

Interference Mechanics as Theory of Everything

Yusuke Kato

Ultimate Artificial General Intelligence

Abstract

The electromagnetic, strong, Higgs, weak, gravity force are explained as the result of interference. The force is that the waves try to avoid weakening and to strengthen each other to increase their probability of existence. These forces correspond to axial, radial, space moving, time moving, size symmetry. The Standard Model is explained geometrically, with γ and Z^0 are orthogonal planes, W^\pm is a sphere, and θ_W is the angle between a sphere and a plane. All forces are unified in the form that the magnitude of the geometrically expressed phase asymmetry coincides with the gauge coupling constant. The theoretical and experimental values for the mass and coupling constant of the gauge particle are almost in agreement. Photons are symmetrical from front to back, so they have zero mass. All forces are derived from the principle that particle waves are always standing waves. The masses of all fermions are expressed in geometric volume ratios, and it is suggested that the generation is the number of dimensions of space. Energy and asymmetry are equivalent. The asymmetry of the Higgs particle is 1, and the Higgs mass M_H is a natural unit. $2M_H - v.e.v.$ divided by the Higgs volume inflated to match the hierarchy of gravity matches the observed value of dark energy. All forces and mass are not just one or something that was unnecessary in the early universe, they are all necessarily necessary.

ai@ultagi.org

<https://ultagi.org/>

Index

1. Introduction.....	4
2. Electromagnetic force	4
Interpreting electromagnetic forces as interference.....	4
Interpretation of phase and charge.....	5
Interpretation of the electroweak unified theory.....	6
Phase diagram	8
Force and Symmetry	8
Half-side interference.....	9
Reduction of the coupling constant due to spin	10
Electroweak force gauge coupling constant.....	10
3. Higgs Force and Weak Forces.....	12
Interference with past self.....	12
The role of the Higgs mechanism.....	13
Standing Wave Principle.....	13
Units of Symmetry and Rest Mass	14
Interference Mechanics.....	16
4. Fermion and Strong force.....	16
Fermion model.....	16
Strong Force.....	17
Hadron	18
Strong force gauge coupling constant	19
5. Chirality and Spin	20
Relationship between chirality and parity	20
Part of a fermion.....	21
Helicity and Chirality	22
Valid Chirality	22
Interpretation of 1/2 spin.....	23
Interpretation of the Pauli Exclusion Principle.....	24
6. Generation and Mass	24
Generation and Moving dimensions	24
Generation and Mixing dimension.....	25
Higgs vacuum expectation value.....	26
Cancellation of asymmetry	27
Tauon Mass.....	27

7. Heuristic mass	28
Koide formula	28
Geometric charged lepton mass	28
Geometric neutrino mass.....	31
Geometric quark mass	32
8. Gravity.....	32
Interpretation of Gravity	32
Gravity force gauge coupling constant	34
Modified Planck Scale	34
Scale hierarchy.....	35
9. Cosmology.....	36
Dark Energy	36
Dark matter ratio.....	38
Baryon number.....	39
Mass of the observable universe	39
10. Theory of Everything	40
The summary of all forces.....	40
The potential of unknown power.....	41
Natural Units	42
The unity of forces strength.....	42
Time Machine	43
Experiment of rewriting the past.....	44
11. Conclusion	45
References.....	46

1. Introduction

A theory that explains all forces in a unified way is called the theory of everything. However, interference phenomena such as those in the double slit experiment cannot be explained by attractive or repulsive forces. The dark parts of the interference fringes are interpreted as the result of wave interference, not as the result of a particle moving away from that position due to repulsive forces. The same is true of the Pauli exclusion principle. The position and probability of a particle's existence at a certain time cannot be explained by attractive or repulsive forces alone, and interference must also be taken into account. If forces and interference can be treated in a unified way, it can be said to be a true theory of everything. There are two main ways to do this. One is to interpret interference as the result of forces. However, interference phenomena are well explained by quantum mechanics, so there is no need to introduce a new force. The other is to interpret forces as the result of interference. This method has a great advantage in unifying forces. Although the forces have different strengths, there is only one interference phenomenon. Regardless of the process by which the waves are superimposed, the square of the amplitude is the probability of existence. Interpreting forces as the result of interference means that the strength of the force corresponds to the degree of wave superposition. Since the degree of wave superposition is between perfect in-phase and anti-phase, the strength of the force is theoretically limited and predictable. Because of the limitations, it is also possible to disprove it. First, an interpretation is attempted as the interference of the electromagnetic force and the weak force, which are already unified in the Standard Model of Elementary Particles. Next, within the same framework, an interpretation of rest mass (Higgs force), the strong force, and gravity is attempted. Since such an interpretation is unnecessary simply to explain experimental results, this type of research has not been conducted sufficiently until now, but it is useful for considering the physics behind it.

2. Electromagnetic force

Interpreting electromagnetic forces as interference

First, as an example of the simplest force, let us try to interpret the Coulomb force as a result of interference. First, we need to consider what waves and their phases are. In quantum mechanics, particles of the same kind cannot be distinguished, so we assume that two electrons have similar waves and phases. In that case, we can expect the positron to have the opposite phase to the electron. Then, even though the charges of the electron and positron are of opposite sign, the waves weaken each other due to the opposite phase, so they avoid each other. In order for the charges of the same sign to

avoid each other and the charges of the opposite signs to attract each other, the phase needs to be reversed depending on the direction of viewing. This can be thought of as a vector that radiates outward if it is positive and inward if it is negative. The directions of the vectors emitted by positive and negative charges match, so the waves reinforce each other. This is the electric field vector. This vector weakens in proportion to the inverse square of the distance. Therefore, the closer the distance between the two particles, the more the waves reinforce each other and the higher the probability of their existence, so it appears that an attractive force is at work. Generally, the force is explained as the result of gauge particles playing catch, but it is difficult to imagine why playing catch results in attractive or repulsive force. It is easier to understand intuitively if you interpret it as two particles interfering with each other through the gauge particle, causing those move in a more reinforced direction.

Interpretation of phase and charge

Regarding the Coulomb force acting on electrons, the electric field and phase may seem to be the same, but the true nature of the phase is not the electric field. This is because neutrons do not have an electric field, but they interfere. It is also possible to imagine cases where they interfere but neither attractive nor repulsive forces act. Let us assume that the electric field does not weaken with distance. Whether the waves interfere and strengthen or weaken each other, there is no need to get closer or farther apart. In the first place, the reason the electric field weakens with distance is because the electric field spreads like a sphere and is inversely proportional to the surface area of the sphere. Electric charge is the source of that sphere. On the other hand, γ also have an electric field, but they do not have electric charge. The electric field of a γ is perpendicular to the direction of travel and is planar rather than spherical. Since it does not spread and attenuate like a sphere, neither attractive nor repulsive forces act even if it interferes. In other words, there is no electric charge. A charge is a spherical vector that represents the phase. The sign of the charge is whether it is pointing inward or outward from the sphere. If vectors representing phase gather in parallel, they form a plane. Even if such a plane exists in a vacuum, no forces act on it, so it is indistinguishable from the fact that it does not exist. There is no contradiction in the fact that such planes are condensed in a vacuum. This vector representing phase can be interpreted simply as representing the directionality of space. An electron can be interpreted as the directionality of space transformed into a sphere. This is illustrated in Fig. 2.1.

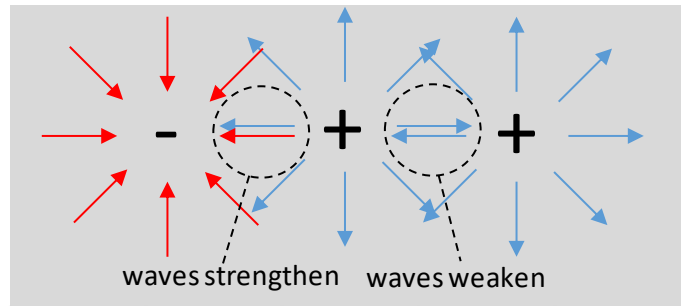

Fig. 2.1. Coulomb force

Interpretation of the electroweak unified theory

In the standard model, the gauge coupling constants for the electromagnetic and weak forces are represented by triangles using the Weinberg angle θ_W . All those gauge coupling constants are illustrated in Fig. 2.2 with the origin as the starting point.

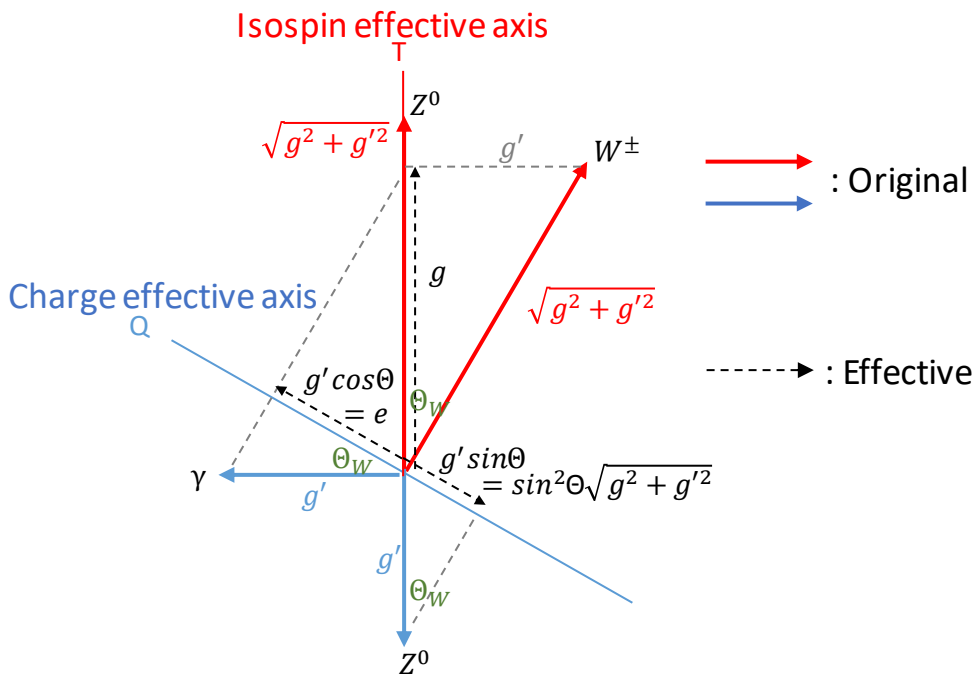

Fig. 2.2. Electroweak gauge coupling constants

Photon γ only acts on the charge Q , and W^\pm only acts on the weak isospin T , but Z^0 acts on both, so they are written separately in the up and down directions. In this figure, not only the effective gauge coupling constants but also the gauge coupling constants that are thought to be the original ones are written. The original values are the maximum values that can be taken depending on the angle. The magnitudes on the T

and Q axes in the figure represent the effective forces acting on T and Q. On the T axis, W originally has the same strength force as Z^0 , but it is tilted and attenuated. On the Q axis, it is similarly tilted, and γ and Z^0 are perpendicular. The strength of the original force of γ and Z^0 on the Q axis is equal, but it is only about half that of the T axis side.

Consider the phase shape of these gauge particles. Only W^\pm has an electric charge, so we can assume that it is a sphere. The fact that there is no orthogonal pair for W^\pm , such as γ and Z^0 , can be interpreted as being because a sphere has no directionality. Also, in the diagram, the Q axis and W^\pm are orthogonal, suggesting that the electric charge also acts in a spherical coordinate system. Then, what are γ and Z^0 , we can guess that they are orthogonal planes. It is known that γ is a transverse wave with an electric field perpendicular to the direction of travel. On the other hand, Z^0 can be assumed to be a longitudinal wave with an electric field horizontal to the direction of travel. Similarly, we assume that the force acting due to weak isospin acts on a plane.

Next, we will speculate geometrically about the origin of θ_W . As shown in Fig. 2.3, the average angle between the spherically radiating vector and the regular octahedron is 30° .

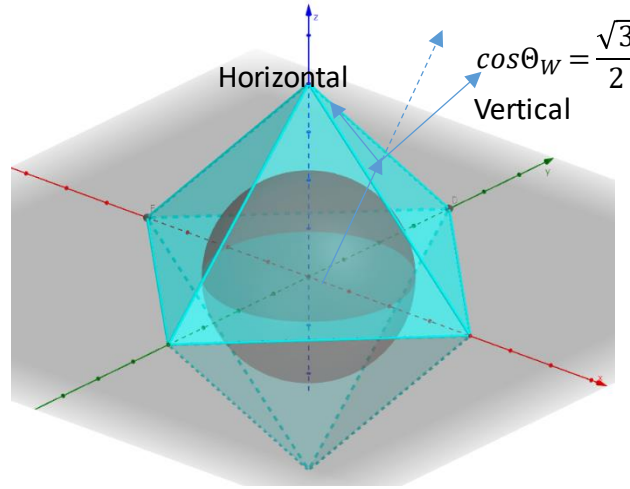

Fig. 2.3. Geometric Weinberg angle

$$\cos\theta_W = \frac{\int_0^{\pi/2} \int_0^{\pi/2} \left(\frac{\cos\theta}{\sqrt{3}} + \frac{\sin\theta\cos\varphi}{\sqrt{3}} + \frac{\sin\theta\sin\varphi}{\sqrt{3}} \right) \sin\theta d\theta d\varphi}{\int_0^{\pi/2} \int_0^{\pi/2} \sin\theta d\theta d\varphi} = \frac{\sqrt{3}}{2} \quad (2.1)$$

$$\theta_W = 30^\circ \quad (2.2)$$

$$\sin^2\theta_W = 0.2500 \quad (2.3)$$

The component perpendicular to the plane is mediated by γ , and the horizontal

component is mediated by Z^0 . There is a slight difference from the experimental value $\sin^2\theta_W = 0.2313$ [1]. However, it is a very beautiful geometric interpretation.

Phase diagram

Particles are thought to have no size, but let us assume that they are roughly the size of the wavelength and consider a schematic diagram of a vector that represents phase. A schematic diagram is shown in Fig. 2.4. We assume that W^+ is a sphere with a white exterior and a black interior. W^- has the black and white reversed. γ and Z^0 are orthogonal planes. The color represents the sign of the phase, and the back side of the white is always black.

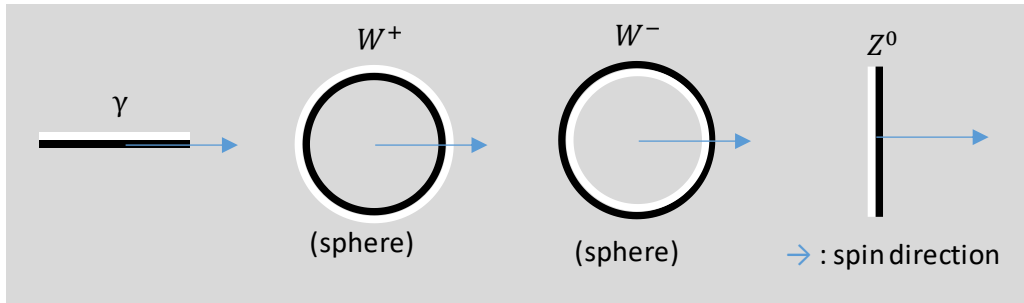

Fig. 2.4. Electroweak boson schematic diagram

Force and Symmetry

The magnitude of phase asymmetry is defined as follows.

$$a_x = |\psi_x - \psi| \quad (2.4)$$

Let the wave function after a certain symmetry transformation x be ψ_x , and the asymmetry at that time be a_x . The asymmetry is in the range of the following equation.

$$0 \leq a_x \leq 1 \quad (2.5)$$

The magnitude of the charge corresponds to the degree of asymmetry between the inside and outside of the sphere in the phase diagram. The sphere has the greatest asymmetry between the inside and outside of the sphere, with a maximum charge of ± 1 . If the asymmetry in the operation of swapping the inside and outside of the sphere is a_Q , then the magnitude of the charge Q will match the asymmetry, as shown in the following equation.

$$|Q| = a_Q \quad (2.6)$$

The gauge particle acting on the charge must also have the same asymmetry as the charge. Since γ is a plane, it can only partially mediate the spherical symmetry, which is thought to result in a small gauge coupling constant.

We hypothesize that a similar mechanism exists for all forces, not just the force due to electric charge. We predict that other forces correspond to a different symmetry, rather than the symmetry inside and outside the sphere. As the weak force is mediated by Z^0 , we speculate that it acts on a planar symmetry perpendicular to the electric field of γ . The magnitude of this asymmetry corresponds to weak isospin. Since W^\pm are spherical, they are tilted relative to the plane, which is thought to make the gauge constant smaller. For other forces, a certain asymmetry becomes the charge, and the corresponding symmetry of the gauge particle becomes the gauge coupling constant. The gauge coupling constant g_x for a certain symmetry x is the asymmetry a_x of the gauge particle, as shown in the following equation.

$$g_x = a_x \tag{2.7}$$

It should always take a value greater than 0 and equal to or less than 1. If it exceeds 1, there is some error in interpretation. However, the magnitude of the charge should be consistent with the units of the magnitude of the symmetry. The smaller the unit of charge, the larger the coupling constant. The charge Q_x of a particle with asymmetry a_x is given by the following equation:

$$|Q_x| = a_x \tag{2.8}$$

Half-side interference

As shown in Fig.2.1, the gauge coupling constant of the force acting on a charge is only half of the force acting on a weak isospin, even before it is tilted. This is true for the same Z^0 particle, so it is not due to differences in gauge particles. Compared to the force when decaying with the weak force, the force of neutral current interaction with other particles is only about half. Neutral currents are similar to γ in that they interact with distant particles. Consider the case where charges of opposite signs interfere with each other through a γ . Consider the front and back sides of two particles facing each other separately. The front sides are in phase with each other, but the front and the back of the other particle are in opposite phase. Therefore, only half sides can strengthen each other by interference. The other half does not participate in the interference. From this assumption, the gauge coupling constant of the force between two particles, which is inversely proportional to the square of the distance, is 1/2.

Gravity falls into this category. It is thought that the strong force does not fall into this category. This assumption holds only when the half sides are allowed to be idle. If confinement of quarks by the strong force is essential, then it is not permitted for them to become free without strong force acting on them just because there are no other quarks in the opposite direction. If the ratio of the gauge coupling constants due to interference on half sides is g_{half} , then we have the following equation.

$$g_{half} = \frac{1}{2} \text{ or } 1 \quad (2.9)$$

Reduction of the coupling constant due to spin

Weak isospin is a planar asymmetry, and since Z^0 is a plane, it is considered to be completely asymmetric. If the force were completely asymmetric, it would be 100% mediated, so the gauge coupling constant should be 1. However, the experimental value is only about 0.7. One possibility is that if the two planes are tilted by 45° , the asymmetry and gauge coupling constant would be $1/\sqrt{2}$. Now, consider that the spin of Z^0 is $L_z = 1$. This means that the z component is 1, and the magnitude of the vector is $L = \sqrt{L_z(L_z + 1)} = \sqrt{2}$. Therefore, the vector is tilted 45° with respect to the direction of travel z. Weak isospin acts on the plane of the direction of travel z, while the plane of the Z^0 particle is tilted 45° with the spin, so we infer that the gauge coupling constant is reduced. If the ratio of the gauge coupling constant due to the spin L_z is g_{spin} , we get the following equation.

$$g_{spin} = \frac{L_z}{\sqrt{L_z(L_z + 1)}} \text{ or } 1 \quad (2.10)$$

However, when the spin is 0, there is no directionality and no tilt, so $g_{spin} = 1$. Also, when 100% symmetry needs to be transmitted due to quark confinement, etc., it becomes 1. When $L_z = 1$, the value becomes as follows.

$$g_{spin} = \frac{1}{\sqrt{1(1 + 1)}} = \frac{1}{\sqrt{2}} \quad (2.11)$$

Electroweak force gauge coupling constant

Taking into account the effects of half-side interference and spin, the gauge coupling constant becomes following equation.

$$g = g_{half} \times g_{spin} \times g_{plane} \quad (2.12)$$

Here, g_{plane} represents the reduction of the gauge coupling constant due to the tilt of

the plane and the sphere.

$$g_{plane} = 1 \text{ or } \cos 30^\circ \text{ or } \sin 30^\circ \quad (2.13)$$

g_{plane} is $\cos 30^\circ$ for the vertical component and $\sin 30^\circ$ for the horizontal component.

We calculated the theoretical values of the gauge coupling constants for W^\pm, Z^0, γ as follows. $g_{Z(T)}$ and $g_{Z(Q)}$ are written separately for the case where Z^0 acts on the weak isospin and the case where it acts on the charge.

$$g_{W(T)} = 1 \times \frac{1}{\sqrt{2}} \times \cos 30^\circ = \frac{\sqrt{3}}{2\sqrt{2}} = 0.612 \quad (2.14)$$

$$g_{Z(T)} = 1 \times \frac{1}{\sqrt{2}} \times 1 = \frac{1}{\sqrt{2}} = 0.707 \quad (2.15)$$

$$g_{Z(Q)} = \frac{1}{2} \times \frac{1}{\sqrt{2}} \times \sin 30^\circ = \frac{1}{4\sqrt{2}} = 0.177 \quad (2.16)$$

$$g_{\gamma(Q)} = \frac{1}{2} \times \frac{1}{\sqrt{2}} \times \cos 30^\circ = \frac{\sqrt{3}}{4\sqrt{2}} = 0.306 \quad (2.17)$$

A comparison with the experimental values is shown in Table 2.1. Although there is some error, the values obtained are close to the experimental values [1].

Table 2.1. Electroweak gauge coupling constants

	Gauge coupling constants							
	g_{half}	g_{spin}	g_{plane}	g		Experimental		Error
$g_{W(T)}$	1	$\frac{1}{\sqrt{2}}$	$\cos 30^\circ$	$\frac{\sqrt{3}}{2\sqrt{2}}$	0.612	$g = \frac{e}{\sin \theta_W}$	0.630	-2.7%
$g_{Z(T)}$	1	$\frac{1}{\sqrt{2}}$	1	$\frac{1}{\sqrt{2}}$	0.707	$\sqrt{g^2 + g'^2} = \frac{g}{\cos \theta}$	0.718	-1.5%
$g_{Z(Q)}$	$\frac{1}{2}$	$\frac{1}{\sqrt{2}}$	$\sin 30^\circ$	$\frac{1}{4\sqrt{2}}$	0.177	$\sqrt{g^2 + g'^2} \sin^2 \theta_W$	0.166	+6.4%
$g_{\gamma(Q)}$	$\frac{1}{2}$	$\frac{1}{\sqrt{2}}$	$\cos 30^\circ$	$\frac{\sqrt{3}}{4\sqrt{2}}$	0.306	$e = \sqrt{4\pi\alpha}$	0.303	+1.1%

The theoretical value of the fine structure constant was also obtained.

$$\alpha = \frac{e^2}{4\pi} = \frac{3}{128\pi} = \frac{1}{134.041} \quad (2.18)$$

The experimental value of $\alpha = 1/137.036$ is slightly different [1]. However, a good

agreement is obtained by assuming that γ also has a reduction in the gauge coupling due to spin. It is suggested that the effect of spin remains the same even for particles traveling at the speed of light.

3. Higgs Force and Weak Forces

Interference with past self

Bohr's quantum condition states that the length of the orbit must be an integer multiple of the wavelength. If it is not an integer multiple, the wave will disappear due to interference with itself, which is the general interpretation. If this is correct, then the particle will be interfering with its past self across time. Even in modern quantum mechanics, the path to a certain coordinate must be added up, ignoring time.

Free electrons can also be thought of as interfering with themselves. They will not meet themselves of previous revolution, but they may interfere with themselves immediately before. Consider a particle divided into a front side and a back side. Assume that the anterior and posterior sides are in opposite phases. The front side of the particle will have been at the coordinates of the back side of the particle until just before. The particle would not be allowed to move because of interference and the wave would disappear. However, if the phase of the front side and the back side are the same, the wave will not disappear due to interference, and the particle will be allowed to move freely. This is illustrated in Fig. 3.1.

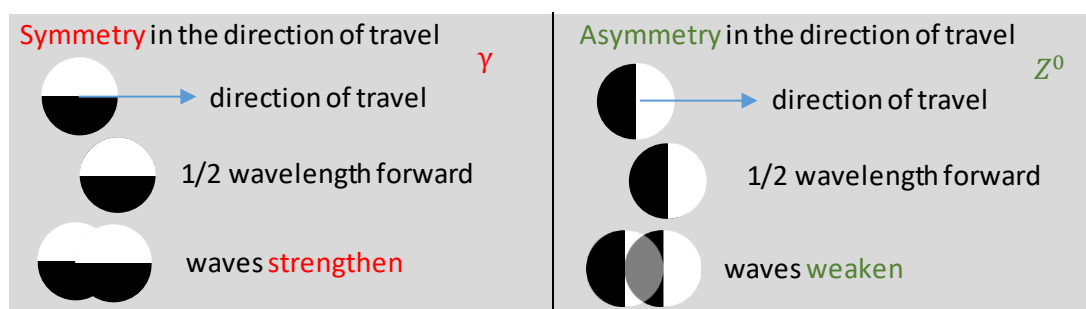

Fig. 3.1. Interference with past self

The particle with the least restriction on movement is a particle with zero mass, such as γ . Such a particle is considered to be a particle with symmetric phases on the front and back sides when moving in parallel. The electric field vector of v is perpendicular to the direction of movement, and is symmetrical front to back. In contrast, Z^0 , which is perpendicular to γ , is asymmetric and heavier.

The role of the Higgs mechanism

Particles that are asymmetric with respect to parallel movement cannot move because the waves disappear. However, in reality, they can move despite the resistance, which means that there must be some mechanism that prevents the waves from disappearing. Particles have no size, but since time and position are uncertain to begin with, we assume that they exist spread out over the size of a wavelength. The phase switches between positive and negative every half wavelength. Suppose that at a certain time, the phase of the front side of the particle is positive and the phase of the back side is negative. Consider what happens after the particle has advanced by half a wavelength. Since the phase shifts by half a wavelength, the phase of the front side becomes negative and the back side becomes positive. This can be interpreted as the phase of the front and back sides being swapped. However, this is not a mirror image inversion; the front side does not move, and what was on the back side has been moved further forward. It is thought that this is done by the Higgs mechanism.

The general Higgs mechanism is thought to involve swapping right-handed and left-handedness. Here, we consider that swapping the front and back sides results in the right-handed and left-handedness being swapped as a by-product. It is also generally believed that in the early universe, Higgs particles were not condensed in the vacuum, and rest mass did not exist. However, in this view, swapping the front and back sides is essential for the waves to travel without disappearing, so the existence of rest mass is required even in the early universe. If it turns out that rest mass did not exist, this interpretation would be refuted.

Standing Wave Principle

When considering the role of the Higgs mechanism, we considered the case where time has advanced exactly half a wavelength, but we will also consider the case where time advances gradually. We think of positive and negative phases repeated every half wavelength as being laid out infinitely ahead. At any given time, only one wavelength is visible. This can be interpreted as a window that determines the visible portion sliding forward with time. The laid-out portion itself is a standing wave that does not change with time.

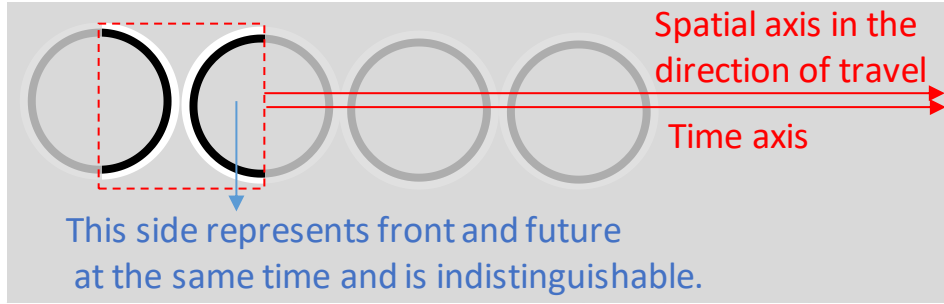

Fig. 3.1. Standing wave and window

Not only for a specific force, but in principle, all particle waves are standing waves in any case. This means that the wave properties for a certain coordinate of a certain particle do not change with time. When this principle holds, the spatial axis of the direction of travel is shared with the time axis. The spatial forward simultaneously represents the temporal forward and cannot be distinguished. In other words, both cannot be determined at the same time. Information about the position of a certain particle at a certain time is originally four-dimensional, but can be described as three-dimensional. This explains why, in the natural world, only three-dimensional information should exist at a certain time, but particles at other times that should be unknowable can interfere with each other. In quantum mechanical calculations, the waves of all routes leading to a certain coordinate are summed up, ignoring time. All that is needed is the total value, and the information on the individual times can be discarded. The fact that such calculations performed by humans represent natural phenomena well suggests that the natural world is also performing the same calculations as humans do.

Units of Symmetry and Rest Mass

For the Higgs particle to invert the symmetry of translation, the Higgs particle itself must be asymmetric. We predict that the Higgs particle is completely asymmetric with respect to its symmetry. If the spin is 0, there is no factor that reduces the symmetry. Therefore, the gauge coupling constant of the Higgs force is considered to be 1. The Higgs particle itself has a rest mass $M_H = 125.2 GeV/c^2$ [1]. The rest mass of the Higgs particle can be interpreted as the only natural unit for converting asymmetry and energy. Phase asymmetry and energy are equivalent. When there is a certain asymmetry a_x , the energy E due to that asymmetry is given by the following equation.

$$E = a_x M_H c^2 \quad (3.1)$$

Therefore, by multiplying the asymmetry a_H of a particle's translation by M_H , the rest mass M of the particle can be calculated as follows.

$$M = a_H M_H \quad (3.2)$$

In the Standard Model, the mass ratio of Z^0 and W^\pm is equal to the ratio of the gauge coupling constants of the weak force. Also, the asymmetry is equal to the gauge coupling constant. Multiplying the gauge coupling constant by the mass of the Higgs particle gives follows.

$$M_Z = \frac{1}{\sqrt{2}} M_H = 88.5 \text{ GeV}/c^2 \quad (3.3)$$

$$M_W = \frac{\sqrt{3}}{2\sqrt{2}} M_H = 76.7 \text{ GeV}/c^2 \quad (3.4)$$

A comparison with the experimental values is shown in Table 3.1 Although there is some error, the values obtained are close to the experimental values [1].

Table 3.1. Electroweak boson mass

	Gauge coupling constants				Rest mass [GeV/c^2]		
	g_{half}	g_{spin}	g_{plane}	g	gM_H	Experimental	Error
W^\pm	1	$\frac{1}{\sqrt{2}}$	$\cos 30^\circ$	$\frac{\sqrt{3}}{2\sqrt{2}}$	76.7	80.4	-4.6%
Z^0	1	$\frac{1}{\sqrt{2}}$	1	$\frac{1}{\sqrt{2}}$	88.5	91.2	-2.9%
H	1	1	1	1	125.2	125.2	0%

However, it is the Higgs force, not the weak force, that determines the rest mass. However, both the weak force and the Higgs force act with planar symmetry with respect to the direction of travel. At least for Z^0 and W^\pm , the magnitude of their asymmetry is almost the same. We assume that the asymmetry of the Higgs force is a_H and the asymmetry of the weak force is a_W , which are the same as shown in the following equation.

$$a_H = a_W \quad (3.5)$$

It is difficult to imagine that there are two overlapping forces acting on exactly the same symmetry. Therefore, we assume that the principle of standing waves exists. The spatial axis and the time axis of the traveling direction are common. If the Higgs force is a force acting on the symmetry of spatial movement, we can infer that the weak force is

a force acting on the symmetry of temporal movement.

Interference Mechanics

All forces act to prevent the waves from being cancelled out due to interference, with respect to each phase symmetry. All forces can be said to be one unified force. If there is perfect symmetry, the waves will not be cancelled out, so no force will act. In other words, the potential energy of the unified force is proportional to the asymmetry. The relationship between asymmetry and energy is expressed by the following equation.

$$\Delta E = \Delta a_x M_H c^2 \quad (3.6)$$

When a force is acted, the asymmetry is reduced by Δa_x , generating energy ΔE , which can become kinetic energy or be converted into asymmetry.

Consider the Coulomb force acting between two particles with opposite charges. Each of the two particles has an asymmetry in the inner and outer directions of the sphere. The magnitude of this asymmetry appears to be unrelated to the distance between the two particles. However, the closer the particles are, the stronger the mediation by the photon. This can be interpreted as the asymmetry between the two particles being partially cancelled out through the mediation of the photon. The cancelled asymmetry is converted into energy that moves the two particles closer together.

4. Fermion and Strong force

Fermion model

The charge Q of a fermion is the sum of its weak isospin T and hypercharge Y .

$$Q = T + Y \quad (4.1)$$

The Q of all quarks and leptons can be expressed in terms of the following degrees of freedom.

$$Q = \pm \frac{1}{2} \pm \frac{1}{6} \pm \frac{1}{6} \pm \frac{1}{6} \quad (4.2)$$

Hypercharge can be divided into three parts as shown in the following formula.

$$Q = \pm T \pm Y_R \pm Y_G \pm Y_B \quad (4.3)$$

The model of fermions is shown in Table 4.1. Only one generation is shown here. Quarks come in three colors, but only green is shown as a representative. Also, only fermions with chirality that interacts with the weak force are shown.

Table 4.1. Fermion charge model

	e	\bar{u}	d	$\bar{\nu}$	ν	\bar{d}	u	\bar{e}
T	-1/2	-1/2	-1/2	-1/2	+1/2	+1/2	+1/2	+1/2
Y_R	-1/6	-1/6	+1/6	+1/6	-1/6	-1/6	+1/6	+1/6
Y_G	-1/6	+1/6	-1/6	+1/6	-1/6	+1/6	-1/6	+1/6
Y_B	-1/6	-1/6	+1/6	+1/6	-1/6	-1/6	+1/6	+1/6
$Q = T + Y$	-1	-2/3	-1/3	0	0	+1/3	+2/3	+1

As a representative example, a schematic diagram of the u quark is shown in Fig. 4.1.

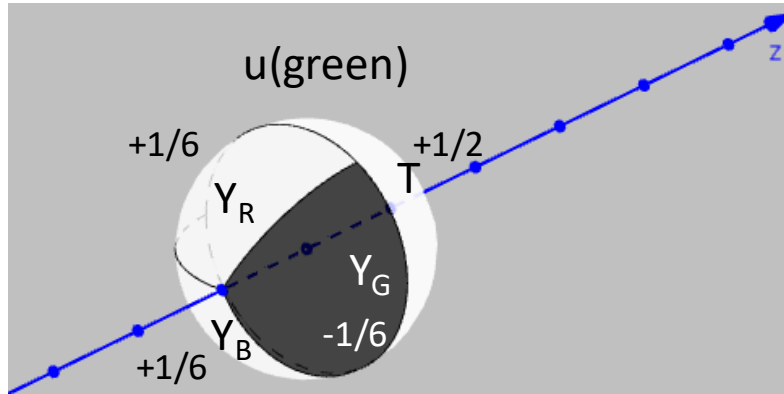

Fig. 4.1. u(green) schematic diagram

The hemisphere is the T part, and the three 1/6 spheres are the Y parts. The sign of the charge in each part is free, and the colors of the front and back of the sphere are inverted accordingly. One of the three Y parts of a quark is reversed with respect to the remaining two. This degree of freedom is considered to be the degree of freedom of color. The directions in which the three parts of the Y part face are called the R axis, G axis, and B axis. These axes must be rotationally symmetric with respect to the spin axis. If they were not rotationally symmetric, there would be differences in the magnetic moment depending on the color.

Strong Force

Consider a particle spinning at rest. For particles with mismatched electric charges on Y_R, Y_G, Y_B the waves disappear due to the rotation caused by the spin. Two of the three are in phase and one is in the opposite phase, so one-third of the waves remain. If the principle of standing waves exists, there must be some way to prevent the waves from disappearing. It is thought that gluons are responsible for this. Gluons switch colors

according to the rotation of the spin. Only two of the three need to change color. Therefore, gluons invert the phase of two of the R, B, and G axes. The three axes are orthogonal axes in space. Gluons need to be asymmetric with respect to two orthogonal planes. Also, if the mass is zero, they need to be symmetric with respect to the direction of travel, just like photons. Therefore, gluons are asymmetric with respect to each of the two planes perpendicular to the direction of travel. Fig. 4.2 illustrates a planar gauge particle.

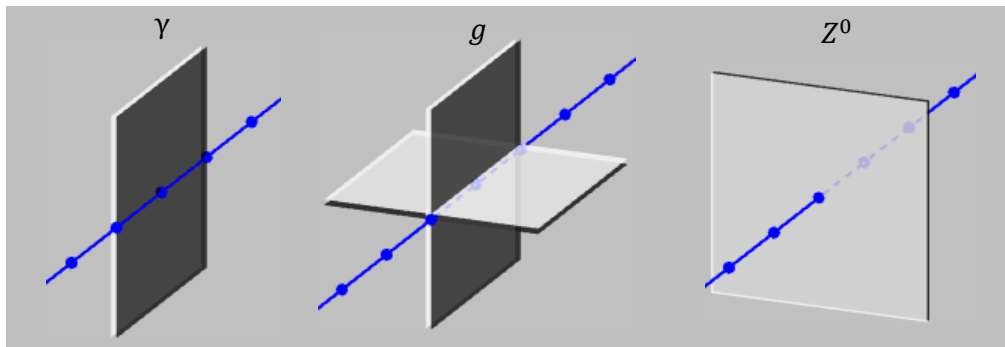

Fig. 4.2. Flat boson schematic diagram

Since color is merely a matter of the direction that a particle faces at any given moment, there is only one type of gluon. If more than one type were observed, this model would be disproved.

Hadron

Gluons, which are the product of exchanging the colors of quarks, also have colors. When colored particles rotate, the colors mix and the waves disappear. However, if they travel at the speed of light, there is an exception. As they travel, they simply trace a spiral path, and the colors do not mix. Gluons are eventually absorbed by other quarks and become mesons or baryons. A schematic diagram of a baryon is shown in Fig. 4.3.

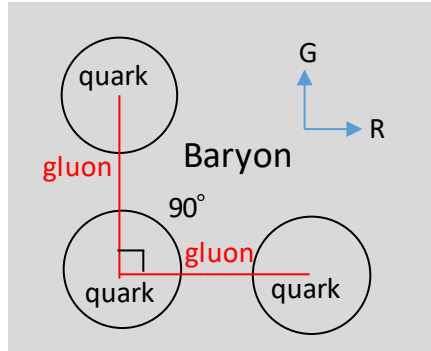

Fig. 4.3. Baryon model

The three quarks that make up a baryon must be arranged in an L-shape at right angles. The three colors are three perpendicular directions, so if they are not at right angles, the color balance will not be balanced. If we can observe a right angle, it will support the interpretation that colors are directions. Conversely, if it is not always at a right angle, it will be disproved.

Strong force gauge coupling constant

The gauge coupling constant of the strong force must be 1. If it were less than 1, the colors of the quarks would not be able to be completely exchanged. If the principle of standing waves is correct, this would not be allowed. This is the same as in the case of the Higgs field. However, the gauge coupling constant becomes 1 only when the magnitude of the color charge matches the magnitude of the asymmetry. The part that is symmetric with respect to the spin rotation must be excluded. The phase of 1/2 of the charge on the T side of the quark does not flip when it spins. Only 2/3 of the charge on the Y side flips the phase with spin. This corresponds to 1/3 of the whole sphere. Therefore, in order to match the asymmetry with the magnitude of the color charge, the magnitude of the color charge must be 1/3, not 1. Conversely, if the magnitude of the color charge is 1, the gauge coupling constant becomes 1/3. A comparison with the experimental value is shown in Table 4.2. Although there is an error, a value close to the experimental value was obtained [1].

Table 4.2. Strong gauge coupling constant

	Color charge	Gauge coupling constant						
		g_{half}	g_{spin}	g_{plane}	g	Experimental		Error
g_s	1/3	1	1	1	1	-	-	-
	1				1/3	$\sqrt{\alpha_s}(M_Z)$	0.3435	-3.0%

Here, the gauge coupling constant is $\sqrt{\alpha_s}$ instead of $\sqrt{4\pi\alpha_s}$. 4π is needed when the force decays inversely proportional to the surface area of the sphere depending on the distance. The strong force does not decay in this way, so 4π is not needed. If 4π is added, the gauge coupling constant will exceed 1, so it is thought that there is some misinterpretation there. The coupling constant does not exceed 1 for a single gauge particle. However, as a result of multiple gauge particles mediating a force, the coupling constant can actually exceed 1 in total. Also, even if the coupling constant is 1, it is possible that multiple gauge particles with a coupling constant less than 1 act simultaneously, resulting in a total of 1. Since gluons have a spin of 1, it is more universal to think that the coupling constant per particle is less than 1, as with the gauge particles of the electroweak force.

The strength of the strong force varies with the energy scale. There is a slight error between the theoretical and experimental values on the M_Z scale, but the error is minimal near the M_H scale. M_H can be thought of as a natural unit that converts asymmetry and energy. It is more natural for the strength of the force to be unified on the natural energy scale than for it to be unified at higher energies.

5. Chirality and Spin

Relationship between chirality and parity

Table 5.1. Fermion chirality model

	e	\bar{u}	d	$\bar{\nu}$	ν	\bar{d}	u	\bar{e}
Spin	-1/2	+1/2	-1/2	+1/2	-1/2	+1/2	-1/2	+1/2
Chirality	L	R	L	R	L	R	L	R
T	-1/2	-1/2	-1/2	-1/2	+1/2	+1/2	+1/2	+1/2
Y_R	-1/6	-1/6	+1/6	+1/6	-1/6	-1/6	+1/6	+1/6
Y_G	-1/6	+1/6	-1/6	+1/6	-1/6	+1/6	-1/6	+1/6
Y_B	-1/6	-1/6	+1/6	+1/6	-1/6	-1/6	+1/6	+1/6
Parity ($Y_R Y_G Y_B$)	-	+	-	+	-	+	-	+
$Q = T + Y$	-1	-2/3	-1/3	0	0	+1/3	+2/3	+1
Spin \times Parity	+	+	+	+	+	+	+	+

Table 5.1 adds spin, chirality, and parity to Table 4.1. The chirality column indicates whether right-handed or left-handed weak interactions are possible. The sign of spin is

for cases where weak interactions are possible, with right-handed being positive. Parity here is the product of the signs of the charges of Y_R, Y_G, Y_B . The signs of parity and spin are the same. The product of the signs of parity and spin is always positive.

If the sign of the electric charge is reversed, then, in a schematic diagram, the colors inside and outside the sphere are reversed. This is a mirror image of the sphere. When the image is inverted, the right-handed and left-handed nature is reversed. Whether the number of times the image is inverted determines whether it is right-handed or left-handed. It can be thought of as originally being either right-handed or left-handed, which is inverted by the electric charge. For both particles and antiparticles, only those that are originally right-handed are capable of weak interactions.

In the schematic diagram, Y_R, Y_G, Y_B are hemisphere Y divided by 120° , but this is not accurate. If it were divided like this, whether weak interactions are possible for each of the three parts would be determined, and the whole particle would be the average. Y_R, Y_G, Y_B can be thought of as representing the R, G, and B axis components of hemisphere Y, respectively. The three axes are orthogonal spatial axes. When the charge of Y_R is inverted, the whole of Y is considered to be a mirror image inverted with respect to the R axis. Then, the total number of inversions of Y_R, Y_G, Y_B determines whether the whole is ultimately right-handed or left-handed.

Part of a fermion

Fermions are modeled with half T and half Y, depending on the magnitude of the charge. However, chirality is determined only by the parity of the Y part, and is not affected by the inversion of the charge of the T part. The properties related to spin seem to be determined only by the Y side, which is half of the particle.

The magnitude of weak isospin T is set to $1/2$. Y has no effect on the magnitude of T at all. The weak force can be interpreted as acting only on the T side, which is $1/2$ of the particle. On the other hand, the strong force can be interpreted as acting only on the Y side, which is $1/2$ of the particle. Since the T side is not divided into three parts and is rotationally symmetric, no strong force is applied even if it is within the range of influence.

From the above considerations, we deduce that the Y part is the part that is responsible for the spatial properties of fermions, and the T part is the part that is responsible for the temporal properties. If we assume that the weak force is a force regarding the symmetry of time, then it can explain why only the T part is the object of the force. Since space is three-dimensional, the Y part can be divided into three, but since time is one-dimensional, the T part cannot be divided. The number of dimensions

is itself the degree of freedom. When considering why material particles are divided into T and Y parts in the first place, it is natural to think of them as corresponding to time and space.

Helicity and Chirality

Right-handed and left-handed are not simply the directions of spin, because spin looks different to different observers. To an observer rotating twice as fast in the same direction as the spin, the particle rotates in the opposite direction. To an observer rotating at the same speed as the spin, the particle does not rotate. Therefore, chirality can be said to be determined independently of the direction of rotation.

If the principle of standing waves is correct, the time axis and the spatial axis of travel cannot be distinguished. When an observer overtakes a particle, the spatial direction of travel is reversed. On the other hand, the temporal direction of travel is not reversed. Some orientation of the particle relative to the direction of the time axis is constant regardless of the observer. This can be called chirality.

Here, we consider the role of the Higgs field to swap the front and back sides of particles, but it is generally thought to swap right-handed and left-handed handedness. Therefore, we assume that the direction of front and back of a particle is chirality. Since the spatial front and back change depending on the observer, we use the temporal front and back as the basis. Due to the principle of standing waves, the spatial front of a particle also means the temporal front. The spatial front is swapped by the Lorentz transformation, but the temporal front is not swapped. The T and Y sides of a fermion are considered to be located either forward or backward in time. Whether the T or Y side is forward in time determines whether a weak interaction is possible.

Valid Chirality

Let us consider a mechanism by which only one chirality can weak interact. We speculate that weak interactions are possible only when the particle's time forward is either the T or Y side. The time forward is the side that appears first when the particle is created. However, there is no difference if the forward and backward sides are created at the same time. In the case of composite particles, it is possible to distinguish which existed first. For example, consider the case where a rubber gluon is torn and a quark pair is created in the cross section. Of the mesons created, the quark that existed from the beginning can be said to be located in the time forward.

W^\pm has $T = \pm 1$, which can be thought of as a sphere with two hemispheres of the $T = \pm 1/2$ part of a quark stuck together. When W^\pm decays into two particles, T is

conserved. The two T parts of W^\pm can be thought of as being reused as they are in the decayed particle. Only the Y part is considered to be newly created. In this case, the T part will always be forward in time, since it existed from the beginning. In the decay of W^\pm , only particles with T forward in time are produced. It can be said that the weak force only interacts with particles with T forward in time.

γ interacts with both right-handed and left-handed particles. When pair production occurs from γ , the part that was originally in γ is not reused. In that case, either the T side or the Y side is allowed to be forward in time.

Z^0 is bonded to $T - Q\sin^2 \theta_W$. We can expect that the interaction due to T is similar to that due to W^\pm , and that due to Y is similar to that due to γ . However, there is a minus sign between the two, so they weaken each other. In the decay of W^\pm , we can imagine the two parts being torn apart as they try to move away from the central point. Conversely, in pair production from γ , γ must disappear without being reused, so we can imagine them gathering at the central point. As shown in Fig. 5.1, the forces due to T and Y are in opposite directions, so we can imagine them weakening each other.

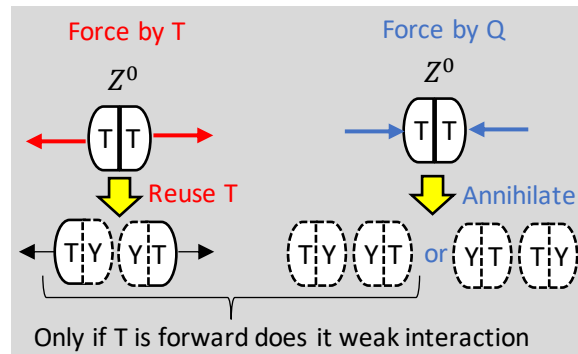

Fig. 5.1. Decay mode

Interpretation of 1/2 spin

If the optical path length of a photon with spin 1 is an integer multiple of the wavelength, then interference will occur and the waves will reinforce each other. It is thought that the phase will return to its original state after one rotation. However, the same thing happens with an electron with spin 1/2. After one half rotation, the phase does not reverse, and it appears to return to its original phase. This can be interpreted as follows. Consider that the T side and the Y side alternately rotate once depending on the spin. In this case, the angular momentum will be halved, but the original phase will return after one wavelength.

A particle with spin 1/2 has the property of rotating 720° and returning to its original

state. This can be interpreted as follows. When rotating a particle by a method other than spin, the T side and Y side rotate equally. When the entire particle is rotated 360° , the T side and Y side each rotate only 180° . Therefore, the phase is inverted.

Interpretation of the Pauli Exclusion Principle

Swapping the positions of two fermions reverses the sign of the wave function. This can be interpreted as follows. Imagine two particles staring at each other. When they swap positions, the two particles are back-to-back. This is the same as each of the two particles rotating 180° in place. In total, they rotate 360° . A 360° rotation inverts the phase of a fermion.

Two indistinguishable fermions cannot exist in the same position. This phenomenon can be interpreted as a result of interference. When two fermions are in the same position, they cannot be distinguished from a state where they have swapped positions. When they swap positions, if one fermion does not rotate, the other rotates 360° . In other words, they cannot be distinguished from a state where the phase is reversed. They cannot be allowed to interfere with themselves and the wave disappears.

6. Generation and Mass

Generation and Moving dimensions

The asymmetry of the Higgs particle H is considered to be a maximum value of 1. However, the top quark t is heavier than H. Since the rest mass is proportional to the asymmetry, the asymmetry of t exceeds the maximum value of 1. However, there is no contradiction if we consider that multiple Hs are acting. Consider the state of Fig. 6.1.

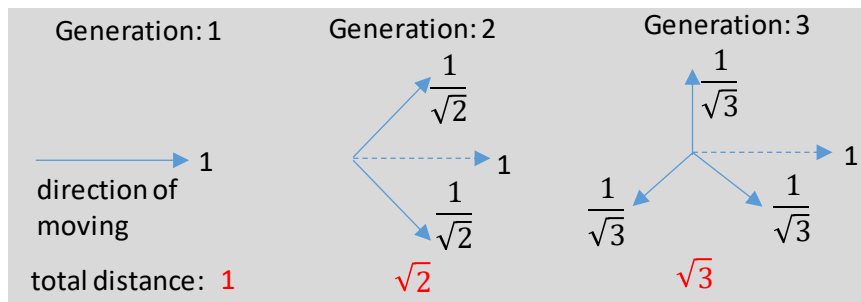

Fig. 6.1. Dimension number of moving

Even if it appears to move the same distance, it may be the sum of movements in multiple directions. When moving in two orthogonal directions, it moves $1/\sqrt{2}$ in each direction, and moves a total distance of $\sqrt{2}$ times. Similarly, when moving in three

orthogonal directions, it moves a distance of $\sqrt{3}$ times. It is allowed to have a maximum mass of $\sqrt{3}$ times that of H. The mass of t is within that range. There are three possible levels of the number of directions to move, and everything except mass remains the same. This is thought to be related to the mass by generation. However, since the mass ratio of the three generations is greater than 1, $\sqrt{2}$, and $\sqrt{3}$ times, there must be some other reason. If it moves in only one direction, the mass will be 0 if it is symmetric in that direction. On the other hand, if it moves in three directions simultaneously, the mass will not be 0 unless it is symmetric in each direction.

The theoretical value of the Weinberg angle was calculated by the angle between a sphere and a regular octahedron. A regular octahedron is three-dimensional and is considered to be close to the third generation of quarks. The mass of W^\pm is also close to that of the third generation of quarks. It can be said that the smaller the generation, the lighter it becomes, rather than the larger the generation, the heavier it becomes. If we consider the mass of the Higgs particle to be a natural unit, we can say that the third generation is closer to natural mass.

Generation and Mixing dimension

It is believed that the Higgs field causes the front and back of a particle to be swapped. In this case, the particle appears to be split into two. If it moves in two directions at the same time, it is split into two in both directions, for a total of four parts. If it moves in three directions, it is split into eight parts in the same way. As shown in Fig. 6.2, there are three levels of splitting: 2, 4, and 8.

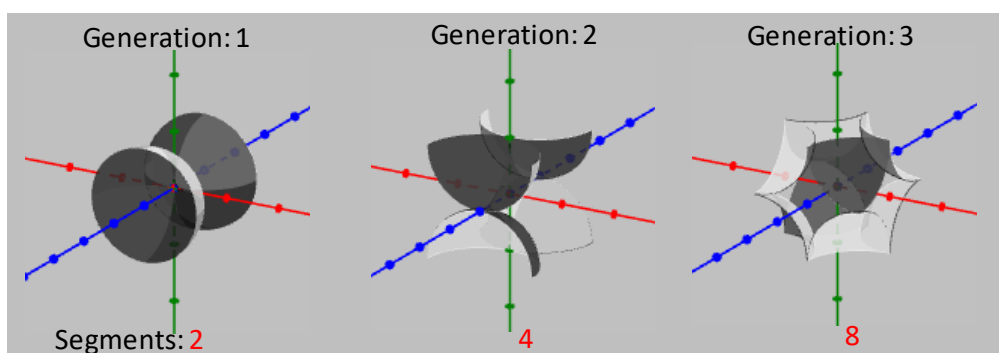

Fig. 6.2. Dimension number of moving

In the case of a 2-part division, it is thought that T and Y occupy each part. However, in the case of a 4- or 8-part division, there is a degree of freedom as to which parts T and Y occupy. Entropy is maximized when T and Y are arranged alternately. It can be said

that there are three levels of mixing of T and Y. It is thought that these may correspond to each generation. In this model, only particles that have both T and Y parts have generations. This can explain why gauge bosons have no generations.

Both the dimensionality of the moving and the dimensionality of the mixing may be related to the generation. Since both are spatial dimensions, they may match. There may be a slight difference, which may be the cause of quark mixing.

Higgs vacuum expectation value

The phase of the Higgs field is inverted by swapping the front and back sides. When the phase of a matter particle is inverted from positive to negative, the phase of the Higgs field is inverted from negative to positive. If the phase of the matter particle and the Higgs field are the same, they cannot be inverted. To be able to invert the phase of matter particles of both phases, it is necessary to prepare Higgs fields of both phases. The experimental value of the vacuum expectation value of the Higgs is $v.e.v. = 246.22\text{GeV}/c^2$, which is about twice the mass of the Higgs particle, $M_H = 125.20\text{GeV}/c^2$ [1]. This suggests that about two Higgs particles of opposite phases are condensed in the vacuum. The theoretical value under this assumption is as follows.

$$v.e.v. = 2M_H = 250.40\text{GeV}/c^2 \quad (6.1)$$

The difference between the theoretical and experimental values may be a meaningful value rather than a measurement error.

$$(n_H + n_{\bar{H}})M_H = v.e.v. = 246.22\text{GeV}/c^2 \quad (6.2)$$

In the above equation, the number of Higgs particles condensed in the vacuum is n_H , and the number of Higgs particles in the opposite phase is $n_{\bar{H}}$. When $n_H = 1$, the equation becomes.

$$n_{\bar{H}} = 0.9666 \quad (6.3)$$

The above formula is for the maximum value, and one of the phases may be reduced and become asymmetric. If we assume that the two are symmetric when both are 1, then the asymmetry of the vacuum expectation value becomes.

$$a_{v.e.v.} = |n_H - n_{\bar{H}}| = |1 - 0.9666| = 3.34\% \quad (6.4)$$

If the vacuum is asymmetric, various effects can be considered. First, there is a possibility that the theoretical and experimental values of the rest mass and gauge coupling constants may differ. It may also be the cause of the asymmetry between

particles and antiparticles. In the first place, asymmetry and energy are equivalent. If the vacuum is asymmetric, it means that the vacuum has energy. It is speculated that this energy is equivalent to dark energy. Its value can be calculated using the following formula.

$$a_{v.e.v.} M_H c^2 = 4.18 GeV \quad (6.5)$$

Cancellation of asymmetry

It is believed that the rest mass is proportional to the asymmetry between the front and back sides during the movement. Let's consider the mass of the third generation of quarks and leptons. They are heavier in the order of neutrino, b quark, and t quark. Up to this point, the order of the magnitude of the charge and the mass is correct. It can be inferred that the smaller the charge, the smaller the asymmetry. However, the charged lepton τ is lighter than the t quark, even though it has a larger charge. This cannot be explained by the magnitude of the charge alone. It seems that a mass closer to the mass of the Higgs particle would be more natural, so it is predicted that τ is lighter for reasons other than charge. Intuitively, one can imagine that a charged lepton with an integer charge is more stable and lighter than a quark with a fractional charge.

One mechanism by which mass becomes lighter is the cancellation of asymmetry. First, fermions are divided into T and Y parts. At a certain time, the phase of the T part of the Higgs field needs to be inverted from positive to negative, and the Y part needs to be inverted from negative to positive. There is a demand for two Higgs fields with opposite phases, but if they can be cancelled out, the demand disappears. In that case, the closer to perfect asymmetry, the less is left uncanceled. This method can explain why charged leptons are lighter than quarks. However, W^{\pm} also has the same charge as charged leptons, so it is thought that they have a similar asymmetry. Nevertheless, W^{\pm} remains heavy. This is thought to be because W^{\pm} cannot cancel itself out within itself because it is not divided into T and Y parts.

Tauon Mass

We calculate the rest mass of the tauon τ in the same way as for W^{\pm} . Since τ has spin $L_z = 1/2$, the asymmetry due to spin is given by following.

$$a_{spin} = \frac{L_z}{\sqrt{L_z(L_z + 1)}} = \frac{0.5}{\sqrt{0.5(0.5 + 1)}} = \frac{\sqrt{3}}{4} \quad (6.6)$$

Multiplying the asymmetry by M_H gives us the mass.

$$\frac{\sqrt{3}}{4}M_H = 54.21\text{GeV}/c^2 \quad (6.7)$$

The reason why this mass is several orders of magnitude larger than the experimental value is probably because the cancellation of asymmetry is not taken into account. It is necessary to consider the amount of symmetry that remains uncanceled. If we assume that the vacuum is asymmetric and that the amount of symmetry that cannot be cancelled out is $a_{v.e.v.} = 3.34\%$, we obtain the mass in the following formula.

$$M_\tau = a_{v.e.v.} \frac{\sqrt{3}}{4}M_H = 1809.99\text{MeV}/c^2 \quad (6.8)$$

A comparison with the experimental values is shown in Table 6.1. Although there is some error, the values obtained are close to the experimental values [1].

Table 6.1. Tauon mass

	$a_{v.e.v.}$	a_{spin}	$a = a_{v.e.v.}a_{spin}$	Rest mass [MeV/c^2]		
				aM_H	Experimental	Error
τ	3.34%	$\frac{\sqrt{3}}{4}$	1.446%	1809.99	1776.93	+1.9%

7. Heuristic mass

Koide formula

The masses of the three generations of fermions cannot be expressed by a simple sequence, making theoretical explanation difficult. To obtain hints for theoretical explanation, it is useful to search for regularities in the masses. The famous empirical Koide formula that expresses the mass ratio of charged leptons is shown below [2].

$$\frac{M_e + M_\mu + M_\tau}{(\sqrt{M_e} + \sqrt{M_\mu} + \sqrt{M_\tau})^2} = \frac{2}{3} \quad (7.1)$$

The ratio in this formula can take values between 1/3 and 1, with the experimental value agreeing with the central value of 2/3 with high precision.

Geometric charged lepton mass

Based on the expectation that generations correspond to the number of dimensions of space, we made the following assumptions.

$$M_e = 1, \quad M_\mu = 2\pi r, \quad M_\tau = \pi r^2 \quad (7.2)$$

The rest masses of the three generations of charged leptons correspond to points, circumferences, and areas of circles. The solution that satisfies the Koide formula above was found by solving a fourth-order equation.

$$r = 33.57715 \dots, \quad \frac{1}{\pi 33.57715 \dots} \quad (7.3)$$

If the circumference is greater than the point, the latter solution is contradictory, so we adopt the former solution. Although the three quantities have different units, they all become volume by multiplying them by the unit length, as shown in the following equation.

$$V_e = 1 \times 1 \times 1, \quad V_\mu = 2\pi r \times 1 \times 1, \quad V_\tau = \pi r^2 \times 1 \quad (7.4)$$

In addition, we consider W^\pm to be spherical, so we assume the volume of a sphere.

$$V_W = \frac{4\pi r^3}{3} \quad (7.5)$$

The volume of the Higgs particle H is assumed to be as follows.

$$V_H = \pi r^2 \times \frac{2\pi r}{3} \quad (7.6)$$

This is the volume of a cylinder with a length of $2\pi r/3$, or a cone with a length of $2\pi r$. Assuming that the volume and rest mass are proportional, the mass can be calculated by volume ratio using $M_H = 125.20 \text{ GeV}/c^2$ as the standard.

$$M_e = \frac{V_e}{V_H} M_H = \frac{M_H}{V_H} = 0.502648 \text{ MeV}/c^2 \quad (7.7)$$

$$M_\mu = 2\pi r \times M_e = 106.044 \text{ MeV}/c^2 \quad (7.8)$$

$$M_\tau = \pi r^2 \times M_e = 1780.34 \text{ MeV}/c^2 \quad (7.9)$$

$$M_W = \frac{4\pi r^3}{3} \times M_e = 79.70 \text{ GeV}/c^2 \quad (7.10)$$

A comparison with experimental values is shown in Table 7.1. Although there is some error, the values obtained are close to the experimental values [1].

Table 7.1. Geometric charged lepton mass

	Volume V	Rest mass $M [GeV/c^2]$		
		$\frac{V}{V_H} M_H$	Experimental	Error
e	1	0.000502648	0.000510999	-1.6%
μ	$2\pi r$	0.106044	0.105658	+0.4%
τ	πr^2	1.78034	1.77693	+0.2%
W^\pm	$\frac{4\pi r^3}{3}$	79.70	80.37	-0.8%
H	$\pi r^2 \frac{2\pi r}{3}$	125.20	125.20	(0)

When an object that has the same radius in all directions, such as a sphere, moves, the path it follows forms a cylinder. If we assume that the movement encounters resistance from the Higgs field, it makes sense that rest mass is proportional to volume. The volumes of the three generations of leptons are parts of the same cylinder. This can be interpreted as the lower the generation, the less resistance a part of the volume experiences from the Higgs field. Also, the formula for the Higgs volume contains $2\pi r$, which is thought to represent the wavelength rather than the circumference. The volume is illustrated in Fig. 7.1.

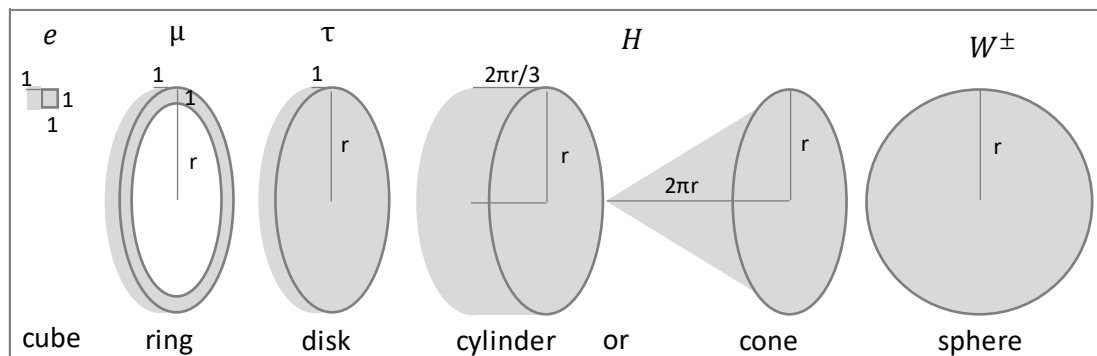

Fig. 7.1. Geometric lepton volume

The Koide formula here expresses the balance between a point, a circumference, and a

circular area. The Koide formula can take values from 1/3 to 1, but if the median is 0, the range is $\pm 1/3$. The Koide formula may be showing that it is natural for the value to be 0, which is not biased toward either side.

Geometric neutrino mass

Neutrinos have three mass states m_1, m_2, m_3 . Assuming that the three masses follow a geometric progression, the calculation is as follows.

$$m_1 = \frac{1}{r^2 V_H^2} M_H = \frac{M_H}{V_H} = 0.00179 eV/c^2 \quad (7.11)$$

$$m_2 = \frac{1}{r^{1.5} V_H^2} M_H = \frac{M_H}{V_H} = 0.01037 eV/c^2 \quad (7.12)$$

$$m_3 = \frac{1}{r^1 V_H^2} M_H = \frac{M_H}{V_H} = 0.06010 eV/c^2 \quad (7.13)$$

Here, we assume that $m_1 < m_2 < m_3$. Comparison with experimental values is shown in Table 7.2. Although there is some error, the values obtained are close to the experimental values [1]. The total value is within the limit of $0.12 eV/c^2$ [1].

Table 7.2. Neutrino mass

	Rest mass [eV/c^2]				
	Geometric progression		Δ	Experimental	Error
m_1	$\frac{1}{r^2 V_H^2} M_H$	0.00179	$\sqrt{7.37 \times 10^{-5}}$	$\sqrt{7.53 \times 10^{-5}}$	-1.1%
m_2	$\frac{1}{r^{1.5} V_H^2} M_H$	0.01037			
m_3	$\frac{1}{r^1 V_H^2} M_H$	0.06010	$\sqrt{2.473 \times 10^{-3}}$	$\sqrt{2.455 \times 10^{-3}}$	+0.4%

The mass of a neutrino is proportional to the inverse square of V_H , which may suggest that mass is generated by a secondary effect. Charged leptons can be thought of as experiencing the resistance of the Higgs field in a portion of their volume, while neutrinos can be thought of as experiencing the resistance of the Higgs field when two portions of their volumes overlap.

Geometric quark mass

Assuming that the mass of a quark is proportional to the volume of a portion of the cylinder, just like the charged leptons, we can express it as shown in Table 7.3. Although there is some error, the values obtained are close to the experimental values [1].

Table 7.3. Quark mass

	Geometric			Volume V	Rest mass M [GeV/c ²]		
	Height	Radial	Axial		$\frac{V}{V_H} M_H$	Experimental	Error
d	9			9	0.00452	0.00470	-3.7%
s		$\frac{1}{3\sqrt{3}} 2\pi \left(\frac{1}{2}r\right)$		$\sqrt{3}\pi r$	0.0918	0.0935	-1.8%
b		$\pi \left(\frac{1}{2}r\right)^2$		$\frac{9}{4}\pi r^2$	4.006	4.183	-4.2%
u	$\frac{9}{2}$			$\frac{9}{2}$	0.00226	0.00216	+4.7%
c		$\frac{1}{\sqrt{3}} 2\pi \left(\frac{9}{2}r\right)$		$\frac{81}{2\sqrt{3}}\pi r$	1.240	1.273	-2.6%
t		$\pi \left(\frac{9}{2}r\right)^2$		$\frac{729}{8}\pi r^2$	162.2	172.6	-6.0%
e	1			1	0.000503	0.000511	-1.6%
μ		$2\pi r$		$2\pi r$	0.1060	0.1057	+0.4%
τ		πr^2		πr^2	1.780	1.777	+0.2%
H	$\frac{2\pi r}{3}$	πr^2		$\frac{2}{3}\pi^2 r^3$	125.20	125.20	(0)

Assuming that the three generations of quarks follow a geometric progression, the coefficient of the second generation was corrected to approach the experimental value. The coefficients appear to have a certain regularity. This result may be coincidental, but it may have some meaning.

8. Gravity

Interpretation of Gravity

Gravity is on the same scale as other forces when the mass of an elementary particle is as large as the Planck mass. A small force means that it is nearly symmetric. The

greater the energy, the shorter the wavelength λ . We assume that there is some constant length l_G regardless of the energy. In that case, we can assume that the asymmetry of gravity a_G is as follows.

$$a_G = \frac{l_G}{l_G + \lambda} \quad (8.1)$$

Here, l_G is a length close to the Planck length. The shorter the wavelength, the closer the asymmetry is to 1. If $l_G \ll \lambda$, the asymmetry is proportional to the energy. If this assumption is correct, then as we approach the Planck energy scale, the strength of gravity weakens and is not proportional to the energy. The greater the energy, the stronger the gravity, but this formula is assumed due to the constraint that the asymmetry must not exceed 1.

l_G can be interpreted as follows. The size of a graviton is l_G . The size of anything other than a graviton is the wavelength λ . All particles have gravitons inherently. Gravitons interfere only with gravitons, reinforcing the waves. The larger λ becomes, the smaller the ratio of inherent l_G becomes, so the interference becomes weaker.

Gravitons can be interpreted as follows. Particles other than gravitons have positive and negative phases. Gravitons do not interfere with anything other than gravitons, so the phase of a graviton is neither positive nor negative. Therefore, we assume a complex phase. If the front of a surface has a positive phase and the back has a negative phase, the phase of a graviton is a cross section. It can be expressed as the phase of an imaginary number. A graviton G is illustrated in Fig. 8.1.

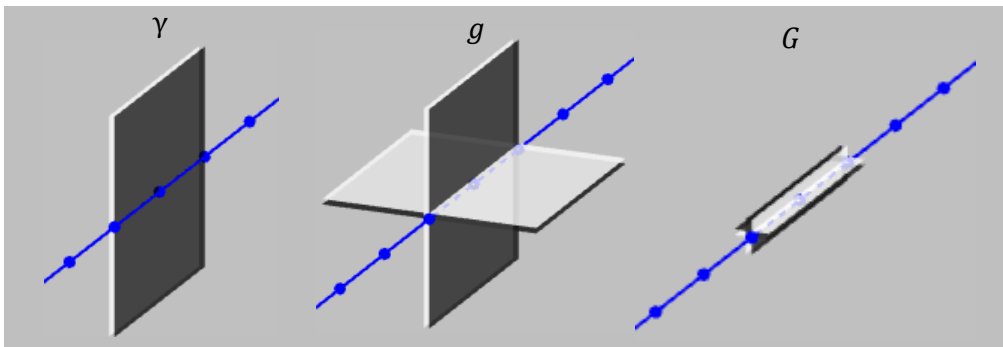

Fig. 8.1. Graviton

The graviton G returns to its original state when rotated 180 degrees. This is a property of spin 2. If the phase in a certain direction is an imaginary number, then the part rotated 90 degrees is a negative imaginary number because the colors on the left and

right are reversed. Like photons and gluons, it is symmetrical in the direction of travel, so its mass is 0.

If the cross section between positive and negative is the phase of an imaginary number, then it can be said that particles other than the graviton also have an imaginary phase. Particles other than the graviton are thought to have an equivalent imaginary phase, rather than containing the graviton itself.

Gravity force gauge coupling constant

The gauge coupling constant for gravity is calculated in the same way as for other forces. As with the electromagnetic force, when the graviton mediates the interaction between two distant particles, only half of it is involved, so it is 1/2.

$$g_{half} = \frac{1}{2} \quad (8.2)$$

The gradient for spin $L_z = 2$ is calculated as before.

$$g_{spin} = \frac{L_z}{\sqrt{L_z(L_z + 1)}} = \frac{2}{\sqrt{2(2 + 1)}} = \frac{2}{\sqrt{6}} \quad (8.3)$$

Gravitons are considered to have the shape of a line, not a surface. A line is the intersection of a surface and a perpendicular surface. In other words, there is no need to consider them as separate entities like γ and Z^0 , one entity plays both roles. Therefore, we have the following equation.

$$g_{plane} = 1 \quad (8.4)$$

If the graviton in the perpendicular direction had mass, $g_{plane} = \cos 30^\circ$, but we assume that this is not the case. The gauge coupling constant of gravity, g_G , is given by follows.

$$g_G = g_{half} \times g_{spin} \times g_{plane} = \frac{1}{2} \times \frac{2}{\sqrt{6}} \times 1 = \frac{1}{\sqrt{6}} \quad (8.5)$$

Modified Planck Scale

The Planck mass M_p is the mass when the gauge coupling constant is strong enough to correspond to 1. However, the gauge coupling constant of gravity has been calculated to be $g_G = 1/\sqrt{6}$. The mass when the gauge coupling constant is strong enough to correspond to $1/\sqrt{6}$ is defined as the modified Planck mass $M_{p'}$.

$$M_{P'} = g_G \times M_P = \frac{1}{\sqrt{6}} \times \sqrt{\frac{\hbar c}{G}} = 8.885 \times 10^{-9} kg \quad (8.6)$$

The gravitational constant G used is following [1].

$$G = 6.674 \times 10^{-11} m^3 kg^{-1} s^2 \quad (8.7)$$

Similarly, the modified Planck length $l_{P'}$ is also defined.

$$l_{P'} = \frac{1}{g_G} \times l_P = \sqrt{6} \times \sqrt{\frac{\hbar G}{c^3}} = 3.959 \times 10^{-35} m \quad (8.8)$$

The modified Planck length $l_{P'}$ is the length that determines the strength of gravity and corresponds to the length of the graviton l_G .

$$l_G = l_{P'} \quad (8.9)$$

Scale hierarchy

The ratio of the Higgs mass to the modified Planck mass has the following hierarchy of values.

$$\frac{M_{P'}}{M_H} = 3.981 \times 10^{16} \quad (8.10)$$

The length hierarchy W is considered to be as follows.

$$W = \frac{2\pi l_{P'} \times 2\pi l_H}{(2l_{P'})^2} = \pi^2 \frac{l_H}{l_{P'}} = 3.929 \times 10^{17} \quad (8.11)$$

Here, $2\pi l_H$ is the Compton wavelength of the Higgs mass. The denominator is the area obtained by square the Schwarzschild radius at the modified Planck scale. The numerator is the area of a cylinder whose radius is the modified Planck scale and whose length is the Compton wavelength. W is the ratio of the two areas. Number of states W can also be said to be the number of states that selects the smaller area from among the larger areas. Entropy S is expressed as the natural logarithm of the number of states W.

$$S = k_B \ln W = 40.512 \approx \frac{81}{2} \quad (8.12)$$

Entropy S is approximately expressed as an integer. Here, we use a unit system with the Boltzmann constant $k_B = 1$. In relation to entropy, there is the following law of equipartition of energy.

$$E = \frac{1}{2} N k_B T \quad (8.13)$$

T is the temperature, and the following relationship exists between energy E and entropy S.

$$S = \frac{E}{T} \quad (8.14)$$

From these equations, the degree of freedom N is calculated.

$$N = 2 \ln W \approx 81 = 3^4 \quad (8.15)$$

If we assume that gravity has 81 more degrees of freedom than other forces, we can explain the hierarchy. We can imagine gravity, with three degrees of freedom, lined up in a three-dimensional array of $3 \times 3 \times 3$.

On the other hand, the cube of the volume of a cylinder $V_{cylinder}$, using r derived from the Koide formula is close to W.

$$V_{cylinder} = \pi r^2 \times 2\pi r \quad (= 3V_H) \quad (8.16)$$

$$W \approx V_{cylinder}^3 = (3V_H)^3 = 4.172 \times 10^{17} \quad (8.17)$$

In this interpretation, entropy cannot be an integer. At least one of the two interpretations are coincidental.

9. Cosmology

Dark Energy

The mass M_Z of the Higgs particle corresponds to an asymmetry of 1 and is considered to be a natural unit. Since it is the only mass, we can predict that the universe began with that mass. Similarly, we predict that the length at the beginning of the universe is the length l_H , which is M_H converted into natural units.

$$l_H = \frac{\hbar}{M_H c} = 1.576 \times 10^{-18} m \quad (9.1)$$

We assume that post cosmic inflation, l_H is multiplied by the hierarchy W to become $l_{H'}$.

$$l_{H'} = W \times l_H = 3.929 \times 10^{17} l_H = 0.6193 m \quad (9.2)$$

Calculate the volume of the sphere.

$$V_{sphere} = \frac{4}{3}\pi l_H^3 = 0.9984m^3 \quad (9.3)$$

The difference between the Higgs vacuum expectation value and $2M_H$ can be said to be an asymmetry of the vacuum, and is therefore thought to correspond to dark energy.

$$a_{v.e.v.} = \frac{2M_H - v.e.v.}{M_H} = 3.34\% \quad (9.4)$$

$$E = a_{v.e.v.}M_H = 2M_H - v.e.v. = 4.18GeV/c^2 = 7.45 \times 10^{-27}kg \quad (9.5)$$

Calculate the energy density.

$$\frac{E}{V_{sphere}} = 7.49 \times 10^{-30}g/cm^3 \quad (9.6)$$

The experimental value of dark energy is following [1].

$$5.83 \times 10^{-30}g/cm^3 \quad (9.7)$$

The theoretical value and the experimental value are close. However, $a_{v.e.v.}$ needs to be determined experimentally. Therefore, we consider the following value.

$$\frac{1}{r} = \frac{1}{33.57715} = 2.987216\% \quad (9.8)$$

r is derived from the Koide formula, and its reciprocal is close to $a_{v.e.v.}$. We assume that they are the same.

$$a_{v.e.v.} \approx \frac{1}{r} \quad (9.9)$$

Using this value, we calculated the dark energy as follows.

$$E' = \frac{1}{r}M_H = 3.729GeV/c^2 = 6.647 \times 10^{-27}kg \quad (9.10)$$

$$\frac{E'}{V_{sphere}} = 6.682 \times 10^{-30}g/cm^3 \quad (9.11)$$

The theoretical value is approaching the experimental value. $a_{v.e.v.}$ and $1/r$ are equal when M_H is the following value.

$$M_H = \frac{v.e.v.}{2 - 1/r} = 124.97GeV/c^2 \quad (9.12)$$

This is within 2σ of the experimental value and is likely to be the true value [1].

When predicting the mass of leptons using the Koide formula, the volume V_H of the

Higgs particle was assumed to be a cylinder with a length of $2\pi r/3$, or a cone with a length of $2\pi r$. If we calculate the dark energy assuming the volume V_{cone} of that shape, rather than a sphere, we get the following.

$$V_{cone} = \pi l_{H'}^2 \times \frac{2\pi l_{H'}}{3} = 1.5626m^3 \quad (9.13)$$

$$\frac{E}{V_{cone}} = 4.769 \times 10^{-30} g/cm^3 \quad (9.14)$$

$$\frac{E'}{V_{cone}} = 4.254 \times 10^{-30} g/cm^3 \quad (9.15)$$

This calculation also gave values close to the experimental values.

These results suggest that the inflation of the universe created the hierarchy of gravity. At the beginning of the universe, there was only the natural unit, the Higgs boson. $1/r$ of the energy of the Higgs boson was diluted by inflation to dark energy.

Dark matter ratio

The energy makeup of the universe is 68.5% dark energy, 26.57% dark matter, and 4.93% normal matter. [1] The proportion of normal matter is following.

$$\frac{\Omega_{baryon}}{\Omega_{baryon} + \Omega_{cold\ dark\ matter}} = \frac{4.93\%}{4.93\% + 26.57\%} = 15.7\% \quad (9.16)$$

From the hierarchy W, the following calculation can be made.

$$\frac{1}{\sqrt{\ln W}} = \frac{1}{\sqrt{40.512}} = 15.7\% \quad (9.17)$$

This is almost the same as the ratio of normal matter. If you square the ratio of normal matter, you get the following formula.

$$\left(\frac{\Omega_{baryon}}{\Omega_{baryon} + \Omega_{cold\ dark\ matter}} \right)^2 = \frac{1}{40.825} \quad (9.18)$$

This can be interpreted as the probability that when two matter particles meet, both are normal matter. This value is almost equal to the entropy, which is the natural logarithm of the hierarchy W of gravity. If this is not a coincidence, we can infer that the ratio of normal matter was determined by inflation. In other words, after inflation is complete, the amount of dark matter is conserved. We predict that normal matter and dark

matter cannot be converted into each other.

When $W = 1$, the amount of dark matter is 0, which means that we can predict that dark matter did not exist before inflation.

Baryon number

The baryon number η of the universe is estimated to be following [1].

$$\eta = \frac{n_{baryon}}{n_\gamma} = 6.04 \times 10^{-10} \quad (9.19)$$

From the hierarchy W , the following calculation can be made.

$$\frac{1}{3\sqrt{W}} = 5.318 \times 10^{-10} \quad (9.20)$$

This value is close to the baryon number. The division by 3 is done to convert the number of quarks to the baryon number. It can also be written as following.

$$\left(\frac{n_{quark}}{n_\gamma}\right)^2 = (3 \times 6.04 \times 10^{-10})^2 \approx \frac{1}{W} \quad (9.21)$$

This can be interpreted as $1/W$ being the probability that when two particles meet, neither of them will be an antiparticle. If this is not a coincidence, we can infer that the baryon number was determined by inflation. That is, after inflation is complete, the baryon number is conserved. If a non-conservation of the baryon number, such as proton decay, were observed, this hypothesis would be disproved.

When $W = 1$, the number of quarks is 1. This means that before inflation, there were only particles, and no antiparticles. It is not that something that was symmetrical was broken into an asymmetry, but rather that the universe has been asymmetrical from the beginning. Since energy and asymmetry are equivalent, some kind of asymmetry must have existed when energy existed in the universe. If it is unnatural for the universe to be asymmetry from the beginning, then it is conceivable that there exists an asymmetric pair of universes, although this cannot be observed.

Mass of the observable universe

The natural logarithm of the length hierarchy W can be expressed as a value close to an integer.

$$\ln W = 2.00061 \times \left(\frac{9}{2}\right)^2 \quad (9.22)$$

It is unclear what 9/2 represents, but we will calculate what happens when we change it from a square to a cube.

$$\ln W' = 2.00061 \times \left(\frac{9}{2}\right)^3 \quad (9.23)$$

Multiply that hierarchy by the Higgs mass.

$$W' M_H = 3.33 \times 10^{54} \text{ kg} \quad (9.24)$$

This is close to the commonly assumed mass of the observable universe, but includes dark matter and dark energy. The factor 9/2 also appears in the empirical formula for the mass of quarks, but it is unclear whether this is related or coincidental.

10. Theory of Everything

The summary of all forces

All forces are summarized in Table 10.1.

Table 10.1. All forces

	Symmetry	Charge source	Gauge coupling constant					
			g_{half}	g_{spin}	g_{plane}	g	exp.	error
g	Radial (Rotation)	1 [color] 1/3 [Y]	1			0.333 1	0.344	-3.0%
γ	Axial	1 [T+Y]	$\frac{1}{2}$	$\frac{1}{\sqrt{2}}$	$\cos 30^\circ$	0.306	0.303	+1.1%
Z^0					$\sin 30^\circ$	0.177	0.166	+6.4%
W^\pm	Time moves	1/2 [T]			1	0.707	0.718	-1.5%
G	Size	1 [T+Y]		$\frac{2}{\sqrt{6}}$	1	0.408		
H	Space move	1 [T+Y]	1			1		

g (gluon) mediates the radial asymmetry. The radial direction is the direction of rotation due to spin. Orthogonal to the radial direction is the axial direction. The axial asymmetry is mediated by γ and Z^0 . γ and Z^0 are orthogonal to each other. g , γ and Z^0 are orthogonal to each other and correspond to the three dimensions of space. Z^0 , along with W^\pm , also mediates the asymmetry in time moving. The asymmetry in space moving is mediated by H . G mediates the size asymmetry. An image of all the forces is shown in Fig. 10.1.

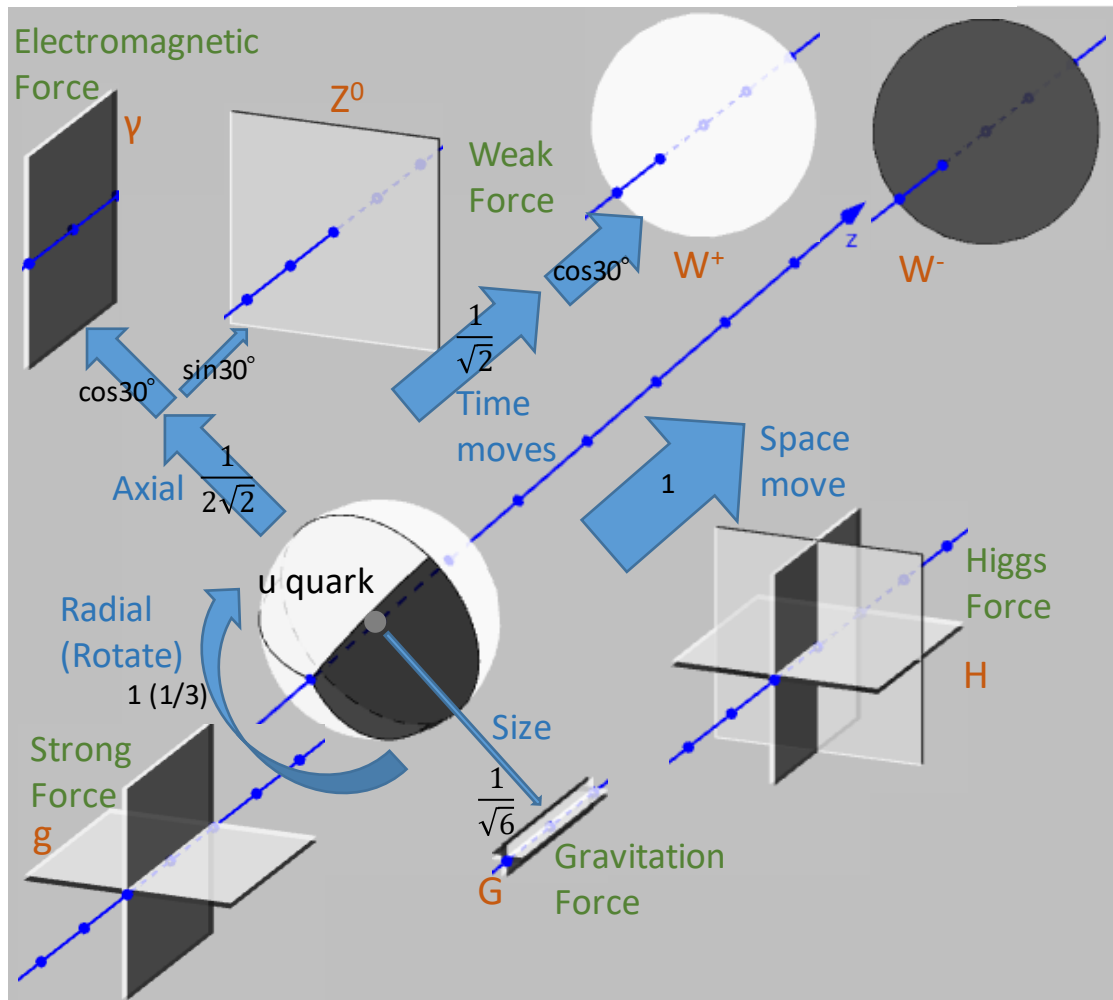

Fig. 10.1. All forces image

The potential of unknown power

Consider the possibility of unknown forces. Consider the existence of symmetries other than the known ones. The deformation of a three-dimensional shape is expressed by an affine transformation matrix. It is a matrix with $4 \times 3 = 12$ quantities. When a three-dimensional shape is input, a three-dimensional shape is output. One dimension is added to represent translation. Being expressed by 12 quantities means that 12 types of deformation are possible. In other words, there are 12 symmetries. There are three rotations, three translations, three scaling, and three shear deformations, for a total of 12. The three rotations are handled by g, γ, Z^0 . The three translations are handled by H. H has no directionality and can handle three directions with one type. The three scaling are handled by G. Scaling that maintains the aspect ratio can be expressed by one quantity. If scaling that does not preserve the aspect ratio is possible, gravity with

different strengths will occur depending on the direction. If such a phenomenon does not exist, it can be said paradoxically that the shape of the particle is isotropic. However, in order to observe the strength of gravity depending on the direction, it is difficult to do so because it is necessary to align the direction of a large number of particles. Shear deformation does not exist if the shape of the particles is isotropic. If we consider dark matter as well, the existence of an unknown force due to the asymmetry of shear deformation cannot be denied.

Natural Units

As shown in Table 10.2, we define the Higgs unit with $M_H = 1$. The Planck unit is set based on the strength of gravity. On the other hand, the Higgs unit is set based on the magnitude of symmetry. It is a unit based on the strength of all forces, not a specific force. The three units of Higgs length, Higgs time, and Higgs mass correspond to the asymmetry of 1.

Table 10.2. Natural units

	Planck units (Gravity standard)	Higgs units (Symmetry standard)
Definition	$c = 1$	$c = 1$
	$\hbar = 1$	$\hbar = 1$
	$G = 1$	$\left(G = \frac{\pi^4 \hbar c}{6W^2 M_H^2}\right)$
	-	$M_H = 1$
Units	$l_p = 1.6166 \times 10^{-35}m$	$l_H = 1.5761 \times 10^{-18}m$
	$t_p = 5.3925 \times 10^{-44}s$	$t_H = 5.2573 \times 10^{-27}s$
	$M_p = 2.1759 \times 10^{-8}kg$	$M_H = 2.2319 \times 10^{-25}kg$

The unity of forces strength

We do not expect all gauge coupling constants to match at the energy scale of the early universe, as in the grand unified theory. Matching something is not necessarily more natural or beautiful than not matching it. It is beautiful from some perspective that all forces were unified into one at the early universe. However, this means that at least one type of force is enough for the universe. One type is enough, but the symmetry has been broken and it has been differentiated into multiple forces that can be either present or

absent. If something that is not necessary exists, it can only be said that it was decided by chance. It is unscientific because it cannot be disproved that it is a coincidence. I think it would be more beautiful if all existing forces were necessary and there were no unnecessary forces. The known forces correspond to their respective symmetries and there does not seem to be any excess or deficiency. Consider the possibility that the strength of forces is unified at the energy scale of the early universe. It is necessary that the amount of interference of waves due to translation and the amount of interference of waves due to rotation are the same. Translation and rotation are different phenomena, so there is no need for them to match. All forces are unified in the sense that the actual strengths acting do not have to match, but the strength of the forces is the same if the magnitude of the asymmetry is the same.

Time Machine

If the principle of standing waves is correct, time travel to the past is also possible. It takes advantage of the fact that the spatial axis in the direction of travel and the time axis are shared and cannot be distinguished. We will explain this using Fig. 10.2. Prepare a car that can wrap itself around itself in a black hole shell. All that is required is that the event horizon is spherical and that it can block information from inside and outside. If only the shell is a black hole and the area near the center is not inside the black hole, a human can survive inside. First, assume that the car is traveling at 2km/min. At 0min, the car is wrapped in a black hole. Information is blocked and the inside cannot be seen from the outside. The black hole continues to move at 2km/min due to inertia. After 1min, it is at the 2km point. On the other hand, the outside cannot be seen from inside the black hole. Suppose that the car is braked and decelerated from 2 to 1km/min. After 2min, it reaches the 2km point. The black hole is eliminated at this point. It should appear that the black hole has been eliminated at the same point even when viewed from the outside. However, at the 2km point, it is 2 minutes later on the inside, but 1 minute later on the outside. In other words, the car arrived in the past. It can also be interpreted as the speed at which time flows being different for the two places. Since information is blocked, there is no contradiction in causality.

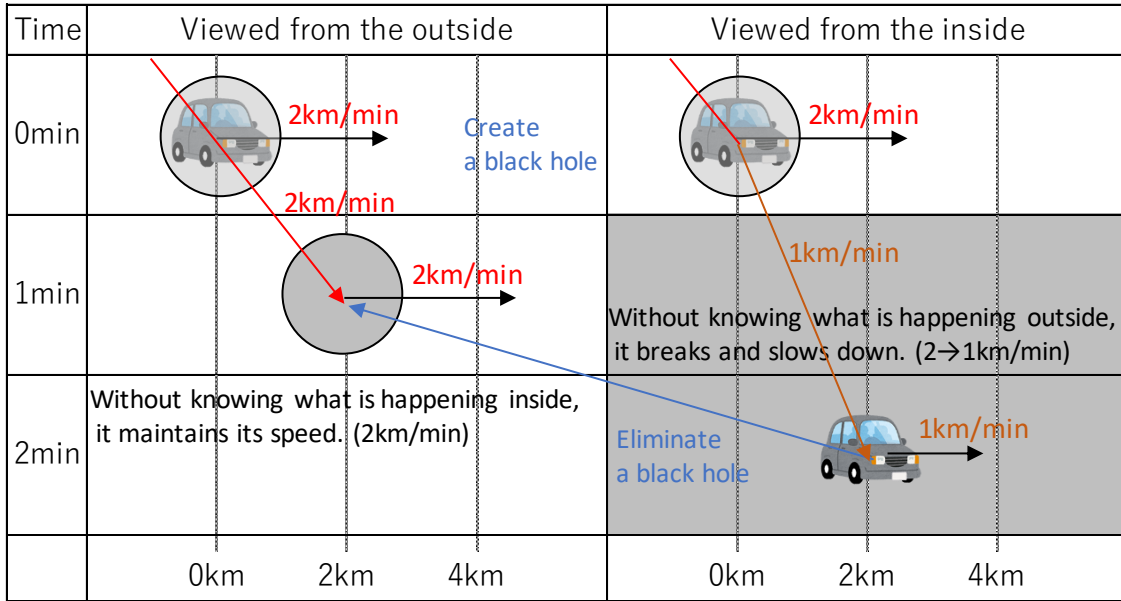

Fig. 10.2. Time machine

Since the position on the spatial axis corresponds to the position on the time axis, the time of arrival is ultimately determined by the position where the black hole is released. So, what happens if the car is reversed and returns to a time before the black hole was generated? It can be assumed that the person in the car will arrive at the time before the black hole was generated. However, if the car suddenly appears when viewed from the outside, this contradicts the conservation laws. When viewed from the outside, the car must have been there all along. In other words, it has moved to a different world line. In the first place, when information is blocked by the black hole, it is separated from the original world line. When the information blockade is released, it is thought to connect to a world line that satisfies the conservation laws.

Experiment of rewriting the past

If the principle of standing waves is correct, the spatial axis and the time axis cannot be distinguished. Observation does not necessarily determine only the quantum state at the moment of observation. It may also affect the past. Consider the double slit experiment shown in Fig. 10.2. Let the shorter optical path length be L_1 and the longer one be L_2 . There is a movable mirror on the longer one. When the time $L_1/c \leq t < L_2/c$, the light from L_2 cannot arrive yet, so there is no interference. A pattern that is not a stripe is drawn on the screen. When the time $L_2/c \leq t$ is reached, interference becomes possible, so a stripe pattern is drawn on the screen. The latter is what we usually see as the result of the double slit experiment. The pattern that was drawn in the past has

been rewritten. Since interference occurs even when the optical path difference is many times the wavelength, this cannot be explained by the uncertainty principle. After the past has been rewritten, it is difficult to recognize this because there is no information left that it was originally that way. It can also be expressed as a change in the world line. Also, by moving the mirror, you can choose how to rewrite the past. All quantum states that we think are definite are in fact only provisional: a little bit of light might tunnel out of the device, be gravitationally lensed by a black hole, and come back, rewriting the interference patterns. All quantum states are subject to rewriting in the future.

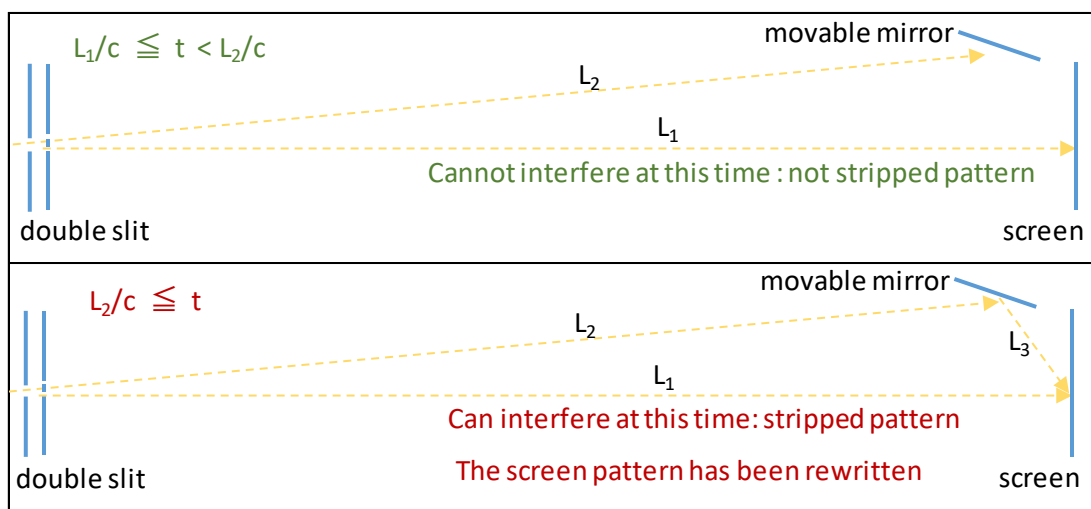

Fig. 10.2. Experiment of rewriting the past

11. Conclusion

The electromagnetic, strong, Higgs, weak, gravity force are explained as the result of interference. The force is that the waves try to avoid weakening and to strengthen each other to increase their probability of existence. These forces correspond to axial, radial, space moving, time moving, size symmetry. The electroweak unification theory can be interpreted in beautiful geometry, with γ and Z^0 being orthogonal planes, W^\pm being a sphere, and the Weinberg angle θ_W being the angle of 30° between the sphere and a plane.

The principle of standing waves is that the space and time axes are shared and particles are always standing waves. A strong force was needed to maintain the standing wave even when rotating. Also, the Higgs force was needed to maintain the standing wave even when moving parallel.

The gauge coupling constant represented the magnitude of the asymmetry. The theoretical and experimental values of the gauge coupling constant were in close

agreement. All forces were unified, in that if the magnitude of the asymmetry was the same, the strength of the force was also the same. The mass of the Higgs particle was a natural unit corresponding to an asymmetry of 1. Energy and asymmetry were equivalent. The theoretical and experimental values of the rest mass of the gauge particle were in close agreement. Photons are symmetrical from front to back, so they have zero mass.

Only some of the masses and mixing angles of fermions have been theoretically calculated. Empirically, using the Koide formula, the masses of all fermions can be expressed as geometric volumes. It has been suggested that the generation is related to the dimension number of the space.

By calculating the gauge constant of gravity, we obtained a value that represents the hierarchy of gravity and the Higgs. From that value, we empirically obtained approximations for dark energy, dark matter fraction, and baryon number. Dark energy is the energy difference between $2\times$ the Higgs mass and the vacuum expectation value divided by the volume of the Higgs particle inflated by the hierarchy of gravity. All forces and mass are not just one or something that was unnecessary in the early universe, they are all necessarily necessary. In the end, all that is needed to explain everything is the basic principle that everything is a standing wave.

References

- [1] Particle Data Group. (2024). "The Review of Particle Physics (2024)".
<https://pdg.lbl.gov/2024/>
- [2] Koide, Y. (2005). "Challenge to the mystery of the charged lepton mass".
<https://arxiv.org/abs/hep-ph/0506247>