

Temporal Calculus: resolving Elementary Particle formation and confinement

26th September 2020

Stephen H. Jarvis.

License: CC BY-NC-ND 4.0

<http://orcid.org/0000-0003-3869-7694> (ORCID)

EQUUS AEROSPACE PTY LTD

Web: www.equusspace.com

email: shj@equusspace.com

Abstract: Here Temporal Calculus explains the formation of the elementary particles as mass-structures, defining their confinement and relationship to their over-arching quantum environment, detailing the concepts of symmetry breaking, asymptotic freedom, particle confinement, and baryon asymmetry, as a follow-on from the proposed solution to the “Yang Mills existence and mass gap” problem of the previous paper, here moreover introducing a new phenomenon, namely “atomic barrier enhancement”, pointing to mechanisms for new atomic fuel generation, here explained in the form of Hydrogen fuel generation.

Keywords: calculus; temporal; Yang-Mills; symmetry breaking; asymptotic freedom, kaon; particle confinement; baryon asymmetry; atomic barrier enhancement; hydrogen fuel

1. Introduction

As a continuation of the Temporal Calculus series of papers [1-26], here Temporal Calculus moves on to discuss the fundamental process involved in elementary and thence subatomic particle formation and associated confinement properties of particles. Highlighted in this paper shall be four key features of Temporal Calculus:

- (i) The idea of symmetry breaking as the time-algorithm
- (ii) The energy manifolds identified with the time-algorithm
- (iii) The time-point patterns generated in the context of those energy-manifolds
- (iv) The resultant particle formation and behaviour of the time-point patterns of those energy manifolds

In this paper, the reader must put aside the notion of the Λ CDM (big bang) model, of time and thence energy (as entropy) beginning at the proposed initiation of the big bang. Here, the reader must consider the proposal for a steady state manifold of energy as time-points in space, a general theme of time's arrow split into 3 (time-before, time-now, and time-after) that allows for the formation of two distinct energy processes, entropy and enthalpy, and how this effects a general pattern of time-space and associated manifestation of mass, as described in the Temporal Calculus series of papers [1-26].

In reviewing such a presented case [1-26], first the time-algorithm shall be re-presented in identifying the idea of symmetry breaking. Then, the general time-space pattern and associated energy structure (entropy and enthalpy) shall be explained, following which a description as to how mass-particles form in the time-space vacuum, explained as atomic "*barrier enhancement*". To highlight the effectiveness of Temporal Calculus, namely the effectiveness of the unique mathematical relation between time and space, 3 key subatomic phenomena shall be accurately described by this method of time-space analysis, namely asymptotic freedom, Kaons, and Baryon asymmetry. Following such, a proposed new phenomenon as "*atomic barrier enhancement*" shall be outlined, not accounted for by contemporary physics theories.

This paper shall be divided into the following sections as such:

1. Introduction
2. The time-algorithm: symmetry breaking
3. Time-space energy pattern formation
4. Particle-mass formation as EM^{DIR} barriers
5. Asymptotic freedom, Kaons, and Baryonic Asymmetry
6. Atomic Barrier Enhancement
7. Conclusion

As shall be highlighted, Temporal Calculus as a mathematics is more broad ranging and accurate in its application to physical phenomena and associated data than contemporary mathematical utilities, able to link both the data and associated phenomena of Quantum Mechanics (and QFT) with the Standard Model of particle physics, while describing a new set of axioms for time and space, a new mathematical dynamic between time and space, that owing to its sizeable body of work needs to be thoughtfully and thoroughly presented and referenced appropriately.

2. The time-algorithm: Symmetry Breaking

In physics, symmetry breaking [27] is a process that describes infinitesimally small fluctuations either acting on or being intrinsic to a nominated system context in time and space (a particle) crossing a critical point and deciding the fate of that particle's position, by determining which branch of a bifurcation is taken for the manifestation of that particle's motion status (namely reference of position in space in regard to time). This process is thought to play a major role in pattern formation (despite yet being proven on the atomic and associated elementary particle level).

Physics considers there to be two types of symmetry breaking, *explicit* symmetry breaking and *spontaneous* symmetry breaking, characterized respectively by whether the intrinsic property of the nominated system context (particle) fails to be invariant (breaks symmetry as a particle process, as explicit) or the ground state (the vacuum itself effecting the particle, presumably) fails to be invariant (breaks symmetry for the particle process, as spontaneous).

The logic of pattern formation is that a general outcome of symmetry breaking for a system of particles will eventuate a general pattern of particle behaviour that has an intrinsic (particle) and external (vacuum) connection, which is a logical thing to consider if indeed "space" as the vacuum relates well with the idea of gravity, and the intrinsic property of a particle relates well with electromagnetic phenomena, or in short, the idea of an overall pattern would be that overall display of particles behaving with one another in the context of gravity and EM.

Of course in the absence of a theory linking EM and G, the nature of the pattern is given as a fundamental nature of symmetry breaking being the primordial effecting constituent, yet of course also as a result of the initial conditions of the proposed Λ CDM big bang event where that fine-tuning evident at that time of initiation, presumably, at that moment of rapid expansion, lead to the general "pattern" of what exists today.

Temporal Calculus, in not abiding by the Λ CDM given the Λ CDM's list of problems ([17]: p3-4), has set about constructing a time-algorithm that proposes a process of symmetry breaking in the context of time-points in space, two results as per the following equation from paper 1 ([1]: p3-4):

If indeed the future is unknown, then we can suggest the following:

$$t_A = ? \quad (2)$$

Let's propose that the idea of increasing entropy obeys the following process of time: time divides from a singularity in the "past" t_B to a duality in the "future" t_A , where t_A is two possibilities of t_B (fig. 8.):

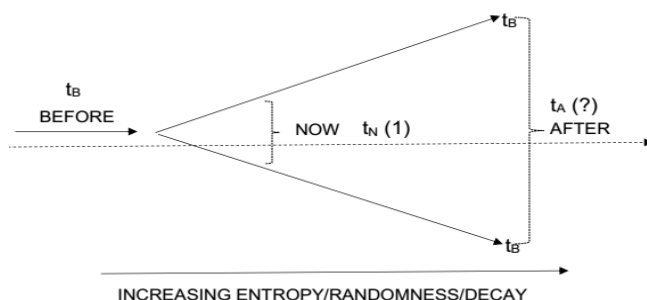

paper 1 [1], Figure 8.

Here t_N represents that process of time-dividing, becoming dual time as t_A , as two possible outcomes for t_B , a process of symmetry-breaking for a vector of 0-scalar space (as it involves a process of an uncertain outcome), yet here we are assigning this feature of symmetry-breaking to time. Let us suggest the following:

$$t_A = t_B^2 \tag{3}$$

Now consider the following as a standard for time's flow:

$$t_N = 1 \tag{4}$$

Here time "now" has a constancy (in its application to space), a uniformity (eq. 1.) that has the potential for entropy, of division, of diversity, of symmetry-breaking for S_2 (compared to S_1). Let us also consider a standard:

$$t_N = t_A - t_B \tag{5}$$

Simply, t_B when applied to space (as 1, t_N) leads to t_A , as a proposed equation for "time". Thus:

$$\begin{aligned} t_B + 1 &= t_B^2 \\ \frac{t_B + 1}{t_B} &= t_B \\ \frac{t_B^2 + t_B}{t_B^2} &= \frac{t_B^2}{t_B^2} \\ \frac{t_A + t_B}{t_A} &= \frac{t_A}{t_B} \end{aligned} \tag{6}$$

This equation is significant, for it represents the "golden ratio"[7], ϕ , which is solved as a quadratic equation for t_B as -0.61803... or 1.61803...; for each scalar/vector event in space, each past event is divided as a "now" event into the future as a change in state/reference in time, hence "randomness", "entropy", etc. Note each result for t_B can be 1.61803... or its negative inverse (-1/1.61803) as -0.61803... (the quadratic solutions for t_B).

The idea of both the vacuum of space and the intrinsic nature of the particle (as the time-point sub-structure) accounts for both the idea of the spontaneous (vacuum) and specific (time-point) symmetry breaking nature of a particle, namely that its context in space as a passage of time from time-before (t_B) to time-after (t_A) via time-now (t_N) results in a ϕ and $-\frac{1}{\phi}$ outcome that itself must as an equation for time be relevant to not t_A yet t_B , given that paradoxically t_A is designed to be " $t_A = ?$ " as per (2) above. What this means is that the two different values for the golden ratio as a t_A outcome that loops back to t_B (as presented in paper 6) presents the case of a new time-point position in space, and thus a different course of motion. Note here the time sequence from paper 6 ([6]: p4, table5):

Paper 6, Table 5

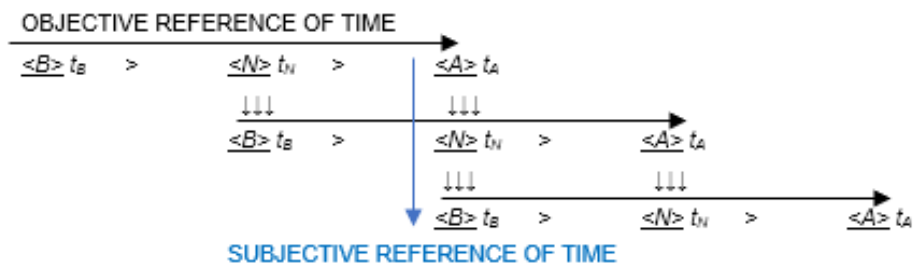

To note also is how time was defined initially as a time-point in space, namely a different position in space, as it can only be, as presented in paper 8, “The Golden Ratio Time Algorithm” ([8]: p4, eq1-7):

In mathematics, an equation is a statement that asserts the equality of two expressions. To present an “absolute” equation for time then requires a type of equality to be established between two expressions of time. What can we say about “time” that has two expressions using both “1” (as t_N) and t_B , as an expression of equality?

We traditionally have related time-before to time-after along a basic linear mathematical construct as $t_B > t_N > t_A$. Is time so simple though?

Let’s break it down further. For instance, we know that placing t_B next to t_N requires a negative sign for t_B (equation 1) given t_B would be a “backward/negative” step compared to (in reference to) t_N .

$$(-t_B) + 1 = \text{fundamental property A} \quad \text{equation 1.}$$

Yet, if time is a singularity, we can present the case that t_N can also be “per” ($-t_B$) as another equation for the flow of time, as technically t_B would already be contained within the t_N construct, as it would have already happened (equation 2).

$$\frac{1}{(-t_B)} = \text{fundamental property B} \quad \text{equation 2.}$$

The question now is regarding their relationship (A and B).

*If these two features represent fundamental processes to time, **and time itself is a singularity**, then fundamental property A must equate to fundamental property B (equation 3.)*

$$(-t_B) + 1 = \frac{1}{(-t_B)} \quad \text{equation 3.}$$

Essentially we are taking two proposed properties of the mathematical relationship between t_B and t_N and equating them together as the algorithm for time.

From equation 3, we arrive at the following (equations 4-5).

$$t_B^2 - t_B = 1 \quad \text{equation 4.}$$

$$t_B + 1 = t_B^2 \quad \text{equation 5.}$$

Equation 5 is interesting, as essentially it suggests that if we consider an “arrow of time” equation that is absolute, and we add the past as a “positive value” (as it would be in considering an arrow of time equation) to t_N , as past + present, only logically we would arrive at the future, let us call t_A (equation 6.)

$$t_B + 1 = t_A \quad \text{equation 6.}$$

Yet as we know, $t_B^2 = t_A$ (equation 7.)

$$t_B^2 = t_A \quad \text{equation 7.}$$

Accommodating symmetry breaking with paper 25 figure 15 ([25]: p48, fig15), the following is in play here as per figure 1:

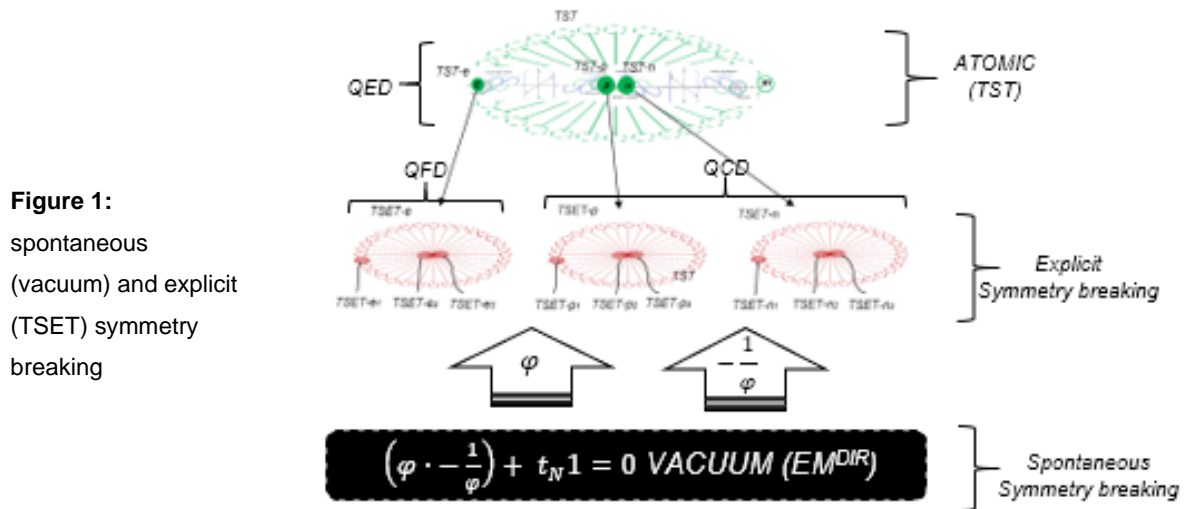

Figure 1:
spontaneous
(vacuum) and explicit
(TSET) symmetry
breaking

In short, the idea of symmetry breaking is encoded into the time-algorithm. The question is how a general pattern can form between the vacuum of space and these time-points in the context of EM (time-points) and Gravity (vacuum), as presented in paper 21 ([21]: p16-23) as per EM-A, EM-B, EM-A^{DIR}, and EM-B^{DIR}.

3. Time-space energy pattern formation

A manifold is commonly defined as a collection of points forming a certain kind of set, such as those of a topologically closed surface or an analogue of such in three or more dimensions. The general time-space manifold Temporal Calculus has formed was granted through the discourses of logic and associated time-space building process of papers 1 [1] through to paper 26 [26]. This is summarised in the following manner as an amalgamation of figure 6 from paper 24 ([24]: p24, fig6) and figure 15 from paper 25 ([25]: p48, fig15), here as figure 2:

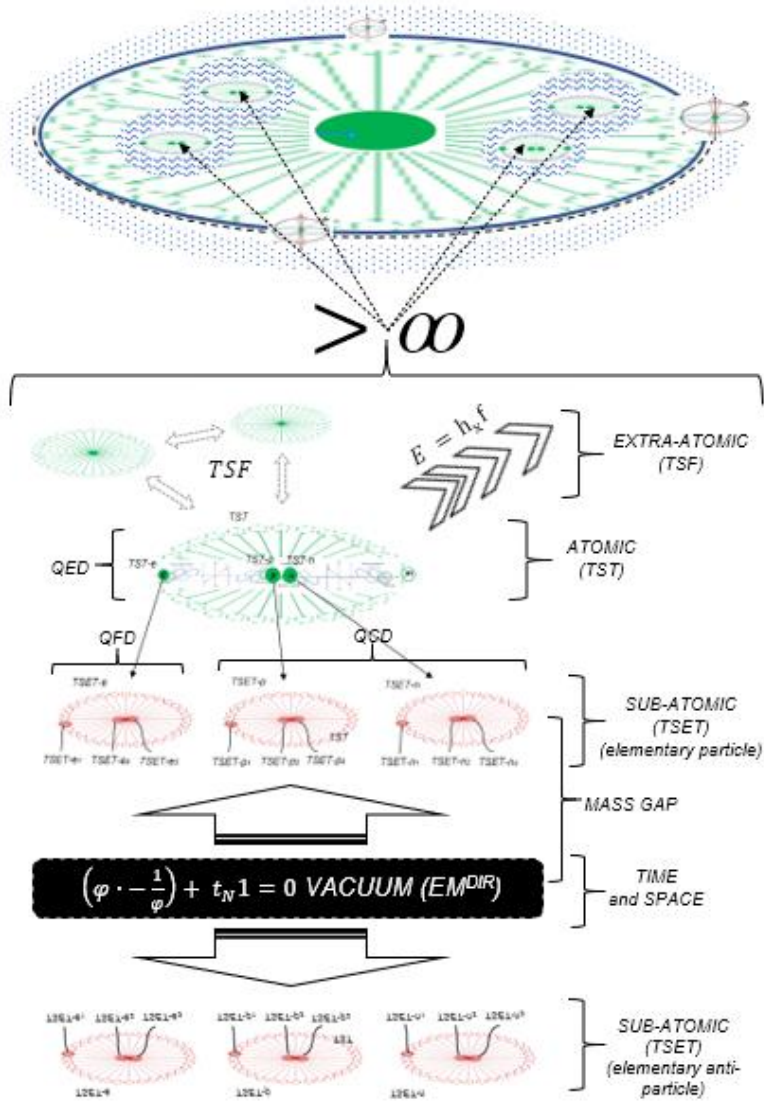

Figure 2: the TST level as a multitude of TST's in space ($>\infty$), as a play between the EM and G characteristics of each TST reference.

This entire structure (time-space manifold) represents an energy system with both entropic and enthalpic levels in the general time-space manifold.

In statistical mechanics, entropy is an *extensive* property (a value proportional to the size of the system being described) of a thermodynamic system quantifying *the number* of microscopic configurations (known as microstates) relevant to the *macroscopic entities* that characterize the system (such as its volume, pressure and temperature). The second law of thermodynamics states that the entropy of an isolated system never decreases over time, always evolving toward thermodynamic equilibrium, defined as a state of maximum entropy. As entropy is determined by the number of microstates, entropy is related to the amount of additional information needed to specify the exact physical state of a system, given its macroscopic specification, and thus with the greater number of microstates being defined in the one system context, the greater apparent randomness that entropy would prescribe as it increases with increasing microstates.

Enthalpy conversely is a property of a thermodynamic system defined as the sum of the system's internal energy and the product of its pressure and volume, or rather, the nature of the internal energies

within each particle reference keeping the particles together (and not split-dispersed in a greater microstate manner). Enthalpy thus is a measure of the overall pattern-order of the particle reference and associated system. Such is the same logic presented in paper 5 with figures 3 and 4 ([5]: p9-10, fig3-4) combined here as figure 3:

Figure 3: the entropic/enthalpic event that the general shape of figure 2 needs to account for.

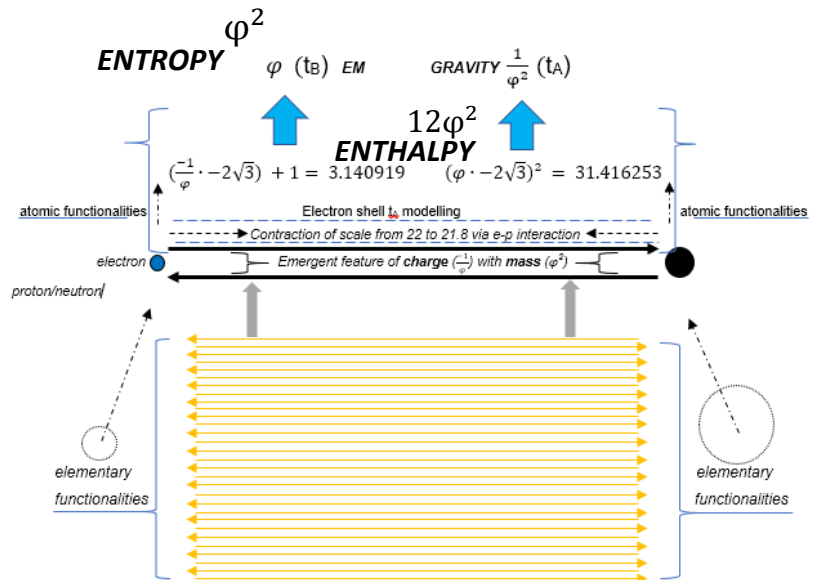

This steady state system was then transferred to the time-space 10-point scheme in accounting for the “12” factorial as the TSET level, as per paper 25 ([25]: p38):

3.5.2 Temporal Calculus Elementary Particle TSC context (TSEC)

Given what has been presented thus far in the previous sections of this paper, the “next-step” of theoretic development will be taken using the idea of the time-space context (TSC) in the time-space uncertainty (TSU) arena, a new level TSC in the “fractal” time-point aether system/field uncertainty manifold, the TSEC level. The reason to consider a new “subatomic” level is based on the “12” factorial initial presented in paper 5 ([5]: p9), as shall be now explained.

In short, the enthalpy manifold is defined as the *exclusive* time-point energy component of the particles, the entropy manifold being that of the particles’ *extensive* property in the greater time-space structure. *Breaking this pattern therefore*, this time-space energy manifold, *will require energy*, as per breaking the *exclusive* property, if indeed such an *exclusive* pattern is based on an enthalpic component that would need to be overcome in order to create a new pattern. Thus, any research/experiment that endeavours to tear these particles away from this structure will represent the underlying energies and associated particle masses that have these particles set/held in this pattern formation. And such supports the case of light being massless, namely because light according to Temporal Calculus is a time point phenomena as energy, ultimately connected with space mathematically as though fluid with the 3

dimensions of space, and therefore why particle physics research must rely on breaking the particles away from their pattern confinements requiring set sums of energy relevant to the situational qualities of those particles. One thing now needs to be made clear, namely particle formation and particle confinement.

4. Particle-mass formation as EM^{DIR} *barriers*

In paper 21 ([21]: p13-17), particle mass was proposed to form as an $EM-A^{DIR}$ construct. And this $EM-A^{DIR}$ construct was proposed to interact with space, space as an $EM-B^{DIR}$ construct, thereby providing for the effect of mass ($EM-A^{DIR}$) and gravity ($EM-B^{DIR}$), together explained as the EM^{DIR-X} field in paper 23 [23], and how that relates with a standard EM field, as follows ([23]: p30):

*According to the theory presented here nonetheless, the EM^{DIR} "X" field (say EM^{DIR-X}) is itself anchored to the general G-B field of space, to that vacuum. The G-B field of space is essentially the general spatial field that normal mass is influenced by as gravity, as presented in papers 21 ([21]: p16-23) and 22 ([22]: p13-17). So, the EM^{DIR-X} field is anchored to the general spatial background thus, like EM^{DIR-X} tyres on the G-B track, it grips. And therefore, when the EM^{DIR-X} field pushes against an EM field, that EM field is forced away into a 45° tilt orientation, yet because the EM^{DIR-X} field being generated is virtually insubstantial as a G-B field, as space, if the EM field in being pushed away is attached to a bulkhead also attached to the resonance chamber producing the EM^{DIR-X} field, then that resonance chamber attached to the bulkhead is allowed to move along with the bulkhead as though not being opposed by it, virtually resistance free, as technically the EM^{DIR-X} field is purely spatial in nature, and the EM field being pushed away has technically nothing to push back **upon** given the EM^{DIR-X} field is technically a spatial field.*

The obvious question to ask therefore is how does a wave-function just destructively interfere to become a particle? The answer is that it's exactly as it can only be, namely an $EM-A^{DIR}$ **on** an $EM-B^{DIR}$ creates an added focus *in space* that represents a type of *barrier*, an added spatial effect compared to a standard $EM-B^{DIR}$ (vacuum) field, and this *barrier* effect would manifest as mass, as such a barrier, as such an "enhanced" $EM-B^{DIR}$ field by the added effect of the $EM-A^{DIR}$, as per figure 4.

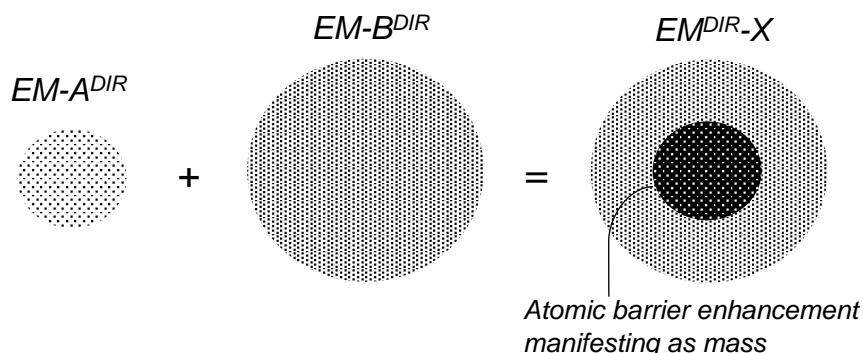

Figure 4: The idea of combining a standard atomic $EM-A^{DIR}$ field with the standard backdrop of an $EM-B^{DIR}$ (space) field presents with a natural “barrier” effect for the region circumscribed by the $EM-A^{DIR}$ field upon the $EM-B^{DIR}$ field.

Simply, the $EM-A^{DIR}$ field *in the atom* as the PQWF ([2]: p10-18)([4]: p4-9) produces the standard time-space template (TST), that overall atomic *barrier*, as though here the atom itself manifests as a mass, a particle, as an $EM-A^{DIR}$ upon the $EM-B^{DIR}$ of space. The question now then is how this works for the *subatomic* particles (“e”, “p”, and “n”) and their own constituent particles.

In therefore referring to the time-space-template (TST), yet more precisely, the subatomic particles of the TST, namely the proton, neutron, and electron, these particles as per paper 25, ([25]: p40-41), are in fact time-space *elementary templates*, TSET’s. These TSET’s were deemed necessary to accommodate for the entropy-enthalpy time-space system equation (12 factorial) as presented here in section 2. The problem on this level (as the “Yang Mills existence and mass gap” problem presents [26]) is that this TSET level is *sub-quantum*, below the dimensional level (wave-length, etc) of the phi-quantum wave-function, of EM. So how is a “particle” as mass made manifest for the TSETs? The answer can only be that the TSET constituent time points (TSET-e₁₋₃, TSET-p₁₋₃, and TSET-n₁₋₃) exist as pure time-points upon a field of time-points, an enhancement of time-point activity presenting as a particle, as a mass, and these constituent time-points *form* their relevant TSET which as a template/pattern represents also the concept of a barrier, as a mass/particle, that “confines” its constituent time-point particles/masses. Essentially therefore mass can only work using the fundamental elementary particle level (TSET) *with the TST*; anything else as a particle would be in a dynamic state of relative flux to the background TSF (time-space field).

5. Asymptotic Freedom, Kaons, and Baryon Asymmetry

In particle physics, *asymptotic freedom* [28] describes elementary particle *confinement*, namely a property that causes interactions between particles to become asymptotically weaker as the energy scale increases and the corresponding length scale decreases. In short, the further the elementary particles in their confined particle (TSET) try to move apart, the greater the force of resistance for them to

do such becomes, explained above, namely, “The answer can only be that the TSET constituent time points ($TSET-e_{1-3}$, $TSET-p_{1-3}$, and $TSET-n_{1-3}$) exist as pure time-points upon a field of time-points, an enhancement of time-point activity presenting as a particle, as a mass, and these constituent time-points form their relevant TSET which as a template/pattern represents also the concept of a barrier, as a mass/particle, that “confines” its constituent time-point particles/masses.”

The idea of the Kaon in particle physics is similarly explained. Kaons represent elementary particle pairings, namely the bound state of a strange quark (or antiquark) and an up or down antiquark (or quark). Of course to study Kaons is to break down the TSET and uncover the constituent elementary particles, and here the TSET template defines a type of confinement between the $TSET-e_2$ and $TSET-e_3$, $TSET-p_2$ and $TSET-p_3$, and $TSET-n_2$ and $TSET-n_3$ particles, as presented in figure 5.

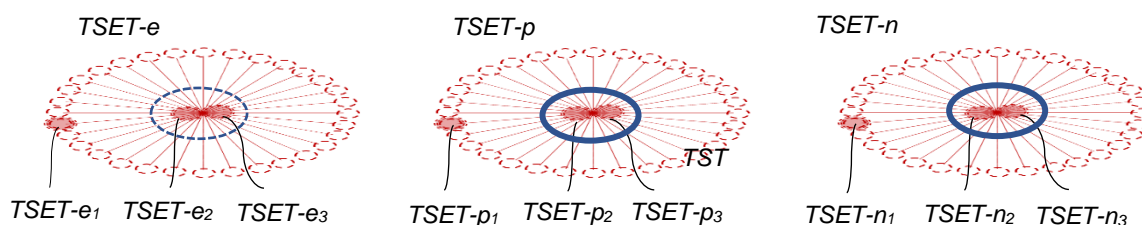
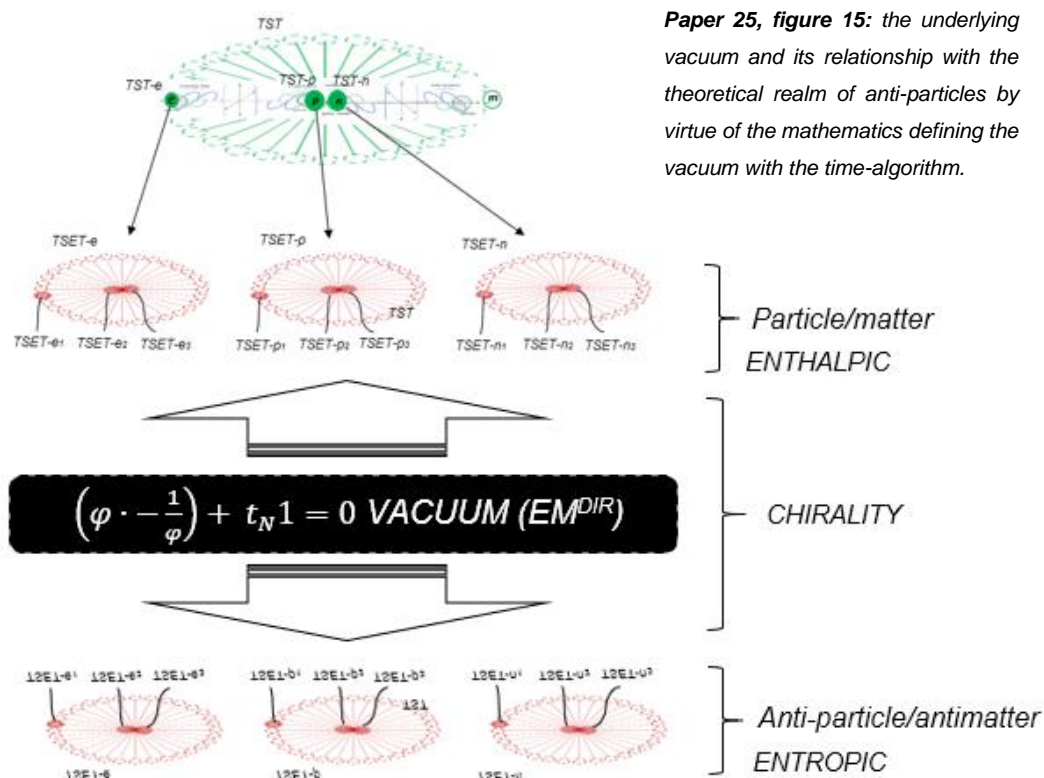

Figure 5: standard Kaon pairings (solid blue rings), and the weaker Kaon pairing of the $TSET-e_2$ and $TSET-e_3$ particles (broken blue ring).

Primarily, given the electron itself is not a part of a TST particle pairing as the proton and neutron are, Kaons would be considered to represent the pairings of the $TSET-p_2$ and $TSET-p_3$, and $TSET-n_2$ and $TSET-n_3$ particles, and therefore four in all.

One of the greatest mysteries in physics is the matter-antimatter asymmetry problem, the observed asymmetry between Baryonic matter (observed matter) and antibaryonic matter. The explanation for antimatter was provided in paper 25 ([25]: p48) as follows,:

In knowing nonetheless that the two outcomes of the golden-ratio time-algorithm as one represent a value of -1, as a negative unit value, this value in theory in relationship with the fundamental t_N1 process would represent a confounding issue for the particles manifesting on the TSET level, a type of “anti”- t_N1 concept (and therefore anti-particle potentiality), as per $(\varphi \cdot -\frac{1}{\varphi}) + t_N1 = 0$, having the effect of eliminating (it would seem) a full expression of each particle, putting each elementary particle in a state of compromise in regard to the anti-particle mathematical nature of the vacuum central to a particle’s symmetry-breaking manifestation from the vacuum, yet not just manifestation, yet “percentage relationship” to their TSET particle neighbours (1-3). Consider figure 15.



Paper 25, figure 15: the underlying vacuum and its relationship with the theoretical realm of anti-particles by virtue of the mathematics defining the vacuum with the time-algorithm.

Note here why particles (matter) would dominate over anti-particles (antimatter), given the elementary particle level is fundamentally enthalpic (energy conservation) whereas the anti-particle realm would be entropic, purely, and therefore be exhausted almost instantaneously. This anti-particle potential realm would nonetheless represent an entirely theoretical confounding limit for mass in breaching the vacuum, and provide space with a type of repulsive effect against particle mass as it does with light as calculated in paper 23 ([23]: p24-31), together with giving space a type of “negative energy” feature in regard to mass, as proposed initially in paper 7 ([7]: p2-3), as follows

In short, as with particle formation, there is anti-particle formation according to the basic need for the time-space manifold to abide by the energy requirements in space and associated temporal accountability of time-points, whereby anti-particle formation in being entropic quite simply “doesn’t last very long” compared to the enthalpic manifestation of normal baryonic matter and their constituent particles.

6. Atomic Barrier Enhancement (ABE)

One overlooked feature is how an EM^{DIR} field interacts with the TST (and not necessarily the TSET, as explained already). The proposal is that **if** the EM^{DIR} field interacts with the TSET as presented

in figure 15 paper 25 ([25]: p48, fig 15), then so too an EM^{DIR} field would have a similar *enthalpic* effect on the TST level, if an EM^{DIR} field were forced upon the TST, as what can only be described as a type of “*atomic barrier enhancement*”. This would primarily have the effect, in theory, of subatomic particle “building”, namely an increase in the number of “e”, “n”, and “p” particles, and thus a type of “mass” (barrier) enhancement of the TST, proposed here as a phenomenon termed “*atomic barrier enhancement*”. Consider figure 6:

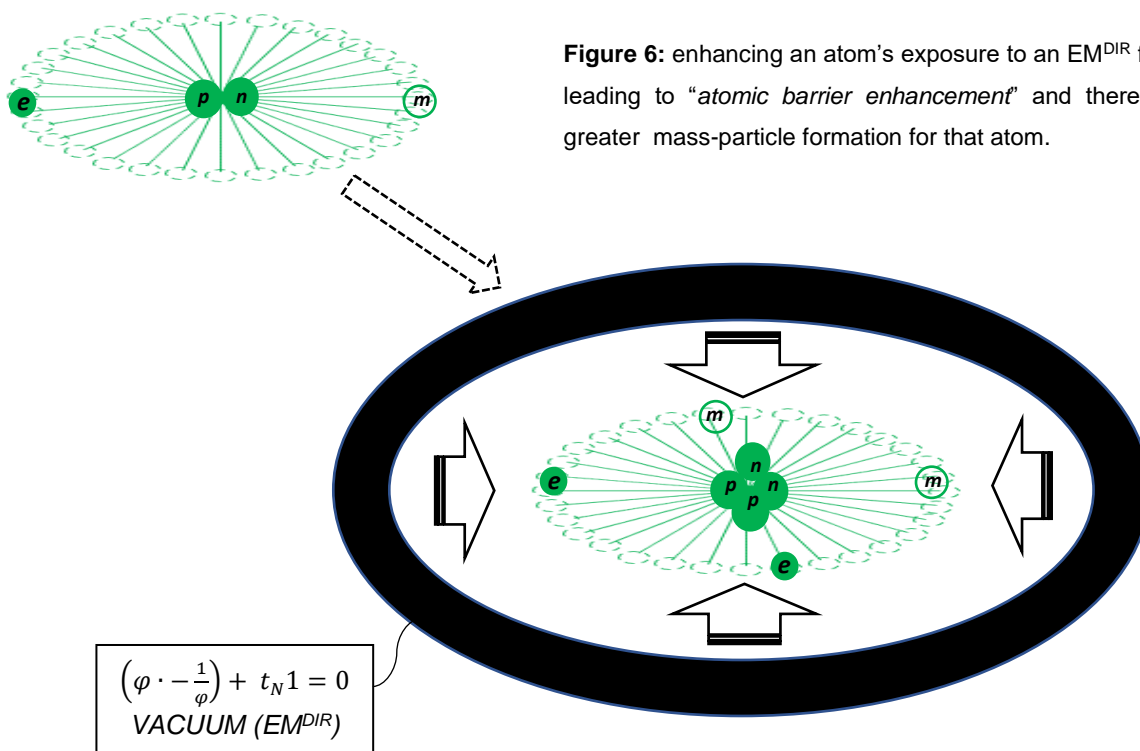

In figure 6, a TST is exposed to an EM^{DIR} enhancement, producing an upscale of subatomic time-points and therefore particles. Such is how atoms would be naturally modelled under the influence of extreme gravity conditions (given gravity is a process of EM-A^{DIR} and EM-B^{DIR} ([21]: p13-17), built by this process and limited by the value presented in paper 1 as per the Rydberg equations and constant ([1]: p12-15)([2]: p12-17) whereby the maximum electron shell number is set as per paper 2 page 17 ([2]: p17):

Basically, there would be on this electron shell emergent level only a maximum of “32” full orientations for each electron shell level if indeed the proton and neutron must remain fixed as mass entities undertaking a strong-force of association ([1]: p12). The Rydberg Formula presents that the following series of electrons in shells is allowable: 2, 8, 18, 32, 50, 72 [19]. Here though we are stating that it is not possible for an energy shell to go beyond 32 electrons. And this is indeed correct with the Periodic Table [21] where the elements are unable to reach the “50” occupancy level for an energy shell. It seems therefore we have capped the development of an atom (confirmed with what is found in nature) by the application of the golden ratio as an algorithm for time.

The proposal here is that given greater enhancement with a greater EM^{DIR} field strength then greater atomic barrier enhancement (an enthalpic process) can be brought in effect. This idea would have useful applications if it were possible to generate an EM^{DIR} field and expose it to an atom for the purpose of atomic particle building (*atomic barrier enhancement*), yet further to this, “molecular” *reconstruction* in the manner of altering how different atoms would share their electron shells in the form of covalent bonds and how exposure to an EM^{DIR} field would effectively aim to bring the molecular atomic constituents into not just a higher enthalpic state yet into a type of molecular break-down with the aim of primary atomic barrier enhancement. The thinking here therefore is that it would be possible to utilise this process to manufacture certain compounds for fuel, namely the development of compounds in a higher enthalpic state than previously exposed to an EM^{DIR} field, such as for instance in a most basic sense exposing water to an EM^{DIR} field (as an enthalpic process) to produce the higher enthalpic state of hydrogen (H₂) and oxygen (O₂) gas, as per equation 1:



For instance, as presented in figure 7, an EM^{DIR} Hydrogen Generator would comprise of a resonance chamber (1.) that would contain the EM^{DIR} field, an internal aerial (2.) providing for the signature destructive interference resonance (the EM^{DIR} field) from a RF source (3.), and an EM permeable internal water chamber that would be EM permeable (4.) which would have connected to it a feed-in water pipe (5.) to supply the chamber with water, and a feed-out gas pipe (6.) to extract the formed gases (Hydrogen and Oxygen). The resonance chamber (1.) would typically be an EM impervious cylinder (such as aluminium) designed such that the length and width of the chamber would represent any factor of the input RF wavelength of the incoming RF field plus ½ the RF wavelength (out of phase), the point being to effect maximum destructive interference resonance (EM^{DIR}). The water chamber (1.) and associated feed-in (5.) and feed-out (6.) pipes could be attached to any part of the chamber (1.) provided that they do not interfere with the integrity of the EM^{DIR} chamber in its ability to resonate a pure EM^{DIR} field.

Figure 7: (1.) the resonance chamber, (2.) the aerial within the chamber connected to the external RF power supply, (3.) the power source, ideally RF field, to feed into the chamber aerial, (4.) the water chamber, (5.) the feed-in water supply pipe, (6.) the feed-out gas (hydrogen and oxygen) supply pipe.

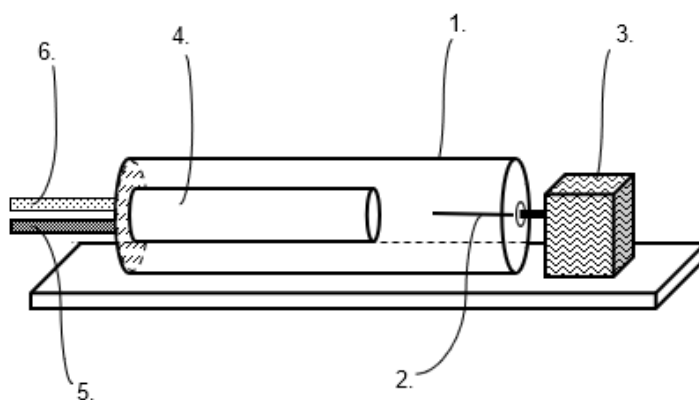

7. Conclusion

Here is presented the Temporal Calculus time-space manifold theory accounting for both energy and mass in a data compliant and driven manner on supra-atomic, atomic, and sub-atomic/elementary mass/particle levels, encompassing both Quantum Mechanics (and QFT) and the Standard Model of particle physics, proof of which is proposed in the previous two papers [25-26] for the “Yang Mills existence and mass gap” problem, here as a description of particle formation and confinement, accounting for particle-phenomena symmetry breaking, asymptotic freedom, confinement (including that of Kaons), and Baryon asymmetry. The proposal for the new theoretic device of “*Atomic Barrier Enhancement*” was derived in the context of all the previous methodology for Temporal Calculus, pointing to Hydrogen fuel production mechanisms in the absence of carbon utility and emissions.

Conflicts of Interest

The author declares no conflicts of interest; this has been an entirely self-funded independent project.

References

1. Jarvis S. H. (2017), Gravity's Emergence from Electrodynamics, DOI: [10.13140/RG.2.2.35132.28804](https://doi.org/10.13140/RG.2.2.35132.28804), <http://vixra.org/abs/1704.0169?ref=9367626>
2. Jarvis S. H. (2017), Golden Ratio Axioms of Time and Space, DOI: [10.13140/RG.2.2.30099.12327](https://doi.org/10.13140/RG.2.2.30099.12327), <http://vixra.org/abs/1706.0488>
3. Jarvis S. H. (2017), The Emergence of Consciousness from Chaos, DOI: [10.13140/RG.2.2.23388.23683](https://doi.org/10.13140/RG.2.2.23388.23683), <http://vixra.org/abs/1707.0044>
4. Jarvis S. H. (2017), Phi-Quantum Wave-Function Crystal Dynamics, DOI: [10.13140/RG.2.2.10045.10726/1](https://doi.org/10.13140/RG.2.2.10045.10726/1), <http://vixra.org/abs/1707.0352>
5. Jarvis S. H. (2017), Time as Energy, DOI: [10.13140/RG.2.2.23466.88009/3](https://doi.org/10.13140/RG.2.2.23466.88009/3), <http://vixra.org/abs/1711.0419>
6. Jarvis S. H. (2018), The Relativity of Time, DOI: [10.13140/RG.2.2.13400.55044/3](https://doi.org/10.13140/RG.2.2.13400.55044/3), <http://vixra.org/abs/1801.0083>
7. Jarvis S. H. (2019), Golden Ratio Entropic Gravity: Gravitational Singularity Field Testing, DOI: [10.13140/RG.2.2.35399.14246/1](https://doi.org/10.13140/RG.2.2.35399.14246/1), <http://vixra.org/abs/1904.0485>
8. Jarvis S. H. (2019), The Golden Ratio Time Algorithm, DOI: [10.13140/RG.2.2.35399.14246/1](https://doi.org/10.13140/RG.2.2.35399.14246/1), <http://vixra.org/abs/1905.0081>
9. Jarvis S. H. (2019), The Physics Chimera, DOI: [10.13140/RG.2.2.28499.02084/1](https://doi.org/10.13140/RG.2.2.28499.02084/1), <http://vixra.org/abs/1906.0127>
10. Jarvis S. H. (2019), The Conception of Time, DOI: [10.13140/RG.2.2.10258.71363/1](https://doi.org/10.13140/RG.2.2.10258.71363/1), <http://vixra.org/abs/1906.0441>
11. Jarvis S. H. (2019), Space, and the propagation of Light, DOI: [10.13140/RG.2.2.15833.67689/1](https://doi.org/10.13140/RG.2.2.15833.67689/1), <http://vixra.org/abs/1908.0388>

12. Jarvis S. H. (2019), Space, and the Nature of Gravity, DOI: [10.13140/RG.2.2.17320.93443](https://doi.org/10.13140/RG.2.2.17320.93443),
<http://vixra.org/abs/1909.0656>
13. Jarvis S. H. (2019), Space, and the Redshift Effect, DOI: [10.13140/RG.2.2.14287.43683](https://doi.org/10.13140/RG.2.2.14287.43683), <http://vixra.org/abs/1911.0064>
14. Jarvis S. H. (2019), Solving The Cosmological Constant Problem, DOI: [10.13140/RG.2.2.25730.63686/1](https://doi.org/10.13140/RG.2.2.25730.63686/1),
<http://vixra.org/abs/1912.0451>
15. Jarvis S. H. (2020), Hybrid Time Theory: "Euler's Formula" and the "Phi-Algorithm", DOI:
[10.13140/RG.2.2.13078.91205/2](https://doi.org/10.13140/RG.2.2.13078.91205/2), <http://vixra.org/abs/2001.0233>
16. Jarvis S. H. (2020), The Hybrid Time Clock as a Function of Gravity, DOI: [10.13140/RG.2.2.27053.64487/1](https://doi.org/10.13140/RG.2.2.27053.64487/1),
<http://vixra.org/abs/2001.0401>
17. Jarvis S. H. (2020), Hybrid Time Theory: Cosmology and Quantum Gravity (I), DOI: [10.13140/RG.2.2.20045.79847/1](https://doi.org/10.13140/RG.2.2.20045.79847/1),
<http://vixra.org/abs/2003.0659>
18. Jarvis S. H. (2020), Scientific Principles of Space, Time, and Perception, DOI: [10.13140/RG.2.2.16207.84648/1](https://doi.org/10.13140/RG.2.2.16207.84648/1),
<http://vixra.org/abs/2004.0260>
19. Jarvis S. H. (2020), Hybrid Time Theory: Cosmology and Quantum Gravity (II), DOI: [10.13140/RG.2.2.23972.22405](https://doi.org/10.13140/RG.2.2.23972.22405),
<http://vixra.org/abs/2005.0053>
20. Jarvis S. H. (2020), Mathematical Principles of Time and Energy, DOI: [10.13140/RG.2.2.34441.67683/2](https://doi.org/10.13140/RG.2.2.34441.67683/2),
<http://vixra.org/abs/2005.0179>
21. Jarvis S. H. (2020), Dimensional Mechanics of Time and Space, DOI: [10.13140/RG.2.2.21001.88169/1](https://doi.org/10.13140/RG.2.2.21001.88169/1),
<http://vixra.org/abs/2005.0286>
22. Jarvis S. H. (2020), Dimensional Thermodynamics, DOI [10.13140/RG.2.2.29715.71202/1](https://doi.org/10.13140/RG.2.2.29715.71202/1),
<http://vixra.org/abs/2006.0194>
23. Jarvis S. H. (2020), Time-Space Wave-Mechanics, DOI [10.13140/RG.2.2.10565.68320/2](https://doi.org/10.13140/RG.2.2.10565.68320/2),
<http://vixra.org/abs/2007.0223>
24. Jarvis S. H. (2020), Temporal Calculus (The Calculus of Time-points in Space), DOI: [10.13140/RG.2.2.15362.09929/3](https://doi.org/10.13140/RG.2.2.15362.09929/3),
<http://vixra.org/abs/2008.0111>
25. Jarvis S. H. (2020), Temporal Calculus: solving the "Yang-Mills Existence and Mass Gap" problem.,
DOI: [10.13140/RG.2.2.33774.43843/2](https://doi.org/10.13140/RG.2.2.33774.43843/2), <http://vixra.org/abs/2008.0226?ref=11562969>
26. Jarvis S. H. (2020), Temporal Calculus: Time Scaling Space, DOI: [10.13140/RG.2.2.28539.75043/2](https://doi.org/10.13140/RG.2.2.28539.75043/2),
<https://vixra.org/abs/2009.0091>
27. Anderson, P.W. (1972). "More is Different" (PDF). *Science*. **177** (4047): 393-396. [Bibcode:1972Sci...177..393A](https://doi.org/10.1126/science.177.4047.393). [doi:10.1126/science.177.4047.393](https://doi.org/10.1126/science.177.4047.393). PMID 17796623
28. Gerard 't Hooft, "When was Asymptotic Freedom discovered? or The Rehabilitation of Quantum Field Theory", *Nucl. Phys. Proc. Suppl.* **74**:413–425, 1999, [arXiv:hep-th/9808154](https://arxiv.org/abs/hep-th/9808154)