

Fundamentals of a Theory of Aether – Part 1

(submitted: July the 26th, 2020; last updated: August the 3rd, 2020)

Ionel DINU, B.Sc. Physics, M.Sc. Physics, Teacher of Physics QTS
Lori GARDI, Senior Software Developer, Western University

Abstract

The necessity of acknowledging the existence of a new chemical element is discussed. A new view of the electric current as a diffusion wave in a wire is advanced. The production of a magnetic field by an electric current is explained in terms of mechanics of surface waves.

Keywords: aether, aether acoustic wave, electrigen, diffusion wave, electric charge, electric current, magnetic field

Introduction

This work is an improvement upon the ideas advanced in the previous work titled Rudiments of a Theory of Aether (2007). Its aim is to continue with the ambitious plan of giving a mechanical description of the phenomena of electricity, magnetism, gravitation and light. While the previous work still used the concept of electron and electric charge, this is not the case now. Scrapping the concept of electric charge naturally leads to reconsidering the nature of the electric current and of the mechanism through which a magnetic field is produced by it. It will be seen that the new view advanced here is fully consistent with the phenomena observed in electromagnetism.

A mechanical explanation of electromagnetic phenomena is very much desired and has been the ultimate goal of the founding physicists of this science in the 19th century. Mechanics operates with the most fundamental concepts in physics and therefore is most fitted in explaining physical phenomena. The basic tenet of a mechanical theory is that the actions produced by matter are due to what matter *does*, not to what matter *is*. In explaining the nature of gravitation, and its power to act at a distance through vacuum, the concept of mass having an intrinsic power to attract another mass at a distance has been denied, as did Isaac Newton many times in his writings (see The Origin of Gravitation).

A similar procedure will be used now. Electrostatic actions are not due to entities called electric charges, positive and negative. Electrostatic attractions and repulsions are the result of molecular vibrations transmitted through the aether and the artificial concept of electric charge is here replaced with that of *energy charge*. The concept of electric charge has been very helpful in systemizing the phenomena of electricity, but this does not mean that electric charge and electric force must be elevated to the status of irreducible, fundamental, concepts in physics. They are so now because no mechanical explanation has been found so far.

The Electrigen

Ever since electrical phenomena have been observed and recorded, two distinct processes have been identified: that bodies act at a distance on one another, and that something in their constitution has changed, that they are in a new condition. Confusing these two has prevented researchers from finding a mechanical explanation of electrostatic phenomena.

On the one hand, Benjamin Franklin clearly noticed that something is being transferred from one body to another during friction, induction, or when connected to an electrical machine. This change in constitution was related by him to the existence of an *electric fluid* that has been lost by one and gained by another.

On the other hand, objects that gained or lost electric fluid act at a distance on one another through attractions and repulsions. These interactions cannot be transmitted other than by vibrations in the intervening aether because they are observed even in vacuum and because the aether is a compressible inviscid liquid that can propagate interactions exclusively through longitudinal waves. If we are to find a mechanical explanation of these interactions, the only way is to think of them as being produced by what matter *does*, not by what matter *is*, and so it is necessary to avoid introducing artificial concepts such as positive or negative matter. This further leads to the conclusion that electrostatic attractions and repulsions are due to matter set in a motion of vibration. In other words, that matter is *charged with energy*, not with “electricity”.

Thus, Benjamin Franklin’s electric fluid does not have to be a substance “charged with electricity”, it is sufficient to acknowledge its existence and to explain the electrostatic forces to which it gives rise by its vibration, that is, by its *energy charge*. In this work, this fluid is called *electrigen*.

The electrigen can be thought of as a chemical element. Following the naming scheme used in chemistry, the element name stems from electri- (electrical phenomena) and -gen (gene - producing). Needless to add that it is a neutral substance, just as any other chemical element. And its name is not to be understood as implying that it is the only element producing electrostatic attractions and repulsions through its vibration. The other elements are equally potent when set in vibration but it is due to the electrigen having revealed the existence of electrostatic phenomena that such a name was assigned to it.

In acknowledging the existence of electrigen as a new chemical element, we find support from the most unexpected quarters, even from chemistry itself. Thus, no other than Dmitri Mendeleev, the founder of the Periodic Table of Chemical Elements, foretold the existence of elements x and y in Group 0. Look at Figures 1 and 2 of his table. In the present work, element x is identified as the aether, and the element y as the electrigen.

Series	Zero Group	Group I	Group II
0	x		
1	y	Hydrogen H=1.008	
2	Helium He=4.0	Lithium Li=7.03	Beryllium Be=9.1
3	Neon Ne=19.9	Sodium Na=23.01	Mg

Figure 1

Series	Zero Group	Group I	Group II	Group III	Group IV	Group V	Group VI	Group VII	Group VIII			
0	x											
1		Hydrogen H=1.008										
2	Helium He=4.0	Lithium Li=7.03	Beryllium Be=9.1	Boron B=11.0	Carbon C=12.0	Nitrogen N=14.04	Oxygen O=16.00	Fluorine F=19.0				
3	Neon Ne=19.9	Sodium Na=23.05	Magnesium Mg=24.1	Aluminium Al=27.0	Silicon Si=28.4	Phosphorus P=31.0	Sulphur S=32.06	Chlorine Cl=35.46				
4	Argon Ar=38	Potassium K=39.1	Calcium Ca=40.1	Scandium Sc=44.1	Titanium Ti=48.1	Vanadium V=51.4	Chromium Cr=52.1	Manganese Mn=55.0	Iron Fe=56.9	Cobalt Co=59	Nickel Ni=59	(Cu)
5		Copper Cu=63.6	Zinc Zn=65.4	Gallium Ga=70.0	Germanium Ge=72.3	Arsenic As=75.0	Selenium Se=79	Bromine Br=79.95				
6	Krypton Kr=81.8	Rubidium Rb=86.4	Strontium Sr=87.8	Yttrium Y=89.0	Zirconium Zr=90.6	Niobium Nb=94.0	Molybdenum Mo=96.0		Ruthenium Ru=101.7	Rhodium Rh=103.0	Palladium Pd=106.5	(Ag)
7		Silver Ag=107.9	Cadmium Cd=112.4	Indium In=114.0	Tin Sn=119.0	Antimony Sb=120.0	Tellurium Te=127	Iodine I=127				
8	Xenon Xe=128	Cesium Cs=132.9	Barium Ba=137.4	Lanthanum La=139	Cerium Ce=140							
9												
10				Ytterbium Yb=173		Tantalum Ta=183	Tungsten W=184		Cesium Cs=132.9	Iridium Ir=193	Platinum Pt=194.9	(Au)
11		Gold Au=197.2	Mercury Hg=200.0	Thallium Tl=204.1	Lead Pb=206.9	Bismuth Bi=208						
12			Radium Rd=224		Thorium Th=232		Uranium U=238					

Figure 2

Further support for the existence of electrigen comes from the phenomena observed in vacuum tubes. William Crookes called it *the fourth state of matter*, other researchers *cathode rays*. O.W. Richardson observed that electrigen can be evaporated from substances heated in vacuum, and that in such a state of vibration the electrigen behaves as a “negatively charged substance”. In a mechanical explanation of electrostatic phenomena what this means is that the vibrating electrigen repels itself and attracts other chemical elements.

Due to its lightness, the electrigen is easily set in vibration and its oscillations can be conceived as transferring to the aether small amplitude, high frequency waves. Other elements, being heavier, would impart to the aether waves of larger amplitudes and lower frequencies. As a result, elements placed in such *aether acoustic fields* will be attracted or repelled according to their natural vibration frequencies.

Heat and electricity in voltaic cells

Heat is known to rise from the vibration of substances. That there is a connection between heat and electricity has been proven by thermoelectric phenomena. Pairs of different metal wires, having their ends joined and maintained at different temperatures, produce an electric current. This is a first hint that electricity is also due to the vibration of substances.

But a stronger support for this idea comes from the chemical reactions occurring in voltaic cells. It is experimentally shown that the heat evolved when chemical reactions occur in a voltaic cell is diminished when the cell does electrical work. Thus:

$$\text{Heat of reaction} = \text{electrical work} + \text{heat evolved}$$

In some voltaic cells the whole electrical work done equals the total heat of reaction. So chemical reactions occurring in some voltaic cells can produce either electrical energy or heat, depending on the circumstances. In some voltaic cells the electrical work is less than the heat of reaction and the cell heats up when working, while in some voltaic cells the electrical work is greater than the heat of reaction and the cell cools when working, absorbing heat from the surroundings.

Even the EMF of a voltaic cell can be calculated from the heats involved in the chemical reactions occurring in the cell. Since EMF is a measure of the electrification of the electrodes, this leads to the important conclusion that electrification is a form of molecular vibration, just like heat energy. Practically, at the molecular level, heat and electrical energy are indistinguishable from one another.

As it is known, at the cathode of a voltaic cell a metal (Zn) reacts with the electrolyte (dilute sulfuric acid) and dissolves, and this invariably leads to the charging of the metal with “negative electricity”. In a mechanical view, upon dissolving and thus leaving the solid metal lattice, the Zn atoms leave behind electrigen in an excited state. The accumulation of vibrating electrigen on the Zn electrode gives rise what is called “negative electricity” (Figure 3).

At the anode hydrogen is deposited upon another metallic electrode (Cu), charging it with “positive electricity”. In a mechanical view, the hydrogen atoms diminish the quantity of electrigen in the metallic electrode, and the solid metal lattice, whose vibrations have been dampened by the electrigen that covered it, is now able to transmit its vibrations to the aether, giving rise to “positive electricity” (Figure 3).

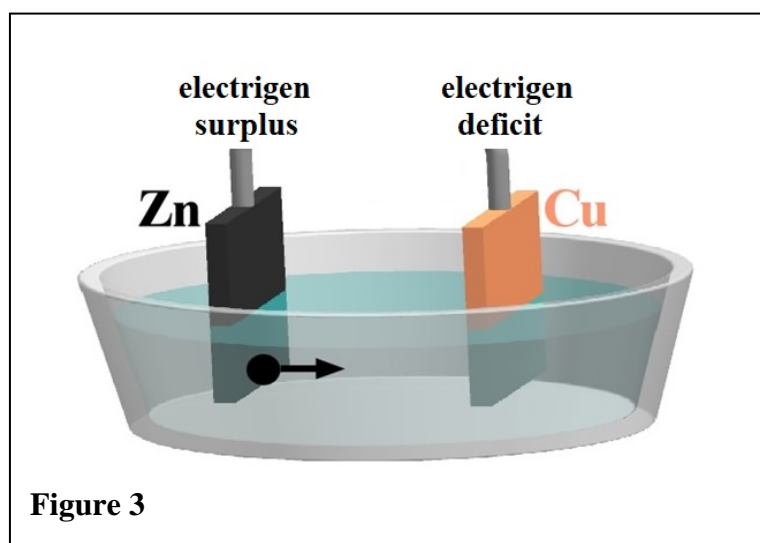
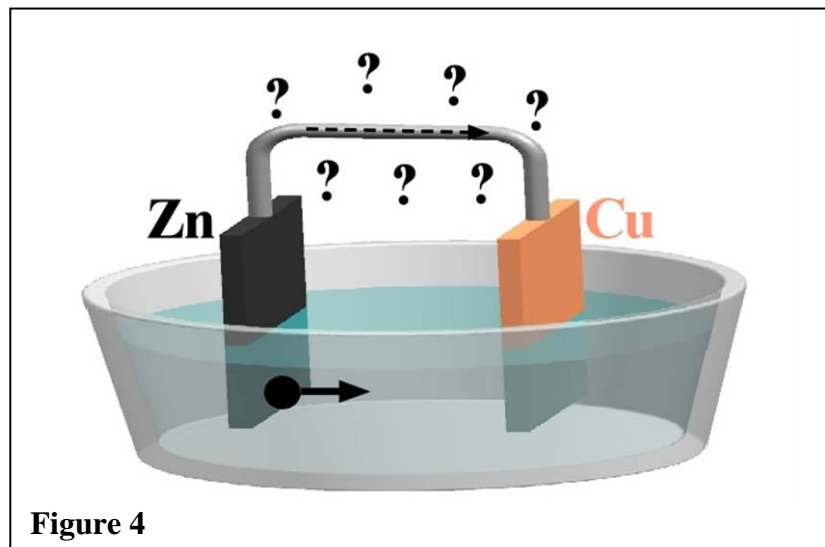

Figure 3

The electric current and its magnetic effect

From all the effects of the electric current, its magnetic effect is the most difficult to explain due to the fact that it is observed as *magnetism*, and because it occurs *in the space surrounding the wire*, even when the wire is in vacuum (Figure 4).



The extreme difficulty in understanding what is going on in this phenomenon and explaining it in a rational manner is due not only to the fact that the nature of magnetism is still unknown to us, but also to the fact that what constitutes an electric current has been a subject of much debate in the past and also because the nature of the vacuum itself is not agreed upon by most of the investigators of this field. We have here three poorly defined concepts that must be related to one another in a logical manner.

In *Rudiments of a Theory of Aether* (2007), the theory of metallic conduction accepted today was used when it was supposed that the electric current in a wire is produced by electrons moving in it. In an attempt to give a mechanical explanation for the production of a magnetic field in the space around the wire, the moving electrons were further supposed to produce wakes in the aether surrounding the wire. This system of aether wakes was then identified with the magnetic field experimentally observed around a current-carrying wire (Figure 5).

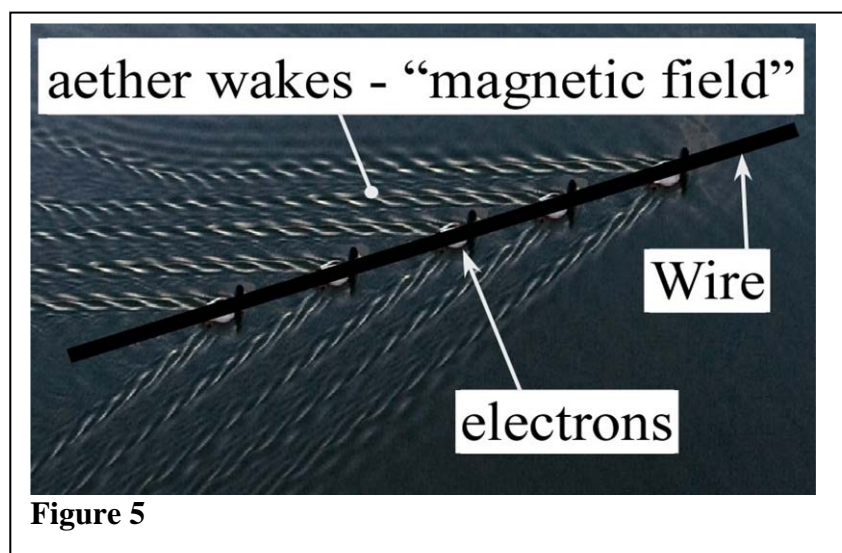

In the present work the concept of electron and of electric charge have been replaced by that of electrigen and its vibration, therefore the nature of the electric current and the structure of the magnetic field to which it gives rise will be reconsidered.

Following from what has been discussed in the previous section on voltaic cells, it is to be expected that once the Zn and the Cu electrodes are connected with a conducting wire, the surplus of vibrating electrigen on the Zn electrode will diffuse through the wire towards the Cu electrode. The electric current that results is thus a vibratory motion of electrigen transmitted along the wire from the Zn to the Cu electrode accompanied by the diffusion of electrigen in the same direction. Consequently, it can be stated that :

The electric current is a diffusion wave of electrigen (Figure 6).

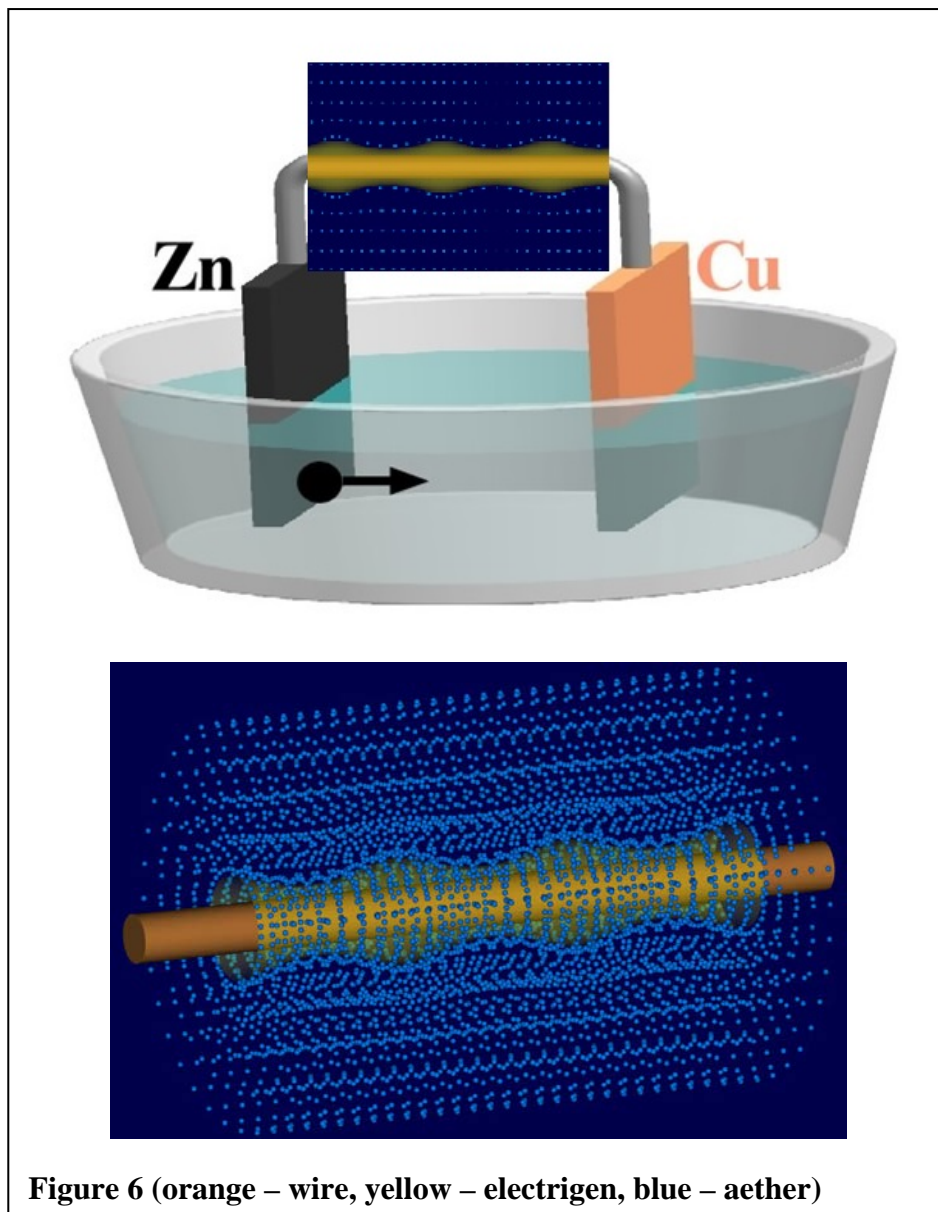

Figure 6 (orange – wire, yellow – electrigen, blue – aether)

In travelling along the wire, the electrigen diffusion wave acts mechanically on the surrounding aether, with which is in direct contact and has a common interface. In order to understand this action, look at the air moving above the water surface and

setting it in undulatory wave motion (Figure 7). The orbits described by the water particles decrease with the distance from the surface, i.e. from the interface between air and water. This picture is helpful because in what follows the water corresponds to the aether, while the air corresponds to the electrigen diffusion wave.

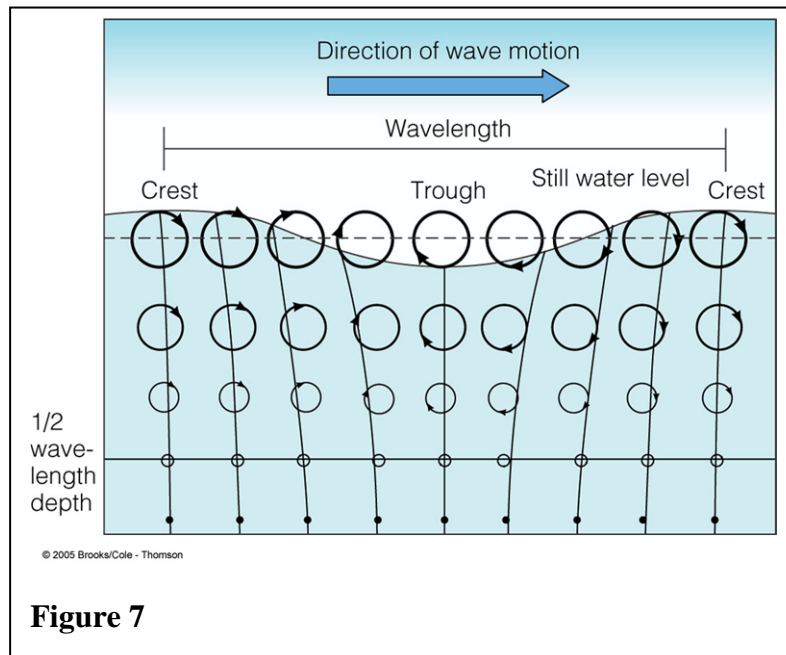

Figure 7

In the case of a wire, the diffusion of vibrating electrigen causes the aether in contact with it to oscillate like a water surface wave. The aether particles move in circular paths, with the radius of each orbit decreasing with the distance from the surface. The magnetic field of a current-carrying wire is thus composed of aether in circular motion (Figure 8).

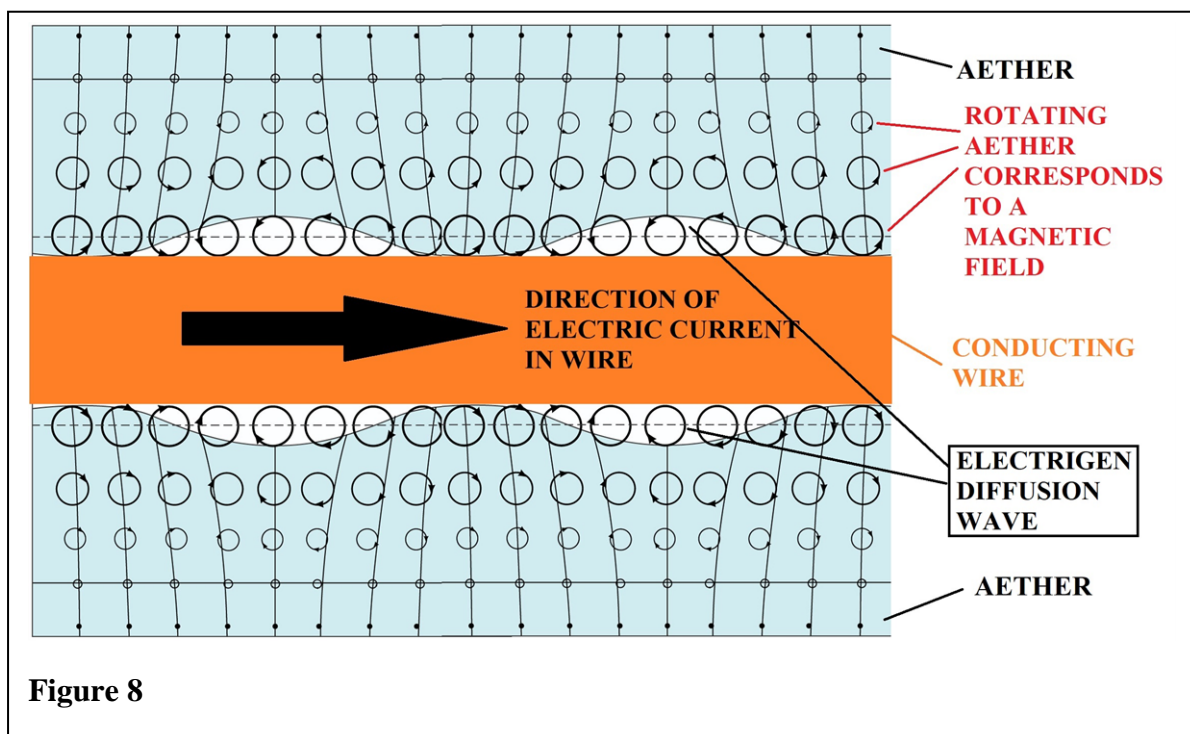

Figure 8

In a plane perpendicular to the wire, the aether moving in circular orbits at the same distance from the wire forms a ring enclosing the wire (any blue circle in Figure 9). From the circular motion of the aether in all these orbits, it can be seen that this ring is in fact a vortex ring of aether centered on the wire. When all these vortex rings in one plane are considered, it is observed that a system of vortex rings of increasing diameters surrounds the wire in a plane perpendicular to the wire. The greater their diameter, the thinner the vortex rings are, i.e. the smaller the radius of the circular orbit becomes. In such smaller orbits, the aether moves proportionally slower.

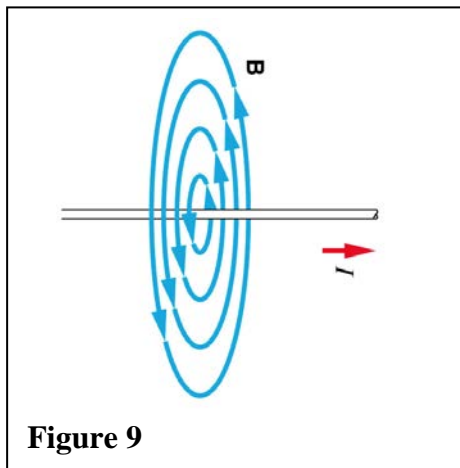

Figure 9

All these are consistent with the experimental observation that a current-carrying wire is surrounded by concentric magnetic lines of force, each circular line being the core of the vortex ring of aether (Figure 9). In other words, the aether is in circular motion around each line of magnetic force. The decrease of the strength of the magnetic field with the distance from the wire is accounted for by the slower rotation of the aether at greater distances from the wire.

Finally, it is to be noted that the explanation presented here is fully consistent with James Clerk Maxwell's description of these processes given in his work *On Physical Lines of Force*

(1861), with the observation that Maxwell did not provide a mechanical explanation

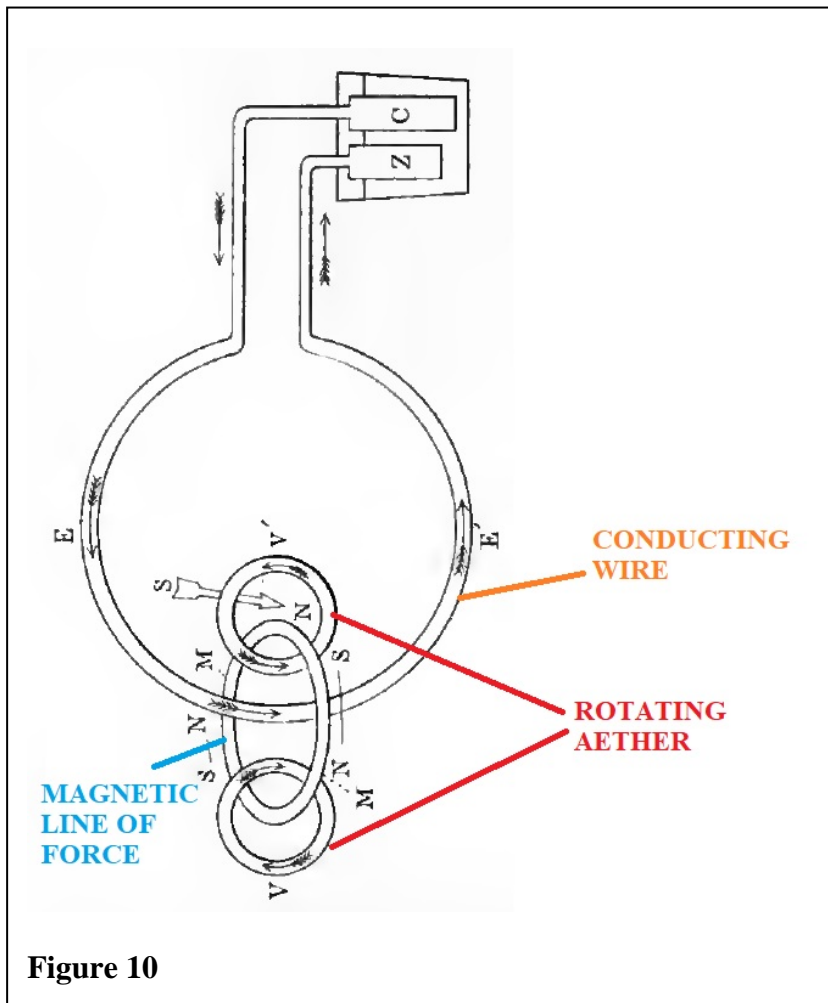

Figure 10

for his theory (Figure 10, labels added). The direction of the electric current is immaterial as long as the relative directions of the resulting magnetic field are consistent.

Conclusions

The present work showed how a mechanical picture of the electrostatic phenomena can be constructed by using the new concept of electrigen as a Group 0, Period I chemical element of the Periodic Table of Elements. In this scheme, the aether is a chemical element that occupies Group 0, Period 0 cell of the same table, consistent with Dmitri Mendeleev's conception of elements x and y (proposed chemical symbols for the elements are [E] for electrigen and [A] for aether).

The electrostatic phenomena of attractions and repulsions are attributed to the vibrations of the various elements and to the acoustic fields they produce in the surrounding aether.

The electrigen is conceived as covering the atoms of elements and clinging to them due to the external aether pressure. It evaporates when substances are heated in vacuum, while in chemical reactions it is transferred from one substance to another. In a voltaic cell for example, it is accumulated on the dissolving electrode in an excited state of vibration, and produces a diffusion wave through a wire when one is connected between the two electrodes of the cell.

The electric current is thus a diffusion wave of electrigen that acts mechanically on the surrounding aether at the common interface between the two and produces surface waves in it. The circular motion of aether particles which results constitute the magnetic field observed around a current-carrying wire. This view has further implications on the tenability of Ampere's formula for electric current elements as well as on our conception of the magnetic field, which will be explored in a future work.

A detailed animation depicting the action of the electrigen diffusion wave on the aether surrounding the wire is in preparation and will be released on YouTube under the title: Aether, Electrigen, and the Magnetic Effect of the Electric Current.