

# **New Physics EM Drive Space Thrusters without Lorentz reaction force and Fermion Crushing using monopole B field interference.**

By Leo Vuijk

Architect, MSc.

Free Energy Laboratories.

## **Abstract,**

The electromagnetic field around a direct current in a wire and the so called Lorentz force, has always been questioned by me and others about the microscopic visualization of individual (string) particle physics. (figure 1)

Now I present my view on EM space flight and Fermion Crushing based on kitchen table experiments and my Q-FFF Rigid Transformer String Theory.

For Fermion crushing by focused B-fields at the end of solenoids can use direct- or alternative currents, due to both interference field symmetries.

**1, for a Tubular Dual Coaxial Solenoid,** (figure 2,3,4)

**2, for a Triple Coaxial Tesla Pancake Coil. (Trifilar coil)** (figure 5,6)

## **Introduction.**

**Hardware:** Dual coaxial Solenoids or Trifilar Tesla coils for Lorentz EM Thruster Levitation effect.

**Standard Physics 1:** “Lorentz force” perpendicular to the magnetic field lines created by a direct current in the magnetic field.

**Standard physics 2:** Magnetic “B field” outside a long solenoid, shows a strong field reduction down to zero (called a B- field) and can be used for Lorentz force based levitation without the usual EM (Electro Magnetic) reaction force. (According to Q-FFF Theory)

Several configurations for effective EM thruster levitation without reaction force are possible like a dual coaxial solenoid (**figure 2**), or in the form of a so called Trifilar Tesla coil. (**figure 3**).

**The origin of both EM Drives is based on the EM B-field effects.**

**The origin of all B field effects (or anti Maxwell dipping zones) is postulated to be created by the microscopic interference of dual magnetic monopole field trajectories of North and South monopole photons.**

**The so called tubular shaped Anti Maxwell field dip (B field ) around a direct current in a wire is a second example of the monopole interference predicted by Quantum FFF Theory rigid string model. See poster. (Figure 1).**

**Future experiments should be able to create alternative configurations Monopole interference based B field phenomena.**

# Anti Maxwell magnetic field reduction close to an electric wire.

Explained by detail observation of iron powder distribution (the ring shaped absence) around a wire or coil. Below: Several observations and explanation by the curvature of monopole quantum information arrays.

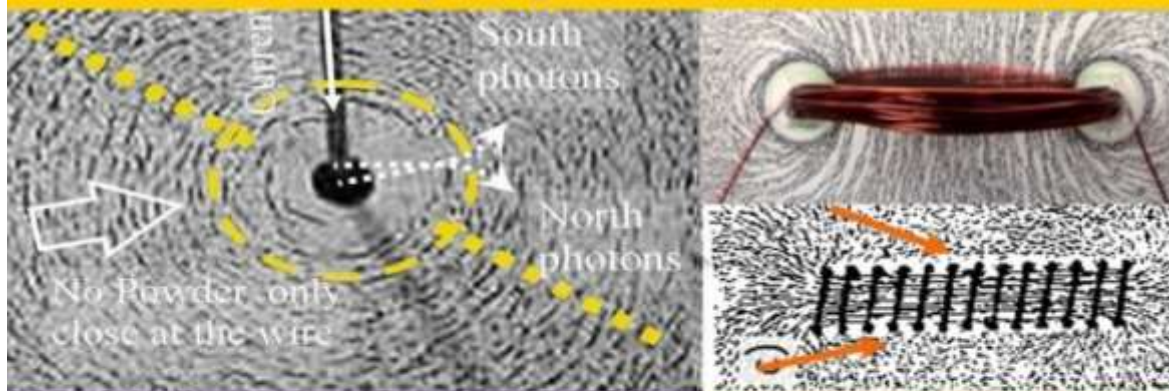

According to Quantum FFF theory, all magnetic fields can be presented as DUAL Magnetic Monopole Photon Vector Arrays. These monopole arrays undergo curvature. As a result, the magnetic field intensity around the Earth and a wire is NOT dropping off with the square of the distance from the source!! The field become stronger polarized away from the source (See images). Close to the current transporting wire the magnetic field strength is zero due to the parallel trajectories of North and South Photons before curvature and polarisation of iron powder ( Author: Leo Vuy!)

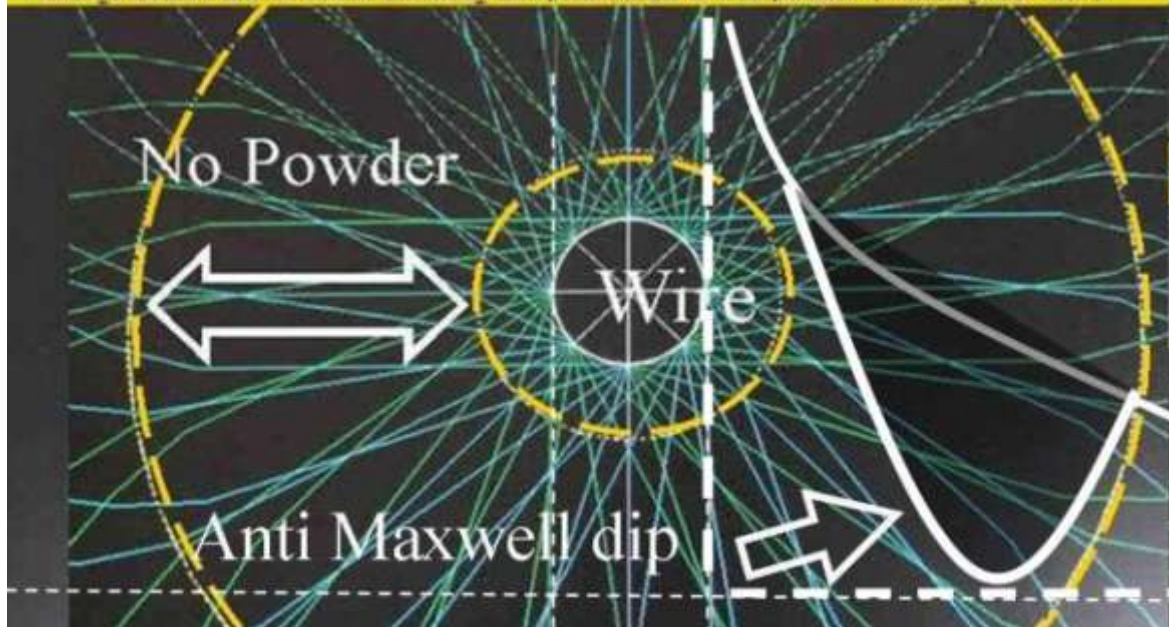
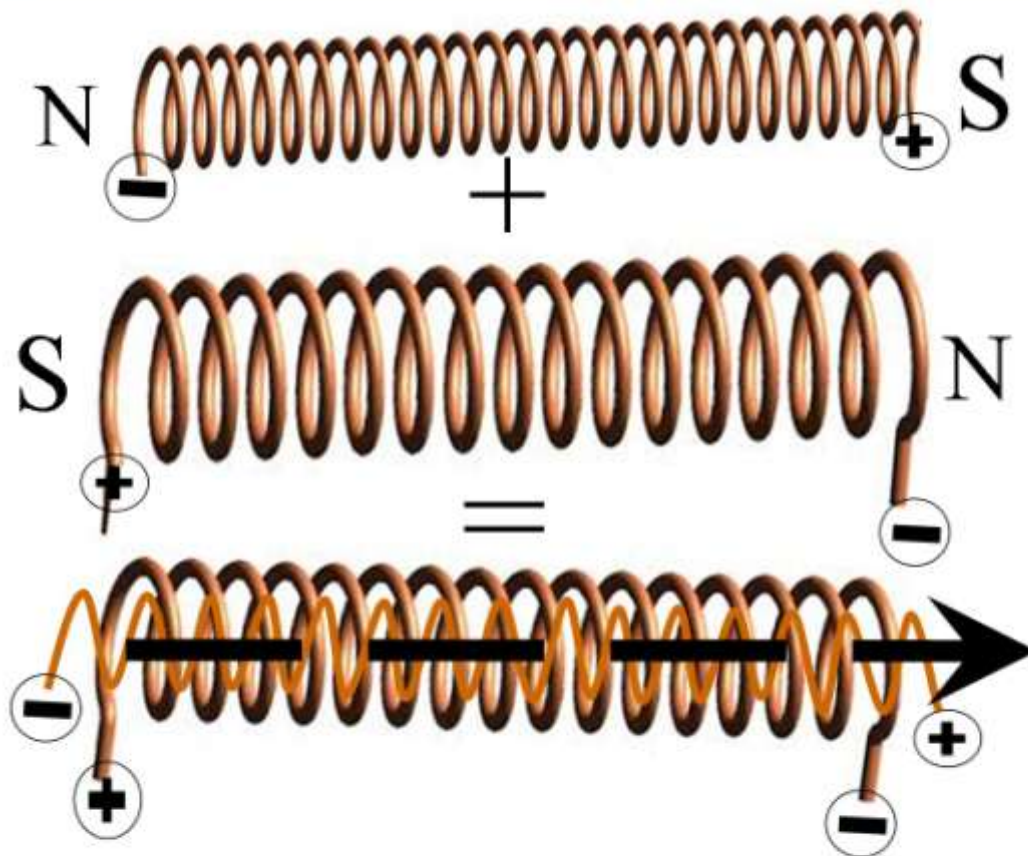

Figure 1,



## EM Drive Thruster Levitation by EM Monopole interference creating B-field.

Both outside B Fields of the solenoids, have a strong reduction due to monopole interference down to zero (according to Quantum FFF Theory) Therefore, the zero B field of the inner solenoid, has NO Lorentz force reaction effect on the outside solenoid.



The resulting Lorentz force on the inner solenoid depends on both potentials and polarities

Figure 2,

## Dual Coaxial Solenoid for EM Drive Thruster Levitation effect.

Both outside B Fields of the solenoids, have a strong reduction due to monopole interference down to zero (according to Quantum FFF Theory) Therefore, the zero B field of the inner solenoid, has NO Lorentz force reaction effect on the outside solenoid.

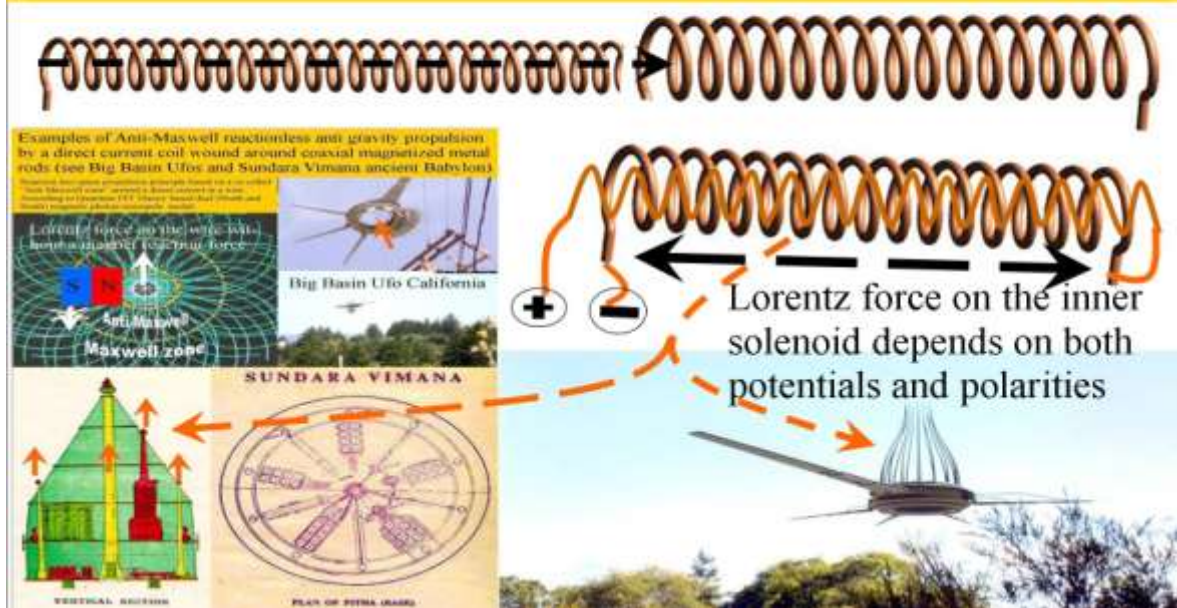

Figure 2,

## Fermion Crusher by EM Monopole interference creating B-field.

Both 2x coaxial aligned opposing North South Fields of internal solenoids create a focussed B- field on both sides. (arrows by direct- and alt. currents)  
B- fields can neutralise GLUOS between Quarks and/or electrons inside the atom.  
See: 3x B-filed Flat Fermion crushers. ( Quantum FFF Theory)



Fermion Crusher by EM Monopole interference creating B-field.  
 Both 2x coaxial aligned opposing North South Fields of internal solenoids create a focussed B- field on both sides. (arrows by direct- and alt. currents)  
 B- fields can neutralise GLUOS between Quarks and/or electrons inside the atom. See: 3x B- filed Flat Fermion crushers. ( Quantum FFF Theory)

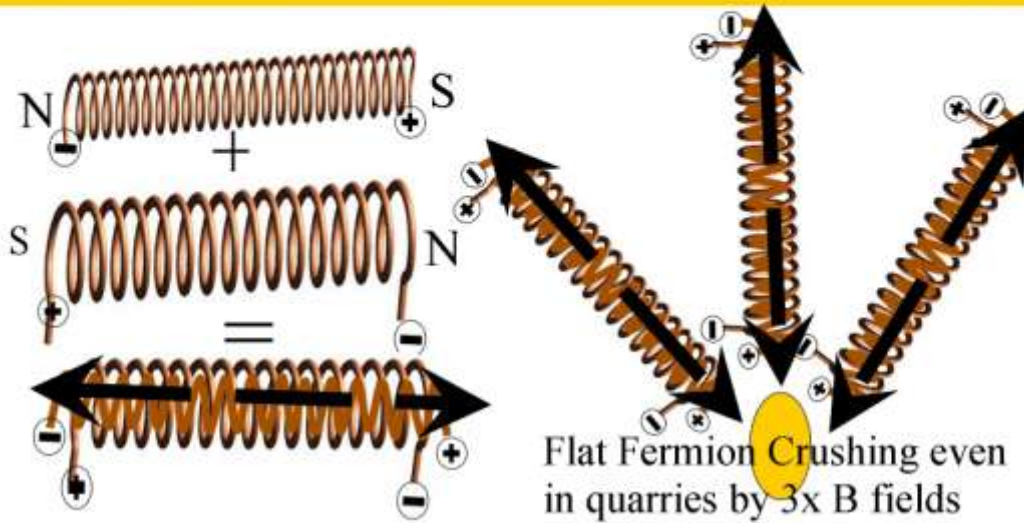

Figure 3,

Even with only ONE solenoid combination it seems to be able to evaporate Fermion or rock. ( Angouleme Fr. (Getty stock)

Evidence for Ancient Stone Block Cutting by focussed new physics B-Field of electric dual central solenoids without chisels.  
 (Angouleme France) See Quantum FFF Theory.

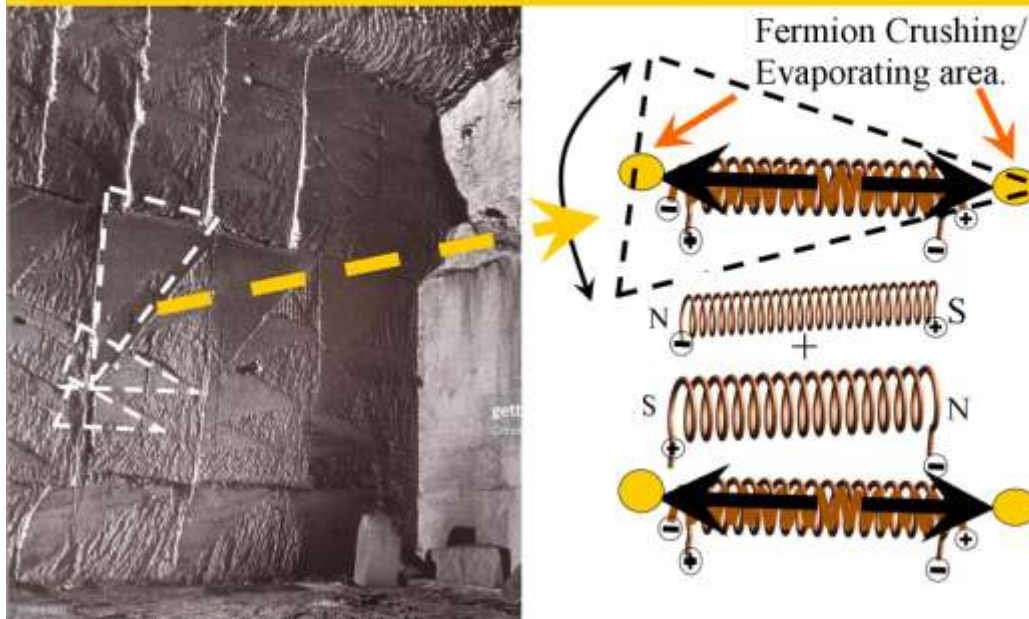

Figure 5,

## EM Drive Thruster Disc by triple coaxial Tesla Pancake coils

Reaction less Lorentz force creation inside a Bifilar Tesla coil field due to the reduced **Anti Maxwell tubular magnetic field** around a current in the multiple wired compound coil conductors of the internal third pancake coil. (According to Q-FFF Theory)

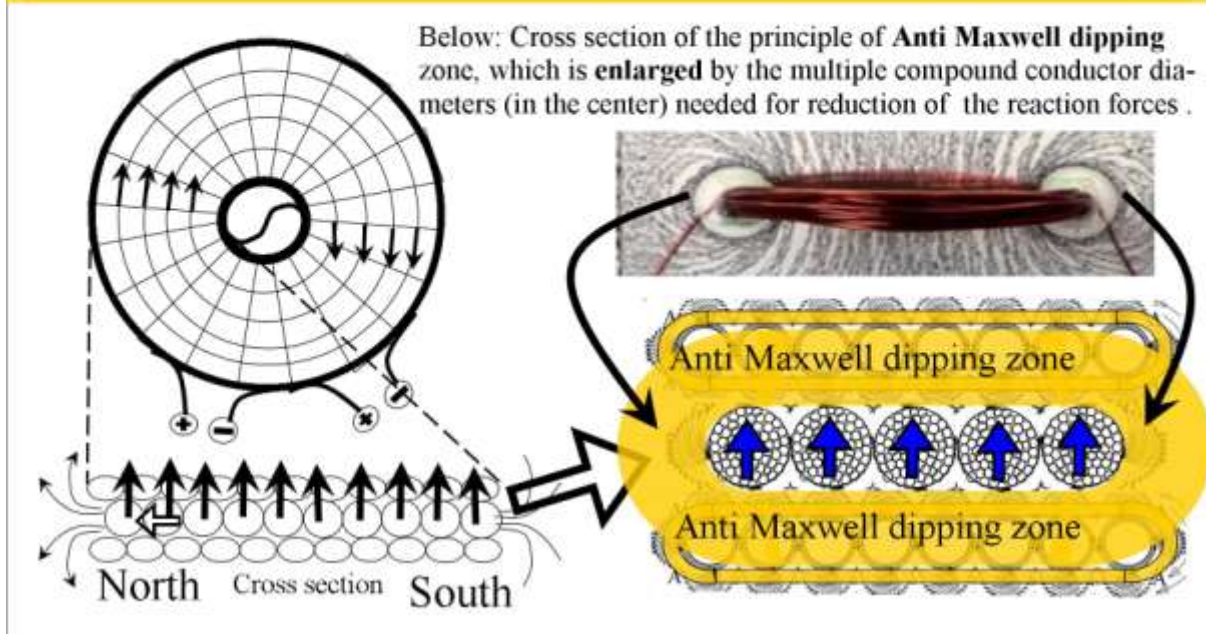

Figure 6,

UFO back engineering by EM Drive Thruster Discs by triple coaxial Tesla Pancake coils, with reaction less Lorentz force creation by anti Maxwell B-field interference reduction according to Q-FFF Theory.

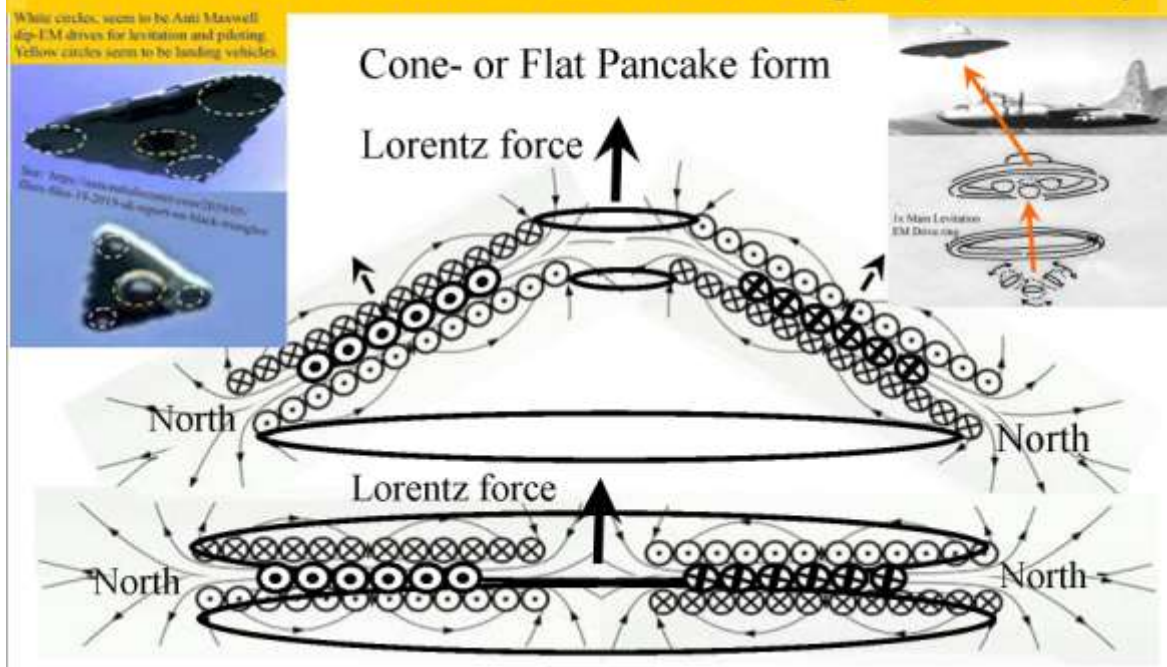

Figure 7,



Anti Maxwell Zone close to a current in a wire, is responsible for a new dual Monopole Photon based reaction less spaceflight principle.

Reaction less space propulsion principle based on a so called "Anti Maxwell zone" around a direct current in a wire.

According to Quantum FFF Theory based dual magnetic photon monopole model.

According to Quantum FFF theory, all magnetic fields can be presented as DUAL Magnetic Monopole Photon Vector Arrays. These monopole arrays undergo curvature. As a result, the magnetic field intensity around the Earth and a wire is NOT dropping off with the square of the distance from the source! The field become stronger polarized away from the source (See images). Close to the current transporting wire the magnetic field strength is zero due to the parallel trajectories of North as South Photon before curvature and polarisation of iron powder (Author: Leo Vuyk)

Lorentz force on the wire without a magnet reaction force.

TWO (North and South) Monopole Photon trajectories around a current in a wire shown in cross section. Between the two yellow circles both (N+S) trajectories are pointing about parallel. The result: No iron Powder orientation between the concentric circles, as is observed in the lab (see upper photo). This is a firm support for the monopole photon vector array element of Quantum FFF Theory.

Figure 8,

## Other elements of Quantum FFF Theory: ( FFF= Form Follows Function at the quantum scale)

The Magic of Fermion- Repelling and Creating Black Hole Horizon

! You need a dark energy oscillating particle Vacuum Lattice combined with a Dark Matter String Nucleus of a Black Hole AND Propeller shaped Rigid Spinning Fermions.

According to Quantum FFF Theory, there is no fermion information loss, only photonic information loss in a black hole. Quantum fluctuations around the BH horizon produce pairs of leptons,  $e^-e^+$  and even compound quarks (d,u, etc. see Fermion 3D string propeller theory - fermion repelling by spin flip). For tripple BH horizons see image nr's 7, 10 and 11. Event horizon=7, Inner photon ring = 10, Outer photon ring = 11. Conclusion The Big Bang did not produce instantly all the Fermions in the univers. Even now lots of Fermions are produced by all BHs even the largest primordial Big bang splinters located outside large galaxies - see also: <http://vixra.org/abs/1410.0039>

Black hole EAT the vacuum lattice with the oscillating Higgs particles. So, the vacuum lattice structure around a black hole could be represented like this. As a result, the new vacuum is thinner or diluted, it has holes, which could be the origin of the Universal HIGGS field. In contrast, my new black hole paradigm says: the origin of vacuum robustness is Dark matter. Dark matter is the proliferation of vast numbers of Black holes around Galaxies. Conclusion, based on Higgs's subtitle, you don't know anything about expansion or contraction of the universe. (Author: Leo Vuyk)

Figure 9,

Geometry of the New Magic number nucleus with 34 nucleons, found by RIBF/Riken. Japan, ( D.Steppenbeck) according to Quantum FFF Theory.

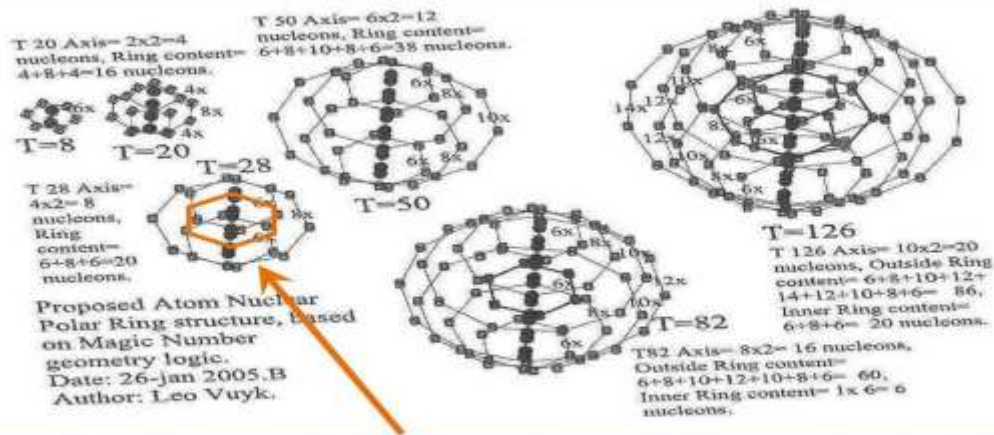

Additional equatorial positioned coaxial ring structure with 6x nucleons in the centre of the nucleus.  
 Result:  $T=28 + 6$  nucleons becomes  $T=34$ . (oct.2013).  
 Future evidence for additional nucleon rings (+6+8 or 10) inside nuclei coded:  $T=50-82$  or  $126$  seems to be possible.

Figure 10,



Alt. SuSy Rigid Transformer String Standard Model with 6x neutrinos (3x for the anti matter universe) with one torus Axion-Higgs Mother particle of rectangular cross section (UROL)  
See Quantum FFF Theory.

The Axion- Higgs Vacuum Field particle is coded OOO, representing three closed Rigid String hinges of the mother rigid ring, able to rotate in steps over 90 degrees into L,U and R: Left Up and Right,

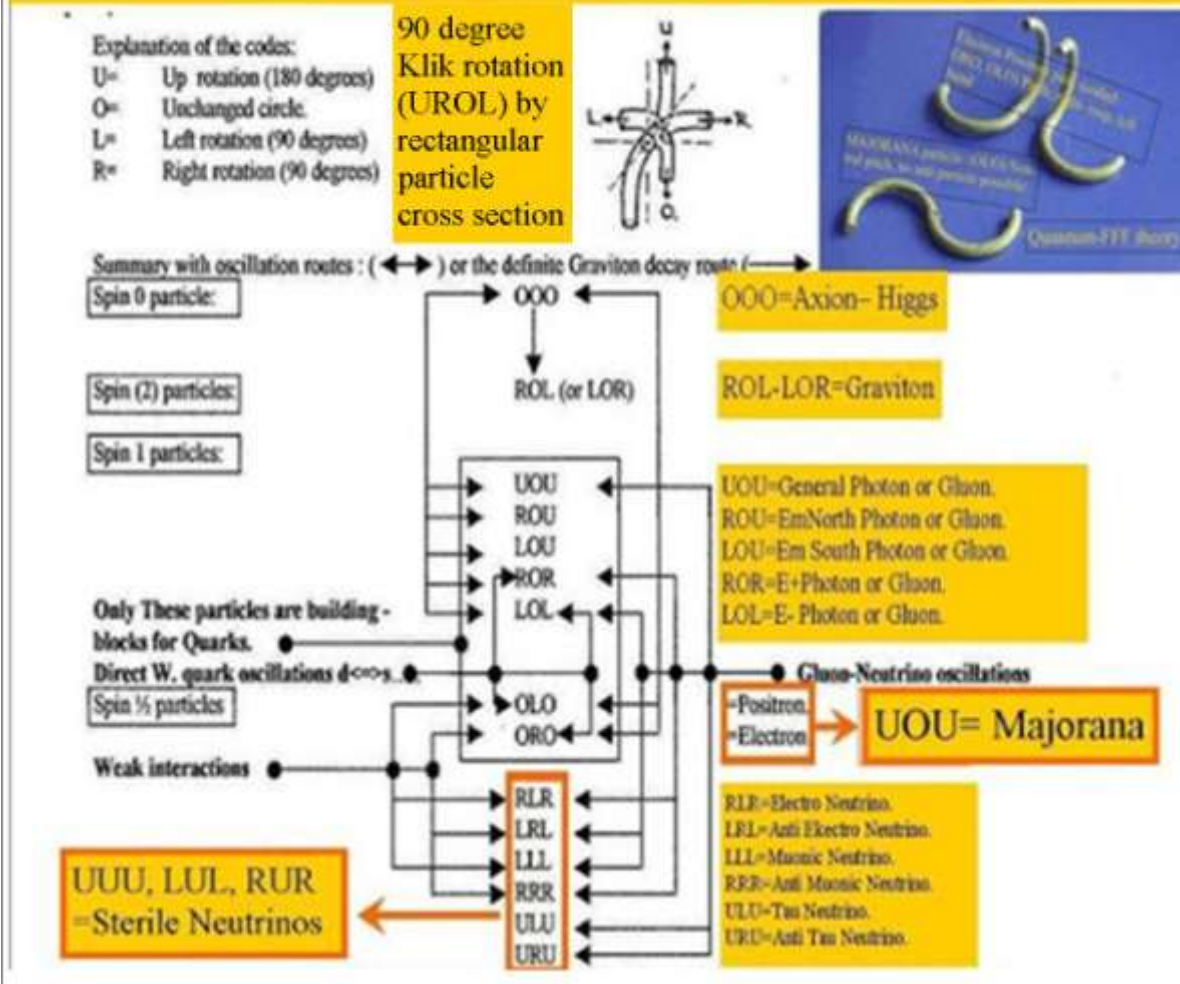
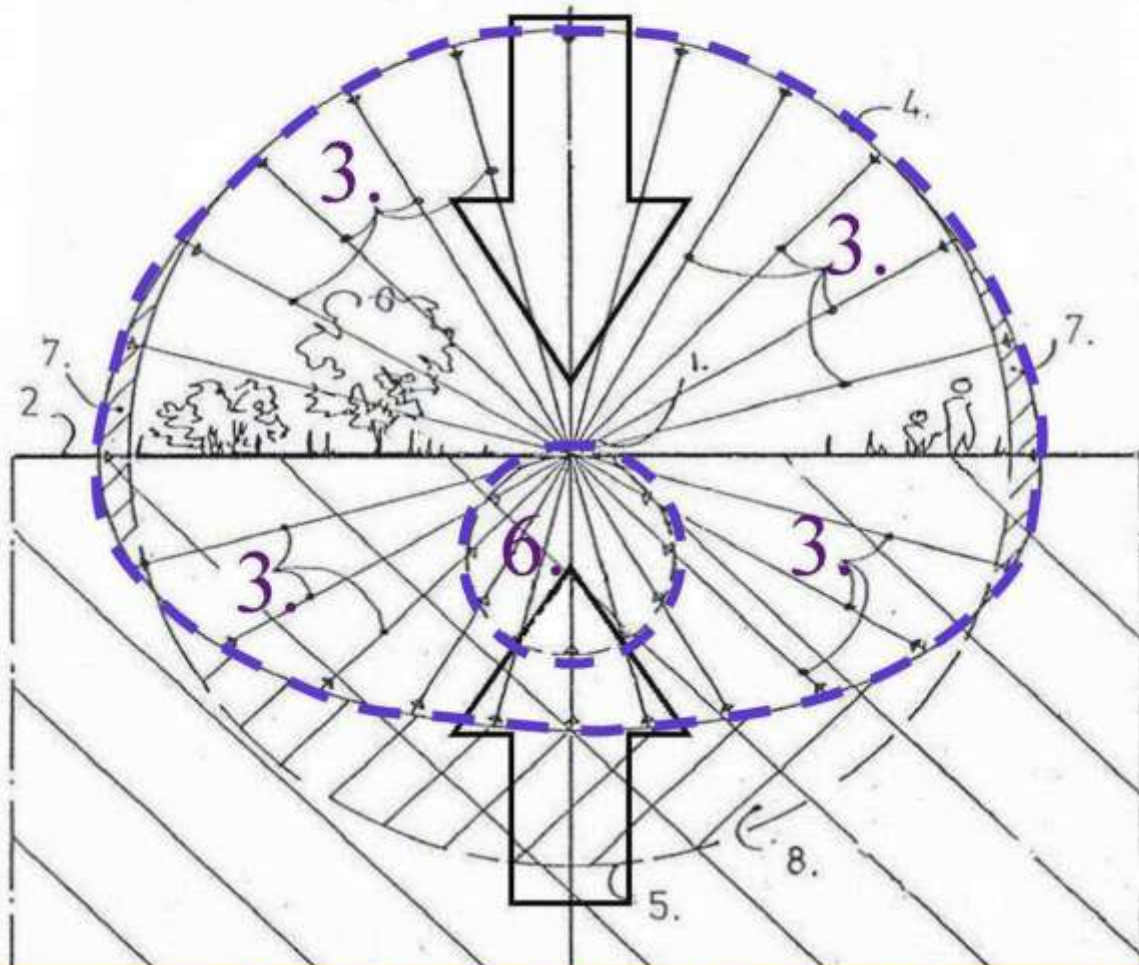

Figure 11,

Quantum Gravity as pressure distribution of the oscillating dual Higgs/Graviton vector field.



Cross section through the dual Higgs/ Graviton 3D vector field pressure distribution (or globular Hedgehog) on a point mass (1) located on earth's surface (2), according to Quantum FFF theory.  $3+4$ = Higgs vector field.  $6$ = Graviton vector field originated by the Higgs-graviton field transformation of the earth itself.  $7+8$ = differences with a perfect globular vector distribution. Field variables  $3+6$  are rendered as inversed arrows. (see also black hole pressure distribution without gravitons)

Figure 12,



↓ 3D base for 3x hinged rigid strings.



OOO,-ROL-UOU,ROU,LOU,ROR,LOL,-OLO,ORO-RUR,LRL,LLL,RRR,ULU,URU.

Figure 13,

## Splitting String Black Hole Inflation/Vacuum evaporation

The Origin of energy overdensities in the CMB

The Cosmic Background (CMB) energy overdensities can be explained by a Big Bang Black Hole splitting and evaporation process, according to Quantum FFF Theory.

EDM-BHs: Electric Dark Matter -Black Hole systems seem to be active at all scales.

Multi Bangs for Dual Symmetric Universes

Dual Quasars /Herbig Haro ( Galaxy/ Stellar Anchor BHs)

Big Bang BH Splinters

Herbig Haro system

Dual Galaxy Anchor BHs

Galaxy Central BHs growing by merger BHs of S-Novas as a start of a contracting Universe into a Big Crunch.

"Reversed Inflation" of the Universe: the Origin of Filaments and Voids.

New oscillating Axion -Higgs vacuum lattice

Empty space

Herbig Haro systems

Cygnus A with dual plasma/gas producing "New physics" negative charged BHs as hotspots, with growing merger (SN) black hole in the center. Below: local Quantum vacuum push gravity vector butterflies originated by the BH vacuum absorption of dark vacuum energy.

Electron-ion jet

Electron-ion jet

Fermion repelling Black hole horizon

Vacuum Push Gravity Butterfly curves around test masses.

The origin of the Cosmic Alpha System (CS) and Higgs vacuum, by the splitting of the Big Bang Black Hole (BBBH) into smaller Spindler BHs (SBH). The splinter BHs (SBH) separate into smaller evaporating black holes at the Front (LF) which compresses the pressure from the backside alpha BHs (LB). The BHs (LB) are assumed to partly evaporate like BHs (LF) also into a newly formed oscillating Higgs vacuum until the Higgs vacuum pressure stops the evaporation and forms Galaxy-Forming BHs (LF) behind. However single BH will pair (LB) with the nearest other BHs to form DoubleBH systems, which efficiently form Giant Stars and Galaxies (LF) in between (random: Last work).

Figure 14,



# The Bouncing Multiverse 2a

According to Quantum FFF Theory, we live inside one of a specific number of Charge Parity symmetric copy universes coming out of a huge ( Axion/Higgs rigid string black hole nucleus = Dark Matter). All copy string particles are guided by long distance (holographic) multiverse entanglement and transformable by mutual collision into all Standard model particles and more. Such as mono-pole bosons or massless Axion/Higgs vacuum particles (Dark Energy), responsible for the Casimir effect and half of all other SM semi pressure forces.

One bouncing universe of the Raspberry Multiverse depicted.

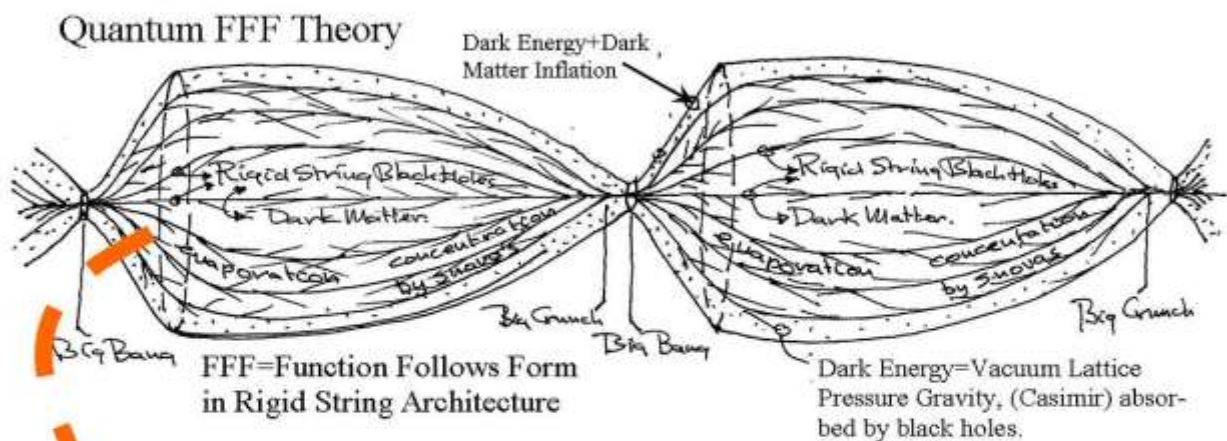

Below: the usual BH dual pairing after the Big Bang splitting.

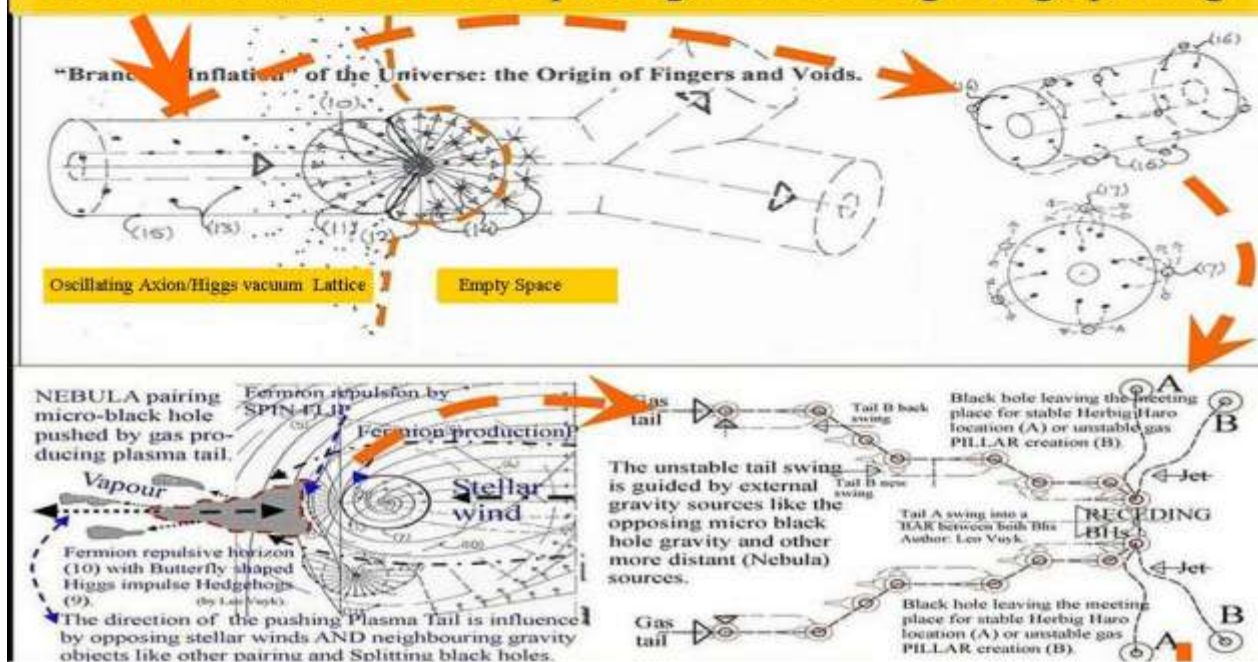
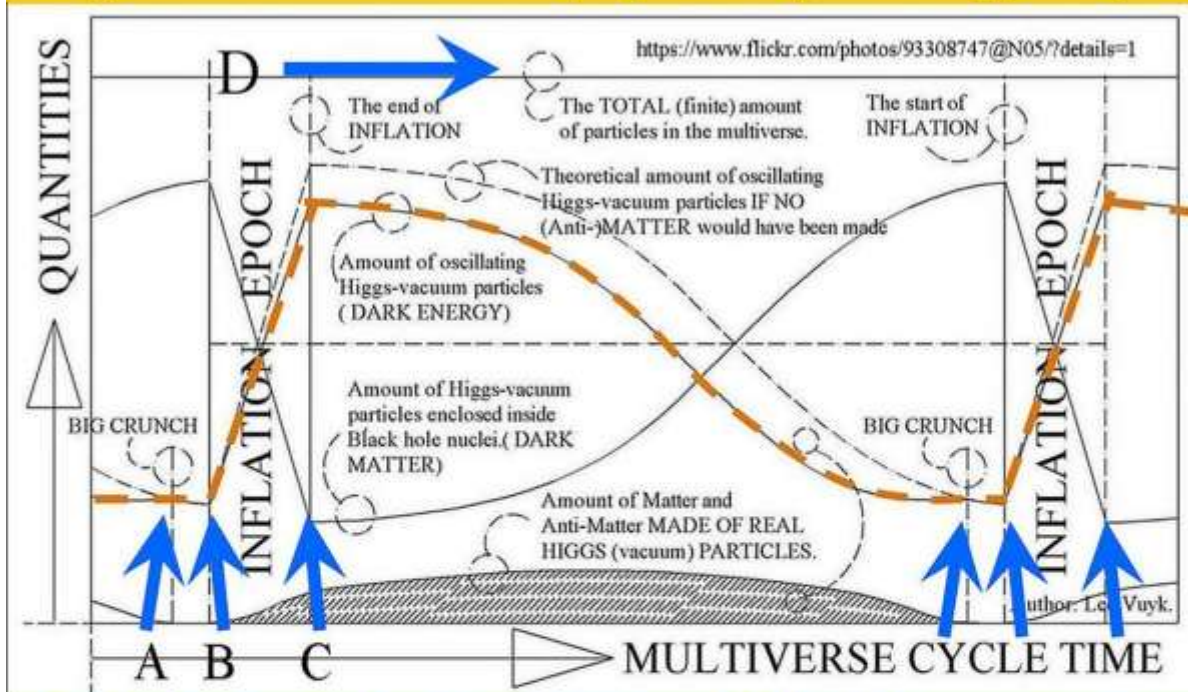

Figure 15,



## The Beginning and End of Time.

Multiverse cycle time versus quantities of mass carrying particles, Dark Matter Black Hole particles and Dark Energy Oscillating Vacuum Lattice (Axion Higgs field) particles. All particles and fields are assumed to be based on rigid string particles. Negative and Positive charged Fermions should have propeller shapes with opposite pitch.



A: The end of matter based time. (Big Crunch) All rigid string matter is through merger Super Nova black holes concentrated into one BH nucleus, which is compressed by the remaining-but absorbing- deluting-dark energy vacuum. If the deluted vacuum pressure comes into equilibrium with the total internal string tension of the nucleus, the Big Bang BH splits symmetrical into 8 or 12 entangled BH nuclei.

B: The beginning of matter based time and the splitting of the Big Bang Black Hole string nucleus into series of minor secondary primordial BHs, building the fractal shaped Lyman Alpha Forest and the start of dual pairing BHs into primordial Herbig Haro systems with vast galaxy formation in between.

All New physics BHs (even micro interference BHs) are postulated to create not only pair production at the horizon, but even entire protons. (plasma)

C: The end of primary Big Bang black hole splitting and the end of vacuum expansion (vacuum inflation)

D: The Total number of particles during the cycle process is constant.

According to the Quantum Function Follows Form model.

Figure 16,



The Nucleus of the Rigid String Knotty  
Black Hole, compressed and growing  
by the Axion Higgs vacuum.  
(According to Quantum FFF Theory)



A ball of stringy particles, compressed by the energy of the oscillating Axion Higgs particle based vacuum lattice= ( Casimir) Dark Energy.  
The BH nucleus itself is Dark Matter.  
Conclusion: all stable BH nuclei represent all Dark Matter in the universe.  
Non stable evaporating BH nuclei can be called Ball Lightning or micro comets.  
The boundary between these two types is unknown.

Figure 17,



New Black Hole Nuclear Interior  
 with primal Rigid transformable  
 ring shaped Strings ( Axion Higgs  
 vacuum rings) compressed by the  
 oscillating repeller vacuum.  
 (Quantum FFF Theory)

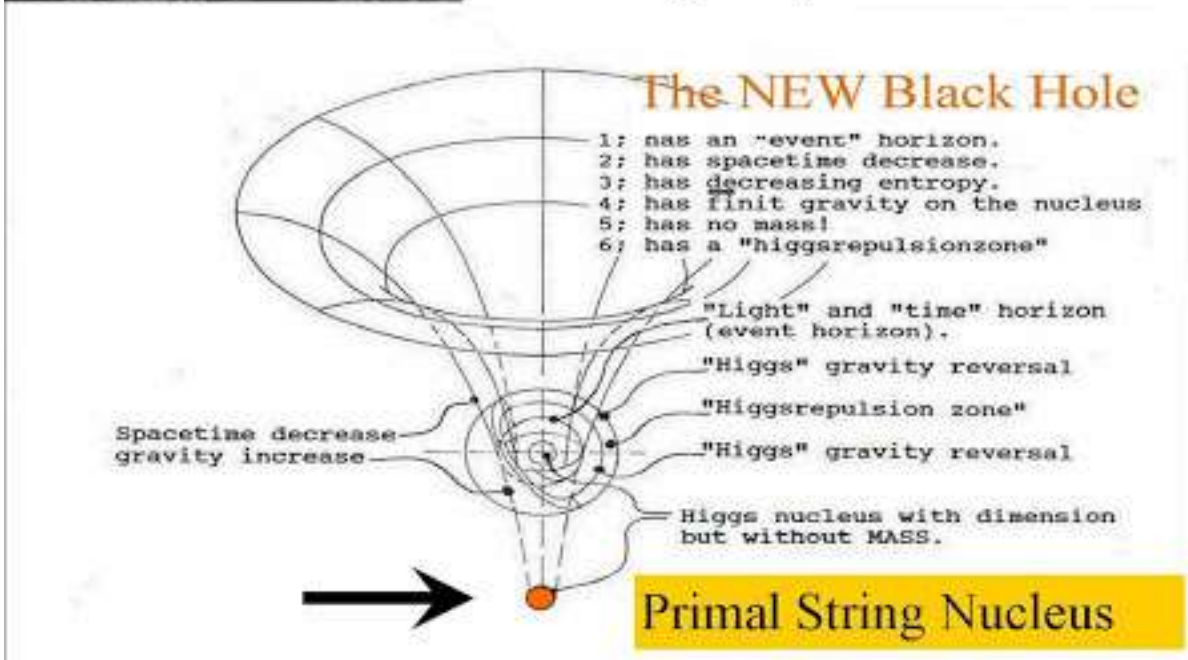

Figure 18,

Evidence for a Fermion Repelling New Physics Black Hole inside Herbig Haro (HH34) Bowshock ! Outflow Velocity differences between the leading black hole and the secondary Fermion plasma hotspots are the indication, according to Q-FFF Theory.

The black hole (O) has the smallest relative velocity. Conclusion: Secondary Fermionic plasma hotspots are repelled ! As predicted!

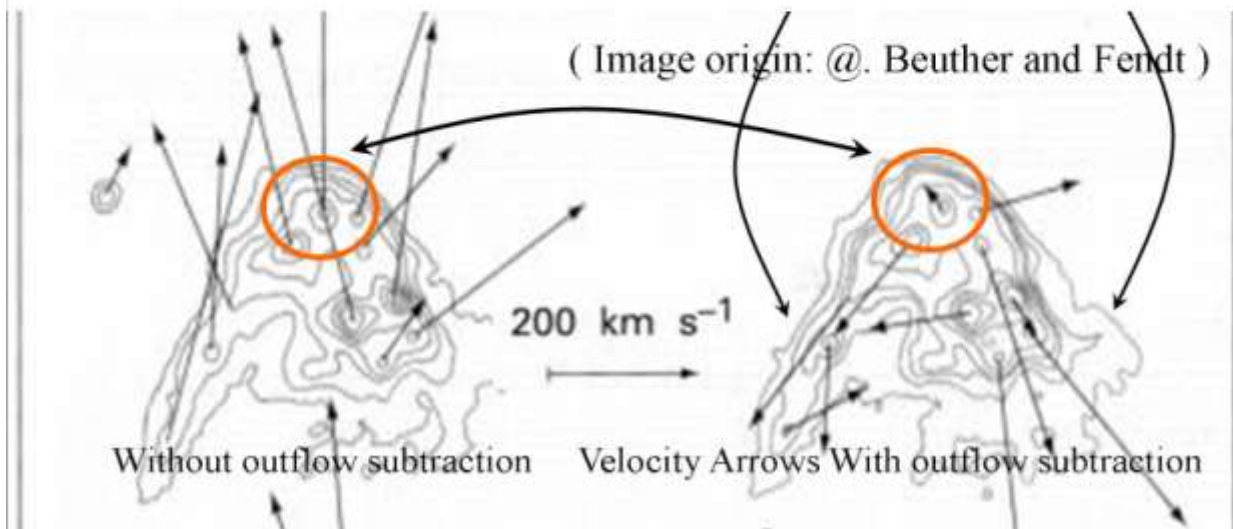

Figure 19,

Stable Micro Comets, Ball Lightning and WIMPs are the future solution for our CO2 problem, by electric vacuum energy production technology. [http://vixra.org/author/leo\\_vuyk](http://vixra.org/author/leo_vuyk)  
 See: Artificial Ball Lightning production and exploitation device for Zero Point Electric Energy usage. <http://vixra.org/pdf/1108.0036v6.pdf> and <http://vixra.org/pdf/1404.0151v1.pdf>

Ball lightning pushed by Plasma tail against the wind

Vapour trail washed out by the wind

Ball lightning micro-black hole pushed by gas producing plasma tail

Self propelled Ball Lightning-Micro Comets. What is wrong with Physics?

Micro Comets (micro black holes)

- 1: Gravity is a dual pressure force of pushing Gravitons opposing the stronger Casimir vacuum pressure..
- 2: The vacuum has resistance for ALL Fermions motion.
- 3: Black Holes attract but also repel Fermions close by.
- 4: The cyclic Raspberry multiverse has 8 or 12 symmetric anti copy universes entangled at QUANTUM SCALE as the origin of Inertia and Consciousness.

Figure 20,



## Observed dual LHC signals of 124-126 GeV Higgs

The chirality of our material universal vacuum lattice formed by the massless Axion/Higgs oscillating dark energy field, is supposed to be the origin of these different masses. According to Quantum FFF Theory,

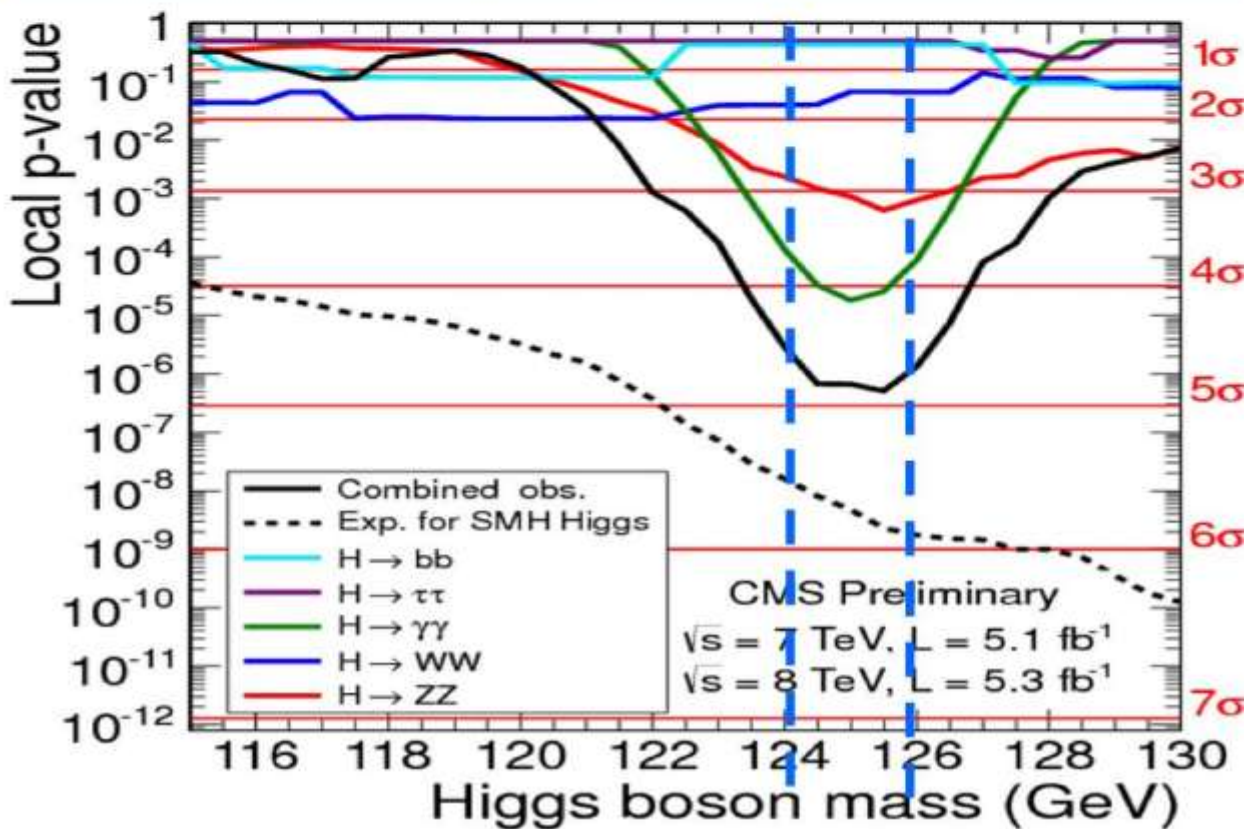
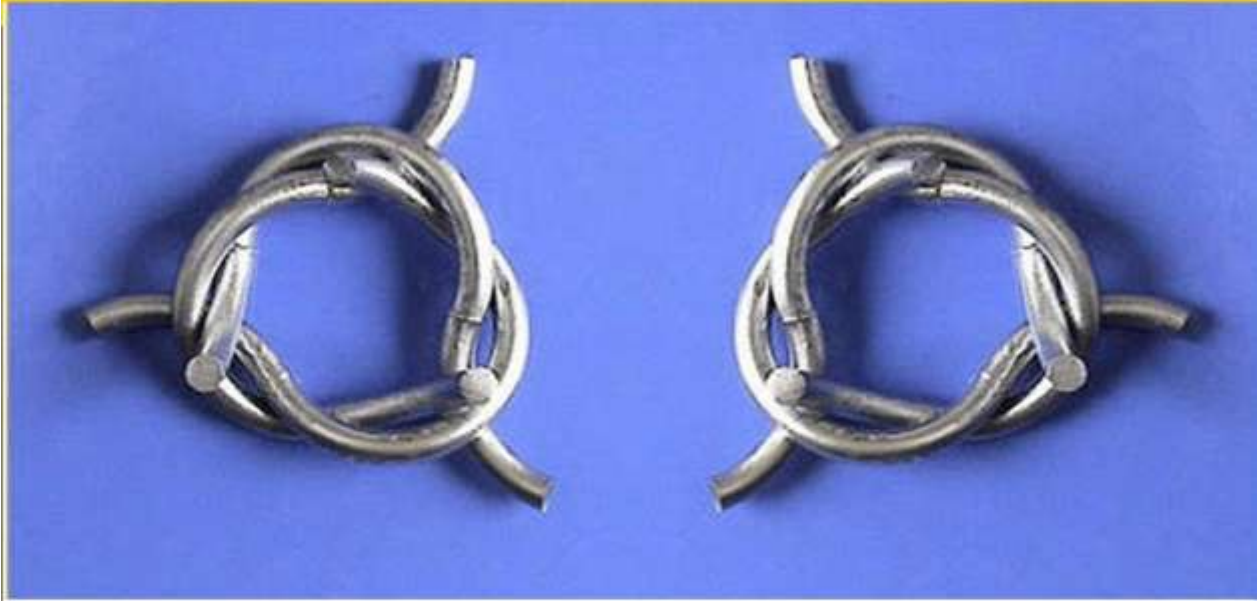

Figure 21,

# The New Black Hole according to the Quantum-FFF Model: Negative Charged (outside) and Fermion (Plasma) Creation out of the massless Axion-Higgs String vacuum. (Fermion repulsion).

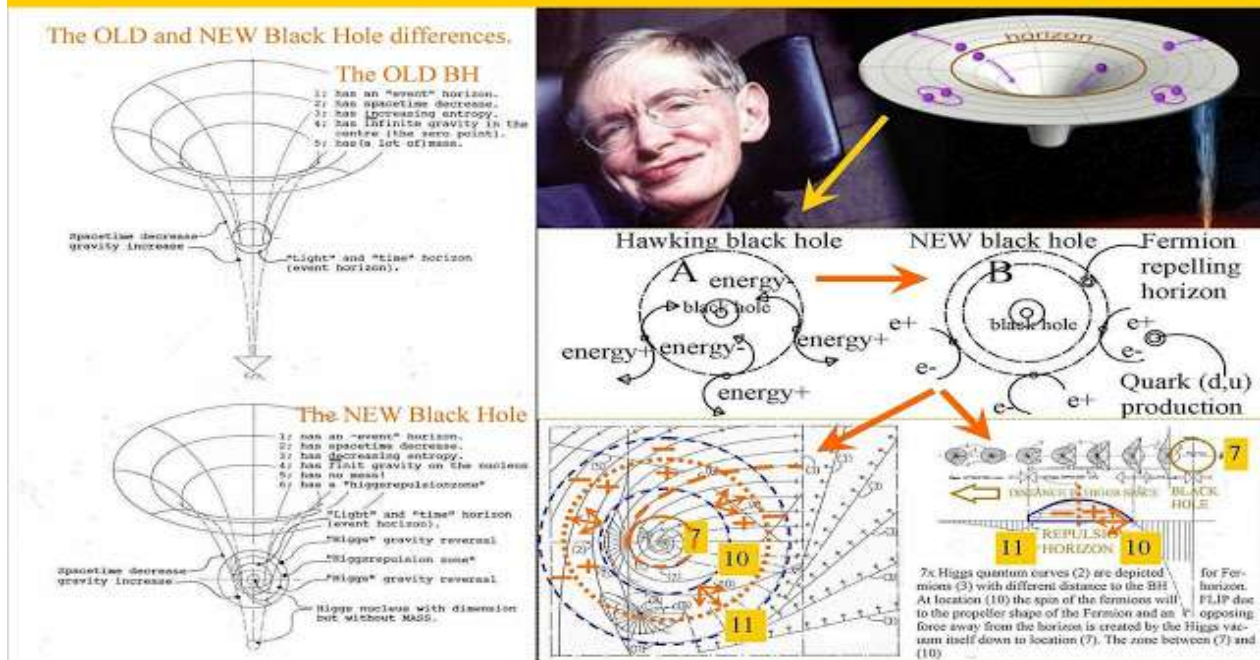

Figure 22,

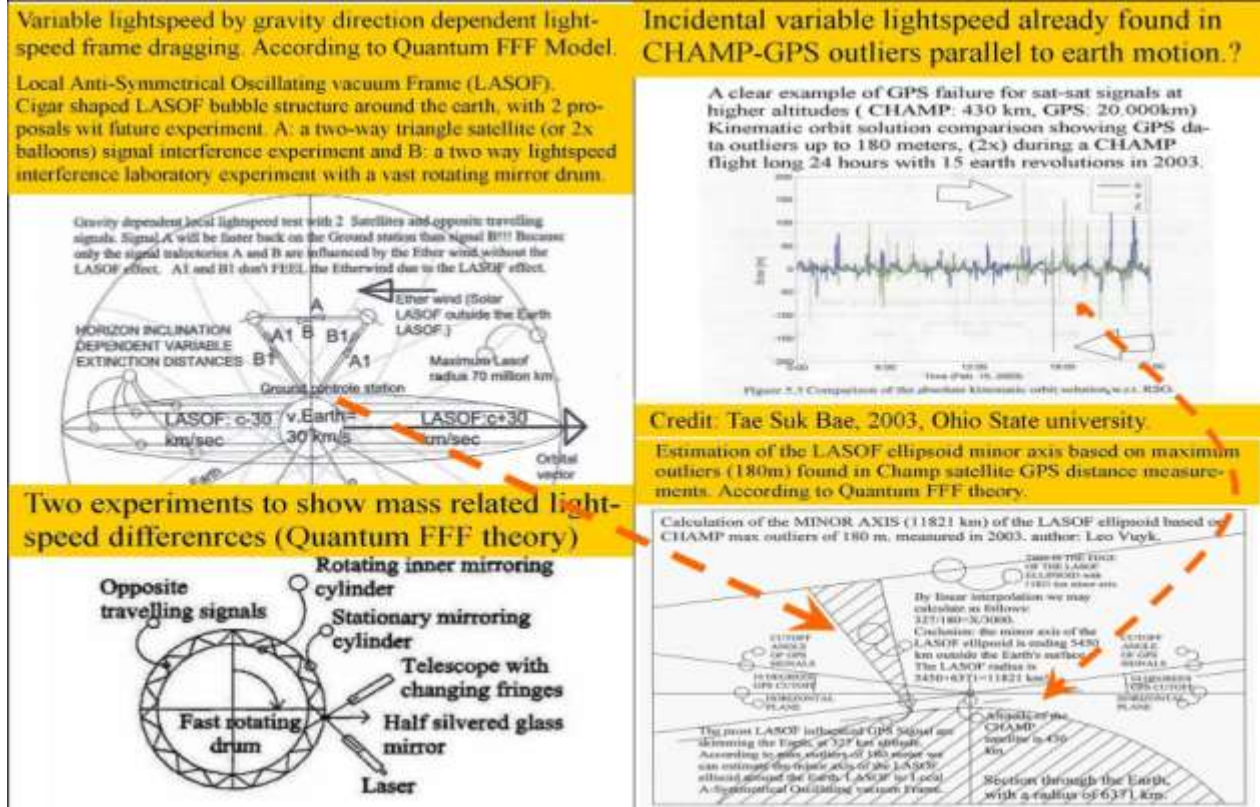
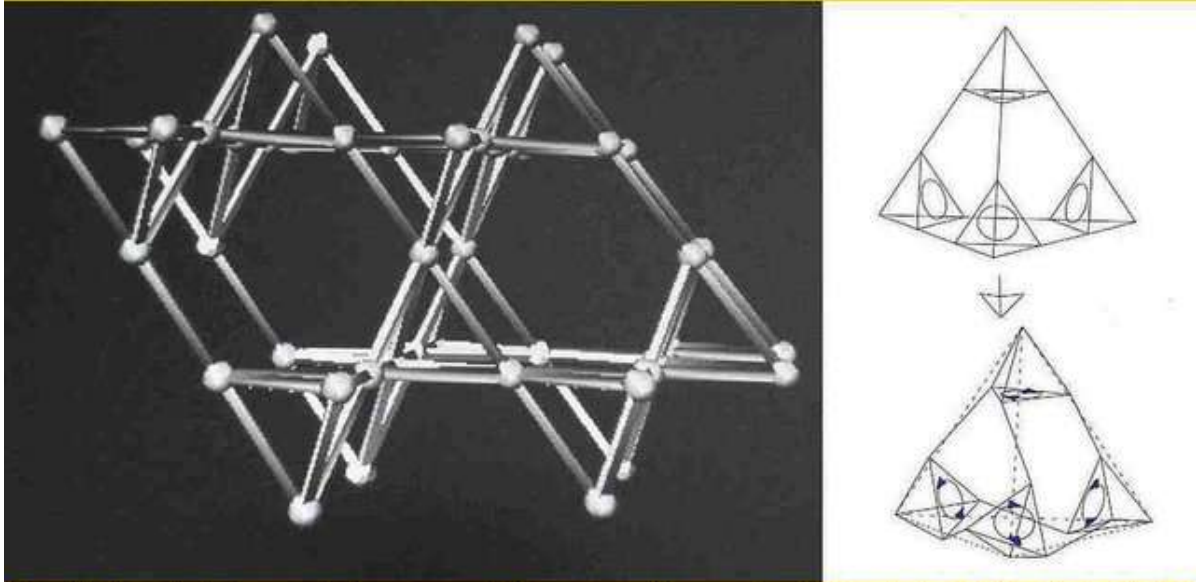

Figure 23,



# New Dark Matter Black Hole, “Eat” the chiral oscillating Higgs vacuum.(Quantum-FFF Theory)



Simplified tetrahedral vacuum lattice structure (left), constructed by complex chiral tetrahedral building blocks (right). Each universe has to choose between a left- or righthanded rotation of its tetrahedral building blocks. Each chiral lattice has the Planck length and is supposed to be equipped with at least two oscillating massless new Higgs particles.

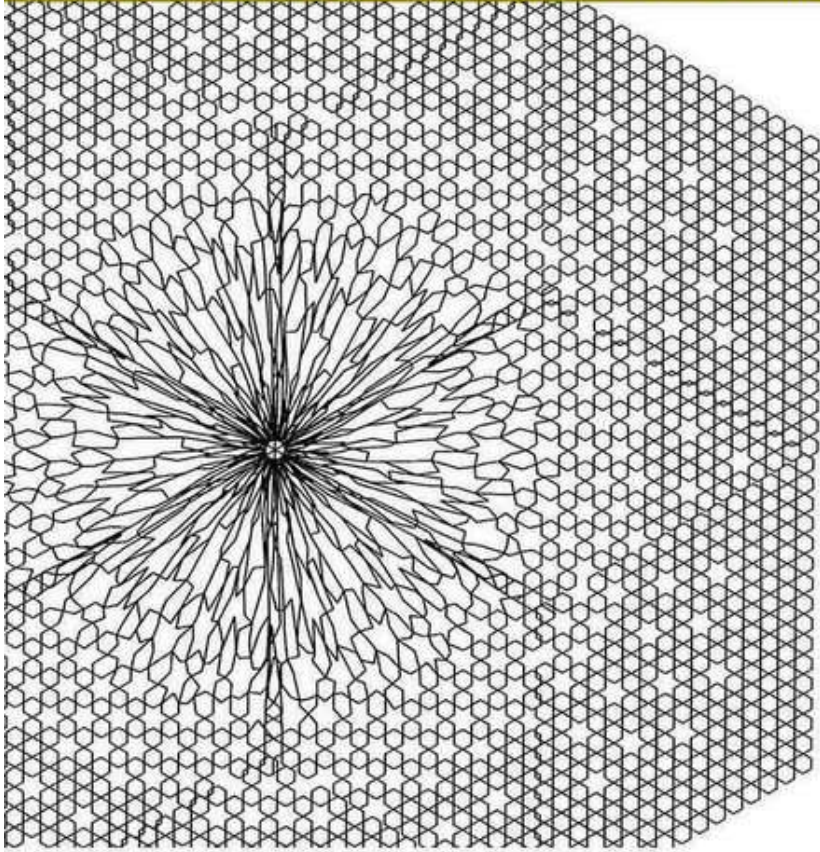

Black holes EAT the vacuum lattice with the oscillating Higgs particles.  
 So, the vacuum lattice structure around a black hole could be represented like this.  
 As a result, the near vacuum is thinner or diluted, it has holes, which could be the origin of the Universal HUBBLE redshift.  
 By contrast, my new black hole paradigm says: the origin of universal redshift is Dark matter.  
 Dark matter is the proliferation of vast numbers of Black holes around Galaxies.  
 Conclusion, based on Hubble redshift, we don't know anything about expansion or contraction of the universe.  
 (Author Leo Vuyk)

Figure 24,



# Composite rigid transformable string models based on 3x internal-90 degr. step rotation of the Axion-Higgs Torus made of primordial matter.

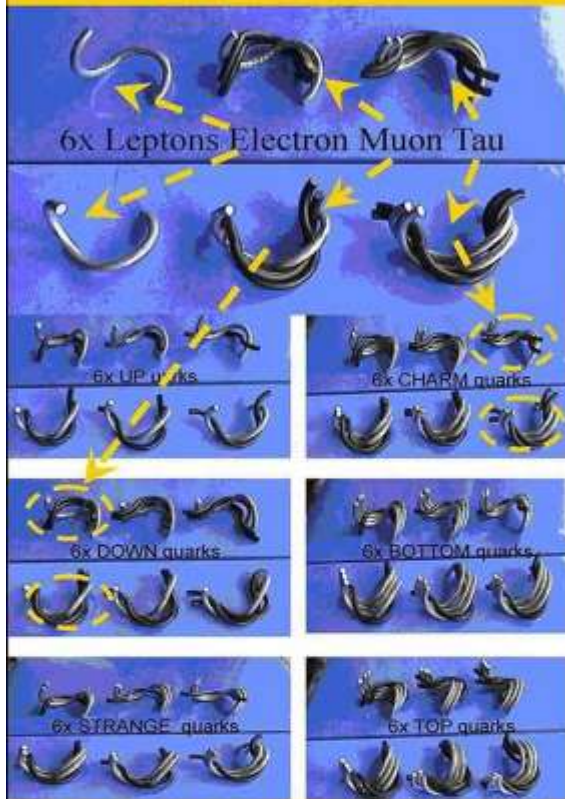

Geometrical proposal for the sub-quantum structure of 6 Leptons and Quarks interpreted as compound Photon/Electron Positron propeller combinations. Muon- and Tau particles seem to show up as family members of the Down respectively Charm Quarks.

The basic rigid transformable Axion string Torus with aspect ratio (=7) and 1x splitting and 3x hinges made of primordial matter, according to Quantum FFF Theory.

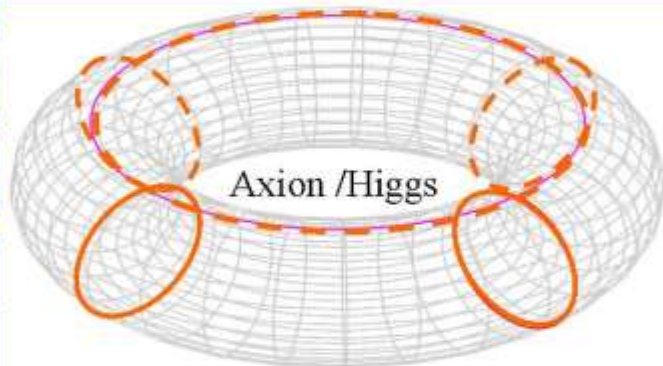

All Photons (1x graviton, 2x electric-, 2x magnetic and 1x general x-gamma-ray photon) and two Fermions, are transformed direct out of the massless Axion/Higgs ring, by internal hinge rotation over 90 degree steps. Electric Dark Matter Black Holes (EDMBHs or EREBONS (Penrose) are formed by 3 or 4 photon knots (ball lightning). Neutrinos are single transformed photons or fermions.

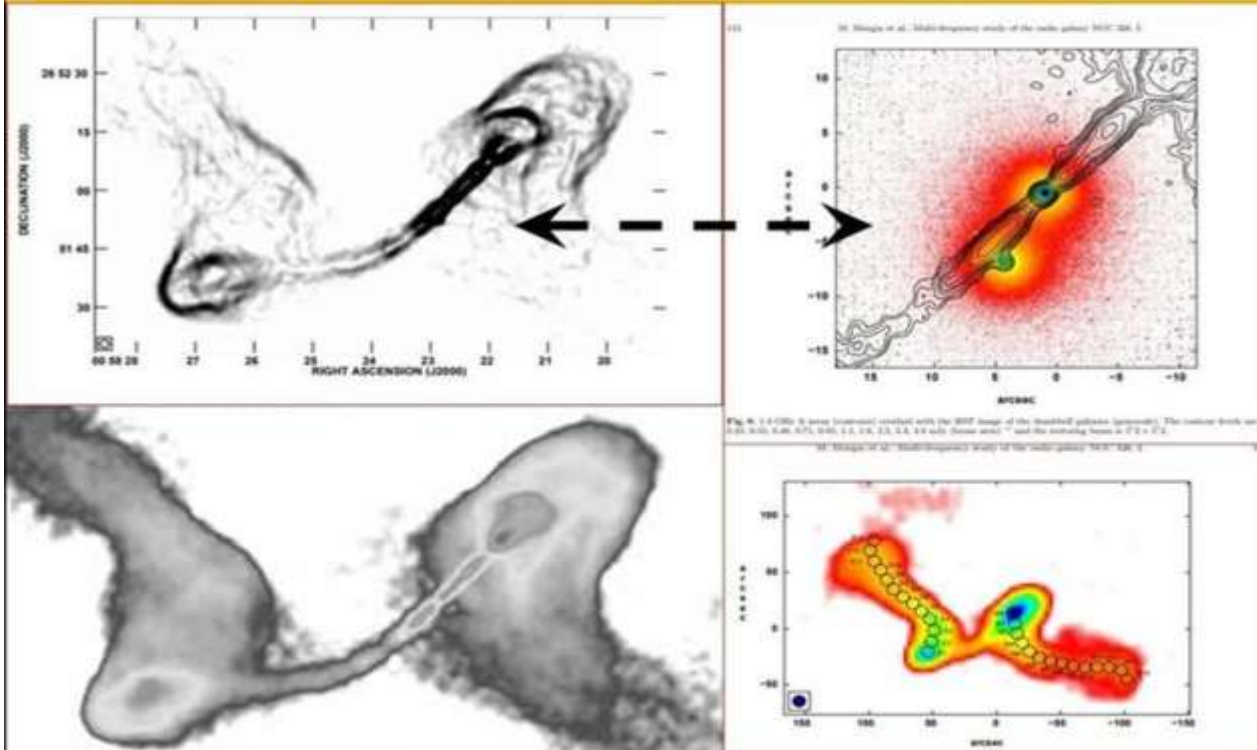

Figure 25,



# The Key Observation of new Physics Fermion Repelling Dark Matter Black Holes for Universal structure.

Example of NGC 326: The Repelling of Two Equal sized Black Holes as the formation of a Herbig Haro Bowshock system, with star formation in between and double jets. According to Quantum FFF Theory.



@ images: A multi-frequency study of the radio galaxy NGC 326 by M.Murgia et.al. (CNR Bologna.it.) <https://www.aanda.org/articles/aa/pdf/2001/46/aah3092.pdf>

Evidence for a Fermion Repelling New Physics Black Hole inside Herbig Haro (HH34) Bowshock ! Outflow Velocity differences between the leading black hole and the secondary Fermion plasma hotspots are the indication, according to Q-FFF Theory.

The black hole (O) has the smallest relative velocity. Conclusion: Secondary Fermionic plasma hotspots are repelled ! As predicted!

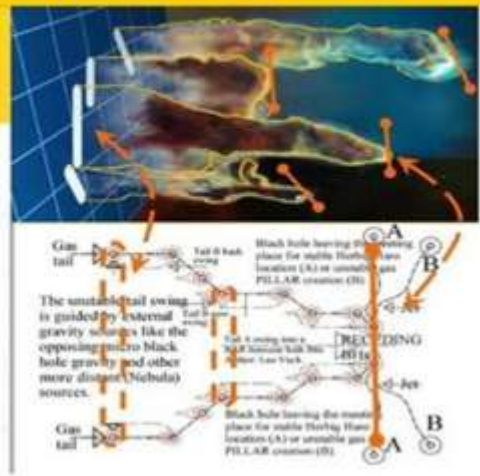
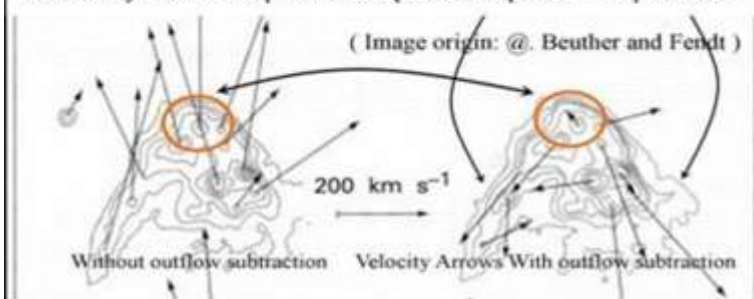
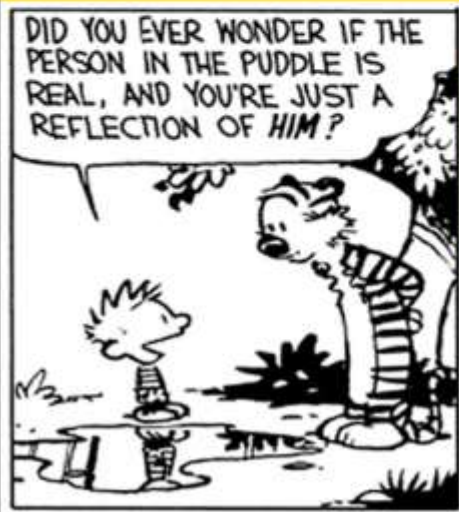

Figure 26,

# Schrödinger's cat paradox solved with Dual Anti Matter Copy Cats, living inside Entangled Raspberry Multiverse Bubbles.

Anti Matter deficit problem solved by the mirror symmetric Undivided Multiverse without dual Cats in boxes.



The Wavefunction collapse in the (CP symmetric) raspberry multiverse by the entangled observation between (anti) copy particles

According to Quantum FFF Theory, the collapse of the wavefunction is assumed to be triggered by particle collisions with instant entanglement between (anti-)COPY universes. So there is Charge and Parity symmetry between the entangled particles living in opposing universes. Each particle is its own observer!! Each human has to deal with one or more opposing anti-COPY humans.

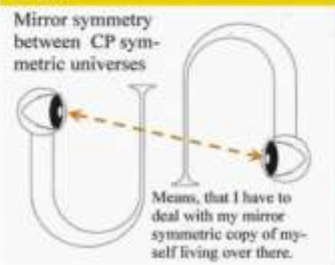

2-D Section through the raspberry multiverse, with large void in the middle. The void in the middle is required to be filled by the start of the Fermi process, when the vacuum density of the Fermi (anti) multiverse one still too high for a free particle to exist (see the body).

The Dodecahedron Raspberry Multiverse with a 5-fold neighbour Low Variance contact structure lead to a Golden Ratio ( $\Phi$ ) in every single universe according to Quantum FFF Theory (Function Follows Form)

Figure 27,

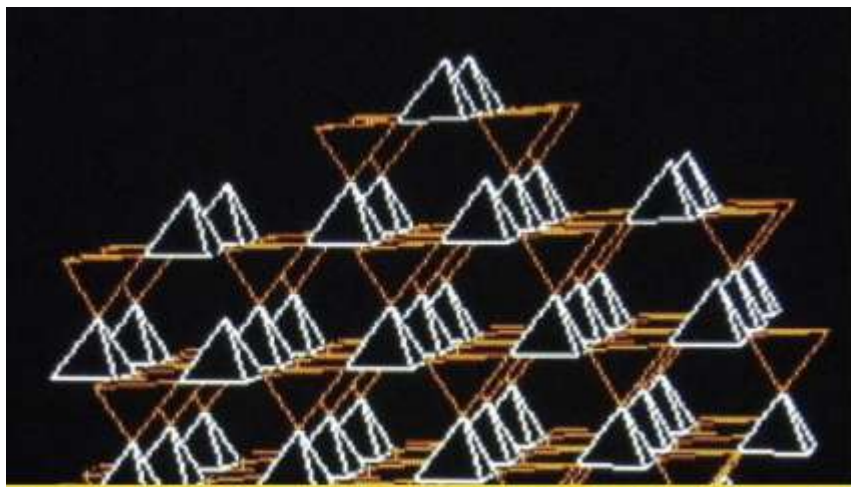

Truncated tetrahedron space according to the Quantum-FFF model. Each tetrahedron lattice has a spiral shape based on three linear units

3-D image of TWO tetrahedron space fill units with chiral, left or right handed characteristics, the origin of our material universe and our opposite anti-matter universe.

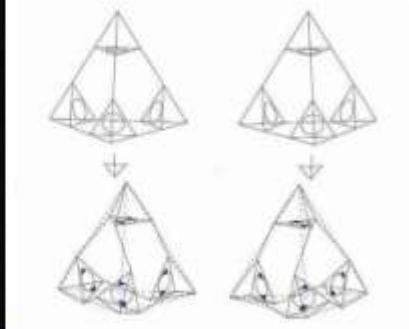

Space fill unit with RIGHT hand rotation. Space fill unit with LEFT hand rotation.

Figure 28,



# Anti Maxwell Magnetic Monopole Interference effect around a current in a wire, used for EM Drive.

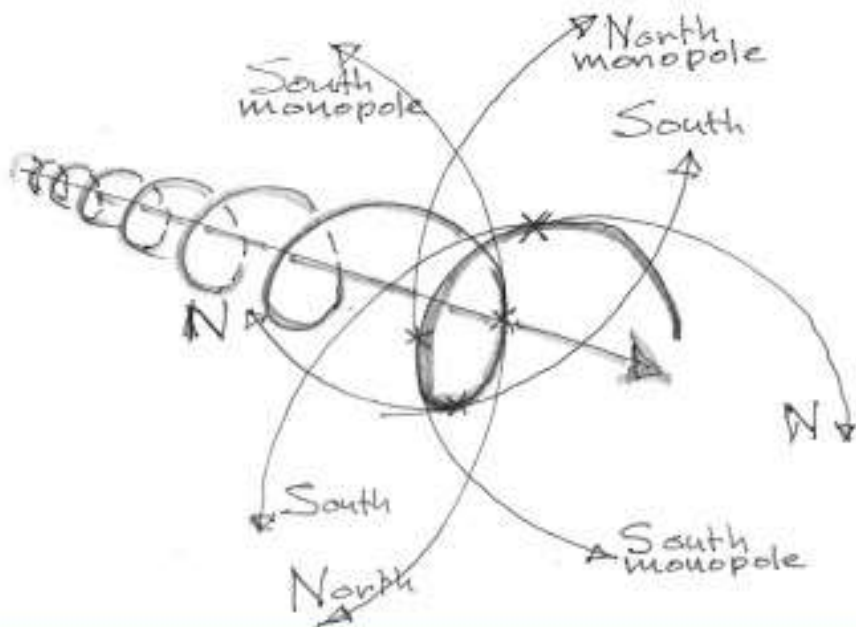

## Anti Gravity Propulsion (EM Drive)

A new physics Space Drive by the Interesting anti Maxwell dip-effect, according to Quantum FFF Theory.  
 see: <https://bigbang-entanglement.blogspot.com/2019/01/an-new-space-drive-by-impossible-anti.html>  
 and: <https://nationalufocenter.com/2019/05/filers-files-19-2019-uk-report-on-black-triangles/>  
 Ufo photos: White circles, seem to be Anti Maxwell dip-EM drives for levitation and piloting. Yellow circles seem to be landing vehicles.

### Em. Drive for Reaction Less Space Propulsion by New Physics Dual Anti-Maxwell Magnetic Monopole effect.

Explained by detail observation of iron powder distribution (the ring shaped absence) around a wire or coil. Below: Several observations and explanation by the curvature of monopole quantum information arrays.



Several observations and explanation by the curvature of monopole quantum information arrays.

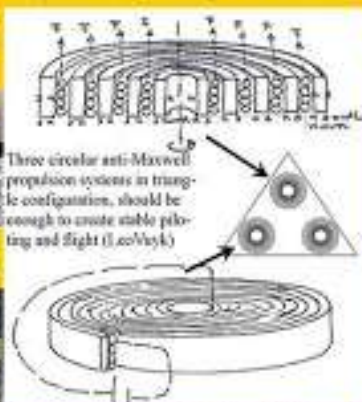

<http://visra.org/pdf/1605.0257v4.pdf>

"Quantum FFF Theory", as a base for new understanding of Anti-Maxwell magnetic field distribution around a wire. And reaction less propulsion.

### Triangle shaped UFOs.

White circles, seem to be Anti Maxwell dip-EM drives for levitation and piloting. Yellow circles seem to be landing vehicles.



Figure 29, Simple Anti gravity propulsion principle with magnetic metal band material and electric wires. For laboratory use.

# References:

Books: 1: The Physics of Rigid Transformer Strings. LuLu 2019. 2: The New God Particle and Free Will.

Author: Leo Vuyk, LuLu publishers, 2008. ISBN number 978-1-4092-1031-3

<http://www.lulu.com/spotlight/LeoVuyk> Quantum FFF Theory is also published in the form of POSTERS

at the Flickr site: <http://www.flickr.com/photos/93308747@N05/> Numbered listing (below: latest) of

Vixra essays by Leo Vuyk. [http://vixra.org/author/leo\\_vuyk](http://vixra.org/author/leo_vuyk)

[132] [viXra:2002.0094](#) Electric Birkeland Current Production Between Two Herbig Haro Black Holes or

[131] [viXra:2002.0074](#) 3-Dimensional Rigid Transformer Strings with Composite Topological Strings

[130] [viXra:2002.0073](#) The Origin of “Ultra Diffuse Galaxies” in Galaxy Cluster Centers and the Start Inside the Contracting Abell 520.

[129] [viXra:1911.0346](#) The Cyclic Undivided Raspberry Multiverse.

[128] [viXra:1909.0417](#) The Magic Fermion Repelling Stringy Fuzzball Black Hole, the Origin of a Cyclic Raspberry Multiverse.

[127] [viXra:1907.0250](#) The Conscious Readiness Potential Ratio Multiverse with Transactional Interpretation of J. Cramer.

[126] [viXra:1905.0244](#) EM Drive Thruster by Anti Maxwell Dual Monopole Tubular Interference Field Reduction Around a Conductor.

[125] [viXra:1905.0123](#) The Conscious Undivided Multiverse,

[124] [viXra:1904.0599](#) The Origin of Universal Structure: Herbig Haro -Electric Dark Matter Black Hole- Systems.

[123] [viXra:1903.0447](#) Black Hole Creation and Destruction of the Cyclic Conscious Multiverse.

[122] [viXra:1903.0347](#) Visualizing Subatomic Particles as Building Blocks of the Universe.

[121] [viXra:1903.0102](#) What Is Wrong With Physics?

[120] [viXra:1902.0349](#) The Electric Universe by Electric Dark Matter Big Bang Black Holes of Quantum FFF Theory.

[119] [viXra:1902.0201](#) Novel Ideas About Dark Matter and the SuSy Multiverse.

[118] [viXra:1901.0426](#) 4x and 3x Interference for Stringy Bose Einstein Black Hole Production.

[117] [viXra:1812.0228](#) Equal Sized Rigid String Based New Black Holes do not Merge But, Form Herbig Haro Systems.

[116] [viXra:1812.0095](#)  $E = not Mc^2$  in Massless Black Holes According to Quantum FFF Theory.

[115] [viXra:1811.0125](#) Testing Proposals for Human Free Will in the Raspberry Multiverse, Local Entanglement and M&M Lightspeed.

[114] [viXra:1811.0002](#) Big Bang Energy out of Nothing, or a Compressed Rigid String Nucleus

[113] [viXra:1809.0189](#) Apparent Violation of the Second Law, Around Black Hole Nuclei and Other Quantum Knots.

[112] [viXra:1807.0437](#) Preference for Dual Herbig Haro Black Hole Consumption by the Central MW Black Hole, Leaving Plasma Jets Behind.

[111] [viXra:1806.0368](#) A Fifth Force Vacuum Dipole Repeller, Needed to Create All Attraction Forces Even Around Black Holes in Quantum FFF Theory.

[110] [viXra:1806.0298](#) Expanding Earth, by Growing Water based Crashed Comet core.

[109] [viXra:1806.0068](#) Primordial Electric Dark Matter Black Holes Outside Galaxies Responsible for the Creation and Contraction of a Cyclic Multi-Universe.

[108] [viXra:1805.0541](#) Tidal Star Disruption Events (TDE) by Fermion Repelling Black Holes in Quantum FFF Theory.



[107] viXra:1805.0307 Fulgurite Created by Lightning Bullet Also Known as Ball Lightning, According to Quantum FFF Theory.

[106] viXra:1804.0138 Non Inertial Dark Matter Black Hole Galaxy Hierarchy According to Quantum FFF Theory.

[105] viXra:1803.0100 submitted Free Will Readiness Potential Ratios, the Key for a Multiverse Number Calculation.

[104] viXra:1803.0093 Skyrmion Interference Black Holes, Photonic Molecules, Ball Lightning, Micro Comets, Sprite-Fireballs and Sunspots According to Quantum FFF Theory.

[103] viXra:1801.0121 Quantum FFF Theory, a Conscious String Theory with Different Vacuum Trajectories for Axion-Higgs Field/ Photons Respectively Fermions, Gluons and Bosons.

[102] viXra:1711.0379 The Raspberry Shaped Multiverse, Pulsating Between Big Crunch and Big Bang, Based on Rigid Transformable Massless Axion Higgs Particles.

[101] viXra:1711.0327 The Einstein Cross Lensing Effect Explained by the Quadruple Dark Matter Formation Process of Edge-on Spiral Galaxies, According to Quantum FFF Theory.

[100] viXra:1711.0237 Higgs Particle Based SIMPs for Ancient and Future (Stone) Cutting Technology.

[99] viXra:1711.0112 Higgs Quantum Knots is Dark Matter is Black Holes or: Higgs Dark Matter Black Holes.

[98] viXra:1710.0257 Kilonova Merger Black Holes as the Origin of Dark Matter Black Hole Halo Population.

[97] viXra:1710.0115 Grand Unification of 4 Forces According to the Quantum FFF Model by di-Monopole Repeller Rigid String Pressure. [96] viXra:1710.0050 Emergent Gravity by Dipole Repeller Rigid String Pressure the Origin of Quantum Gravity and Non Inertial Black Holes. [95] viXra:1710.0034 The New Physics Black Hole Nucleus: Gravity Without Inertial Mass Effects. [94] viXra:1709.0396 Dual Solar Anchor Black Holes or Herbig Haro Hotspots, the Origin of Quick Star Formation. [93] viXra:1709.0388 Splitting Dark Matter Black Hole Big Bang as the Origin of UltraEnergetic-Cosmic-Rays-From Far-Away [92] viXra:1709.0216 Photonic Molecule based Higgs Photonic Knots of Different Masses the Origin of Future Lightsaber use? [91] viXra:1708.0296 The Origin of “Ultra Diffuse Galaxies” in Galaxy Cluster Centers. [90] viXra:1708.0170 Action Without Reaction Symmetry for em Space Propulsion Thruster Technology. [89] viXra:1708.0083 Dipole Repeller Gravity Effects at Different Universal Scales as the Origin of Large Scale and Local Quantum Gravity and Hubble Redshift. [88] viXra:1707.0224 The Magic of the New Electric Dark Matter Black Hole on Earth and Space. [87] viXra:1707.0189 Black Hole Nuclei as a Bunch of Rigid Transformable Higgs Strings Splitting by Relative Small Companion Mergers or Decreased Vacuum Pressure. [86] viXra:1706.0490 The Origin of “Dead” Galaxies. [85] viXra:1706.0420 Mass in Motion According to Quantum FFF Theory. [84] viXra:1706.0413 Magnetic Monopole Test to Demonstrate the Existence of a Anti Maxwell Dead Zone Around a Current in a Wire. [83] viXra:1705.0153 A Different Black Hole Horizon Interpretation Leading to Entropy Reduction and Violation of the Second Law. [82] viXra:1705.0026 The Magic of Life- and Matter Creating Self Propelled Electric Dark Matter Black Holes Guided by a Holographic Entangled Symmetric Multiverse System. [81] viXra:1704.0272 Interference Black Holes, Ball Lightning, Micro Comets, Sprite Fireballs and Sunspots According to Quantum FFF Theory. [80] viXra:1704.0150 The Origin of Life and the Need for a Rigid String Propeller Fermion Model Combined with a Chiral Vacuum Lattice and Micro Interference Black Holes [79] viXra:1704.0133 2. Signals for Retarded Single Big Bang Black Hole Nucleus Splitting and Pairing into Dual Black Hole Herbig Haro Systems [78] viXra:1704.0047 Bohmian Double Slit Interpretation by Dual Entangled Universes, and the Benjamin Libet Experiment. [77] viXra:1704.0003 A Testable CP Symmetric Multiverse Model by Extended Experiments, Done by the Late Benjamin Libet in 1964. [76] viXra:1702.0109 CP Symmetry Between

Material and Anti Material Copy Universes Combined with Local- and Multi-Universal Cycle Time. [75] viXra:1702.0040 The Alternative Origin of Hubble Redshift : Vacuum Absorption by black holes as a Support for Quantum Dipole Repeller Gravity and a Contracting Universe. [74] viXra:1701.0633 Local and Multi-Universal Cycle Time According to Quantum FFF Theory. (FFF= Function Follows Form) 17 [73] viXra:1612.0365 John S. Bell Was Right: “How to Teach Special Relativity” and Atomic Pear Shaped Contraction. [72] viXra:1612.0026 Democratic Free Will and Telepathy in the Instant Entangled [71] viXra:1611.0226 Galaxy Cluster Merging and Vacuum Absorption by black holes as a Support for Quantum Dipole Repeller Gravity and a Contracting Universe. [70] viXra:1611.0101 Observed Dual Higgs Mass 124-126 Gev and the Chirality of the Vacuum Lattice. [69] viXra:1611.0031 Rigid String Cosmology with a Massless Axion-Higgs Oscillating Photon Vacuum Lattice and Massive Quantum Knots. [68] viXra:1611.0005 Electric Dark Matter Black Holes in the Moon (Orientele Basin) [67] viXra:1609.0407 New Physics Elements in the Quantum Function Follows Form Model. [66] viXra:1608.0329 God Seems to Play Dice with Dual Entangled Pinball Machines in a Super symmetric (Susy) Multiverse [65] viXra:1607.0376 Axion-Higgs 3-Dimensional Rigid Transformable Strings and the Compound 650 GeV Z-Z Decay into Quarks/Lepto quarks. [64] viXra:1605.0257 Reaction Less Drive by Anti Maxwell Dead Zone Around a Wire. [63] viXra:1604.0372 Herbig Haro Hotspots or Bow shocks Are the Origin of Star Formation, not the Result as the Mainstream Suggest. [62] viXra:1604.0229 Er=epr in the Super symmetric Cyclic Multiverse and in the Lab Without Strange Cats. [59] viXra:1505.0101 The Origin of Bok Globules and Molecular Clouds, Splitting and Pairing Electric Dark Matter Black Holes. [58] viXra:1503.0186 Primordial Dark Matter Black Holes Outside Galaxies Responsible for the Creation and Contraction of a Cyclic Universe? 22 [57] viXra:1503.0097 Quantum FFF Theory, Poster News 4.2 [56] viXra:1502.0086 Parity and Chirality as a Base for Quark-Gluon Plasma and Dust Creating Black Holes and the Beginning and End of Time.. [55] viXra:1411.0039 Quantum FFF Theory, Poster News 2 [54] viXra:1410.0039 Evidence for Dark Matter Black Hole Based Plasma, Dust and Ice Production Inside Comets Like 67P,C-G. and the Growing Earth. [53] viXra:1409.0164 The O’Connell Effect in Eclipsing Binaries Explained by Mass Related Light Speed Extinction Distances (Lasof) of Stars and Even Planets. (See also figure 29) [52] viXra:1407.0001 Evidence for Evaporating Dark Matter Particles in Silicon Fireballs. [51] viXra:1406.0076 Galaxy Formation and Evolution According to Quantum FFF Theory. [50] viXra:1406.0019 Quantum FFF Theory Proposals for Some Unsolved Physics Problems. [49] viXra:1405.0224 Dual Star Ejection in Open Star Clusters by the Central Star. [48] viXra:1404.0151 Future Free Energy of New Physics Ball Lightning Black Holes, the Origin of a Super Social Society or the Opposite? [47] viXra:1404.0002 Proposal for the Origin of Unexpected Large B-Modes Found in the Bicep2 Measurements. [46] viXra:1402.0132 Reconciliation of GR and QM by a New Gravity-Black Hole and Lightspeed Model Called Quantum- FFF Theory. [45] viXra:1402.0044 The Impossible Zero Point Electric Black Hole as the Origin of New Physics even for Comets like 67P,C-G. [44] viXra:1401.0115 Calabi Yau Shaped Double Fermion Spin States. [43] viXra:1401.0071 Democratic Free Will in the Instant Entangled Multiverse. [42] viXra:1312.0143 The Navel Cord Multiverse with Raspberry Shape, a Super Symmetric

Entangled 12 Fold Bubble Universe. [41] viXra:1312.0076 Are Sunspots Made of Gravitating Dark Matter Black Holes? [40] viXra:1310.0101 The New Nuclear Magic Number (34) Explained by the Polar Coaxial Ring System of Quantum FFF Theory. [39] viXra:1310.0059 The Semi Relativistic Higgs Field Aether with Mass Related Lightspeed Adaptation. [38] viXra:1309.0081 New Physics by Table Top Experiments. [37] viXra:1308.0083 23 The Raspberry Shaped Super Symmetric Multiverse [36] viXra:1307.0068 Quantum Function Follows Form Theory, the Small Scale, Posters part 1. [35] viXra:1307.0067 Quantum Function Follows Form Theory, the Large Scale, Posters part 2. [34] viXra:1306.0218) Dark Matter UFO Dust Particles or Quantum Knots in the LHC at CERN ? 33,



viXra:1306.0065 The Splitting Dark Matter- Black Hole- Big Bang and the Cyclic Multiverse. 32,  
viXra:1305.0140 Quantum FFF Theory Experiments, a Summary. 31, viXra:1305.0041 The Shnoll Effect  
Explained by Quantum FFF Theory. 30, viXra:1304.0022 The Self Organizing Universe in the Carina  
Nebula. 29, viXra:1303.0211 Hubble Redshift Combined with Universal Contraction is Possible. 28,  
viXra:1303.0053 Micro Birkeland Currents Between Two RF Generated Plasma Balls in the Laboratory.  
27, viXra:1302.0172 Silicon Based Ball Lightning Globule Structures and Signs for Accumulation and  
Retarded Decrease of Tunneling Energy Bullets. 26, viXra:1301.0088 Two or Three Large Quasar Groups  
(LQGs) Located at the Start of Two or Three Lyman Alpha Systems and a Part of the Raspberry  
Multiverse? 25, viXra:1301.0050 Dwarf Galaxies and Their Relation with Dark Matter Based Galaxy  
Anchor Black Holes (Gabhs). 24, viXra:1210.0177 Instant Broglie Bohm Pilot Waves, the Origin of All  
Entanglement Effects in the Lab and Wavefunction Collapses in Our Universe as Related to Our Opposing  
Anti-Copy Universe(s) According to Quantum FFF Theory. 23, viXra:1209.0092 New Dark Matter Black  
Holes and a New Dark Energy Higgs Field, Lead to a Bouncing CP Symmetrical Multiverse, and New  
Experiments. 22, viXra:1209.0061 Birkeland Currents, Sunspots, Comets and Ball Lightning Originated  
by New Paradigm Dark Matter Black Holes. 21, viXra:1209.0030 Majorana and Sterile Neutrino  
Solutions in the Quantum-FFF Model. 20, viXra:1208.0031 Clumpy Dark Matter Around Dwarf Galaxies  
a Support for an Alternative Black Hole Theory According to the Quantum Function Follows Form  
Model. 19, viXra:1202.0091 Earth Magnetic Monopole Array Field Interaction with Cyclotron –  
Synchrotron Electrons and Muon Conversion Used for Levitation Systems. 18, viXra:1201.0092 Earth  
Magnetic Monopole Array Field Interaction with Cyclotron Electrons used for Levitation Systems. 17,  
viXra:1112.0065 24 LHC Signals Between 121-130 GeV Interpreted with Quantum-FFF Theory 16,  
viXra:1111.0096 Reconciliation of QM and GR and the Need for a Pulsating Entangled CPT Symmetric  
Raspberry Shaped Multiverse. 15, viXra:1111.0061 Black Hole Horizon Curvature Dependent Balance  
Between Plasma Creation and e-e+ Annihilation in Quantum FFF Theory. 19 14, viXra:1108.0036  
Artificial Ball Lightning Production and Exploitation Device for Zero Point Electric Energy Usage. 13,  
viXra:1108.0006 Mass in Motion in Quantum FFF Theory 12, viXra:1104.0083 Quantum FFF Theory in  
Posters. 11, viXra:1104.0044 Ball Lightning, Micro Comets, Sprite-Fireballs and X-Ray/gamma Flashes  
According to Quantum FFF Theory. 10, viXra:1104.0002 Stellar Anchor Black Holes as the Remnants of  
Former Herbig Haro Objects 9, viXra:1103.0097 ZPE Zero Point Energy Examples Around Black Holes.  
8, viXra:1103.0068 Function Follows Form, at the Quantum Scale and Beyond. 7, viXra:1103.0024  
Quantum Gravity and Electro Magnetic Forces in FFF Theory 6, viXra:1103.0015 Wavefunction Collapse  
and Human Choice-Making Inside an Entangled Mirror Symmetrical Multiverse. 5, viXra:1103.0011 An  
Alternative Black Hole, Provided with Entropy Decrease and Plasma Creation 4, viXra:1103.0002 3-  
Dimensional String Based Alternative Particles Model 3, viXra:1102.0056 Experiments to Determine the  
Mass Related Lightspeed Extinction Volume around massive objects. 2, viXra:1102.0054 Atomic Nuclear  
Geometry Based on Magic Number Logic. 1, viXra:1102.0052 Construction Principles for Chiral “atoms  
of Spacetim”=====