

The Fermion Repelling String Black Hole, the origin of a Cyclic Raspberry Multiverse?

Leo Vuyk,
Architect,
Rotterdam, the Netherlands.

Abstract,

This consciousness theory of everything, also called Quantum FFF Theory, (FFF = Function Follows Form) is a semi classical theory based on a symmetrical Big Bang into 8 or 12 Charge Parity (CP) symmetric copy universes.

However such a cyclic multiverse seems to be only possible with special ingredients,

1: a propeller shaped fermion able transform by collision and spin in two pitch directions.

2: A fermion knot based dark matter black hole of enough rigid string content, to become stable against the fierce oscillations of the oscillating vacuum lattice and repelling all spinning Fermions. but not other black hole nuclei or photons.

As a result, The Quantum FFF Theory is a semi classical theory because it describes reality by the real collision and shape transformation processes of real sub quantum rigid stringy multiverse entangled particles.

Each particle is supposed to be conscious by its entanglement with 8 or 12 CP symmetric copy particles located inside 8 or 12 Charge Parity (CP) symmetric universal bubbles at long distance in raspberry shape.

Those particles are supposed to be based on only one original transformable ring shaped massless virgin particle called the Axion/Higgs particle assumed to be the product of the symmetric cyclic big bang nucleus as the creation of one symmetrical raspberry shaped multiverse equipped with an even number of material and anti material universal bubbles.

The Quantum FFF theory is called Semi classical because in addition to the ring shaped transformable rigid string particles, all universal bubbles are assumed to be each others Charge Parity (CP) mirror symmetric universal bubbles which are assumed to be instant entangled down to each individual string particle created out of the Axion Higgs splitting cold Big Bang.

The sheer simplicity of such a system is perhaps the reason that I could not find comparable proposals for such consciousness theories of everything.

David Bohm suggested in the "Copenhagen interpretation", that reality is not created by the eye of the human observer, and second: elementary particles should be "guided by a pilot wave" inside an "UNDIVIDED UNIVERSE"

In this Quantum-FFF Theory translated into: an "UNDIVIDED MULTIVERSE" with multi universal instant entanglement between CP symmetric mirror strings)

The Nucleus of the Rigid String Knotty
Black Hole, compressed and growing
by the Axion Higgs vacuum.
(According to Quantum FFF Theory)



A ball of stringy particles, compressed by the energy of the oscillating Axion Higgs particle based vacuum lattice= (Casimir) Dark Energy.

The BH nucleus itself is Dark Matter.

Conclusion: all stable BH nuclei represent all Dark Matter in the universe.

Non stable evaporating BH nuclei can be called Ball Lightning or micro comets.

The boundary between these two types is unknown.

Figure 1 The nucleus of a very small and unstable black hole like an unstable ball lightning.

Introduction.

According to Quantum FFF Theory, (Function Follows Form at the quantum scale) Mass is the potency of rigid string based Fermions and Bosons, to produce and radiate Gravitons by the collision process, between mass less but energetic oscillating transformable Axion Higgs vacuum field particles and.. more complex shaped compound Fermions or Bosons (W + Z+Higgs family).

Gravity is assumed to be the statistical result of local dual opposing graviton pressure (instead of attraction) with opposing Axion Higgs field particles on fermions.

A recent example of local vacuum pressure duality is called "Dipole Repeller" gravity by Yehuda Hoffman also suggested partly in line as Emergent Gravity by E. Verlinde.

More extended loops or "arms" of each rigid string particle is supposed to create more Axion transformation into Gravitons photons per Planck time unit.

Secondly, gravitons are assumed to exert not an attraction force on fermions and bosons but only a reduced pressure force in opposition to the vacuum pressure of the Axion Higgs field..

Black holes do not radiate gravitons but "eat" the local vacuum particles leading to a single repeller effect on the growing Black hole nucleus.

The ring shaped Axion Higgs field particles are supposed to oscillate in tandem (as the boxer engine pistons) along each vacuum lattice with the local Planck length and transfer information of monopole photons through the whole universe as long as they do not collide with fermions or bosons.

The new physics black hole nucleus is represented as a compact quantum knot of Axion Higgs particles, compressed together by the inflow of vacuum particles.

As a consequence the incoming Axion Higgs field pressure is the only origin of the Gravity pressure effect around each black hole nucleus .

In Quantum FFF Theory, the inertial mass effects of the earth and all atomic fermions is supposed to be originated by the real Lorentz polarization of all fermionic mass of the earth mainly pointing into the direction of motion around the sun, as the opposing effort for the resisting vacuum.

Rigid string shaped Fermions are assumed to have a real propeller shape able to plow into the direction of motion through the local space time creating vacuum lattice.

Bosons without a propeller shape (Higgs and Z) including black hole nuclei, seem to be not able to polarize and will present signals to be "stuck" in the local solar centered vacuum lattice.

According to Quantum FFF Theory, the new black hole nucleus is represented as a bunch of rigid string particles compressed by the oscillating Axion Higgs field vacuum particles.

All Fermions should be repelled at a new physics Black Hole (BH) repelling horizon which is supposed to have concentric globular shells of positive (inside) or negative charge (outside)

As a result, each black hole is assumed to have a globular shell of positron and proton based plasma at the inside and a negative electron based plasma shell outside this positive shell.

If we include the existence of small interference black holes (or Quantum Knots or WIMPs) then Ball lightning and micro comets (including Comets and sunspots) are to be explained as micro black holes violating also the second law of thermodynamics.

The form and microstructure of elementary particles, is supposed to be the origin of functional differences between Higgs- Graviton- Photon and Fermion particles.

As a consequence of the quantum gravity difference on fermions and black hole nuclei, the new splitting, accelerating and pairing massless black hole, is able to convert vacuum energy (ZPE) into real energy by entropy decrease. This explains quick Galaxy- and Star formation, down to Sunspots, (Micro) Comets, Lightning bolts, Sprites and Elves, Sprite Fireballs and Ball Lightning according to quantum.

In Quantum FFF Theory, the inertial mass effects of the earth is supposed to be originated by the real Lorentz polarization of all fermionic mass of the earth, on average pointing into the direction of motion around the sun, as the opposing effort for the resisting vacuum.

Conclusion some Bosons (Higgs and Z particles) seem to be not able to polarize and will present signals to be more or less "stuck" in the local solar centered vacuum lattice.

The LHC could perhaps be able to show this anti inertial mass effect created by the solar reference frame also called solar LASOF (Local Oscillating vacuum Frame,
 Secondly, Dark matter concentrations “stuck” in the middle of merger galaxies clusters is also supposed to be a smoking gun for non- inertial mass of dark matter black holes..
 Emergent gravity as proposed by E.Verlinde and Dipole Rrepeller gravity by Yehuda Hoffman, (fig 5) are in line with dual rigid string pressure gravity on fermions and bosons.

General description of the Quantum-FFF model.

It is assumed that the vacuum is seeded with massive numbers of massless Axion-Higgs (A-Higgs) particles, all energetic oscillating inside a chiral vacuum lattice system and as such the origin and bearer of all energy in the universe.

If by a local energy excess, two A-Higgs particles collide with enough energy, it is assumed that an electron and positron emerges by internal hinge transformation.

Due to the propeller shape of the Fermions, these Fermions are assumed to spin by a constant collision and scattering process with the Higgs vacuum, changing A-Higgs particles continuously into different forms of Photon or Gluons.

This collision scattering process is proposed to be the base for the “eigen energy” of Fermions.

Thus Fermions are constantly consuming and transforming vacuum particle energy into

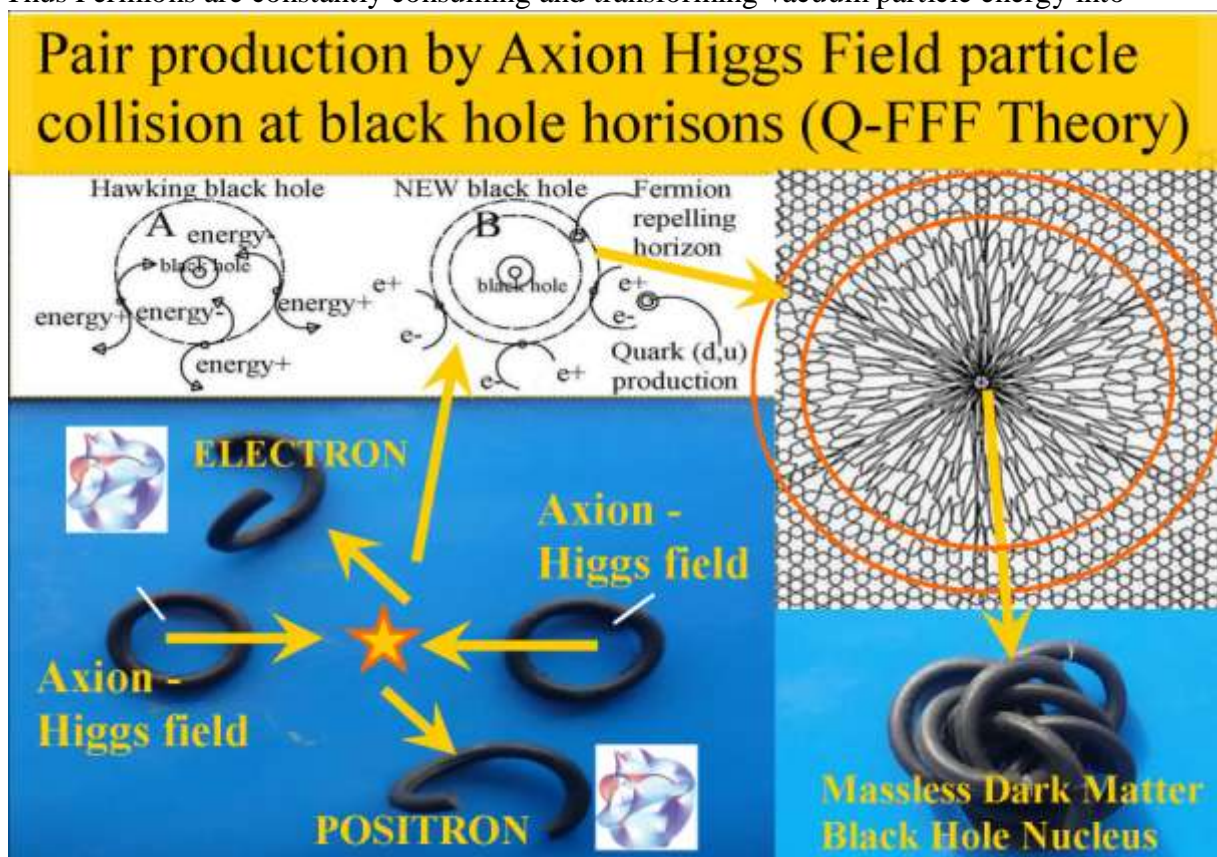

Figure 2, Pair production by Axion Higgs field collision at black hole horizons.

As a consequence, in Quantum FFF Theory photons should be the same as gluons and gluons become photons after collision with local fermions (atomic fermions) or after 1cm distance being absorbed by the local vacuum.

As a result, I suggest that many “elementary” (Quarks, Z and W) particles should not be elementary, but compound constructions or KNOTS of transformed A-Higgs particles. Even the Muon and Tau Lepton should be compound particles having the same shape as one of the different colored “naked” Down- respectively Charm Quarks. Thus, Muon- and Tau particles are supposed to be naked Quarks! Recent LHC (Large Hadron Collider) results are telling us that so called di-Higgs resonances lead to a variety of Higgs masses. In Quantum FFF Theory however the real building block of the universe should be only the Axion-Higgs vacuum particle without any mass.

The basic elements:

- 1: Black holes (BHs) are the same as Dark Matter, they all consume photons, even gravitons and the Axion-Higgs field, (for short: Higgs field) but REPEL Fermions due to their propeller shape polarization away from the BH. They produce electric charged plasma.
- 2: Dark Energy is the oscillating (Casimir) energy of the massless Axion-Higgs Field equipped with a tetrahedron lattice structure with variable Planck length around black holes..
- 3: Quantum Gravity = Dual Push gravity= Attraction (Higgs-Casimir opposing Graviton push).
- 4: The Big Bang is a Splitting dark matter Big Bang Black Hole (BBBH), splitting into smaller Primordial Big Bang Splinters (PBBS) forming the Fractal Lyman Alpha forest and evaporating partly into a zero mass energetic oscillating Higgs particle based Higgs field.
- 5: Dual PBBSs hotspots, produce central plasma concentration in electric Herbig Haro systems as a base for star formation in open star clusters as a start for Spiral Galaxies.
- 6: Spiral Galaxies will keep both Primordial Dark Matter Black Holes as Galaxy Anchor Black Holes (GABHs) at long distance.
- 7: After Galaxy Merging, these GABHs are the origin of Galaxy- and Magnetic field complexity and distant dwarf galaxies .
- 8: Black Holes produce Plasma direct out of the Higgs field because two rigid massless but mutable Higgs particles are convertible into symmetric electron and positron (or even dual quark-) propellers (by BH horizon fluctuations).
- 9: The chirality of the (spiraling) vacuum lattice is the origin our material universe. (propeller shaped positrons merge preferentially first with gluons to form (u) Quarks to form Hydrogen with electrons.
- 10: The first Supernovas produce medium sized Black Holes as the base for secondary Herbig Haro systems and open star clusters.
- 11: ALL Dark Matter Black Holes are supposed to be CHARGE SEPARATORS with internal positive charge and an external globular shell of negative charged Quark electron plasma.
- 12: The lightspeed is related to gravity fields like the earth with long extinction distances to adapt with the solar gravity field. (See the o’Connell effect, figure 29)
13. Quantum FFF Theory states that the raspberry shaped multiverse is symmetric and instant entangled by so called WORMHOLE BRIDGES (ER=EPR) down to the smallest quantum level between different raspberry berries=universes. Nonlocal entangled down to each quantum and even living or dying CATS in BOXES.
- 14 Large Primordial Big Bang Splinters (PBBS) are responsible for the creation of the Lyman Alpha forest structure and first spiral galaxy forming of the universe, but they seem to be also responsible for the implosion of the universe at the end in the form of Galaxy Anchor Black

Holes (GABHs) located mainly outside galaxies. see: (Quasisoft Chandra sources)

15, As a consequence of 12-14, Time is always local time in combination with cyclic period time of the multiverse.

16, If our material universes has a chiral left handed oscillating Higgs field, then our material Right Handed DNA helix molecule could be explained.
 However it also suggests that in our opposing symmetric ANTI-MATERIAL entangled neighbor universe the DNA helix should have a Left handed spiral.
 According to Max Tegmark: in an entangled multiverse we may ask: is there COPY PERSON over there, who is reading the same lines as I do?
 If this COPY person is indeed living over there, then even our consciousness should be shared in a sort of entangled DEMOCRATIC form.
 Then we are not alone with our thoughts and doubts,
 See also: “Democratic Free Will and Telepathy in the Instant Entangled Multiverse.”
<http://vixra.org/pdf/1612.0026v3.pdf>

17, All particles and waves should be entangled with anti-copy particles and Higgs field based waves in our opposing anti universes.
 Then wave particle duality and the so called one particle double slit interference could be explained by accepting that real shaped 3D photon particles only exist in their function of Gluons. However Gluons should transfer form information to the oscillating luminiferous Higgs field ether, within about 1 cm distance from a Fermion.(see: Babcock and Bergman anomaly,1964)

18, Different elementary particles have different qualities by their different complex stringy shape. Leptons and Quarks have a propeller shape with left or right handed pitch creating charge difference. Gluons, Photons and Neutrino particles have no pitch.

20 All particles can be converted to one or more Higgs particles, Lepto Quarks are also compound particles with an exception for the electron and positron..

21 All particles are assumed to be present as Axion-Higgs particles already in the cyclic Big Bang Black Hole (BBBH) after the former multiverse has collapsed into a Big Crunch Black Hole.

22, We seem to live inside one material universal bubble of an instant entangled (Charge Parity Time) CPT symmetric raspberry bubble multiverse. Each quantum jump or wave function collapse or human choice is guided by this instant entanglement at long distant.
 If our material universes has a chiral oscillating Higgs field, then our material Right Handed DNA helix molecule could be explained.
 However it also suggests that in our opposing ANTI-MATERIAL multiverse neighbour universe the DNA helix should have a LEFT HANDED spiral.
 According to Max Tegmark: in an entangled multiverse we may ask: is there COPY PERSON over there, who is reading the same lines as I do?
 If this COPY person is indeed living over there, then even our consciousness should be shared in a sort of DEMOCRATIC form,
 Then we are not alone with our thoughts and doubts, see:
 Democratic Free Will in the instant Entangled Multiverse.
 Conclusion, Quantum FFF Theory is based on Non-Local Realism. The CP(T)-symmetrical raspberry shaped multiverse (with 8-12 berries) is non local instant connected down to each quantum. Each quantum can be visualized as a deformed Axion-Higgs ring able to convert into other shapes and able to form compound structures like quarks, muons or even Tau leptons. So realism (cogwheels) connected by symmetric non-local instant entanglement.
vixra.org/pdf/1401.0071v2.pdf

5x historic references.

It was **Abdus Salam** who proposed that quarks and leptons should have a sub-quantum level structure, and that they are compound hardrock particles with a specific non-zero sized form. **Jean Paul Vigiér** postulated that quarks and leptons are "pushed around" by an energetic sea of vacuum particles.

David Bohm suggested in contrast with The "Copenhagen interpretation", that reality is not created by the eye of the human observer, and second: elementary particles should be "guided by a pilot wave" inside an "UNDIVIDED UNIVERSE" (in my Quantum-FFF Theory translated into: AN "UNDIVIDED MULTIVERSE" with multi universal instant entanglement between CP symmetric mirror strings)

John Bell argued that the motion of mass related to the surrounding vacuum reference frame, should originate real "Lorentz-transformations", and also real relativistic measurable contraction.

Richard Feynman postulated the idea of an all pervading energetic quantum vacuum. He rejected it, because it should originate resistance for every mass in motion, relative to the reference frame of the quantum vacuum.

However, I postulate the strange and counter intuitive possibility, that this resistance for mass in motion, can be compensated, if we combine the ideas of Vigiér, Bell, Bohm and Salam, and a new dual universal Bohmian "pilot wave", which is interpreted as the EPR correlation (or Big Bang entanglement) between individual elementary anti-mirror particles, living in dual universes.

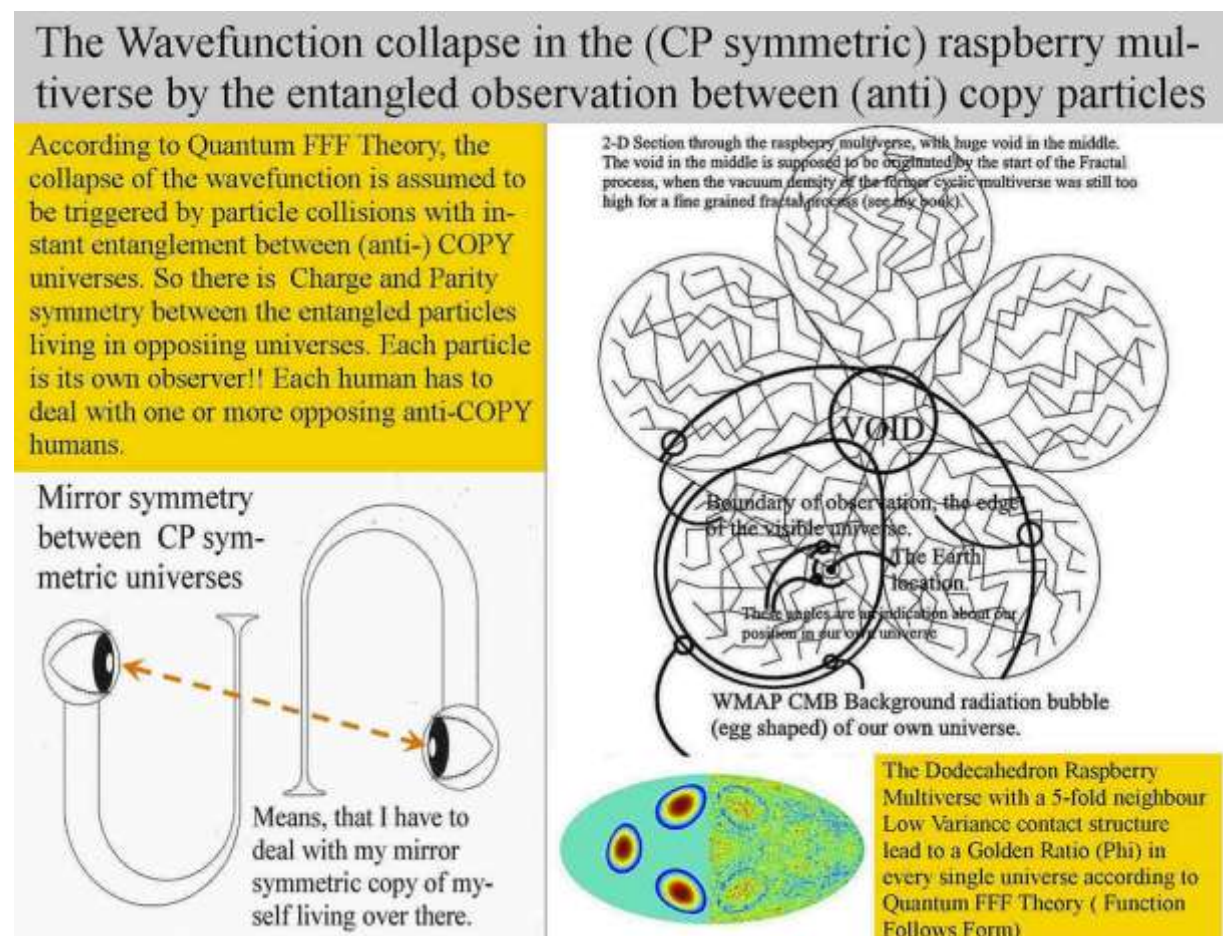

Figure 3, wavefunction collapse between CP symmetric mirror particles by instant entanglement between multi universal bubbles located around the Big Bang central void.

See also: "Democratic Free Will and Telepathy in the Instant Entangled Multiverse."
<http://vixra.org/pdf/1612.0026v3.pdf>

Feynman for Di-Monopole Repeller Forces

Attraction and Repulsion forces created by Dipole Repeller effects between the Higgs Field vacuum (OOO) and 5x opposing Photons. (UOU, ROU, LOU, ROR, LOL)

According to Quantum FFF Theory. Feynman diagrams

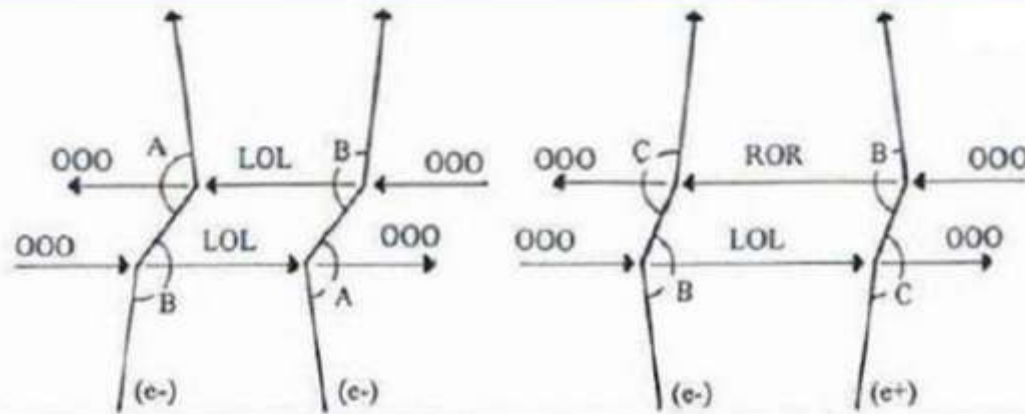

(Above) Alternative Feynman diagrams for electron-positron attraction and electron-electron repulsion by Dipole Repeller system.

Explanation of the codes:
 U= Up rotation (180 degrees)
 O= Unchanged circle
 L= Left rotation (90 degrees)
 R= Right rotation (90 degrees)

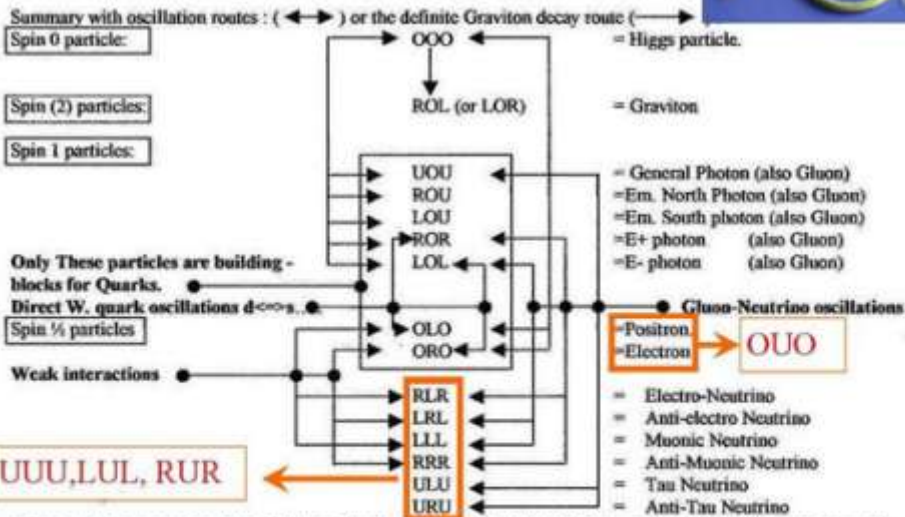
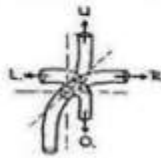

Higgs particles are supposed to oscillate in Tandem along so called linear Vacuum Lattices, two by two in opposite directions, as the symmetrical opposite pistons of a boxer engine, as the origin of all energy, spin and mass effects. This enables the Tandem Higgs particles to change the form of their own Torus into an Electron and Positron pair at

Figure 4. Feynman diagrams for di-monopole repeller forces. 5x monopole photons are also Gluons for the Strong Force.

Entropic or Emergent Gravity and Dipole Repeller Gravity seem to be Opposing Repeller Gravity of Axion Higgs field and Graviton pressure information.

According to Quantum FFF Theory, empty space is filled with a fast oscillating lattice of massless Axion-Higgs field particles as a half base for our opposing dipole pressure Higgs-graviton gravity on earth. Now prof. Yehuda Hoffman shows us a support for this hypothesis.

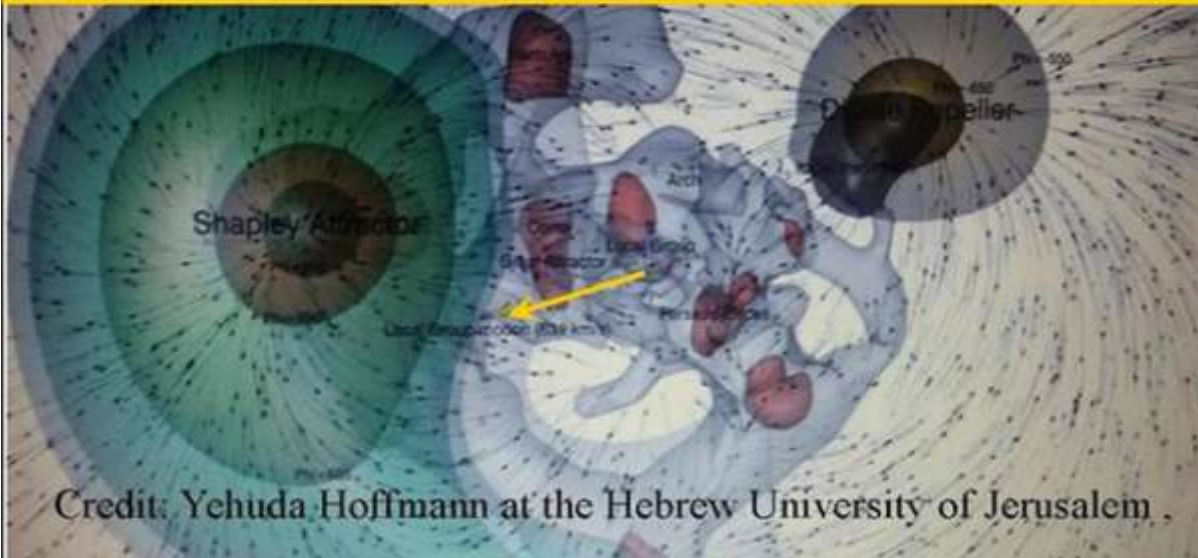

Quantum Gravity as pressure distribution of the oscillating dual Higgs/Graviton vector field

New Dark Matter Black Hole, "Eat" the chiral oscillating Higgs vacuum.(Quantum-FFF Theory)

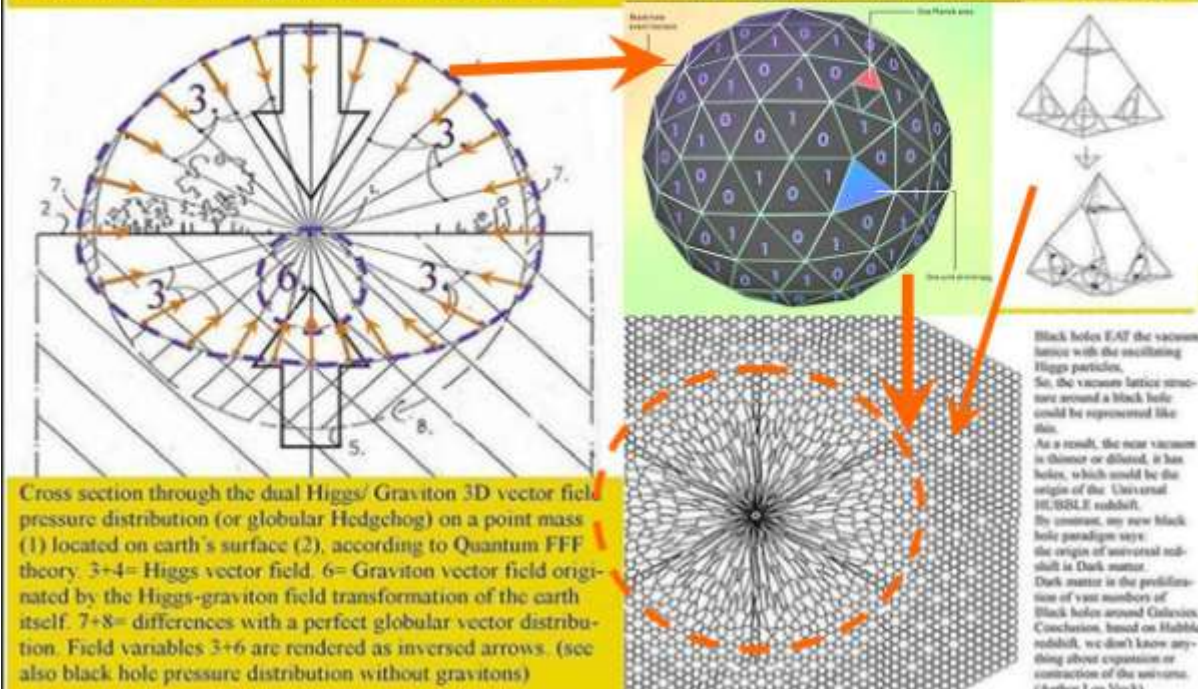

Figure 5. Di-monopole repeller gravity and or entropic emergent gravity combined. Yehuda Hoffmann and Erik Verlinde.

Black hole mass related merger dynamics.

6000 small S-Nova black holes in the Milky Way center (green spots below) is a support for the BH family distribution according to Quantum FFF Theory. (see right below). However Abell 520 cluster seems to centralize massive 1e and 2e Galaxy Anchor BHs (GABHs) in a DM core after merging of three clusters. (below left).

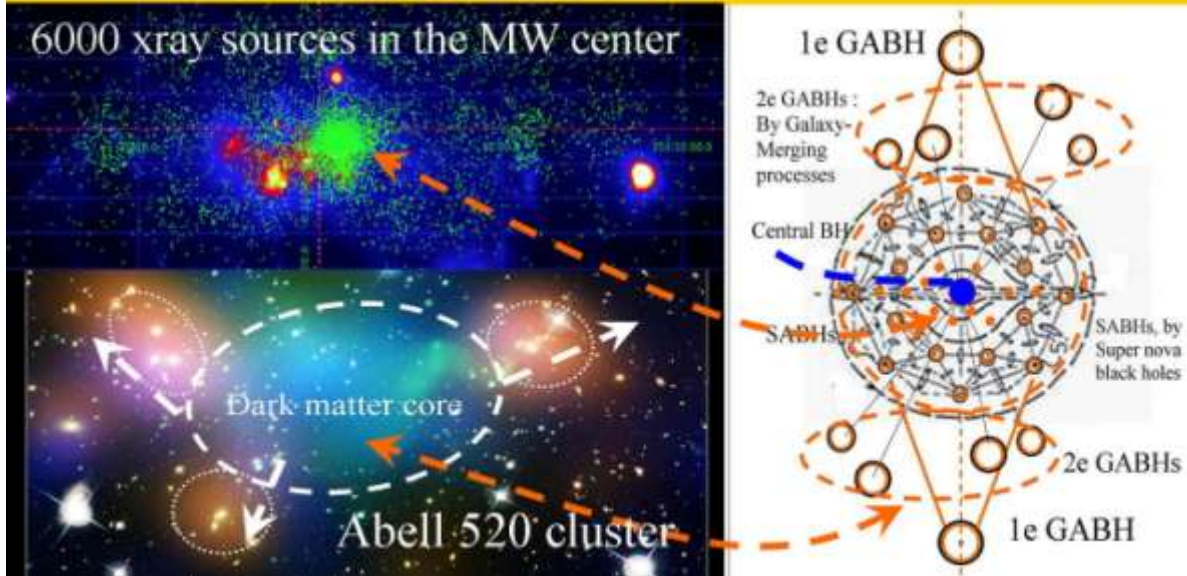

Figure 6, Merger dynamics of NON inertial Dark Matter black holes left behind after merging in the middle.

Examples of evaporating Photonic Molecules or Quantum Knots or Ball Lightning or Micro Comets .

Kugelblitz - hochaufgelöst / Ball lightning in high resolution.
 Max-Planck-Institut für Plasmaphysik (youtube 2014)
 As shown by the high-speed camera, first a surface discharge with thread-like plasma structures is generated.
 As is typical of hot gases rising, this changes into a mushroom-like form and finally into a luminous cloud. After about three blinks of an eyelash or 0.5 seconds the plasma vanishes. For further particulars:
<http://www.gpp.mpg.de/91359/kugelblitz>

The creation of MICRO-Electric Dark Matter Black Holes (quantum knots, falling down) by magnetic lightning interference, according to Quantum FFF Theory.



Figure 7, Microscopic Black Holes on Earth.

Rigid String based information building blocks with Fermion Calabi Yaw propellers (right) and Boson non propellers (left)

Rigid String Quantum Knot suggestions for different configuration: 125-375-500-750-1600 GeV and More called dark matter black holes. (According to Quantum FFF Theory architecture)

$125\text{GeV} + 375\text{GeV} = 500\text{GeV}$ And More

500GeV

$375\text{GeV} + 375\text{GeV} = 750\text{GeV}$

$2 \times 750\text{GeV} + 125 = 1625\text{GeV}$

6x Leptons Electron Muon Tau

6x UP quarks

6x CHARM quarks

6x DOWN quarks

6x BOTTOM quarks

6x STRANGE quarks

6x TOP quarks

Pair production by Axion Higgs Field particle collision at black hole horizons (Q-FFF Theory)

Hawking black hole

NEW black hole

Fermion repelling horizon

Quark (d,u) production

energy+

energy+

energy+

energy+

e^+

e^-

e^+

e^-

ELECTRON

POSITRON

Axion - Higgs field

Axion - Higgs field

Massless Dark Matter Black Hole Nucleus

Figure 8, Fermionic propeller shaped Quantum Knots (high up right) and Higgs Boson family based Quantum Knot-Black Hole (high up, left) and pair production around black holes.

No Fermion Information Loss in Black Holes by Fermion Repelling Horizon.

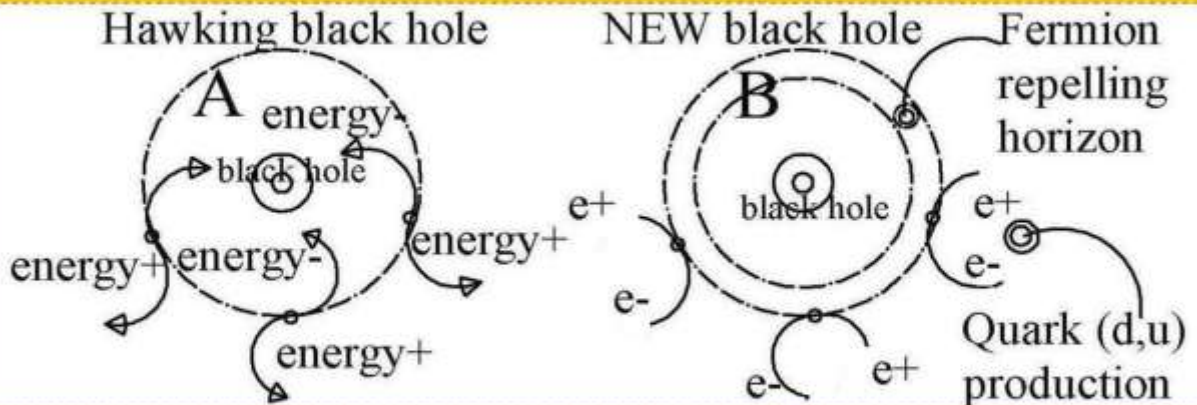

According to Quantum FFF Theory, there is no fermion information loss, only photonic information loss in a black hole. Quantum fluctuations around the BH horizon produce pairs of leptons, e^- , e^+ and even compound quarks (d,u, etc, see Fermion 3D string propeller theory: Fermion repelling by spin flip). For tripple BH horizons see image nrs 7, 10 and 11. Event horizon=7, Inner photon ring = 10, Outer photon ring = 11. Conclusion The Big Bang did not produce instantly all the Fermions in the universes. Even now lots of Fermions are produced by all BHs even the largest primordial Big bang splinters located outside large galaxies. see also: <<http://vixra.org/abs/1410.0039>

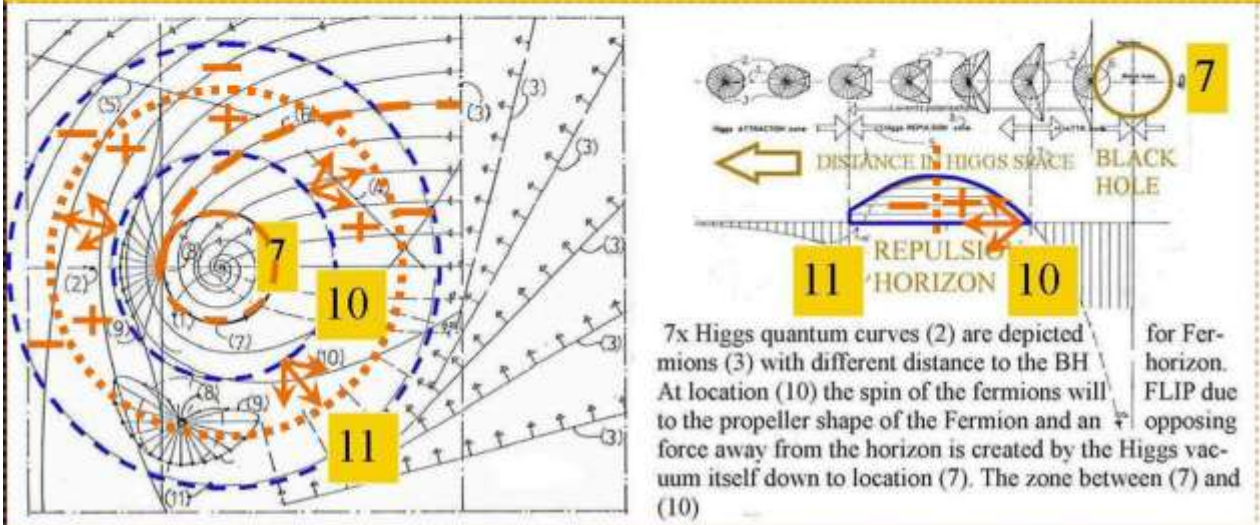
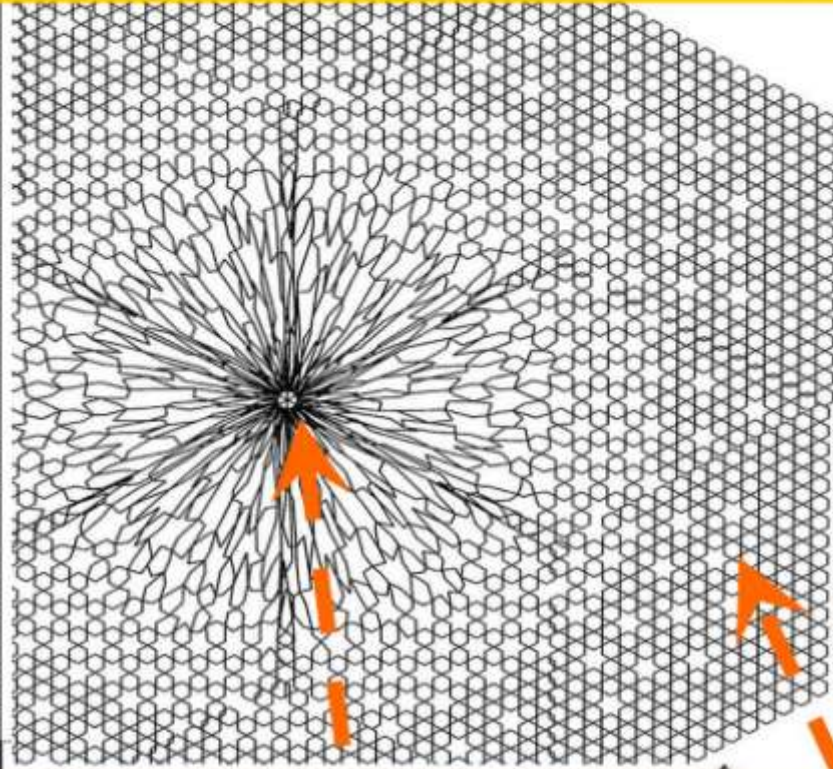

Figure 9, Electric Dark Matter Black Holes (EDMBHs) have a Fermion repelling horizon and are negative charged in our part of the multiverse.

Black Hole Nucleus is a Quantum Knot, evaporate or eat the local Axion-Higgs vacuum if it has large enough scale, (Quantum FFF Theory)



Black holes EAT the vacuum lattice with the oscillating Higgs particles. So, the vacuum lattice structure around a black hole could be represented like this. As a result, the near vacuum is thinner or diluted, it has holes, which could be the origin of the Universal HUBBLE redshift. By contrast, my new black hole paradigm says: the origin of universal redshift is Dark matter. Dark matter is the proliferation of vast numbers of Black holes around Galaxies. Conclusion, based on Hubble redshift, we don't know anything about expansion or contraction of the universe. (Author Leo Vuyk)

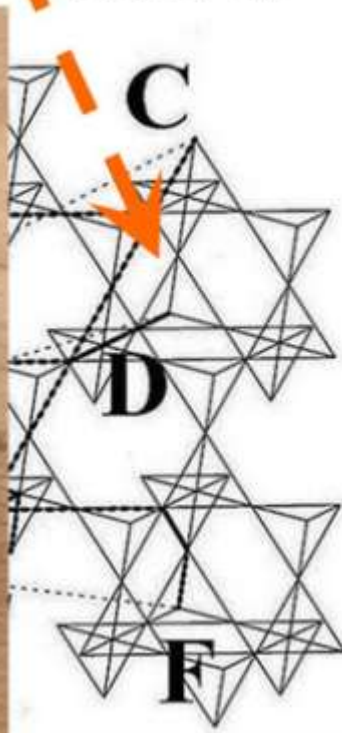

Figure 10, A stable black hole nucleus is large enough to “eat” the vacuum particles and grow by it.

Astronomical mysteries.

“One of the big mysteries of this object (B1509 “The hands of God”) is whether the pulsar Fermion particles are interacting with the material in a specific way to make it look like a hand (NASA)

In this paper I support the idea that the orange x-ray elements of B1509) represent a ring of star spot black holes ejected from the exploding star

The micro black hole ring looks as hotspots accelerating away, with the white Pulsar (white) far relocated by the different quantum vacuum gravity effects on Fermion matter and Black hole nuclear matter, assumed to be a bunch of Higgs string particles with resistance in space for motion through the oscillating vacuum lattice.

In Quantum FFF Theory, (Function Follows Form) black hole nuclei are assumed to be a bunch of massless rigid strings compressed by the surrounding oscillating Axion-Higgs vacuum lattice. Fermion mass however is assumed to be created by the ongoing interaction with the same surrounding oscillating vacuum lattice including the collision production of photon/gluons and gravitons. Black hole nuclei can move through the vacuum lattice only by the deformation of its horizon system by horizon deforming and repelled plasma tails observed in so called Tadpoles, often found inside nebula.

Fermionic mass like neutrons however feel the gravitational influence of the local vacuum lattice polarization and graviton influence of local Fermionic matter.

In the shape of “the hands of God” (B1509) we observe a clear relocation of the central Fermionic Neutron star (white) and the ejected elliptic star spot black hole system (orange).

This in contrast with black hole supernovas where we observe often a symmetric ring or globular shell nebula around the just formed central black hole.

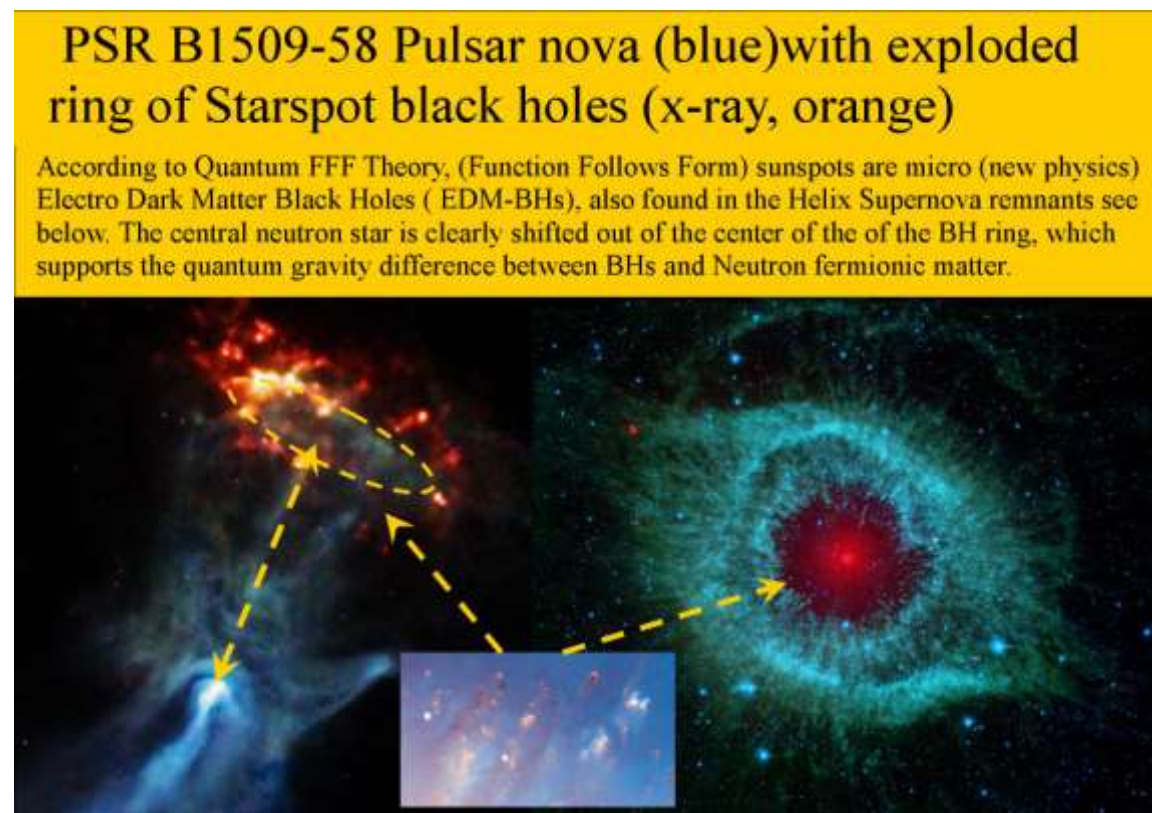

Figure 11, The A-symmetric B 1509-58 nebula , and symmetric Helix nebula as examples of the difference between Fermion and Black hole Quantum Gravity effects.

Multiple Horizons created around Supernova Black Holes.

Proposal for the relation between different S-Nova shapes and the external primordial black hole configuration called Herbig Haro hotspot or Stellar Anchor Black Holes (SABHs)

Different Super Nova shapes are created around two star types:
 A: Stars with distant "dual or quadrupole Stellar Anchor Black Holes" assumed to be located in the center of a former open star cluster. (SN1987, NGC2440, Crab Nebula)
 B: stars without SABHs. (SN1572) Our sun is equipped with two sunspot rings assumed to be of type A, with two SABHs, according to Quantum Function Follows Form Theory.

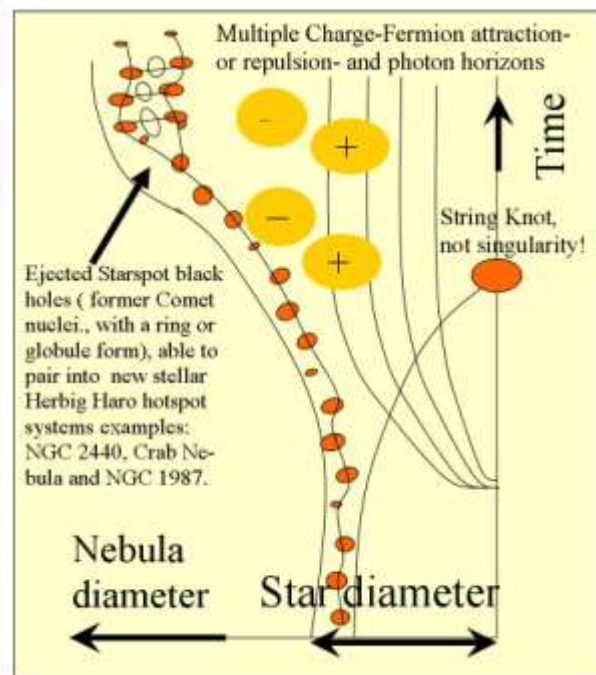
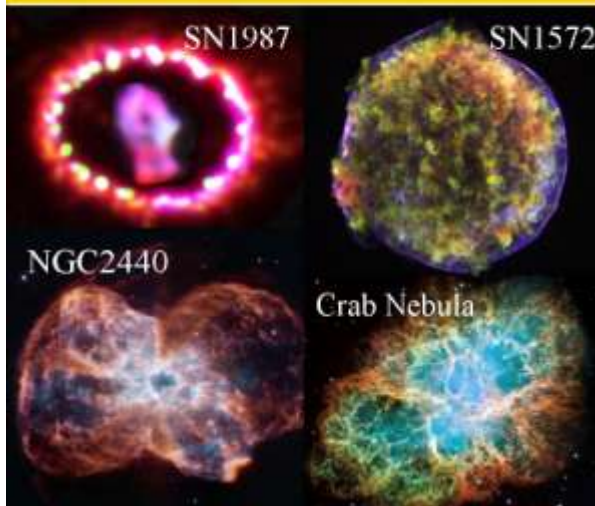

Figure 12, Other examples of Quantum Gravity effects on ejected rings of micro black hole starspots at work in different nebula .

New physics black holes.

Complex galaxy / star evolution seems to be not only created by galaxy or star merging, but even by central galaxy- and stellar mass black hole chopping into two equal parts to form black hole based Hotspots for Herbig Haro systems or even for Double Radio Galaxies.

This process is supposed to be the consequence of the new physics Electric Dark Matter Black Hole (EDM-BH) principle of Quantum FFF Theory (Function Follows Forms) and supported by observation of Triple Double Radio Galaxies and even by BH splitting in the Spire Eagle nebula. (Figure 13)

The EDM-BH is assumed to contain a real particle nucleus of so called Axion-Higgs rigid transformable strings , which are compressed together by the pressure of the oscillation Axion Higgs vacuum lattice. Even the Big Bang nucleus is assumed to contain only compressed Axion Higgs strings which could explode into splinters and dual vacuum particles by the reduced vacuum pressure around the Big Crunch nucleus of a former universe.

There seems to be a EDM- BH Ratio related black hole ability to merge (see LIGO) or split into Equal parts if the dual BH ratio is smaller than a LIGO BH ratio boundary which will be found in the future.

Until now, the smallest LIGO ratio is found to be: 1/ 1.9. (or 0.52: LIGO 2016), however future LIGO results could shift this boundary to lower ratios. (Figure 13)

As a consequence for increasing galaxy- and star complexity there is a need for different sized primordial dual black holes instead of two equal sized.

Consequently for the first star formation between the equal BH hotspots (bow shocks) of a Herbig Haro system , the equal nuclear mass/size ratio of both i black holes is important. (fig 12)
 Quasars such as Cygnus A are supposed to be a larger copies of a Herbig Haro system with larger BHs observed also as (radio) hotspots.

Markarian 231 seems to represent a large scale multiplying BH chopping system for symmetric so called Galaxy Anchor Black Hole (GABH) complexity, forming a Triple-Double lobed Radio Galaxy (TDRG).

The Spire nebula of the seems to show a more complex BH. splitting process. (Figure 13)
 For 3D rigid string particle models.

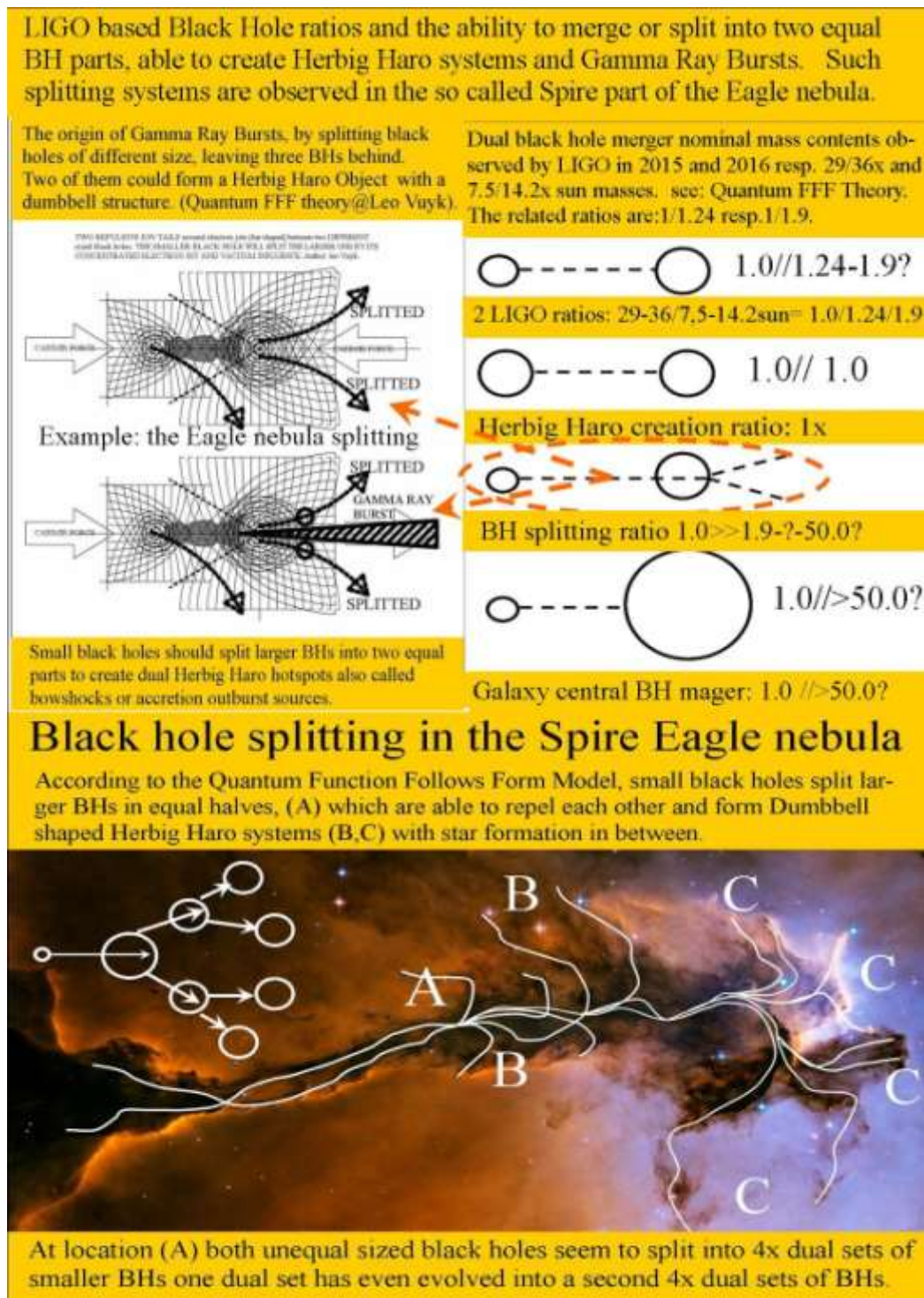
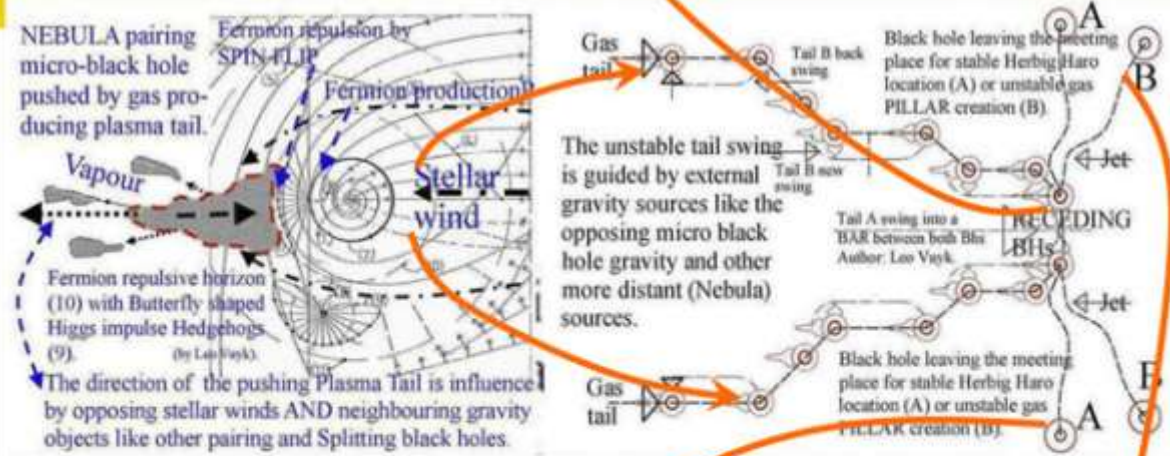

Figure 12, LIGO BH ratios and the BH multiplier splitting process in the Spire- Eagle nebula.

Markarian 231 as the Infant Stage of Cygnus-A Quasar. By EDM Black Hole



Markarian 231



EDM-BHs: Electric Dark Matter -Black Hole systems seem to be active at all scales.

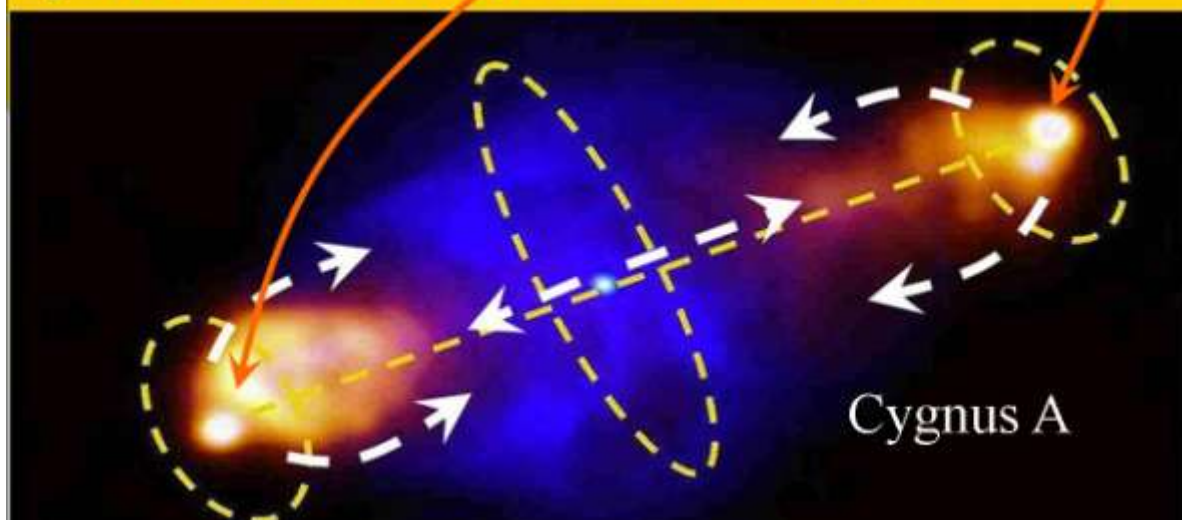
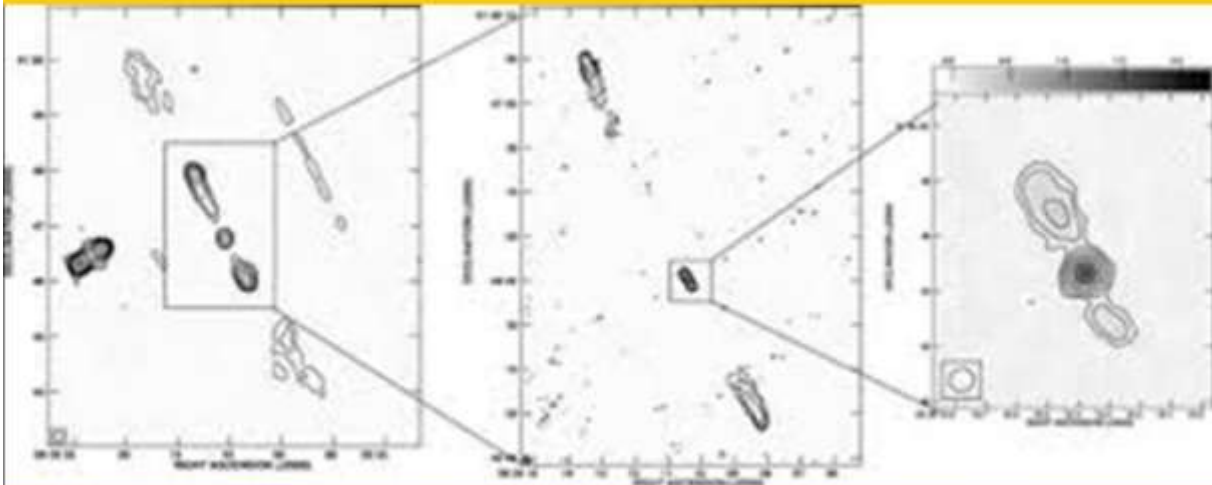

Figure 14. . the relation between Markarian 231 and other BH splitting systems

Black hole splitting as the origin of spiral Galaxies after a double or multiple lobed Quasar process.



In Quantum FFF theory, stars and galaxies need at least two new physics Electric Dark Matter Black Holes (EDMBHs) for a Herbig Haro system (or dual lobed Quasar). However multiple symmetric lobed systems seem also possible by a repeated central black hole splitting process.

LIGO based Black Hole ratios and the ability to merge or split into two equal BH parts, able to create Herbig Haro systems and Gamma Ray Bursts. Such splitting systems are observed in the so called Spire part of the Eagle nebula.

The origin of Gamma Ray Bursts, by splitting black holes of different size, leaving three BHs behind. Two of them could form a Herbig Haro Object with a dumbbell structure. (Quantum FFF theory@Leo Vuyk).

Dual black hole merger nominal mass contents observed by LIGO in 2015 and 2016 resp. 29/36x and 7.5/14.2x sun masses. see: Quantum FFF Theory. The related ratios are: 1/1.24 resp. 1/1.9.

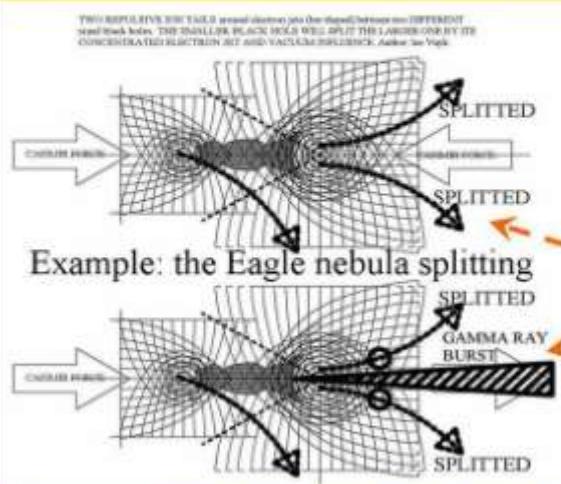

Small black holes should split larger BHs into two equal parts to create dual Herbig Haro hotspots also called bowshocks or accretion outburst sources.

$$\text{Small BH} \text{ --- } \text{Large BH} \text{ --- } \text{Large BH} \quad 1.0 // 1.24-1.9?$$

2 LIGO ratios: 29-36/7,5-14.2sun= 1.0/1.24/1.9

$$\text{Small BH} \text{ --- } \text{Large BH} \quad 1.0 // 1.0$$

Herbig Haro creation ratio: 1x

$$\text{Small BH} \text{ --- } \text{Large BH} \quad \text{BH splitting ratio } 1.0 \gg 1.9-?-50.0?$$

$$\text{Small BH} \text{ --- } \text{Large BH} \quad 1.0 // >50.0?$$

$$\text{Small BH} \text{ --- } \text{Large BH} \quad 1.0 // >50.0?$$

Galaxy central BH Merger: 1.0 // >50.0?

Figure 15, Markarian 231 at a larger scale with triple- double lobed radio sources.

Quantum FFF Theory effects.

According to Quantum FFF Theory, early Galaxies have growing potential by the number and size of external primordial dark matter black holes initially formed as big bang splinters able to pair into Quasars with star forming galaxies in between the so coined “Galaxy Anchor Black Holes” (GABHs) The galaxies can merge with other galaxy-systems into complex spirals and elliptical OR produce complexity by the BH splitting (chopping) process. Irregular galaxies and Dwarf galaxies are supposed to be the result of secondary star forming interaction between GABHs.

After Supernova black hole production these smaller black holes are able to pair as hotspots or “bow shocks” into new Herbig Haro systems,.

If no galaxy merger candidates are available in the neighborhood, or no BH ratio differences are able to split larger BHs into two halves for HH systems, then galaxy will soon reach a maximum size and die. (dead galaxies: figure 21)

Also according to Quantum FFF (Function Follows Form) Theory, all star forming molecular clouds are the result of one or more Herbig Haro systems, equipped with so called dual hotspots which are assumed to be the result of dual new physics “electric dark matter black holes” in contrast with general accepted black hole theories. As a consequence there is a great misconception in mainstream Astronomical theories.

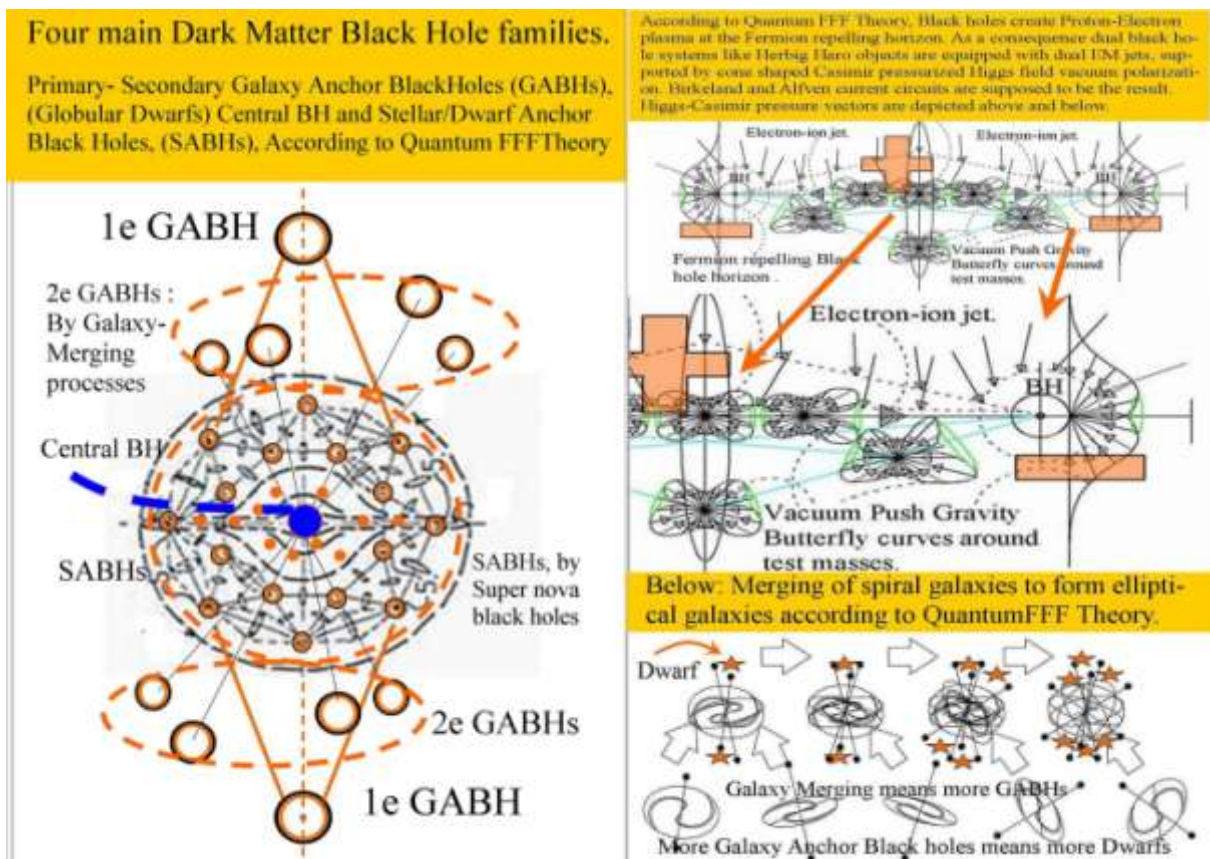

Figure 16, GABHs as the largest unit of Dark Matter black hole families

According to Quantum FFF Theory, the Big Bang can be described as the explosion of a giant Dark Matter Black Hole nucleus which is assumed to contain all the particles and smaller black hole nuclei of a former multiverse after a big crunch process.

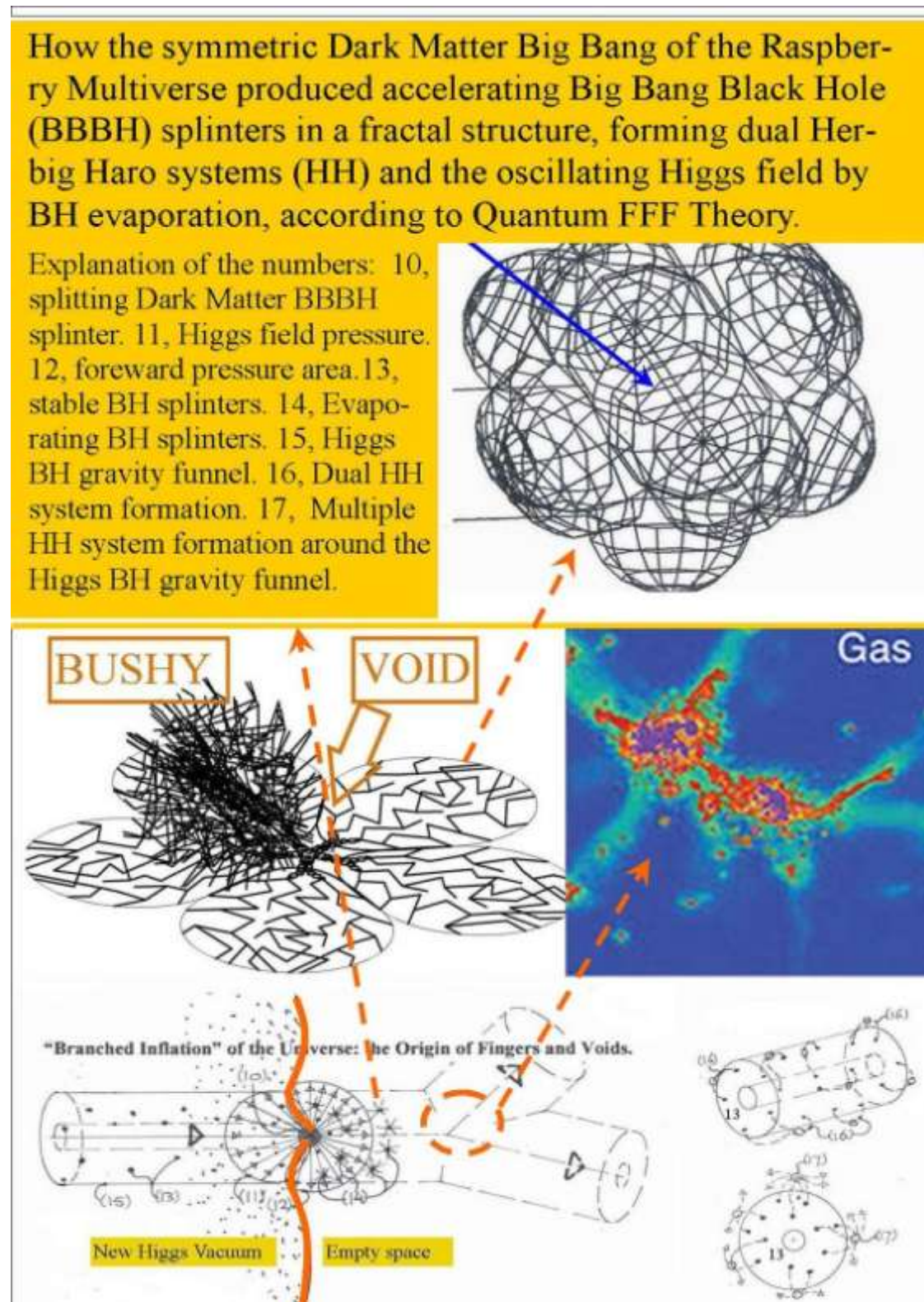

Figure 17, BBBH , the Big Bang Black Hole splintering into smaller BHs and evaporating into the oscillating Axion Higgs Vacuum lattice .

The Big Bang Inflation epoch.

In contrast with the standard inflation model, in Q-FFF Theory, the inflation is described as the splitting and evaporation process of the Dark Matter Big Bang Black Hole Nucleus.

The splitting travelling process is also a pairing process into Herbig Haro systems forming stars and galaxies along the Lyman Alpha forest.

The evaporation process is assumed to be responsible for the evaporation of single Axion Higgs field particles from the BB nucleus, to form the self energetic oscillating Vacuum lattice. (fig 17)

The smaller exploded black hole splinters (fig 19, 20) are assumed to be responsible for the fractal

structure of the universe by splitting in succession into smaller nuclei to pair and form huge primordial Herbig Haro systems (Quasars) with star and later galaxy formation in the middle between the stable paired equally sized hotspot black holes.

After supernova explosions of the large early giant stars, new black holes are formed which are supposed to be able to form smaller dual Herbig Haro systems by splitting processes.

By the ever reducing black hole nuclei als smaller star formation in between will be the standard process as a start for the internal structure of the spiral galaxy.

At the same time such a splitting and pairing process is assumed to happen at all scales in the current universe (entangled copy mirror multiverse) even down to molecular clouds and even inside Bok globules.

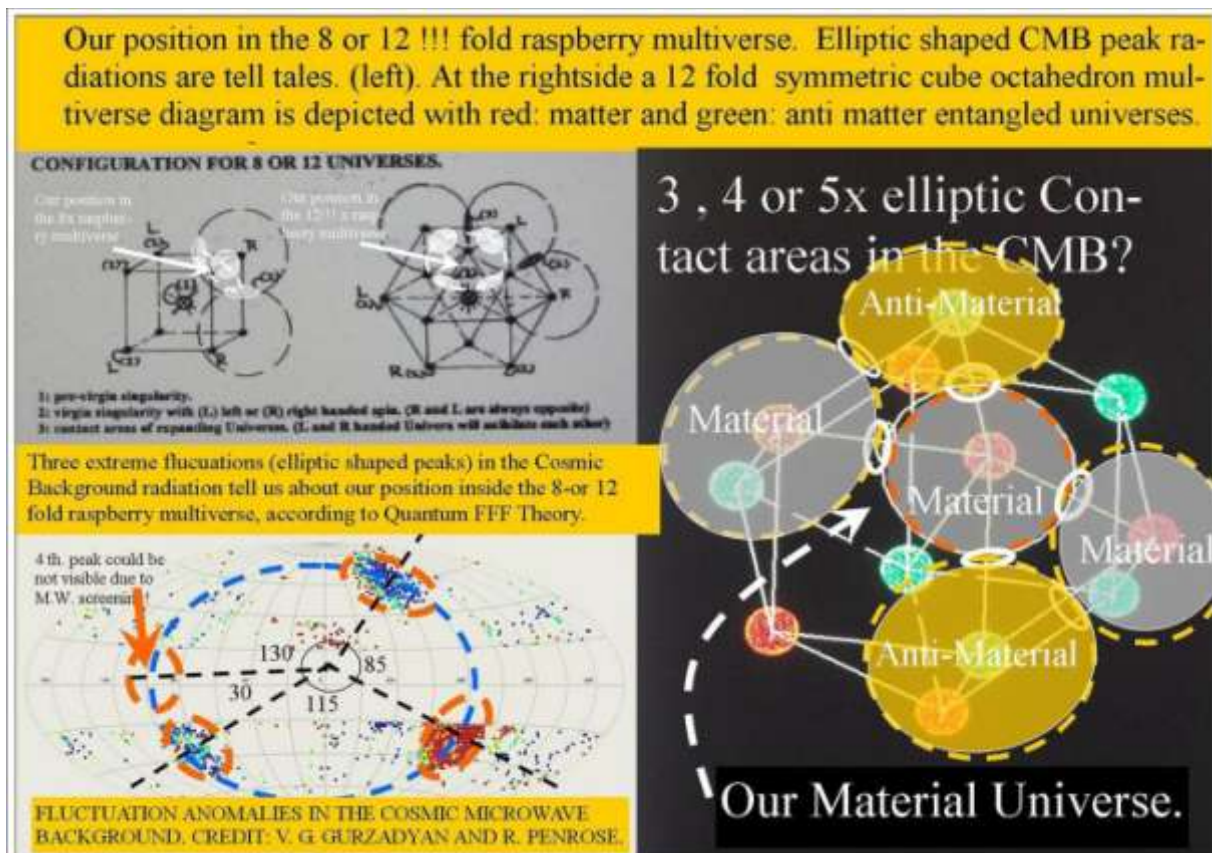
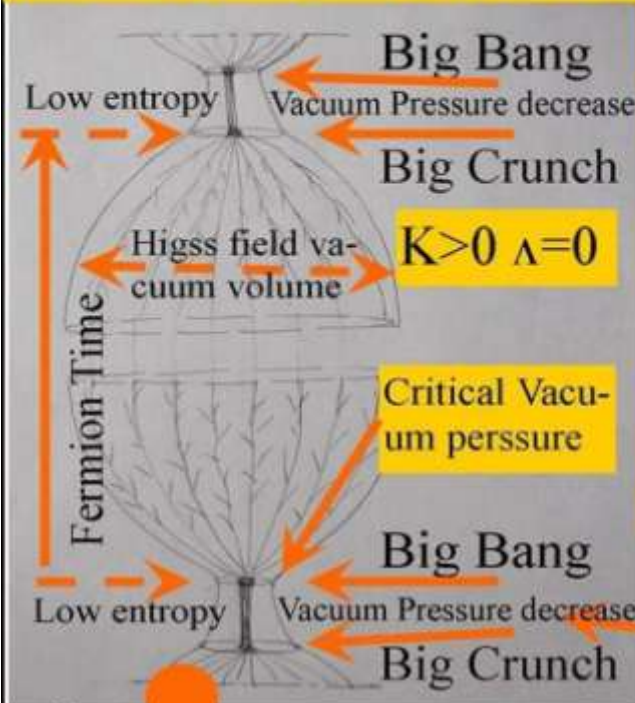

Figure 18, The Multiverse with 8-12 Charge Parity (time) symmetric Universal bubbles.

Bouncing/ Cyclic Multiverse.

The Big Bang and Big Crunch originated by Black Hole splitting, pairing and recycling into massive growing central galaxy black holes, according to Quantum FFF Theory.



Below: The pairing and splitting primordial black holes as creators of spiral galaxies, able to merge and form elliptical galaxies, (like M87) equipped with a central growing black hole.

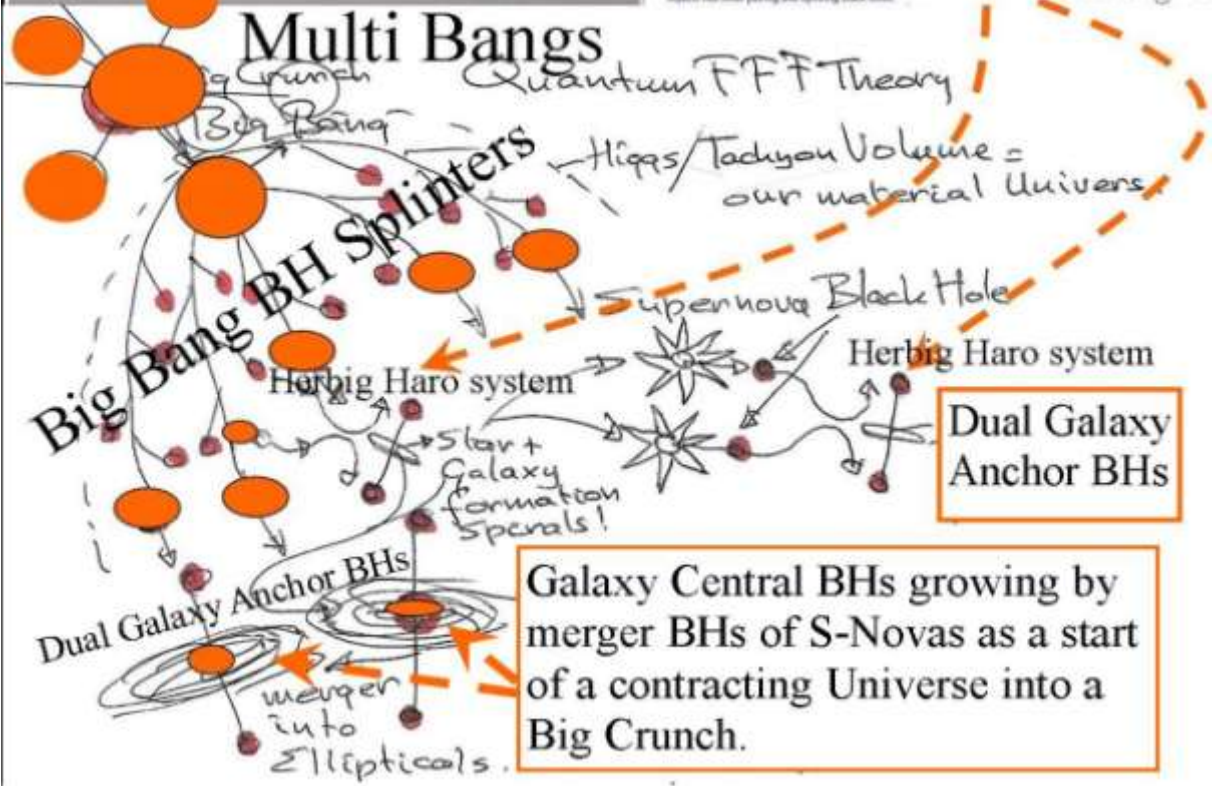
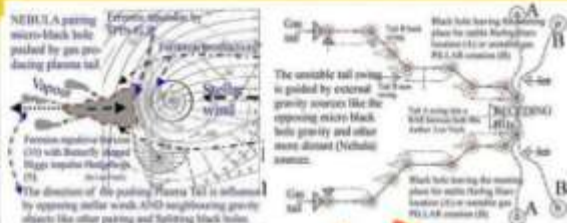
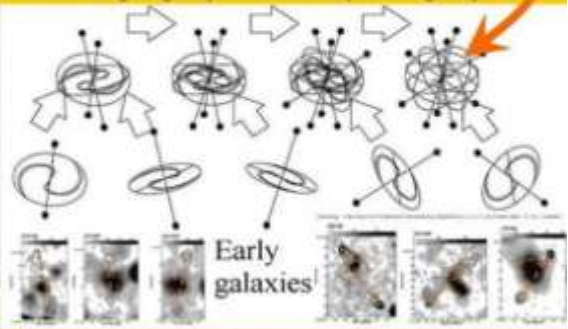
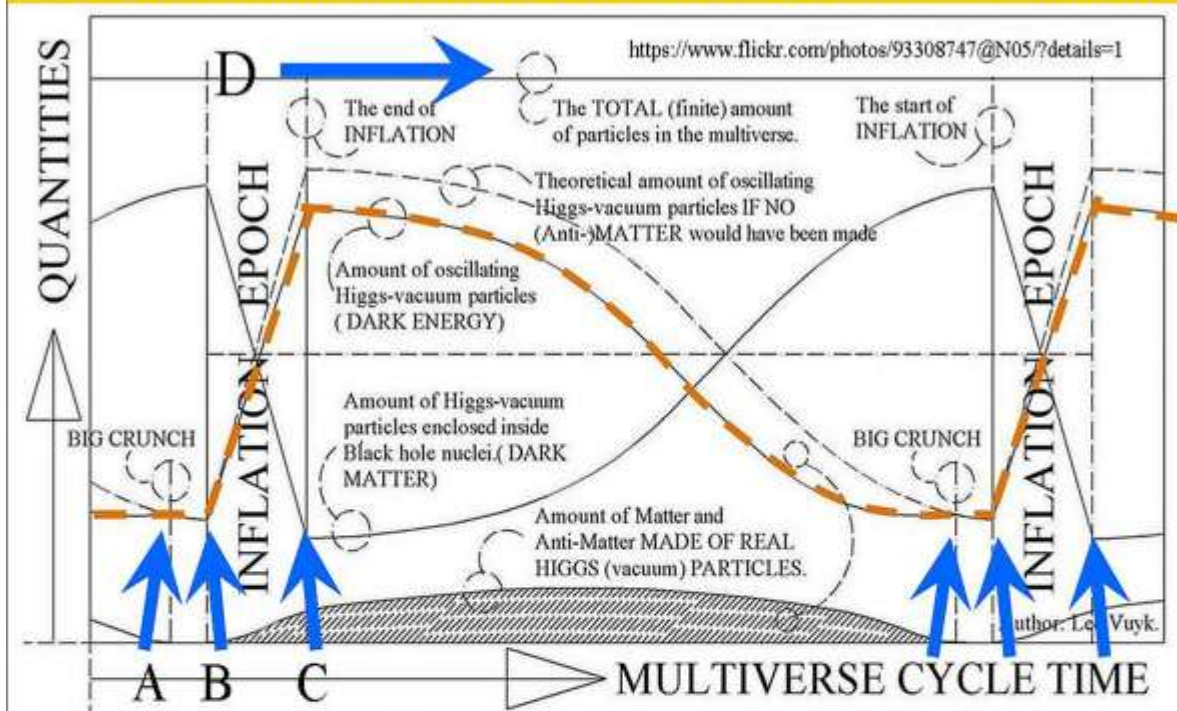

Figure 19, A Cyclic Multiverse bubble.

The Beginning and End of Time.

Multiverse cycle time versus quantities of mass carrying particles, Dark Matter Black Hole particles and Dark Energy Oscillating Vacuum Lattice (Axion Higgs field) particles. All particles and fields are assumed to be based on rigid string particles. Negative and Positive charged Fermions should have propeller shapes with opposite pitch.



A: The end of matter based time. (Big Crunch) All rigid string matter is through merger Super Nova black holes concentrated into one BH nucleus, which is compressed by the remaining-but absorbing- deluting-dark energy vacuum. If the deluted vacuum pressure comes into equilibrium with the total internal string tension of the nucleus, the Big Bang BH splits symmetrical into 8 or 12 entangled BH nuclei.

B: The beginning of matter based time and the splitting of the Big Bang Black Hole string nucleus into series of minor secondary primordial BHs, building the fractal shaped Lyman Alpha Forest and the start of dual pairing BHs into primordial Herbig Haro systems with vast galaxy formation in between.

All New physics BHs (even micro interference BHs) are postulated to create not only pair production at the horizon, but even entire protons. (plasma)

C: The end of primary Big Bang black hole splitting and the end of vacuum expansion (vacuum inflation)

D: The Total number of particles during the cycle process is constant.

According to the Quantum Function Follows Form model.

Figure 20, The beginning and end of time, with an inflation era strongly differ from the standard model.

The origin of “dead” galaxies: Simple external dark matter black hole configuration



According to Quantum FFF Theory, Galaxies have maximum growing potential by the number and size of external primordial dark matter black holes formed as big bang splinters able to pair into primordial Quasars or Herbig Haro like galaxy systems, which can merge with others. If no galaxy merger candidates are available in the neighborhood, the galaxy will soon reach a maximum size and die. Some Elliptic galaxies die also by reaching maximum merger potential.

Figure 21, The origin of Dead galaxies.

The great misconception in Astronomy:

Herbig Haro Bowshocks and Cometary Globules, are not interpreted as Dark Matter Black Holes. See below: Bok- and Cometary Globules with young Herbig Haro Bowshocks in the making in the Carina nebula.

Splitting and pairing electric dark matter black holes. Magic self propelling in space and even on earth according to Quantum FFF theory.



Several accelerating pairing and resulting mirror black holes, as the start of HH objects, in the Carina nebula, with temporary meeting phase (A) and arrival phase (B). (Quantum FFF Theory)



Pairing Cometary Globules

The pairing and splitting of Electric Dark Matter Black Holes into dual Herbig Haro bowshocks, as the fast creation and proliferation of Stars and galaxies after the splitting bigbang.

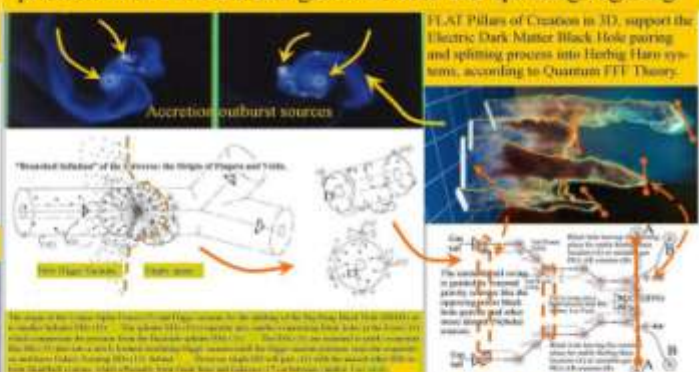

Dual Stellar Anchor Black Holes

Figure 22, The great misconception in astronomy.

Giant galaxies die from the inside out: Star formation shuts down in the centers of elliptical galaxies first.

According to Quantum FFF Theory, Galaxy- and Cluster black hole hierarchy is the origin of dying galaxies where star formation in the center stops. X-ray point sources (Dark matter black holes) in Virgo and Perseus cluster centers present evidence for black hole hierarchy: the smallest BHs are located in the centers and are not any more able to create Supernova black holes large enough to form Herbig Haro systems with star formation in between. The result: Dying "red and dead" galaxies as the start of Universal contraction and collapse (Big Crunch) in a cyclic multiverse.

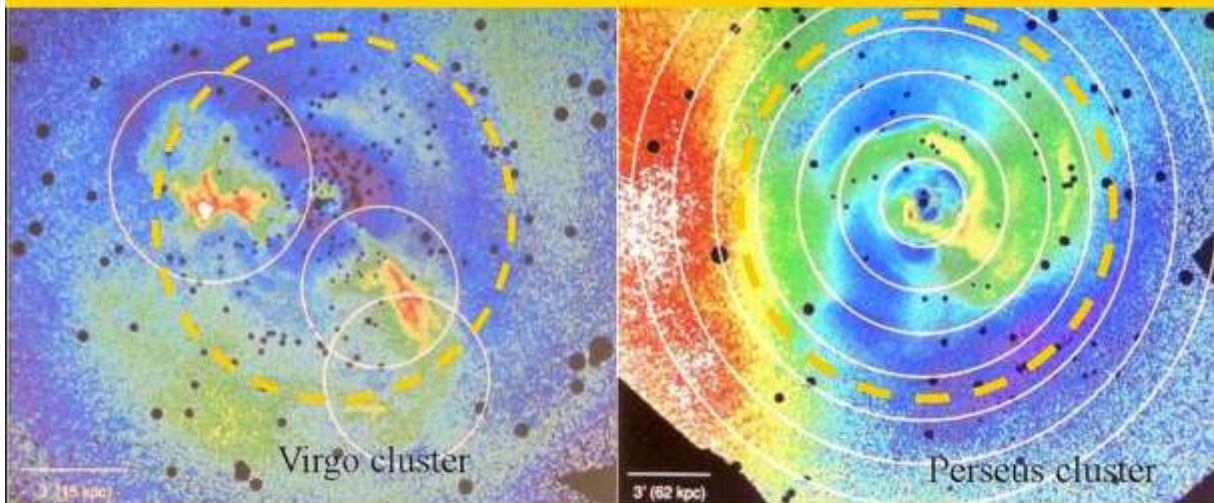

Below: Example of the galaxy black hole hierarchy model observed at Andromeda (M31 below left) and the Sombrero galaxy (M104 right).

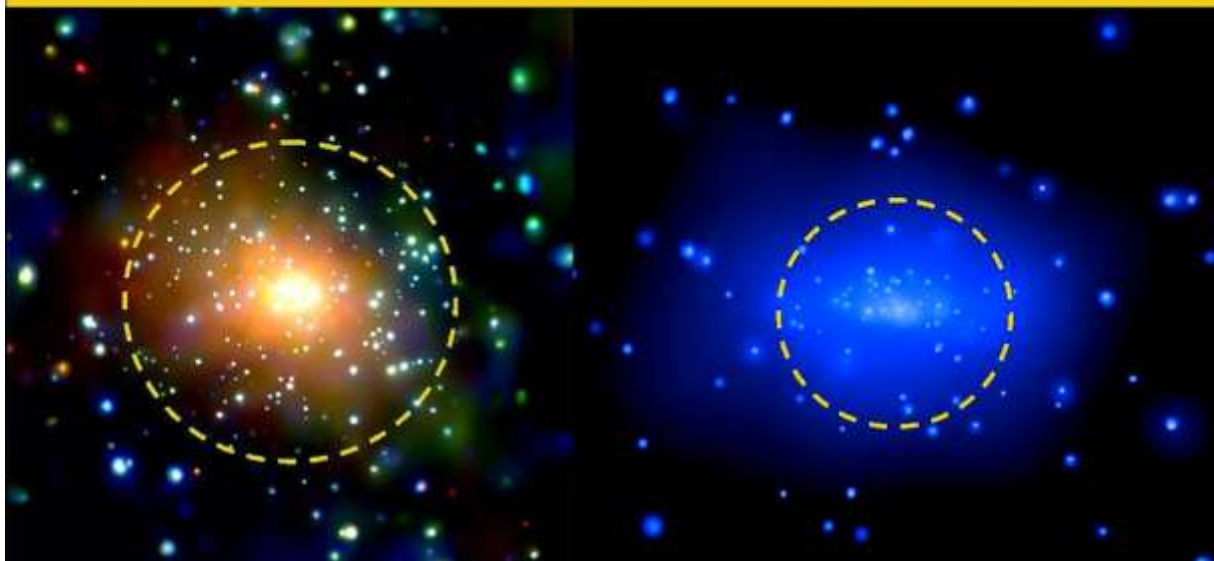

Figure 23, Star formation seem to shut down in the center of galaxies.

SABH cosmic ray hotspots (electric dark matter black holes) as the origin and future slingshot accelerators of Brown Dwarfs expelled by the sun.

New giant gas planets expelled by the sun, moving away to the south, into the direction of the Southern cross SABH hotspot.

A hotspot for powerful cosmic rays found under the Big Dipper, by the University of Utah. The mysterious source of cosmic rays is also reason to look at the southern hemisphere to observe the opposing second Stellar Anchor Black Hole (SABH) (Cosmic ray production by NEW black hole paradigm according to Quantum-FFF Theory).



Dates 10Jan.2014 (below) and 11March.2012 (above). "Brown Dwarfs ?" according to Q-FFF.

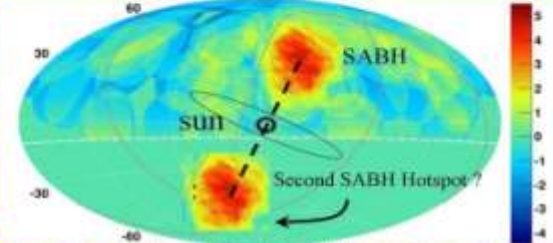
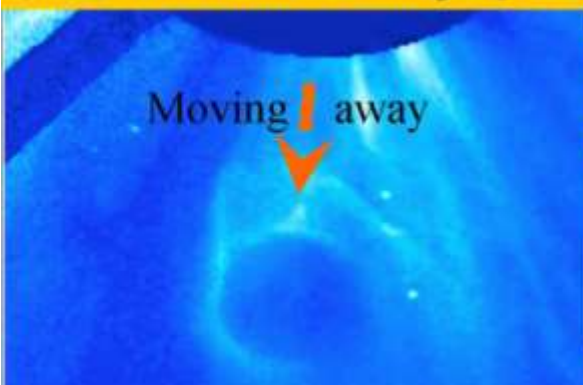

According to Quantum FFF Theory, "New Black Holes produce Proton-Electron plasma. By the strong Casimir vacuum push gravity on the BH, the "lighter" electrons will stay outside the "heavier" proton horizon (blue). As a consequence BHs have a strong electric potential, which is liberated by asymmetric processes in dual BH systems like Herbig Haro objects showing strong electro-magnetic effects in open cluster star formation and Hirkeland Alfvén circuits around the earth and even in the so called DICTEP 2 results.

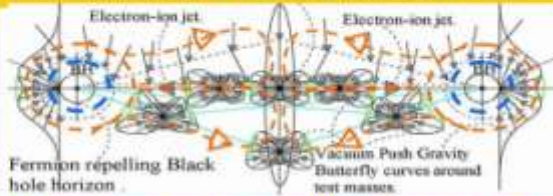

Scheme of the electric SABH principle around the sun.

Figure 24, Even the sun seems to have polar dual black hole Herbig Haro remnants and is able to produce and expel gas planets (failed stars) at this age.

Equivalence between gravity and acceleration does not hold in Quantum FFF Theory. Mass in motion needs a reference frame of ZPE oscillating Higgs field and Lorentz polarization of conscious propeller Fermions (s) to keep a non accelerated flight.

Quantum Gravity as pressure distribution of the oscillating dual Higgs/Graviton vector field.

Polarized Fermion Mass in motion through the resistive, but also pushing oscillating Higgs vacuum (according to Quantum FFF theory)

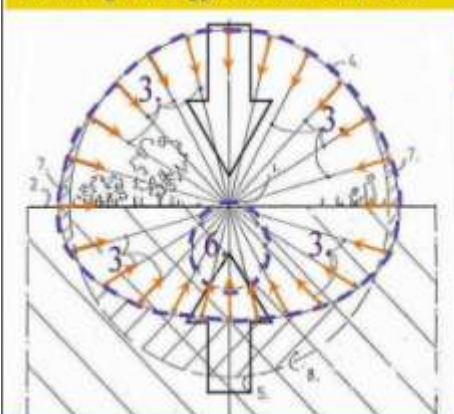

Cross section through the dual Higgs/Graviton 2D vector field pressure distribution (or globular Hedgehog) on a point mass (1) located on earth's surface (2), according to Quantum FFF theory. 3+4= Higgs vector field. 6= Graviton vector field originated by the Higgs-graviton field transformation of the earth itself. 7-8= differences with a perfect global vector distribution. Field variables 3+6 are rendered as inversed arrows. (see also black hole pressure distribution without gravitons)

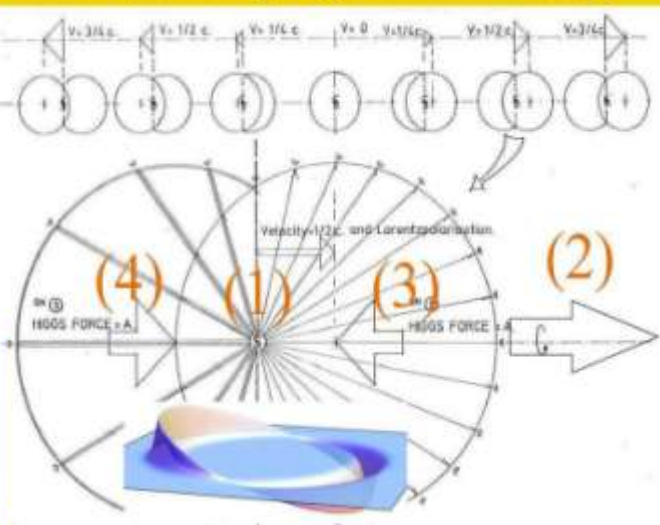

Figure 25, Quantum Gravity and Mass in motion. (Quantum FFF Theory)

Lorentz Fitzgerald Contraction is real!

A real Lorentz Fitzgerald contraction does not fit into Einsteins Special Relativity. However recent findings of atomic nucleons polarized into one fixed spacetime direction should tell us differently.

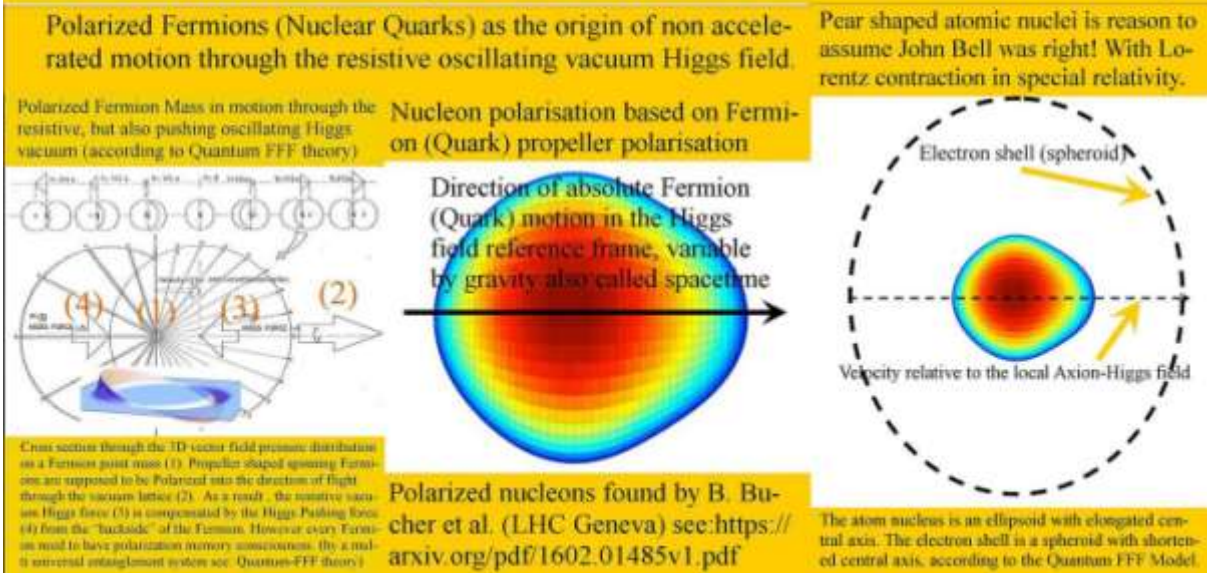

Figure 26, Lorentz Fitzgerald contraction is real (John Bell)

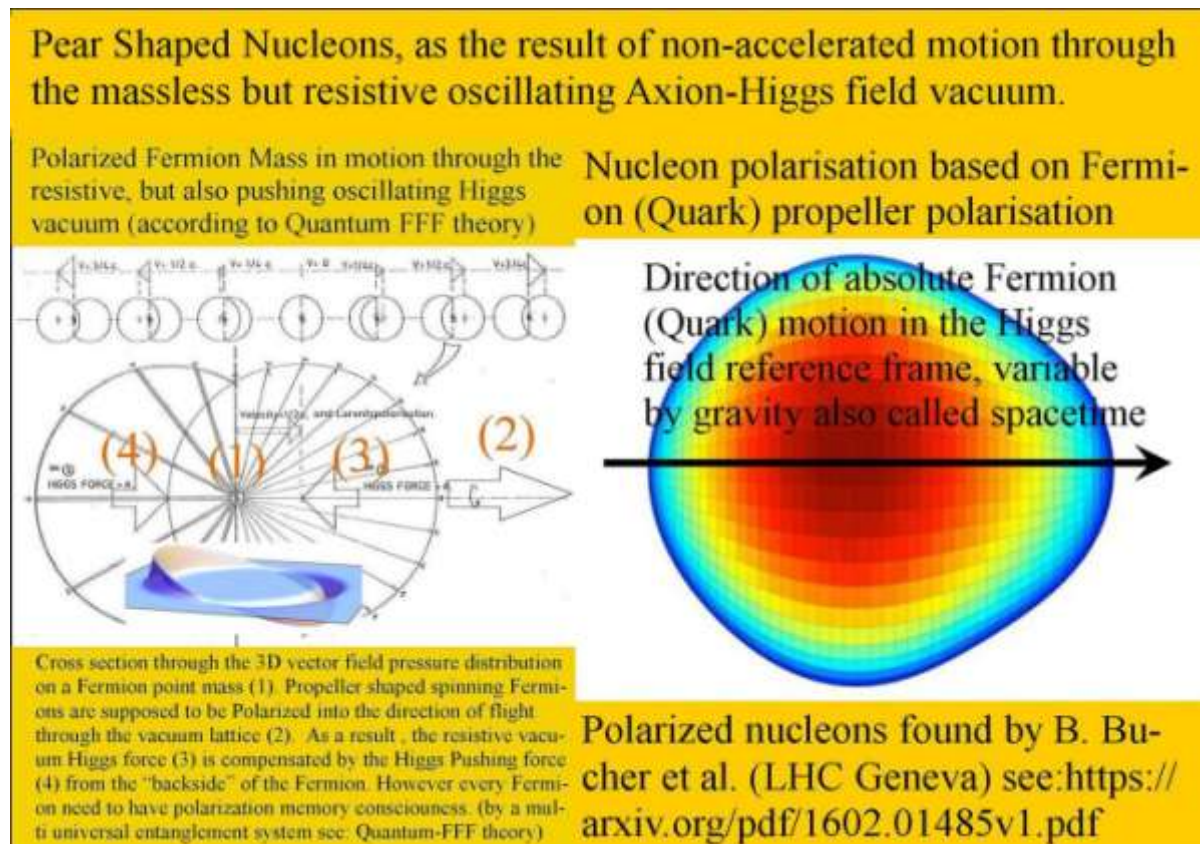

Figure 27, Lorentz Fitzgerald contraction by nucleon pear shaping.

Why 125 GeV Higgs does not decay via 2x bosons into 2x Taus and 2x Bottom quarks? (see: Lubos Motl)

According to the Quantum FFF Model, 2x Taus and 2x Bottom quarks together need 10x electron/positron propellers (silver colored, see at the bottom below).

Light Higgses seem to decay into: (aa) 2x bosons containing 4x or 6x or possibly for ZZ bosons even 8x electron positron propellers.



Z Boson= 2x



W Boson= 3x



ZZ Bosons= 4x



See below counting silver particles: 4x Taus = 8x elements, 2x Muon with 2x Taus = 6x. 2x Muon with 2x Bottom = 8x.!



6x BOTTOM quarks

Figure 28, Some examples of 3D particle structures according to Quantum FFF Theory.

LASOF Lightspeed ($c \pm v$) extinction ellipsoid around massive objects as the origin of the anomalous Quasi Periodic Oscillations and the a-symmetric light curves called the O'Connell effect. According to Quantum FFF Theory.

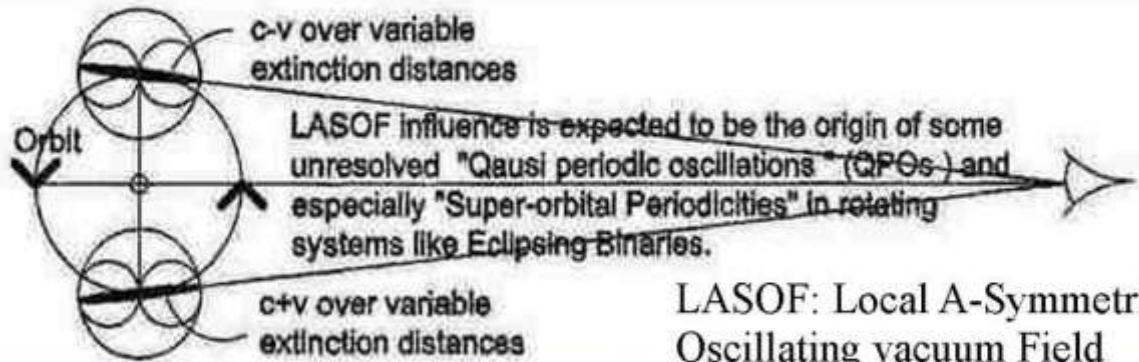

Eclipsing Binary Stars are observed to be alternating red- or blueshifted with a wobbling redshift if passing in front of the other and called "QUASI PERIODIC OSCILLATIONS" (↘) Just like the passing of the SUN by VENUS (see I.I.Shapiro)

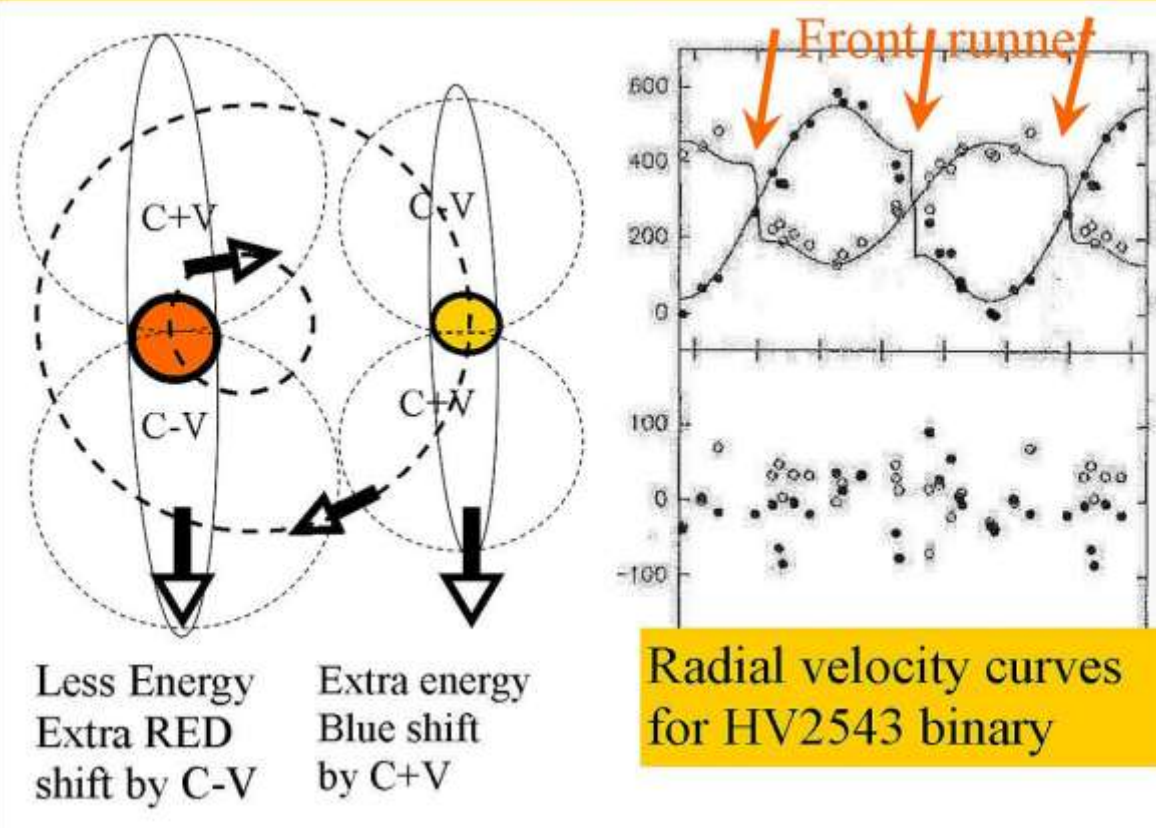

Figure 29, Lightspeed differences according to (LASOF) Local Anti Symmetric Oscillating vacuum Frame model, around eclipsing binaries.

“Monster colliding black holes might lurk on the edge of spiral galaxies”. Supported by Quantum FFF Theory.

The Contribution Of Outer HI Disks To The Merging Binary Black Hole Population see: <https://arxiv.org/abs/1710.09407>

BH Overdensity origin at the Spi- Plasma tail Propulsion of
ral edge by plasma tail propulsion . new physics black holes.

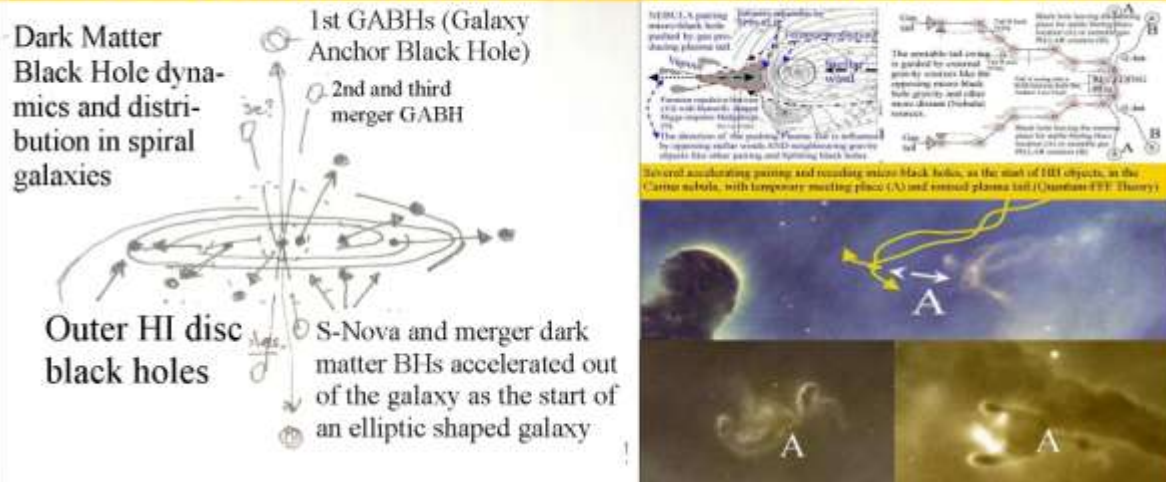

Figure 30, . Dark Matter Black Hole dynamics in spiral galaxies.

The New Black Hole according to the Quantum-FFF Model:
Negative Charged (outside) and Fermion (Plasma) Creation out
of the massless Axion-Higgs String vacuum. (Fermion repulsion).

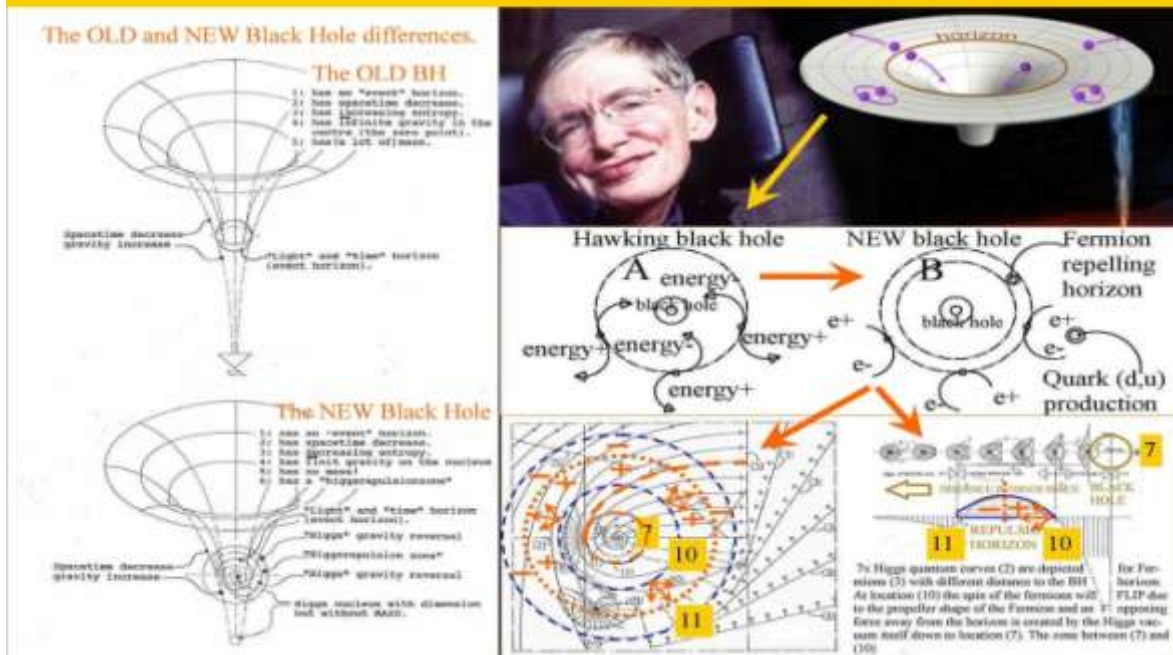
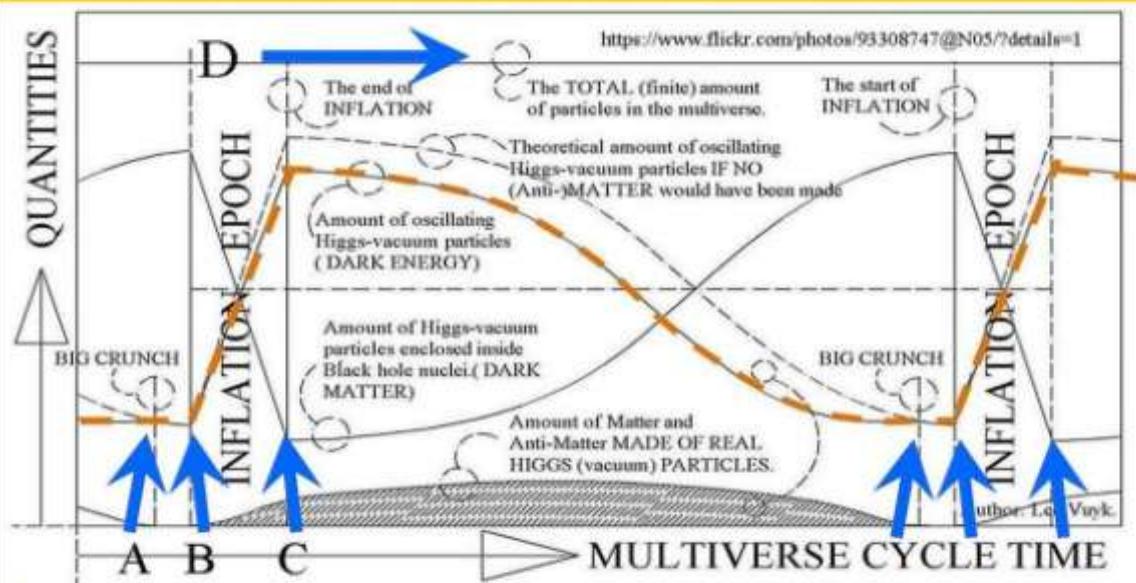

Figure 31, The new black hole

The Bouncing Multiverse 3 -

According to Quantum FFF Theory, we live inside one of a specific number of Charge Parity symmetric entangled copy universes coming out of a huge (massless Axion/Higgs rigid string black hole nucleus = Dark Matter). All copy string particles are guided by long distance (holographic) multiverse entanglement and transformable by mutual collision into all SM particles and monopole bosons or massless oscillating Axion/Higgs vacuum particles (Dark Energy) , responsible for the Casimir effect and half of all other SM semi pressure forces.



One bouncing universe of the Raspberry Multiverse depicted.

Quantum FFF Theory

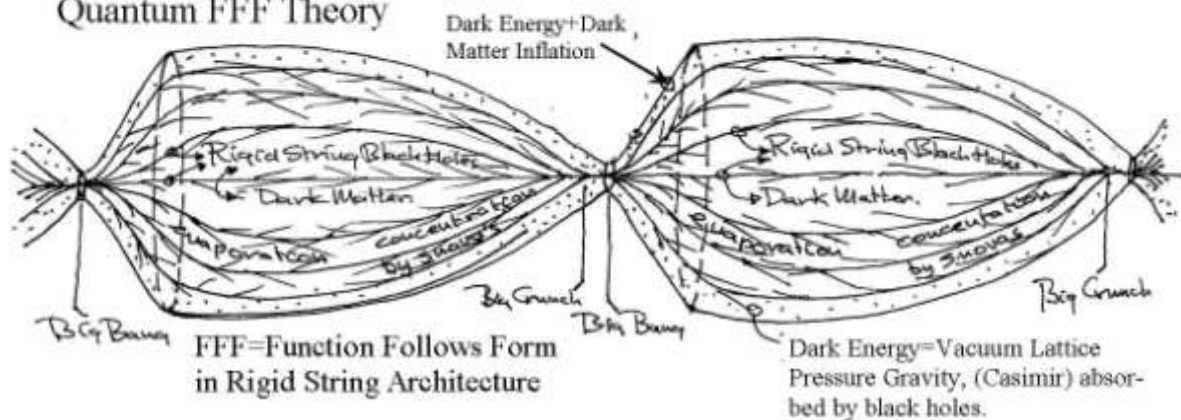

The Raspberry Many Worlds Interpretation of Quantum Mechanics is based on an Fixed Number of Material and Anti- Material Universal bubbles.

In the accepted Many Worlds theory our Material Universe splits constantly every second at the quantum scale. However, in the Raspberry Multiverse, the Big Bang produced an even number of Charge Parity Super Symmetric entangled Universal bubbles.

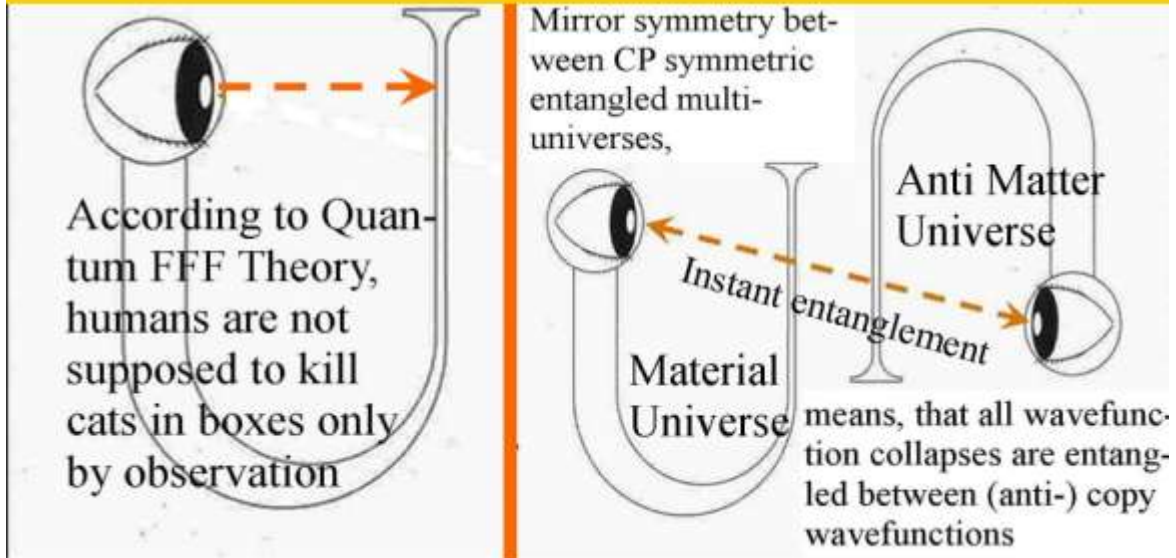

Figure, 32. Entanglement between many symmetric universes, needed for the guidance memory of all particles.

2 Diagrams of a 12 fold Raspberry Multiverse showing preplanning (RPI) of one of the instant entangled copy subjects in the Benjamin Libet lab, with- and without a Veto action of one of the copy subjects (according to Quantum FFF Theory)

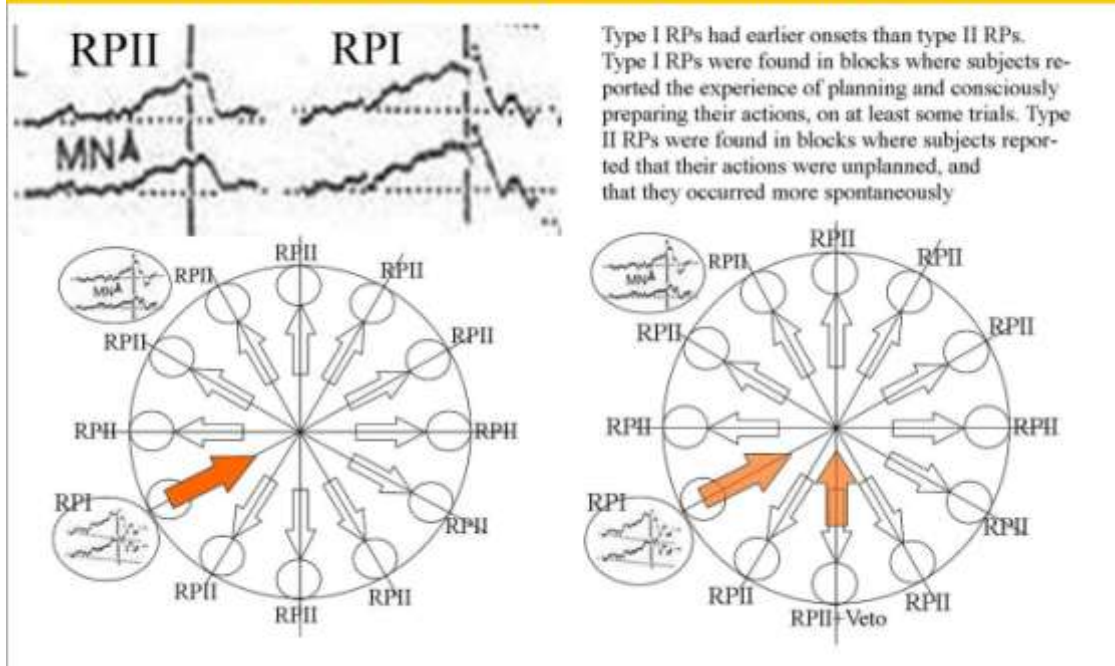

Figure 33, Quantum FFF Theory explanation of the difference between RPI and RPII (R=Readiness potential) observed and published by Benjamin Libet around 1964. (reference: 72: Democratic Free Will and Telepathy in the Instant Entangled Multiverse)

Anti Maxwell Zone close to a current in a wire, is responsible for a new dual Monopole Photon based reaction less spaceflight principle.

Reaction less space propulsion principle based on a so called "Anti Maxwell zone" around a direct current in a wire.

According to Quantum FFF Theory based dual magnetic photon monopole model.

According to Quantum FFF theory, all magnetic fields can be presented as DUAL Magnetic Monopole Photon Vector Arrays. These monopole arrays undergo curvature. As a result, the magnetic field intensity around the Earth and a wire is NOT dropping off with the square of the distance from the source!! The field become stronger polarized away from the source (See arrows). Close to the current transporting wire, the magnetic field strength is zero due to the parallel trajectories of North or South Photons before curvature and polarization of iron powder. (Author: Leo Vuyk)

Lorentz force on the wire without a magnet reaction force.

TWO (North and South) Monopole Photon trajectories around a current in a wire shown in cross section. Between the two yellow circles both (N+S) trajectories are pointing about parallel. The result: No iron Powder orientation between the concentric circles, as is observed in the lab (see upper photo). This is a firm support for the monopole photon vector array element of Quantum FFF Theory.

Figure 34,

The New Dual Magnetic String Physics of the Anti-Maxwell Magnetic dip around a wire, for reaction less space propulsion.

Explained by detail observation of iron powder distribution (the ring shaped absence) around a wire or coil. Below: Several observations and explanation by the curvature of monopole quantum information arrays.

According to Quantum FFF theory, all magnetic fields can be presented as DUAL Magnetic Monopole Photon Vector Arrays. These monopole arrays undergo curvature. As a result, the magnetic field intensity around the Earth and a wire is NOT dropping off with the square of the distance from the source!! The field become stronger polarized away from the source (See arrows). Close to the current transporting wire, the magnetic field strength is zero due to the parallel trajectories of North or South Photons before curvature and polarization of iron powder. (Author: Leo Vuyk)

Three circular anti-Maxwell propulsion systems in triangle configuration, should be enough to create stable piloting and flight (LeoVuyk)

New physics of Rigid String Theory called "Quantum FFF Theory", as a base for new understanding of Anti-Maxwell magnetic field distribution around a wire. And reaction less propulsion.

Figure 35,

Evidence for a Fermion Repelling New Physics Black Hole inside Herbig Haro (HH34) Bowshock ! Outflow Velocity differences between the leading black hole and the secondary Fermion plasma hotspots are the indication, according to Q-FFF Theory.

The black hole (O) has the smallest relative velocity. Conclusion: Secondary Fermionic plasma hotspots are repelled ! As predicted!

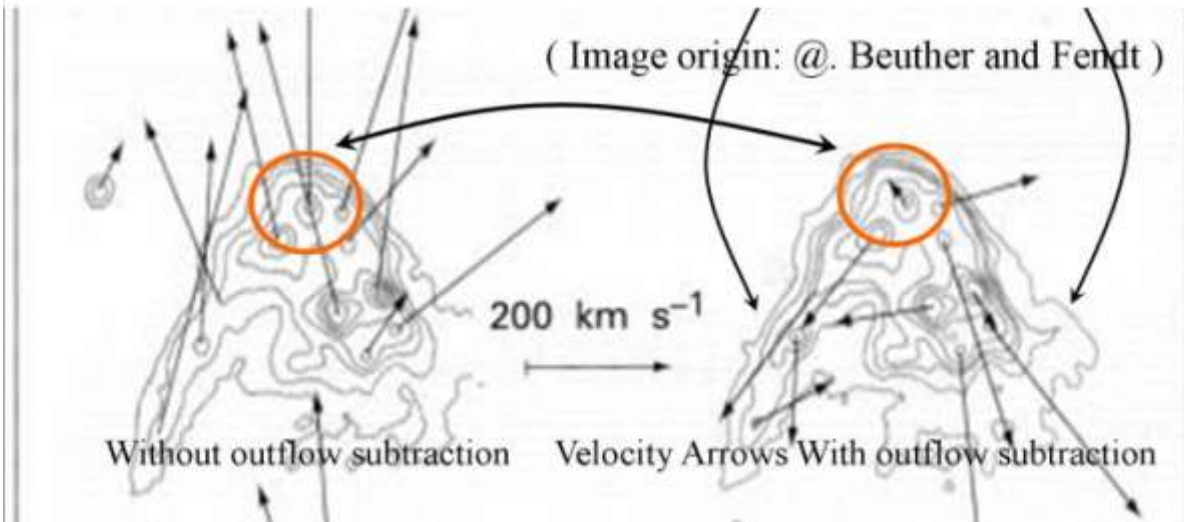

Figure 36,

Dual Quasar/Galaxy Cluster Relation in the Early Universe

Stars indicate quasars and bright (respectively faint) galaxies at the same epoch are shown as circles (respectively as dots). The galaxy overdensity with respect to the average density is shown by the coloured contours. Quasar pair members are associated with high density regions of galaxies. See: <https://www.sciencedaily.com/releases/2018/03/180313093054.htm>
Conclusion the dual Quasars represent Big Bang Black Holes.

Dark Matter Big Bang exploding into small dual (New physics) plasma producing DM Black Hole splinters as the origin of quick star formation, according to Quantum FFF Theory.

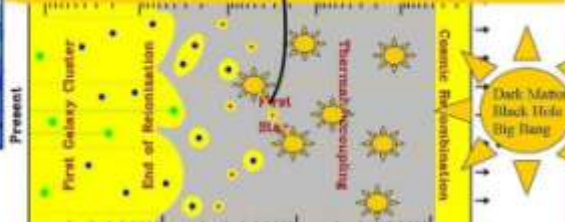
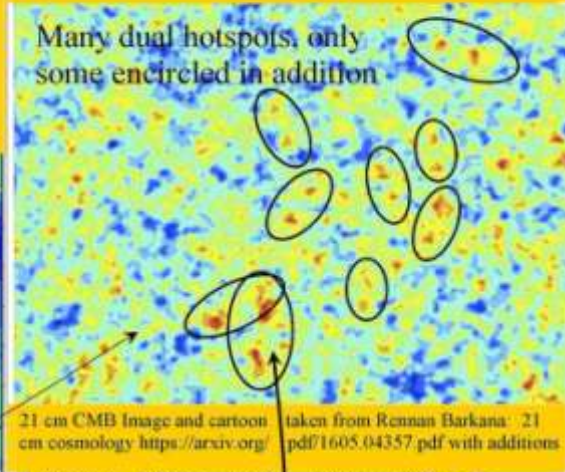
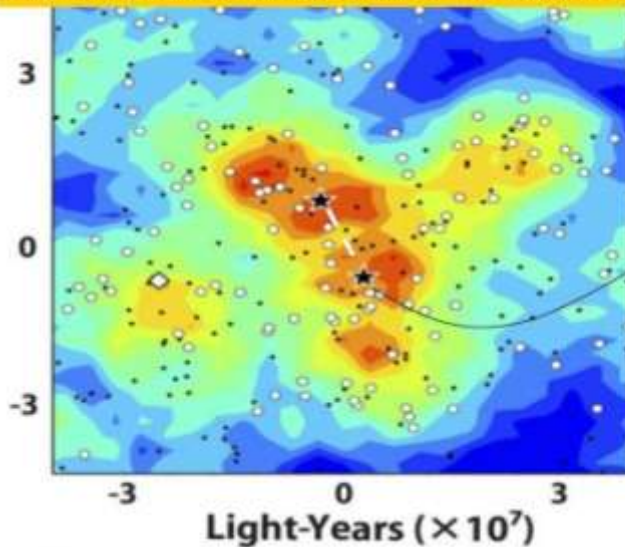
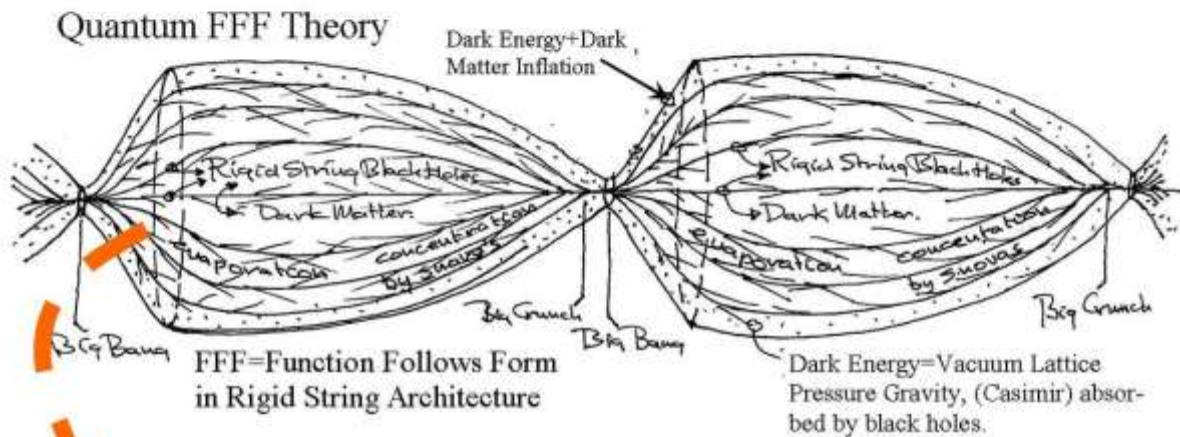

Figure 37,

The Bouncing Multiverse 2a

According to Quantum FFF Theory, we live inside one of a specific number of Charge Parity symmetric copy universes coming out of a huge (Axion/Higgs rigid string black hole nucleus = Dark Matter). All copy string particles are guided by long distance (holographic) multiverse entanglement and transformable by mutual collision into all Standard model particles and more. Such as monopole bosons or massless Axion/Higgs vacuum particles (Dark Energy), responsible for the Casimir effect and half of all other SM semi pressure forces.

One bouncing universe of the Raspberry Multiverse depicted.



Below: the usual BH dual pairing after the Big Bang splitting.

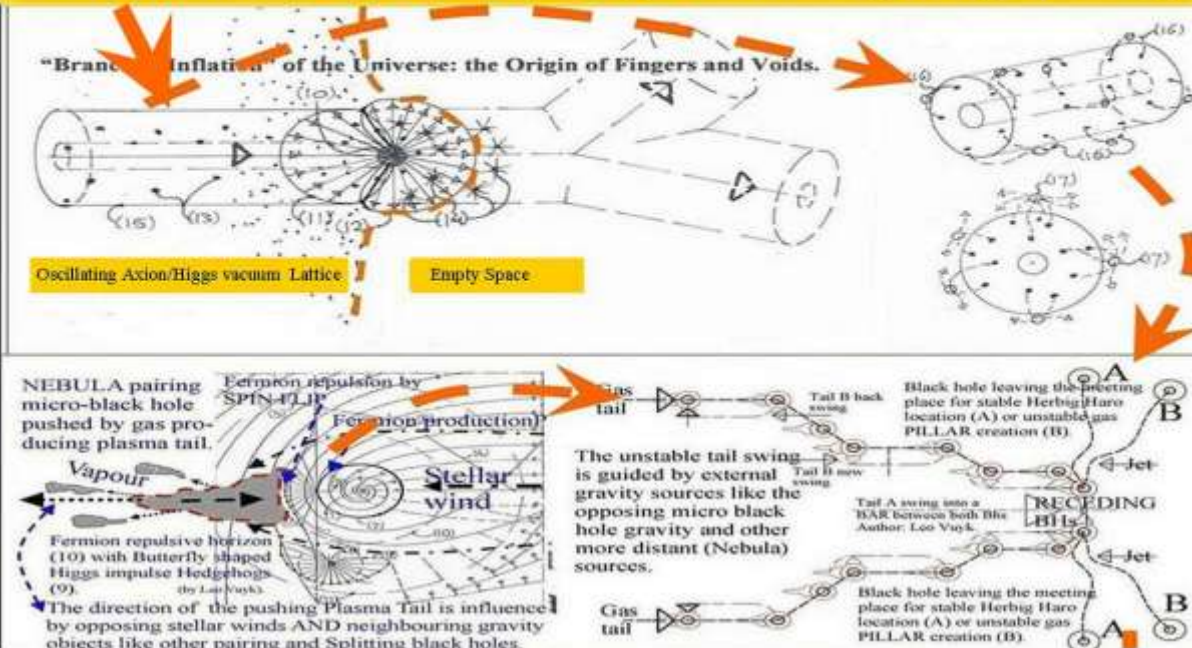
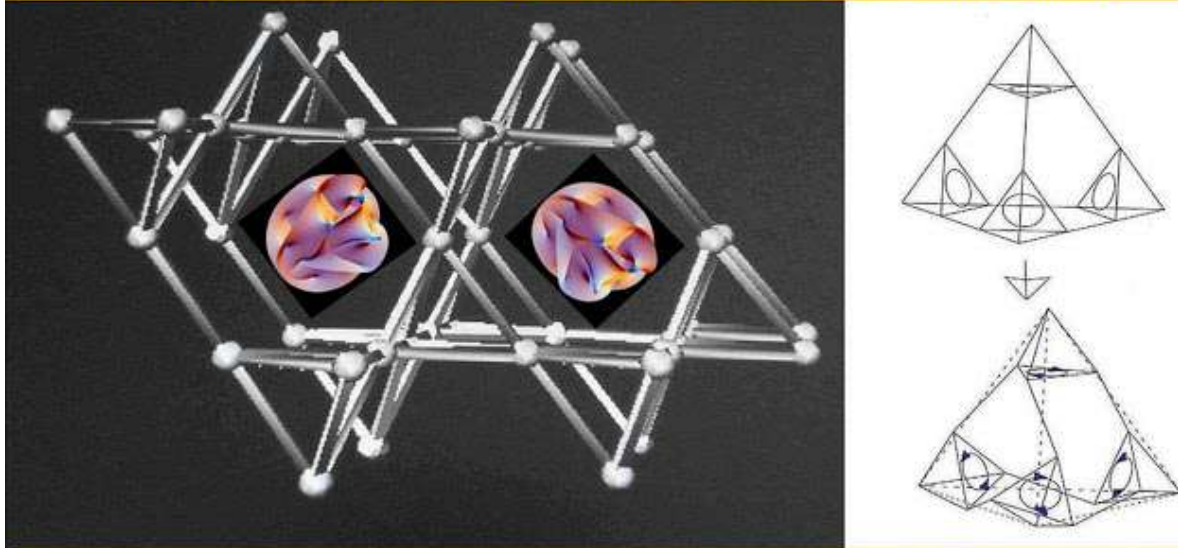

Figure 38,

Calabi Yau propeller fermions inside the Axion-Higgs vacuum lattice

Chiral pyrochlore tetrahedral vacuum structure with oscillating Axion Higgs strings between nodes, are supposed to be the origin of Dark Energy of the vacuum, and the motor for all "eigen energies" of propeller shaped Fermions, (according Quantum FFF Theory)



Simplified tetrahedral vacuum lattice structure (left), constructed by complex chiral tetrahedral building blocks (right). Each universe has to choose between a left- or righthanded rotation of its tetrahedral building blocks. Each chiral lattice has the Planck length and is supposed to be equipped with at least two oscillating massless new Higgs particles.

Figure 39,

Not the radiation of the sun is origin of Comet 67P-CG plasma jets but a new physics micro dark matter black hole.

Comet P67 CG, evidence for local internal energy and plasma creation and ejection.

According to Quantum FFF Theory created by multiple internal new physics micro electric dark matter black holes.

Crater creation by internal icy Funnel Structures, suggested to be created by aligned Dark Matter BH point sources for Comet 67PCG.

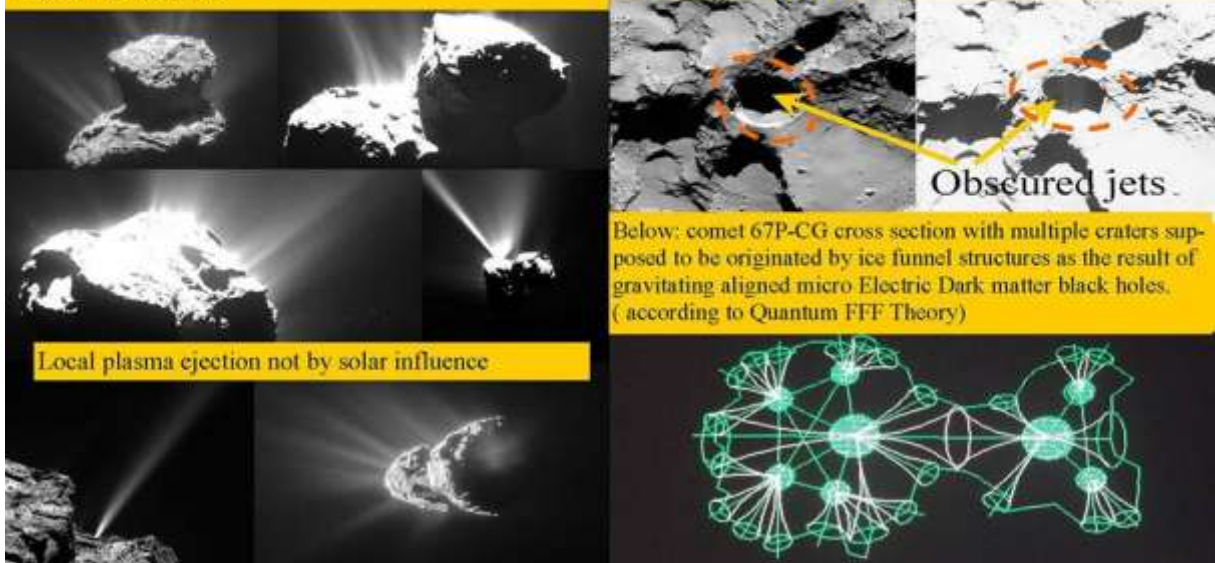

Local plasma ejection not by solar influence

Obscured jets

Below: comet 67P-CG cross section with multiple craters supposed to be originated by ice funnel structures as the result of gravitating aligned micro Electric Dark matter black holes, (according to Quantum FFF Theory)

Figure 40,

How to measure the earth magnetic monopole vector field direction. According to Quantum FFF Theory.

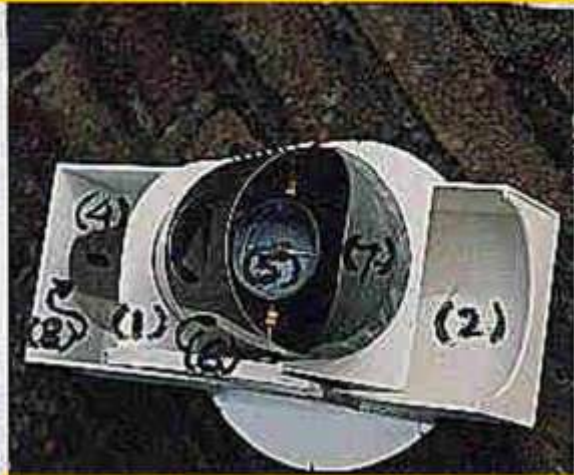

A compass inside a mu-metal tube, was enough to get clear 3D results (left)

Measuring results of the mu-metal instrument (magnetic telescope) described on app. Page 5. Dated 4-4-1998, By: Leo Vayk. Location: Weesp the Netherlands.

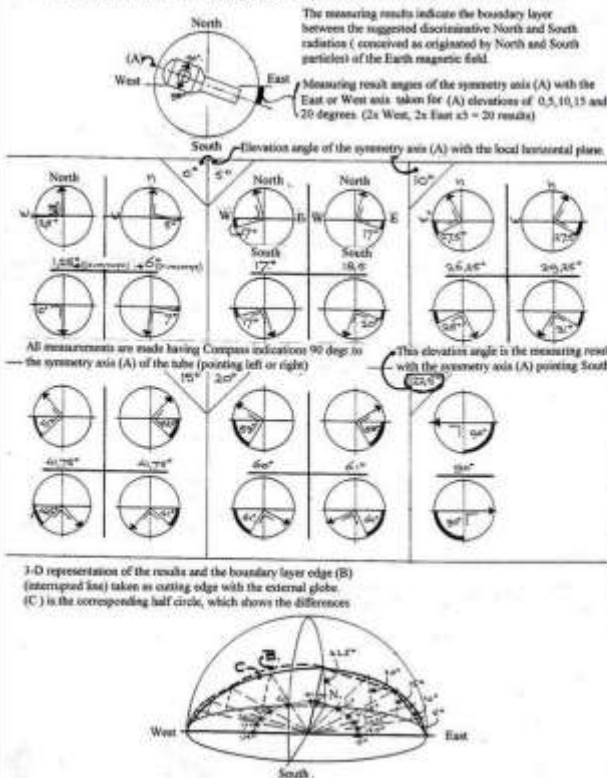

Figure 40,

The Butterfly oscillating Vector Casimir Vacuum seems to be able to transfer the Plasma Gas bubble fully into an electric Ringed Plasma Discs, and a spiral but focused jet, Parallel with Solar Birkeland currents (according to Quantum-FFF Theory.) However, no gas is reaching the stringy Black Hole Dark Matter nucleus ! Below right: comparison for bended jets with primary and secondary GABHs observable inside the Centaurus A jets.
 see: <http://vixra.org/pdf/1903.0102v2.pdf>

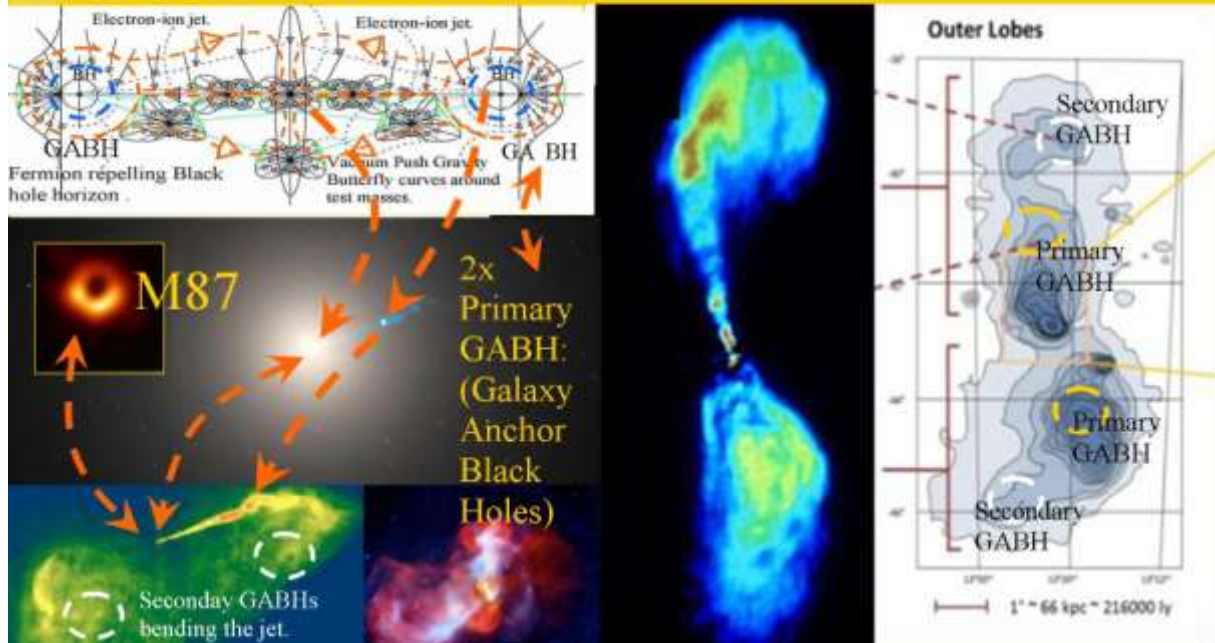

Figure 41,

“Electric Charged Dark Matter Black Holes” seem to be active at all scales, even as micro black hole sunspots! Examples: Sunspot-Herbig Haro-Quasar twin grouping of black holes compared below, according to Quantum FFF Theory. http://vixra.org/author/leo_vuyk

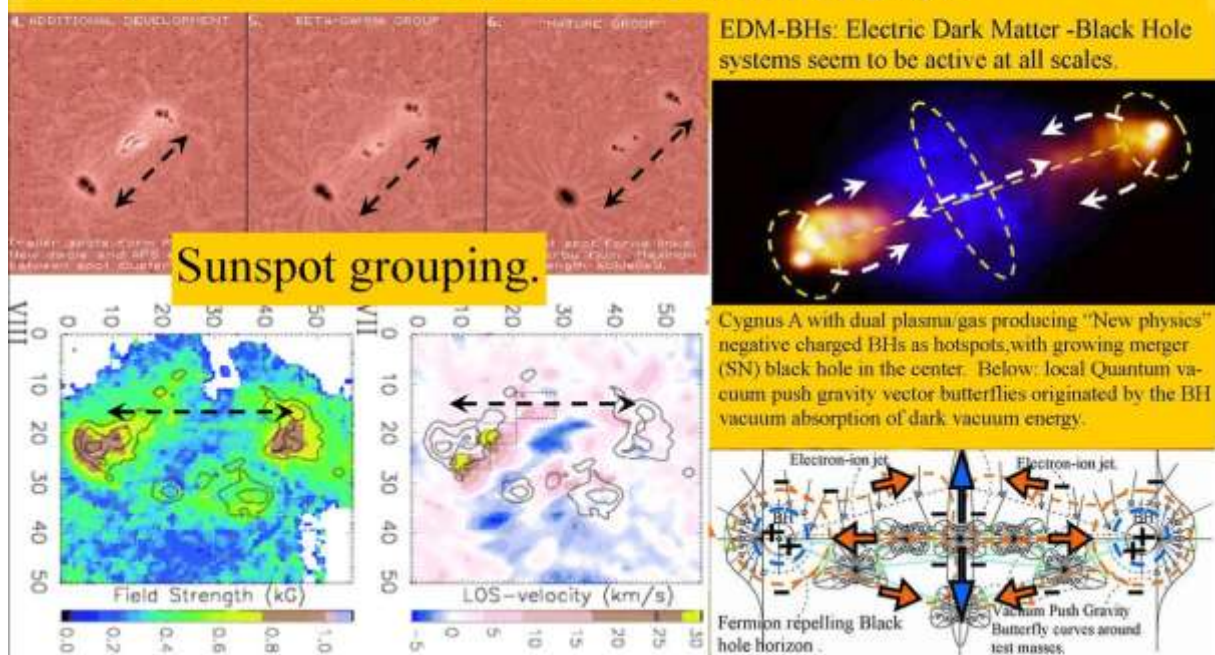

Figure 42,

The Butterfly Vector Casimir Vacuum is able to form Plasma Gas into fully Repelled Jets- and a Disc. (according to Quantum-FFF Theory.) see: <http://vixra.org/pdf/1806.0368v1.pdf>

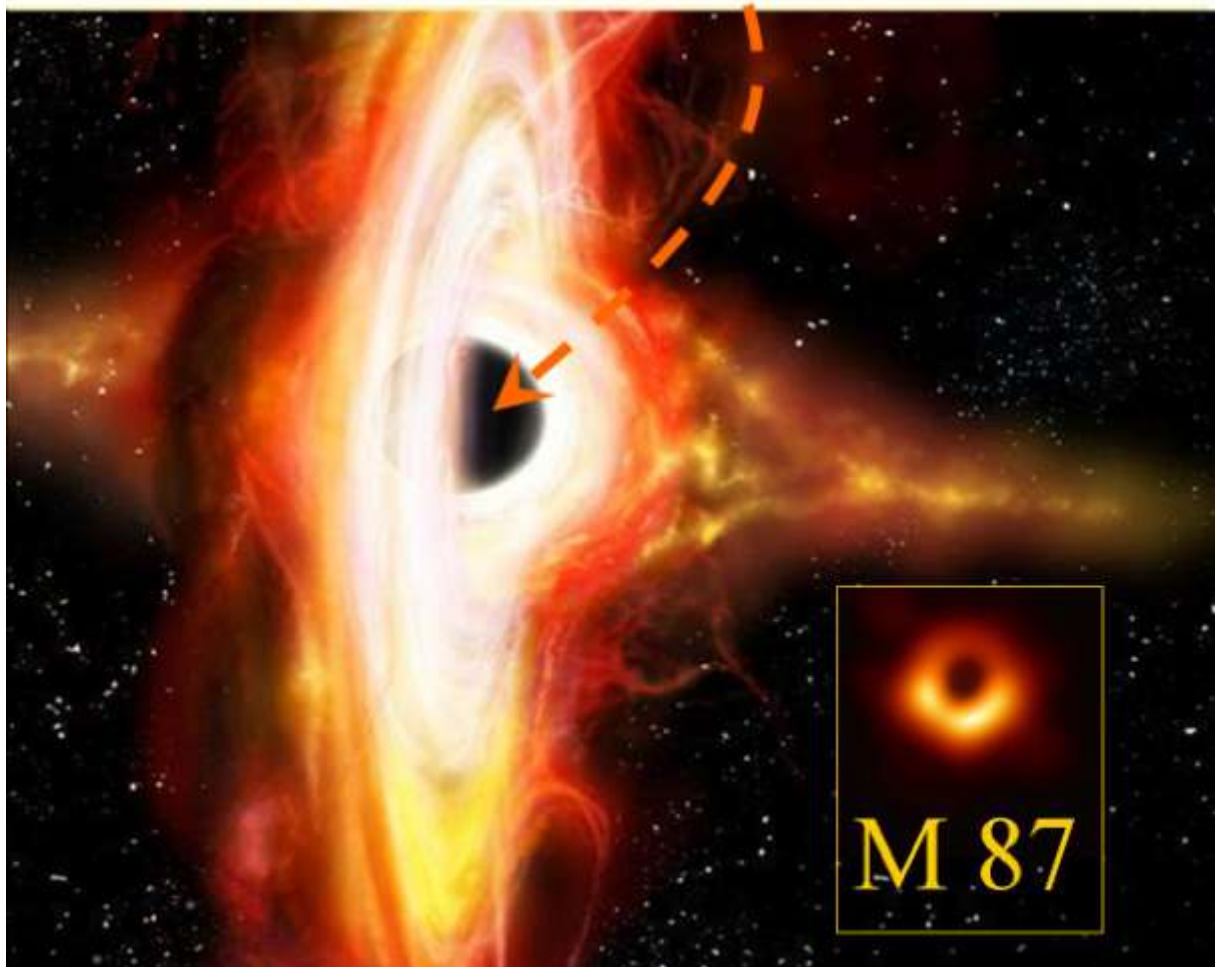
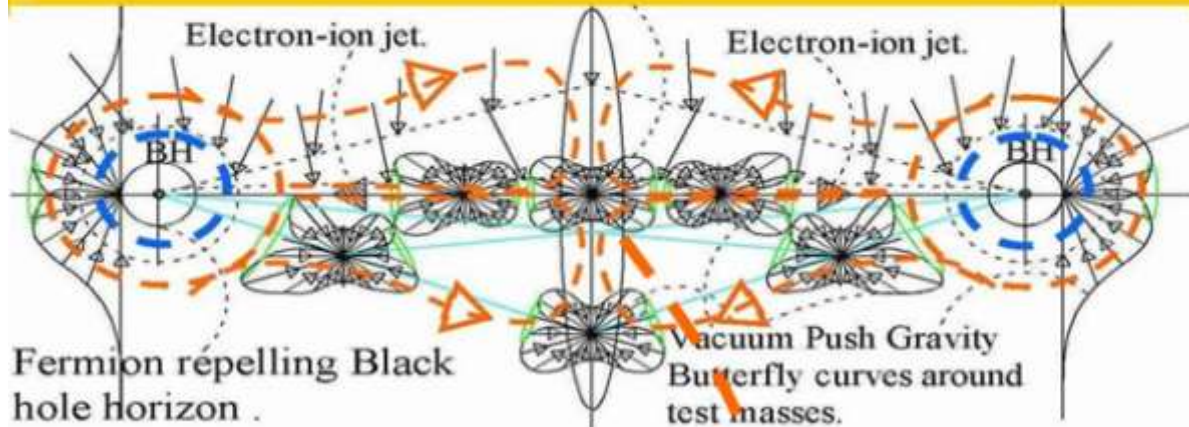
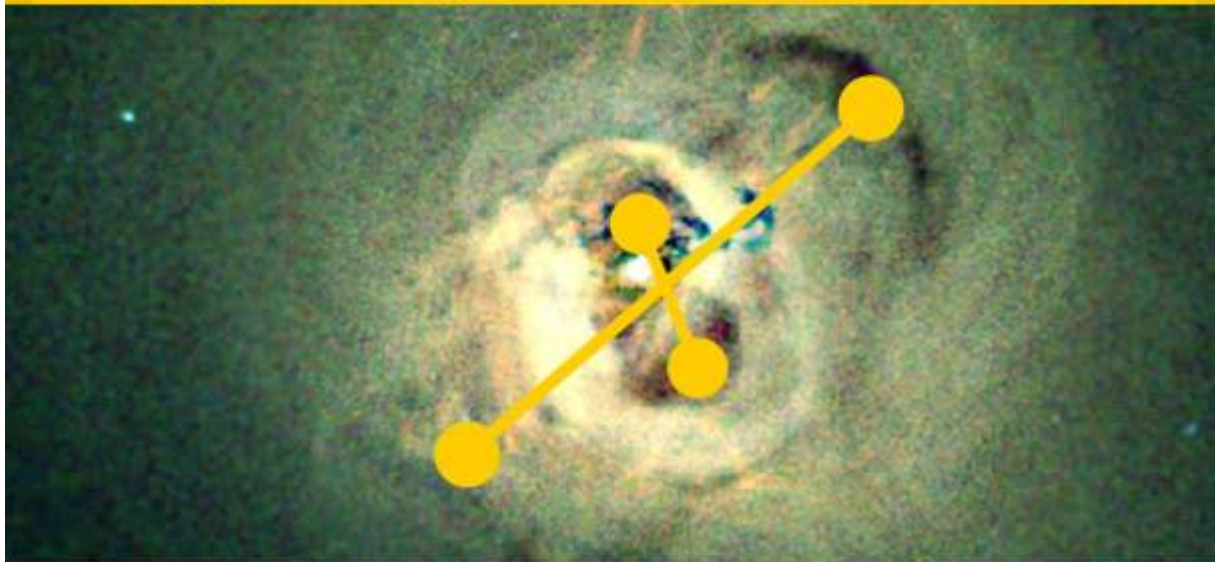

Figure 43,

Persei cluster dual hot gas distribution

Multiple dual Herbig Haro black hole (Bowshock) systems observed inside the Persei cluster.

See: http://vixra.org/author/leo_vuyk



Four main Dark Matter Black Hole families.

Primary- Secondary Galaxy Anchor BlackHoles (GABHs), (Globular Dwarfs) Central BH and Stellar/Dwarf Anchor Black Holes, (SABHs), According to Quantum FFFTheory

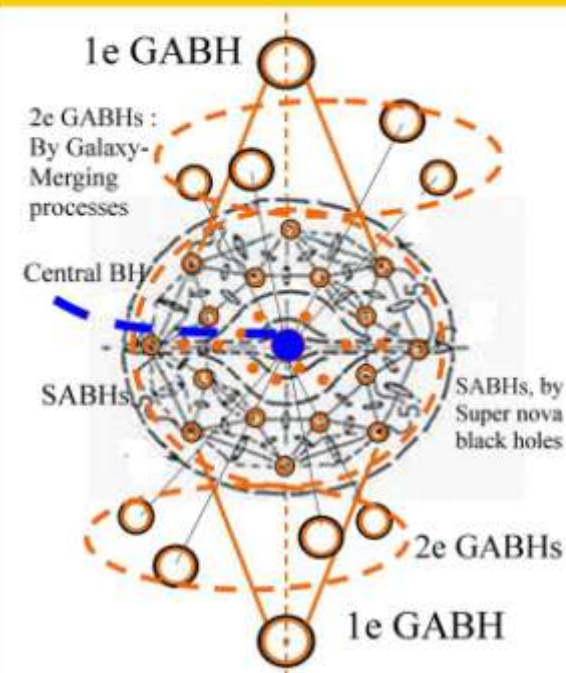

According to Quantum FFF Theory, Black holes create Proton-Electron plasma at the Fermion repelling horizon. As a consequence dual black hole systems like Herbig Haro objects are equipped with dual EM jets, supported by cone shaped Casimir pressurized Higgs field vacuum polarization. Dirkeland and Alfvén current circuits are supposed to be the result. Higgs-Casimir pressure vectors are depicted above and below.

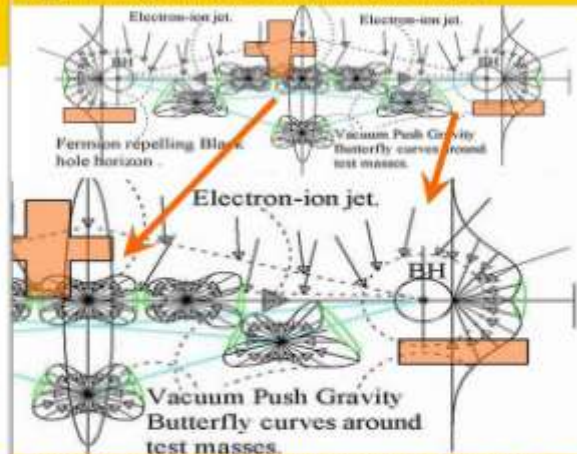

Below: Merging of spiral galaxies to form elliptical galaxies according to QuantumFFF Theory.

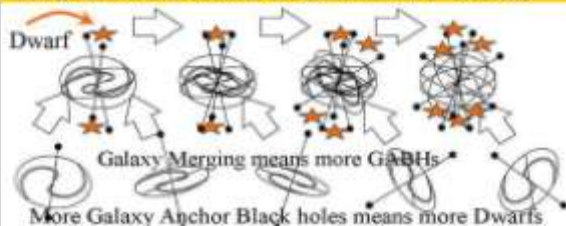

Figure 44,

SABH cosmic ray hotspots (electric dark matter black holes) as the origin and future slingshot accelerators of Brown Dwarfs expelled by the sun.

New giant gas planets expelled by the sun, moving away to the south, into the direction of the Southern cross SABH hotspot.

A hotspot for powerful cosmic rays found under the Big Dipper, by the University of Utah. The mysterious source of cosmic rays is also reason to look at the southern hemisphere to observe the opposing second Stellar Anchor Black Hole (SABH) (Cosmic ray production by NEW black hole paradigm according to Quantum-FFF Theory).



Dates 10Jan.2014 (below) and 11March.2012 (above). "Brown Dwarfs ?" according to Q-FFF.

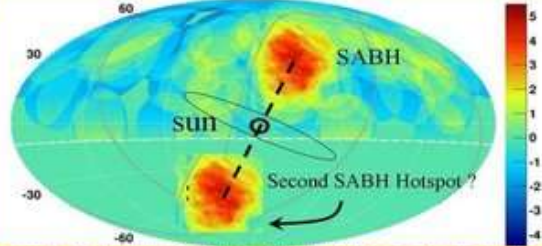
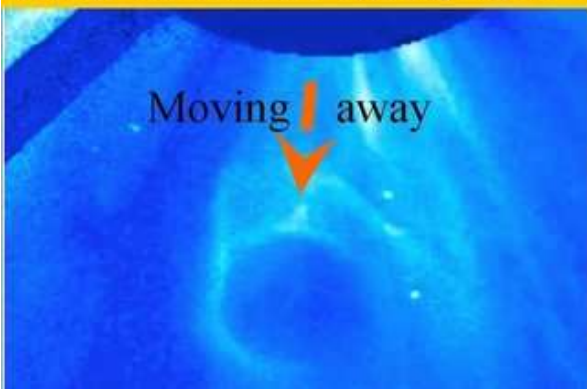

According to Quantum FFF Theory, "New Black Holes produce Proton- Electron plasma. By the strong Casimir vacuum push gravity on the BH, the "lighter" electrons will stay outside the "heavier" proton horizon (blue). As a consequence BHs have a strong electric potential, which is liberated by asymmetric processes in dual BH systems like Herbig Haro objects showing strong electro magnetic effects in open cluster star formation and Birkeland Alfvén circuits around the earth and even in the so called BICEP 2 results.

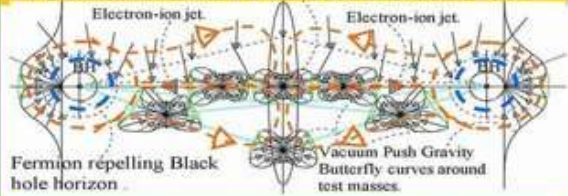

Scheme of the electric SABH principle around the sun.

Figure 45,

Charge splitting black holes and the mysterious dual pairing to form Herbig Haro objects, galaxies and starclusters.

Black holes create negative charged plasma and Herbig Haro Objects to form stars in between.

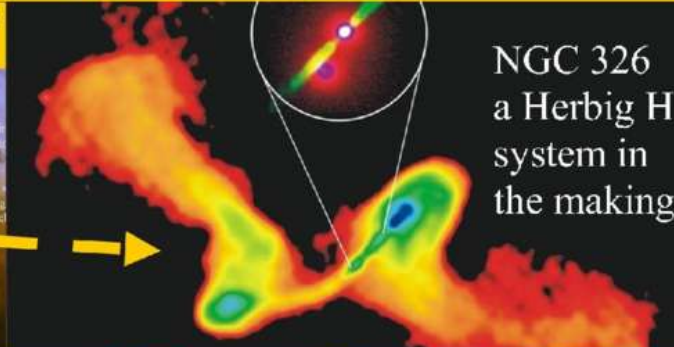
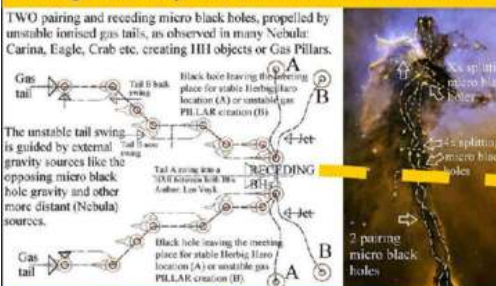

NGC 326 a Herbig H system in the making

Quantum FFF Theory says: Infalling observers (in BHs) and self created plasma will be pushed out (by fermion spin flip) and negative charged. The result is that the plasma will act as pushing accelerator to accelerate the BH away from nearby larger (BH) gravity sources. Consequently, equal sized black holes will find each other and form a so called plasma BAR, at a critical distance, but split in succession to form an electric Herbig Haro system as the base for an open star cluster. In the early universe however, these star cluster will grow into primordial galaxies. Those systems are observed as radio galaxies (below)

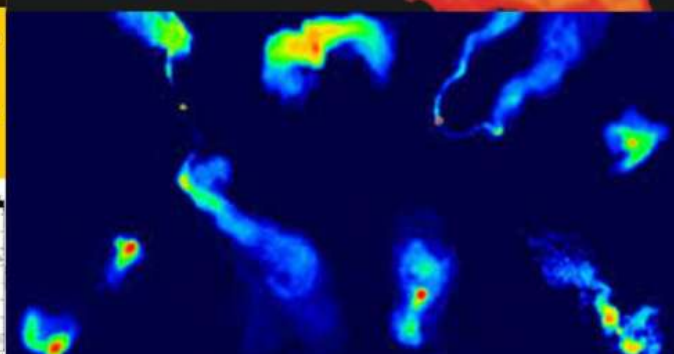
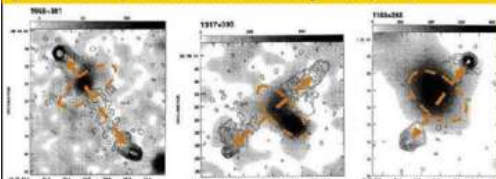
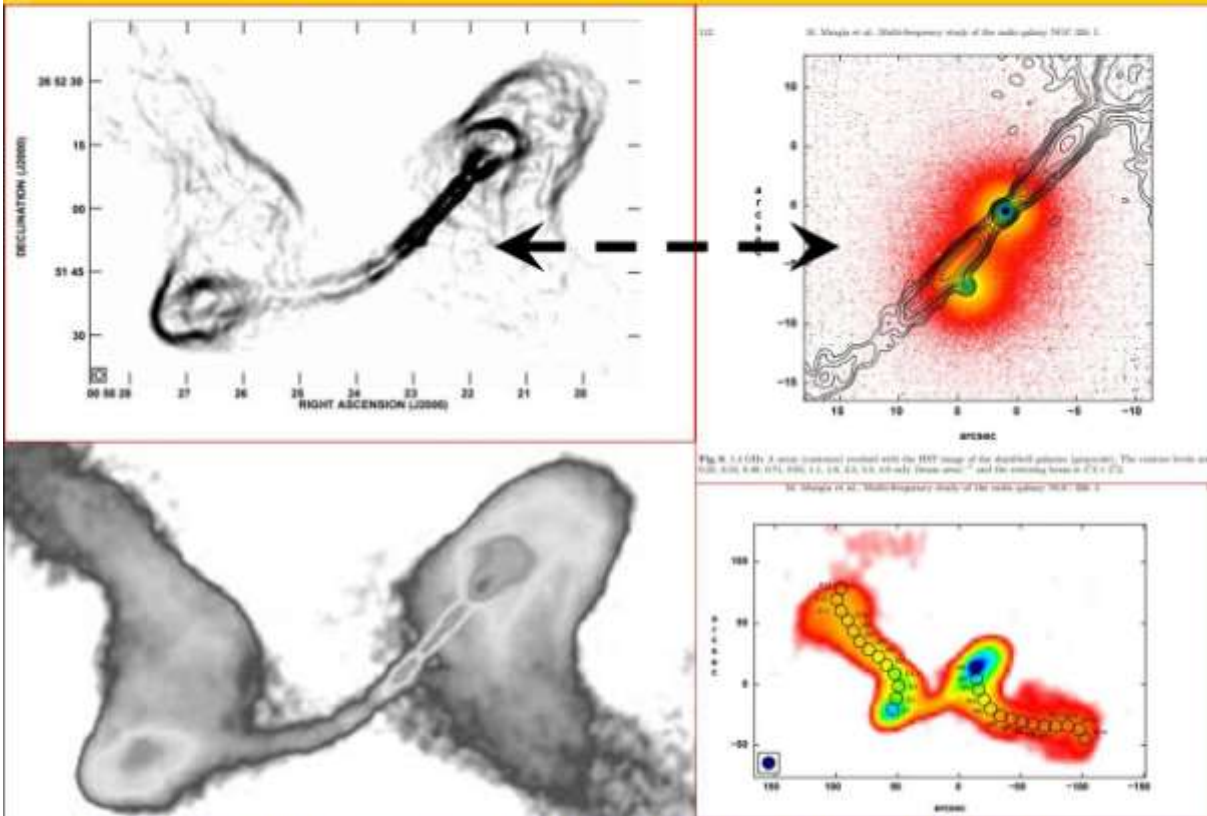

Figure 46,

Example of NGC 326: The Repelling of Two Equal sized Black Holes as the formation of a Herbig Haro Bowshock system, with star formation in between and double jets. According to Quantum FFF Theory.



@ images: A multi-frequency study of the radio galaxy NGC 326 by M.Murgia et al. (CNR Bologna.it.) <https://www.aanda.org/articles/aa/pdf/2001/46/aah3092.pdf>

Evidence for a Fermion Repelling New Physics Black Hole inside Herbig Haro (HH34) Bowshock ! Outflow Velocity differences between the leading black hole and the secondary Fermion plasma hotspots are the indication, according to Q-FFF Theory.

The black hole (O) has the smallest relative velocity. Conclusion: Secondary Fermionic plasma hotspots are repelled ! As predicted!

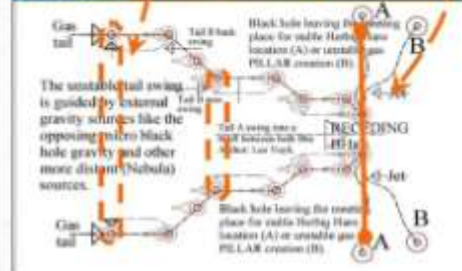
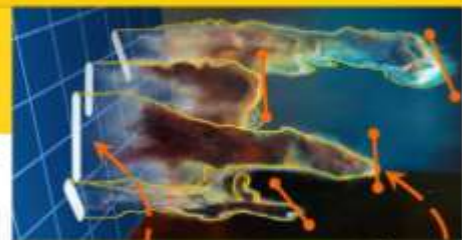
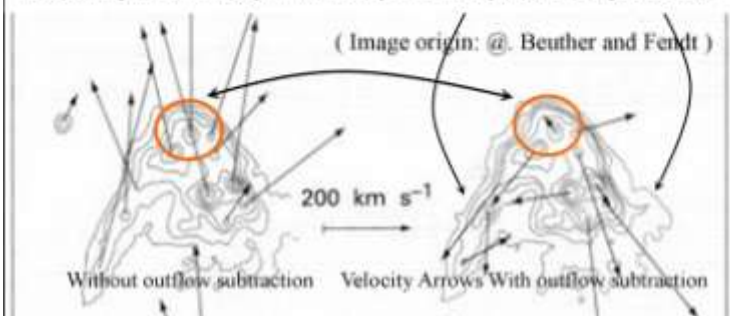
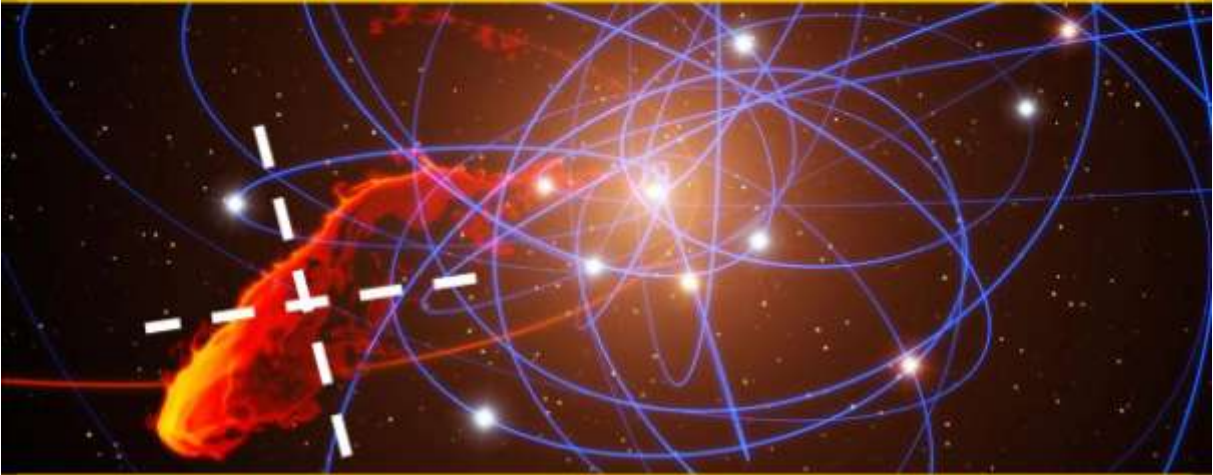

Figure 47,

Feeding the BH Dragon Sag-A

According to Quantum FFF Theory, propeller shaped stringy Fermions are repelled from a black hole at a certain distance.



Below: Time laps of the G2 Black hole/Gas object feeding Sag-A, changed into blueshift and disappear, (instead of flying back to the observer) by leaving charged gas components into the gas disc.

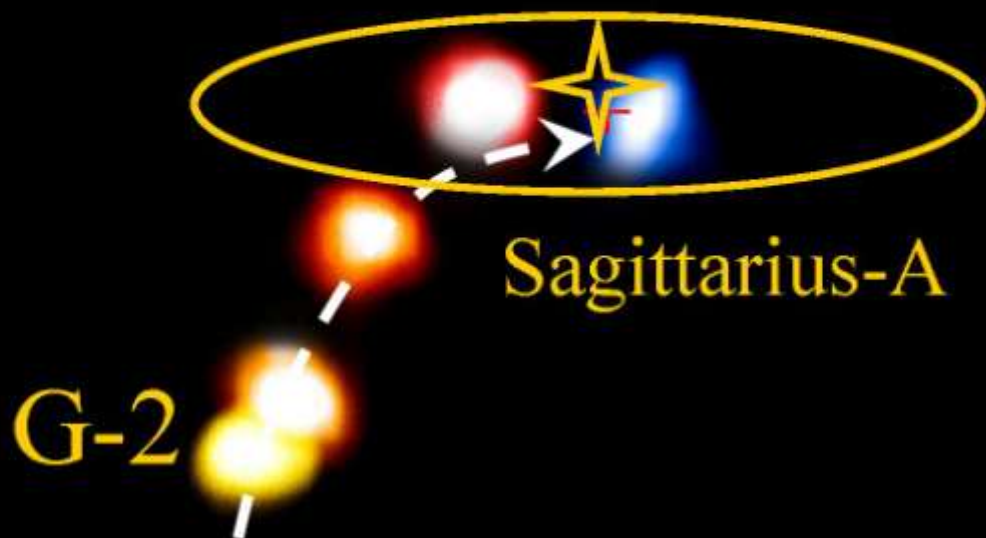
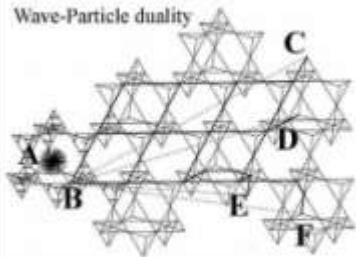

Figure 48,

What is wrong with Physics

Wave-Particle duality



Photon trajectories through the interrelated Higgs vacuum lattice.

A photon is created as a delocalized Higgs particle in position (A), then as a single (Higgs) photon particle which after some distance changes from back into a Higgs particle (B).
The photon energy is transferred into the oscillating Higgs system and oscillating through the vacuum lattice in the form of a rotating BECCO of entangled energetic Higgs oscillations with the local speed of light. The distance between two cycles of the BECCO resembles the wavelength of the photon radiating source (the beam also matches with the single photon double slit experiment).
After collision with a second fermion, at location C,D,E,F, the BECCO of energy and light and change the FORM of a local Higgs particle into the shape of the original fermion.
Two different shaped Higgses after some distance are called Photons.
The five different shaped Photons that they generate in Glass. Author: Leo Vuyk

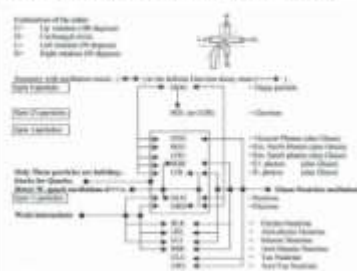

Author: Leo Vuyk 30-01-2011 NL



The "Eigen energy" distribution around the spinning fermion propagator, is supposed to come in cone form. The fermion spin and radiation is the product of a scattering process with oscillating Higgs vacuum particles. As a result, the fermion has a double spin around two polar axes. This is supposed to be the origin of a dipole magnetic field with North and South magnetic poles and the circular distribution of graviton and electric radiation. In addition it must be stated that all fermions are entangled with their object subject particles for away.

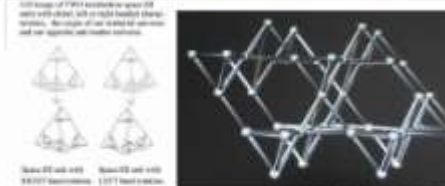

Leo Vuyk@Gmail.com <http://bigbang-entanglement.blogspot.com/>

At the Quantum level

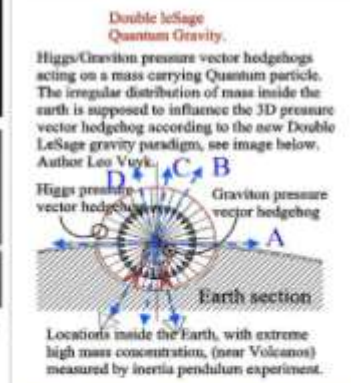

Oscillation directions A,B,C,D, of the NEW Inertia Oscillator device, will give larger DAMPING differences as expected by Newtonian gravity rules

<http://bigbang-entanglement.blogspot.com/>

Figure 51,

What is wrong with Physics at the astronomical scale?

Ball lightning pushed by Plasma tail against the wind

Vapour trail washed-out by the wind

Two accelerating, pairing and merging micro black holes in the Carina nebula with magnetic rearing plasma A

Two accelerating, pairing and merging micro black holes in the Carina nebula with magnetic rearing plasma A and second HD jet well

3x splitting micro black holes

2x splitting micro black holes

2 pairing micro black holes

The CPT SYMMETRIC MULTIVERSE CYCLE

The NEW Black Hole Paradigm

The Structure of the NEW Black Hole

Author: Leo Vuyk 4-02-2011 NL

Leo Vuyk@Gmail.com <http://bigbang-entanglement.blogspot.com/>

Figure 52,

THE SECRET OF BALL LIGHTNING. Its production by e.m.- x-ray interference into a KNOTTY Nucleus, able to accelerate, decrease Entropy and produce Vapour.



Falling RAIN DROPS 2

VAPOUR TRAIL.

RAIN

The NEW Black Hole Paradigm

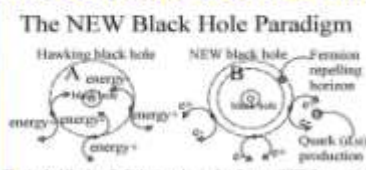

Hawking black hole **NEW black hole** - Fermion repelling horizon

energy- energy+ Quark (Qs) production



Ball lightning produced by Plasma to overcome the wind

Vapour trail washed-out by the wind



The standard Hawking Radiation presumes in that all matter (NOT all energy) is drawn into the Black hole. The NEW paradigm is that matter is even created (and pushed outside) as the Black hole loses by QUANTUM FLUCTUATIONS producing Electrons and Positrons.

The reason for this NEW Theory production effect is, that it is a consequence of the concentrations of local on Higgs particle collisions just at the horizon. Some Electrons and Positrons will annihilate, but the rest will form Quarks and plasma, because the Higgs vacuum barrier is CHARGED, and prefer to link Quarks to Positrons and from U- Quarks to Positrons and Electrons, which form D-Quarks.

These more Electrons will stay single and form Hydrogen atoms shells. However they have less mass than Quarks and feel less attraction to the Black hole nucleus, then Electrons form also an external shell around the Black hole inner shell of Positrons and atom Nucleus.

Due to the propeller shape of the particles all the plasma is expelled away from the Black hole? The Black hole will not evaporate?

This is the base for NEW Physics and a support for a new explanation of Cometary 5-rays, Hydrogen and AMINO ACID production, Even DNA Ribbe and Hurley Wave formation inside Volcano become a high base. Author Leo Vuyk.

How is the vacuum able to release energy to overcome the opposing wind? By SPIN FLIP and the Plasma tail is always swept at the back of the BL by the wind itself!



The Fermion repelling horizon

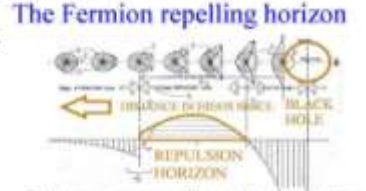

REPUSSION HORIZON

BLACK HOLE

IMPEDANCE TO FERMION TRAVEL

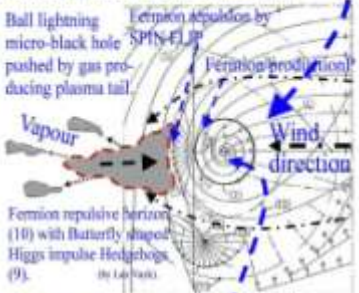

Ball lightning Electron repulsion by micro-black hole SPIN-FLIP

Vapour Fermion production pushed by gas producing plasma tail

Wind direction

Fermion repulsive horizon (10) with Butterfly shaped Higgs impulse Hedgehogs (9).

(by Leo Vuyk)

The creation of BL by x-ray interference

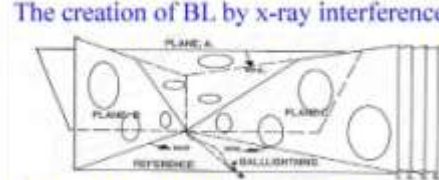

PLANE A, PLANE B, PLANE C, REFERENCE, BALL LIGHTNING



Knotty Micro-Black hole nucleus

Author: Leo Vuyk 10-02-2011 NL.

<http://bigbang-entanglement.blogspot.com/>

Figure 53,

LIGHTSPEED Extinction exp.

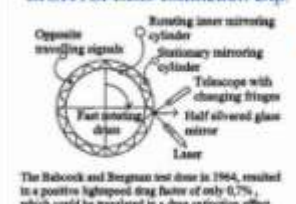

Opposite traveling signals, Rotating inner mirroring cylinder, Stationary mirroring cylinder, Telescope with changing fringes, Half silvered glass mirror, Laser

The Babcock and Bergman test done in 1964, resulted in a positive lightspeed drag factor of only 0.7%, which could be translated in a drag coefficient of about one over ten thousand after signal passage through the flat mirroring glass window. See: Journal of the Optical Society of America Vol. 54, nr 2 page 147-151 Febr. 1964. Determination of the Constancy of the speed of Light by Babcock and Bergman.

If the Quantum Mechanical Vacuum structure is influenced over a distance of 1 cm. by matter, as the Experiment done by Babcock and Bergman seems to indicate, then a flat mirroring mirror cylinder inside a stationary cylinder should influence the interference pattern produced inside the telescope much more, than the Babcock and Bergman's experiment did. We should get better results, if the distance between the inner and outer mirror cylinder is minimized and the number of lightspeed reflections is maximized.

Some FFF Theory related Experiments Function Follows Form in QM and Cosmo

Repeating investigation of the CHAMP/GPS satellite anomalous outliers of 180 meter, in relation to the gravity-drag LASOF Ellipsoidal EXTINCTION influence on the light/speed.

A clear example of GPS failure for sat-sat signals at higher altitudes (CHAMP- 430 km, GPS: 20 000km) Kinematic orbit solution comparisons showing GPS do to outliers up to 180 meters, (2x) during a CHAMP flight long 24 hours with 15 earth revolutions in 2003.

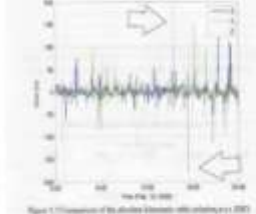

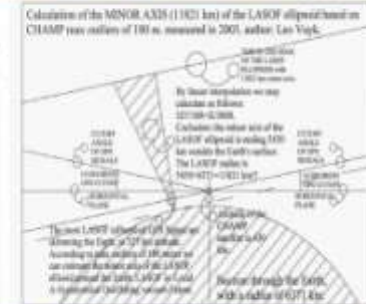

Calculation of the MINOR AXIS (180) km) of the LASOF ellipsoid on CHAMP (see outliers of 180 m. measured in 2003, author: Leo Vuyk)

It is been discovered we may calculate as follows:

Calculate the minor axis of the LASOF ellipsoid according to the LASOF radius 1400 km (1000 km) and the LASOF angle 14.5° (10.5°) etc.

The minor LASOF ellipsoid of GPS signal will be affected by the drag of 180 m. according to the calculation of the LASOF ellipsoid of 180 m. (1000 km) radius.

DOUBLE LeSage Gravity

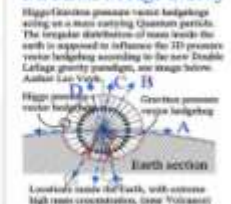

Higgs boson produces vector hedgehogs, which on a more complex Quantum particle. The regular distribution of mass levels the earth is supposed to influence the GPS precision vector hedgehogs according to the new Double LeSage gravity paradigm, see strange Science Author: Leo Vuyk, 10-02-2011.

Higgs boson Creation process vector hedgehogs

Earth section

LeSage's model of Earth, with extreme high mass concentration, since Volcanoes measured by inertia production experiments.

Chaotic structure A,B,C,D,E of the NEW inertia creation device, will give faster LASOF/GPS distances as explained by Quantum gravity model.

Support for Atomic ENTANGLEMENT in single and DOUBLE Stern Gerlach experiments

Since Stern Gerlach experiment, based on the hypothesis that the iron mirroring particles described by CHAMP, is the best 'quantifiable and measurable' in QM (Ch. 16, page 130-132) originated by a spin and wave form of moving beam to a distance between the first silver mirror (the S-G magnet) and the second, leading to the silver plate to be rotated. It is assumed, that the separation of particles and nuclei the silver wire, are always using 100 km/h. No, guarantee is that iron wire, and the absence of a 'MAGNETIC' effect author: Leo Vuyk, 25-10-2010

The traditional Stern Gerlach experiment.

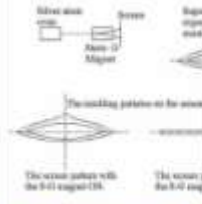

Silver wire, Magnet, Screen, Silver wire, Magnet, Screen

The resulting pattern on the screen.

The screen pattern with the S-G magnet ON.

The screen pattern with the S-G magnet OFF.

The new proposed experiment, with two S-G magnets always ON

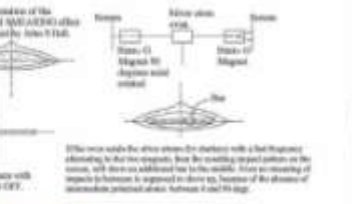

Silver wire, Magnet, Screen, Silver wire, Magnet, Screen

Other than within the silver wire (or chamber) with a flat frequency alternating, to the two magnets, from the resulting pattern on the screen, will show an additional line to the middle. From an increasing regular interference is expected to show up, because of the distance of intermediate, perpendicular, distance of 1 cm. long.

Opposite running LASER signal interference exp. in triangular shape between two Balloons or Satellites and the Earth.



GRAVITY DIRECTION DEPENDENT LIGHT SPEED FRAME DRAKING for LASOF (LeSage) Anti-Symmetrical Gas Blowing vacuum Friction. SIGAR shaped LASOF Double structure of the Earth with, propulsive for a future more heavy TRAVELER satellite signal interference experiment. Date: 9-12-2009 (2) This is an extension of Figure 301 dated: 14-05-2005) author: Leo Vuyk

Gravity dependent light propagation with 100% interference with opposite running signals. Signal A and B from Earth to the ground station that signal B is received after the signal interference is used for determining the other with another LASOF signal. At 1000 km (1000 km) the interference due to the LASOF effect.

Antisymmetrical LASOF structure of the Earth with, propulsive for a future more heavy TRAVELER satellite signal interference experiment. Date: 9-12-2009 (2) This is an extension of Figure 301 dated: 14-05-2005) author: Leo Vuyk

MULTIVERSE exp. New B.Libet experiments focused on RPI - RPII statistics.

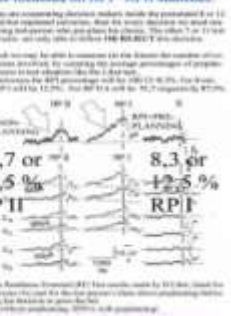

As a result many will be interested to know the number of the universe particles, by counting the average amount of particles in the universe in the last 100 years.

For 100 particles the RPI statistics will be 87.5% or 87.5% RPII

For 100 particles the RPI statistics will be 87.5% or 87.5% RPII

87.5% or 87.5% RPII

8.3 or 12.5% RPI

Author: Leo Vuyk 30-01-2011 NL.

LeoVuyk@Gmail.com <http://bigbang-entanglement.blogspot.com/>

Figure 54,

Gaia Untangles the Starry Strings of the Milky Way. (ESA)

Which tend to be oriented at right angles to the spiral arm nearest to our Solar System. (explanation, see below.) According to Quantum FFF Theory: originated by the Big Bang Dual Splinter Black Holes forming Herbig Haro twin Bowshocks with stars in between,

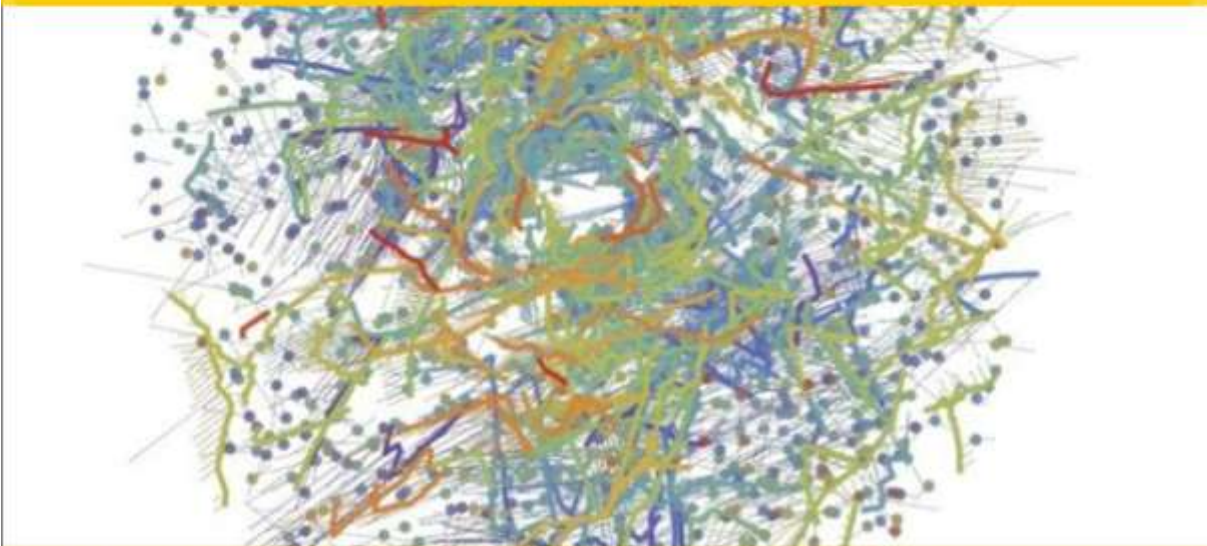

Splitting String Black Hole Inflation/Vacuum evaporation

The Origin of energy overdensities in the CMB EDM-BHs: Electric Dark Matter -Black Hole systems seem to be active at all scales. The Cosmic Background (CMB) energy overdensities can be explained by a Big Bang Black Hole splitting and evaporation process, according to Quantum FFF Theory.

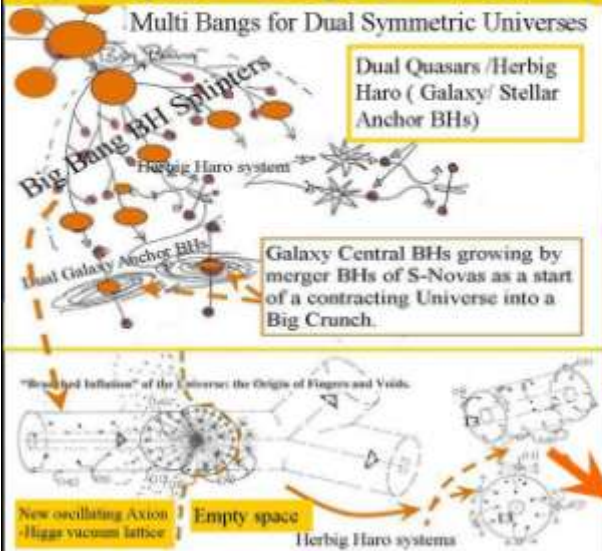

Cygnus A with dual plasma/gas producing "New physics" negative charged BHs as hotspots, with growing merger (SN) black hole in the center. Below: local Quantum vacuum push gravity vector butterflies originated by the BH vacuum absorption of dark vacuum energy.

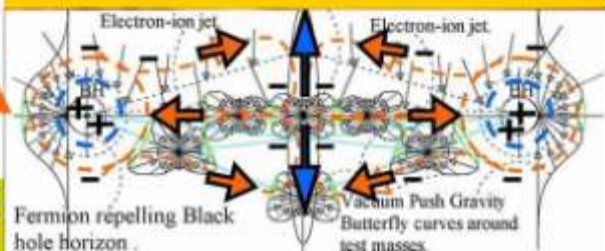

The origin of the Cosmic Alpha Forest (CAF) and Omega vacuum, by the splitting of the Big Bang black hole (BH) into two smaller separating black holes at the time of inflation, which compresses the pressure from the black hole (BH) into two smaller separating black holes at the time of inflation. The BH (1) also enters a very localized non-Herbig Haro vacuum near the Herbig Haro system, which is surrounded by the Galaxy Forming BH (2) below. However, single BH will give a BH with the nearest other BHs in

Figure 55.

Schrödinger's cat paradox solved with Anti Matter Copy Cats, living inside Entangled Raspberry Multiverse Bubbles.
see: The Conscious Undivided Multiverse, A Semi Classical Theory of Everything, based on Long Distance Multiverse Entangled Rigid String Topology.
<http://vixra.org/pdf/1905.0123v1.pdf>

Schrödinger's cat paradox solved with Anti Matter Copy Cats, living inside Entangled Raspberry Multiverse Bubbles.

Anti Matter deficit problem solved by the mirror symmetric Undivided Multiverse without dual Cats in boxes.



The Wavefunction collapse in the (CP symmetric) raspberry multiverse by the entangled observation between (anti) copy particles

According to Quantum FFF Theory, the collapse of the wavefunction is assumed to be triggered by particle collisions with instant entanglement between (anti-) COPY universes. So there is Charge and Parity symmetry between the entangled particles living in opposing universes. Each particle is its own observer!! Each human has to deal with one or more opposing anti-COPY humans.

Mirror symmetry between CP symmetric universes

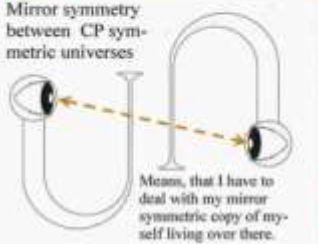

2:21 Section through the raspberry multiverse, with huge void in the middle. The void in the middle is supposed to be triggered by the state of the Planck process, when the vacuum density of the Planck multiverse was still too high for a five-globed Earth-like life (see the book).

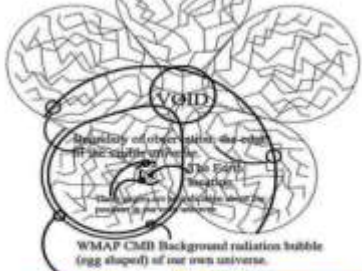

DID YOU EVER WONDER IF THE PERSON IN THE PUDDLE IS REAL, AND YOU'RE JUST A REFLECTION OF HIM?

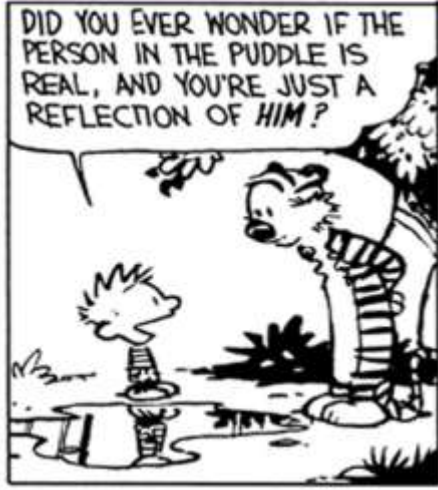

Figure 56.

The Benjamin Libet discovery about consciousness: two different Readiness Potentials (I and II) and the possibility to VETO an act.

Benjamin Libet measured the so called electric Readiness Potential (RP) time to perform a volitional act, in the brains of his students and the time of conscious awareness (TCA) of that act, which appeared to come 500 m.sec behind the RP. The “volitional act” was in principle based on the free choice to press an electric switch button. The results of this experiment gives still an ongoing debate in the broad layers of the scientific community, because the

results are still (also in recent experiments) in firm contrast with the expected idea of Free Will and causality. However I would propose the absurd but constructive possibility that we are not alone for decision making in a multiverse as an individual person. Even Max Tegmark suggested already about the multiverse: "Is there a copy of you reading this article?" We could be instant entangled with at least one instant entangled anti-copy person living inside a Charge and Parity symmetric copy Universe. In that case we could construct a causal explanation for Libet's strange results. New statistical difference research on RPI and RPII of repeated Libet experiments described here could support these ideas. Wikipedia says: "Democracy is a form of government in which all eligible citizens participate equally". Free will in a multiverse seems to be based on: all instant entangled ideas of copy persons living in all CP symmetric copy universes, have the same possibility to Veto an act and participate equally. If I am able to "Tap into" those instant entanglement connections" sent out by other people, then even telepathic effects (mind reading) could be explained. See also: "Democratic Free Will and Telepathy in the Instant Entangled Multiverse." <http://vixra.org/pdf/1612.0026v3.pdf>

QUANTUM FFF THEORY.

According to Quantum FFF Theory, (Function Follows Form) the FORM and microstructure of elementary particles, is supposed to be the origin of FUNCTIONAL differences between HiggsGraviton- Photon- and Fermion particles.

As a result, a NEW paradigm of splitting-, accelerating- and pairing Black Hole seems to be able to accelerate itself by a -Zero Point Energy driven-self created plasma tails (by a new Quantum Fluctuation process), to form dumbbell systems, of two or even more black holes. Inside Nebula these dumbbell systems are called Herbig Haro systems.

I think that Stephen Hawking did not calculate with the possibility of a chiral oscillating Higgs field vacuum lattice combined with propeller shaped Fermions. Then, due to Vacuum Chirality, Electron- and Positron propellers could both pushed away from the BH horizon after spin flip polarization at different distances, forming two charged separated spheres. With quark (plasma) formation in between.

Based on such a simple object (propeller and process) oriented ontology, Black Holes could be imagined as charge splitters violating the 2e law of thermodynamics, combined with a continuous microscopic big bang plasma creation process!

The result:

- 1: Black holes are the same as Dark Matter, they all consume photons, even gravitons and the Axion-Higgs field, but REPEL Fermions due to their propeller shape. They produce electric charged and plasma.
- 2: Dark Energy is the oscillating (Casimir) energy of the Higgs Field equipped with a tetrahedron lattice structure with variable Planck length..
- 3: Quantum Gravity = Dual Push gravity= Attraction (Higgs-Casimir opposing Graviton push).
- 4: The Big Bang is a Splitting dark matter Big Bang Black Hole (BBBH), splitting into smaller Primordial Big Bang Spinters (PBBS) forming the Fractal Lyman Alpha forest and evaporating partly into a zero mass energetic oscillating Higgs particle based Higgs field.
- 5: Dual PBBSs hotspots, produce central plasma concentration in electric Herbig Haro systems as a base for star formation in open star clusters as a start for Spiral Galaxies.
- 6: Spiral Galaxies will keep both Primordial Dark Matter Black Holes as Galaxy Anchor Black Holes (GABHs) at long distance.
- 7: After Galaxy Merging, these GABHs are the origin of Galaxy- and Magnetic field complexity and distant dwarf galaxies .

8: Black Holes produce Plasma direct out of the Higgs field because two Higgs particles are convertible into symmetric electron and positron (or even dual quark-) propellers (by BH horizon fluctuations).

9: The chirality of the (spiraling) vacuum lattice is the origin our material universe. (propeller shaped positrons merge preferentially first with gluons to form (u) Quarks to form Hydrogen.

10: The first Supernovas produce medium sized Black Holes as the base for secondary Herbig Haro systems and open star clusters.

11: ALL Dark Matter Black Holes are supposed to be charge separators with internal positive charge and an external globular shell of negative charged Quark electron plasma.

12: The lightspeed is related to gravity fields like the earth with long extinction distances to adapt with the solar gravity field. (figure 29)

13. Quantum FFF Theory states that the raspberry shaped multiverse is symmetric and instant entangled down to the smallest quantum level. Also down to living and dying CATS in BOXES.

14 Large Primordial Big Bang Spinters (PBBS) are responsible for the creation of the Lyman Alpha forest structure and first spiral galaxy forming of the universe, but they seem to be also responsible for the implosion of the universe at the end in the form of Galaxy Anchor Black Holes (GABHs) located mainly outside galaxies. see: (Quasisoft Chandra sources)

15, As a consequence of 12-14, Time is always local time in combination with cyclic period time of the multiverse.

16, If our material universes has a chiral left handed oscillating Higgs field, then our material Right Handed DNA helix molecule could be explained. However it also suggests that in our opposing symmetric anti-material entangled neighbor universe the DNA helix should have a Left handed spiral.

According to Max Tegmark: in an entangled multiverse we may ask: is there COPY PERSON over there, who is reading the same lines as I do? If this copy person is indeed living over there, then even our consciousness should be shared in a sort of entangled democratic form. Then we are not alone with our thoughts and doubts, see: Democratic Free Will in the instant Entangled Multiverse.

17, All particles and waves should be entangled with anti-copy particles and Higgs field based waves in our opposing anti universes. Then wave particle duality and the so called one particle double slit interference could be explained by accepting that real shaped 3D photon particles only exist in their function of Gluons. However Gluons should transfer form information to the oscillating luminiferous Axion-Higgs field ether, within about 1 cm distance from a fermion.(see: Babock and Bergman anomaly,1964)

18, Different elementary particles have different qualities by their different complex stringy shape. Leptons and Quarks have a propeller shape with left or right handed pitch creating charge difference. Gluons, Photons and Neutrino particles have no pitch.

20, All particles can be converted to one or more Higgs particles, Lepto Quarks can be compound particles.

21, All particles are assumed to be present as Higgs particles already in the cyclic Big Bang Black Hole (BBBH) after the former multiverse has collapsed into a Big Crunch Black Hole.

22, We seem to live inside one material universal bubble of an instant entangled (Charge Parity Time) CPT symmetric raspberry bubble multiverse. Each quantum jump or wave function collapse or human choice is guided by this instant entanglement at long distant. If our material universes has a chiral oscillating Higgs field, then our material Right Handed DNA helix molecule could be explained. However it also suggests that in our opposing Anti material multiverse neighbor universe the DNA helix should have a left handed spiral. According to Max Tegmark: in an entangled multiverse we may ask: is

There copy person over there, who is reading the same lines as I do? If this copy person is indeed living over there, then even our consciousness should be shared in a sort of democratic form,

References:

Books: The New God Particle and Free Will. Author: Leo Vuyk, LuLu publishers, 2008. ISBN number 978-1-4092-1031-3 <http://www.lulu.com/spotlight/LeoVuyk>

Quantum FFF Theory is also published in the form of POSTERS at the Flickr site: <http://www.flickr.com/photos/93308747@N05/>

Numbered listing of Vixra essays by Leo Vuyk. http://vixra.org/author/leo_vuyk

[127] [viXra:1907.0250](#) The Conscious Readiness Potential Ratio Multiverse with Transactional Interpretation of J. Cramer.

[126] [viXra:1905.0244](#) EM Drive Thruster by Anti Maxwell Monopole Tubular Field Reduction Around a Conductor.

[125] [viXra:1905.0123](#) The Conscious Undivided Multiverse.

[124] viXra:1904.0599 The Origin of Universal Structure: Herbig Haro -Electric Dark Matter Black Hole- Systems.

[123] viXra:1903.0447 Black Hole Creation and Destruction of the Cyclic Conscious Multiverse.

[122] viXra:1903.0347 Visualizing Subatomic Particles as Building Blocks of the Universe.

[121] viXra:1903.0102 What Is Wrong With Physics?

[120] viXra:1902.0349 The Electric Universe by Electric Dark Matter Big Bang Black Holes of Quantum FFF Theory.

[119] viXra:1902.0201 Novel Ideas About Dark Matter and the SuSy Multiverse.

[118] viXra:1901.0426 4x and 3x Interference for Stringy Bose Einstein Black Hole Production.

[117] viXra:1812.0228 Equal Sized Rigid String Based New Black Holes do not Merge But, Form Herbig Haro Systems.

[116] viXra:1812.0095 $E = \text{not } Mc^2$ in Massless Black Holes According to Quantum FFF Theory.

[115] viXra:1811.0125 Testing Proposals for Human Free Will in the Raspberry Multiverse, Local Entanglement and M&M Lightspeed.

[114] viXra:1811.0002 Big Bang Energy out of Nothing, or a Compressed Rigid String Nucleus

[113] viXra:1809.0189 Apparent Violation of the Second Law, Around Black Hole Nuclei and Other Quantum Knots.

[112] viXra:1807.0437 Preference for Dual Herbig Haro Black Hole Consumption by the Central MW Black Hole, Leaving Plasma Jets Behind.

- [111] viXra:1806.0368 A Fifth Force Vacuum Dipole Repeller, Needed to Create All Attraction Forces Even Around Black Holes in Quantum FFF Theory.
- [110] viXra:1806.0298 Expanding Earth, by Growing Water based Crashed Comet core.
- [109] viXra:1806.0068 Primordial Electric Dark Matter Black Holes Outside Galaxies Responsible for the Creation and Contraction of a Cyclic Multi-Universe.
- [108] viXra:1805.0541 Tidal Star Disruption Events (TDE) by Fermion Repelling Black Holes in Quantum FFF Theory.
- [107] viXra:1805.0307 Fulgurite Created by Lightning Bullet Also Known as Ball Lightning, According to Quantum FFF Theory.
- [106] viXra:1804.0138 Non Inertial Dark Matter Black Hole Galaxy Hierarchy According to Quantum FFF Theory.
- [105] viXra:1803.0100 submitted Free Will Readiness Potential Ratios, the Key for a Multiverse Number Calculation.
- [104] viXra:1803.0093 Skyrmion Interference Black Holes, Photonic Molecules, Ball Lightning, Micro Comets, Sprite-Fireballs and Sunspots According to Quantum FFF Theory.
- [103] viXra:1801.0121 Quantum FFF Theory, a Conscious String Theory with Different Vacuum Trajectories for Axion-Higgs Field/ Photons Respectively Fermions, Gluons and Bosons.
- [102] viXra:1711.0379 The Raspberry Shaped Multiverse, Pulsating Between Big Crunch and Big Bang, Based on Rigid Transformable Massless Axion Higgs Particles.
- [101] viXra:1711.0327 The Einstein Cross Lensing Effect Explained by the Quadruple Dark Matter Formation Process of Edge-on Spiral Galaxies, According to Quantum FFF Theory.
- [100] viXra:1711.0237 Higgs Particle Based SIMPs for Ancient and Future (Stone) Cutting Technology.
- [99] viXra:1711.0112 Higgs Quantum Knots is Dark Matter is Black Holes or: Higgs Dark Matter Black Holes.
- [98] viXra:1710.0257 Kilonova Merger Black Holes as the Origin of Dark Matter Black Hole Halo Population.
- [97] viXra:1710.0115 Grand Unification of 4 Forces According to the Quantum FFF Model by di-Monopole Repeller Rigid String Pressure.
- [96] viXra:1710.0050 Emergent Gravity by Dipole Repeller Rigid String Pressure the Origin of Quantum Gravity and Non Inertial Black Holes.
- [95] viXra:1710.0034 The New Physics Black Hole Nucleus: Gravity Without Inertial Mass Effects.
- [94] viXra:1709.0396 Dual Solar Anchor Black Holes or Herbig Haro Hotspots, the Origin of Quick Star Formation.
- [93] viXra:1709.0388 Splitting Dark Matter Black Hole Big Bang as the Origin of Ultra-Energetic-Cosmic-Rays-From Far-Away
- [92] viXra:1709.0216 Photonic Molecule based Higgs Photonic Knots of Different Masses the Origin of Future Lightsaber use?
- [91] viXra:1708.0296 The Origin of "Ultra Diffuse Galaxies" in Galaxy Cluster Centers.
- [90] viXra:1708.0170 Action Without Reaction Symmetry for em Space Propulsion Thruster Technology.
- [89] viXra:1708.0083 Dipole Repeller Gravity Effects at Different Universal Scales as the Origin of Large Scale and Local Quantum Gravity and Hubble Redshift.
- [88] viXra:1707.0224 The Magic of the New Electric Dark Matter Black Hole on Earth and Space.
- [87] viXra:1707.0189 Black Hole Nuclei as a Bunch of Rigid Transformable Higgs Strings Splitting by Relative Small Companion Mergers or Decreased Vacuum Pressure.
- [86] viXra:1706.0490 The Origin of "Dead" Galaxies.

- [85] viXra:1706.0420 Mass in Motion According to Quantum FFF Theory.
- [84] viXra:1706.0413 Magnetic Monopole Test to Demonstrate the Existence of a Anti Maxwell Dead Zone Around a Current in a Wire.
- [83] viXra:1705.0153 A Different Black Hole Horizon Interpretation Leading to Entropy Reduction and Violation of the Second Law.
- [82] viXra:1705.0026 The Magic of Life- and Matter Creating Self Propelled Electric Dark Matter Black Holes Guided by a Holographic Entangled Symmetric Multiverse System.
- [81] viXra:1704.0272 Interference Black Holes, Ball Lightning, Micro Comets, Sprite Fireballs and Sunspots According to Quantum FFF Theory.
- [80] viXra:1704.0150 The Origin of Life and the Need for a Rigid String Propeller Fermion Model Combined with a Chiral Vacuum Lattice and Micro Interference Black Holes
- [79] viXra:1704.0133 2. Signals for Retarded Single Big Bang Black Hole Nucleus Splitting and Pairing into Dual Black Hole Herbig Haro Systems
- [78] viXra:1704.0047 Bohmian Double Slit Interpretation by Dual Entangled Universes, and the Benjamin Libet Experiment.
- [77] viXra:1704.0003 A Testable CP Symmetric Multiverse Model by Extended Experiments, Done by the Late Benjamin Libet in 1964.
- [76] viXra:1702.0109 CP Symmetry Between Material and Anti Material Copy Universes Combined with Local- and Multi-Universal Cycle Time.
- [75] viXra:1702.0040 The Alternative Origin of Hubble Redshift : Vacuum Absorption by black holes as a Support for Quantum Dipole Repeller Gravity and a Contracting Universe.
- [74] viXra:1701.0633 Local and Multi-Universal Cycle Time According to Quantum FFF Theory. (FFF= Function Follows Form)
- [73] viXra:1612.0365 John S. Bell Was Right: “How to Teach Special Relativity” and Atomic Pear Shaped Contraction.
- [72] viXra:1612.0026 Democratic Free Will and Telepathy in the Instant Entangled
- [71] viXra:1611.0226 Galaxy Cluster Merging and Vacuum Absorption by black holes as a Support for Quantum Dipole Repeller Gravity and a Contracting Universe.
- [70] viXra:1611.0101 Observed Dual Higgs Mass 124-126 Gev and the Chirality of the Vacuum Lattice.
- [69] viXra:1611.0031 Rigid String Cosmology with a Massless Axion-Higgs Oscillating Photon Vacuum Lattice and Massive Quantum Knots.
- [68] viXra:1611.0005 Electric Dark Matter Black Holes in the Moon (Orientale Basin)
- [67] viXra:1609.0407 New Physics Elements in the Quantum Function Follows Form Model.
- [66] viXra:1608.0329 God Seems to Play Dice with Dual Entangled Pinball Machines in a Super symmetric (Susy) Multiverse
- [65] viXra:1607.0376 Axion-Higgs 3-Dimensional Rigid Transformable Strings and the Compound 650 GeV Z-Z Decay into Quarks/Lepto quarks.
- [64] viXra:1605.0257 Reaction Less Drive by Anti Maxwell Dead Zone Around a Wire.
- [63] viXra:1604.0372 Herbig Haro Hotspots or Bow shocks Are the Origin of Star Formation, not the Result as the Mainstream Suggest.
- [62] viXra:1604.0229 $E_r = epr$ in the Super symmetric Cyclic Multiverse and in the Lab Without Strange Cats.
- [59] viXra:1505.0101 The Origin of Bok Globules and Molecular Clouds, Splitting and Pairing Electric Dark Matter Black Holes.
- [58] viXra:1503.0186 Primordial Dark Matter Black Holes Outside Galaxies Responsible for the Creation and Contraction of a Cyclic Universe? 22
- [57] viXra:1503.0097 Quantum FFF Theory, Poster News 4.2

[56] viXra:1502.0086 Parity and Chirality as a Base for Quark-Gluon Plasma and Dust Creating Black Holes and the Beginning and End of Time..

[55] viXra:1411.0039 Quantum FFF Theory, Poster News 2

[54] viXra:1410.0039 Evidence for Dark Matter Black Hole Based Plasma, Dust and Ice Production Inside Comets Like 67P,C-G. and the Growing Earth.

[53] viXra:1409.0164 The O'Connell Effect in Eclipsing Binaries Explained by Mass Related Light Speed Extinction Distances (Lasof) of Stars and Even Planets. (See also figure 29)

[52] viXra:1407.0001 Evidence for Evaporating Dark Matter Particles in Silicon Fireballs.

[51] viXra:1406.0076 Galaxy Formation and Evolution According to Quantum FFF Theory.

[50] viXra:1406.0019 Quantum FFF Theory Proposals for Some Unsolved Physics Problems.

[49] viXra:1405.0224 Dual Star Ejection in Open Star Clusters by the Central Star.

[48] viXra:1404.0151 Future Free Energy of New Physics Ball Lightning Black Holes, the Origin of a Super Social Society or the Opposite?

[47] viXra:1404.0002 Proposal for the Origin of Unexpected Large B-Modes Found in the Bicep2 Measurements.

[46] viXra:1402.0132 Reconciliation of GR and QM by a New Gravity-Black Hole and Lightspeed Model Called Quantum- FFF Theory.

[45] viXra:1402.0044 The Impossible Zero Point Electric Black Hole as the Origin of New Physics even for Comets like 67P,C-G.

[44] viXra:1401.0115 Calabi Yau Shaped Double Fermion Spin States.

[43] viXra:1401.0071 Democratic Free Will in the Instant Entangled Multiverse.

[42] viXra:1312.0143 The Navel Cord Multiverse with Raspberry Shape, a Super Symmetric Entangled 12 Fold Bubble Universe.

[41] viXra:1312.0076 Are Sunspots Made of Gravitating Dark Matter Black Holes?

[40] viXra:1310.0101 The New Nuclear Magic Number (34) Explained by the Polar Coaxial Ring System of Quantum FFF Theory.

[39] viXra:1310.0059 The Semi Relativistic Higgs Field Aether with Mass Related Lightspeed Adaptation.

[38] viXra:1309.0081 New Physics by Table Top Experiments.

[37] viXra:1308.0083 23 The Raspberry Shaped Super Symmetric Multiverse

[36] viXra:1307.0068 Quantum Function Follows Form Theory, the Small Scale, Posters part 1.

[35] viXra:1307.0067 Quantum Function Follows Form Theory, the Large Scale, Posters part 2.

[34] viXra:1306.0218) Dark Matter UFO Dust Particles or Quantum Knots in the LHC at CERN ?

33, viXra:1306.0065 The Splitting Dark Matter- Black Hole- Big Bang and the Cyclic Multiverse.

32, viXra:1305.0140 Quantum FFF Theory Experiments, a Summary.

31, viXra:1305.0041 The Shnoll Effect Explained by Quantum FFF Theory.

30, viXra:1304.0022 The Self Organizing Universe in the Carina Nebula.

29, viXra:1303.0211 Hubble Redshift Combined with Universal Contraction is Possible.

28, viXra:1303.0053 Micro Birkeland Currents Between Two RF Generated Plasma Balls in the Laboratory.

27, viXra:1302.0172 Silicon Based Ball Lightning Globule Structures and Signs for Accumulation and Retarded Decrease of Tunneling Energy Bullets.

26, viXra:1301.0088 Two or Three Large Quasar Groups (LQGs) Located at the Start of Two or Three Lyman Alpha Systems and a Part of the Raspberry Multiverse?

25, viXra:1301.0050 Dwarf Galaxies and Their Relation with Dark Matter Based Galaxy Anchor Black Holes (Gabhs).

- 24, viXra:1210.0177 Instant Broglie Bohm Pilot Waves, the Origin of All Entanglement Effects in the Lab and Wavefunction Collapses in Our Universe as Related to Our Opposing Anti-Copy Universe(s) According to Quantum FFF Theory.
- 23, viXra:1209.0092 New Dark Matter Black Holes and a New Dark Energy Higgs Field, Lead to a Bouncing CP Symmetrical Multiverse, and New Experiments.
- 22, viXra:1209.0061 Birkeland Currents, Sunspots, Comets and Ball Lightning Originated by New Paradigm Dark Matter Black Holes.
- 21, viXra:1209.0030 Majorana and Sterile Neutrino Solutions in the Quantum-FFF Model.
- 20, viXra:1208.0031 Clumpy Dark Matter Around Dwarf Galaxies a Support for an Alternative Black Hole Theory According to the Quantum Function Follows Form Model.
- 19, viXra:1202.0091 Earth Magnetic Monopole Array Field Interaction with Cyclotron – Synchrotron Electrons and Muon Conversion Used for Levitation Systems.
- 18, viXra:1201.0092 Earth Magnetic Monopole Array Field Interaction with Cyclotron Electrons used for Levitation Systems.
- 17, viXra:1112.0065 24 LHC Signals Between 121-130 Gev Interpreted with Quantum-FFF Theory
- 16, viXra:1111.0096 Reconciliation of QM and GR and the Need for a Pulsating Entangled CPT Symmetric Raspberry Shaped Multiverse.
- 15, viXra:1111.0061 Black Hole Horizon Curvature Dependent Balance Between Plasma Creation and e-e+ Annihilation in Quantum FFF Theory.
- 14, viXra:1108.0036 Artificial Ball Lightning Production and Exploitation Device for Zero Point Electric Energy Usage.
- 13, viXra:1108.0006 Mass in Motion in Quantum FFF Theory
- 12, viXra:1104.0083 Quantum FFF Theory in Posters.
- 11, viXra:1104.0044 Ball Lightning, Micro Comets, Sprite-Fireballs and X-Ray/gamma Flashes According to Quantum FFF Theory.
- 10, viXra:1104.0002 Stellar Anchor Black Holes as the Remnants of Former Herbig Haro Objects
- 9, viXra:1103.0097 ZPE Zero Point Energy Examples Around Black Holes.
- 8, viXra:1103.0068 Function Follows Form, at the Quantum Scale and Beyond.
- 7, viXra:1103.0024 Quantum Gravity and Electro Magnetic Forces in FFF Theory
- 6, viXra:1103.0015 Wavefunction Collapse and Human Choice-Making Inside an Entangled Mirror Symmetrical Multiverse.
- 5, viXra:1103.0011 An Alternative Black Hole, Provided with Entropy Decrease and Plasma Creation
- 4, viXra:1103.0002 3- Dimensional String Based Alternative Particles Model
- 3, viXra:1102.0056 Experiments to Determine the Mass Related Lightspeed Extinction Volume around massive objects.
- 2, viXra:1102.0054 Atomic Nuclear Geometry Based on Magic Number Logic.
- 1, viXra:1102.0052 Construction Principles for Chiral “atoms of Spacetim

=====