

Calculation of the Standard Model parameters and particles based on a SU(4) preon model

Jan Helm
Technical University Berlin
Email: jan.helm@alumni.tu-berlin.de

Abstract

This paper describes an extension and a new foundation of the Standard Model of particle physics based on a SU(4)-force called hyper-color. The hyper-color force is a generalization of the SU(2)-based weak interaction and the SU(1)-based right-chiral self-interaction, in which the W- and the Z-bosons are Yukawa residual-field-carriers of the hyper-color force, in the same sense as the pions are the residual-field-carriers of the color SU(3) interaction.

Using the method of numerical minimization of the SU(4)-Lagrangian based on this model, the masses and the inner structure of leptons, quarks and weak bosons are calculated: the mass results are very close to the experimental values. We calculate also precisely the value of the Cabibbo angle, so the mixing matrices of the Standard model, CKM matrix for quarks and PMNS matrix for neutrinos can also be calculated. In total, we reduce the 28 parameters of the Standard Model to 2 masses and 2 parameters of the hyper-color coupling constant.

- 2
1. SU(4) gauge theory
 2. The Standard Model and QCD, the SU(4)-preon model and QHCD
 3. The calculation method for the SU(4)-preon model
 4. The particles and families of the SU(4)-preon model
 5. Weak hadron decays in the SU(4)-preon model

1. SU(4) gauge theory

Gauge theory

In the following, we consider the gauge theory QCD (quantum chromodynamics) based on SU(3) and the gauge theory QHCD (quantum hyper-color dynamics) based on SU(4).

The gauge invariant QCD Lagrangian is ($\hbar = c = 1$)

$$L = \bar{\psi} (i\gamma^\mu D_\mu - m)\psi - \frac{1}{4} G^a_{\mu\nu} G_a{}^{\mu\nu}$$

where $\psi_i(\mathbf{x})$ is the quark field, a dynamical function of spacetime, in the fundamental representation of the SU(3) gauge group, indexed by i, j, \dots ; $A_\mu^a(\mathbf{x})$ are the fields, also dynamical functions of spacetime, in the adjoint representation of the SU(3) or the SU(4) gauge group, indexed by a, b, \dots . The γ^μ are Dirac matrices connecting the spinor representation to the vector representation of the Lorentz group.

The total field is $A_\mu(x) \equiv A_\mu^a(x) \cdot \lambda_a/2$, and the Dirac-conjugate

$\bar{\psi}_i(x) = \psi_i^c(x)\gamma^0$, where ψ_i^c is the complex-conjugate.

D_μ is the gauge covariant derivative $D_\mu := \partial_\mu - ig A_\mu^\alpha \lambda_\alpha$ where g is the coupling constant.

For the QCD based on SU(3), $A_\mu^a(x)$ is the (color) gluon gauge field, for eight different gluons is a four-component Dirac spinor, and where λ_a is one of the eight Gell-Mann matrices, $A_\mu^a(x)$ is the hc-boson field, for 15 hc-bosons and λ_a are the 15 generators of the SU(4),

$$\lambda_1 = \begin{pmatrix} 0 & 1 & 0 & 0 \\ 1 & 0 & 0 & 0 \\ 0 & 0 & 0 & 0 \\ 0 & 0 & 0 & 0 \end{pmatrix}, \lambda_2 = \begin{pmatrix} 0 & -i & 0 & 0 \\ i & 0 & 0 & 0 \\ 0 & 0 & 0 & 0 \\ 0 & 0 & 0 & 0 \end{pmatrix}, \lambda_3 = \begin{pmatrix} 1 & 0 & 0 & 0 \\ 0 & -1 & 0 & 0 \\ 0 & 0 & 0 & 0 \\ 0 & 0 & 0 & 0 \end{pmatrix}$$

$$\lambda_4 = \begin{pmatrix} 0 & 0 & 1 & 0 \\ 0 & 0 & 0 & 0 \\ 1 & 0 & 0 & 0 \\ 0 & 0 & 0 & 0 \end{pmatrix}, \lambda_5 = \begin{pmatrix} 0 & 0 & -i & 0 \\ 0 & 0 & 0 & 0 \\ i & 0 & 0 & 0 \\ 0 & 0 & 0 & 0 \end{pmatrix}, \lambda_6 = \begin{pmatrix} 0 & 0 & 0 & 0 \\ 0 & 0 & 1 & 0 \\ 0 & 1 & 0 & 0 \\ 0 & 0 & 0 & 0 \end{pmatrix}$$

$$\lambda_7 = \begin{pmatrix} 0 & 0 & 0 & 0 \\ 0 & 0 & -i & 0 \\ 0 & i & 0 & 0 \\ 0 & 0 & 0 & 0 \end{pmatrix}, \lambda_8 = \frac{1}{\sqrt{3}} \begin{pmatrix} 1 & 0 & 0 & 0 \\ 0 & 1 & 0 & 0 \\ 0 & 0 & -2 & 0 \\ 0 & 0 & 0 & 0 \end{pmatrix}, \lambda_9 = \begin{pmatrix} 0 & 0 & 0 & 1 \\ 0 & 0 & 0 & 0 \\ 0 & 0 & 0 & 0 \\ 1 & 0 & 0 & 0 \end{pmatrix}$$

$$\lambda_{10} = \begin{pmatrix} 0 & 0 & 0 & -i \\ 0 & 0 & 0 & 0 \\ 0 & 0 & 0 & 0 \\ i & 0 & 0 & 0 \end{pmatrix}, \lambda_{11} = \begin{pmatrix} 0 & 0 & 0 & 0 \\ 0 & 0 & 0 & 1 \\ 0 & 0 & 0 & 0 \\ 0 & 1 & 0 & 0 \end{pmatrix}, \lambda_{12} = \begin{pmatrix} 0 & 0 & 0 & 0 \\ 0 & 0 & 0 & -i \\ 0 & 0 & 0 & 0 \\ 0 & i & 0 & 0 \end{pmatrix}$$

$$\lambda_{13} = \begin{pmatrix} 0 & 0 & 0 & 0 \\ 0 & 0 & 0 & 0 \\ 0 & 0 & 0 & 1 \\ 0 & 0 & 1 & 0 \end{pmatrix}, \lambda_{14} = \begin{pmatrix} 0 & 0 & 0 & 0 \\ 0 & 0 & 0 & 0 \\ 0 & 0 & 0 & -i \\ 0 & 0 & i & 0 \end{pmatrix}, \lambda_{15} = \frac{1}{\sqrt{6}} \begin{pmatrix} 1 & 0 & 0 & 0 \\ 0 & 1 & 0 & 0 \\ 0 & 0 & 1 & 0 \\ 0 & 0 & 0 & -3 \end{pmatrix}$$

The λ_μ matrices are orthogonal under trace $\text{Tr}()$ and satisfy

$$\text{Tr}(\lambda_\mu)^2 = 2; \quad \mu = 1 \dots 15$$

The symbol $G_{\mu\nu}^a$ represents the gauge invariant field strength tensor, analogous to the electromagnetic field strength tensor, $F^{\mu\nu}$, in quantum electrodynamics. It is given by

$$G^a_{\mu\nu} = \partial_\mu A^a_\nu - \partial_\nu A^a_\mu + g f^{abc} A^b_\mu A^c_\nu$$

where f_{abc} are the structure constants of SU(3) or SU(4) : the generators T^a satisfy the commutator relations $[T^a, T^b] = i f^{abc} T^c$

Yang-Mills theory

Yang-Mills theories are a special example of gauge theory with a non-commutative symmetry group given by the Lagrangian [12]

$$\mathcal{L}_{\text{gf}} = -\frac{1}{2} \text{Tr}(F^2) = -\frac{1}{4} F^{\alpha\mu\nu} F^a_{\mu\nu}, \quad \text{where for QCD with SU(3) } F = G^a_{\mu\nu}$$

with the generators of the Lie algebra, indexed by a , corresponding to the F -quantities (the curvature or field-strength form) satisfying

$$\text{Tr}(T^a T^b) = \frac{1}{2} \delta^{ab}, \quad [T^a, T^b] = i f^{abc} T^c,$$

where the f^{abc} are structure constants of the Lie algebra, and the covariant derivative defined as

$$D_\mu = I \partial_\mu - ig T^a A^a_\mu$$

where I is the identity matrix (matching the size of the generators), A^a_μ is the vector potential, and g is the coupling constant. In four dimensions, the coupling constant g is a pure number and for a SU(N) group one has

The relation

$$F_{\mu\nu}^a = \partial_\mu A_\nu^a - \partial_\nu A_\mu^a + gf^{abc} A_\mu^b A_\nu^c$$

follows from the commutator for the covariant derivative D_μ

$$[D_\mu, D_\nu] = -igT^a F_{\mu\nu}^a.$$

The field has the property of being self-interacting and equations of motion that one obtains are said to be semilinear, as nonlinearities are both with and without derivatives. This means that one can manage this theory only by perturbation theory, with small nonlinearities.

From the given Lagrangian one can derive the equations of motion given by

$$\partial^\mu F_{\mu\nu}^a + gf^{abc} A^{\mu b} F_{\mu\nu}^c = 0. \quad (\text{Yang-Mills-equations}), \text{ which correspond to the Maxwell equations in}$$

electrodynamics, where $f^{abc} = 0$

Putting these can be rewritten as

$$(D^\mu F_{\mu\nu})^a = 0.$$

The Bianchi identity holds

$$(D_\mu F_{\nu\kappa})^a + (D_\kappa F_{\mu\nu})^a + (D_\nu F_{\kappa\mu})^a = 0$$

which is equivalent to the Jacobi identity

$$[D_\mu, [D_\nu, D_\kappa]] + [D_\kappa, [D_\mu, D_\nu]] + [D_\nu, [D_\kappa, D_\mu]] = 0 \quad \text{for Lie-groups}$$

since Define the dual strength tensor $\tilde{F}^{\mu\nu} = \frac{1}{2}\epsilon^{\mu\nu\rho\sigma} F_{\rho\sigma}$ then the Bianchi identity can be rewritten as

$$D_\mu \tilde{F}^{\mu\nu} = 0.$$

A source current J^a_ν enters into the equations of motion (eom) as

$$\partial^\mu F_{\mu\nu}^a + gf^{abc} A^{\mu b} F_{\mu\nu}^c = -J_\nu^a.$$

The Dirac part of the Lagrangian is

$$L_D = \bar{\psi}(i\hbar D_\mu \gamma^\mu - mc)\psi$$

with the resulting eom=gauge Dirac equation

$$(i\hbar D_\mu \gamma^\mu - mc)\psi = 0$$

The running coupling constant of the QCD

With the potential

$$V(r) = -\frac{4}{3} \frac{\alpha_s \hbar c}{r} + kr \quad \text{potential} = \langle q\bar{q} \rangle$$

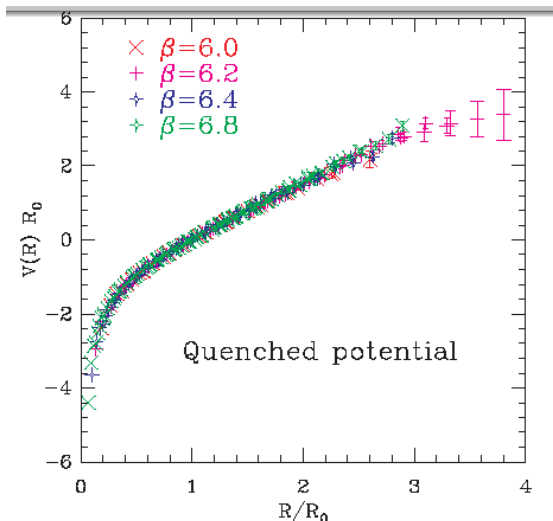

The static qq potential in the quenched approximation obtained by the Wuppertal collaboration. The data at

$\beta = 6.0, 6.2, 6.4$ and 6.8 has been scaled by R_0 , and normalized such that $V(R_0) = 0$. The collapse of the different sets of data on to a single curve after the rescaling by R_0 is evidence for scaling. The linear rise at large r implies confinement. [9]

The color confinement results from $\lim(V(r), r \rightarrow \infty) = \infty$

Callan-Symanzik equation

The Callan-Symanzik equation describes the behavior of the transfer function of a Feynman diagram with n momentums [12]

$$G^{(n)}(x_1, x_2, \dots, x_n; M, g), \text{ where } M=\text{energy and } g=\text{coupling constant}$$

$$M \rightarrow M + \delta M$$

under scaling transformation $g \rightarrow g + \delta g$

It has the form

$$\left[M \frac{\partial}{\partial M} + \beta(g) \frac{\partial}{\partial g} + n\gamma \right] G^{(n)}(x_1, x_2, \dots, x_n; M, g) = 0, \text{ where } \gamma = -\frac{M}{\delta M} \delta \eta, \quad \beta = \frac{M}{\delta M} \delta g$$

From the definition and setting $\mu=M$, we get a differential equation for $g(\mu)$:

$$\mu \frac{\partial g}{\partial \mu} + \beta(g) = 0$$

The running coupling for QCD is characterized by the β -function with colors $N=3$, flavors $n_f=3$, μ =transfer energy

$$\mu \frac{\partial g}{\partial \mu} = -\beta(g) = -(\beta_0 g^3 + \beta_1 g^5 + \dots)$$

$$\beta_0 = \left(\frac{11N - 2n_f}{3} \right) / 16\pi^2$$

$$\beta_1 = \left(\frac{34N^2}{3} - \frac{10Nn_f}{3} - \frac{n_f(N^2 - 1)}{N} \right) / (16\pi^2)^2.$$

$$\text{resulting in } g(\mu) = \frac{1}{\sqrt{2\beta_0 \log\left(\frac{\mu}{\Lambda}\right)}} \text{ for } \mu \rightarrow \infty$$

$$\alpha_s(\mu) = \frac{g^2(\mu)}{4\pi} = \frac{1}{8\pi\beta_0 \log\left(\frac{\mu}{\Lambda}\right)} = \frac{12\pi}{(11N - 2n_f) \log\left(\frac{\mu^2}{\Lambda^2}\right)} \quad \alpha\text{-coupling constant}$$

where

$\Lambda \approx 220$ MeV critical energy of QCD, $\Lambda \approx m(\text{pion})^{3/2} = 210$ MeV

$n_f = 3$: number of quark flavours

$$\text{The corresponding critical length of QCD } r_{0c} = \frac{\hbar c}{\Lambda} = \frac{1.96 * 10^{-7} \text{ eVm}}{220 \text{ MeV}} = 0.89 * 10^{-15} \text{ m}$$

which about the proton radius.

For energies $\mu \approx \Lambda$ it must be modified to avoid the singularity

$$g_c(\mu) = 4\pi \sqrt{\frac{3}{54 \sqrt{\left(\log\left(\frac{\mu}{\Lambda}\right)\right)^2 + c_{GE0}^2}}}, \text{ for the numerical calculation we set } c_{GE0} = \frac{1}{\log\left(\frac{m(p)}{\Lambda_{QCD}}\right)} = 0.683 \approx \log 2,$$

which is consistent with the Callan-Symanzik relation for $\mu > 2\Lambda$, as shown below

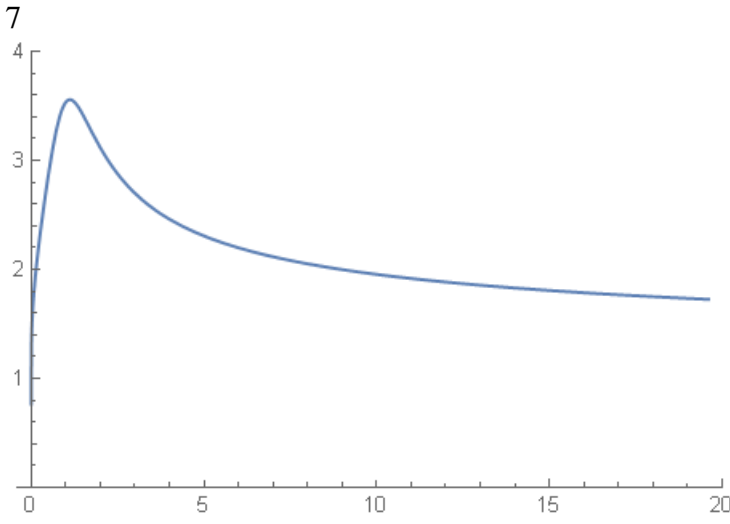

$g_c(\mu)$, μ in E_0 -units, $E_0=196\text{MeV}$

The running coupling constant of the QHCD

For the QHCD the Callan-Symanzik equation is still valid, as it is derived from the scale-independence of the theory.

The running coupling for QHCD with colors $N=4$, flavors $n_f=3$, μ =transfer energy becomes

$$\alpha_{hc}(\mu) = \frac{g^2(\mu)}{4\pi} = \frac{12\pi}{(11N - 2n_f) \log\left(\frac{\mu^2}{\Lambda_{hc}^2}\right)}$$

Again, it must be corrected to avoid a singularity for $\mu = \Lambda_{hc}$

$$g_{hc}(\mu) = 4\pi \sqrt{\frac{3}{54 \sqrt{\left(\log\left(\frac{\mu}{\Lambda_{hc}}\right)\right)^2 + c_{GE1}^2}}}$$

we set $\Lambda_{hc} = 2m(Z_0) = 180\text{GeV}$ in analogy to the QCD , and $c_{GE1} = \frac{1}{\text{Log}\left(\frac{m(t)}{m(d)}\right)}$, with the masses of the top-

and the d-quark: this should assess the logarithmic scale of the generation energy ratio.

Both settings are of course only a plausible guess, but these values work very well for the preon model, as we will see.

The coupling constant g_{hc} for the QHCD is shown below (energy in $1000E_0$ -units):

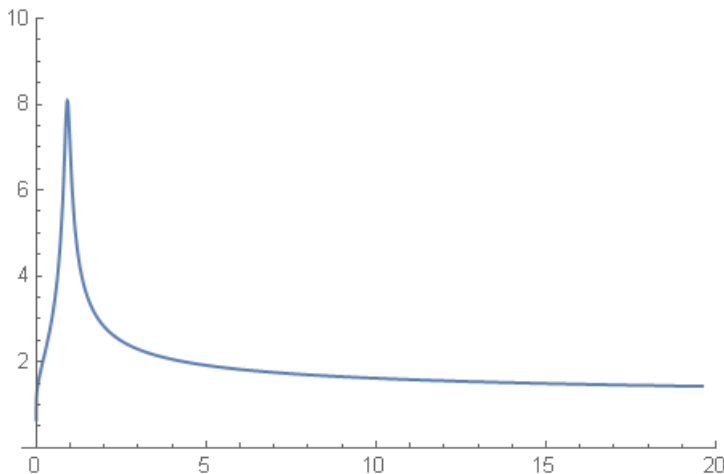

The peak is much higher than in QCD, which reflects the enormous span of the mass scale in the Standard Model.

The corresponding critical length of QHCD $r_{0hc} = \frac{\hbar c}{\Lambda_{hc}} = \frac{1.96 * 10^{-7} eVm}{180 GeV} = 1.08 * 10^{-18} m$

which is about 1/1000 of the proton radius: the energy scale of the QHCD is by a factor 1000 larger, and consequently the length scale by a factor 1000 smaller than in QCD. This agrees with the experimental assessment of the quark radius being about 1/1000 of the proton radius.

2. The Standard Model and QCD, the SU(4)-preon model and QHCD

2.1 Parameters of the Standard Model

Basic particles of the standard model [20]

Fermions in the Standard Model

The following table describes the basic fermion particle of the SM

Generation 1						
Fermion (left-handed)	Symbol	Electric charge	Weak isospin	Weak hypercharge	Color charge *	Mass **
Electron	e^-	-1	-1/2	-1	1	511 keV
Positron	e^+	+1	0	+2	1	511 keV
Electron neutrino	ν_e	0	+1/2	-1	1	< 0.28 eV ****
Electron antineutrino	$\bar{\nu}_e$	0	0	0	1	< 0.28 eV ****
Up quark	u	+2/3	+1/2	+1/3	3	~ 3 MeV ***
Up antiquark	\bar{u}	-2/3	0	-4/3	$\bar{3}$	~ 3 MeV ***
Down quark	d	-1/3	-1/2	+1/3	3	~ 6 MeV ***
Down antiquark	\bar{d}	+1/3	0	+2/3	$\bar{3}$	~ 6 MeV ***

Generation 2						
Fermion (left-handed)	Symbol	Electric charge	Weak isospin	Weak hypercharge	Color charge *	Mass **
Muon	μ^-	-1	-1/2	-1	1	106 MeV
Antimuon	μ^+	+1	0	+2	1	106 MeV
Muon neutrino	ν_μ	0	+1/2	-1	1	< 0.28 eV ****
Muon antineutrino	$\bar{\nu}_\mu$	0	0	0	1	< 0.28 eV ****
Charm quark	c	+2/3	+1/2	+1/3	3	~ 1.337 GeV
Charm antiquark	\bar{c}	-2/3	0	-4/3	$\bar{3}$	~ 1.3 GeV
Strange quark	s	-1/3	-1/2	+1/3	3	~ 100 MeV
Strange antiquark	\bar{s}	+1/3	0	+2/3	$\bar{3}$	~ 100 MeV

Generation 3						
Fermion (left-handed)	Symbol	Electric charge	Weak isospin	Weak hypercharge	Color charge *	Mass **
Tau	τ^-	-1	-1/2	-1	1	1.78 GeV
Antitau	τ^+	+1	0	+2	1	1.78 GeV
Tau neutrino	ν_τ	0	+1/2	-1	1	< 0.28 eV ****
Tau antineutrino	$\bar{\nu}_\tau$	0	0	0	1	< 0.28 eV ****

Top quark	t	$+2/3$	$+1/2$	$+1/3$	$\mathbf{3}$	171 GeV
Top antiquark	\bar{t}	$-2/3$	0	$-4/3$	$\bar{\mathbf{3}}$	171 GeV
Bottom quark	b	$-1/3$	$-1/2$	$+1/3$	$\mathbf{3}$	~ 4.2 GeV
Bottom antiquark	\bar{b}	$+1/3$	0	$+2/3$	$\bar{\mathbf{3}}$	~ 4.2 GeV

The quark radius: as of 2014, experimental evidence indicates they are no bigger than 10^{-4} times the size of a proton, i.e. less than 10^{-19} metres [16]

Field bosons

The following table describes the basic bosons of the SM : 3 massive bosons W_{\pm} , Z , H and 2 massless field-carriers : photon γ and gluon g .

Particle	Charge	w.Isospin T	w.hcharge Y	Spin	Color	Lifetime	Mass
W_{\pm}	± 1	± 1	0	1	0	$3 \cdot 10^{-25}$ s	80.4 GeV
Z	0	0	0	1	0	$3 \cdot 10^{-25}$ s	91.2 GeV
γ photon	0	0	0	1	0		0
g gluon	0	0	0	1	3		0
H higgs	0	0	0	0	0	10^{-22} s	125.1 GeV

Parameters Standard model [9]

The model has 28 parameters

Parameters of the Standard Model

Symbol	Description	Renormalization scheme (point)	Value
m_e	Electron mass		511 keV
m_{μ}	Muon mass		105.7 MeV
m_{τ}	Tau mass		1.78 GeV
m_u	Up quark mass	$\mu_{\text{MS}} = 2 \text{ GeV}$	1.9 MeV
m_d	Down quark mass	$\mu_{\text{MS}} = 2 \text{ GeV}$	4.4 MeV
m_s	Strange quark mass	$\mu_{\text{MS}} = 2 \text{ GeV}$	87 MeV
m_c	Charm quark mass	$\mu_{\text{MS}} = m_c$	1.32 GeV
m_b	Bottom quark mass	$\mu_{\text{MS}} = m_b$	4.24 GeV
m_t	Top quark mass	On-shell scheme	172.7 GeV
θ_{12}	CKM 12-mixing angle	q flavor mixing	13.1°
θ_{23}	CKM 23-mixing angle		2.4°
θ_{13}	CKM 13-mixing angle		0.2°
δ_{13}	CKM CP-violating Phase		0.995
θ_{12}	PMNS 12-mixing angle	v flavor mixing	$33.6 \pm 0.8^\circ$
θ_{23}	PMNS 23-mixing angle		$47.2 \pm 4^\circ$
θ_{13}	PMNS 13-mixing angle		$8.5 \pm 0.15^\circ$
δ_{13}	PMNS CP-violating Phase		4.1 ± 0.75
g_1 or g'	U(1) gauge coupling	$\mu_{\text{MS}} = m_Z$	0.357
g_2 or g	SU(2) gauge coupling	$\mu_{\text{MS}} = m_Z$	0.652
g_3 or g_s	SU(3) gauge coupling	$\mu_{\text{MS}} = m_Z$	1.221

11

\mathcal{A}	crit. energy in SU(3)	220MeV
c_{gE0}	additional log in col-coupling	0.69
θ_{QCD}	QCD vacuum angle	~ 0
v	Higgs vacuum expectation value	246 GeV
m_{H}	Higgs mass	125.36 ± 0.41 GeV
$m_{\nu e}$	electron neutrino mass	≤ 0.12 eV
$m_{\nu \mu}$	mu neutrino mass	≤ 0.12 eV
$m_{\nu \tau}$	tau neutrino mass	≤ 0.12 eV

2.2 The basics of the preon model

The preon model describes the basic particles of the Standard Model (leptons, quarks and exchange bosons) as composed of smaller particles (preons), which obey a super-strong hyper-color interaction.

Examples are the rishon model (Harari 1979 [26], [27]) and the primon model (de Souza 2002 [25]).

The rishon model

In the rishon model, there are two preons (called rishons) T (charge $+1/3e$) and V (charge 0). Leptons and quarks and exchange bosons are built of 3 rishons. They obey a hc-interaction based on SU(3), the 3-rishon combinations have the (color)x(hyper-color) representation $SU(3)_c \times SU(3)_{hc}$

TTT = antielectron

VVV = electron neutrino

TTV, TVT and VTT = three colours of up quarks

TVV, VTV and VVT = three colours of down antiquarks

TTT = electron

VVV = electron antineutrino

TTV, TVT, VTT = three colours of up antiquarks

TVV, VTV, VVT = three colours of down quarks

W^+ boson = TTTVVV

Generations are explained as excited states of the first generations, mass is not explained.

The primon model

In the primon model there are four preons (called primons) (p_1, p_2, p_3, p_4), which carry charge $(+5/6, -1/6, -1/6, -1/6)$ and hc-charge, they obey a hc-interaction based on SU(2).

Quarks are built of two primons:

$u(p_1, p_2), c(p_1, p_3), t(p_1, p_4), d(p_2, p_3), s(p_2, p_4), b(p_3, p_4),$

leptons are non-composite, there are 3 non-composite Higgs-bosons.

Generations are explained as primon-configuration, the mass spectrum is only qualitatively explained

Requirements for the preon model

The two basic ideas of the preon model (PM) are

- the basic particles of the Standard Model (SM) are composed of a few fundamental fermions
- there is a super-strong hyper-color interaction, with massless field bosons

A successful PM should uphold the symmetries and invariances of the SM and solve its main problems:

-PM should encompass the preservation of the baryon and lepton number

-PM should explain and derive the generations (flavor) of the SM and their energy scales

-PM should explain the allowed and not-allowed decay modes and the flavor-mixing of the SM

-PM should correctly calculate the mass spectrum, and explain the huge difference in mass scale between leptons and quarks, and between the generations: $m(\text{neutrino } \nu_e) \sim 10^{-4} \text{ eV}$, : $m(\text{top quark } t) = 170 \text{ GeV}$, which makes a factor of 10^{15}

-PM should describe the weak exchange bosons W, Z, and the higgs H as Yukawa-bosons of the hc-interaction, as all other fundamental field bosons graviton $A^{\mu\nu}$, photon A^μ , gluon A_c^μ are massless waves; the field bosons A_{hc}^μ of hc should be also massless

-hc interaction should be stronger the SU(3)-color interaction and should encompass the weak SU(2), also it should reproduce the spontaneous symmetry breaking of the electroweak symmetry group

$SU(2)_{L, \text{weak}} \otimes SU(1)_{R, \text{weak}} \otimes SU(1)_{em}$ with their exchange bosons $\{W^\mu, Z^\mu\} \otimes \{Z^\mu\} \otimes \{A^\mu\}$

-PM should reduce the 28 parameters of the SM to very few fundamental parameters

2.3 Realization of the SU(4) preon model

The SU(4) preon model (SU4PM) is based essentially on two assumptions

- The SU4PM postulates two basic Weyl-spinors $\{r, q\}$ as the fundamental particles and the SU(4) as the gauge group of the hc-interaction, with spin $S=1/2$, with electrical charge $Q_e=\{-1/2, 1/6\}$ and color charge $Q_c=\{0, 1\}$
- The field-bosons are the 15 generators A_{hc}^μ of the SU(4), described by the 15 standard generator 4x4 matrices λ_i of the SU(4). The SU(4) has 4 hc-charges: {chirality L, chirality R, electrical charge +, electrical charge -} in analogy to the 3 color charges of the SU(3): {r, g, b}.

From these assumptions follow the basic particle families of

- leptons $L=r\otimes r$ being a hc-tetra-spinor of a doublet of two r-preons, fermions with total spin $S=1/2$
- quarks $Q=r\otimes q$ being a hc-tetra-spinor of a doublet of an r- and a q-preon, colored fermions with color $Q_c=1$ with total spin $S=1/2$
- (hypothetical) strong neutrinos $N_c=q\otimes q$ being a hc-tetra-spinor of a doublet of two q-preons, colored fermions with color $Q_c=0$ with total spin $S=1/2$
- weak bosons $B_w=r\pm r$ being a linear combinations of two or more r-preons, with total spin $S=0$ (scalar like higgs H) or $S=1$ (vector like W and Z)
- (hypothetical) strong bosons $B_c=q\pm q$ being a linear combinations of two or more q-preons, with color $Q_c=0$ and total spin $S=0$ (scalar like higgs H_q) or $S=1$ (vector like Z_q)

A hc-tetra-spinor is a hc-quadruplet with the hc-charges $\{L-, L+, R-, R+\}$.

Both preons can carry all four charges of SU(4), i.e. there are $\{rL-, rL+, rR-, rR+\}$ and $\{qL-, qL+, qR-, qR+\}$, where the spinor-anti-spinor pairs are $\{rL-, rR+\}$ and $\{rL+, rR-\}$.

The r-q-doublets, i.e. the quarks, have one more degree of freedom, as they consist of different fermions, and are therefore chiral-neutral, which is energetically more favorable.

A hc-doublet occupies two positions in a hc-tetra-spinor with indices (i, j) , e.g. the e-neutrino with the configuration $\{rL-, rL+, 0, 0\}$ has the hc-indices $(1, \bar{2})$, the bar over 2 signifies the anti-spinor.

One can show, that for two hc-indices $\{i, j\}$ there are three field-boson configurations, which are compatible with the SU(4) symmetry: one boson A_{ij} (corresponding to the non-diagonal hc-matrix $\tilde{\lambda}_{ij}$ interchanging i with j , e.g. for $(i, j) = (1, 2)$ $\tilde{\lambda}_{ij} = \lambda_1$), four bosons $A_{ij}, \bar{A}_{ij}, A_{kl}, \bar{A}_{kl}$ (interchanging resp. (i, j) , (i, \bar{j}) , and the dual index pairs (k, l) , (k, \bar{l})), and all 15 bosons as the third configuration. These correspond to the three generations (flavors) of the SM, as the calculation shows.

Basic parameters of SU4PM

We have 4 parameters for SU4PM: 2 preon masses, and for the coupling constant the critical energy Λ_{hc} and the peak height constant c_{GE1} . The 2 parameters of the coupling constant have been derived in chap. 1.

For the mass of the r-preon, we make a guess of $m(\text{e-neutrino})/3$: in the lightest lepton, the e-neutrino, there are two r-preons and one hc-boson, so $m(r)$ will be approximately 1/3 of the assessed $m(\text{e-neutrino})$: this is assumed to be 1/1000 (1000=approximate factor for flavor 3) of the best upper limit for $m(\text{tau-neutrino})=0.1\text{eV}$. For the mass of the q-preon, we take 1/3 of mass(u-quark) the lightest quark, in analogy to the r-preon.

preon data

r-preons $\{rL-, rL+, rR-, rR+\}$
 $Q(r)=-1/2, m(r)=0.033\text{ meV}$

q-preons $\{qL-, qL+, qR-, qR+\}$
 $Q(q)=+1/6, m(q)=0.77\text{ MeV}$

coupling constant of hc-interaction

The coupling from the Callan-Symanzik equation must be corrected to avoid a singularity for $\mu = \Lambda_{hc}$

$$g_{hc}(\mu) = 4\pi \sqrt{\frac{3}{54 \sqrt{\left(\log\left(\frac{\mu}{\Lambda_{hc}}\right)\right)^2 + c_{GE1}^2}}}$$

we set $\Lambda_{hc} = 2m(Z_0) = 180\text{GeV}$ in analogy to the QCD, and $c_{GE1} = \frac{1}{\text{Log}\left(\frac{m(t)}{m(d)}\right)} = 0.095$

The configuration of the SM in the SU4PM

Every basic particle of the SM is assigned a preon and a hc-boson configuration.

The preon configuration of a fermion (leptons and quarks) occupies two of the 4 positions in a hc-quadruplet by a Dirac-bispinor, e.g. for electron with index pair $(1,3)$ we have $\begin{pmatrix} rL- \\ 0 \end{pmatrix}$ in position 1 and $\begin{pmatrix} rR- \\ 0 \end{pmatrix}$ in position 3,

according to the hc-charge. The hc-quadruplet has the hc-charges $(L-, L+, R-, R+)$.

There are 3 possible hc-boson configurations for an index-pair (i,j) , which are consistent with the SU(4)-symmetry: 1 hc-boson A_{ij} corresponding to first generation of flavor=1, 4 hc-bosons $A_{ij} + \bar{A}_{ij} + A_{kl} + \bar{A}_{kl}$ corresponding to flavor=2 (the bar specifies the conjugate coupler, and (k,l) is the complementary index pair, e.g. for electron it is $(2,4)$), and finally all 15 hc-bosons corresponding to flavor=3.

The fermions (leptons and quarks) have two independent preon-components $u1$ and $u2$, they form a bispinor with spin $S=1/2$.

The bosons (weak boson W, Z, H) have only one independent preon-component $u1$, which is a linear combination of two preons, the spins add up to $S=1$ for W and Z, or to $S=0$ for H, e.g. for $Z=Z0$

$u1 = ((rL-)+(rR-))/\sqrt{2}$ and $Z0 = \left(\begin{pmatrix} u1 \\ 0 \end{pmatrix}, \begin{pmatrix} 0 \\ u1 \end{pmatrix}, \begin{pmatrix} u1 \\ 0 \end{pmatrix}, \begin{pmatrix} 0 \\ u1 \end{pmatrix} \right) / \sqrt{2}$. The weak bosons W and Z0 are carrier of

the residual weak interaction, and the higgs H generates masses for all r-containing particles: leptons, quarks, weak bosons and the r-preon itself.

The SU4PM predicts the existence of hypothetical strong neutrinos, which consist of $q\bar{q}$ with electrical charge $Q=0$ and color charge $Q_c=0$. They are heavy ($m(qnu)=23.2\text{MeV}$) practically non-interacting particles: they interact only via very heavy q-boson Zq ($m(Zq)=644\text{GeV}$), i.e. they interact only at high resonance energies with small cross-sections. There is a new hypothetical model for Dark Matter called SIMP with mass around 100MeV and interacting strongly at high resonance energies [28]. The strong-neutrinos do fit into this category. Furthermore, the SU4PM predicts the existence of strong bosons Zq and Hq , in analogy to weak bosons $Z0$ and H, built of q-preons instead of r-preons. the strong neutrinos interact with themselves via Zq , and Hq generates masses for strong neutrinos and the q-preon.

The decay of neutron and pion requires (to safeguard the conservation of hc-charge) the existence of further weak neutrinos: the non-chiral (sterile) neutrinos with masses similar to lepton neutrinos. The nc-neutrinos are neutral, non-chiral, and interact with themselves and lepton neutrinos via the weak ZL -boson similar to the $Z0$, but left-chiral.

charged leptons {e, mu, tau}

$$x = \left(\begin{pmatrix} rL^- \\ 0 \end{pmatrix}, 0, \begin{pmatrix} rR^- \\ 0 \end{pmatrix}, 0 \right)$$

$e = x + A13$ flavor F=1 one boson

$mu = x + A13 + \bar{A}13 + A24 + \bar{A}24$ F=2: four bosons

$tau = x + A$ F=3: all bosons

lepton neutrinos {nue, num, nut}

$$x = \left(\begin{pmatrix} rL^- \\ 0 \end{pmatrix}, \begin{pmatrix} 0 \\ rL^+ \end{pmatrix}, 0, 0 \right)$$

$nue = x + A12$

$num = x + A12 + \bar{A}12 + A34 + \bar{A}34$

$nut = x + A$

u-quarks {u,c,t}

$$x = \left(0, \begin{pmatrix} (rL++qL+)/\sqrt{2} \\ (rL++qL+)/\sqrt{2} \end{pmatrix}, 0, \begin{pmatrix} (rR++qR+)/\sqrt{2} \\ (rR++qR+)/\sqrt{2} \end{pmatrix} \right)$$

$u = x + A24$

$c = x + A24 + \bar{A}24 + A13 + \bar{A}13$

$t = x + A$

sterile neutrinos {nus1,nus2,nus3}

$$x = \left(\begin{pmatrix} rL^- \\ 0 \end{pmatrix}, 0, 0, \begin{pmatrix} 0 \\ rR^+ \end{pmatrix} \right)$$

$nus1 = x + A14$

$nus2 = x + A14 + \bar{A}14 + A23 + \bar{A}23$

$nus3 = x + A$

d-quarks {d, s, b}

$$x = \left(\begin{pmatrix} (rL--qL+)/\sqrt{2} \\ 0 \end{pmatrix}, 0, \begin{pmatrix} (rR--qR+)/\sqrt{2} \\ 0 \end{pmatrix}, 0 \right)$$

$d = x + A13$

$s = x + A13 + \bar{A}13 + A24 + \bar{A}24$

$b = x + A$

weak massive bosons {W, Z0, ZL, H}

F=3, all A

$$W = \left(0, 0, \begin{pmatrix} u1 \\ 0 \end{pmatrix}, 0 \right) \sqrt{2} \quad u1 = ((rR^-) - (rR^-)) / \sqrt{2}$$

$$Z0 = \left(\begin{pmatrix} u1 \\ 0 \end{pmatrix}, \begin{pmatrix} 0 \\ u1 \end{pmatrix}, \begin{pmatrix} u1 \\ 0 \end{pmatrix}, \begin{pmatrix} 0 \\ u1 \end{pmatrix} \right) / \sqrt{2} \quad u1 = ((rL^-) + (rR^-)) / \sqrt{2}$$

$$ZL = \left(\begin{pmatrix} u1 \\ u1 \end{pmatrix}, \begin{pmatrix} u1 \\ u1 \end{pmatrix}, 0, 0 \right) / \sqrt{2} \quad u1 = ((rL^-) + (rL^+)) / \sqrt{2}$$

$$H = \left(\begin{pmatrix} u1 \\ u1 \end{pmatrix}, \begin{pmatrix} u1 \\ u1 \end{pmatrix}, \begin{pmatrix} u1 \\ u1 \end{pmatrix}, \begin{pmatrix} u1 \\ u1 \end{pmatrix} \right) / 2 \quad u1 = ((rL^-) + (rL^+) + (rR^-) + (rR^+)) / 2$$

strong neutrinos {qnue, qnum, qnut}

$$x = \left(\left(\begin{array}{c} qL- \\ 0 \end{array} \right), 0, 0, \left(\begin{array}{c} 0 \\ qR+ \end{array} \right) \right)$$

$$qnue = x + A14$$

$$qnum = x + A14 + \bar{A}14 + A23 + \bar{A}23$$

$$qnut = x + A$$

strong massive bosons {Zq, Hq}

F=3, all A

$$Zq = \left(\left(\begin{array}{c} u1 \\ 0 \end{array} \right), \left(\begin{array}{c} 0 \\ u1 \end{array} \right), \left(\begin{array}{c} u1 \\ 0 \end{array} \right), \left(\begin{array}{c} 0 \\ u1 \end{array} \right) \right) / \sqrt{2} \quad u1 = ((qL-) + (qR-)) / \sqrt{2}$$

$$Hq = \left(\left(\begin{array}{c} u1 \\ u1 \end{array} \right), \left(\begin{array}{c} u1 \\ u1 \end{array} \right), \left(\begin{array}{c} u1 \\ u1 \end{array} \right), \left(\begin{array}{c} u1 \\ u1 \end{array} \right) \right) / 2 \quad u1 = ((qL-) + (qL+) + (qR-) + (qR+)) / 2$$

3. The calculation method of the SU(4)-preon model

We apply for the calculation of the parameters of SM particles the numerical minimization of action, using a Ritz-Galerkin expansion for the hc-bosons and a parameterized gaussian for the preons.

3.1 The ansatz for the wavefunction

Hc-boson wavefunction

For the hc-boson wavefunction we apply here the full Ritz-Galerkin series on the function system

$$f_k(r, \theta) = \{bfunc(r, r_0, dr_0) r^{k_1}, k_1 = 0, \dots, n_r\} \times \{(\cos^{k_2} \theta, \cos^{k_2} \theta \sin \theta), k_2 = 0, \dots, n_\theta\} \text{ with coefficients } \alpha_k,$$

where $bfunc(r, r_0, dr_0) = \frac{1}{1 + \exp\left(\frac{r - r_0}{dr_0}\right)}$ is a Fermi-step-function which limits the region $r \leq r_0$ of the preon

with „smearing width“ dr_0 .

$$Ag(t, r, \theta) = \left\{ \begin{array}{l} Ag_{i1}(t, r, \theta) \cos aA_i \\ Ag_{i2}(t, r, \theta) \cos aA_i \\ Ag_{i1}(t, r, \theta) \sin aA_i \\ Ag_{i2}(t, r, \theta) \sin aA_i \end{array} \right\}, i = 1, \dots, 15, \text{ where } aA_i \text{ is the phase angle between the particle and the}$$

anti-particle part of the hc-boson, and with the Ritz-Galerkin-expansion

$$Ag_{kl}(t, r, \theta) = \sum_j \alpha[k, l, j] f_j(r, \theta) \exp(-it EA_k) \text{ with energies } EA_k$$

$$k = 1 \dots 15, l = 1, 2$$

Because of hc-symmetry, the active (non-zero) hc-bosons are

$$Ag = \{Ag_1, \dots, Ag_{15}\} \text{ all hc-bosons: generation 3, flavor=3}$$

$Ag = \{Ag_{ij}, \bar{A}g_{ij}, Ag_{kl}, \bar{A}g_{kl}\}$ 4 hc-bosons: coupler and anti-coupler for hc-indices (i,j) and the corresponding 2 coupler-anti-coupler pair for the complementary indices (k,l): generation 2, flavor=2

$Ag = \{Ag_{ij}\}$ one hc-boson for the hc-indices (i,j): generation 1, flavor=1.

Particle wavefunction

The hc-quadruplet has 4 positions with the hc-charges {L-, L+, R-, R+}, and the particle wavefunction of a fermion (lepton or quark) has two positions occupied with indices (i,j)

$$u = \{..(p_1)..(p_2)..\} \text{ } p_1 \text{ and } p_2 \text{ are Weyl spinors with 2 components.}$$

For the preons we use here a model of a gaussian “blob”

$$p_k(t, r, \theta) = \left(\begin{array}{l} \exp(-it Eu_k) \exp\left(-\frac{(\vec{r} - \vec{r}_{u,k})^2}{2 dr_{u,k}}\right) \cos a_k \\ \exp(-it Eu_k) \exp\left(-\frac{(\vec{r} - \vec{r}_{u,k})^2}{2 dr_{u,k}}\right) \sin a_k \end{array} \right), \text{ where } Eu_k \text{ is the energy, } \vec{r}_{u,k} = (ru_k, \theta u_k) \text{ and } dr_{u,k} \text{ is the}$$

position(r, θ) and its width, a_k is a phase.

3.2 The numerical algorithm [24]

The energy, length, and time are made dimensionless by using the units: $E(E_0 = \frac{\hbar c}{1 \text{ am}} = 0.196 \text{ TeV})$, $r(\text{fm})$, $t(\text{am}/c)$ $\text{am} = 10^{-18} \text{ m}$. We can assume axial symmetry, so we can set $\varphi = 0$ and use the spherical coordinates (t, r, θ) .

We choose the equidistant lattice for the intervals $(t, r, \theta) \in [0,1] \times [0,1] \times [0,\pi]$ with $21 \times 21 \times 11$ points and, for the minimization 8x in parallel, 8 random sublattices:

$l[ix, j] = \{ \{ (t_{i1}, r_{i2}, t_{i3}) \mid (i1, i2, i3) = \text{random}(\text{lattice}, j = 1 \dots 100) \} \mid ix = 1, \dots, 8 \}$.

For the Ritz-Galerkin expansion we use the 12 functions

$$f_k(r, \theta) = \{ \text{bfunc}(r, r_0, dr_0) r^{k_1}, k_1 = 0, \dots, n_r \} \times \{ (\cos^{k_2} \theta, \cos^{k_2} \theta \sin \theta), k_2 = 0, \dots, n_\theta \}$$

The action $S = \int L_{QHCD}(x^\mu, q_i, Ag_i) r^2 \sin \theta dt dr d\theta d\varphi$ becomes a mean-value on the sublattice $l[ix]$

$$\tilde{S}[ix] = \frac{1}{N(l[ix])} \sum_{x \in l[ix]_{sub}} L_{QHCD}(x, q_i, Ag_i) 2\pi V_{r\theta}, \text{ where } V_{r\theta} = \pi \text{ the } (t, r, \theta)\text{-volume and } N(l[ix]) \text{ is the number}$$

of points. We set $N(l[ix]) = 100$ for generation 1 and 2, $N(l[ix]) = 25$ for generation 3.

We impose the boundary condition for $Ag_i(r = r_0) = 0$ via penalty-function (imposing exact conditions is possible, but slows down the minimization process enormously).

\tilde{S} is minimized 8x in parallel with the Mathematica-minimization method "simulated annealing".

The proper parameters of the preons and the hc-bosons are:

$$\text{par}(p_i) = \{ Eu_i, a_i, ru_i, \theta u_i, dru_i \}, \text{ par}(Ag_i) = \{ EA_i, aA_i \}$$

The complexities and execution times (on a 2.7GHz Xeon E5 work-station) differ greatly for different generations.

For the generation 1 electron $e = \left(\left(\begin{pmatrix} rL- \\ 0 \end{pmatrix}, 0, \begin{pmatrix} rR- \\ 0 \end{pmatrix}, 0 \right)$ with 1 hc boson A13:

complexity(Lagrangian)= $6.2 \cdot 10^6$ terms, minimization time $t(\text{minimization})=37\text{s}$.

For the generation 3 tauon $\tau = \left(\left(\begin{pmatrix} rL- \\ 0 \end{pmatrix}, 0, \begin{pmatrix} rR- \\ 0 \end{pmatrix}, 0 \right)$ with all 15 hc-bosons:

complexity(Lagrangian)= $283 \cdot 10^6$ terms, minimization time $t(\text{minimization})=2500\text{s}$.

4. The particles and families of the SU(4)-preon model

Here we present the result of the calculation of the masses, inner structure, and some of the angles of the mixing matrices CKM and PMNS, using the minimization of the action described in chapter 3.

4.1 Charged leptons electron, muon, tau

Spin $S=1/2$, two free preons, occupying fixed positions in the hc-tetra-spinor

$$\text{Preon configuration: } u = \left(\begin{pmatrix} rL^- \\ 0 \end{pmatrix}, 0, \begin{pmatrix} rR^- \\ 0 \end{pmatrix}, 0 \right)$$

Boson configuration: flavor=1: ($A_{13} = \lambda 4$), flavor=2: ($A_{13} = \lambda 4, \bar{A}_{13} = \lambda 5, A_{24} = \lambda 11, \bar{A}_{24} = \lambda 12$)
flavor=3: all 15 bosons

The leptons are charged particles, they interact electromagnetically or weakly via Z and W bosons.

The leptons are spherically symmetric, and have therefore the gyromagnetic ratio $g=2$ exactly, which is valid from the Dirac-equation for a point-like (or spherically symmetric) spin-1/2-particle. The spherical symmetry arises from the fact, that all leptons consist of two r-preons, which differ only in the hc-charge, so it is plausible that their geometric parameters are equal (equal radius r_i , its uncertainty dr_i , equal phase angle a_i , and inter-preon-angle $\theta=0$).

	m(e)	m(mu)	m(tau)
exp.	0.511MeV	106MeV	1.78GeV
calc.	0.293	228	2.26

Energy distribution: preon(u1,u2) bosons Ai

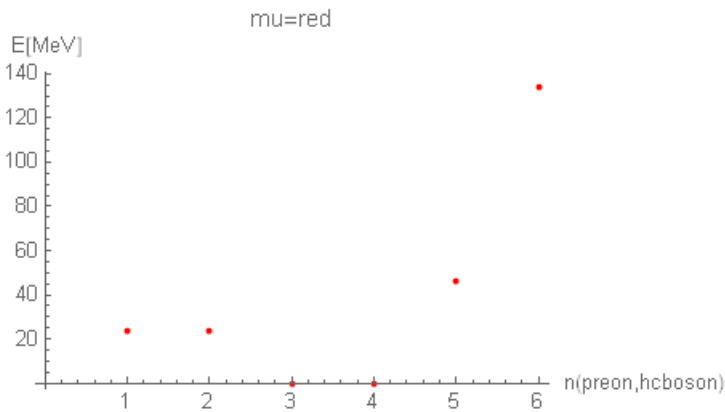
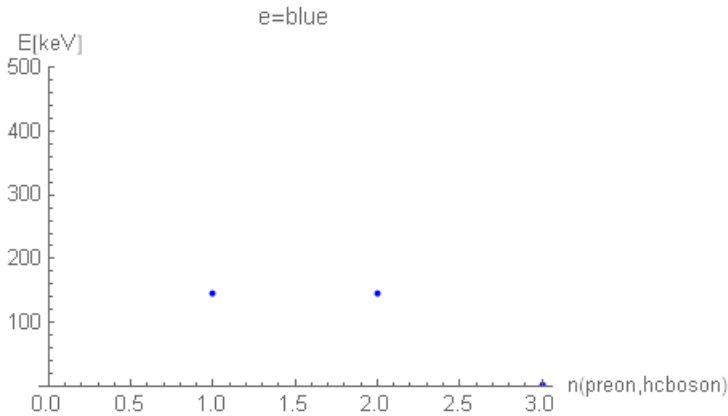

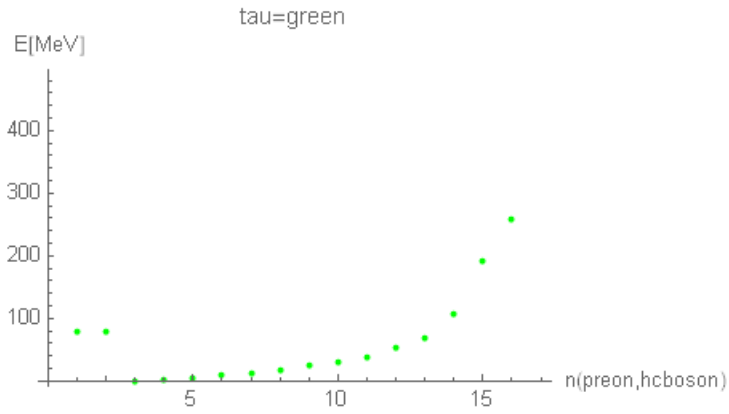

radii r_i , uncertainty dr_i and angle θ

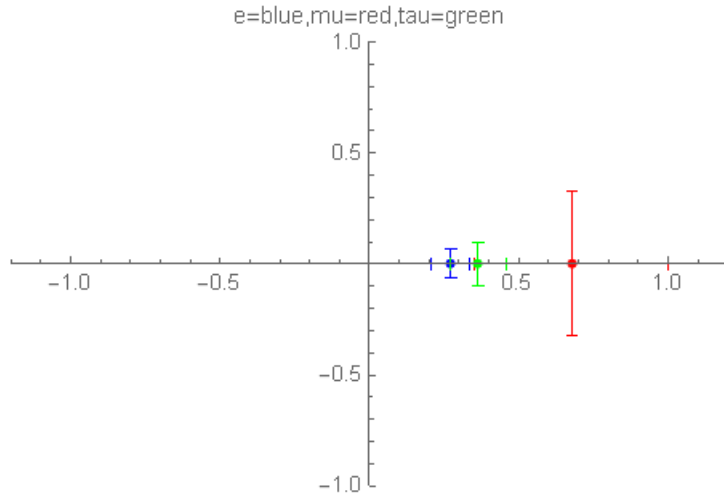

electron $e=(rL-, rR-)$

$$\text{Preon configuration: } u = \left(\left(\begin{matrix} rL- \\ 0 \end{matrix} \right), 0, \left(\begin{matrix} rR- \\ 0 \end{matrix} \right), 0 \right)$$

$$\text{Antiparticle positron } \bar{u} = \left(0, \left(\begin{matrix} 0 \\ rL+ \end{matrix} \right), 0, \left(\begin{matrix} 0 \\ rR+ \end{matrix} \right) \right)$$

$$m=0.511\text{MeV } Q=-1$$

$$E_{\text{tot}}=0.29\text{MeV}, \Delta E_{\text{tot}}=0.096$$

E_{u_i} (MeV)	EA_i	a_i	aA_i	dru_i	ru_i	$\sin(\theta_{u_i})$
0.146,0.146	0.00056	-0.27, -0.27	-0.017	0.131, 0.131	0.272, 0.272	0
ΔE_{u_i}	ΔEA_i	Δa_i	ΔaA_i	Δdru_i	Δru_i	$\Delta \sin(\theta_{u_i})$
0.049, 0.049	0.00074	.		27n,27n	1.93n, 1.93n	

$A_i(e)$

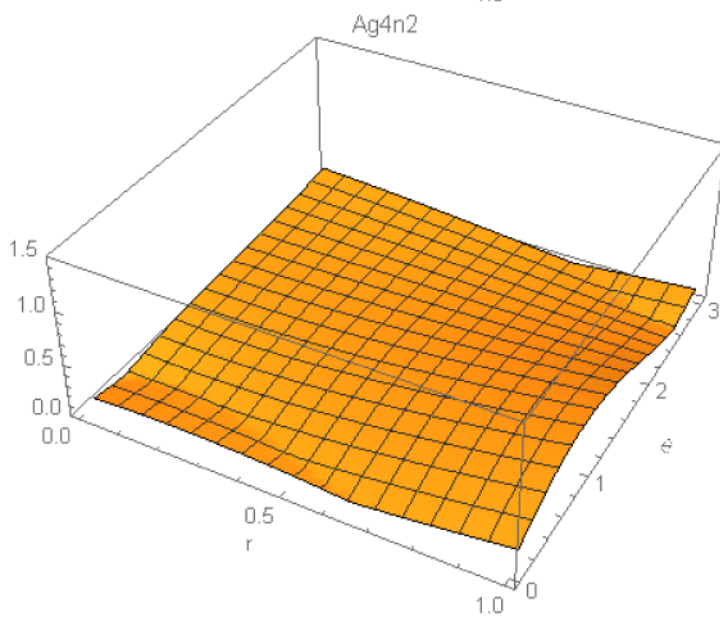
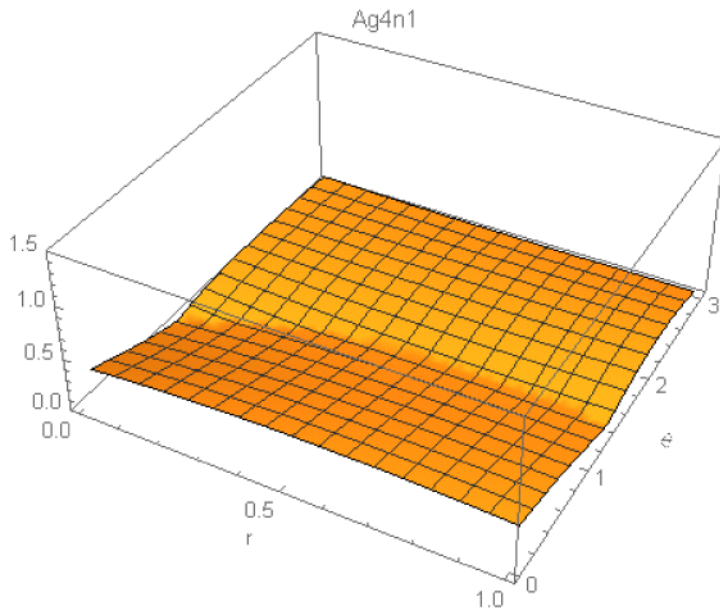

muon $\mu = (rL, rR)$
 $m = 106 \text{ MeV}$ $Q = -1$

$E_{\text{tot}} = 228 \text{ MeV}$, $\Delta E_{\text{tot}} = 154$

E_{u_i} (MeV)	EA_i	a_i	aA_i	dru_i	ru_i	$\sin(\theta_{u_i})$
24.06, 24.06	0.00036, 0.0013, 46.33, 133.75	-0.48, -0.48	0.24, 0.266, -0.55, -0.632	0.648, 0.648	0.68, 0.68	0
ΔE_{u_i}	ΔEA_i	Δa_i	ΔaA_i	Δdru_i	Δru_i	$\Delta \sin(\theta_{u_i})$
18.32, 18.32	0.00045, 0.0011, 30.89 , 87.17	.		4.5u, 4.5u	0.47u, 0.47u	

$A_i(\mu)$

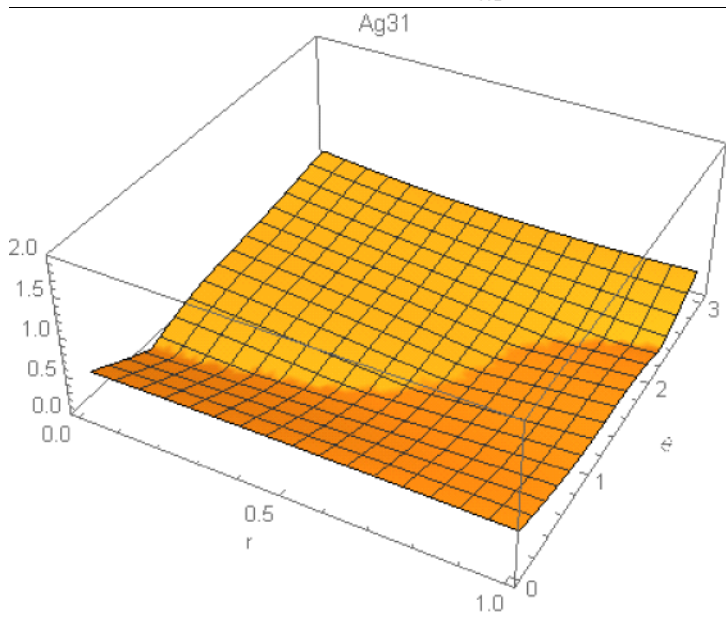
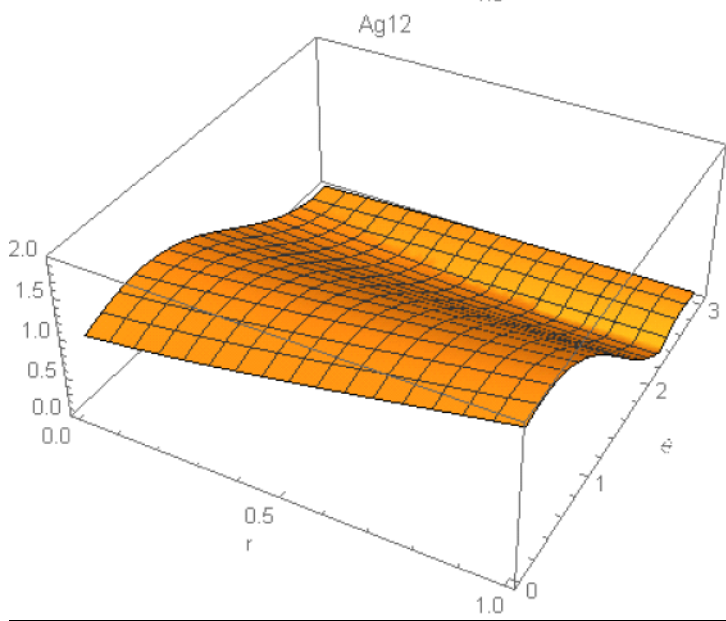
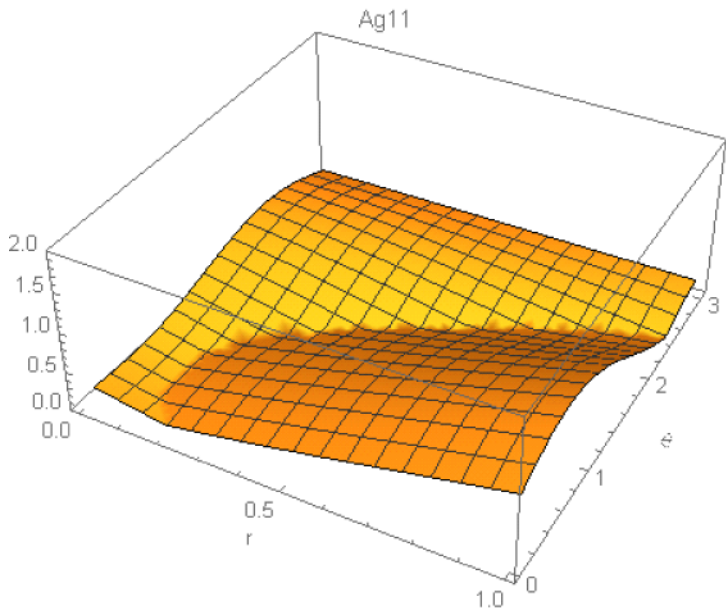

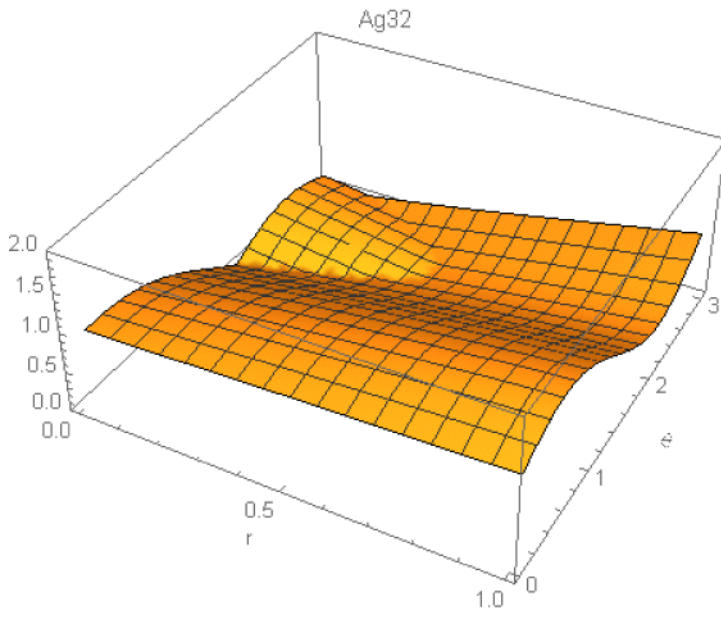

tauon tau=(rL-, rR-)

$m=1.78\text{GeV } Q=-1$

$E_{\text{tot}}=2.26\text{GeV}, \Delta E_{\text{tot}}=0.70$

E_{u_i} MeV	EA_i	a_i	aA_i	dru_i	ru_i	$\sin(\theta_{u_i})$
77.68, 77.68	0.000258, 1.274, 3.51, 8.51, 11.45, 18.12, 25.0369, 30.46, 37.057, 52.78, 69.55, 106.83, 191.129, 259.009, 1297.48	0.216842, 0.216842	-0.33192, - 0.0188942, - 0.0449149, - 0.325663, - 0.0118209, \ -0.0943335, - 0.226005, -0.149676, 0.143007, 0.0745547, 0.102575, - 0.154493, - 0.0987211, - 0.161108, -0.0258635	0.19, 0.19	0.36, 0.36	0
ΔE_{u_i}	ΔEA_i	Δa_i	ΔaA_i	Δdru_i	Δru_i	$\Delta \sin(\theta_{u_i})$
77.66, 77.66	0.00028103, 1.68893, 2.36353, 5.65246, 6.56911, 9.40924, 11.9228, 11.9599, 15.7698, 30.2164, 34.4179, 17.5376, 107.57, 106.864, 180.17	.		33n, 33n	7.6u, 7.7u	

$A_i(\text{tau})$

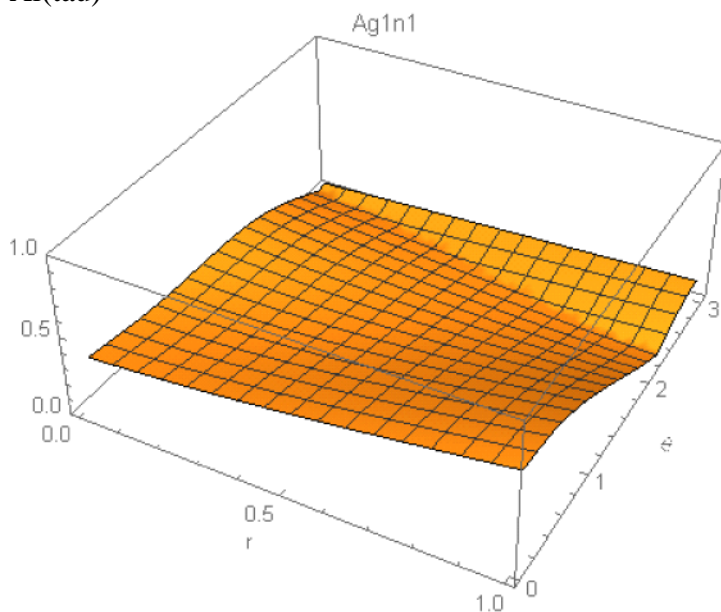

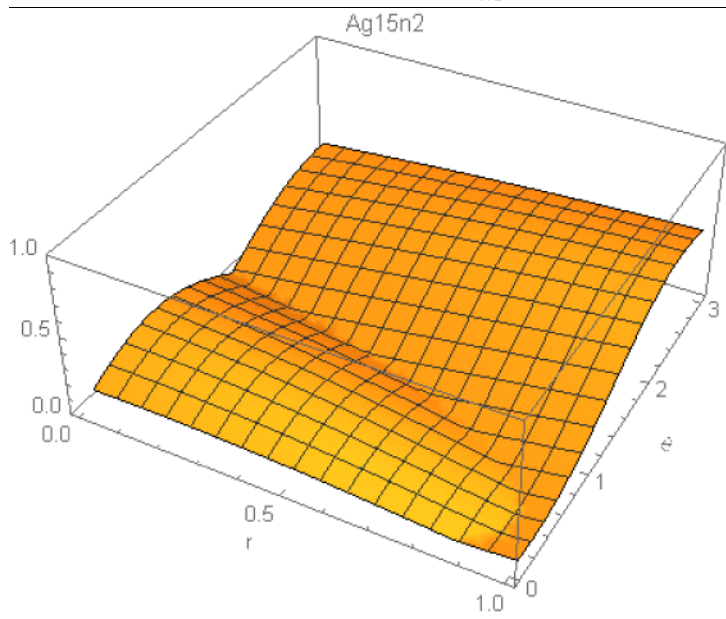
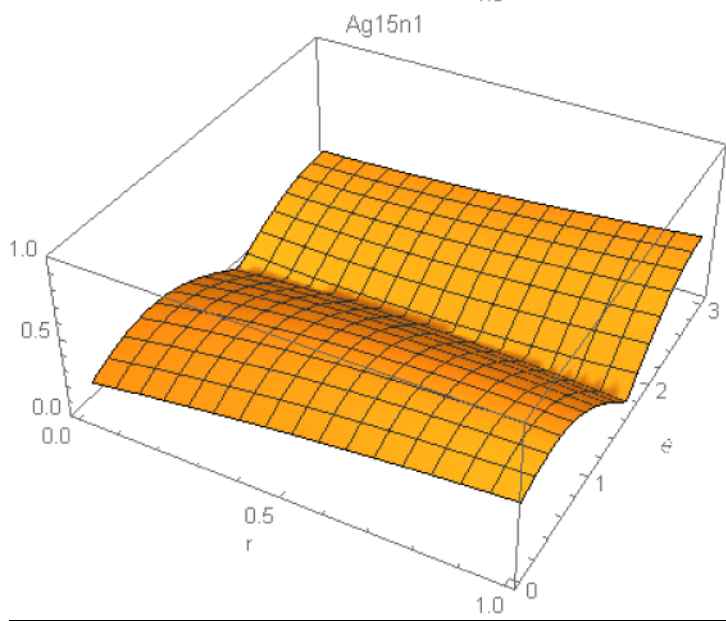
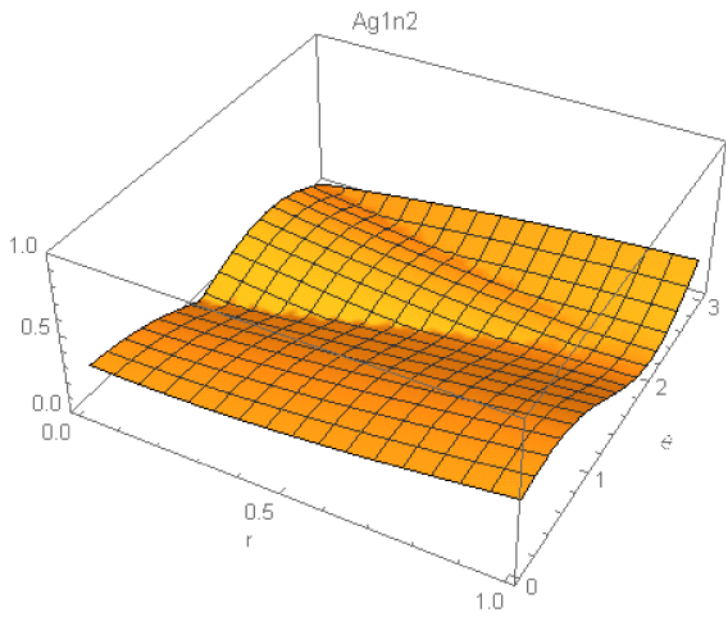

4.2 Lepton neutrinos $\nu_e, \nu_{\mu}, \nu_{\tau}$

Spin $S=1/2$, two free preons, occupying fixed positions in the hc-tetra-spinor

$$\text{Preon configuration: } u = \left(\begin{pmatrix} rL- \\ 0 \end{pmatrix}, \begin{pmatrix} 0 \\ rL+ \end{pmatrix}, 0, 0 \right)$$

Boson configuration: flavor=1: ($A_{12} = \lambda_1$), flavor=2: ($A_{12} = \lambda_1, \bar{A}_{12} = \lambda_2, A_{34} = \lambda_{13}, \bar{A}_{34} = \lambda_{14}$)

flavor=3: all 15 bosons

The lepton neutrinos are spherically symmetric, as shown in the calculation, and have therefore zero magnetic momentum. The spherical symmetry arises from the fact, that all leptons consist of two r-preons, which differ only in the hc-charge, so it is plausible that their geometric parameters are equal (equal radius r_i , its uncertainty dr_i , equal phase angle a_i , and inter-preon-angle $\theta=0$).

The lepton neutrinos are neutral, interact only weak via Z and W bosons.

	m(nue)	m(num)	m(nut)
exp.			
calc.	0.30meV	11meV	98meV

Energy distribution: preon(u1,u2) bosons A_i

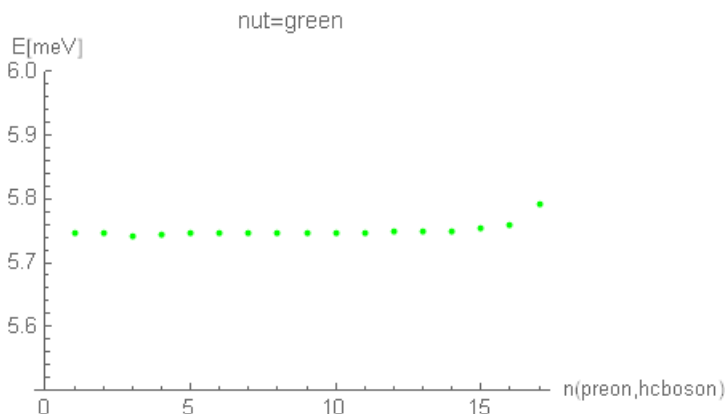
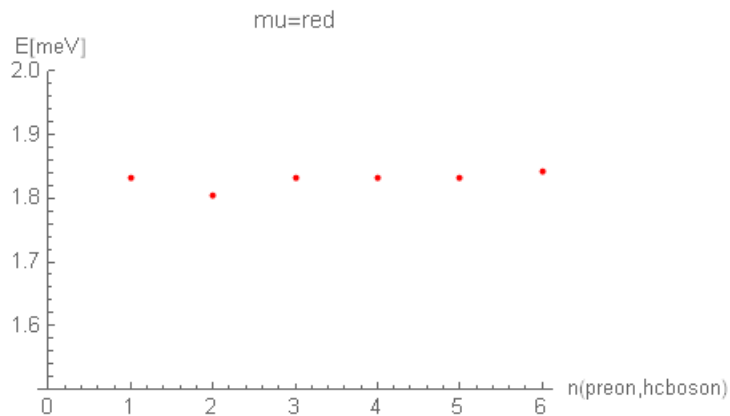
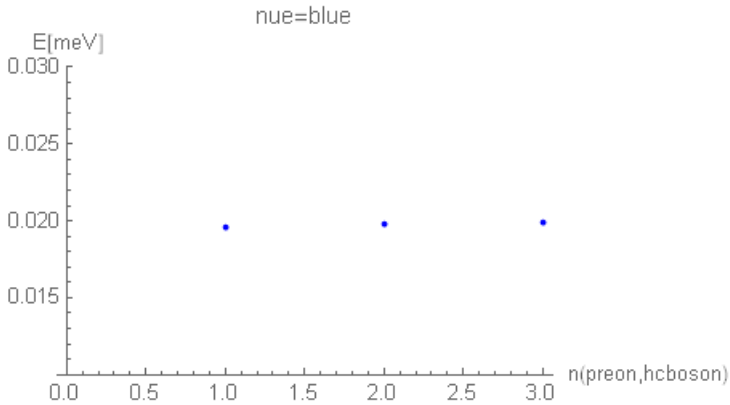

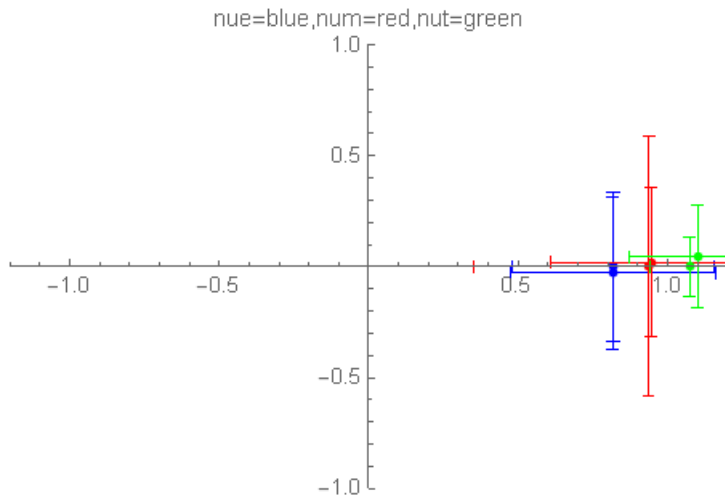
radii r_i , uncertainty dr_i and angle θ **e-neutrino nue=(rL-, rL+)**

$$\text{Preon configuration: } u = \left(\left(\begin{array}{c} rL^- \\ 0 \end{array} \right), \left(\begin{array}{c} 0 \\ rL^+ \end{array} \right), 0, 0 \right)$$

$$\text{Antiparticle right-chiral antineutrino } \bar{u} = \left(0, 0, \left(\begin{array}{c} rR^- \\ 0 \end{array} \right), \left(\begin{array}{c} 0 \\ rR^+ \end{array} \right) \right)$$

$$m < 0.12\text{eV } Q=0$$

$$E_{\text{tot}}=0.30\text{meV}, \Delta E_{\text{tot}}=0.038$$

E_{u_i} (meV)	EA_i	a_i	aA_i	dru_i	ru_i	$\sin(\theta_{u_i})$
0.0195789, 0.0198162	0.0198727	-0.00159052, 0.00281348	0.000719502	0.672092, 0.672795	0.817591, 0.817365	-0.0362275
ΔE_{u_i}	ΔEA_i	Δa_i	ΔaA_i	Δdru_i	Δru_i	$\Delta \sin(\theta_{u_i})$
0.000442384, 0.000217995	0.0000872723	.		0.0533686, 0.0533475	0.000416971, 0.00028167	

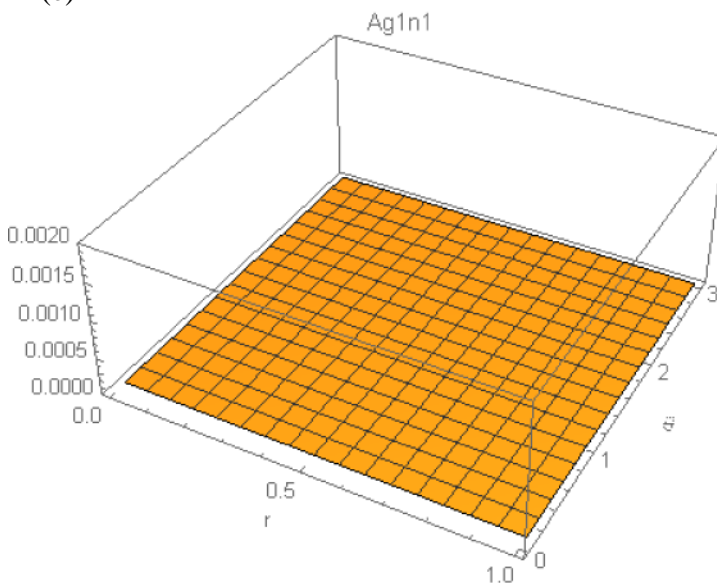
 $A_i(e)$ 

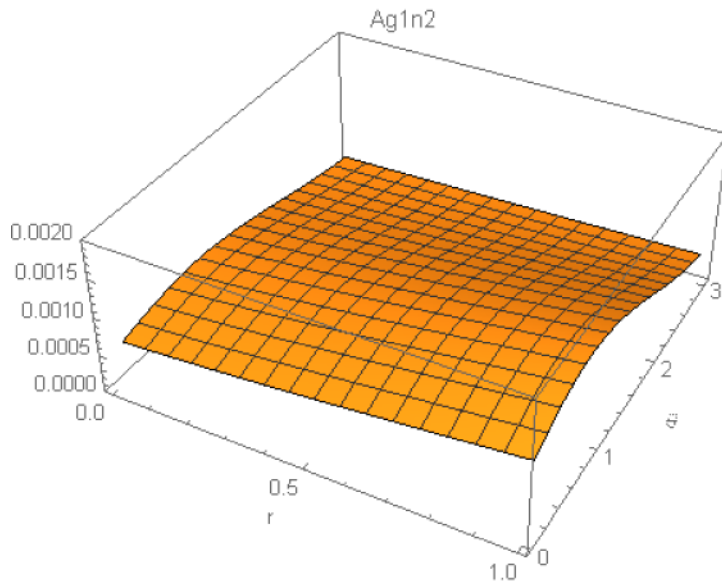

mu-neutrino num=(rL-, rL+)

$m < 0.12\text{eV}$ $Q=0$

$E_{\text{tot}}=11.0\text{meV}$, $\Delta E_{\text{tot}}=0.055$

E_{u_i} (meV)	EA_i	a_i	aA_i	dru_i	ru_i	$\sin(\theta_{u_i})$
1.83215, 1.80438	1.83322, 1.83333, 1.83335, 1.84298	0.00294051, 0.00304653	0.000719502	0.306423, 0.3312	0.943812, 0.936186	0.02
ΔE_{u_i}	ΔEA_i	Δa_i	ΔaA_i	Δdru_i	Δru_i	$\Delta \sin(\theta_{u_i})$
0.00234254, 0.0359295	0.000209844, $2.8895 \cdot 10^{-6}$, 0.0000362216, 0.0162998	.		0.111082, 0.111082	0.126494, 0.179059	

$A_i(e)$

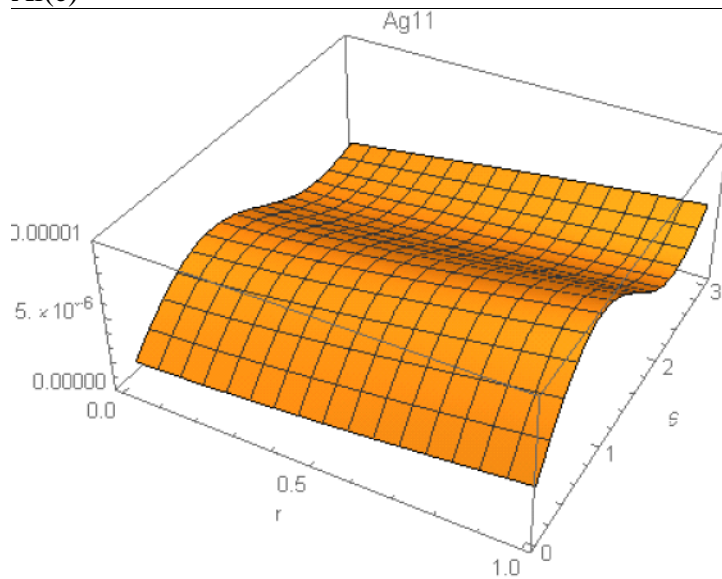

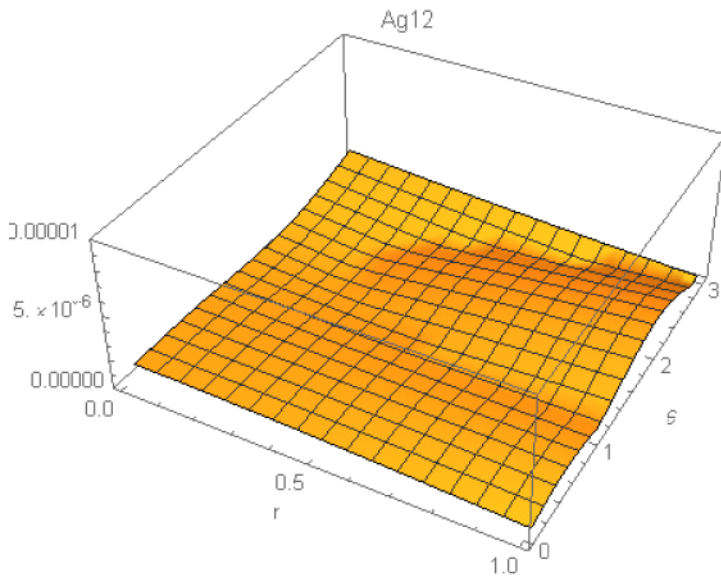

tau-neutrino nut=(rL-, rL+)

$m < 0.12\text{eV}$ $Q=0$

$E_{\text{tot}}=98.0\text{meV}$, $\Delta E_{\text{tot}}=1.85$

E_{u_i} (meV)	EA_i	a_i	aA_i	dru_i	ru_i	$\sin(\theta_{u_i})$
5.74691, 5.74691	5.74263, 5.74519, 5.74578, 5.74647, 5.74688, 5.74707, 5.74725, 5.74761, 5.7479, 5.74861, 5.74951, 5.75005, 5.7531, 5.7595, 5.79127	0.00216278, -0.0145027	0.0645884, 0.0321258, 0.0714192, 0.0356015, 0.0665154, 0.0652989, 0.060689, 0.0555585, 0.0499117, 0.062275, 0.0407549, 0.0359398, 0.0666184, 0.0482816, 0.031136	0.306423, 0.3312	1.1011, ,1.07371	0.0414724
ΔE_{u_i}	ΔEA_i	Δa_i	ΔaA_i	Δdru_i	Δru_i	$\Delta \sin(\theta_{u_i})$
0.110619, 0.110619	0.112495, 0.112474, 0.112249, 0.111351, 0.110999, 0.110905, 0.110818, 0.110445, 0.110137, 0.109776, 0.109065, 0.108836, 0.107668, 0.102724, 0.09513	.		0.207277, 0.197369	0.0609252, 0.06686	

$A_i(e)$

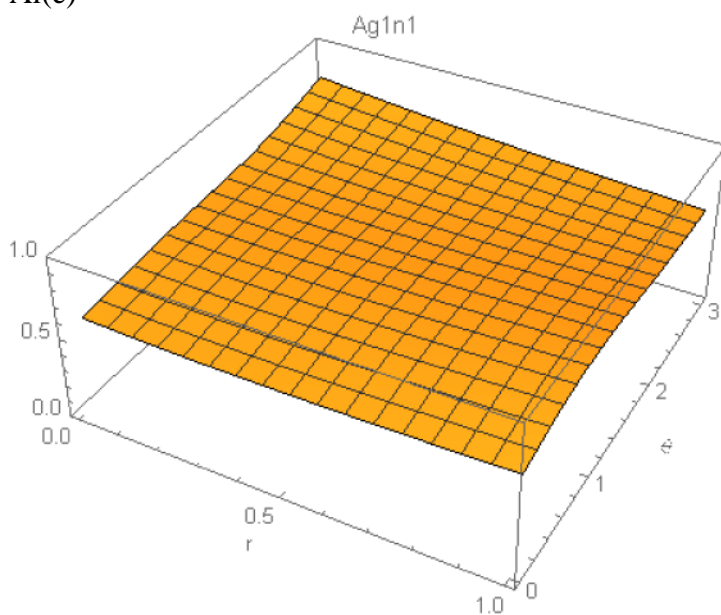

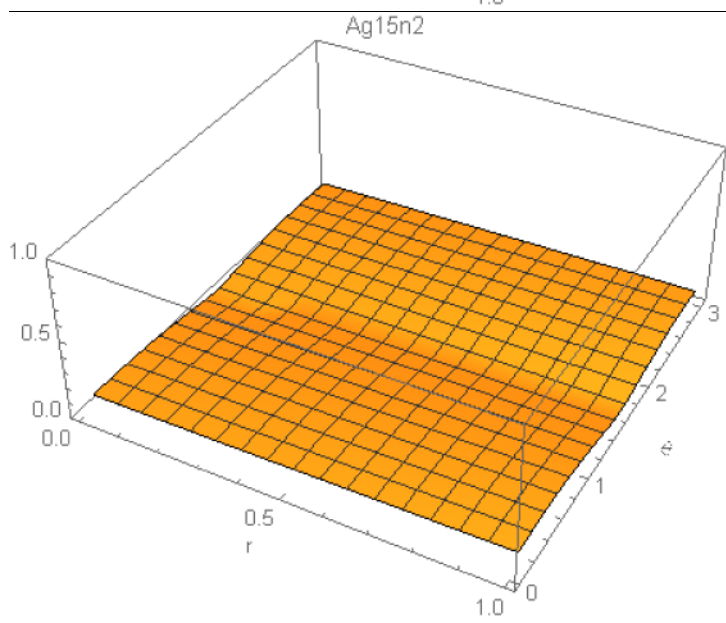
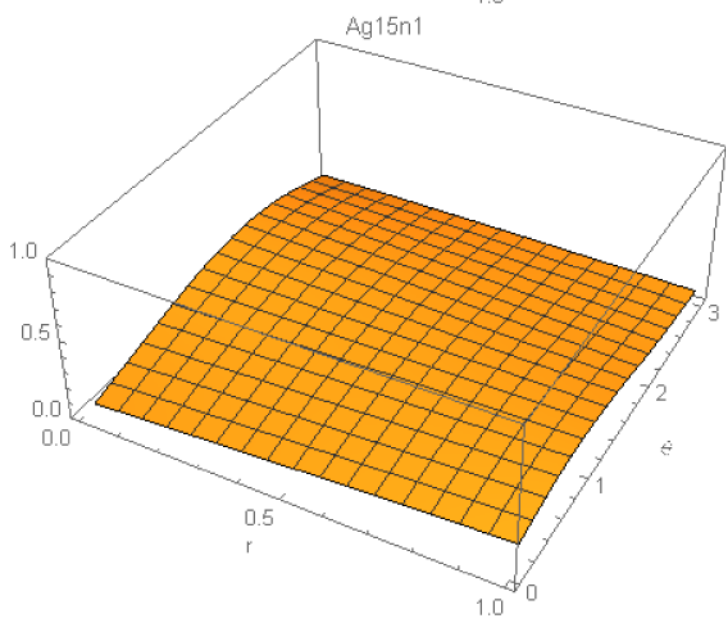
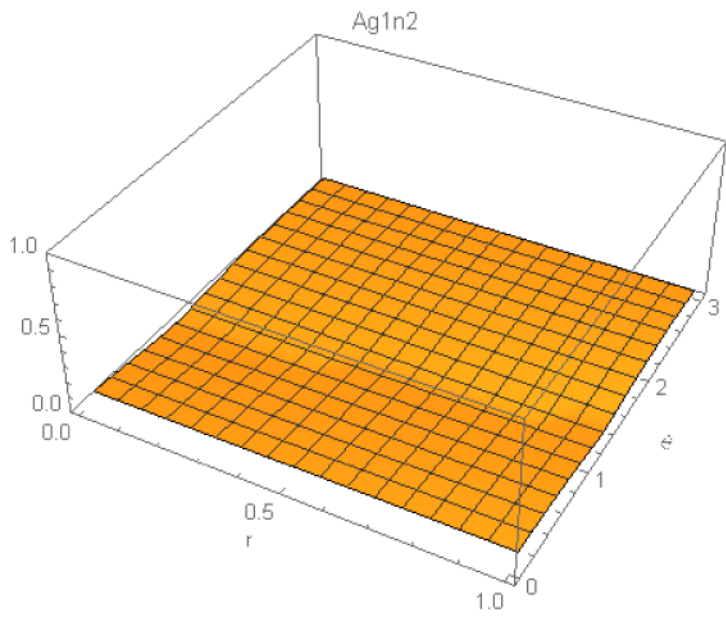

4.3 Non-chiral sterile (hypothetical) neutrinos vs1 , vs2 , vs3

Spin $S=1/2$, two free preons, occupying fixed positions in the hc-tetra-spinor

$$\text{Preon configuration: } u = \left(\left(\begin{matrix} rL- \\ 0 \end{matrix} \right), 0, 0, \left(\begin{matrix} 0 \\ rR+ \end{matrix} \right) \right)$$

Boson configuration: flavor=1: ($A_{14} = \lambda_9$), flavor=2: ($A_{14} = \lambda_9, \bar{A}_{14} = \lambda_{10}, A_{23} = \lambda_6, \bar{A}_{23} = \lambda_7$)
 flavor=3: all 15 bosons

The hypothetical sterile neutrinos are involved in the neutron decay and interact only among themselves and with lepton neutrinos via the weak chiral boson ZL (see 4.1), so the denomination “sterile” is justified. They have similar masses as the lepton neutrinos, but are Majorana particles: antiparticle=particle. Like lepton neutrinos, they are spherically symmetric and have zero magnetic momentum.

	m(nus1)	m(nus2)	m(nus3)
exp.			
calc.	0.09meV	3.6meV	100meV

Energy distribution: preon(u1,u2) bosons Ai

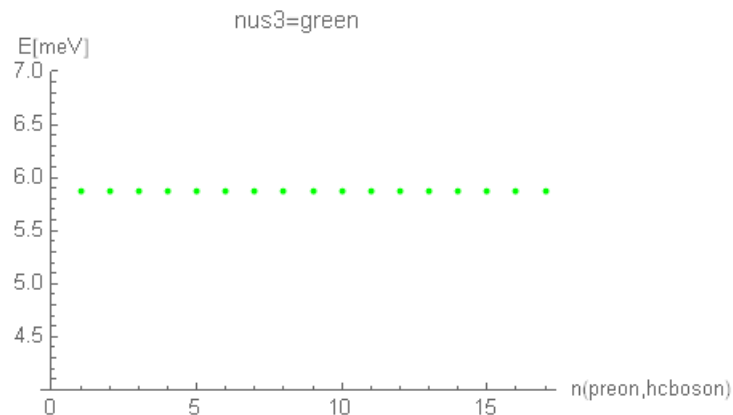
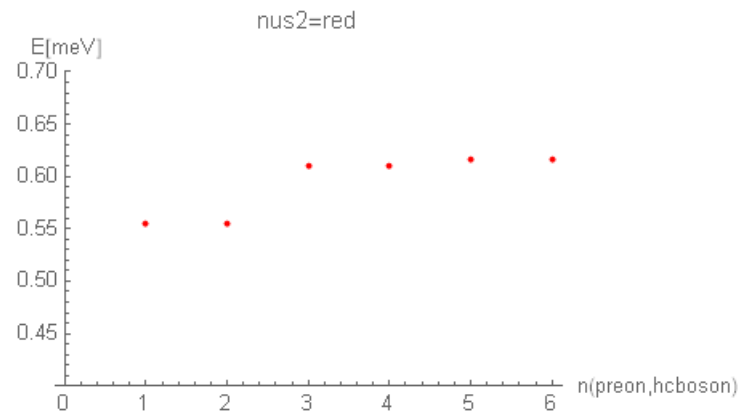
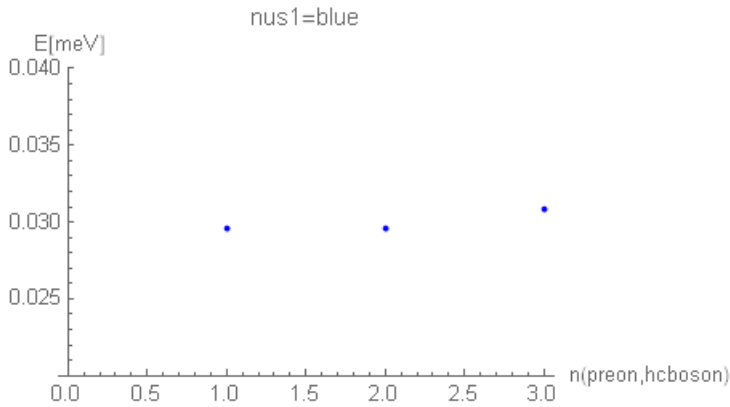

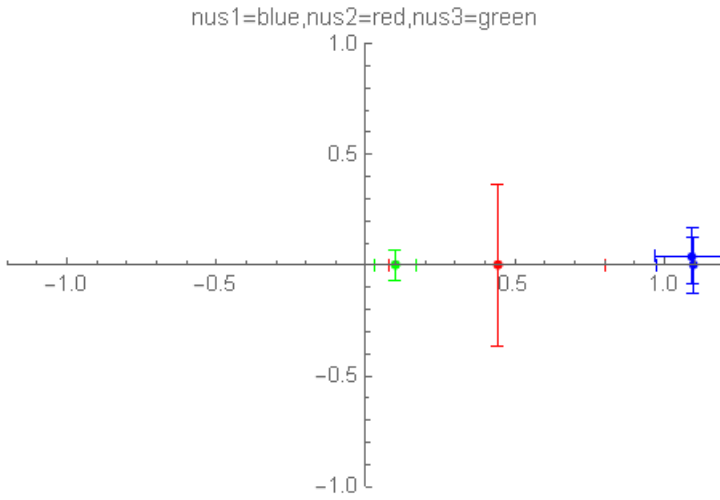
radii r_i , uncertainty dr_i and angle θ **nc-neutrino 1 nus1=(rL-, rR+)**

Preon configuration: $u = \left(\begin{pmatrix} rL- \\ 0 \end{pmatrix}, 0, 0, \begin{pmatrix} 0 \\ rR+ \end{pmatrix} \right)$

Antiparticle $\bar{u} = u$ (Majorana neutrino)
 $m < 0.12\text{eV}$ $Q=0$

$E_{\text{tot}}=0.090\text{meV}$, $\Delta E_{\text{tot}}=0.023$

E_{u_i} (meV)	EA_i	a_i	aA_i	dru_i	ru_i	$\sin(\theta_{u_i})$
0.0295438, 0.0295438	0.03085	0.00981786, - 0.00539754	0.000719502	0.247601, 0.245064	1.0941, 1.09465	0.0385823
ΔE_{u_i}	ΔEA_i	Δa_i	ΔaA_i	Δdru_i	Δru_i	$\Delta \sin(\theta_{u_i})$
0.000714214, 0.000714214	0.000840173	.		0.00802575, 0.00776682	0.00348974, 0.00362492	

Ai(e)

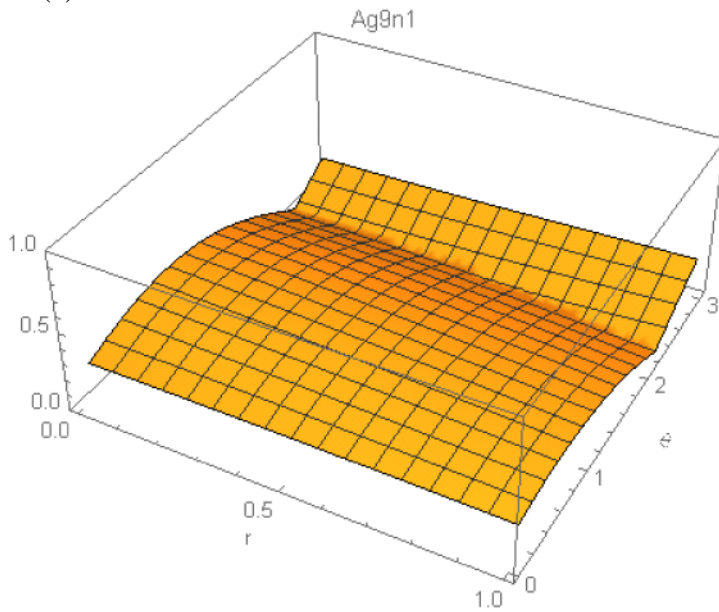

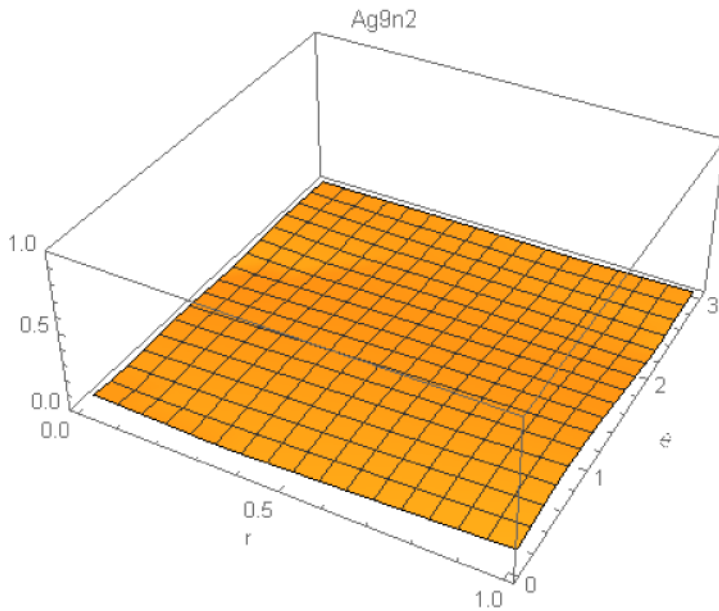

nc-neutrino 2 nus2=(rL-, rR+)
 $m < 0.12\text{eV}$ $Q=0$

$E_{\text{tot}}=3,56\text{meV}$, $\Delta E_{\text{tot}}=0.22$

E_{u_i} (meV)	EA_i	a_i	aA_i	dru_i	ru_i	$\sin(\theta_{u_i})$
0.555866, 0.555866	0.610776, 0.610849, 0.616444, 0.616708	0.0837203, 0.0837203	0.524038, 0.145884, 0.584979, 0.615694	2.22087, 2.22087	0.439613, 0.439613	0.0
ΔE_{u_i}	ΔEA_i	Δa_i	ΔaA_i	Δdru_i	Δru_i	$\Delta \sin(\theta_{u_i})$
0.0579322, 0.0579322	0.029421, 0.0294231, 0.0244551, 0.0243638	.		1.8611, 1.8611	0.337827, 0.337827	

$A_i(e)$

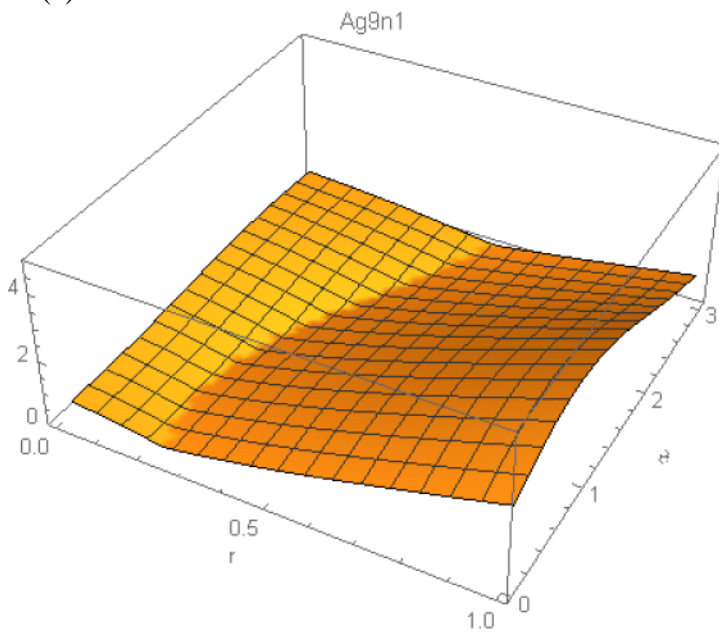

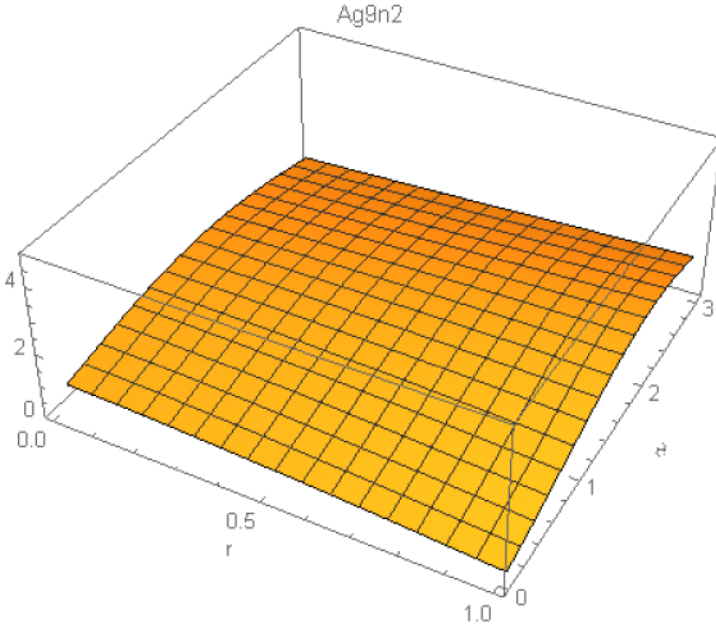

nc-neutrino 3 nus3=(rL-, rR+)
 $m < 0.12\text{eV}$ $Q=0$

$E_{\text{tot}}=100\text{meV}$, $\Delta E_{\text{tot}}=0.064$

E_{u_i} (meV)	EA_i	a_i	aA_i	dru_i	ru_i	$\sin(\theta_{u_i})$
5.87822, 5.87822	5.88029, 5.88029, 5.88029, 5.88029, 5.88029, 5.88029, 5.88029, 5.88029, 5.88029, 5.88029, 5.88029, 5.88029, 5.88029	0.0997489, 0.0997489	0.0517683, 0.0478681, 0.156694, 0.0480563, 0.0494643, 0.0577212, 0.0685586, 0.155112, 0.0500668, 0.050109, 0.0505401, 0.15493, 0.468362, 0.154732, 0.155897	0.0261638, 0.0261638	0.0974364, 0.0974364	0.0
ΔE_{u_i}	ΔEA_i	Δa_i	ΔaA_i	Δdru_i	Δru_i	$\Delta \sin(\theta_{u_i})$
0.00678084, 0.00678084	0.00339045, 0.00339045, 0.00339044, 0.00339043, 0.00339043, 0.00339043, 0.00339042, 0.00339042, 0.00339042, 0.00339042, 0.00339042, 0.00339041, 0.00339011, 0.00338995, 0.00338953, 0.00338949	.		0.0738441, 0.0738441	0.0850158, 0.0850158	

$A_i(e)$

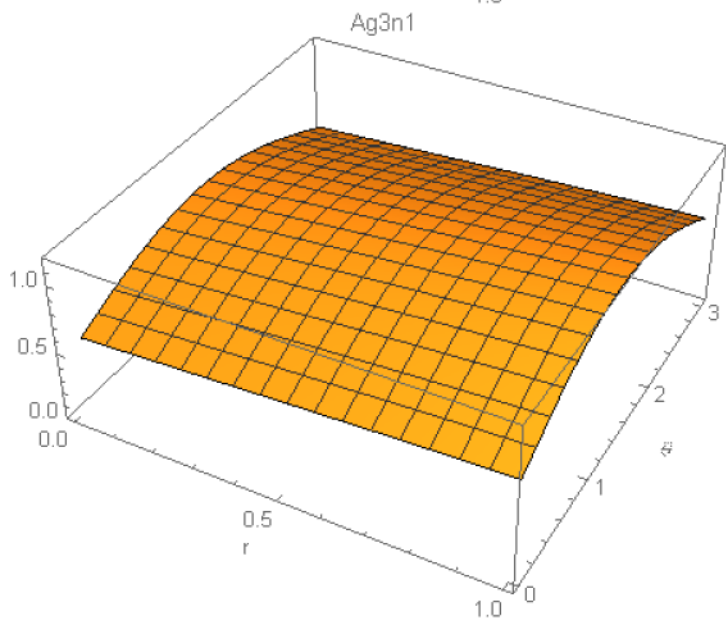
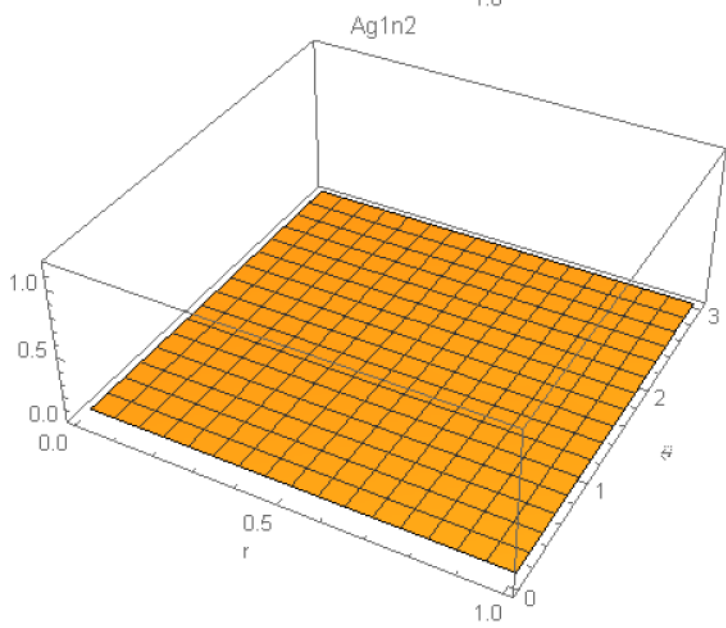
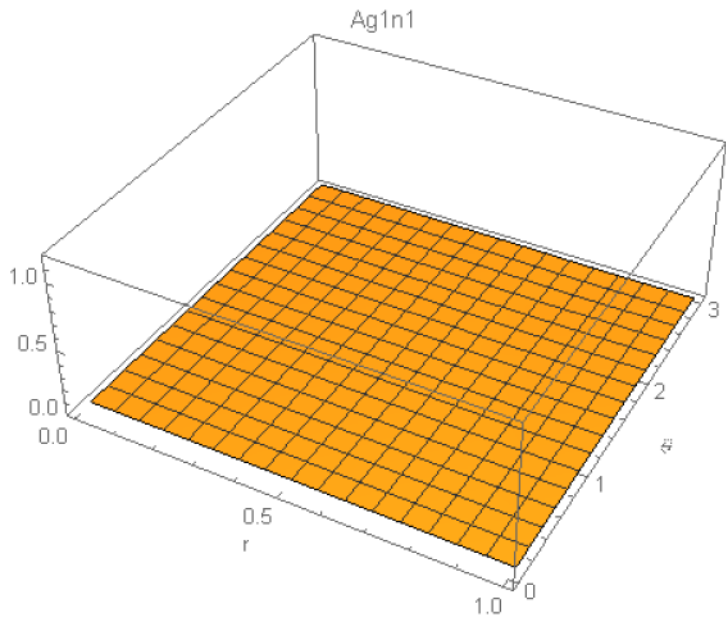

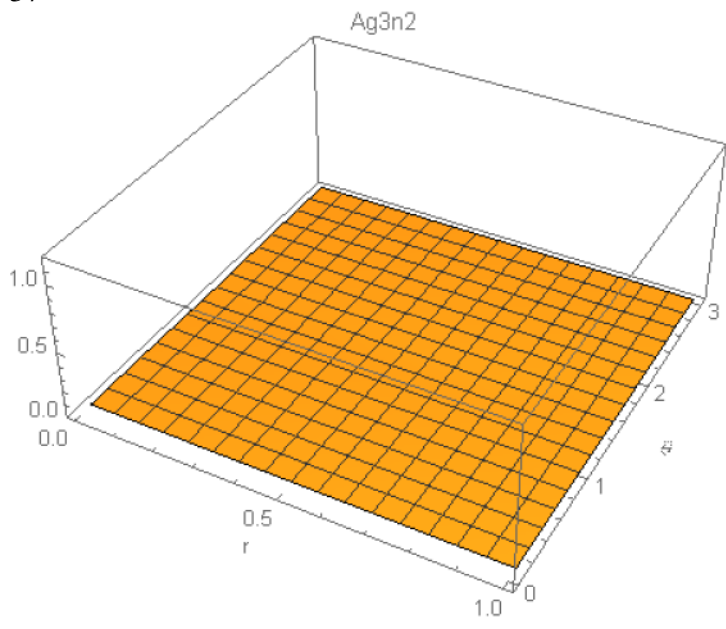

4.4 U-quarks u, c, b

Spin $S=1/2$, two free preons, occupying fixed positions in the hc-tetra-spinor

$$\text{Preon configuration: } u = \left(0, \left(\frac{(rL++qL+)/\sqrt{2}}{\left((rL++qL+)/\sqrt{2} \right)}, 0, \left(\frac{(rR++qR+)/\sqrt{2}}{\left((rR++qR+)/\sqrt{2} \right)} \right) \right)$$

Boson configuration: flavor=1: ($A_{24} = \lambda_{11}$), flavor=2: ($A_{24} = \lambda_{11}, \bar{A}_{24} = \lambda_{12}, A_{13} = \lambda_4, \bar{A}_{13} = \lambda_5$)
 flavor=3: all 15 bosons

The u-quarks have the composition (r+,q+), and they are non-chiral, i.e. a superposition of (rL+,qR+) and (rR+,qL+). They are non-symmetric in r and q, so their internal structure is cylinder-symmetric or ring-symmetric, therefore there are corrections to the standard gyromagnetic factor 2, like for the nucleons. They carry the color charge, and do not appear separately, as the overall color must be zero (white).

	m(u)	m(c)	m(t)
exp.	2.3MeV	1.34GeV	171GeV
calc.	2.35	3.2	163

Energy distribution: preon(u1,u2) bosons A_i

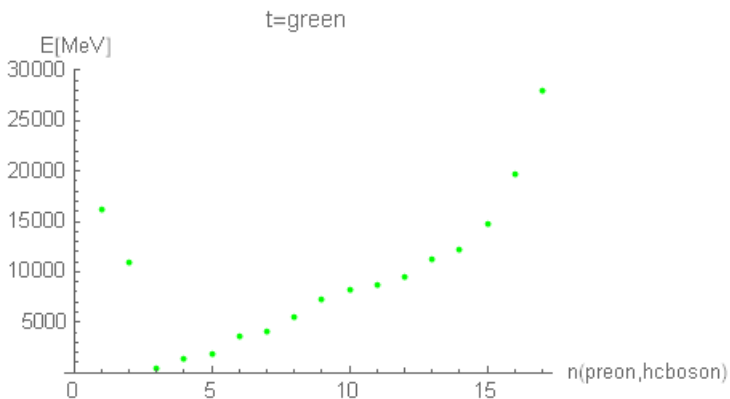
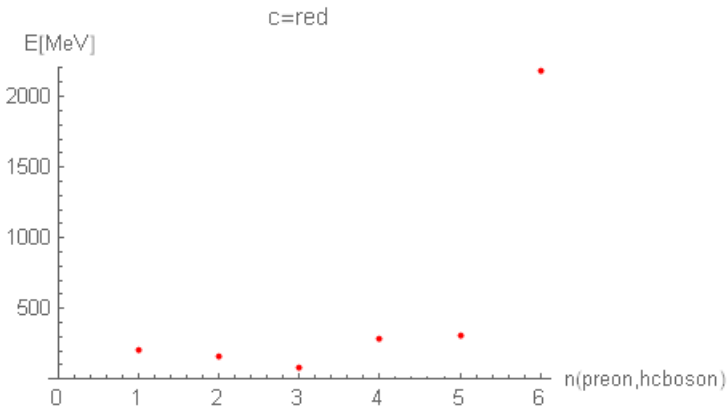
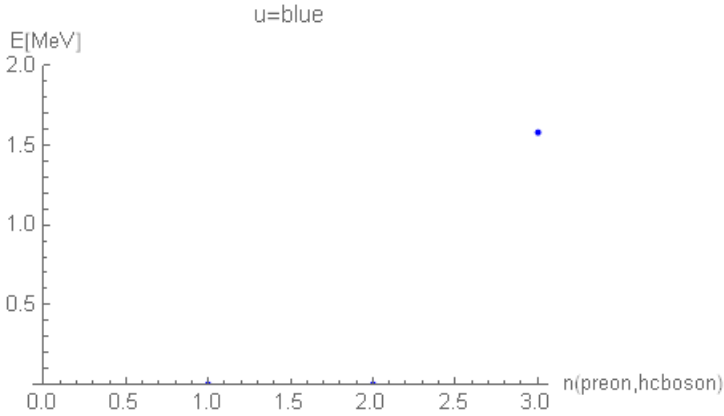

radii r_i , uncertainty dr_i and angle θ

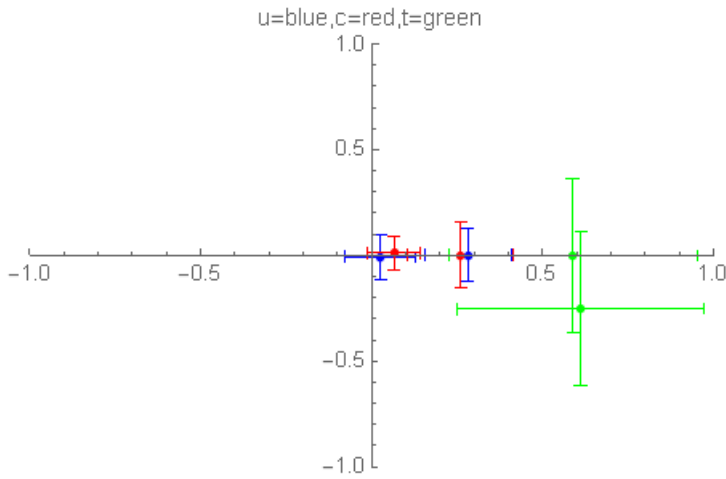

u-quark $u=(rL++qR+)/\sqrt{2}$

Preon configuration: $u = \left(0, \left(\frac{(rL++qL+)}{\sqrt{2}} \right), 0, \left(\frac{(rR++qR+)}{\sqrt{2}} \right) \right)$

Antiparticle $\bar{u} = \left(\left(\frac{(rL--qL-)}{\sqrt{2}} \right), 0, \left(\frac{(rR--qR-)}{\sqrt{2}} \right), 0 \right)$

$m=2.3\text{MeV}$ $Q=+2/3$

$E_{\text{tot}}=2.35\text{MeV}$, $\Delta E_{\text{tot}}=0.26$

Eu_i (MeV)	EA_i	a_i	aA_i	dru_i	ru_i	$\sin(\theta u_i)$
0.00100815, 0.00100963	1.58472	0.0674651, 0.100981	-0.538922	0.209696, 0.253259	0.0263, - 0.280785	0.318731
ΔEu_i	ΔEA_i	Δa_i	ΔaA_i	Δdru_i	Δru_i	$\Delta \sin(\theta u_i)$
0.000620367, 0.00057238	0.254744	.		5.22386n, 4.83211n	4.72523n, 3.27625n	

$Ai(e)$

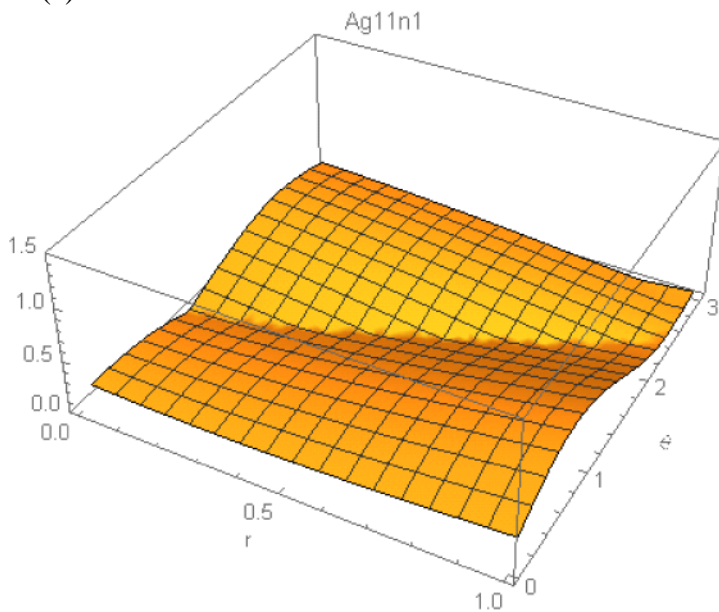

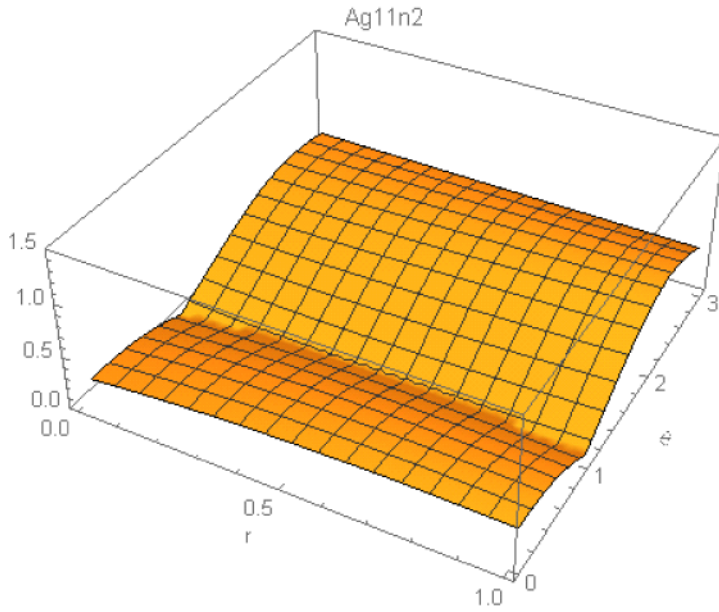

c-quark $c=(rL+ + qR+)/\sqrt{2}$
 $m=1.34\text{GeV}$ $Q=+2/3$

$E_{\text{tot}}=3.2\text{GeV}$, $\Delta E_{\text{tot}}=0.018$

E_{u_i} (MeV)	EA_i	a_i	aA_i	dru_i	ru_i	$\sin(\theta_{u_i})$
207.62, 158.774	84.6596, 281.775, 304.222, 2180.43	-0.0473157, -0.196647	0.187462, 0.228959, 0.152956, -0.33979	0.157295, 0.31158	0.0654933, 0.259696	0.15086
ΔE_{u_i}	ΔEA_i	Δa_i	ΔaA_i	Δdru_i	Δru_i	$\Delta \sin(\theta_{u_i})$
4.8244, 2.96717	2.81296, 3.12201, 1.59539, 3.39955	.		3.32725u, 3.00652u	0.845404u, 0.406528u	

$A_i(e)$

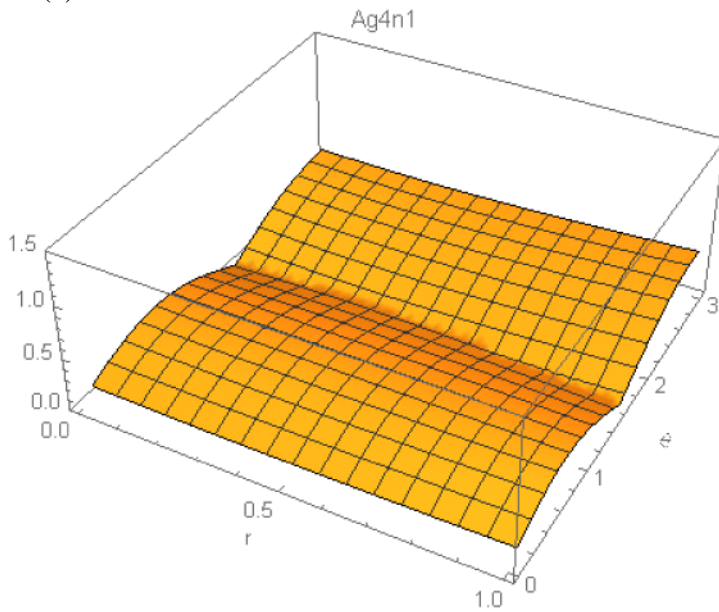

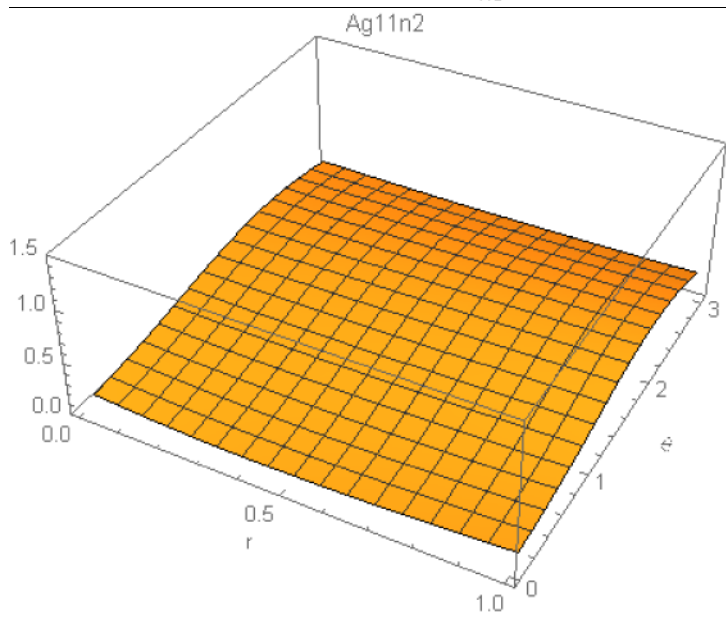
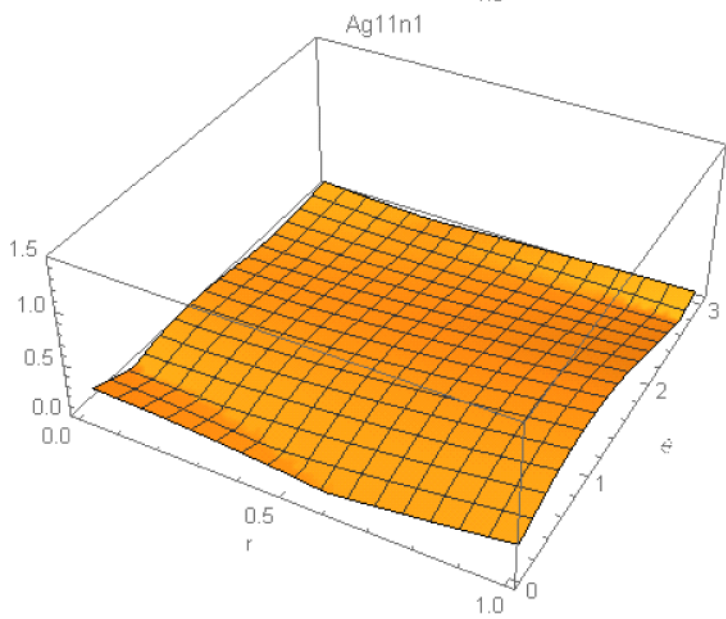
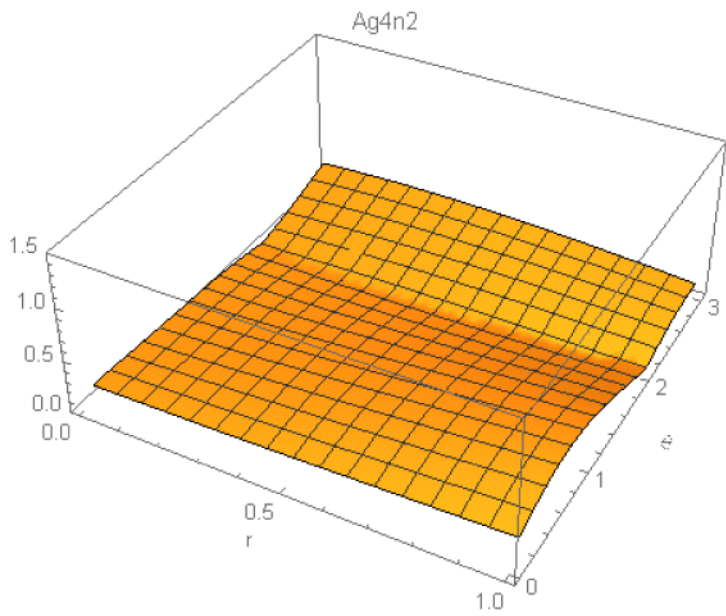

t-quark $c=(rL+ + qR+)/\sqrt{2}$

$m=171\text{GeV } Q=+2/3$

$E_{\text{tot}}=163\text{GeV}, \Delta E_{\text{tot}}=55$

E_{u_i} (MeV)	EA_i	a_i	aA_i	dru_i	ru_i	$\sin(\theta_{u_i})$
16169.4,	447.568, 1324.51,	0.260102, -	0.0345205, -	2.30158,	0.661335, -	0.381818

10963.2	1905.22, 3572.08, 4060.9, 5512.97, 7201.35, 8224.84, 8756.76, 9567.63, 11233.9, 12195.9, 14838.4, 19649.7, 27968.5	0.288355	0.0889711, 0.117581, 0.0804355, 0.0439144, 0.0473357, - 0.10843, 0.016335, - 0.129588, -0.247394, -0.0279795, - 0.18897, -0.337228, 0.0823711, - 0.174481	2.56518	0.588081	
$\Delta E u_i$	$\Delta E A_i$	Δa_i	$\Delta a A_i$	$\Delta d r u_i$	$\Delta r u_i$	$\Delta \sin(\theta u_i)$
10545.1, 7710.93	650.619, 827.92, 845.732, 723.36, 260.622, 1147.26, 2692.84, 3336.08, 3111.95, 2532.61, 1738.6, 1466.69, 3647.34, 7499.15, 7115.09	.		0.896934, 0.609087	0.559172, 0.505538	

$A_i(e)$

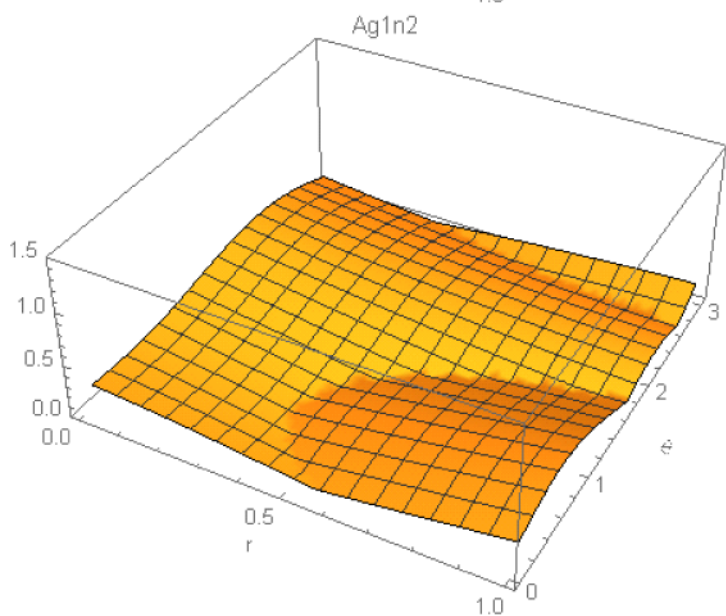
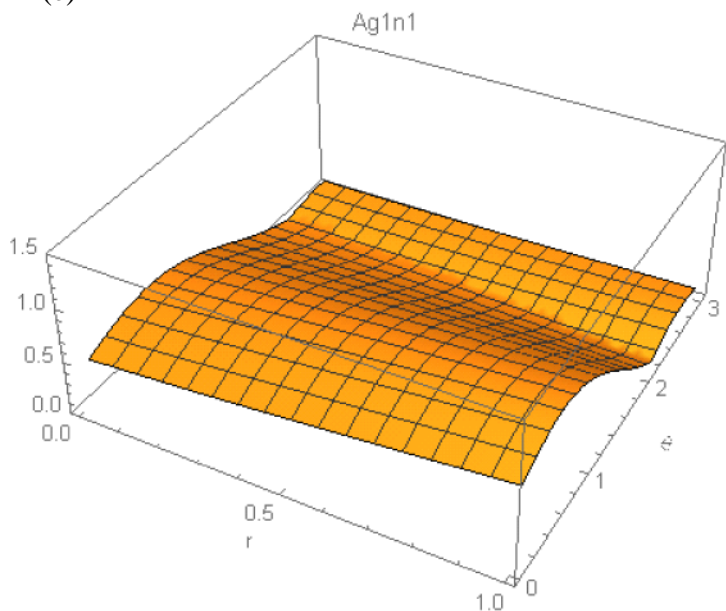

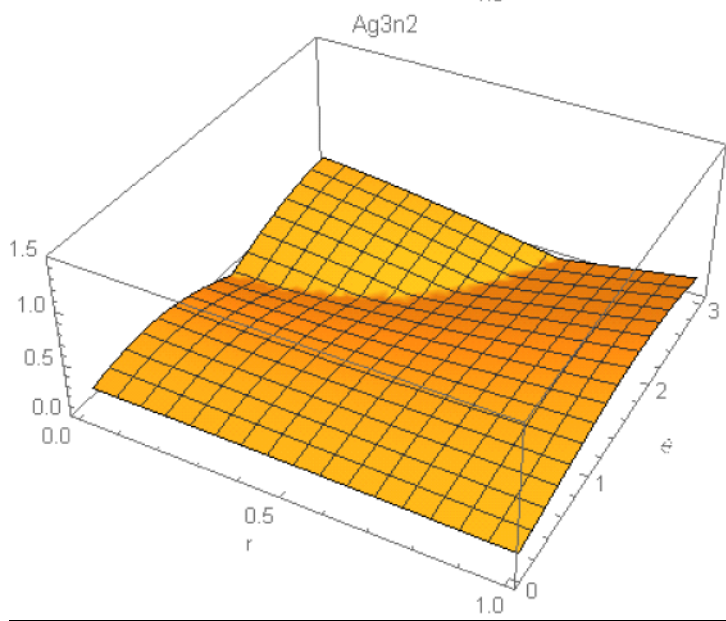
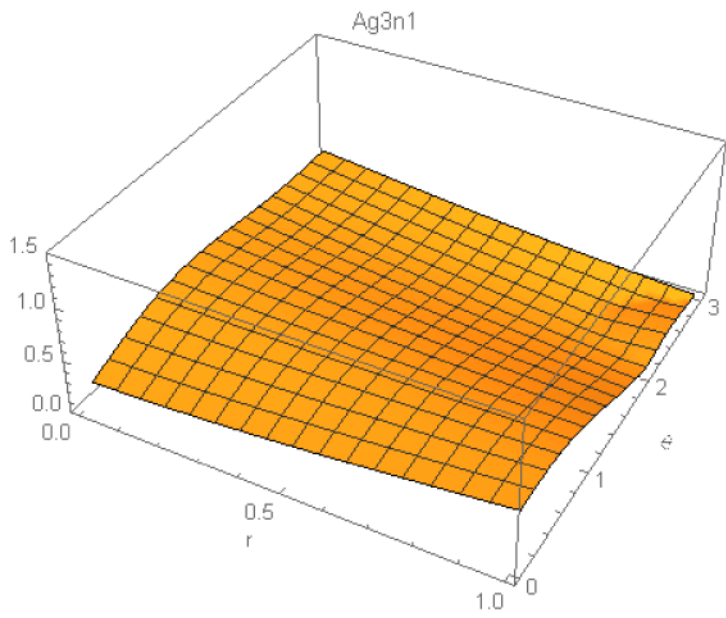

4.5 D-quarks d, s, b

Spin $S=1/2$, two free preons, occupying fixed positions in the hc-tetra-spinor

$$\text{Preon configuration: } u = \left(\left(\begin{array}{c} (rL - + qL +) / \sqrt{2} \\ 0 \end{array} \right), 0, \left(\begin{array}{c} (rR - + qR +) / \sqrt{2} \\ 0 \end{array} \right), 0 \right)$$

Boson configuration: flavor=1: ($A_{13} = \lambda 4$), flavor=2: ($A_{13} = \lambda 4, \bar{A}_{13} = \lambda 5, A_{24} = \lambda 11, \bar{A}_{24} = \lambda 12$)

flavor=3: all 15 bosons

	m(d)	m(dC), $\alpha(C)$	m(s)	m(b)
exp.	4.8MeV	4.8MeV, 13.04°	100MeV	4.2GeV
calc.	4.58	4.74MeV, 13.1°	149	6.1

The d-quarks have the composition (r-,q+), and they are non-chiral, i.e. a superposition of (rL-,qR+) and (rR-,qL+). They are non-symmetric in r and q, so their internal structure is cylinder-symmetric or ring-symmetric, therefore there are corrections to the standard gyromagnetic factor 2, like for the nucleons. They carry the color charge, and do not appear separately, as the overall color must be zero (white).

D-quark flavors intermix via the CKM-matrix, its angles can be calculated (see dC-quark) by making a linear combination with variable CKM-angles, inserting into the hc-Lagrangian and minimizing. The solution is the energetically optimal CKM-mixture and yields the observed CKM-angles.

Energy distribution: preon(u1,u2) bosons A_i

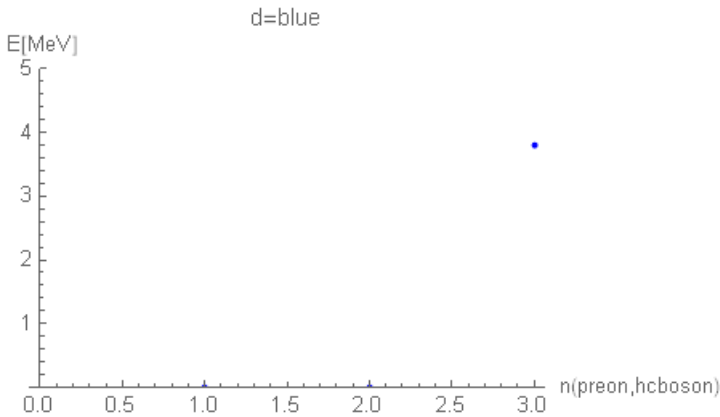

dC=d-part of Cabibbo-mixed quark (d,s), calculated Cabibbo-angle $a_{C12}=0.229=13.13^\circ$ (exp. $13.04^\circ \pm 0.05$)

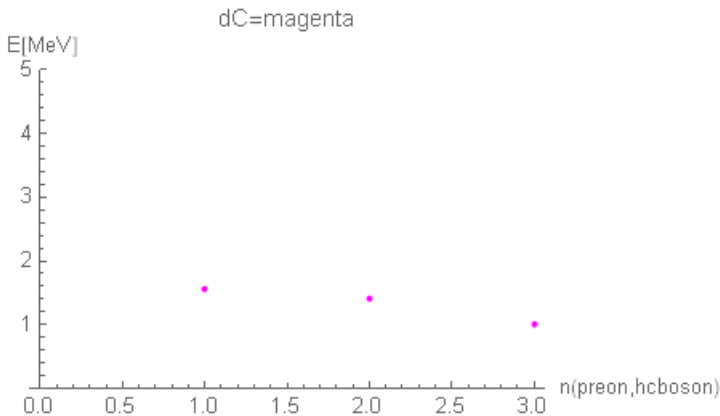

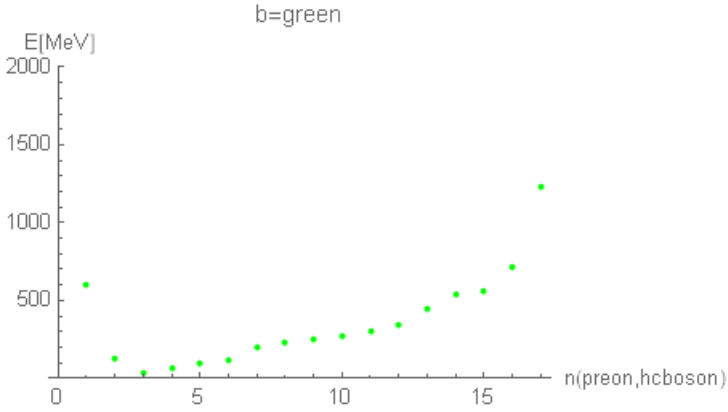
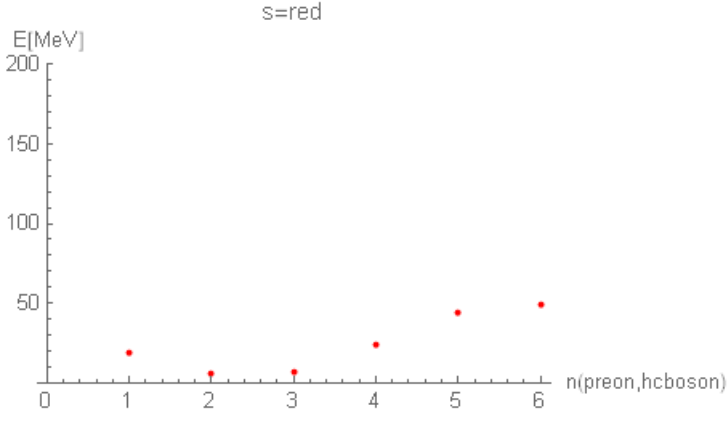

radii r_i , uncertainty dr_i and angle θ

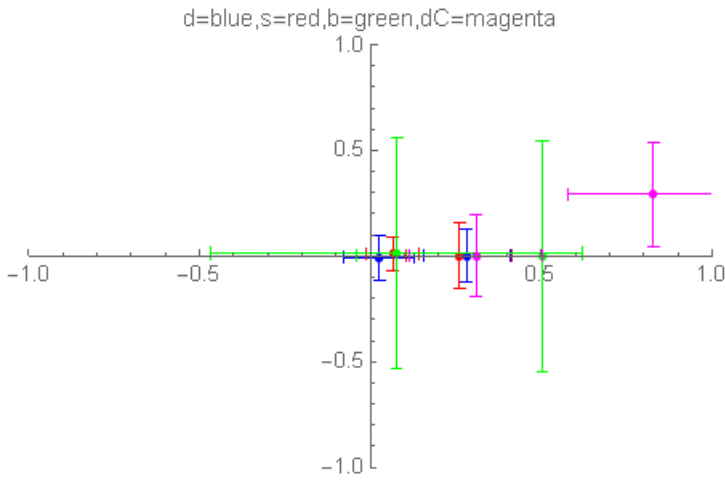

d-quark $\mathbf{d}=(rL- + qR+)/\sqrt{2}$

Preon configuration: $u = \left(\left(\begin{matrix} (rL- + qL+)/\sqrt{2} \\ 0 \end{matrix} \right), 0, \left(\begin{matrix} (rR- + qR+)/\sqrt{2} \\ 0 \end{matrix} \right), 0 \right)$

Antiparticle $\bar{u} = \left(0, \left(\begin{matrix} 0 \\ (rL++ + qL-)/\sqrt{2} \end{matrix} \right), 0, \left(\begin{matrix} 0 \\ (rR++ + qR-)/\sqrt{2} \end{matrix} \right) \right)$

$m=4.8\text{MeV}$ $Q=-1/3$

$E_{\text{tot}}=4.58\text{MeV}$, $\Delta E_{\text{tot}}=0.31$

E_{u_i} (MeV)	EA_i	a_i	aA_i	dr_{u_i}	ru_i	$\sin(\theta_{u_i})$
0.0011901, 0.000620564	3.81209	0.067465, 0.100981	-0.538924	0.209696, 0.253259	0.0263002, - 0.280785	0.318731
ΔE_{u_i}	ΔEA_i	Δa_i	ΔaA_i	Δdr_{u_i}	Δru_i	$\Delta \sin(\theta_{u_i})$
0.000811471,	0.305601	.		0.188066*u,	0.476172u,	

0.00070369				0.900718u	0.350625u	
------------	--	--	--	-----------	-----------	--

Ai(e)

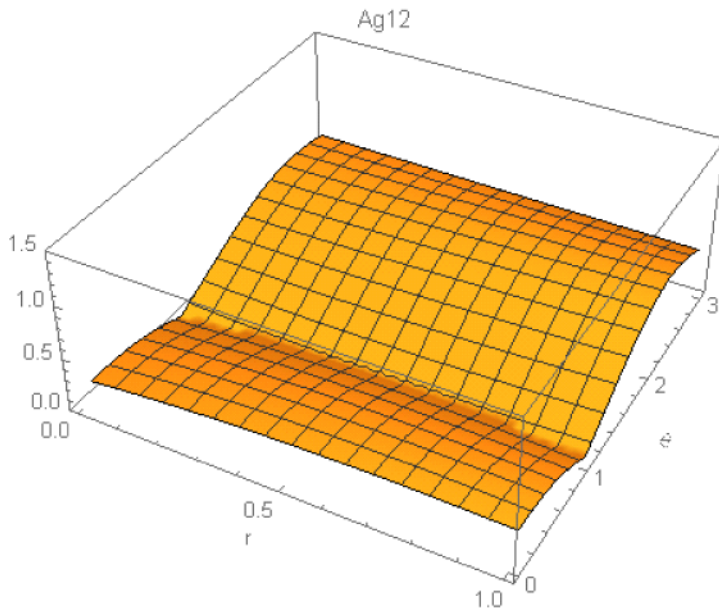
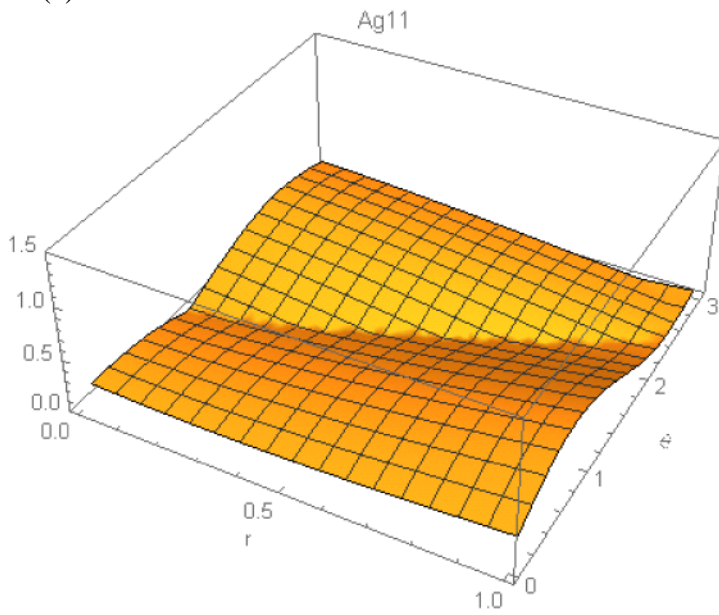

s-quark $s=(rL^- + qR^+)/\sqrt{2}$

$m=100\text{MeV}$ $Q=-1/3$

$E_{\text{tot}}=149\text{MeV}$, $\Delta E_{\text{tot}}=15$

E_{u_i} (MeV)	EA_i	a_i	aA_i	dru_i	ru_i	$\sin(\theta_{u_i})$
18.791, 5.99053	6.94284, 24.1632, 43.9623, 48.9406	-0.047311, - 0.196639	-0.339778, 0.228951, 0.164457, 0.175962	0.157295, 0.311592	0.0654906, 0.259695	0.150859
ΔE_{u_i}	ΔEA_i	Δa_i	ΔaA_i	Δdru_i	Δru_i	$\Delta \sin(\theta_{u_i})$
1.73863, 1.93842	2.1682, 1.88257, 6.34742, 1.22757				18.3405n, 8.854n	

Ai(e)

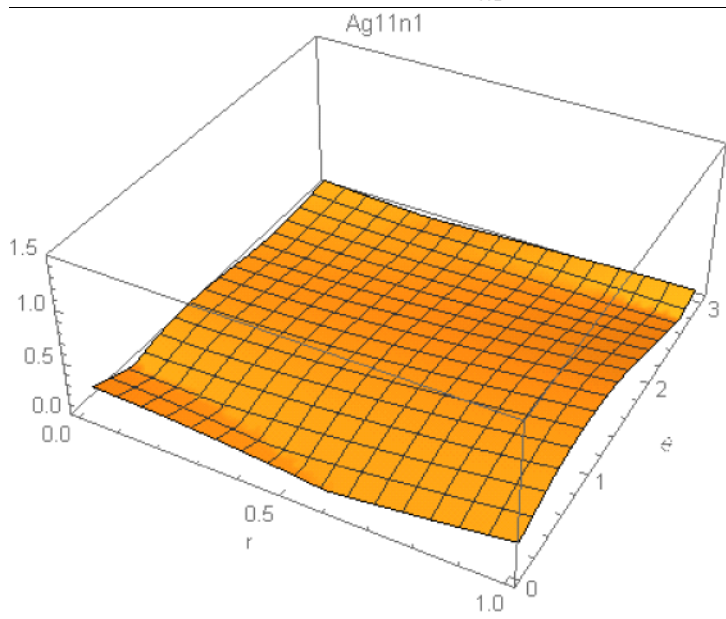
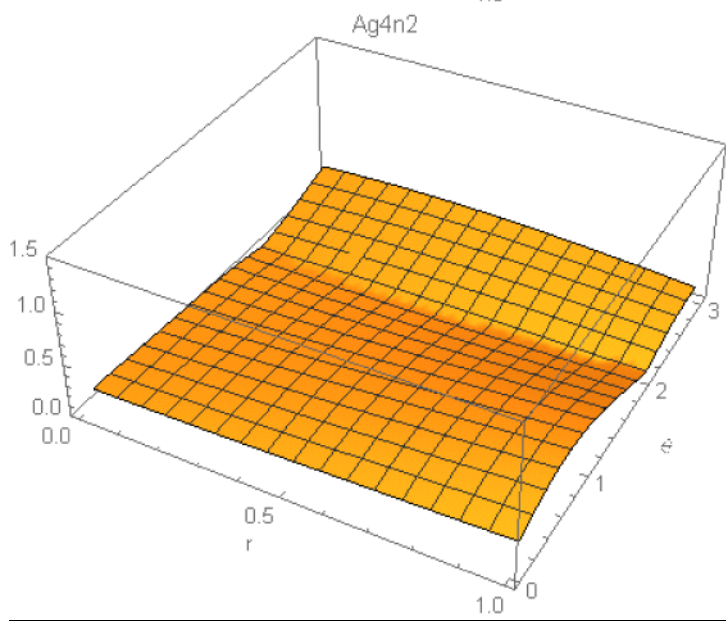
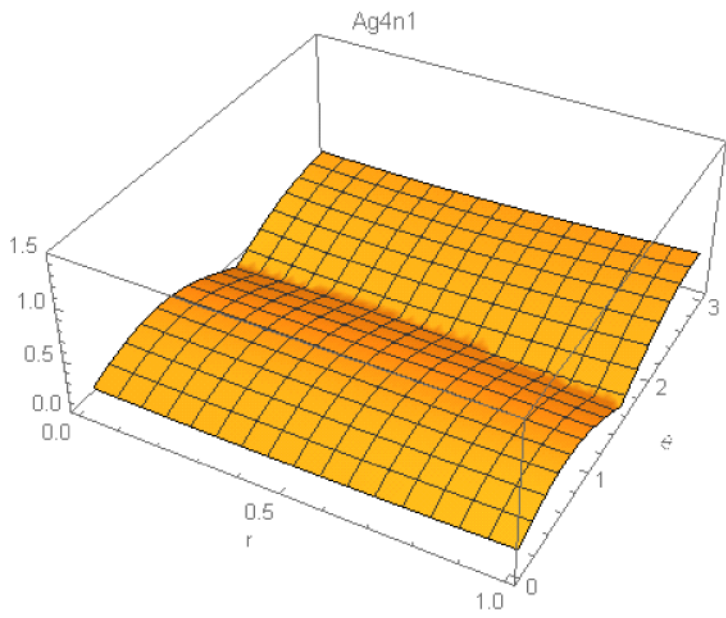

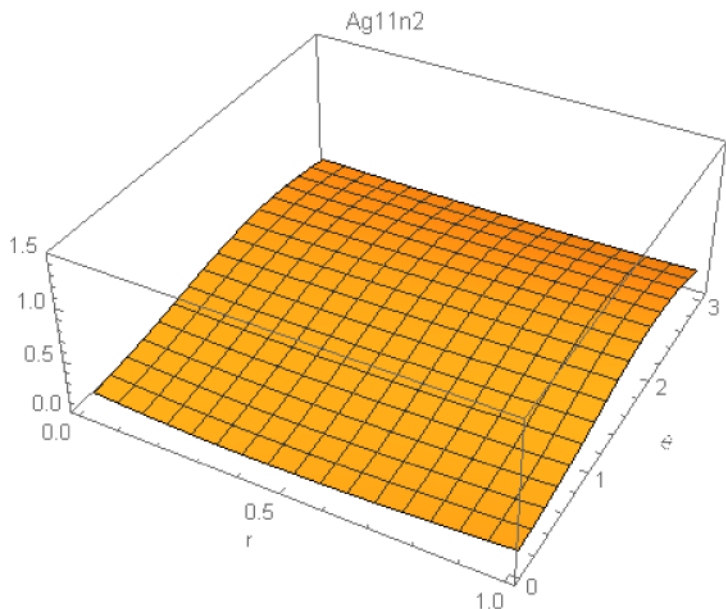

b-quark $\mathbf{b}=(rL- + qR+)/\sqrt{2}$
 $m=4.2\text{GeV}$ $Q=-1/3$

$E_{\text{tot}}=6.1\text{GeV}$, $\Delta E_{\text{tot}}=2.9$

E_{u_i} (MeV)	EA_i	a_i	aA_i	dru_i	ru_i	$\sin(\theta_{u_i})$
601.532, 130.4	35.4338, 69.6218, 92.0785, 120.049, 193.853, 224.967, 255.088, 266.136, 297.881, 348.389, 446.951, 535.473, 559.583, 713.301, 1232.01	-0.350658, 0.419618	-0.119199, 0.0701848, 0.0403467, 0.2601, 0.0412506, 0.175386, -0.0645038, 0.196578, 0.00791169, - 0.0408362, - 0.309195, 0.147146, 0.0139774, - 0.126303, -0.178367	2.00585, 1.73462	0.0775948, 0.502463	0.186426
ΔE_{u_i}	ΔEA_i	Δa_i	ΔaA_i	Δdru_i	Δru_i	$\Delta \sin(\theta_{u_i})$
472.193, 67.3475	20.0937, 39.4015, 39.3106, 70.0438, 171.994, 191.423, 173.845, 173.003, 149.678, 106.309, 107.786, 107.91, 124.87, 228.263, 689.167			0.903552, 0.675784	0.0546897, 0.235836	

$A_i(e)$

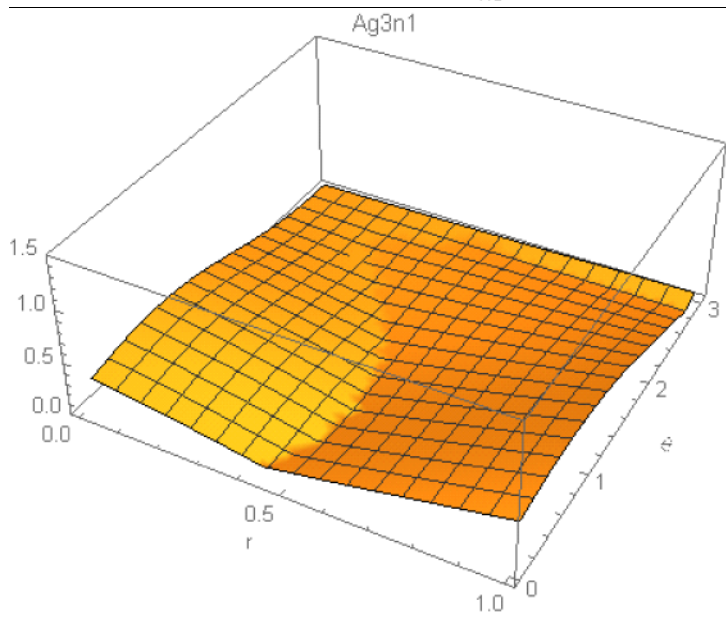
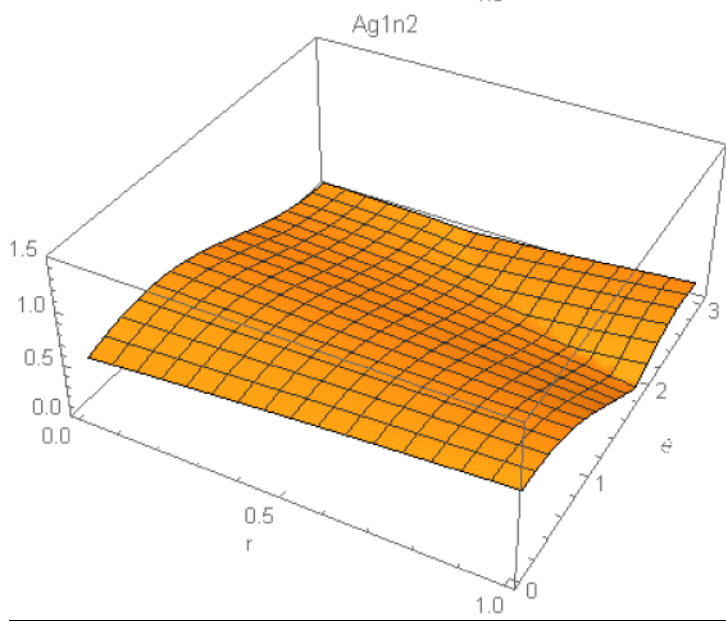
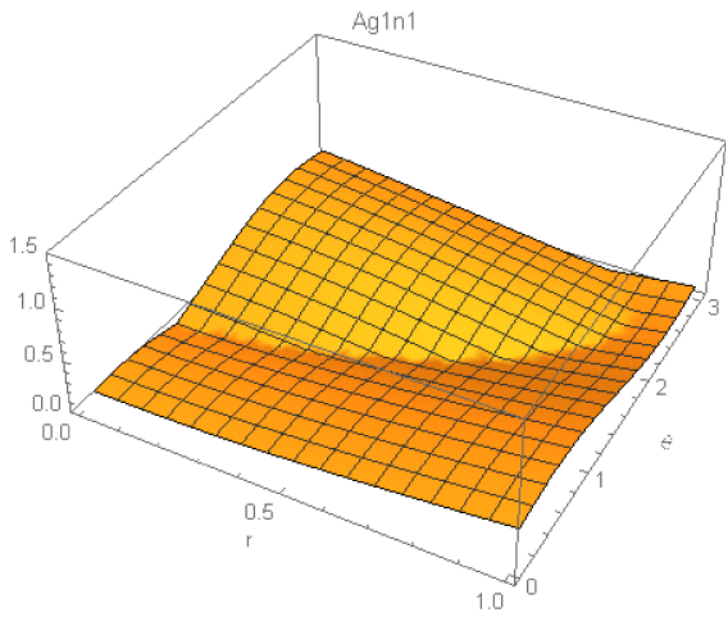

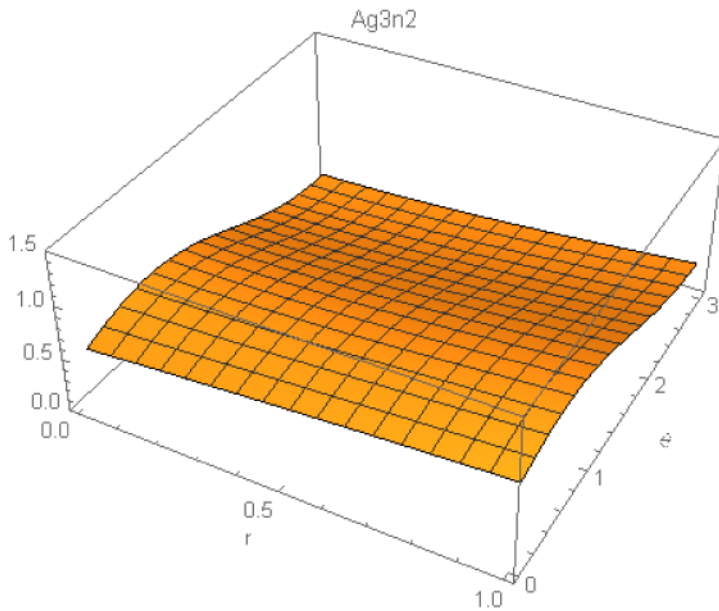

Cabibbo-mixed d-quark $dC=(rL^- + qR^+)/\sqrt{2}$
 $m=4.8\text{MeV}$ $Q=-1/3$

$E_{\text{tot}}=4.74\text{MeV}$, $\Delta E_{\text{tot}}=2.45$

E_{u_i} (MeV)	EA_i	a_i	aA_i	dru_i	ru_i	$\sin(\theta_{u_i})$
1.55842, 1.40699	1.00898	-0.624805, 0.263432	-0.649125	0.495338, 0.386903	0.877748, 0.308765	0.332405
ΔE_{u_i}	ΔEA_i	Δa_i	ΔaA_i	Δdru_i	Δru_i	$\Delta \sin(\theta_{u_i})$
1.38348, 0.700002	0.373778	.		0.188066*u, 0.900718u	12.2162n, 5.02502n	

$A_i(e)$

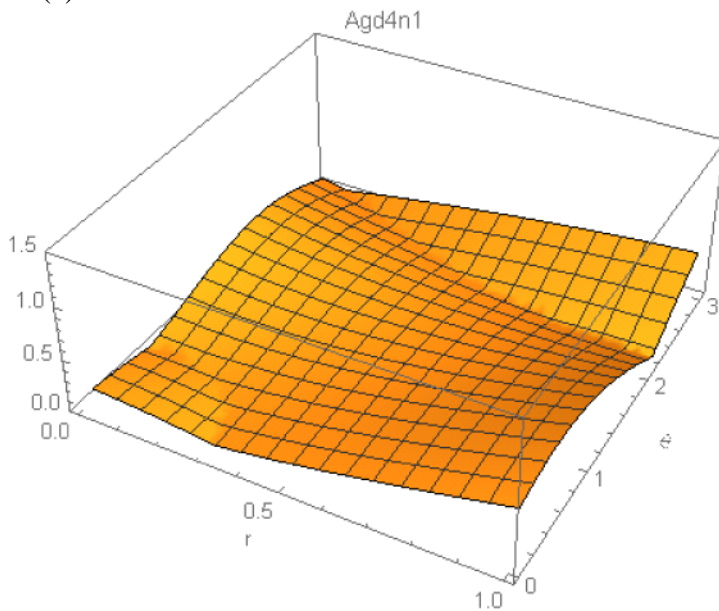

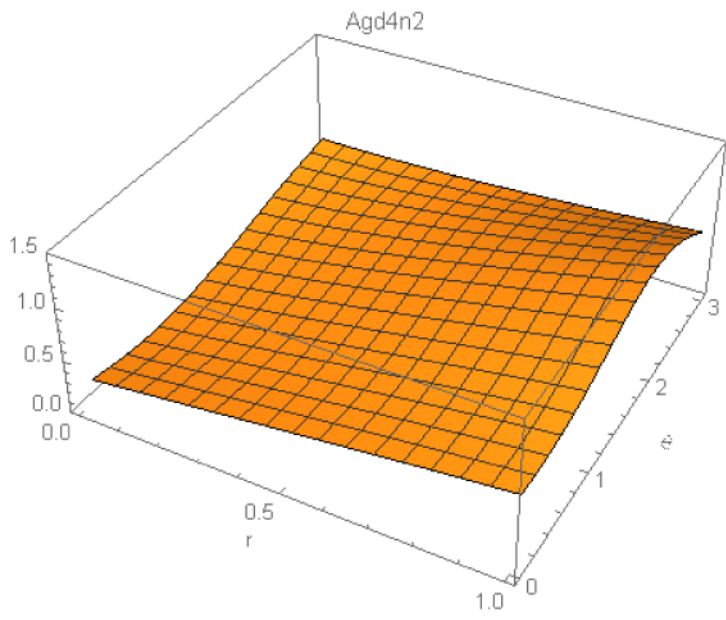

4.6 Weak massive bosons W_m , Z_0 , Z_L , H

Spin $S=1$ or $=0$, one free particle u_1 : linear combination of two or four preons

Preon configuration:

$$u = \left(0, 0, \begin{pmatrix} u_1 \\ 0 \end{pmatrix}, 0 \right) \text{ for weak exchange boson } W_m (= W^-)$$

$$u = \left(\begin{pmatrix} u_1 \\ 0 \end{pmatrix}, \begin{pmatrix} 0 \\ u_1 \end{pmatrix}, \begin{pmatrix} u_1 \\ 0 \end{pmatrix}, \begin{pmatrix} 0 \\ u_1 \end{pmatrix} \right) \text{ for weak exchange boson } Z_0$$

$$u = \left(\begin{pmatrix} u_1 \\ u_1 \end{pmatrix}, \begin{pmatrix} u_1 \\ u_1 \end{pmatrix}, 0, 0 \right) \text{ for (hypothetical) left-chiral Z-boson } Z_L$$

$$u = \left(\begin{pmatrix} u_1 \\ u_1 \end{pmatrix}, \begin{pmatrix} u_1 \\ u_1 \end{pmatrix}, \begin{pmatrix} u_1 \\ u_1 \end{pmatrix}, \begin{pmatrix} u_1 \\ u_1 \end{pmatrix} \right) \text{ for higgs } H$$

Boson configuration: only one flavor=3: all 15 bosons

The weak massive bosons are the Yukawa bosons of the hc -interaction, i.e. they mediate the residual force of the hc -interaction in the form of an exponentially decreasing potential. The L-projections of leptons and quarks interact via $SU(2)$ and (W,Z) bosons, the R-projections of leptons and quarks interact via $SU(1)$ and Z_0 . This happens because of the $SU(4)$ -symmetry breaking $SU(2)_{L,weak} \otimes SU(1)_{R,weak} \otimes SU(1)_{em}$ with their exchange bosons $\{W^\mu, Z^\mu\} \otimes \{Z^\mu\} \otimes \{A^\mu\}$. The higgs H generates mass for leptons and quarks, and also for the r-preon. The sterile nc -neutrinos interact $SU(2)$ -weakly with neutrinos via Z_L -boson.

	$m(W)$	$m(Z_0)$	$m(Z_L)$	$m(H)$
exp.	80.4GeV	91.2GeV		125.1GeV
calc.	89	97	91GeV	125

Energy distribution: preon(u_1, u_2) bosons A_i

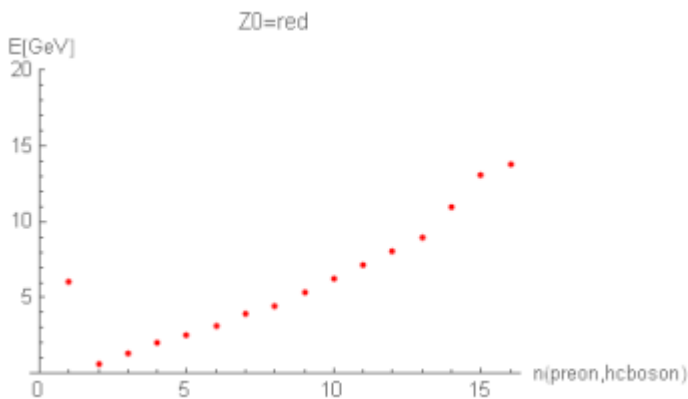
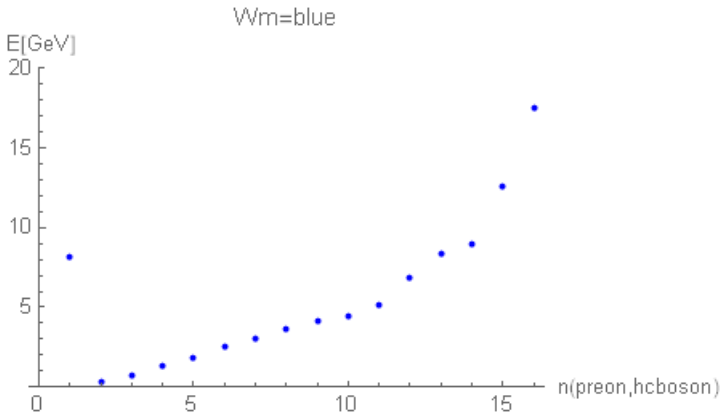

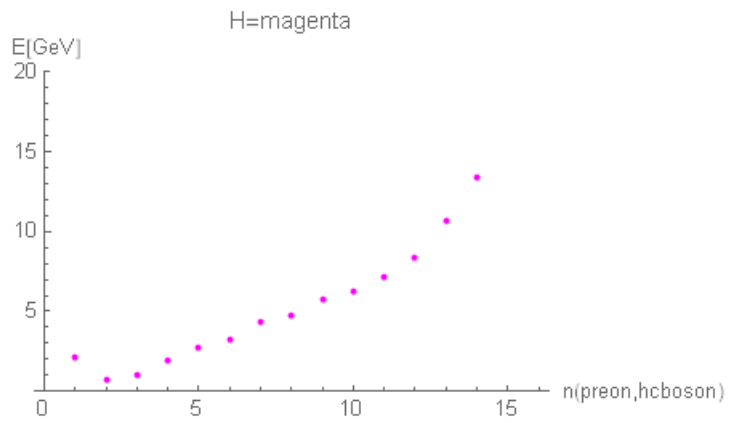
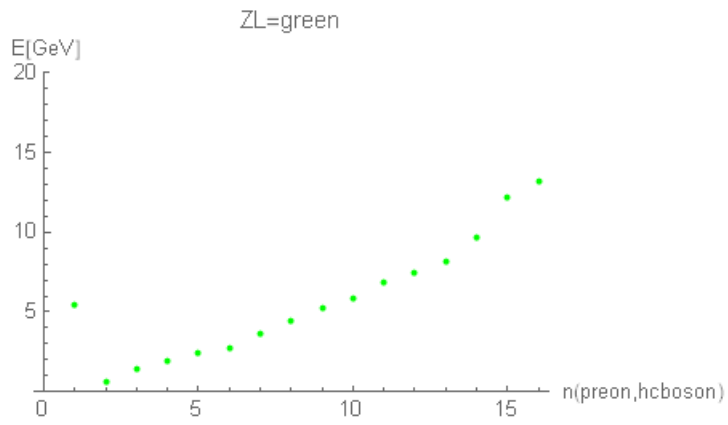

radii r_i , uncertainty dr_i and angle θ_h

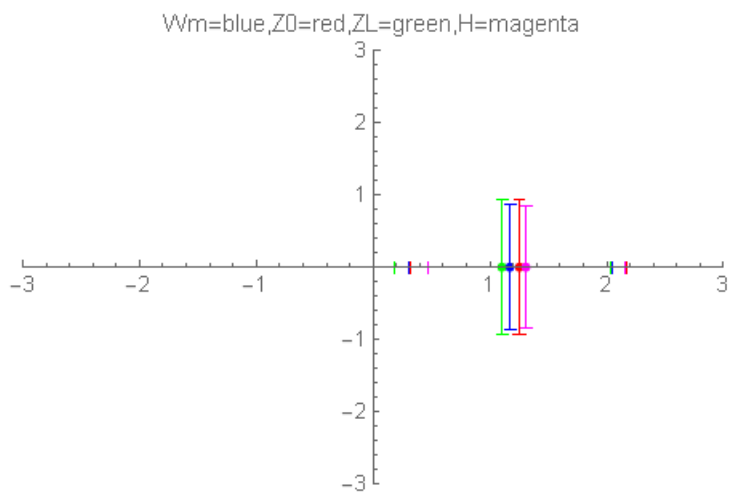

weak exchange boson W_m $W_m = (rR - rR^-) / \sqrt{2}$

right-handed weak exchange boson W^- , $S=1$

Preon configuration: $u = \left(0, 0, \begin{pmatrix} u1 \\ 0 \end{pmatrix}, 0 \right) \sqrt{2}$ $u1 = ((rR^-) - (rR^-)) / \sqrt{2}$

antiparticle $\bar{W}_m = W^+$ configuration $u = \left(0, \begin{pmatrix} 0 \\ u1 \end{pmatrix}, 0, 0 \right)$ $u1 = ((rL^+) - (rL^+)) / \sqrt{2}$

hypothetical chiral counterpart: left-handed W_m^* $u = \left(\begin{pmatrix} u1 \\ 0 \end{pmatrix}, 0, 0, 0 \right)$ $u1 = ((rL^-) - (rL^-)) / \sqrt{2}$

$m=80.4\text{GeV}$ $Q=-1$

$E_{\text{tot}}=89\text{GeV}$, $\Delta E_{\text{tot}}=26$

Eu_i (GeV)	EA_i	a_i	aA_i	dru_i	ru_i	$\sin(\theta_{u_i})$
8.20997	0.316331, 0.68873, 1.31464, 1.8232, 2.48807, 3.07844, 3.6289, 4.09488, 4.45176, 5.1892, 6.90223, 8.4103, 8.99396, 12.5852, 17.5486	-0.294831	0.0551789, - 0.362417, -0.131927, 0.176835, -0.207657, 0.0407577, 0.0430164, 0.042737, -0.161912, 0.0364995, 0.056686, 0.0374209, 0.10742, - 0.0329776, 0.0255881	2.6109	1.17267	0
ΔEu_i	ΔEA_i	Δa_i	ΔaA_i	Δdru_i	Δru_i	$\Delta \sin(\theta_{u_i})$
10.1252	0.188613, 0.334553, 0.70658, 0.801391, 0.626902, 0.823354, 0.876158, 1.0928, 0.869573, 0.559216, 2.0035, 2.08725, 1.95618, 1.91668, 1.3873			0.81355	0.654887	

$A_i(e)$

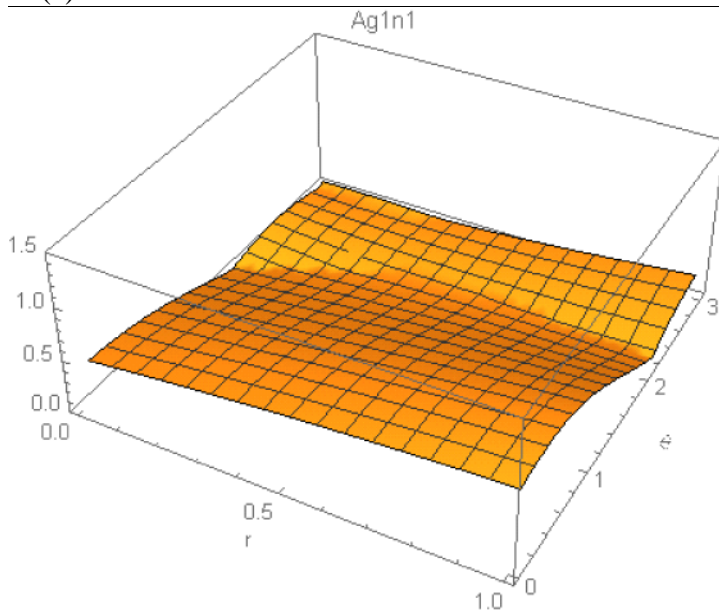

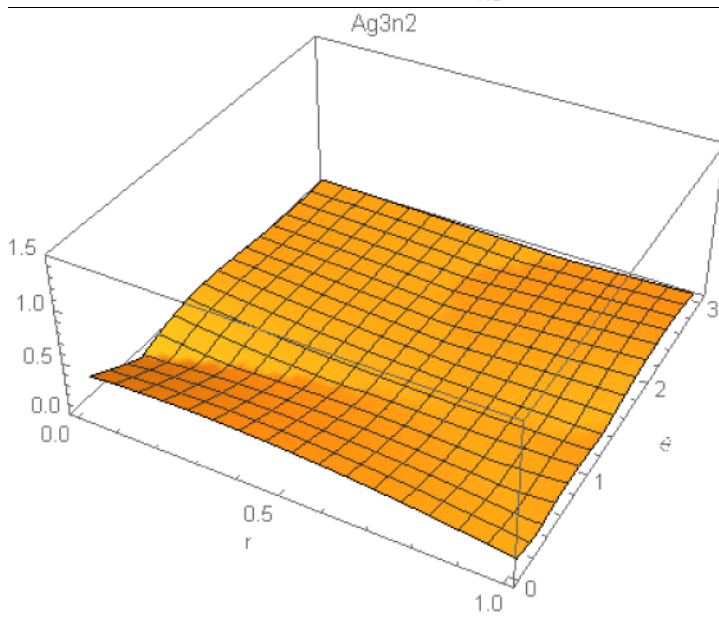
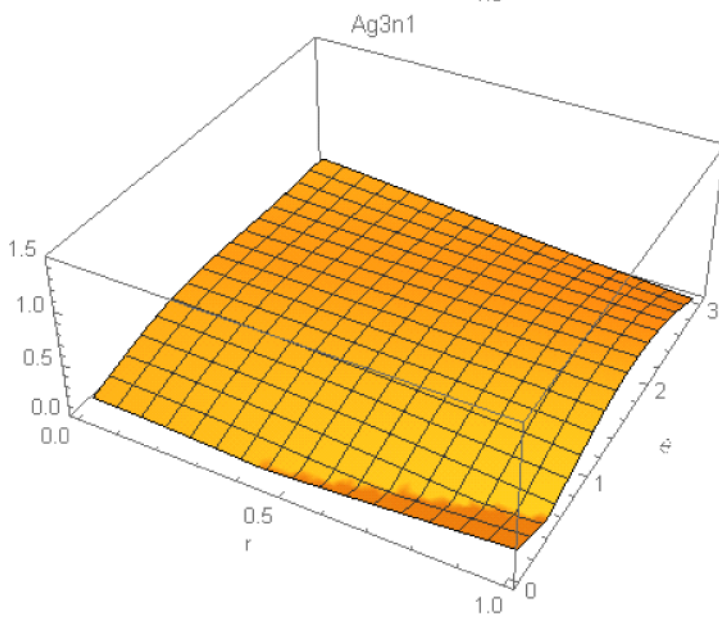
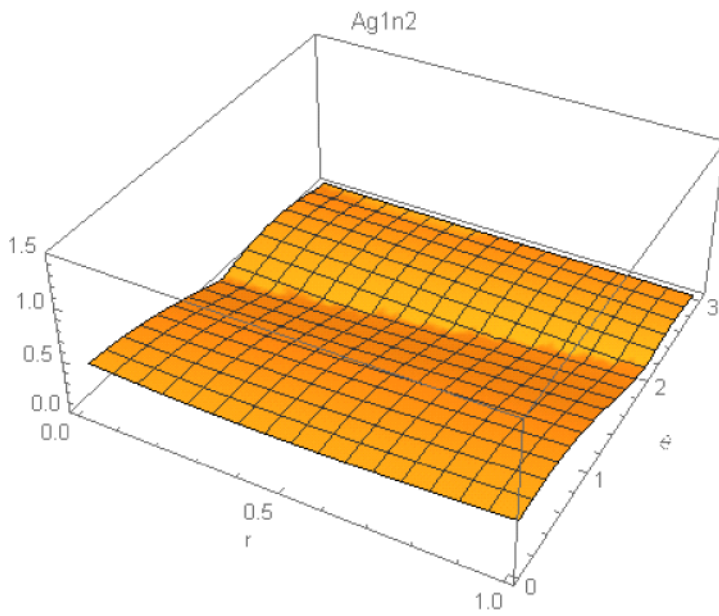

weak exchange boson Z_0 $Z_0 = (r_{L-} + r_{R-} + r_{L+} + r_{R+})/2$
 neutral weak exchange boson Z , $S=1$

Preon configuration: $u = \left(\begin{pmatrix} u1 \\ 0 \end{pmatrix}, \begin{pmatrix} 0 \\ Cu1 \end{pmatrix}, \begin{pmatrix} u1 \\ 0 \end{pmatrix}, \begin{pmatrix} 0 \\ Cu1 \end{pmatrix} \right) / \sqrt{2}$ $u1 = ((rL-) + (rR-)) / \sqrt{2}$

$Cu1 = ((rL+) + (rR+)) / \sqrt{2}$

antiparticle $\bar{Z}_0 = Z_0$

$m=91.2\text{GeV}$ $Q=0$

$E_{\text{tot}}=97\text{GeV}$, $\Delta E_{\text{tot}}=30$

E_{u_i} (GeV)	EA_i	a_i	aA_i	dru_i	ru_i	$\sin(\theta_{u_i})$
6.04329	0.601016, 1.31219, 2.03588, 2.57426, 3.10174, 3.96319, 4.46575, 5.33916, 6.22519, 7.11513, 8.06896, 8.94095, 10.9788, 13.0787, 13.777	-0.294831	0.0551789, - 0.362417, -0.131927, 0.176835, -0.207657, 0.0407577, 0.0430164, 0.042737, -0.161912, 0.0364995, 0.056686, 0.0374209, 0.10742, - 0.0329776, 0.0255881	2.6109	1.17267	0
ΔE_{u_i}	ΔEA_i	Δa_i	ΔaA_i	Δdru_i	Δru_i	$\Delta \sin(\theta_{u_i})$
4.21067	0.42354, 0.63418, 0.928717, 0.946956, 1.1372, 1.30358, 1.4114, 1.20844, 1.02434, 1.25918, 1.27045, 0.93689, 2.58041, 5.49091, 5.57065			0.81355	0.654887	

$A_i(e)$

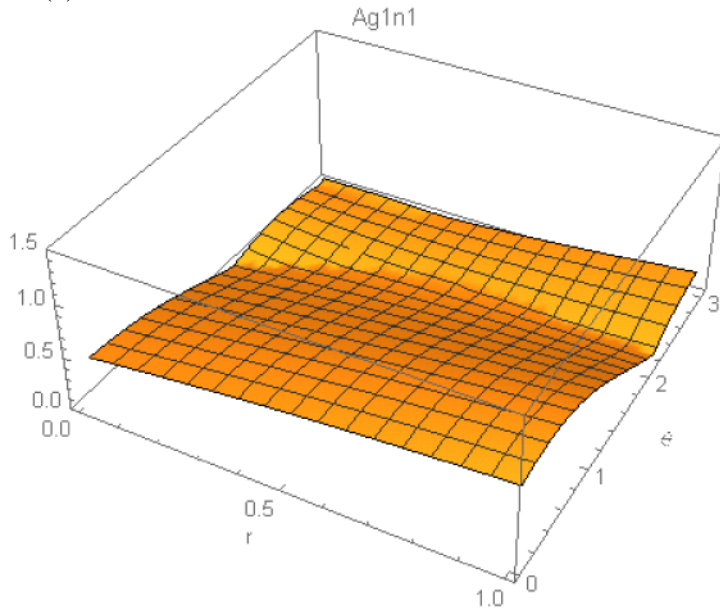

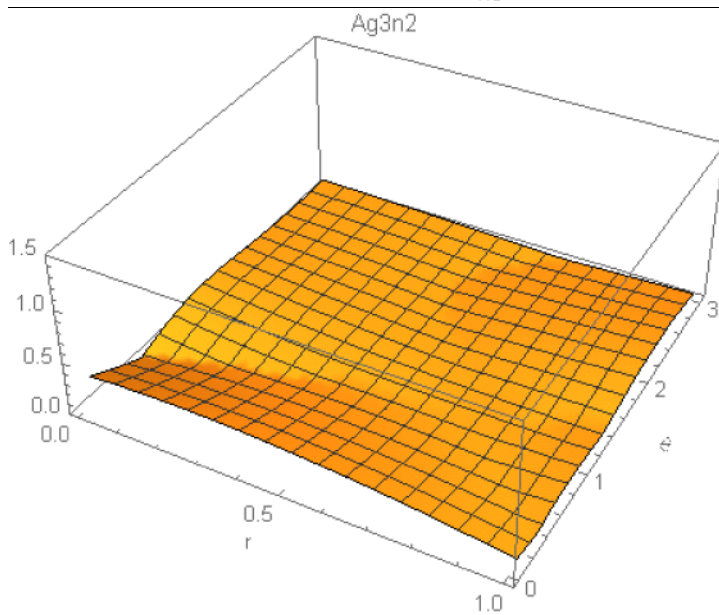
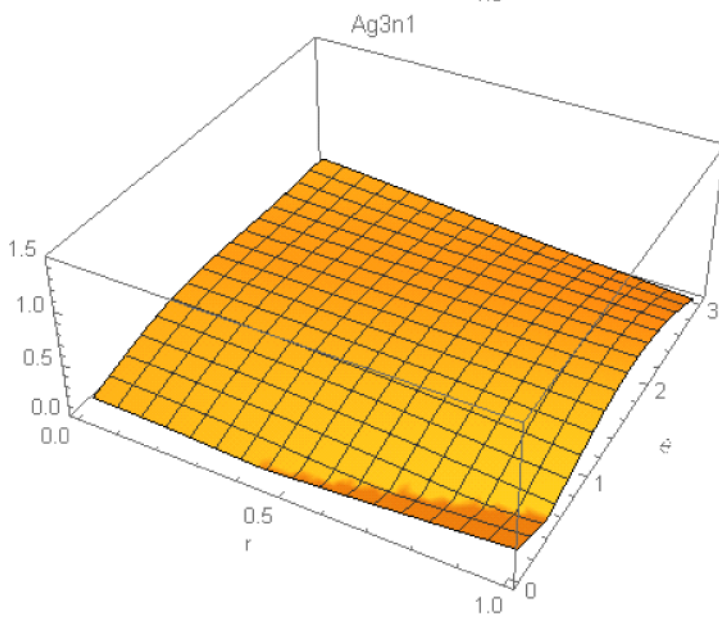
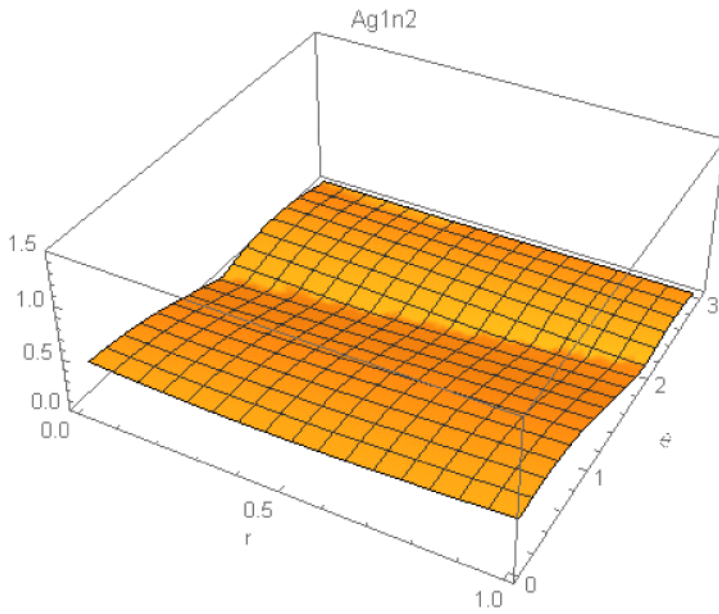

weak chiral boson ZL $ZL = (rL^- + rL^+)/\sqrt{2}$
 neutral left-handed weak exchange boson ZL, S=1

Preon configuration: $u = \left(\begin{pmatrix} u1 \\ u1 \end{pmatrix}, \begin{pmatrix} u1 \\ u1 \end{pmatrix}, 0, 0 \right) / \sqrt{2}$ $u1 = ((rL^-) + (rL^+)) / \sqrt{2}$

antiparticle right-handed $\bar{Z}_L \bar{u} = \left(0, 0, \begin{pmatrix} u1 \\ u1 \end{pmatrix}, \begin{pmatrix} u1 \\ u1 \end{pmatrix} \right) / \sqrt{2}$ $u1 = ((rR -) + (rR +)) / \sqrt{2}$

$m=91.2\text{GeV}$ $Q=0$

$E_{\text{tot}}=97\text{GeV}$, $\Delta E_{\text{tot}}=30$

Eu_i (GeV)	EA_i	a_i	aA_i	dru_i	ru_i	$\sin(\theta_{u_i})$
5.41018	0.635455, 1.45762, 1.94515, 2.40743, 2.76174, 3.62666, 4.40736, 5.29138, 5.81184, 6.81575, 7.50969, 8.17982, 9.70438, 12.2009, 13.1613	-0.28215	-0.0634903, - 0.0177523, 0.0393775, - 0.0141295, 0.238785, 0.06813, - 0.0828258, - 0.0566217, 0.0147406, - 0.0549006, - 0.129071, -0.193776, 0.0224101, - 0.196448, -0.0777609	4.20897	1.10542	0
ΔEu_i	ΔEA_i	Δa_i	ΔaA_i	Δdru_i	Δru_i	$\Delta \sin(\theta_{u_i})$
3.61896	0.361193, 0.294054, 0.542048, 0.685343, 0.734258, 1.14914, 1.37386, 1.86499, 2.16942, 2.02409, 1.91406, 1.31147, 1.01549, 4.24462, 4.70292			0.896122	0.764349	

$Ai(e)$

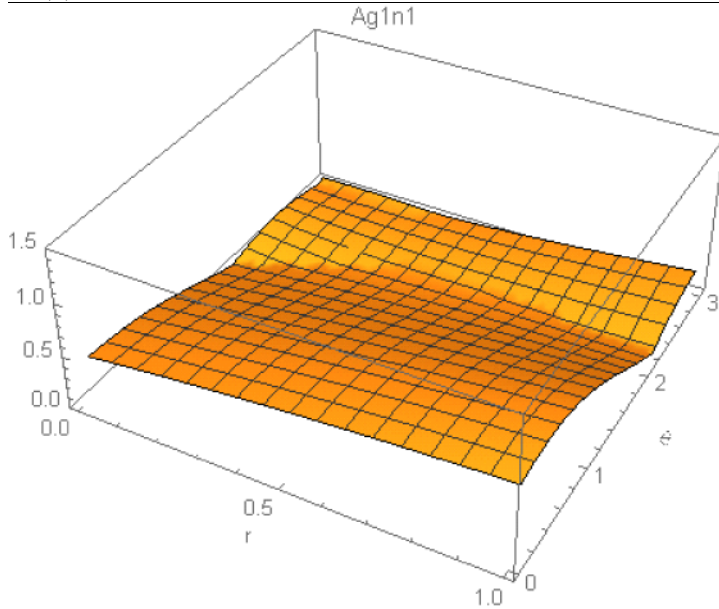

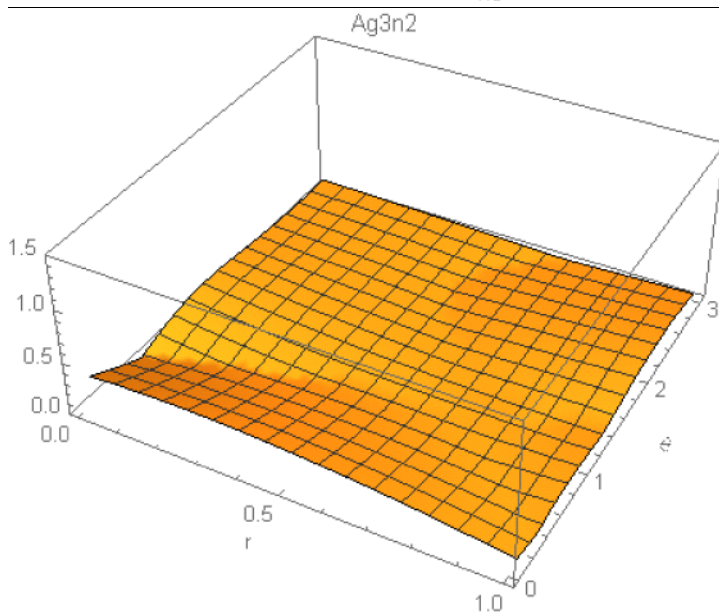
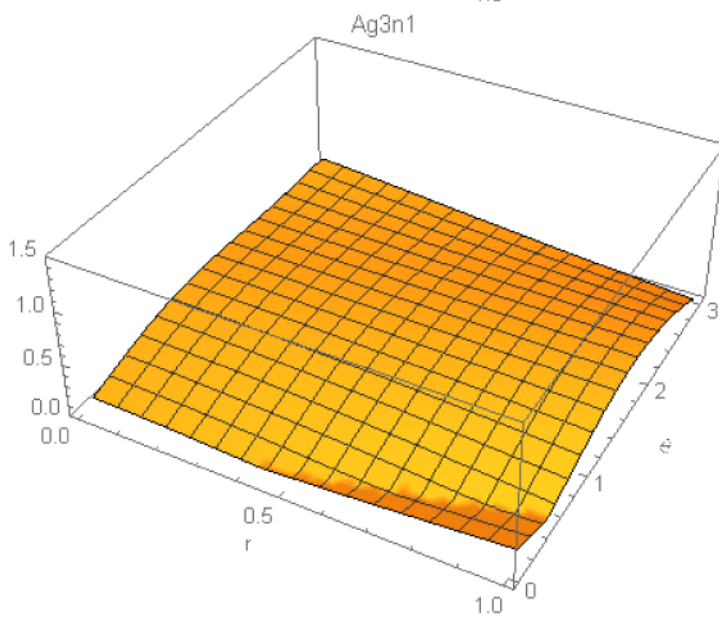
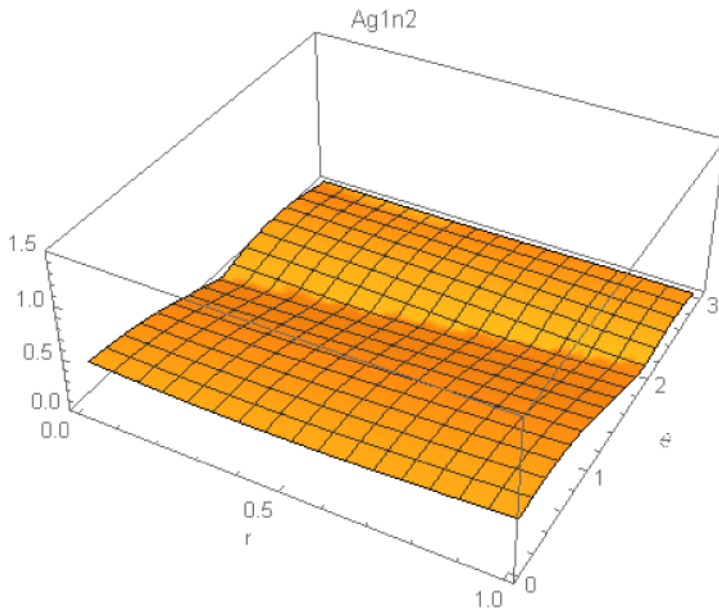

higgs boson H $H=(rL^- + rL^+ + rR^- + rR^+)/2$
neutral mass-generating scalar boson H, S=0

Preon configuration: $u = \left(\begin{pmatrix} u1 \\ u1 \end{pmatrix}, \begin{pmatrix} u1 \\ u1 \end{pmatrix}, \begin{pmatrix} u1 \\ u1 \end{pmatrix}, \begin{pmatrix} u1 \\ u1 \end{pmatrix} \right) / 2$ $u1 = ((rL^-) + (rL^+) + (rR^-) + (rR^+)) / 2$

antiparticle: itself $\bar{H} = H$

m=125.1GeV Q=0

 $E_{\text{tot}}=125\text{GeV}$, $\Delta E_{\text{tot}}=44$

E_{u_i} (GeV)	EA_i	a_i	aA_i	dru_i	ru_i	$\sin(\theta_{u_i})$
2.12256	0.687867, 1.06114, 1.89688, 2.72051, 3.1891, 4.31443, 4.70774, 5.75923, 6.2929, 7.21059, 8.37697, 10.7365, 13.3999, 22.669, 30.1505	0.242174	0.203185, 0.209845, 0.0797134, 0.249824, 0.098651, - 0.0453497, 0.111729, 0.153663, 0.156595, 0.261526, - 0.0971455, - 0.0358294, 0.0815874, 0.0875567, - 0.0353346	2.65352	1.31158	0
ΔE_{u_i}	ΔEA_i	Δa_i	ΔaA_i	Δdru_i	Δru_i	$\Delta \sin(\theta_{u_i})$
0.963583	0.596931, 0.840909, 0.733675, 1.05086, 1.1562, 1.75893, 1.94705, 1.83638, 2.30989, 2.54619, 2.87418, 4.01778, 2.02776, 10.3933, 8.6628			0.164707	0.599096	

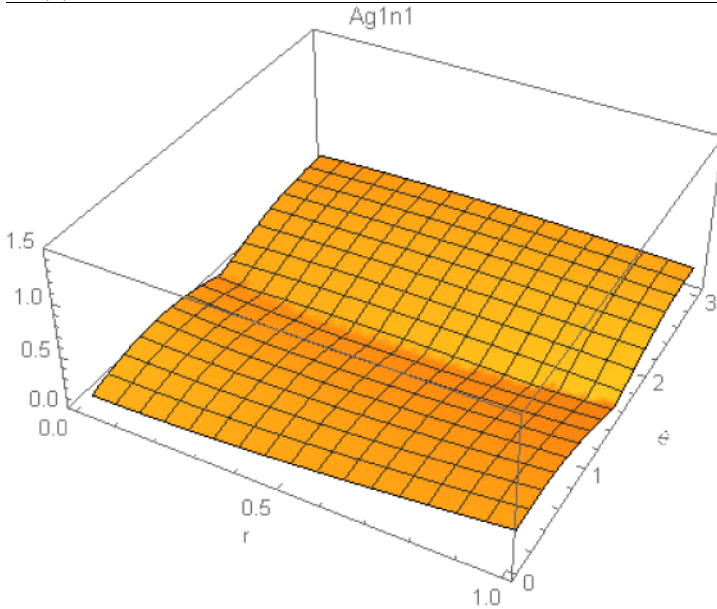
 $A_i(e)$ 

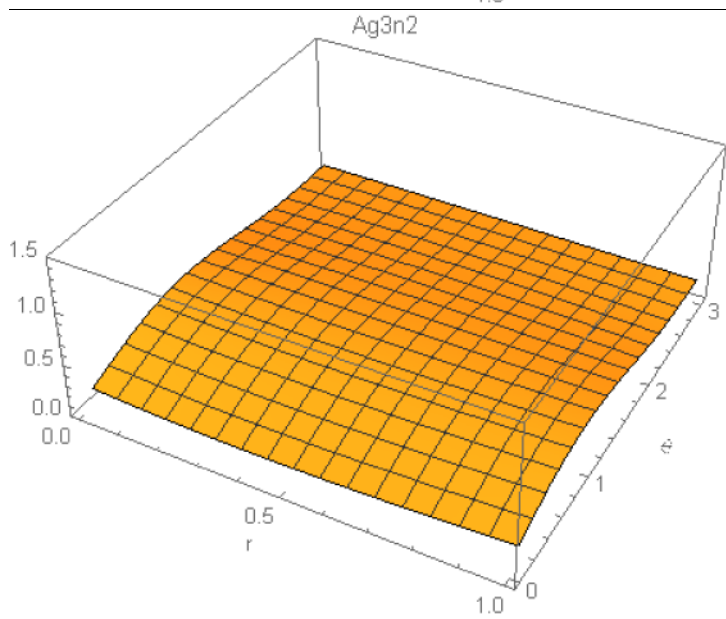
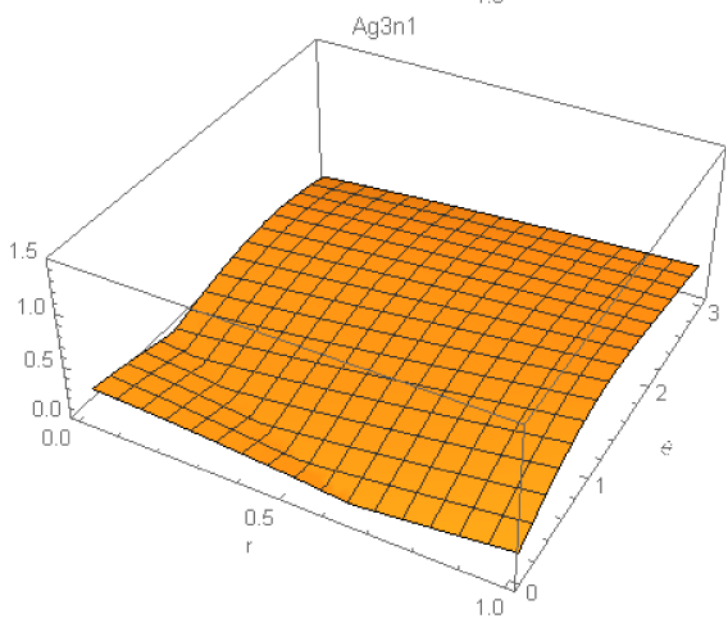
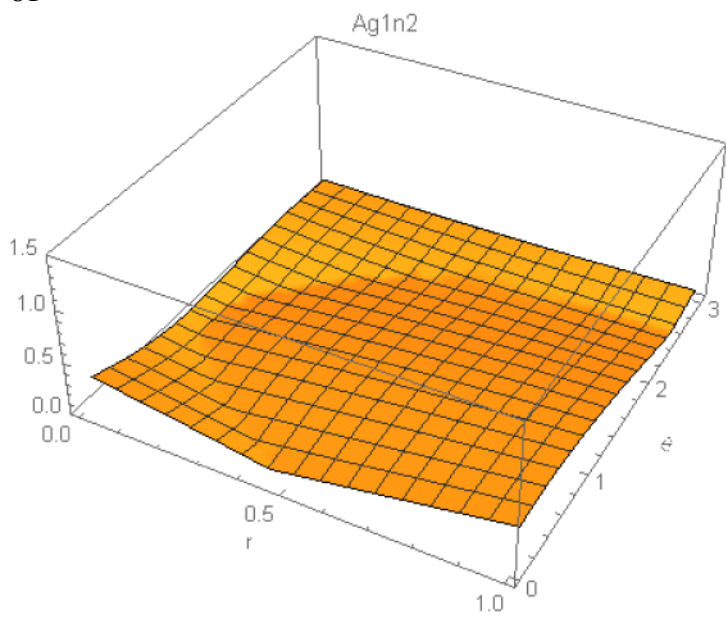

4.7 Strong neutrinos (hypothetical) q_{ue} q_{um} q_{ut}

Spin $S=1/2$, two free preons, occupying fixed positions in the hc-tetra-spinor

$$\text{Preon configuration: } u = \left(\begin{pmatrix} qL^- \\ 0 \end{pmatrix}, \begin{pmatrix} 0 \\ qL^+ \end{pmatrix}, 0, 0 \right)$$

Boson configuration: flavor=1: ($A_{12} = \lambda_1$), flavor=2: ($A_{12} = \lambda_1, \bar{A}_{12} = \lambda_2, A_{34} = \lambda_{13}, \bar{A}_{34} = \lambda_{14}$)

flavor=3: all 15 bosons

The strong neutrinos are neutral spherically symmetric particles with composition (q^+, q^-) and have masses starting with 23MeV. They can hc-interact via Z_q strong bosons, but only for high energies ($E \sim m(Z_q) = 644 \text{ GeV}$), they are colorless and do not interact strongly. They are candidates for dark matter, as they are in the appropriate mass range (around 100MeV, according to the new SIMP-scheme for dark matter), and they interact with themselves at high energies, as was observed for dark matter in certain galaxies.

	$m(q_{ue})$	$m(q_{um})$	$m(q_{ut})$	
exp.				
calc.	23.2MeV	205MeV	2.4GeV	

Energy distribution: preon(u_1, u_2) bosons A_i

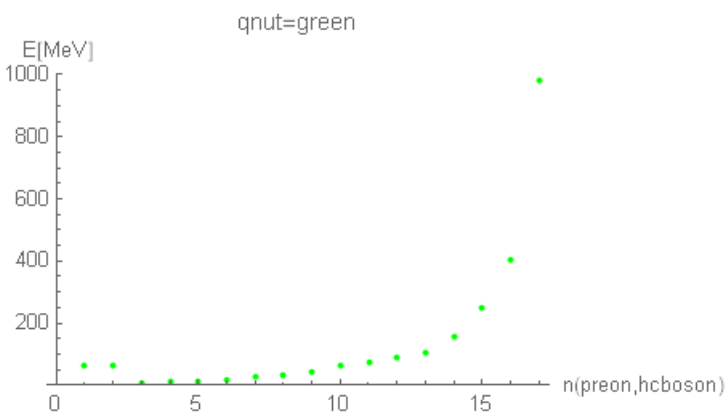
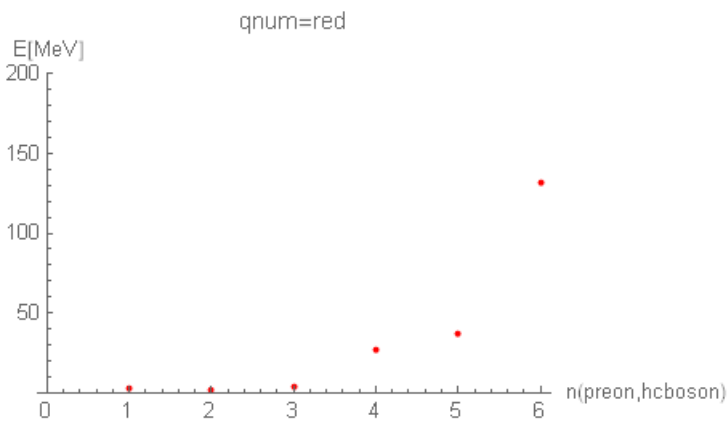
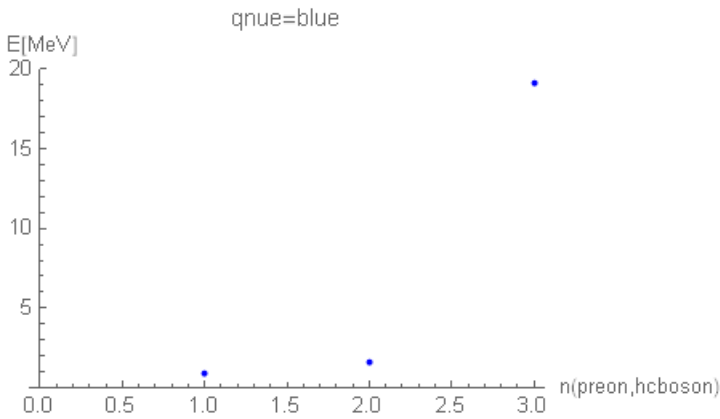

radii r_i , uncertainty dr_i and angle θ_i

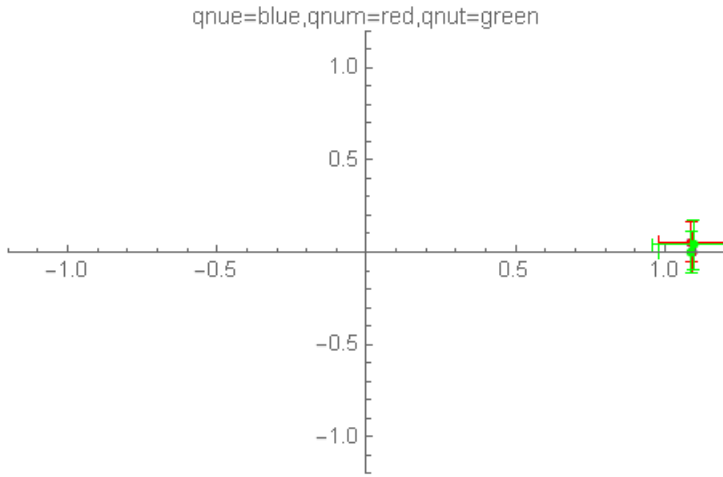

qe-neutrino $q\nu_e=(qL-, qL+)$

Preon configuration: left-handed q-neutrino $u = \left(\begin{pmatrix} 0 \\ qL- \end{pmatrix}, \begin{pmatrix} qL+ \\ 0 \end{pmatrix}, 0, 0 \right)$

Antiparticle right-handed anti-q-neutrino $\bar{u} = \left(0, 0, \begin{pmatrix} 0 \\ qR- \end{pmatrix}, \begin{pmatrix} qR+ \\ 0 \end{pmatrix} \right)$

$m < 0.12\text{eV}$ $Q=0$

$E_{\text{tot}}=23\text{MeV}$, $\Delta E_{\text{tot}}=13.5$

E_{u_i} (MeV)	EA_i	a_i	aA_i	dru_i	ru_i	$\sin(\theta_{u_i})$
0.916713, 1.57978	19.1558	0.0499768, 0.0499806	0.0499709	0.218706, 0.217761	1.08906, 1.08886	0.0495826
ΔE_{u_i}	ΔEA_i	Δa_i	ΔaA_i	Δdru_i	Δru_i	$\Delta \sin(\theta_{u_i})$
2.59139, 4.46489	6.42353			0.00260392, 0.0000482519	0.000467796, 0.0000799548	

$A_i(e)$

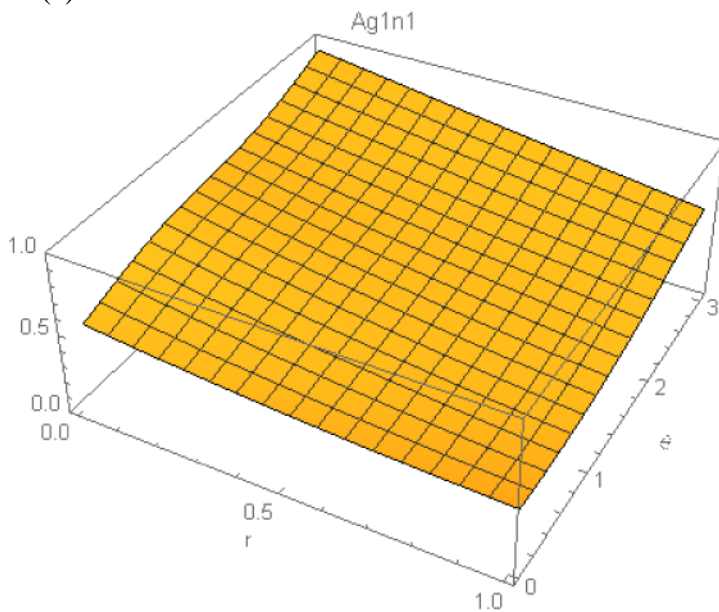

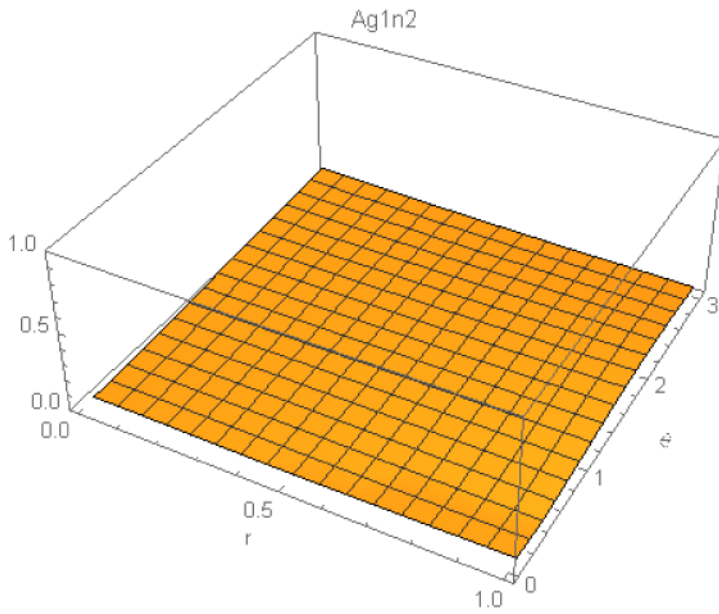

qm-neutrino qnum=(qL-, qL+)
 $m < 0.12\text{eV}$ $Q=0$

$E_{\text{tot}}=205\text{MeV}$, $\Delta E_{\text{tot}}=93$

E_{u_i} (MeV)	EA_i	a_i	aA_i	dru_i	ru_i	$\sin(\theta_{u_i})$
2.31669, 2.10932	3.2139, 27.2516, 36.8587, 131.637	0.049974, 0.0499723	0.0499795, 0.0499777, 0.0499851, 0.0499601	0.218962, 0.217768	1.08916, 1.08885	0.0494963
ΔE_{u_i}	ΔEA_i	Δa_i	ΔaA_i	Δdru_i	Δru_i	$\Delta \sin(\theta_{u_i})$
4.18504, 4.14824	4.03572, 16.4507, 20.6083, 43.8355			0.00272481, 0.0000218384	0.000633244, 0.0000799629	

$A_i(e)$

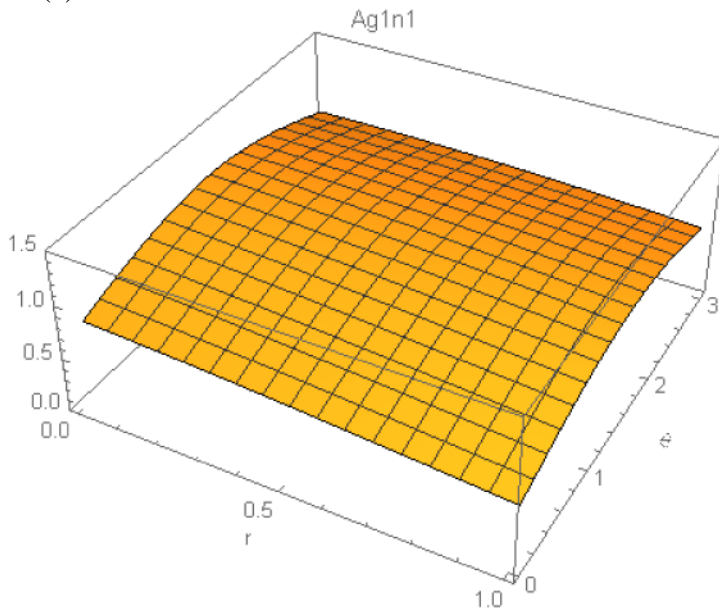

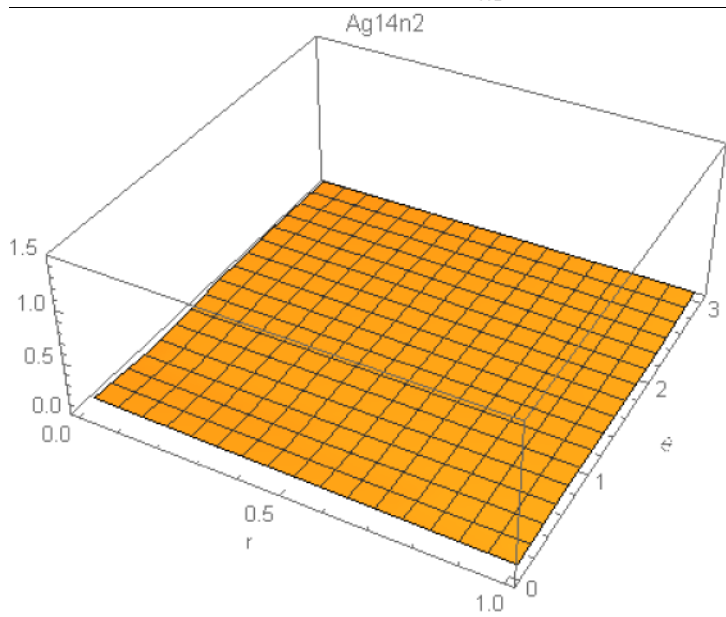
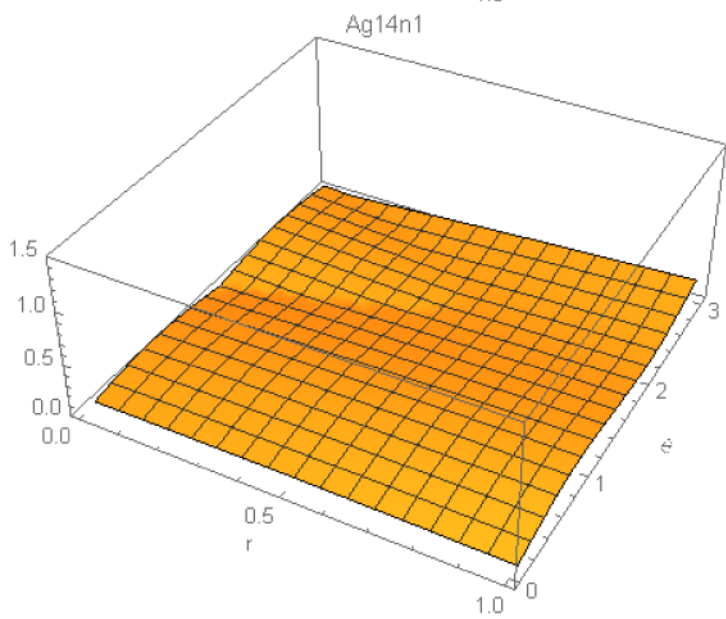
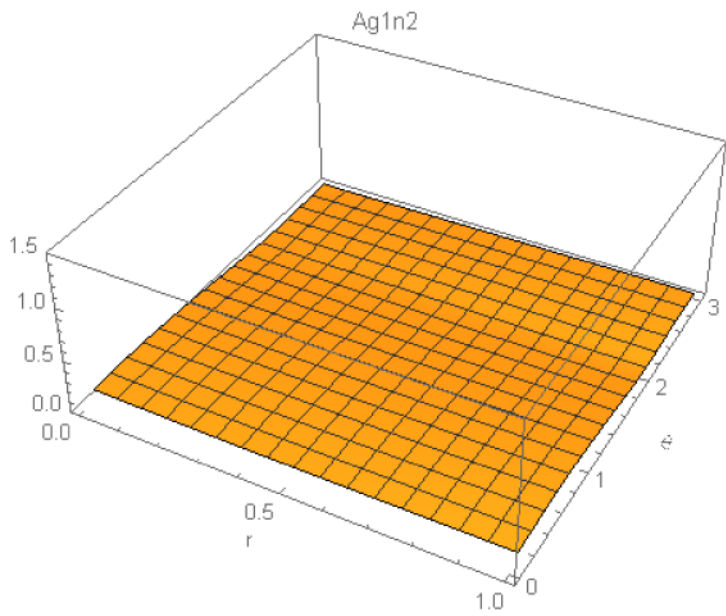

qt-neutrino $q_{\text{nut}}=(q_{L^-}, q_{L^+})$
 $m < 0.12\text{eV}$ $Q=0$

$E_{\text{tot}}=2.40\text{GeV}$, $\Delta E_{\text{tot}}=1.48$

E_{u_i} (MeV)	EA_i	a_i	aA_i	dru_i	ru_i	$\sin(\theta_{u_i})$
62.9487, 61.5266	6.27604, 9.78005, 14.0006, 17.2518, 26.4587, 32.2502, 44.8203, 62.4957, 71.6555, 88.2316, 105.198, 154.92, 251.417, 406.445, 980.267	0.0498284, 0.0496889	0.0499212, 0.0499565, 0.0499232, 0.0499843, 0.0500119, 0.0499806, 0.0499806, 0.0500343, 0.0499183, 0.0495368, 0.0499496, 0.0501089, 0.0500246, 0.0500326, 0.0499384	0.250849, 0.21778	1.09488, 1.08809	0.0362321
ΔE_{u_i}	ΔEA_i	Δa_i	ΔaA_i	Δdru_i	Δru_i	$\Delta \sin(\theta_{u_i})$
80.6687, 82.6461	7.47768, 7.63514, 11.768, 12.944, 23.1368, 23.3382, 31.1644, 43.8489, 52.4387, 59.1117, 70.624, 56.9479, 109.749, 231.239, 579.301			0.0345065, 0.000493132	0.00516914, 0.000793051	

$A_i(e)$

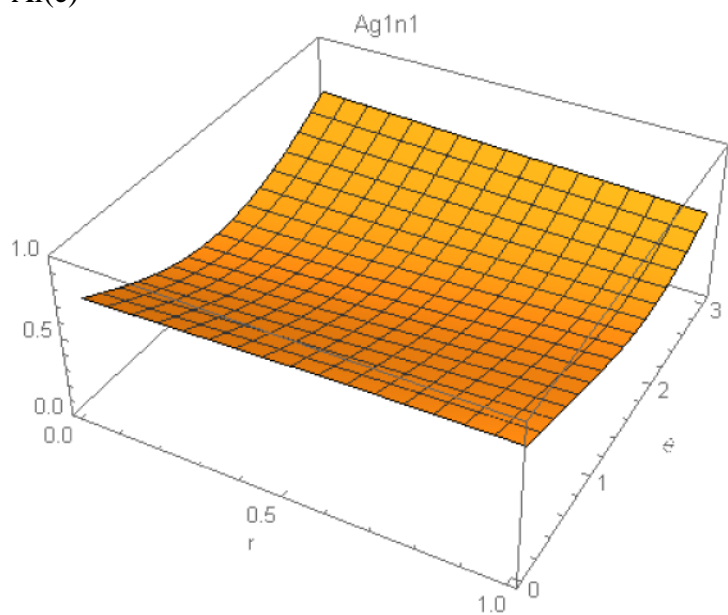

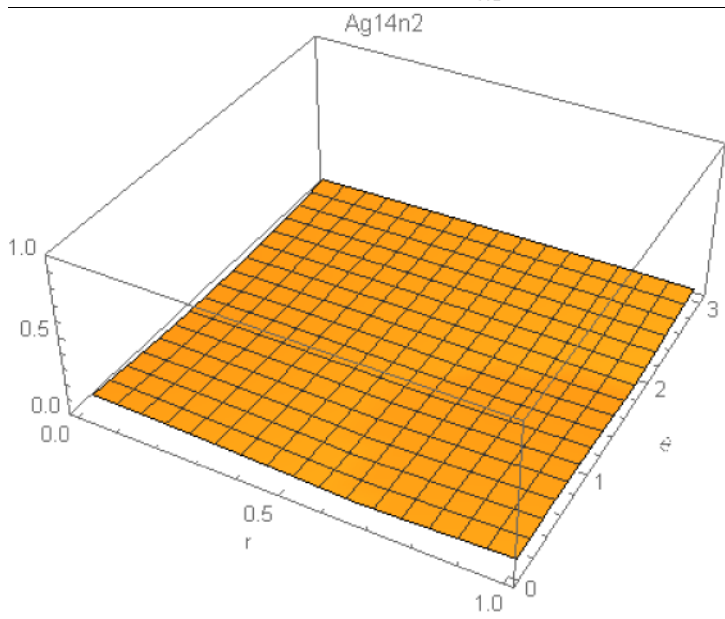
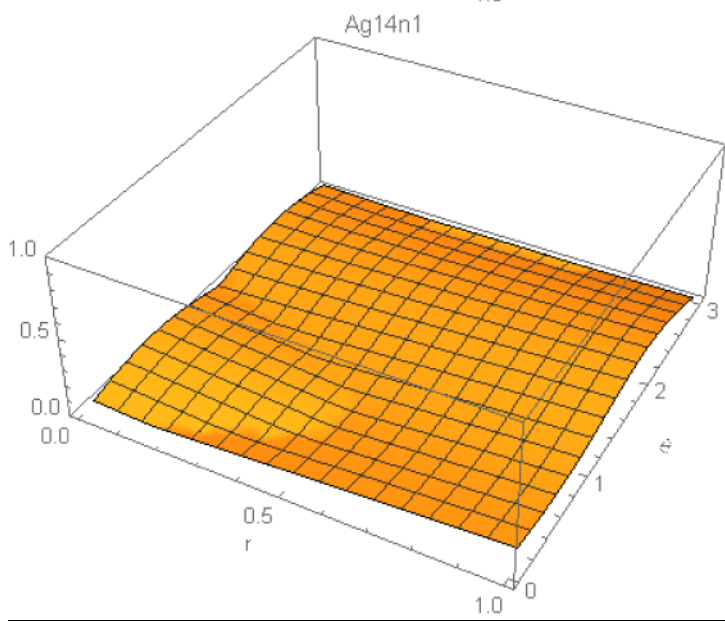
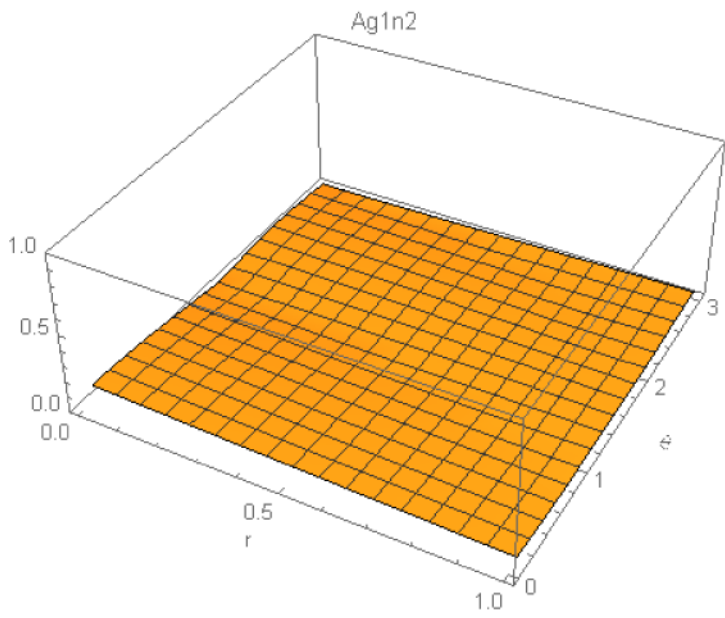

4.8 Strong bosons (hypothetical) Zq Hq

Spin S=1 or =0, one free particle u1: linear combination of two or four preons

Preon configuration:

$$u = \left(\begin{pmatrix} u1 \\ 0 \end{pmatrix}, \begin{pmatrix} 0 \\ u1 \end{pmatrix}, \begin{pmatrix} u1 \\ 0 \end{pmatrix}, \begin{pmatrix} 0 \\ u1 \end{pmatrix} \right) \text{ for strong exchange boson } Zq$$

$$u = \left(\begin{pmatrix} u1 \\ u1 \end{pmatrix}, \begin{pmatrix} u1 \\ u1 \end{pmatrix}, \begin{pmatrix} u1 \\ u1 \end{pmatrix}, \begin{pmatrix} u1 \\ u1 \end{pmatrix} \right) \text{ for q-higgs } Hq$$

Boson configuration; all hc-bosons active flavor=3

The strong boson Zq is the Yukawa-boson for the hc-interaction of q-neutrinos. The strong higgs Hq generates masses for the q-neutrinos and for the q-preons .

	m(Zq)	m(Hq)		
exp.				
calc.	644GeV	637GeV		

Energy distribution: preon(u1,u2) bosons Ai

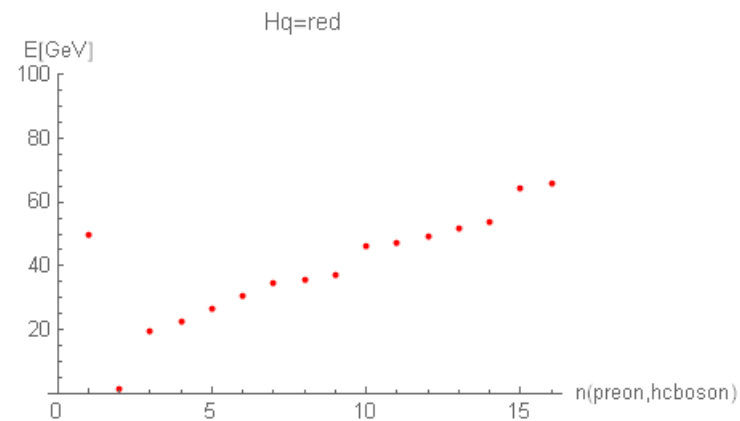
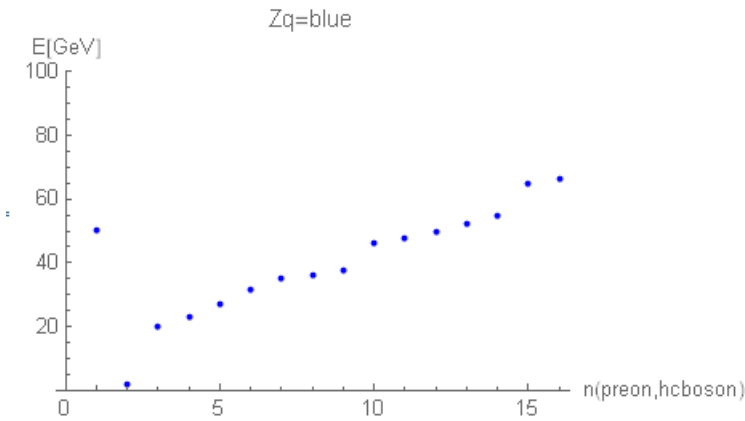

radii r_i , uncertainty dr_i and angle θ

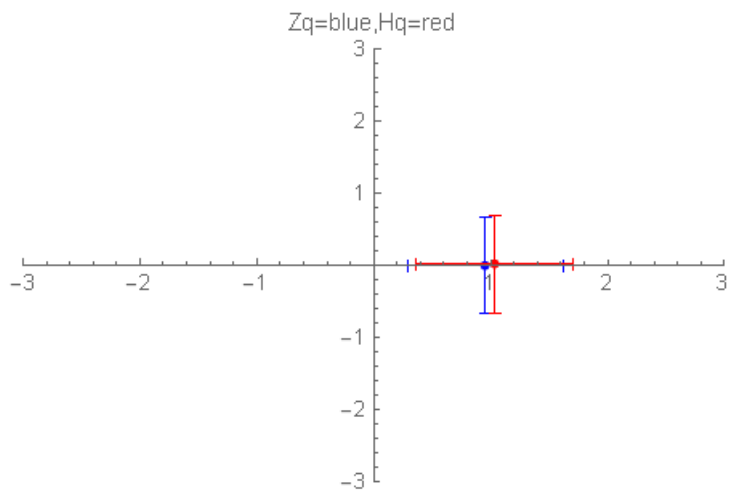

strong exchange boson Z_q $Z_q=(qL^- + qR^- + qL^+ + qR^+)/2$

neutral strong exchange boson Z_q , $S=1$

Preon configuration: $u = \left(\begin{pmatrix} u1 \\ 0 \end{pmatrix}, \begin{pmatrix} 0 \\ Cu1 \end{pmatrix}, \begin{pmatrix} u1 \\ 0 \end{pmatrix}, \begin{pmatrix} 0 \\ Cu1 \end{pmatrix} \right) / \sqrt{2}$ $Cu1 = ((qL^-) + (qR^-)) / \sqrt{2}$

$u1 = ((qL^+) + (qR^+)) / \sqrt{2}$

antiparticle itself $\bar{Z}_q = Z_q$

$m=GeV$ $Q=0$

$E_{tot}=644GeV$, $\Delta E_{tot}=26$

E_{u_i} (GeV)	EA_i	a_i	aA_i	dru_i	ru_i	$\sin(\theta_{u_i})$
50.1031	1.75913, 20.0747, 22.9369, 27.0332, 31.3827, 35.2293, 36.2947, 37.6842, 46.383, 47.6871, 49.7122, 52.4871, 54.6914, 64.7501, 66.1951	0.242169	0.231796, -0.207073, 0.131049, -0.253369, 0.15414, 0.199737, 0.161236, 0.266433, -0.269026, 0.131364, 0.155354, 0.203886, 0.235986, 0.226728, 0.056805	2.90034	0.953641	0
ΔE_{u_i}	ΔEA_i	Δa_i	ΔaA_i	Δdru_i	Δru_i	$\Delta \sin(\theta_{u_i})$
0.501804	1.40428, 2.2256, 2.1451, 4.24188, 3.13026, 1.44886, 1.19789, 1.53643, 1.07209, 0.567924, 0.839207, 1.81534, 1.76197, 1.38173, 1.23064			0.0598953	0.243724	

$A_i(e)$

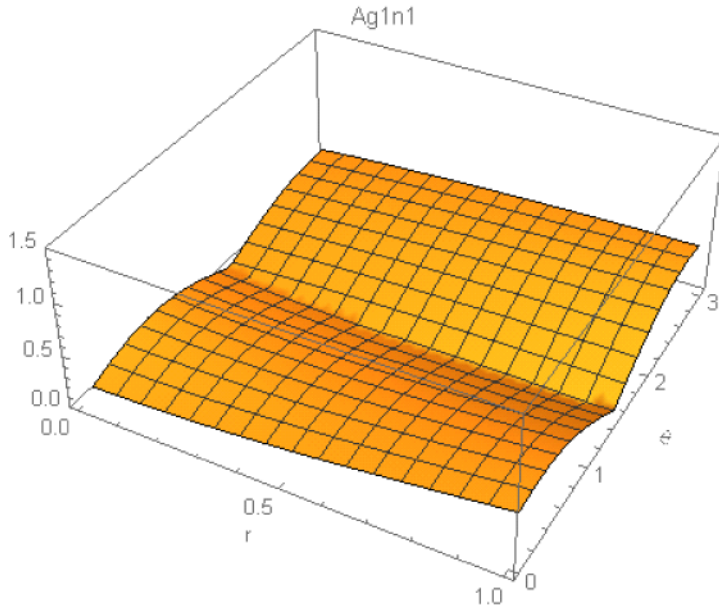

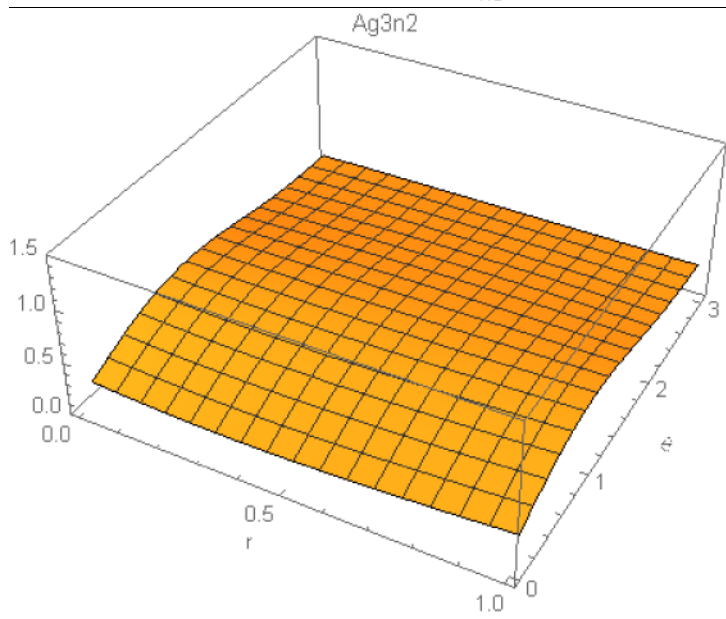
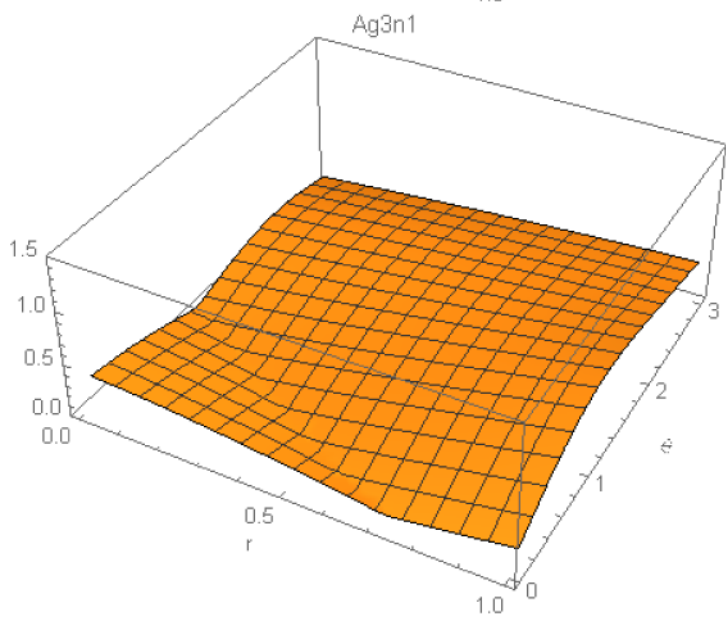
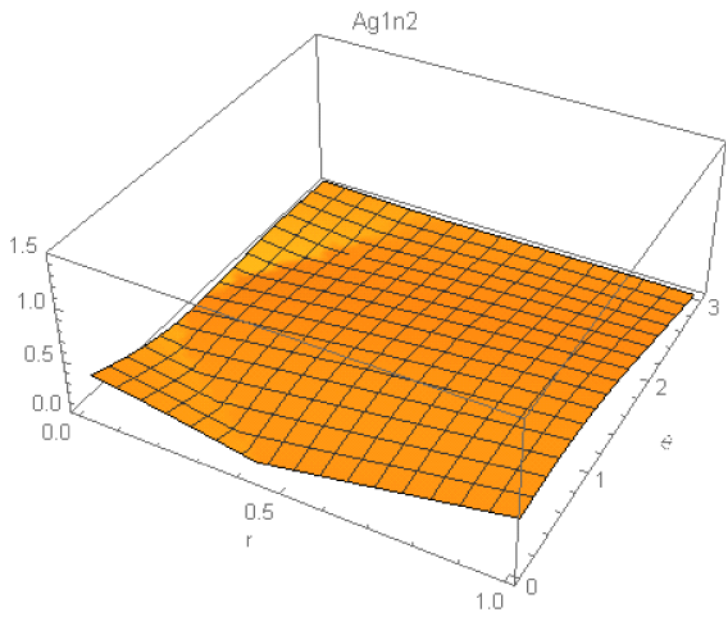

strong higgs boson (hypothetical) H_q , $H_q=(qL^- + qL^+ + qR^- + qR^+)/2$

neutral mass-generating scalar boson H_q , $S=0$

Preon configuration: $u = \left(\begin{pmatrix} u1 \\ u1 \end{pmatrix}, \begin{pmatrix} u1 \\ u1 \end{pmatrix}, \begin{pmatrix} u1 \\ u1 \end{pmatrix}, \begin{pmatrix} u1 \\ u1 \end{pmatrix} \right) / 2$ $u1 = ((qL^-) + (qL^+) + (qR^-) + (qR^+)) / 2$

antiparticle: itself $\bar{H}_q = H_q$

$m=GeV$ $Q=0$

$E_{tot}=637GeV$, $\Delta E_{tot}=17$

Eu_i (GeV)	EA_i	a_i	aA_i	dru_i	ru_i	$\sin(\theta_{u_i})$
49.8974	66.1951}, {49.8974, 1.49444, 19.6994, 22.5362, 26.3583, 30.6179, 34.632, 35.8439, 37.1908, 46.1384, 47.4992, 49.4017, 51.9202, 54.0522, 64.3069, 65.783	0.242181	0.207549, -0.304129, 0.131516, -0.254004, 0.253908, 0.206301, 0.161453, 0.252253, -0.272395, 0.131765, 0.163953, 0.204921, 0.242696, 0.221589, 0.0809426	2.97112	1.03787	0
ΔEu_i	ΔEA_i	Δa_i	ΔaA_i	Δdru_i	Δru_i	$\Delta \sin(\theta_{u_i})$
0.0563816	0.958115, 1.67958, 1.65813, 3.0444, 1.70715, 0.281763, 0.812278, 0.540787, 0.748368, 0.324524, 0.292485, 2.08406, 0.685153, 0.707936, 1.09514			0.071377	0.253642	

$A_i(e)$

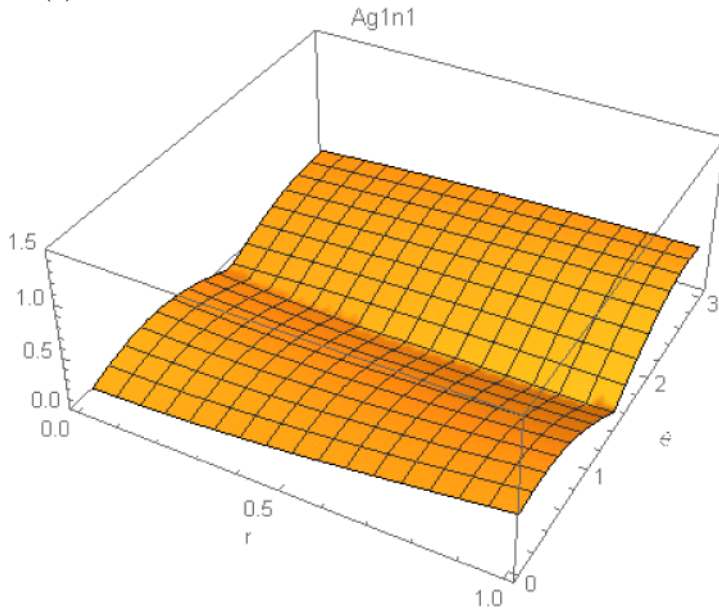

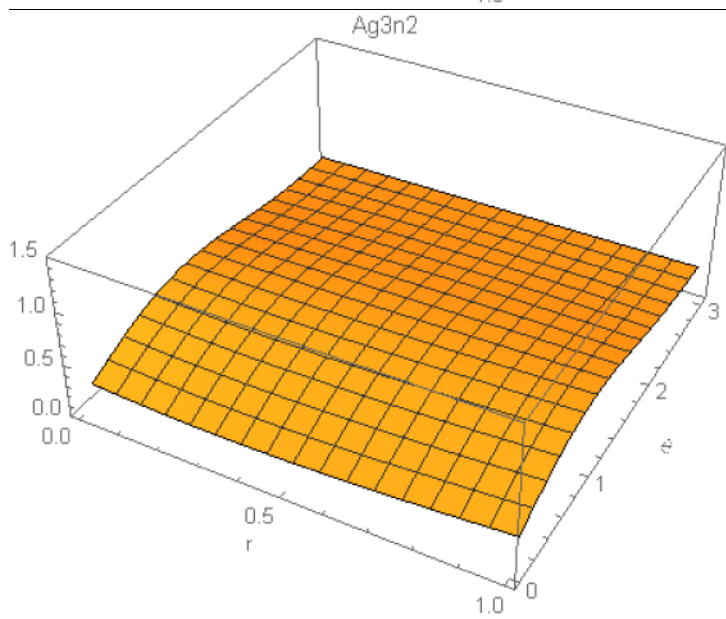
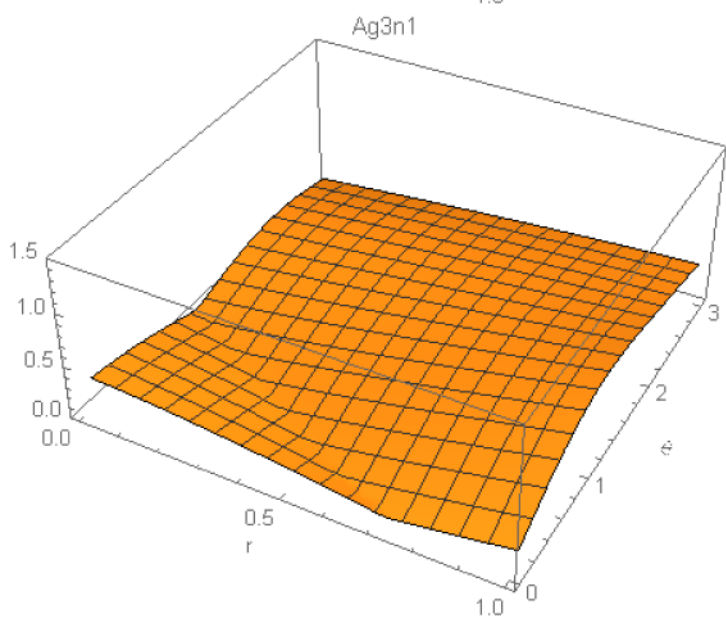
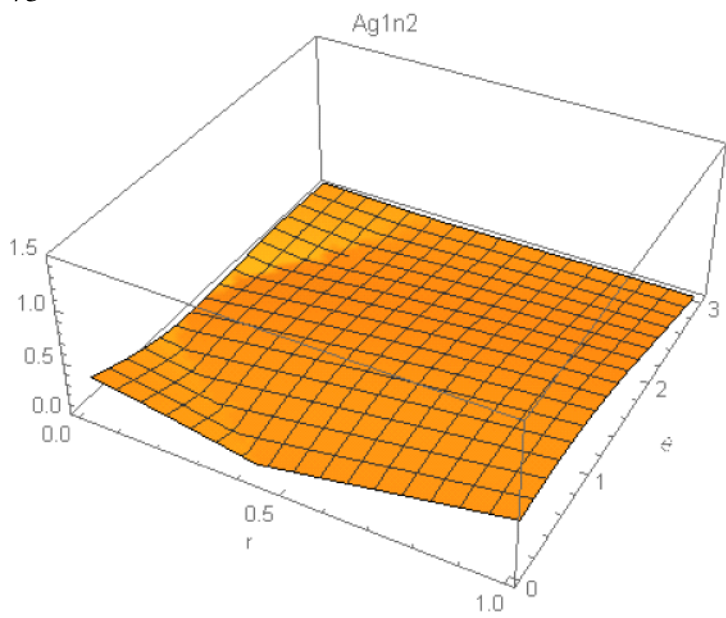

5. Weak hadron decays in the SU(4)-preon model

5.1 Neutron decay

The neutron decay obeys the scheme

$$dd \rightarrow ud + e^- + \bar{\nu}_e, \text{ i.e. for free neutrons } n \rightarrow p + e^- + \bar{\nu}_e$$

with the mean lifetime of $\tau=881.5 \pm 1.5$ s and energy $\Delta E=0.782343$ MeV

In the SM it is described by the interaction of a virtual W-boson

$$n^0 \rightarrow p^+ + W^- \rightarrow p^+ + e^- + \bar{\nu}_e$$

With the probability of about $p=0.001$, an additional photon is emitted

$$n^0 \rightarrow p^+ + e^- + \bar{\nu}_e + \gamma$$

Currently, there is a “neutron lifetime puzzle”: the lifetime measured by proton-counting (beam-method lifetime τ_1) yields $\tau_2 = \tau_1 + 8s$, compared to the bottle-method (lifetime τ_2) of counting the remaining neutrons. A possible explanation is the possibility of other decay channels for n.

In the SU4PM the decay proceeds as follows

$$d(rR-, qL+) \rightarrow u(rL+, qR+) + W^-(rR-, rR-) + Z_q(qL-, qL+)$$

$$d(rL-, qR+) \rightarrow d(rR-, qL+) + Z_L(rL-, rL+) + \bar{Z}_q(qR-, qR+)$$

with the immediate decay $W^-(rR-, rR-) \rightarrow e^-(rL-, rR-) + \bar{\nu}_e(rR-, rR+)$

and the decay $Z_L(rL-, rL+) \rightarrow \nu_e(rL-, rL+) + \nu_{s1}(rL+, rR-)$,

i.e. the total reaction is

$n \rightarrow p + e^- + \bar{\nu}_e + \nu_e + \nu_{s1}$, with the additional emission of a neutrino and a sterile neutrino, which are undetectable and carry away a small fraction of the total energy, ascribed to the antineutrino.

The neutrino and the antineutrino annihilate in a small fraction of events, producing an additional photon.

The virtual Z_q and \bar{Z}_q annihilate immediately and carry no energy away.

5.2 Transitions of quarks

A quark can make a transformation, which swaps the chirality of its components. This is seen at the example of a d-quark transition

$$d(rL-, qR+) \rightarrow d(rR-, qL+) + Z_L(rL-, rL+) + \bar{Z}_q(qR-, qR+) \rightarrow d(rR-, qL+) + \nu_e(rL-, rL+) + \bar{\nu}_q(qR-, qR+)$$

$$d(rR-, qL+) \rightarrow d(rL-, qR+) + \bar{Z}_L(rR-, rR+) + Z_q(qL-, qL+) \rightarrow d(rL-, qR+) + \bar{\nu}_e(rR-, rR+) + \nu_q(qL-, qL+)$$

Both transitions take at least the energy $\Delta E=23$ MeV for the mass of ν_q .

This transition can serve as an additional channel for the neutron decay:

$n \rightarrow n + \bar{\nu}_e + \nu_e + \bar{\nu}_q + \nu_q$, which takes away $\Delta E=2*23$ MeV and makes fast neutrons slow, making them undetectable by the usual scintillation method. This would explain the “neutron lifetime puzzle”.

5.3 Pion decay

The pion decay is the other major source of weak hadron decays, in the SM it is described as

$$u\bar{d} \rightarrow e^+ + \nu_e$$

In the SU4PM the decay proceeds as follows

$$u(rR+, qL+) \rightarrow u(rL+, qR+) + \bar{Z}_L(rR-, rR+) + \nu_q(qL-, qL+)$$

$$\bar{d}(rL+, qR-) \rightarrow \bar{u}(rR-, qL-) + W^+(rL+, rL+) + \bar{\nu}_q(qR-, qR+)$$

the virtual W-boson and ZL-boson decay into electron and neutrinos

$$W^+(rL+, rL+) \rightarrow e^+(rL+, rR+) + \nu_e(rL-, rL+)$$

$$\bar{Z}_L(rR-, rR+) \rightarrow \bar{\nu}_e(rR-, rR+) + \nu_{s1}(rL-, rR+)$$

so the overall reaction is

$$u(rR+, qL+) + \bar{d}(rL+, qR-) \rightarrow u(rL+, qR+) + \bar{u}(rR-, qL-) +$$

$+ e^+(rL+, rR+) + \nu_e(rL-, rL+) + \bar{\nu}_e(rR-, rR+) + \nu_{s1}(rL-, rR+)$, i.e.,

$u\bar{d} \rightarrow e^+ + \nu_e + \bar{\nu}_e + \nu_{s1}$, the pion decays into an electron and antineutrino plus the (undetectable) neutrino and sterile neutrino.

References

- [1] wikipedia 2018, Quantum chromodynamics
- [2] Gerard 't Hooft , Gauge theories, Scholarpedia 2008
- [3] Gavin Salam, SAIFR school on QCD and LHC physics, 2015
- [4] Gavin Salam, Elements of QCD for hadron colliders, [arXiv hep-th/1011.5131], 2011
- [5] P.Z. Skands , Introduction to QCD, [arXiv hep-ph/1207.2389], 2018
- [6] Christian Schwinn , Modern Methods of Quantum Chromodynamics, Universität Freiburg, 2015
- [7] Jorge Casado , Lecture Notes on The Standard Model, University of Oxford, 2017
- [8] Peter Petreczky , Basics of lattice QCD, Columbia University New York, 2014
- [9] Rajan Gupta , Introduction to lattice QCD, [arXiv hep-lat/9807.028], 1998
- [10] Quarks, www.hyperphysics.phy-astr.gsu.edu, 2018
- [11] Quang Ho-Kim & Pham Xuan-Yem, Elementary Particles and their interactions, Springer 1998
- [12] Michio Kaku, Quantum Field Theory, Oxford University Press 1993
- [13] Yu.M. Bystritskiy, & E.A. Kuraev, The cross sections of the muons and charged pions pairs production at electron-positron annihilation near the threshold, [arXiv hep-ph/0505236], 2005
- [14] J.W. Negele, Understanding Hadron Structure Using Lattice QCD, [arXiv hep-lat/9804017], 2001
- [15] wikipedia 2019, Standard model
- [16] wikipedia 2019, Quark
- [17] B. Ananthanaryan et al., Electromagnetic charge radius of the pion at high precision , [arXiv hep-ph/1706.04020], 2018
- [18] A.F. Krutov et al., The radius of the rho meson, [arXiv hep-ph/1602.00907], 2016
- [19] Mathematica-notebook QCDDLattice.nb, www.janhelm-works.de: action minimization in lattice QCD
Mathematica-notebook QCDDLatticeResults.nb, www.janhelm-works.de
- [20] W.-M. Yao *et al.* (Particle Data Group) (2006). "Review of particle physics" *Journal of Physics G* **33**: 1. arXiv: astro-ph/0601168 .
- [21] Leptonic mixing matrix and neutrino masses, <http://www.nu-fit.org/>, January 2018
- [22] Y.Y. Lee & C.T. Chen-Tsai , The Fifteenfold Way of the SU(4) Symmetry Scheme, Chinese journal of physics, 1965
- [23] M.A. Sbaib et al., Lie Algebra and Representation of SU(4), Electronic Journal of Theoretical Physics 28, 2013
- [24] Mathematica-notebook QHCDLattice.nb, www.janhelm-works.de: calculation of the basic particle masses and structure based on the SU(4) preon model
Mathematica-notebook QHCDLatticeResults.nb, www.janhelm-works.de
- [25] M. de Souza, General structure of matter, [arXiv:hep-ph/0207301v1], 2002
- [26] H. Harari, A Schematic Model of Quarks and Leptons, Physics Letters B **86** (1), 1979
- [27] H. Koike, Proton decay and sub-structure, [arXiv:hep-ph/0601153v1], 2006
- [28] S. Mohanty, MeV scale model of SIMP dark matter, [arXiv:hep-ph/1908.00909], 2019