

CI(16)

Science, Art, Music

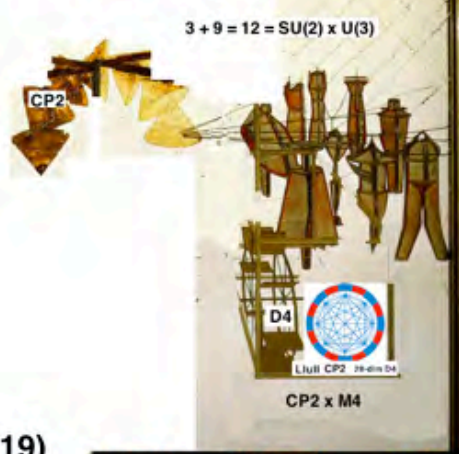

Frank Dodd (Tony) Smith, Jr. (2019)

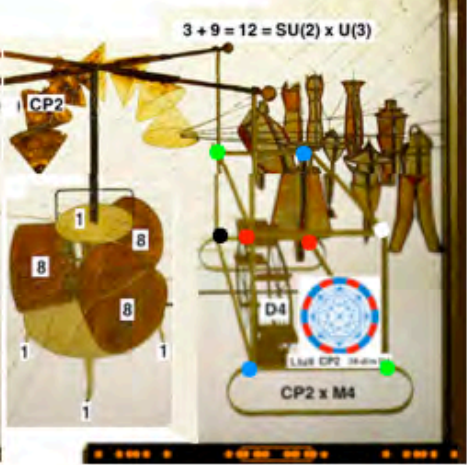
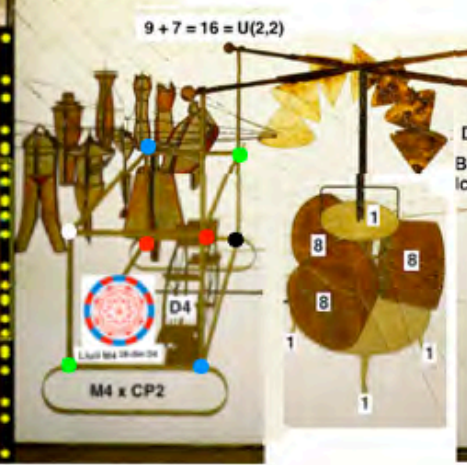

CI(16)

Science, Art, Music

Frank Dodd (Tony) Smith, Jr. - 2019

Abstract

There is a realistic Physics model,
based on Real Clifford Algebras including $Cl(16)$ and $Cl(1,25)$.

Part I describes Real Clifford Algebras.

Part II of this book describes Clifford Algebra Physics
and its calculations of Force Strengths, Particle Masses, Dark Energy :
Dark Matter : Ordinary Matter ratio, Kobayashi-Maskawa Parameters, and
3 mass states of Higgs-Truth Quark Nambu-Jona-Lasinio System as they
appear in Fermilab and LHC data.

Part III describes how Clifford Algebra Physics is related
to Art (specifically to The Large Glass by Marcel Duchamp) and
to Music (specifically to the Grosse Fugue by Ludwig van Beethoven)
and to Archetypes of the Red Book by Carl Gustav Jung.

Part IV describes History: Universe - Humanity - my family.

Part V describes Deuterium fusion $D+D+D+D$ to $He+He + 47.6$ MeV
by Klein Paradox Quantum Tunnelling in Palladium Clusters.

Terminology note - I use the term Spinor for Column Vectors
of full Matrix Algebras (such as Real Clifford Algebras)
instead of their Even Subalgebras so what I call Spinors
are what most people call Pinors. I hope that my usage
will be clear from context.

Table of Contents

Part I - Real Clifford Algebras

CI(VOID) -> CI(16) Finkelstein Clifford Iteration Universe Origin ...	page 4
CI(n) for n = VOID,0,1,2,3 ...	page 6
CI(4) ...	page 8
CI(8) ...	page 9
TriVectors = Fr3(O)	
26D String=World-Line Theory, Tachyons, Bohmions ...	page 10
Vectors + BiVectors + Spinors = F4	
Spacetime, Gauge Bosons, Fermions ...	page 14
Primes and Powers of 2 ...	page 19
CI(16) ...	page 22
CI(8) \otimes CI(8) = CI(16) ...	page 23
H4 + H4 = E8 ...	page 24
E8 Root Vectors ...	page 25
Fermion Particles ...	page 26
Fermion AntiParticles ...	page 27
Spacetime Creation/Annihilation ...	page 28
Standard Model Gauge Bosons ...	page 30
Gravity+Dark Energy Gauge Boson ...	page 32
Overview Graphic for CI(16) ...	page 33

Part II - CI(16) Physics

Basic Structure of CI(16) and CI(1,25) Physics ...	page 34
CI(16) Vectors = Spacetime ...	page 35
CI(16) BiVectors and half-Spinors = Gauge Bosons and Fermions ...	page 37
Octonionic E8 Root Vector Lagrangian ...	page 38
Subtle Supersymmetry (Octonionic) ...	page 41
Quaternionic E8 Root Vector Lagrangian ...	page 43 57
Nambu-Jona-Lasinio Higgs-Truth Quark System ...	page 59
CMS Higgs Histograms ...	page 63
Fermilab Truth Quark data ...	page 69
Varnes Ph.D. Thesis ...	page 70
Dalitz, Goldstein, and Fermilab ...	page 76
Two D4 of D8 / D4xD4 ...	page 78
Schwinger Sources ...	page 81
Visualization ...	page 81
Symmetry of Sources ...	page 87
Kernel and Green's Functions ...	page 88
Masses and Force Strengths ...	page 103
Size and Internal Structure ...	page 106
Indra's Net Blockchain ...	page 107

Table of Contents (cont'd)

Wylter Calculations of Force Strengths, Masses, etc ...	page 122
Gauge Boson Geometry ...	page 123
Force Strengths ...	page 125
Higgs, W+, W-, Z0 Masses ...	page 131
Fermion Masses ...	page 136
Kobayashi-Maskawa Parameters ...	page 148
Neutrino Masses beyond Tree Level ...	page 158
Proton-Neutron Mass Difference ...	page 163
Pion as Sine-Gordon Breather ...	page 164
Planck Mass ...	page 169
Conformal Gravity + Dark Energy and DE : DM : OM ...	page 170
Results of Calculations, Coleman-Mandula, Chirality, Spin-Statistics, 3 Generations ...	pages 180-183
CII(16) TriVectors = Fr3(O) 26D String=World-Line Theory ...	page 184
Construction from J3(O)o ...	page 188
Construction from E8 Redundancy ...	page 193
Many-Worlds ...	page 195
Creation/Annihilation and E8 Maximal Contraction ...	page 197
Bohm Sutherland Lagrangian and Sarfatti Back-Reaction ...	page 198
Algebraic Quantum Field Theory (AQFT) ...	page 200
Penrose-Hameroff Quantum Consciousness ...	page 205
Part III - CI(16) and Art, Music, and Archetypes of Jung's Red Book	
Duchamp's Large Glass ...	page 221
Beethoven's Grosse Fugue ...	page 275
Jung's Red Book ...	page 302
Part IV - History	
Universe from Big Bang to Manetho's Rule of Gods ...	page 307
Humanity from Manetho's Decline of Gods to Now ...	page 315
some of my family history ...	page 349
Part V - Deuterium Fusion in Palladium Clusters	
by Klein Paradox Quantum Tunnelling ...	page 377

Part I

Real Clifford Algebras describe the algebra and geometry of vector spaces and their subspaces. They are matrix algebras whose entries are either Real Numbers (green in the diagram on the following page), Complex Numbers (white) or Quaternions (yellow). The diagram shows some Real Clifford Algebras $Cl(p,q)$ for real vector spaces of signature (p,q) . The $p=0$ line is $Cl(0,q) = Cl(q)$.

The diagram also shows the chain of Real Clifford Algebras used by David Finkelstein to describe the Origin of Our Universe:

VOID

$$Cl(VOID) = Z = \text{Integers} = 0\text{-dimensional}$$

$$Cl(0) = R = \text{Real Numbers} = 1\text{-dimensional}$$

$$Cl(1) = C = \text{Complex Numbers} = 2\text{-dimensional}$$

$$Cl(2) = H = \text{Quaternions} = 4\text{-dimensional}$$

$$Cl(4) = M_2(H) = 2 \times 2 \times 4 = 16\text{-dimensional}$$

$$Cl(16) = M_{256}(R) = 256 \times 256 = 65,536\text{-dimensional}$$

The Finkelstein Clifford Iteration Process stops at $Cl(16)$ because its 16-dim Vector part has Zero Divisors (arXiv math/0512517) given by fibration $Spin(7) / Spin(5) = V(7,2) \rightarrow G_2 \rightarrow S^3$ with symmetry of 10-dim Lie Sphere $Spin(7) / Spin(5) \times U(1)$ corresponding to $Cl(1,9) = Cl(2,8) = M_{32}(R)$ Conformal over $Cl(1,7) = Cl(0,8) = M_{16}(R)$. The 16-dim Sedenion Zero Divisors have $7+28 = 35$ Associative Triples. Further, although by 8-Periodicity $Cl(16) = \text{tensor product } Cl(8) \otimes Cl(8)$, neither $Cl(8) = M_{16}(R)$ nor 8-dim Vectors of $Cl(8)$ are a Division Algebra. $Cl(8)$ Vectors = $Cl(3) = 8\text{-dim associative algebra not the nonassociative Octonions}$.

Some details of $Cl(n)$ describing algebra and geometry of n -dim space are:

For the VOID that is just the Empty Set

$Cl(\text{VOID})$ has no graded structure

$Cl(\text{VOID})$ algebra = **0-dim Integers**

For 0-dim Space that is just a point

$Cl(0)$ has graded structure 0 where

grade 0 = 1 type of 0-dim point

algebra = Real Numbers with basis { 1 }

$Cl(0)$ algebra = $2^0 =$ **1-dim Real Numbers**

with basis { 1 }

For 1-dim Space with coordinate x

$Cl(1)$ has graded structure 0 1 where

grade 0 = 1 type of 0-dim point

algebra = Real Numbers with basis { 1 }

grade 1 = 1 type of 1-dim line

algebra = Imaginary Numbers with basis { i }

$Cl(1)$ algebra = $2^1 =$ **2-dim Complex Numbers**

with basis { 1 i }

For 2-dim Space with coordinates x y

$Cl(2)$ has graded structure 0 1 2 where

grade 0 = 1 type of 0-dim point

algebra = Real Numbers with basis { 1 }

grade 1 = 2 types of 1-dim line

algebra = Imaginary Numbers with basis { i j }

grade 2 = 1 type of 2-dim area

algebra = Imaginary Numbers with basis { k }

$Cl(2)$ algebra = $2^2 =$ **4-dim Quaternions**

with basis { 1 i j k }

For 3-dim Space with coordinates $x y z$
 $Cl(3)$ has graded structure $0 1 2 3$ where
 grade 0 = 1 type of 0-dim point
 grade 1 = 3 types of 1-dim line
 grade 2 = 3 types of 2-dim area
 grade 3 = 1 type of 3-dim volume

$Cl(3)$ algebra = $2^3 = 8 = (4+4)$ -dim **Pair of Quaternions**
 with basis $\{ 1 i j k ; K J I E \}$

$Cl(3)$ is associative and differs from non-associative Octonions.

For Our 3-dim space with coordinates $x y z$
 $Cl(3)$ has graded structure **1 + 3 + 3 + 1**

grade-0 **1 - one type of 0-dim point**

grade-1 **3 - three types of lines / directions in space:**

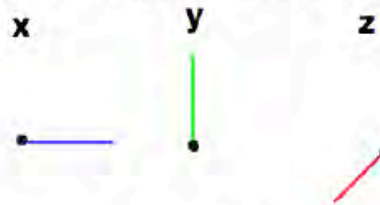

grade- 2 **3 - three types of planes in space:**



grade- 3 **1 - all of 3-space itself**



Wikipedia says "... The ... Clifford algebra of R^3 ... is isomorphic to the ... algebra generated by the ... Pauli matrices ...

$$\sigma_1 = \begin{pmatrix} 0 & 1 \\ 1 & 0 \end{pmatrix} \quad \sigma_2 = \begin{pmatrix} 0 & -i \\ i & 0 \end{pmatrix} \quad \sigma_3 = \begin{pmatrix} 1 & 0 \\ 0 & -1 \end{pmatrix} \quad \dots"$$

For 4-dim Space with coordinates $t\ x\ y\ z$
 $Cl(4)$ has graded structure 0 1 2 3 4 where
 grade 0 = 1 type of 0-dim point
 grade 1 = 4 types of 1-dim line
 grade 2 = 6 types of 2-dim area
 grade 3 = 4 types of 3-dim volume
 grade 4 = 1 type of 4-dim volume

$Cl(4)$ algebra = $2^4 = 2^3 = 16 =$ **(4x4)-dim 2x2 Quaternion Matrices**

Physical Minkowski space M_4 has signature (1,3) so that
 $Cl(M_4) = Cl(1,3) = M_2(H) =$ **2x2 Matrices of Quaternions = $Cl(4)$**
 which is the correct physical form
 of **Dirac Matrices = 16-dim 2x2 Quaternion Matrices**
 for which **Spinor Column Vectors = 8-dim 2x1 Quaternion Matrices**
 naturally represent Fermions as to which Feynman (1986 Dirac Lecture)

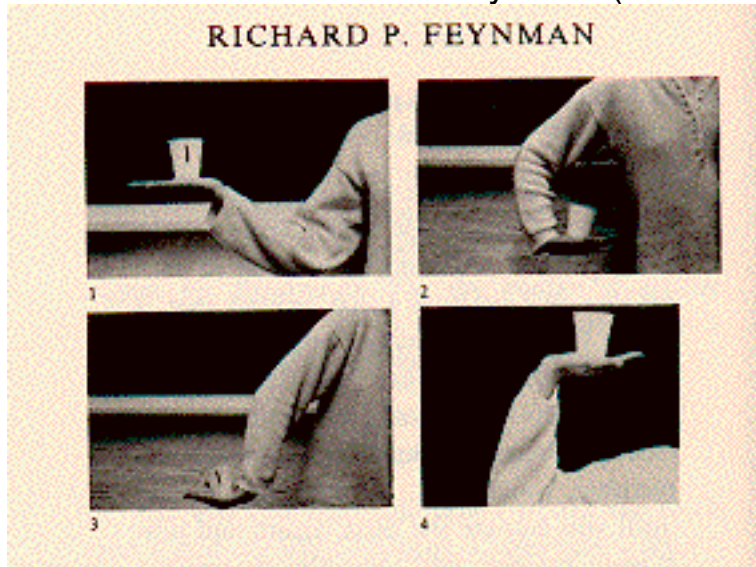

demonstrated a Spinor Orientation-Entanglement property

Realistic Dirac Matrices are not 16-dim 4x4 Real
 or their 32-dim Complexification
 for which Spinor Column Vectors = 4-dim 4x1 Real or 8-dim 4x1 Complex.

For 8-dim Space

Cl(8) has graded structure 0 1 2 3 4 5 6 7 8] where
 grade 0 = 1 type of 0-dim point
 grade 1 = 8 types of 1-dim line
 grade 2 = 28 types of 2-dim area
 grade 3 = 56 types of 3-dim volume

Cl(8) algebra = $2^8 = 256$ -dim **16x16 Real Matrices**

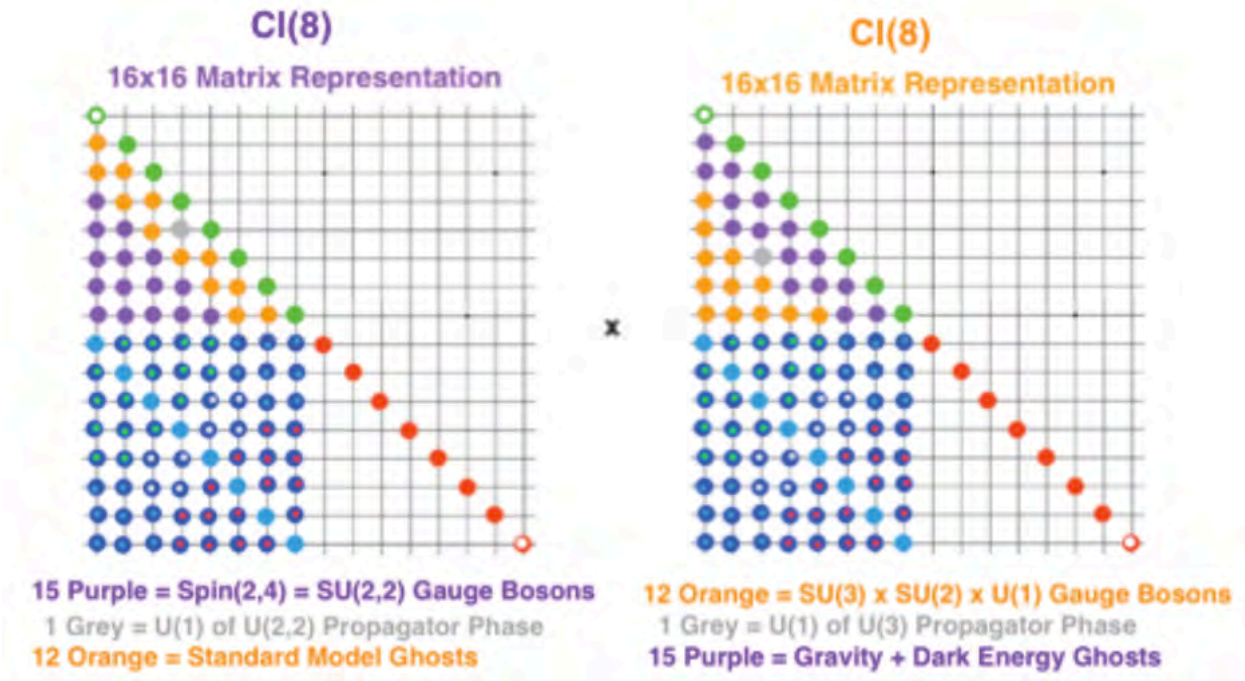

Cl(8) has graded structure $1+8+28+56+70+56+28+8+1$
 and Spinor structure $8s+8c$ in which
 $8s$ denotes +half-Spinors representing Fermion Particles (s for spinor) and
 $8c$ denotes -half-Spinors representing Fermion AntiParticles (c for chiral)
 and

$$56 \text{ TriVectors} = \text{Fr3(O)}$$

56-dim Fr3(O) = Freudenthal Algebra of Zorn vector-matrices

- 8v Vectors = Spacetime (v for vector)
- 28 BiVectors = 28 Spin(8) Gauge Bosons
- 8s +half-Spinors = 8 Fermion Particle Types
- 8c -half-Spinors = 8 Fermion AntiParticle Types
- which combine to form
- $8+28 + 8s+8c = 52$ -dimensional Lie Algebra **F4**

56 TriVectors = Fr3(O)

56-dim Fr3(O) = Freudenthal Algebra of Zorn vector-matrices Fr3(O) is a Complexification of J3(O) and J3(O)o and 26D String=World-Line Theory

$$\begin{array}{c}
 \begin{array}{ccc}
 & & \begin{array}{ccc} d & S_+ & V \end{array} \\
 & & \begin{array}{ccc} S_+^* & e & S_- \end{array} \\
 & & \begin{array}{ccc} V^* & S_-^* & f \end{array} \\
 a & &
 \end{array} \\
 \\
 \begin{array}{ccc}
 \begin{array}{ccc} d' & S_+^{*\prime} & V'^* \end{array} \\
 \begin{array}{ccc} S_+^{\prime} & e' & S_-^{*\prime} \end{array} \\
 \begin{array}{ccc} V' & S_-^{\prime} & f' \end{array} \\
 & & b
 \end{array}
 \end{array}$$

where a, b, d, e, and f are real numbers; S_+ , V , S_- , S_+^{\prime} , V' , and S_-^{\prime} are Octonions; and * denotes conjugation.

$$\begin{array}{ccc}
 d & S_+ & V \\
 S_+^* & e & S_- \\
 V^* & S_-^* & f
 \end{array}$$

is 27-dim J3(O) = 3x3 Hermitian Octonion Matrices whose traceless part is 26-dim J3(O)o that describes 26D String Theory with Strings = World-Lines and Tachyons creating Schwinger Sources and Bohm Quantum Potential for Penrose-Hameroff Quantum Consciousness

V = 8-dim Spacetime

the 8-real-dim space $RP^1 \times S^7$ that is the Shilov Boundary of the 16-real-dim $IV(8,2)$ Bounded Domain (tube type) of the BDI Symmetric Space $Spin(10) / Spin(8) \times U(1)$

S+ = 8 +half-Spinor Fermion Particles

the real part $RP^1 \times S^7$ of the Complex Shilov Boundary S of the 32-real-dim V non-tube type bounded Domain $(C \times O)P_2$ of the EIII Symmetric Space $E_6 / Spin(10) \times U(1)$.

S- = 8 - half-Spinor Fermion AntiParticles

$RP^1 \times S^7$ in the Complex part of the Shilov Boundary S of the 32-real-dim V non-tube type bounded Domain $(C \times O)P_2$ of the EIII Symmetric Space $E_6 / Spin(10) \times U(1)$

With **S+** and **S-** Fermions propagating in **V** Spacetime,
Strings are physically interpreted as World-Lines,

according to David Finkelstein's idea ("Space-Time Code. III" Phys. Rev. D (1972) 2922-2931)

"... According to relativity, the world is a collection of processes (events} with an unexpectedly unified causal or chronological structure. Then an object is secondary ... [to]... a long causal sequence of processes, world line. ... [if] we assemble these ... into chromosomelike code sequences ... and braid and cross-link these strands to make more complex objects and their interactions ...[then]... The idea of the quantum jump comes into its own, and reigns supreme, even over space and time. ...".

Andrew Gray (quant-ph/9712037v2) said:

"... A new formulation of quantum mechanics ... assign[s] ... probabilities ... to entire fine-grained histories ... [It] is fully relativistic and applicable to multi-particle systems ...[and]... makes the same experimental predictions as quantum field theory ...

consider space and time cut up into small volume elements

... and then take the limit as ... volume ... $\rightarrow 0$...

get the final amplitude ... by considering all possible distributions at a time t earlier ...

for each such distribution the amplitude for it to occur [is] multiplied by the amplitude to get ... the final distribution ... **the interference factor ... is a measure of how much interference between the different possible histories that contain the distribution of interest there is at each time ... This result is the ... Feynman amplitude squared times the product of all the interference factors ...**.

Luis E. Ibanez and Angel M. Uranga in “String Theory and Particle Physics” said:

“... String theory proposes ... small one-dimensional extended objects, strings, of typical size $L_s = 1/M_s$, with M_s known as the string scale ... As a string evolves in time, it sweeps out a two-dimensional surface in spacetime, known as the worldsheet, which is the analog of the ... worldline of a point particle ... for the bosonic string theory ... the classical string action is the total area spanned by the worldsheet ... This is the ... Nambu– Goto action ...”.

Consider the Gray Fine-Grained History to be a World-Line String.



**The Gray Fine-Grained History Quantum Theory
is equivalent to
the Nambu-Goto action of 26D String Theory.**

**Nambu-Goto 24x24 traceless spin-2 particle
is
Quantum Bohmion carrier of Bohm Quantum Potential**

Ibanez and Uranga also said:

“... The string groundstate corresponds to a 26d spacetime tachyonic scalar field $T(x)$. This **tachyon** ... is ... unstable

...

The massless two-index tensor splits into irreducible representations of $SO(24)$...

Its **trace** corresponds to a scalar field, the **dilaton** ϕ , whose vev fixes the string interaction coupling constant g_s

...

the **antisymmetric** part is the 26d 2-form field BMN

...

The **symmetric traceless** part is the 26d ... GMN ...”.

Tachyons localized at Orbifolds of Fermions produce virtual clouds of particles / antiparticles that dress Fermions as Schwinger Sources.

Dilatons are Goldstone bosons of spontaneously broken scale invariance that

(analogous to Higgs) go from mediating a long-range scalar gravity-type force to the nonlocality of the Bohm-Sarfatti Quantum Potential.

The **antisymmetric** $SO(24)$ little group is related to the Monster automorphism group that is the symmetry of each cell of Planck-scale local lattice structure.

The **symmetric traceless part is the Bohmion** carrier of the Bohm Quantum Potential. It has spin-2.

Of the 26 dimensions,
16 are for Orbifolded First Generation Fermion Particles (8 types) and AntiParticles (8 types)
and 4 are for CP^2 Internal Symmetry Space of $M_4 \times CP^2$ Kaluza-Klein.

The remaining $26-16-4 = 6$ dimensions are the Conformal Physical Spacetime with $Spin(2,4) = SU(2,2)$ symmetry that produces M_4 Minkowski Physical Spacetime.

$$8 \text{ Vectors} + 28 \text{ BiVectors} + 16 \text{ Spinors} = F4$$

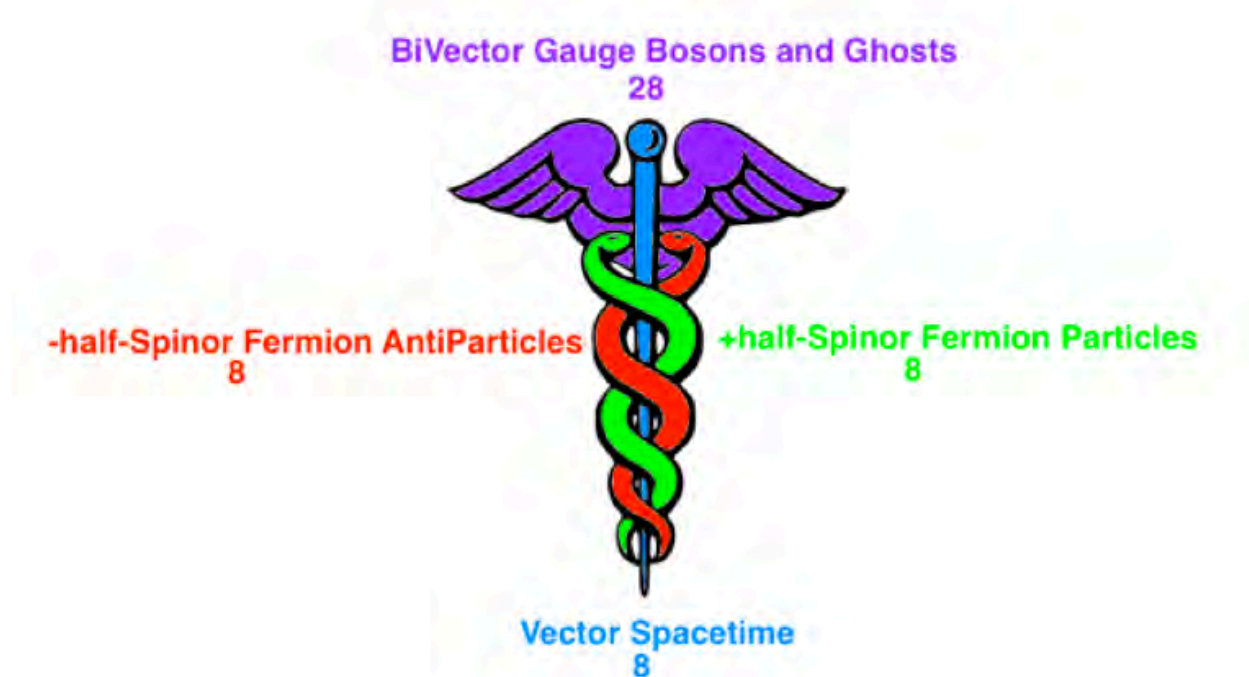

Since $F4 = 8 \text{ Cl}(8) \text{ grade-1} + 28 \text{ Cl}(8) \text{ grade-2} + (8s+8c) \text{ Cl}(8) \text{ Spinors}$:

$$\begin{aligned}
 F4 \otimes F4 &= 1 \times 8 + 8 \times 1 = 16 \text{ Cl}(16) \text{ grade-1} + 28 \times 28 = 784 \text{ of Cl}(16) \text{ grade-4} + \\
 &+ 1 \times 28 + 28 \times 1 + 8 \times 8 = 120 \text{ Cl}(16) \text{ grade-2} + \\
 &+ (8s+8c) \times (8s+8c) = 8s \times 8s + 8s8c + 8c8s + 8c8c \text{ Cl}(16) \text{ Spinors} \\
 &= 16 \text{ Cl}(16) \text{ grade-1} + 784 \text{ of Cl}(16) \text{ grade-4} \\
 &+ 120 \text{ Cl}(16) \text{ grade-2} + 128 (8s8s + 8c8c) \text{ Cl}(16) \text{ half-Spinors} + \\
 &+ 128 (8s8c + 8c8s) \text{ Cl}(16) \text{ half-Spinors}
 \end{aligned}$$

Since $248 \text{ E8} = 120 \text{ Cl}(16) \text{ grade-2} + 128 (8s8s + 8c8c) \text{ Cl}(16) \text{ half-Spinors}$

Here is how the 2 copies of $F4$ produce $E8$ as part of $F4 \otimes F4$

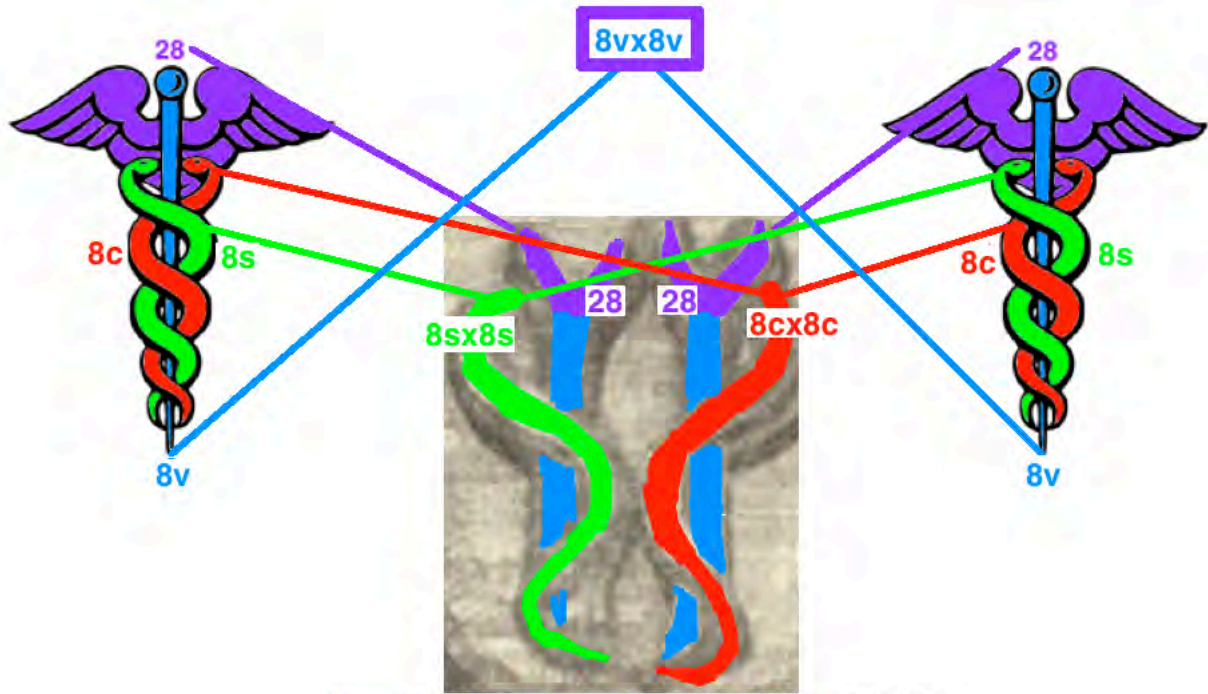

$$28 + 28 + 8vx8v + 8sx8s + 8cx8c = 248 \text{ E8}$$

The diagram can be interpreted in terms of E8 Maximal Contraction Heisenberg Algebra of Creation / Annihilation Operators with grades

$$28 + 64 + 64 + 64 + 28$$

the two purple 28 = Creation / Annihilation Operators for the two D4 of E8, one for Gravity+Dark Energy Gauge Bosons and Standard Model Ghosts and another for Standard Model Gauge Bosons and Gravity+DE Ghosts;

green 8sx8s = Creation / Annihilation operators for 8 spacetime components of 8 Fermion Particle Types;

red 8cx8c = Creation / Annihilation operators for 8 spacetime components of 8 Fermion AntiParticle Types;

blue 8vx8v = A7+R grade-0 of E8 Maximal Contraction Heisenberg Algebra of Creation / Annihilation Operators of 8-dim Spacetime Planck-scale Cells

E8 is contained in $F4 \otimes F4$ so that E8 inherits from F4 properties including representation of its Spinor parts by anticommutators thus allowing the E8 128 (8s8s + 8c8c) Cl(16) half-Spinors to represent physical Fermions (see hep-th/0112261 by Pierre Ramond and viXra 1208.0145).

As to use of a caduceus image from Rudolf Steiner's Goetheanum structures to represent the F4 part of Cl(8), he said: "... "Here we come to something that causes the ... mystic ... to say: There he created a caduceus. I didn't create a caduceus; I allowed the previous forms to grow. The form originated on its own ..." thus supporting Jung's idea of Archetypes built into the structure of the Human Mind.

F4 contains a B4 by $F4 / B4 = OP2 = \text{Octonion Projective Plane}$

B4 contains a D4 by $B4 / D4 = OP1 = \text{Octonion Projective Line}$

28-dim D4 has 2 distinct subspace schemes that with respect to Quaternionic $M4 \times CP2$ Kaluza-Klein act primarily on $M4$ or on $CP2$:

On $M4$: 16-dim $U(2,2)$ containing 15-dim Conformal $SU(2,2) = Spin(2,4)$ for Conformal Gravity+Dark Energy + $U(1)$ Propagator Phase acts on 6-dim (2,4) Conformal Space and therefore also acts on 4-dim (1,3) Minkowski Space $M4$

On $CP2$: 12-dim Standard Model $SU(3) \times SU(2) \times U(1)$ acts as global Color Force $SU(3)$ which is a subgroup of $SU(4)$ subgroup of $D4$.
 $SU(2) \times U(1)$ come from little group of $CP2 = SU(3) / SU(2) \times U(1)$

Each of the 2 $Cl(8)$ of $Cl(8) \otimes Cl(8) = Cl(16)$ contains an F4-B4-D4 chain one of which acts primarily on M4 of M4 x CP2 and has this Quaternionic structure pattern

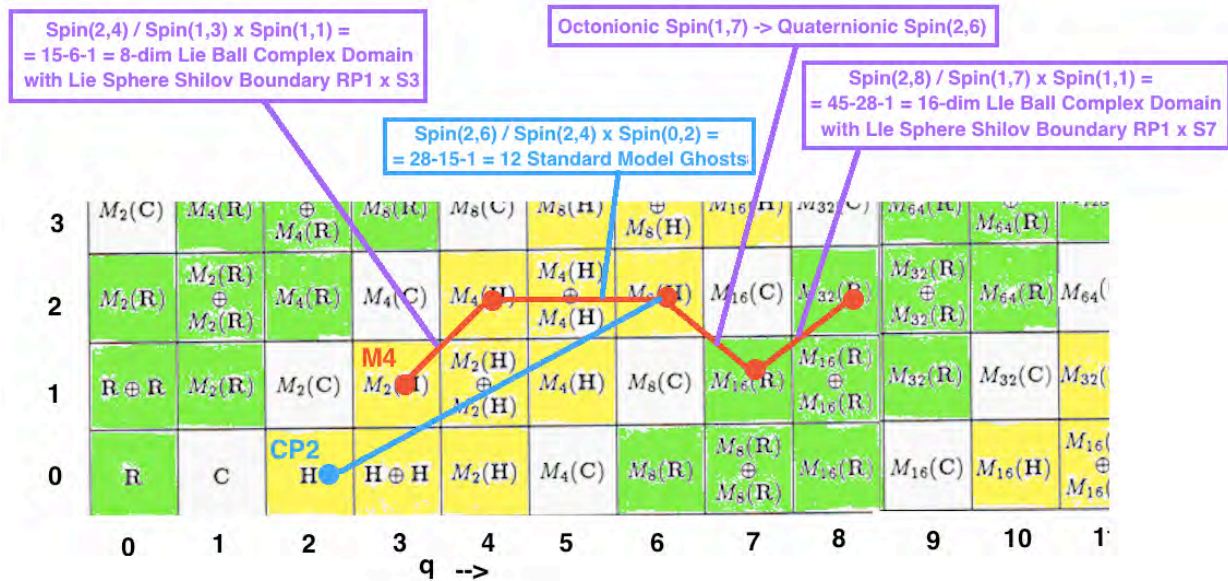

$Cl(2,8)$ to $Cl(1,7)$ gives 16-dim Lie Ball Complex Domain with 8-dim Octonionic-Real Spacetime Shilov Boundary $RP1 \times S7$

$Cl(1,7) = M16(R)$ to $Cl(2,6) = M8(H)$ goes from Octonionic Spacetime to Quaternionic (4+4)-dim M4 x CP2 Kaluza-Klein Spacetime

$Cl(2,6)$ to $Cl(2,4) = M4(H)$ goes to BiVectors $Spin(2,4) = SU(2,2)$ of 15 Gauge Bosons for Conformal Gravity+Dark Energy for M4 and 1 U(1) Propagator Phase from $U(2,2) = U(1) \times SU(2,2)$

$Cl(2,4)$ to $Cl(1,3) = M2(H)$ goes to $Spin(2,4) / Spin(1,3) \times Spin(1,1) = 15-6-1 = 8$ -dim Lie Ball Complex Domain with Lie Sphere Shilov Boundary $RP1 \times S3 = M4$

$Cl(2,6)$ to $Cl(0,2) = H$ goes to $Spin(2,6) / Spin(2,4) \times Spin(0,2) = 28-15-1 = 12$ Standard Model Ghosts
4-dim $H = M4$

and the other of which acts primarily on CP2
 and has this structure pattern of decomposition of Spin(2,6)

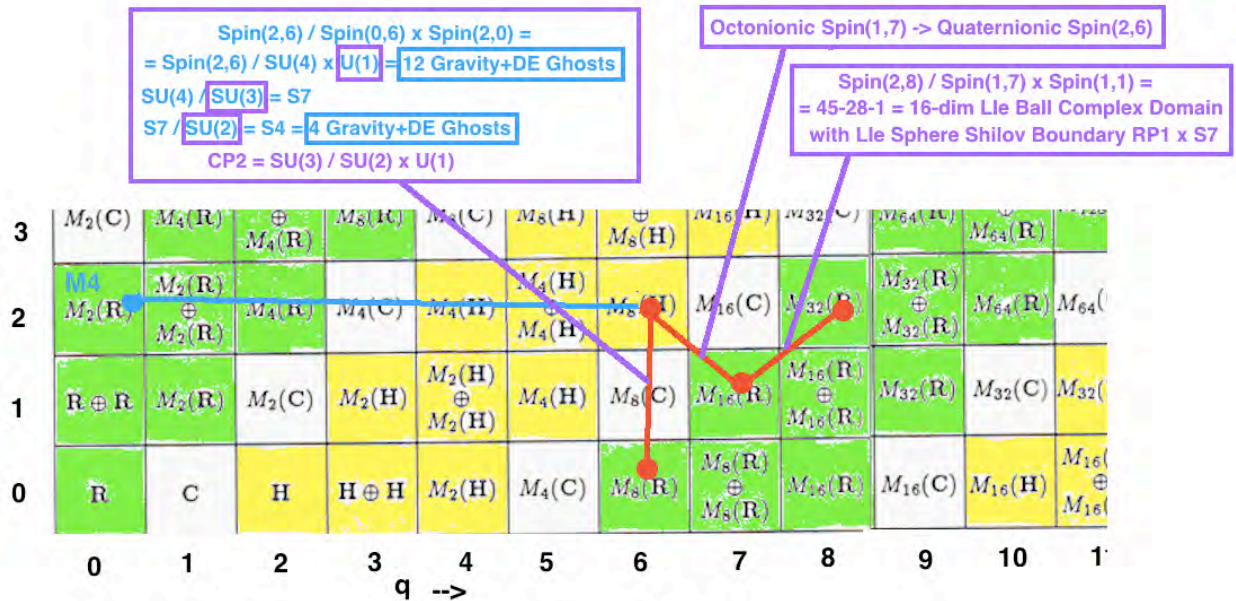

Cl(2,8) to Cl(1,7) gives 16-dim Lie Ball Complex Domain
 with 8-dim Octonionic-Real Spacetime Shilov Boundary RP1 x S7

Cl(1,7) = M16(R) to Cl(2,6) = M8(H) goes from Octonionic Spacetime
 to Quaternionic (4+4)-dim M4 x CP2 Kaluza-Klein Spacetime

Cl(2,6) to Cl(0,6) = Cl(6) = M8(R) goes to BiVectors Spin(6) = SU(4)
 containing Standard Model Color Force Gauge Group SU(3)
 $SU(4) / SU(3) = Spin(6) / SU(3) = \text{exotic } S7$
 $\text{exotic } S7 / SU(2) = \text{exotic } S7 / S3 = CP2 = SU(3) / SU(2) \times U(1)$
 so by Batakis Mechanism (Class. Quantum Grav. 3 (1986) L99-L105)
 for Standard Model Gauge Groups $SU(3) \times SU(2) \times U(1)$

Cl(2,6) to Cl(2,0) = M2(R) goes to $Spin(2,6) / Spin(0,6) \times Spin(2,0) =$
 $= 28-15-1 = 12$ of 16 Gravity+Dark Energy Ghosts
 4-dim M2(R) = 4 of 16 Gravity+Dark Energy Ghosts

There is another (probably equivalent to the one described above) way to visualize the **emergence of E8 in Cl(16)** from **Cl(8) \otimes Cl(8) = Cl(16) = M16(R) \otimes M16(R) = M256(R) = 256 x 256 Real Matrices**

Each Cl(8) in Cl(8) \otimes Cl(8) contains a D4 - B4 - F4 chain

D4 has 24 Root Vectors = Vertices of a 24-cell forming a 4-dim D4 Lattice and with a second D4 Lattice forming a 4-dim D4+ = Z4 Lattice

Ray Aschheim has shown that

N is a power of 2 if and only if the radius-N sphere has 24 vertices
That is: 3 vertices for each of the 8 radii.

N is a prime if and only if the radius-N sphere has 8 x (1+N) vertices
That is:

For each of the 8 radii of length N the sphere has N + 1 vertices - one vertex for each of the N nested spheres intersected by the radius plus one for the origin.

Further, in terms of Real Clifford Algebras:

N is prime if and only if

The orders of ALL grades of Cl(N) (other than 0 and N) contain a factor of N
Cl(N) graded structure = 1 + N + aN + bN + ... + bN + aN + N + 1

For example:

The graded structure for Cl(16) is
1 16 120 560 1820 4368 8008 11440 12870 11440 8008 4368 1820 560 120 16 1
16 is not a factor of 120
and for Cl(17) is
1 17 136 680 2380 6188 12376 19448 24310 ... same numbers in reverse order
divided by 17
NO 1 8 40 140 364 728 1144 1430 ... same numbers in reverse order

These Power-of-2 and Prime Relationships are peculiar to self-dual 24-cell and its Lattices based on Quaternions = Cl(2)

I think that Integer Quaternions with their D4+ Geometric Structure are the most fundamental representation of Integers.

Here are the numbers of vertices in the first 45 shells of the D4+ lattice.

Red S3 shells have prime radius. Green S3 shells have power-of-2 radius.

Purple S3 shells have prime x power-of-2 radius.

m = radius of shell	N(m) = no. vertices in shell of radius m
0	1
1	8 = 1 x 8
2	24 = (1 + 2) x 8 = 1 x 24
3	32 = (1 + 3) x 8
4	24 = 1 x 24
5	48 = (1 + 5) x 8
6	96 = (1 + 3) x 24
7	64 = (1 + 7) x 8
8	24 = 1 x 24
9	104 = (1 + 3 + 9) x 8
10	144 = (1 + 5) x 24
11	96 = (1 + 11) x 8
12	96 = (1 + 3) x 24
13	112 = (1 + 13) x 8
14	192 = (1 + 7) x 24
15	192 = (1 + 3 + 5 + 15) x 8
16	24 = 1 x 24
17	144 = (1 + 17) x 8
18	312 = (1 + 3 + 9) x 24
19	160 = (1 + 19) x 8
20	144 = (1 + 5) x 24
21	256 = (1 + 3 + 7 + 21) x 8
22	288 = (1 + 11) x 24
23	192 = (1 + 23) x 8
24	96 = (1 + 3) x 24
25	248 = (1 + 5 + 25) x 8
26	336 = (1 + 13) x 24
27	320 = (1 + 3 + 9 + 27) x 8
28	192 = (1 + 7) x 24
29	240 = (1 + 29) x 8
30	576 = (1 + 3 + 5 + 15) x 24
31	256 = (1 + 31) x 8
32	24 = 1 x 24
33	384 = (1 + 3 + 11 + 33) x 8
34	432 = (1 + 17) x 24
35	384 = (1 + 5 + 7 + 35) x 8
36	312 = (1 + 3 + 9) x 24
37	304 = (1 + 37) x 8
38	480 = (1 + 19) x 24
39	448 = (1 + 3 + 13 + 39) x 8
40	144 = (1 + 5) x 24
41	336 = (1 + 41) x 8
42	768 = (1 + 3 + 7 + 21) x 24
43	352 = (1 + 43) x 8
44	288 = (1 + 11) x 24
45	624 = (1 + 3 + 5 + 9 + 15 + 45) x 8

B4 has 36 Root Vectors = Vertices of 24-cell + 4-dim Cross Polytope

F4 has 48 Root Vectors = Vertices of 24-cell + dual 24-cell

(images from Frans Marcelis <http://members.home.nl/fg.marcelis/mathematics.htm>)

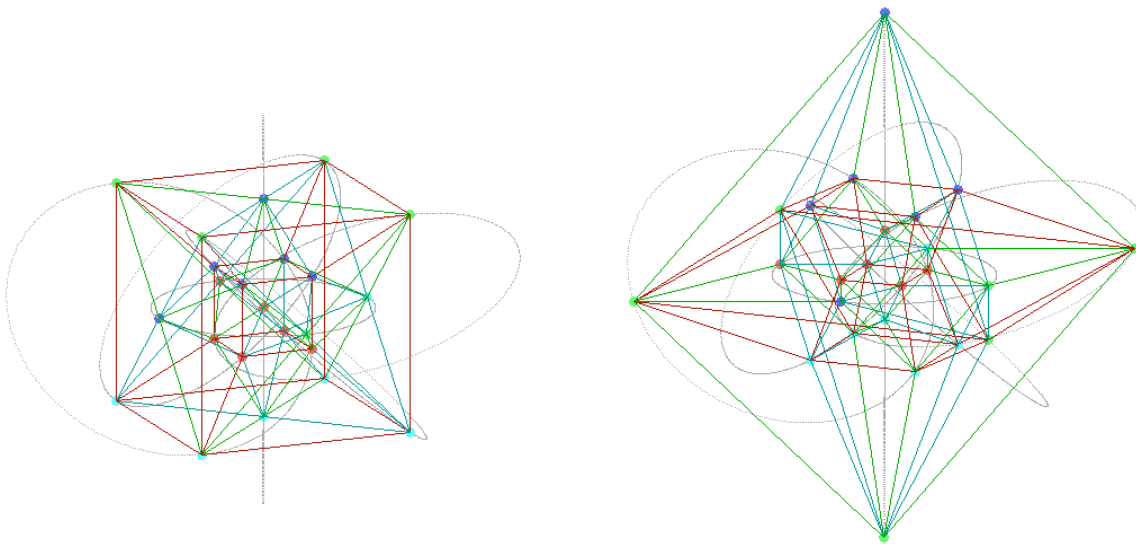

The F4 dual 24-cell has 24 Vertices and 96 Edges.

Divide each of the 96 Edges at Golden Ratio points in a consistent way (there are 2 mirror image ways to do that)

and replace

the 24 Vertices of the dual 24-cell with the 96 Golden Ratio Edge Points.

The 24 + 96 = 120 resulting points are the Root Vectors of an H4 600-cell



Fig. A5.1. The $\{3, 3, 5\}$ polytope. Different flat sections in S^3 (with one site on top) give the following successive shells; (a) an icosahedral shell formed by the first 12 neighbours, (b) a dodecahedral shell, (c) a second and larger icosahedral shell, (d) an icosidodecahedral shell on the equatorial sphere. Then other shells are symmetrically disposed in the second 'south' hemi-hypersphere, relative to the equatorial sphere (e).

Sadoc and Mosseri book "Geometrical Frustration"
600-cell = $\{3, 3, 5\}$

For 16-dim Space

Cl(16) has graded structure 0 1 2 3 4 5 6 7 8 9 10 11 12 13 14 15 16 where
 grade 0 = 1 type of 0-dim point
 grade 1 = 16 types of 1-dim line
 grade 2 = 120 types of 2-dim area
 grade 3 = 560 types of 3-dim volume

Cl(16) algebra = 2^{16} = **65,536-dim 256x256 Real Matrices**

Cl(16) 256x256 Matrix Representation

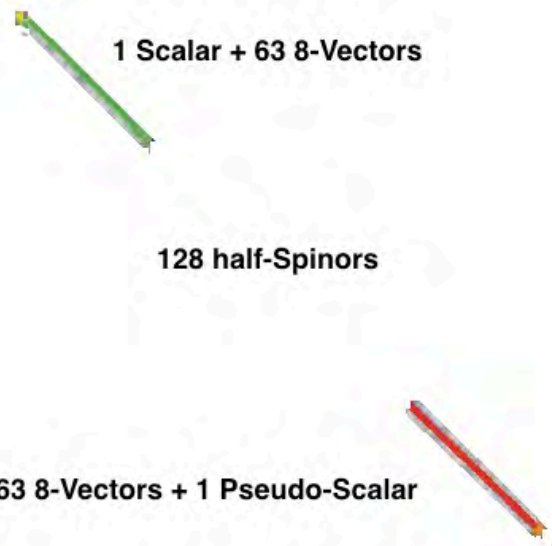
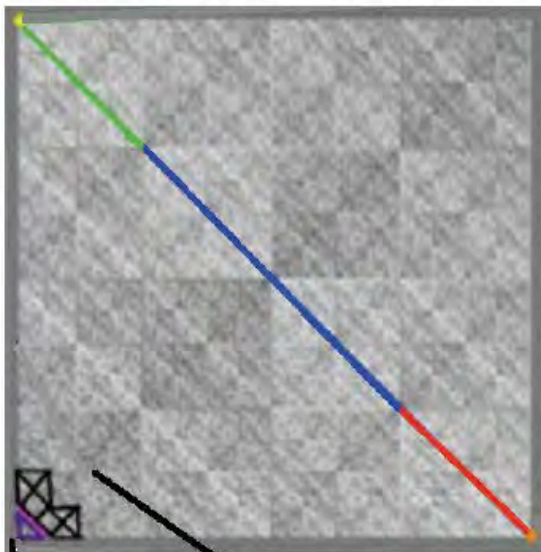

16 Vectors

120 BiVectors

560 TriVectors

120 BiVectors + 128 half-Spinors = 248 E8



$$65,536 - 128 - 120 - 16 - 560 = 64,712$$

Information Carriers

There is an 8-Periodicity of Real Clifford Algebras
 whereby $Cl(8N) = Cl(8) \otimes \dots (N \text{ times tensor product}) \dots \otimes Cl(8)$
 so that in particular $Cl(8) \otimes Cl(8) = Cl(16) =$
 $= M_{16}(R) \otimes M_{16}(R) = M_{256}(R) = 256 \times 256 \text{ Real Matrices}$

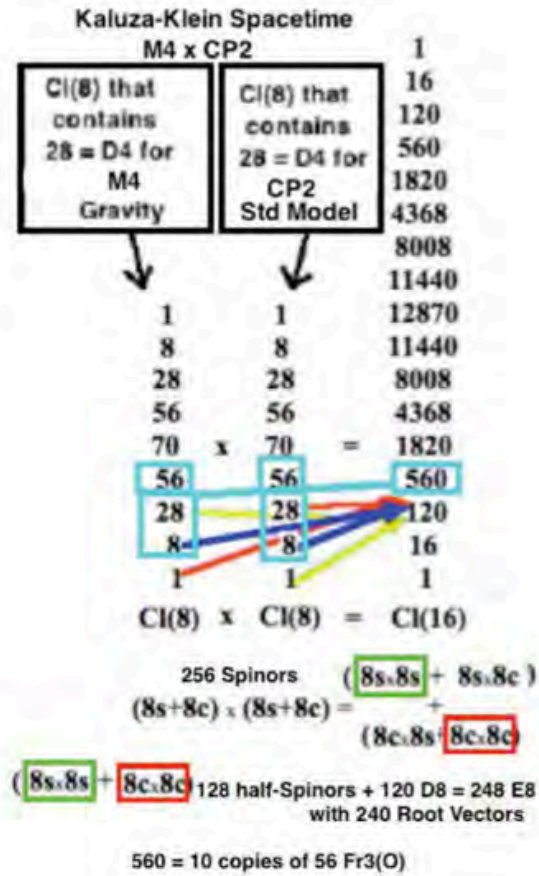

The 2 sets of 120 H4 Root Vectors form the 240 E8 Root Vectors when one H4 is in ordinary 4-dim space and the other is in 4-dim space of algebraic extension by $\sqrt{5}$ and those two 4-dim spaces are combined to form 8-dim E8 Root Vector space. In this 2-dim view (from Coxeter "Regular and Semi-Regular Polytopes III")

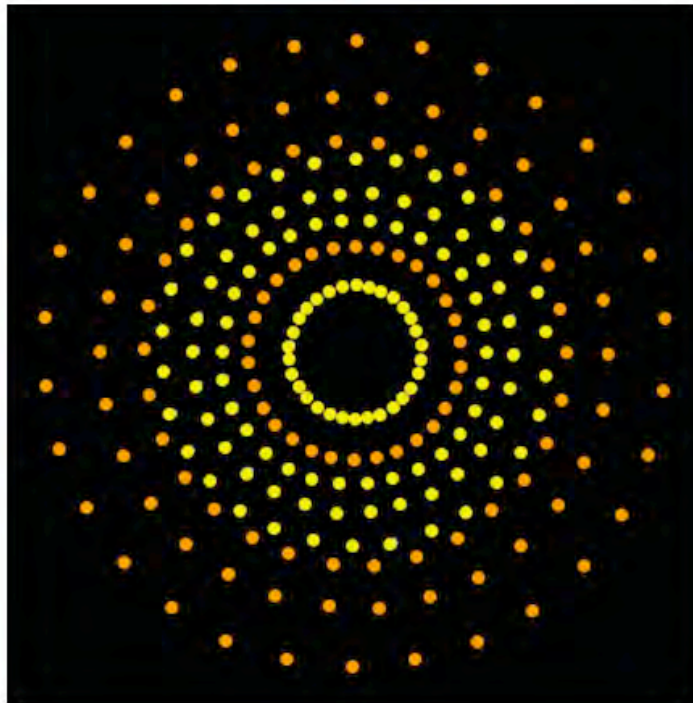

the two H4 sets of 120 are shown in $(4+4) = 8$ circles of 30 Vertices each with the sizes of the two H4 related by the Golden Ratio.

Another 2-dim representation of the 240 E8 Root Vectors by Ray Aschheim is very useful in understanding physical interpretation of E8 Root Vectors:

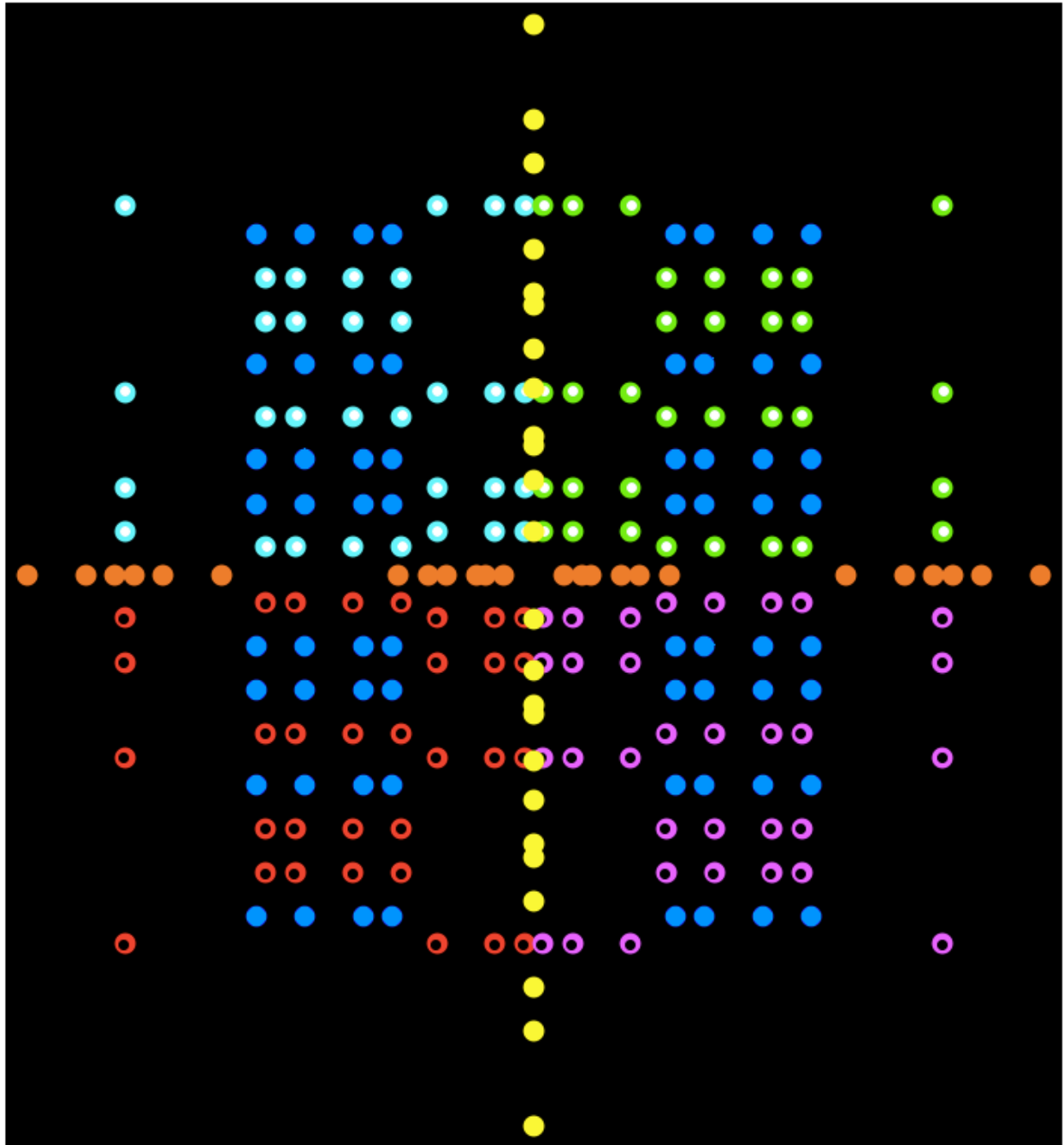

248-dim E8 = 120-dim Spin(16) D8 + 128-dim half-spinor of Spin(16) D8

240 E8 Root Vectors = 112 D8 Root Vectors + 128 D8 half-spinors

112 D8 Root Vectors = 24 D4 (orange) + 24 D4 (yellow) + 64 (blue)

128 D8 half-spinors = 128 elements of E8 / D8

Green and Cyan dots with white centers (32+32 = 64 dots) and

Red and Magenta dots with black centers (32+32 = 64 dots)

correspond to the 128 elements of E8 / D8.

240 = 24 + 24 + 64 + 64 + 64

The 64 Green and Cyan Root Vectors represent half of the First Generation Fermions of E8 / D8.
 The White Centers of their dots indicate that they are Particles.

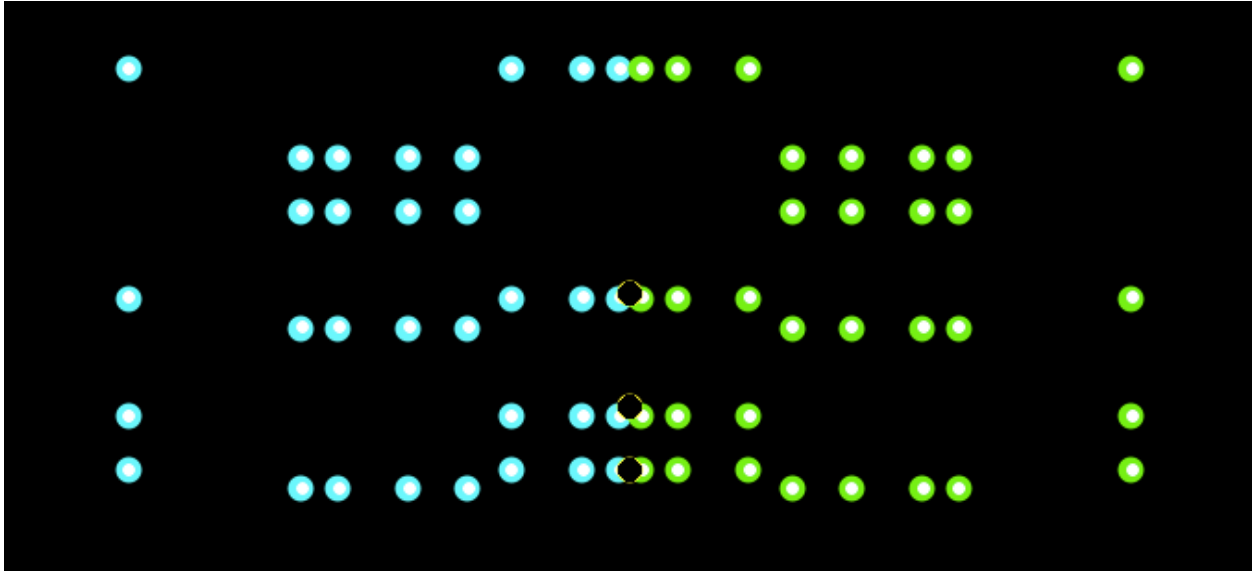

Their physical interpretations are

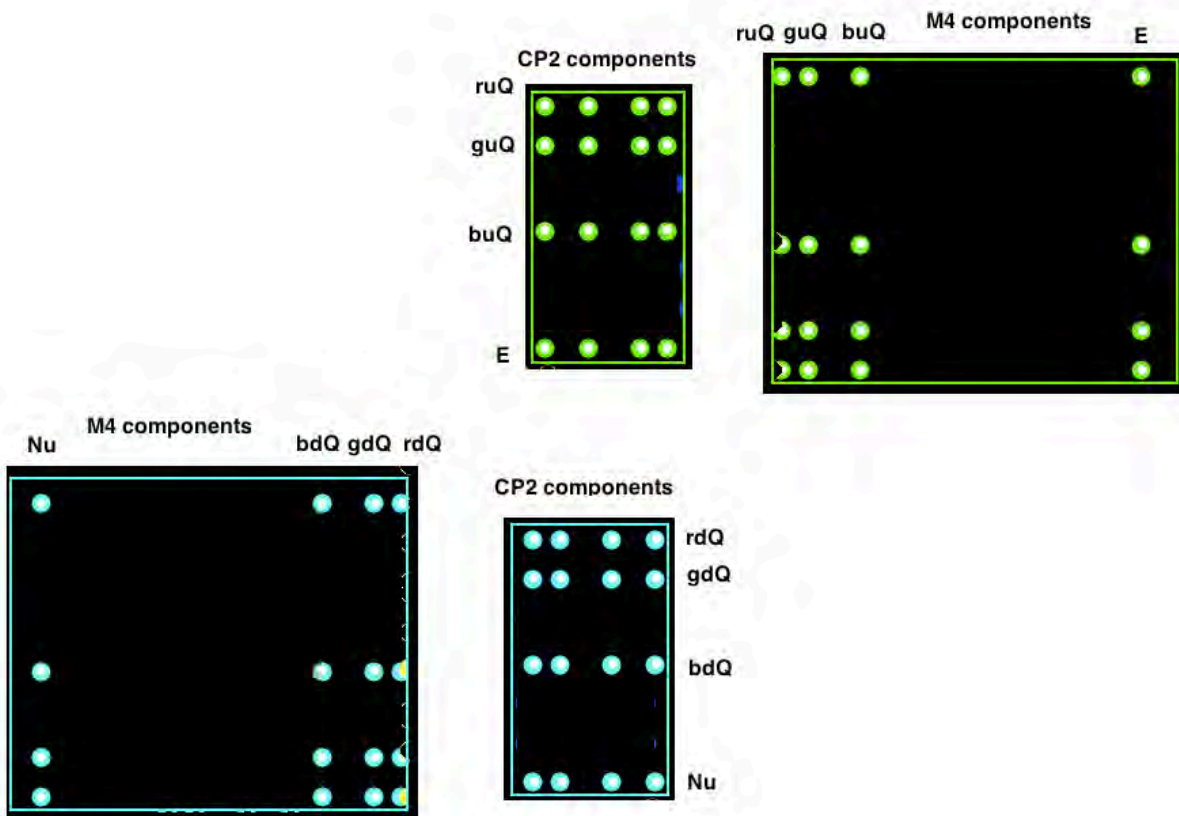

The 64 Red and Magenta Root Vectors represent the other half

of the First Generation Fermions of E8 / D8.
 The Black Centers of their dots indicate that they are AntiParticles.

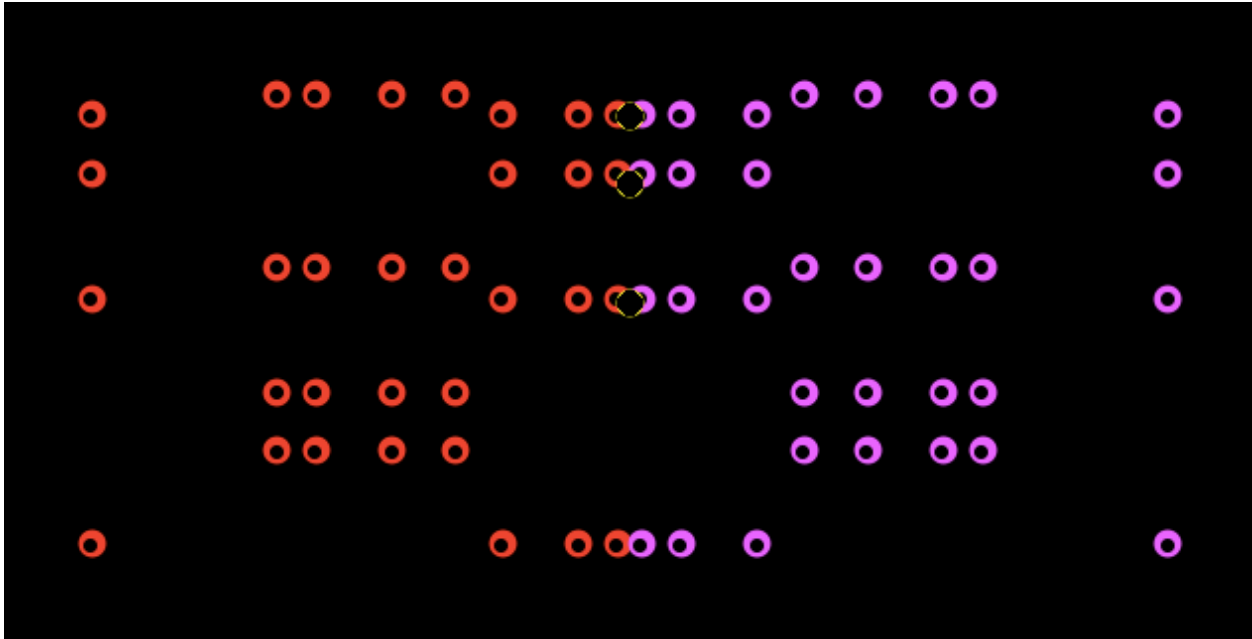

Their physical interpretations are

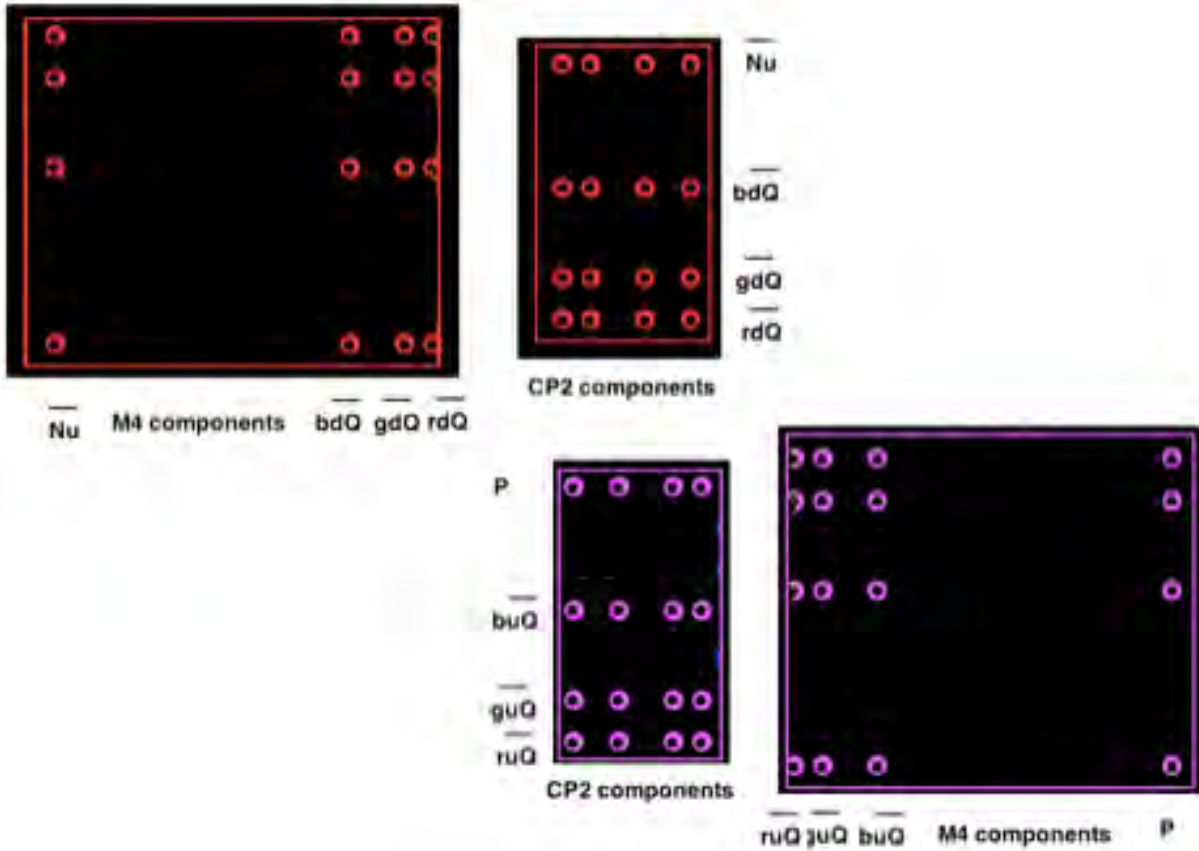

Spacetime, Unimodular Gravity, and Strong CP

The 64 Blue Root Vectors represent
Creation / Annihilation Operators for Planck Cells of 8D Spacetime
represented by $A7+1 = SL(8,R)+R$ of the Maximal Contraction
Heisenberg Algebra of $E8$ with structure $28 + 64 + (A7+1) = 64 + 28$.

(see Rutwig Campoamor-Stursberg in "Contractions of Exceptional Lie Algebras and SemiDirect Products" (Acta Physica Polonica B 41 (2010) 53-77)

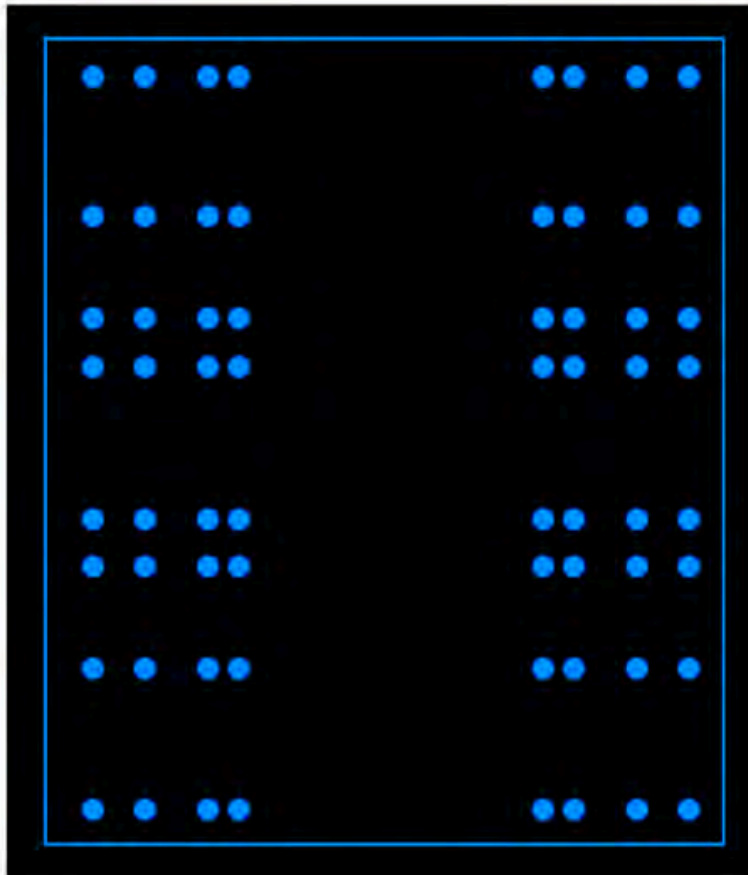

The $4 \times 16 = 64$ blue correspond to the
64-dim symmetric space $D8 / D4 \times D4 = Gr(8,16)$ Grassmannian = set of $RP7$ in $RP15$
They are related by Triality to the 64 + 64 Fermion Components of $E8 / D8$

$A7 = SL(8,R)$ also describes 8-dimensional Unimodular Relativity.
Bradonjic and Stachel in arXiv 1110.2159 said: "... in ... Unimodular relativity ... the metric tensor ... break[s up] ... into the conformal structure represented by a conformal metric ... with $\det = -1$ and a four-volume element ... at each point of space-time ... [that]... may be the remnant, in the ... continuum limit, of a more fundamental discrete quantum structure of space-time itself ...".

In the Initial and Inflation Octonionic Phases of Our Universe

the 64 generators of D8 / D4 x D4 act as an Octonionic Conformal Structure where Spin(0,8) of Cl(0,8) does rotations of 8-dim Octonion Space and Spin(2,8) = Spin(1,9) = SL(2,O) of Cl(2,8) = Cl(1,9) = M(32,R) = M(2,Cl(0,8)) indicates a 10-dim Conformal Spacetime within 26-dim String Theory and an 8-volume element at each point of Octonion Space indicates a fundamental discrete structure of an underlying 26-dim String Theory in which Strings = World-Lines and **a spin-2 particle carries Bohm Quantum Potential.**

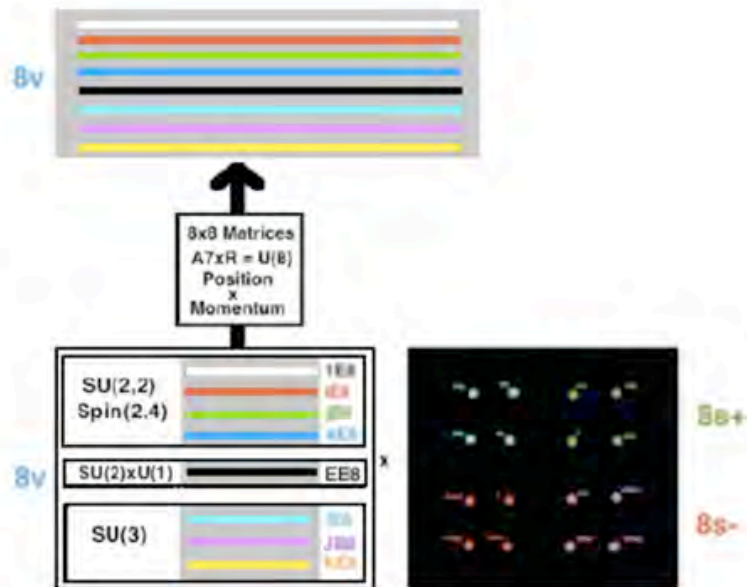

Green, Schwartz, and Witten, in "Superstring Theory" vol. 1, describe 26D String Theory saying "... The first excited level ... consists of ... the ground state ... tachyon ... and ... a scalar ... 'dilaton' ... and ... SO(24) ... little group of a ... massless particle ... and ... **a ... massless ... spin two state** ...".

Unimodular SL(8,R) Gravity effectively describes a generalized checkerboard of 8-dim SpaceTime HyperVolume Elements and, with respect to Cl(16) = Cl(8) ⊗ Cl(8), is the tensor product of the two 8v vector spaces of the two Cl(8) factors of Cl(16). If those two Cl(8) factors are regarded as Fourier Duals, then **8v x 8v describes Position x Momentum in 8-dim SpaceTime.**

In the Post-Inflation Quaternionic Phase of Our Universe

8-dim Octonionic Spacetime splits into (4+4)-dim **M4 x CP2 Kaluza-Klein Spacetime**

M4 underlies a 6-dim Conformal Spacetime of Spin(2,4) = SU(2,2)

where Spin(2,4) = BiVectors of Cl(2,4) = M(4,H) = 4x4 Quaternion Matrices

CP2 = SU(3) / SU(2) x U(1)

carries the Gauge Groups of the Standard Model

Frampton, Ng, and Van Dam in J. Math. Phys. 33 (1992) 3881-3882 said: "... Because of the existence of ... QCD ... instantons the quantized theory contains a dimensionless parameter θ ($0 < \theta < 2\pi$) not explicit in the classical lagrangian. ... **the quantum dynamics of ... unimodular gravity ... may lead to the relaxation of θ to $\theta = 0 \pmod{\pi}$ without the need ... for a new particle ... such as the axion ...".**

The 24 Orange Root Vectors of the D4 of **E8 Standard Model + Gravity Ghosts** are on the Horizontal X-axis.

The 4 Cartan Subalgebra elements of D4 of E8 Standard Model + Gravity Ghosts correspond to half of the 8 Cartan Subalgebra elements of E8.

In the Initial and Inflation Octonionic Phases of Our Universe

the 24+4 = 28 generators of D4 of E8 Standard Model + Gravity Ghosts act as a Spin(8) Gauge Group rotating all 8 Fermion types into each other.



In the Post-Inflation Quaternionic Phase of Our Universe

8-dim Octonionic Spacetime splits into (4+4)-dim M4 x CP2 Kaluza-Klein Spacetime
 8 generators in the Orange Box represent the 8 Root Vectors of the Standard Model Gauge Groups SU(3) SU(2) U(1).

Their 4 Cartan Subalgebra elements correspond to the 4 Cartan Subalgebra elements of D4 of E8 Standard Model + Gravity Ghosts and to half of the 8 Cartan Subalgebra elements of E8.

The other 24-8 = 16 Orange Root Vectors represent Ghosts of 16D U(2,2) which contains the Conformal Group SU(2,2) = Spin(2,4) that produces Gravity + Dark Energy by the MacDowell-Mansouri mechanism.

Standard Model Gauge groups come from CP2 = SU(3) / SU(2) x U(1)
 (as described by Batakis in Class. Quantum Grav. 3 (1986) L99-L105)

Electroweak SU(2) x U(1) is gauge group as isotropy group of CP2.

SU(3) is global symmetry group of CP2 but due to Kaluza-Klein M4 x CP2 structure of compact CP2 at every M4 spacetime point, it acts as Color gauge group with respect to M4.

The $24-8 = 16$ D4 of CP2 Root Vectors represent Ghosts of U(2,2) Conformal Gravity.

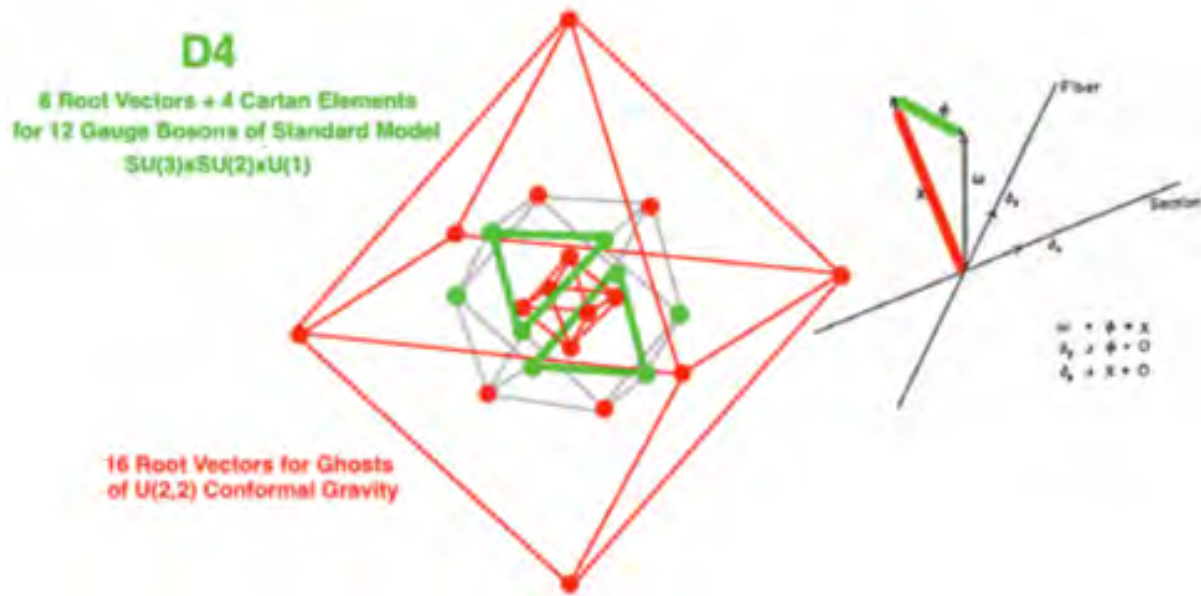

Jean Thierry-Mieg in J. Math. Phys. 21 (1980) 2834-2838 said:

“... The ghost and the gauge field:

The single lines represent a local coordinate system
 of a principal fiber bundle of base space-time.

The double lines are 1 forms.

The connection of the principle bundle w is assumed to be vertical.

Its contravariant components Φ and X are recognized, respectively,
 as the Yang-Mills gauge field and the Faddeev-Popov ghost form ...”.

Steven Weinberg in The Quantum Theory of Fields Volume II Section 15.7 said:

“... there is a beautiful geometric interpretation of the ghosts and the BRST symmetry ...

The gauge fields A_a^μ may be written as one-forms $A_a = A_{a\mu} dx^\mu$, where dx^μ
 are a set of anticommuting c-numbers. ... This can be combined with the ghost to
 compose a one-form $A_a = A_a + w_a$ in an extended space.

Also, the ordinary exterior derivative $d = dx^\mu \partial/\partial x^\mu$ may be combined with the BRST
 operator s to form an exterior derivative $D = d + s$ in this space,
 which is nilpotent because $s^2 = d^2 = sd + ds = 0$...”.



The 24 Yellow Root Vectors of the D4 of E8 Gravity + Standard Model Ghosts are on the Vertical Y-axis.

The 4 Cartan Subalgebra elements of D4 of E8 Gravity + Standard Model Ghosts correspond to half of the 8 Cartan Subalgebra elements of E8.

In the Initial and Inflation Octonionic Phases of Our Universe

the 24+4 = 28 generators of D4 of E8 Gravity + Standard Model Ghosts act as a Spin(8) Gauge Group rotating all 8 dimensions of Octonionic Spacetime into each other.

In the Post-Inflation Quaternionic Phase of Our Universe

8-dim Octonionic Spacetime splits into (4+4)-dim M4 x CP2 Kaluza-Klein Spacetime
 12 generators in the Yellow Box represent the 12 Root Vectors of the Conformal Gauge Group SU(2,2) = Spin(2,4) of Conformal Gravity + Dark Energy

The 4 Cartan Subalgebra elements of SU(2,2)xU(1) = U(2,2) correspond to the 4 Cartan Subalgebra elements of D4 of E8 Gravity + Standard Model Ghosts and to the other half of the 8 Cartan Subalgebra elements of E8.

The other 24-12 = 12 Yellow Root Vectors represent Ghosts of 12D Standard Model whose Gauge Groups are SU(3) SU(2) U(1)

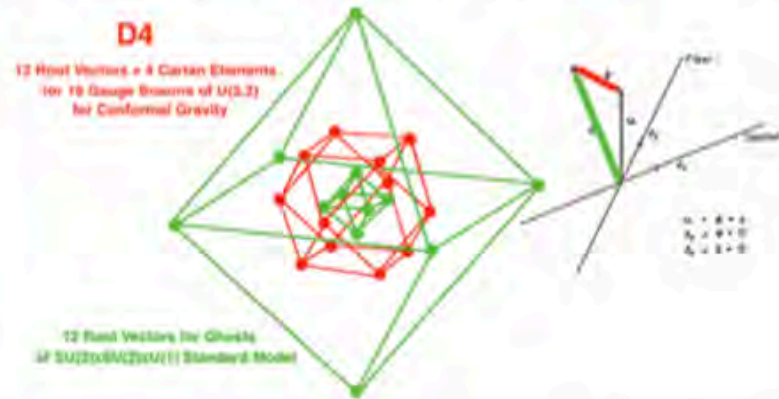

Gravity and Dark Energy come from D4 Conformal Subgroup SU(2,2) = Spin(2,4)

SU(2,2) = Spin(2,4) has 15 generators:

- 1 Dilation representing Higgs Ordinary Matter
- 4 Translations representing Primordial Black Hole Dark Matter
- 10 = 4 Special Conformal + 6 Lorentz representing Dark Energy
 (see Irving Ezra Segal, "Mathematical Cosmology and Extragalactic Astronomy" (Academic 1976))

The basic ratio Dark Energy : Dark Matter : Ordinary Matter = 10.4:1 = 0.67 : 0.27 : 0.06
 When the dynamics of our expanding universe are taken into account, the ratio is calculated to be **0.75 : 0.21 : 0.04**

CI(16) 256x256 Matrix Representation

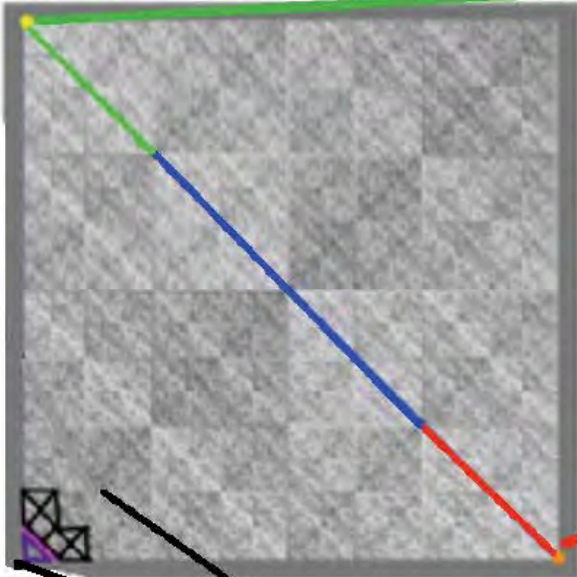

8 Components of 8 Fermion Particles

8 Components of 8 Fermion AntiParticles

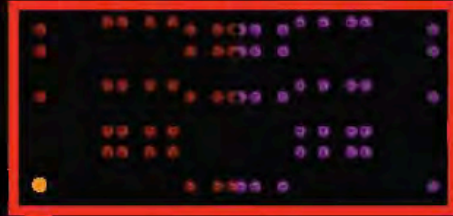

E8 / D8
Spinor Fermions

CI(16) Vectors
BiVectors TriVectors



Fr3(O)
Zorn-type matrices
R J3(O)
J3(O) R

Second D4

Standard Model Gauge Bosons
Gravity + Dark Energy Ghosts
propagator phase Ghost

Lie Ball: Spin(2,8) / Spin(1,7)xU(1)
Shilov Bdy Lie Sphere: RP1 x S7

M4 CP2

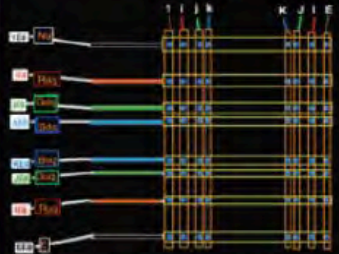

D8 / D4xD4
Base Manifold

First D4

Gravity + Dark Energy Gauge Bosons
propagator phase
Standard Model Ghosts

Cl(16) Physics

Basic Structure of Cl(16) and Cl(1,25) Physics:

Cl(16) Vectors = Spacetime = Shilov Boundary of Lie Ball Complex Domain

Cl(16) BiVectors and half-Spinors = E8 = Gauge Bosons and Fermions
Classical Lagrangian

E8 = Cl(16) BiVectors and half-spinor has 3 Real Forms
corresponding to the Stages of Evolution of Our Universe:
(VOID Quantum Fluctuation, Octonionic Inflation, Quaternionic Expansion)

Cl(16) TriVectors = 10 copies of Fr3(O) for 10 Spacetimes in Superposition
= 26D String=World-Line Theory
whose traceless symmetric spin-2 part = Bohm Quantum Potential

Completion of Union of all tensor products of Cl(1,25) = AQFT =
= Algebraic Quantum Field Theory = Real Clifford Algebra analogue of
Hyperfiniteness von Neumann factor of Complex Clifford Fock Space

CI(16) Vectors = Spacetime

CI(16) Vector Spacetime Geometry has 8-Complex-dim Structure
 $8+8 = 16$ -real dimensional D5 / D4 x U(1) Lie Sphere Symmetric Space Type BDI
 with

8-complex-dim Bounded Complex Domain Type IV(8)
 whose Imaginary Part is
the interior of the Lie Ball Bounded Complex Domain of Type IV(8)
 which represents the Spirit World in which
 the unit lattice cells have structure of CI(16) with 65,536 elements

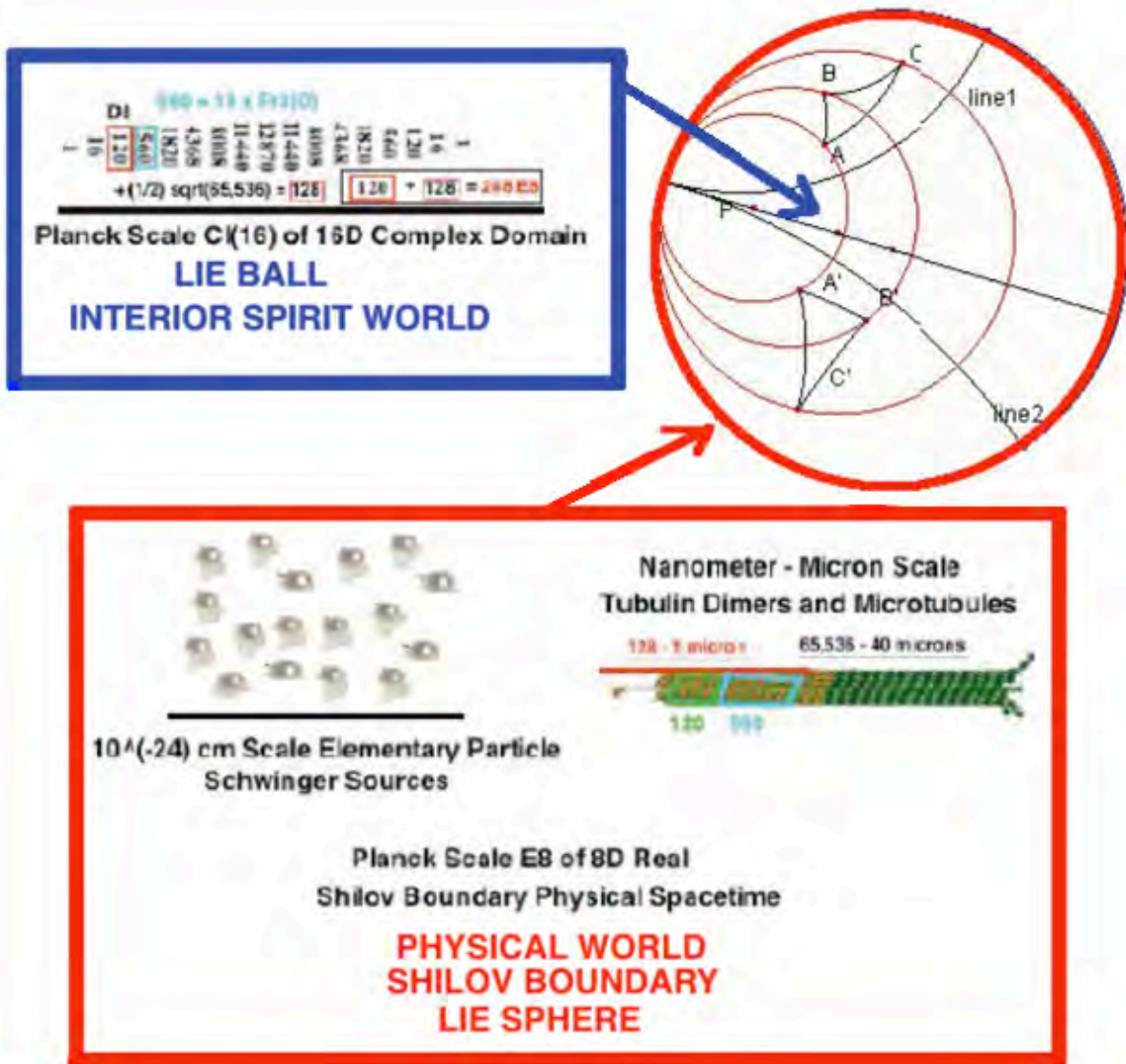

and
 whose Real Part is the Shilov Boundary = 8-real-dim RP1 x S7

which represents the $M4 \times CP2$ Kaluza-Klein Spacetime $M4 \times CP2$
($M4 =$ Minkowski and $CP2 = SU(3) / SU(2) \times U(1)$)
which represents the Earthly World
in which Human Consciousness is based on Microtubules with 65,536 Tubulin Dimers



The **Bounded Complex Domain Lie Ball Interior Spirit World**
is related to
the **Shilov Boundary Lie Sphere Physical World**
by the **Poisson Kernel**.

Cl(16) BiVectors and half-Spinors = Gauge Bosons and Fermions

240 Root Vectors of E8

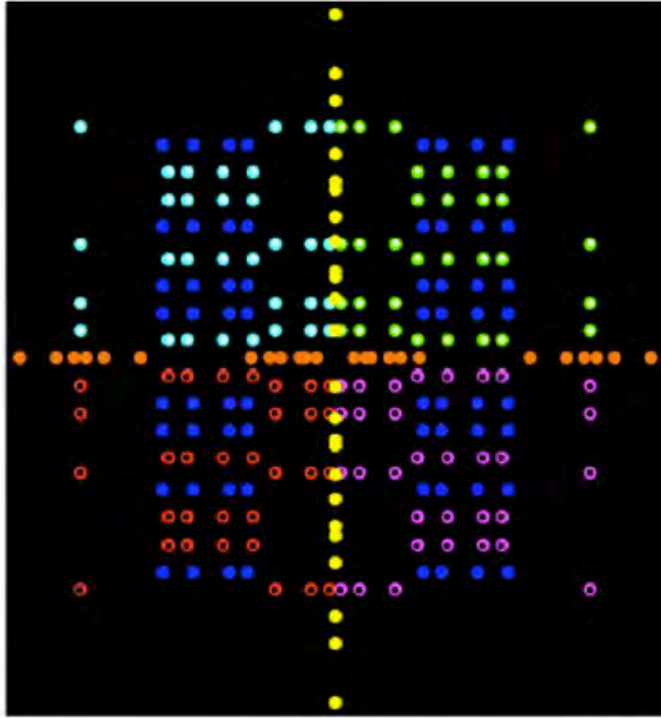

are made up of

120 H4 of M4

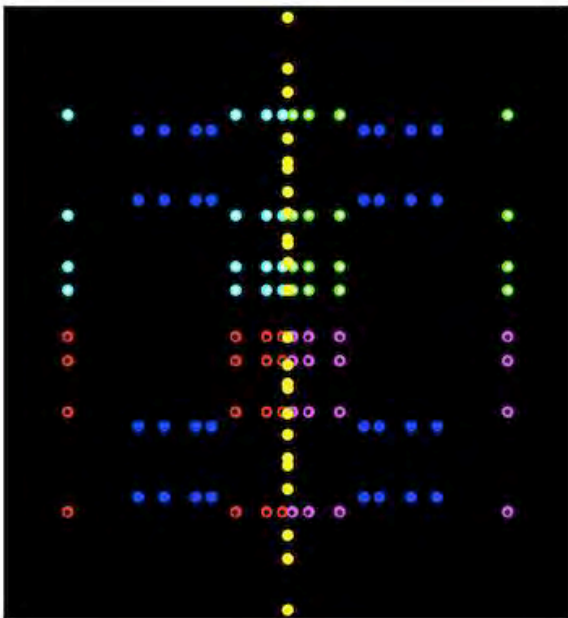

120 H4 of CP2

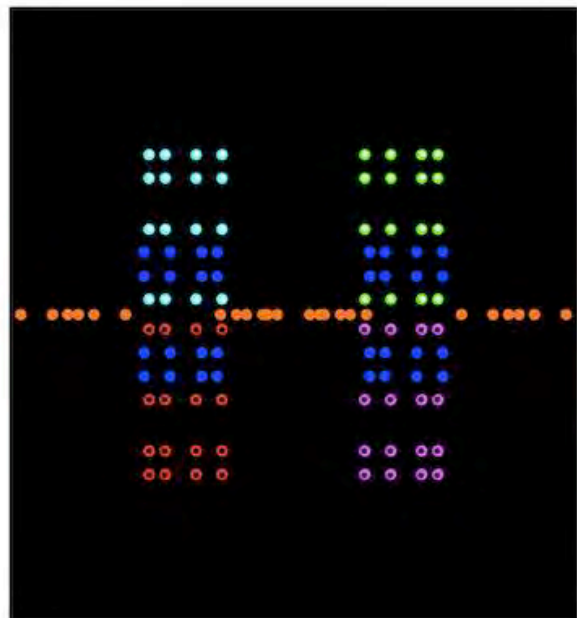

CI(16) Lagrangian

CI(16) Lagrangian in terms of E8 Root Vectors:

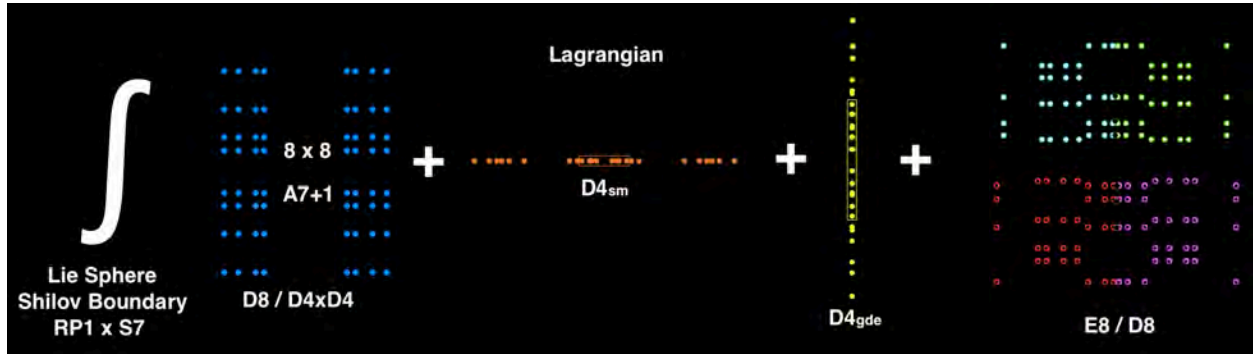

The following page has a larger image of the Lagrangian which page is followed by more details about the Base Manifold and the Density.

The **Base Manifold** is the 8-dim **Shilov Boundary** of the 16-dim **CI(16) Vectors**

The **CI(16) Vector space** is the **Lie Ball Spin(10) / Spin(8) x U(1)**
and
the **Shilov Boundary** is the **Lie Sphere RP1 x S7** with Octonionic structure

The **Lagrangian Density** terms are based on the structure of E8 =
= **CI(16) BiVectors + half-Spinors**

E8 / D8 = 128-dim half-spinors of CI(16) = Fermion Particles and AntiParticles

D8 / D4xD4 = A7+R creation / annihilation operators for 8-dim Spacetime

D4 = 28 Spin(8) generators acting as 8-dim gauge bosons

D4 = 28 Spin(8) generators acting as 8-dim gauge bosons

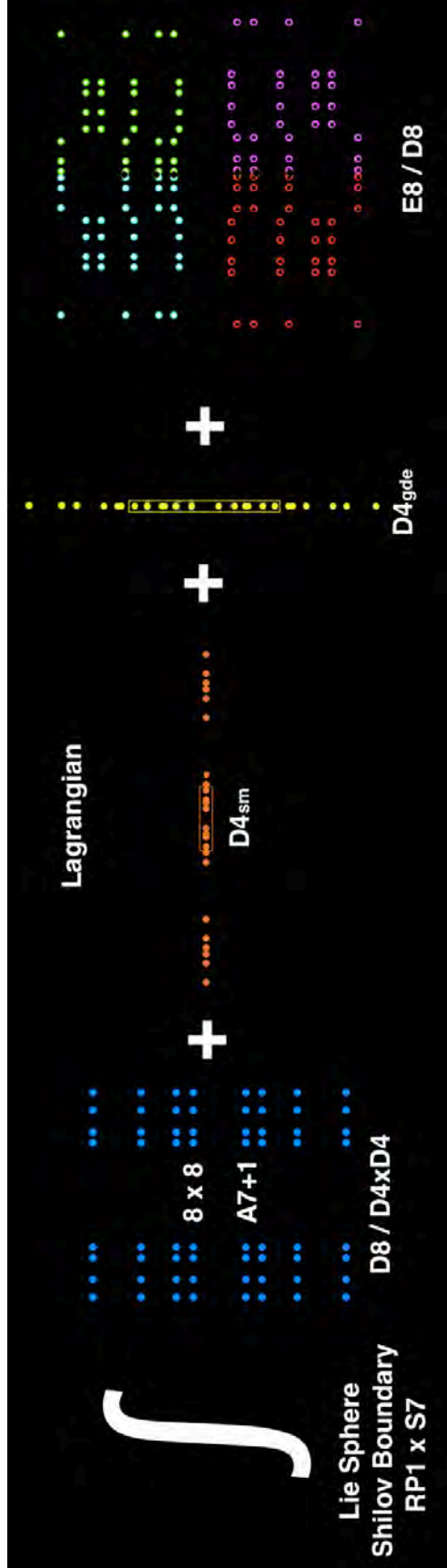

Base Manifold

The **Base Manifold** is the 8-dim Shilov Boundary of the 16-dim Vector space of $Cl(16)$.

The **Vector space is the Lie Ball $Spin(10) / Spin(8) \times U(1)$**
 and the **Shilov Boundary is the Lie Sphere $RP^1 \times S^7$** with Octonionic structure
 1-dim Real Part $Re(O)$ + 7-dim Imaginary Part $Im(O)$ so

Since $Im(O)$ contains a 3-dim associative submanifold
 plus an orthogonal 4-dim coassociative submanifold
 the 8-dim base manifold is made up of two 4-dim parts:

Associative = $Re(O)$ + Associative Submanifold of $Im(O)$
 Coassociative = Coassociative Submanifold of $Im(O)$

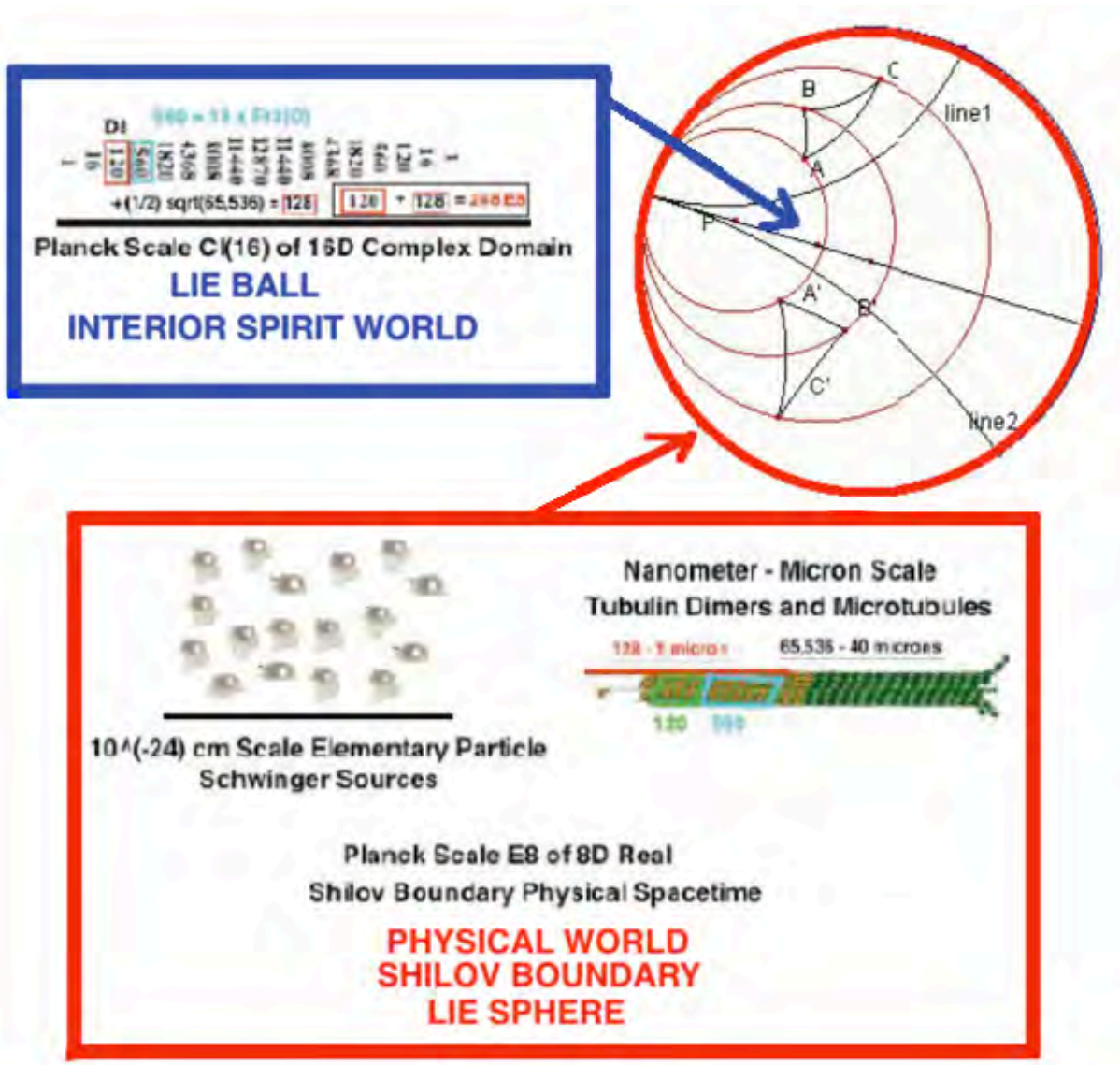

Lagrangian Density



The 10 dimensions of the Vector Space of Spin(10) account for 10 of the 26 dimensions of 26D String=World-Line Theory. 8 of those 10 dimensions, the Shilov Boundary, are Octonionic 8-dim Spacetime that becomes Quaternionic $M4 \times CP2$ Kaluza-Klein at low (relative to Planck) energies.

The $26-10 = 16$ dimensions correspond to orbifold representations of 8 First-Generation Fermion Types: 8 Particles + 8 Antiparticles each with 8 components.

They give the **Lagrangian Density terms labelled E8 / D8**

Weinberg showed in Dirac lecture: each fermion has weight $7/2$ in the 8-dim Lagrangian

The **Lagrangian Density terms labelled D4gde** are the 24 Root Vectors of one of the two 28-dim D4 acting as 8-dim gauge bosons.

Weinberg showed in Dirac lecture: each gauge boson has weight 1 in the Lagrangian

The **Lagrangian Density terms labelled D4sm** are the 24 Root Vectors of the other of the two 28-dim D4 acting as 8-dim gauge bosons.

Weinberg showed in Dirac lecture each gauge boson has weight 1 in the Lagrangian

Since **$(8+8)$ fermions $\times 7/2 = 56 = 28$ gauge bosons $\times 1 + 28$ gauge bosons $\times 1$** there is a subtle fermion-gauge boson supersymmetry leading to ultraviolet finiteness.

The **Lagrangian Density terms labelled D8 / D4xD4** are $8 \times 8 = 64$ dimensions =
 = 8 Fermion Types x (8 Octonion Basis Elements = 8 E8 Lattices)
 There are 8 algebraically independent E8 Lattices, 7 of which are Integral Domains
 corresponding to the 7 Imaginary Octonions and to the 7 massive Fermion Types
 and 1 of which corresponds to the Real Octonion Axis and to Neutrino-Type Fermions
 which are tree-level-massless.

The physical 8-dim Octonionic Spacetime is a Superposition of those 8 E8 Lattices
 in which each Fermion Type propagates in its own E8 Lattice.

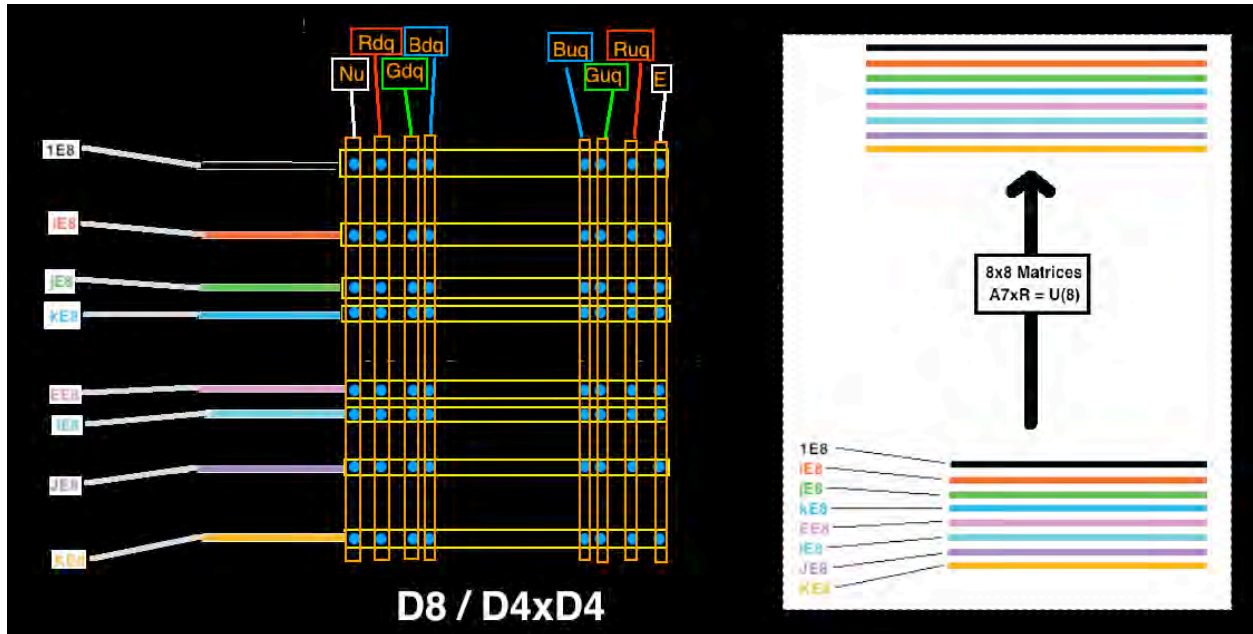

The $8 \times 8 = 64$ -element D8 / D4xD4 structure is $A7+R = SL(R,8) + 1$
 which is the grade-0 part of the Heisenberg Algebra = Maximal Contraction of E8
 with graded structure $28 + 64 + (A7+1) + 64 + 28$
 The $28 + 64 + 64 + 28$ part is already in the Lagrangian
 as creation / annihilation operators for gauge bosons and fermions.
 The $A7+1$ part is creation / annihilation operators for spacetime and
 equivalently $A7 = SL(R,8)$ describes a Unimodular Gravity-like structure of Spacetime

One $Cl(1,25)$ containing one $Cl(0,16)$ containing one E_8 gives a Lagrangian description of one local spacetime neighborhood. To get a realistic global spacetime structure, take the tensor product $Cl(1,25) \otimes \dots \otimes Cl(1,25)$ with all E_8 local 8-dim Octonionic spacetimes consistently aligned as described by [64-dim D8 / D4xD4 \(blue dots\)](#) (this visualization hexagonal 2D projection of the 240 E_8 root vectors).

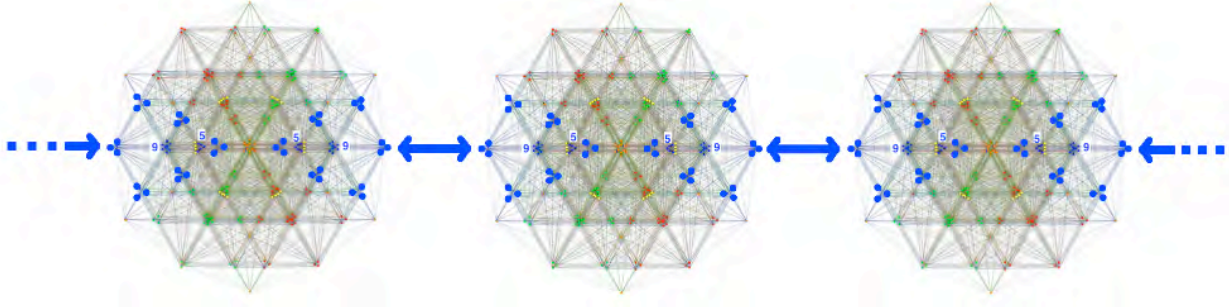

which then fill up spacetime according to Gray Code Hilbert's curves:

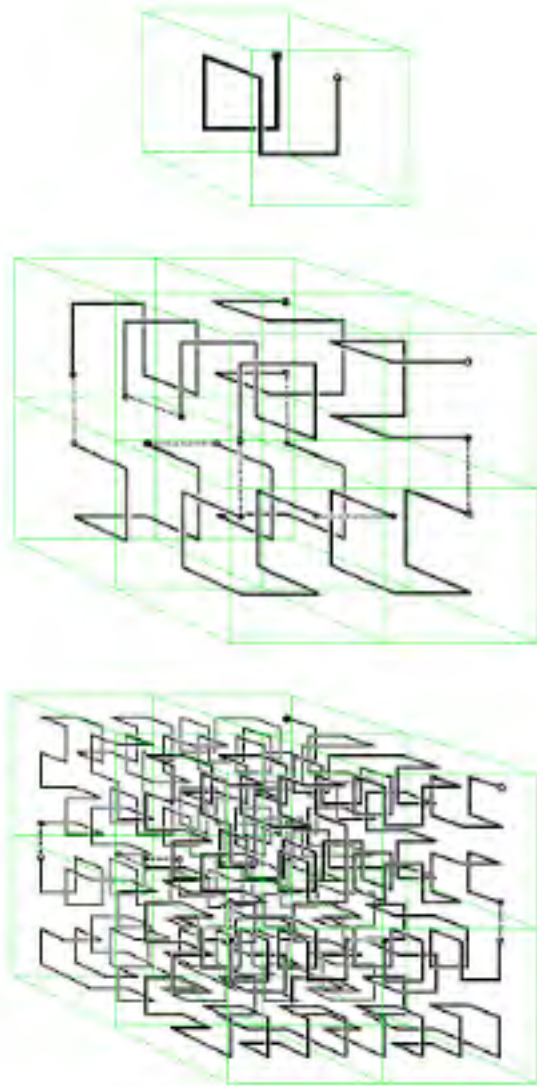

Our Universe emerged from its parent in Octonionic Inflation



As Our Parent Universe expanded to a Cold Thin State Quantum Fluctuations occurred. Most of them just appeared and disappeared as Virtual Fluctuations, but at least one Quantum Fluctuation had enough energy to produce 64 Unfoldings and reach Paola Zizzi's State of Decoherence thus making it a Real Fluctuation that became Our Universe.

As Our Universe expands to a Cold Thin State, it will probably give birth to Our Child, GrandChild, etc, Universes.

Unlike "the inflationary multiverse" described by Andrei Linde in arXiv 1402.0526 as "a scientific justification of the anthropic principle", in the $CI(16)$ $CI(1,25)$ E8 model ALL Universes (Ours, Ancestors, Descendants) have the SAME Physics Structure as E8 Physics (viXra 1312.0036 and 1310.0182)

In the $CI(1,25)$ E8 model, our SpaceTime remains Octonionic 8-dimensional throughout inflation.

Stephen L. Adler in his book Quaternionic Quantum Mechanics and Quantum Fields (1995) said at pages 50-52, 561: "... If the multiplication is associative, as in the complex and quaternionic cases, we can remove parentheses in ... Schroedinger equation dynamics ... to conclude that ... the inner product $\langle f(t) | g(t) \rangle$... is invariant ... this proof fails in the octonionic case, and hence one cannot follow the standard procedure to get a unitary dynamics. ...[so there is a]... **failure of unitarity in octonionic quantum mechanics** ...".

Creation-Annihilation Operators are the 64-dim grade-0 part of the E8 Maximal Contraction generalized Heisenberg Algebra

$$h_{92} \times A_7 = 28 + 64 + ((SL(8,R)+1) + 64 + 28$$

The NonAssociativity and Non-Unitarity of Octonions accounts for particle creation without the need for a conventional inflaton field.

E8 Physics has Representation space for 8 Fermion Particles + 8 Fermion Antiparticles on the original Cl(1,25) E8 Local Lagrangian Region



where a Fermion Representation slot _ of the 8+8 = 16 slots can be filled

by Real Fermion Particles ■ or Real Fermion Antiparticles ■

IF the Quantum Fluctuation(QF) has enough Energy to produce them as Real and

IF the Cl(1,25) E8 Local Lagrangian Region has an Effective Path from its QF Energy to that Particular slot.

Let Cl(16) = Cl(8) \otimes Cl(8) contained in Cl(1,25) where the first Cl(8) contains the D4 of Conformal Gravity with actions on M4 physical spacetime whose CPT symmetry determines the property matter - antimatter.

Consider, following basic ideas of Geoffrey Dixon related to his characterization of 64-dimensional spinor spaces as C \otimes H \otimes O (C = complex, H = quaternion, O = octonion), 64-dim 64s⁺⁺ = 8s⁺ \otimes 8s⁺ of Cl(8) \otimes Cl(8) = Cl(16)

and

64-dim 64s⁻⁻ = 8s⁻ \otimes 8s⁻ of Cl(8) \otimes Cl(8) = Cl(16)

so that

64s⁺⁺ + 64s⁻⁻ = 128s^(++ + --) are +half-spinors of Cl(16) that are in E8

Then Cl(16) contains

128-dim (++ + --)half-spinor space 64s⁺⁺ + 64s⁻⁻ of Cl(16) in E8 that preserve Fermion Particle-AntiParticle type of the Initial Parent Universe Vacuum Fluctuation and

128-dim -half-spinor space 64s⁺⁻ + 64s⁻⁺ of Cl(16) not in E8 = Fermion AntiGeneration which due to +- -+ mixing would create a self-annihilating Particle-AntiParticle mixture.

Since E8 contains only the pure 128 (++ + --)half-spinors and none of the mixing 128 (+- + -+)half-spinors of Cl(16),

if the Parent Universe is dominated by +Particles,

then the Initial QF Cell will be dominated by +Particles

and the 128s^(++ + --) = 64s⁺⁺ + 64s⁻⁻ will have only Effective Paths of QF Energy that go to the Fermion Particle slots that are also of type +

that is, to the 8 Fermion Particle Representation slots



Next, consider the first Unfolding step of Octonionic Inflation. It is based on all 16 = 8 Fermion Particle slots + 8 Fermion Antiparticle Representation slots whether or not they have been filled by QF Energy.

7 of the 8 Fermion Particle slots correspond to the 7 Imaginary Octonions and therefore to the 7 Independent E8 Integral Domain Lattices and

therefore to 7 New $CI(1,25)$ E8 Local Lagrangian Regions.

The 8th Fermion Particle slot corresponds to the 1 Real Octonion and therefore to the 8th E8 Integral Domain Lattice (not independent - see Kirmse's mistake) and therefore to the 8th New $CI(1,25)$ E8 Local Lagrangian Region.

Similarly, the 8 Fermion Antiparticle slots Unfold into 8 more New New $CI(1,25)$ E8 Local Lagrangian Regions, so that one Unfolding Step is a 16-fold multiplication of $CI(1,25)$ E8 Local Lagrangian Regions:

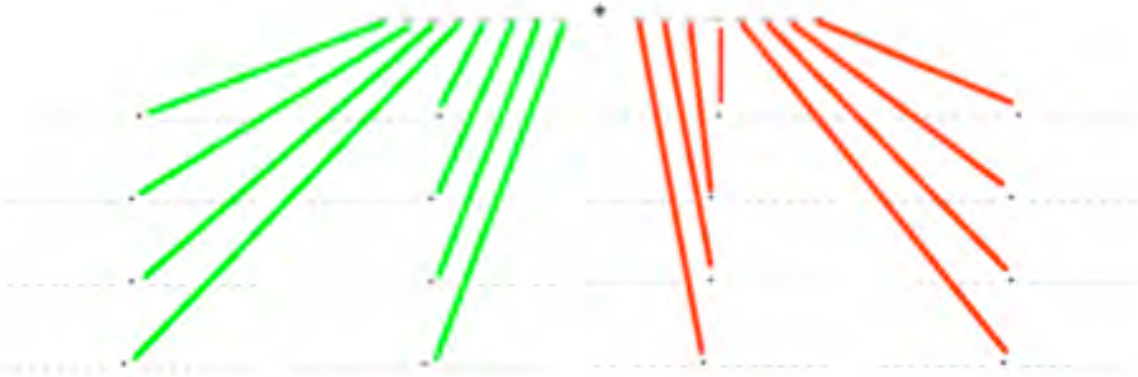

If the Initial QF Cell is dominated by +Particles then, since there is no mixing by E8 $64(++ + --)$ half-Spinors, the Fermion Particle content after the first Unfolding is



so it is clear that the Octonionic Inflation Unfolding Process

creates Fermion Particles with no Antiparticles,

thus explaining the dominance of Matter over AntiMatter in Our Universe.

If the E8 half-Spinors had been mixing $64(+ - + -)$ then Particles = AntiParticles and the Universe would have annihilated itself.

Each Unfolding has duration of the Planck Time T_{planck}

and none of the components of the Unfolding Process Components are simultaneous, so that the total duration of N Unfoldings is $2^N T_{\text{planck}}$.

Paola Zizzi in gr-qc/0007006 said: "... during inflation,

the universe can be described as a superposed state of quantum ... [qubits].

the self-reduction of the superposed quantum state is ... reached at the end of

inflation ...[at]... the decoherence time ... [$T_{\text{decoh}} = 10^9 T_{\text{planck}} = 10^{(-34)}$ sec] ...

and corresponds to a superposed state of ... [$10^{19} = 2^{64}$ qubits]. ...".

Why decoherence at 64 Unfoldings = 2^{64} qubits ?

2^{64} qubits corresponds to the Clifford algebra $Cl(64) = Cl(8 \times 8)$.

By the periodicity-8 theorem of Real Clifford algebras, $Cl(64)$ is the smallest Real Clifford algebra for which we can reflexively identify each component $Cl(8)$

with a vector in the $Cl(8)$ vector space. This reflexive identification/reduction causes our universe to decohere at $N = 2^{64} = 10^{19}$

which is roughly the number of Quantum Consciousness Tubulins in the Human Brain.

The Real Clifford Algebra $Cl(8)$ is the basic building block of Real Clifford Algebras due to 8-Periodicity whereby $Cl(8N) = Cl(8) \times \dots (N \text{ times tensor product}) \dots \times Cl(8)$

An Octonionic basis for the $Cl(8)$ 8-dim vector space is $\{1, i, j, k, E, I, J, K\}$

NonAssociativity, NonUnitarity, and Reflexivity of Octonions is exemplified by

the 1-1 correspondence between Octonion Basis Elements and $E8$ Integral Domains

$$1 \Leftrightarrow 0E8$$

$$i \Leftrightarrow 1E8$$

$$j \Leftrightarrow 2E8$$

$$k \Leftrightarrow 3E8$$

$$E \Leftrightarrow 4E8$$

$$I \Leftrightarrow 5E8$$

$$J \Leftrightarrow 6E8$$

$$K \Leftrightarrow 7E8$$

where $1E8, 2E8, 3E8, 4E8, 5E8, 6E8, 7E8$ are 7 independent Integral Domain $E8$ Lattices and $0E8$ is an 8th $E8$ Lattice (Kirmse's mistake) not closed as an Integral Domain.

Using that correspondence expands the basis $\{1, i, j, k, E, I, J, K\}$ to

$$\{0E8, 1E8, 2E8, 3E8, 4E8, 5E8, 6E8, 7E8\}$$

Each of the $E8$ Lattices has 240 nearest neighbor vectors so the total dimension of the Expanded Space is $240 \times 240 \times 240 \times 240 \times 240 \times 240 \times 240 \times 240$

Everything in the Expanded Space comes directly from the original $Cl(8)$ 8-dim space so all Quantum States in the Expanded Space can be held in Coherent Superposition.

However,

if further expansion is attempted, there is no direct connection to original $Cl(8)$ space and any Quantum Superposition undergoes Decoherence.

If each 240 is embedded reflexively into the 256 elements of $Cl(8)$ the total dimension is

$$256 \times 256 \times 256 \times 256 \times 256 \times 256 \times 256 \times 256 = 256^8 = 2^{(8 \times 8)} = 2^{64} =$$

$$= Cl(8) \times Cl(8) \times Cl(8) \times Cl(8) \times Cl(8) \times Cl(8) \times Cl(8) \times Cl(8) = Cl(8 \times 8) = Cl(64)$$

so the largest Clifford Algebra that can maintain Coherent Superposition is $Cl(64)$

which is why Zizzi Quantum Inflation ends at the $Cl(64)$ level.

At the end of 64 Unfoldings, Non-Unitary Octonionic Inflation ended having produced about $(1/2) 16^{64} = (1/2) (2^4)^{64} = 2^{255} = 6 \times 10^{76}$ Fermion Particles

The End of Inflation time was at about $10^{(-34)}$ sec = 2^{64} Tplanck

and

the size of our Universe was then about $10^{(-24)}$ cm

which is about the size of a Fermion Schwinger Source Kerr-Newman Cloud.

Bohm Quantum Potential with Sarfatti Back-Reaction and AQFT as Third Grothendieck Universe

The First Grothendieck Universe is the Empty Set.

**The Second Grothendieck Universe is Hereditarily Finite Sets such as a
Generalized Feynman Checkerboard Quantum Theory
based on E8 Lattices and Discrete Cl(1,25) Clifford Algebra.**

**The Third Grothendieck Universe is the Completion of Union of all tensor
products of Cl(1,25) Real Clifford algebra**

Since the Cl(1,25) E8 Lagrangian is Local and Classical,
it is necessary to patch together Local Lagrangian Regions to form a Global Structure
describing a Global Cl(1,25) E8 Algebraic Quantum Field Theory (AQFT).

The usual Hyperfinite II₁ von Neumann factor for creation and annihilation operators on
Fermionic Fock Space over $C^{(2n)}$ is constructed by completion of the union of all
tensor products of 2x2 Complex Clifford algebra matrices, which have Periodicity 2,
so for the Cl(1,25) E8 model based on Real Clifford Algebras with Periodicity 8,
Cl(1,25) = 2x2 matrices of Cl(0,24) where Cl(0,24) = Cl(0,8) x Cl(0,8) x Cl(0,8),
the completion of the union of all tensor products of Cl(1,25)
produces a generalized Hyperfinite II₁ von Neumann factor
that gives the Cl(1,25) E8 model a natural Algebraic Quantum Field Theory.

In other words, consider E8 to be Local Classical
and embed E8 into the real Clifford Algebra Cl(0,16)
and use 8-Periodicity to form the Completion of the Union of all Tensor Products of
Cl(0,16) which produces a natural realistic Algebraic Quantum Field Theory (AQFT).
The structure is related to unconventional 26D String Theory by

$$\text{Cl}(0,16) \rightarrow \text{Cl}(0,16) \times \text{Cl}(0,8) = \text{Cl}(0,24) \rightarrow M(2, \text{Cl}(0,24)) = \text{Cl}(1,25)$$

where $M(2, \text{Cl}(0,24)) = 2 \times 2$ matrices with entries in Cl(0,24) and \times = tensor product.

Cl(0,24) contains the Vector Space of the 24-dim Leech Lattice Λ_{24} that is composed of
3 copies of E8 Lattices (2 being Integral Domains and 1 not Algebraically closed)
Since all the matrix entries are Cl(0,24) = tensor product of 3 copies of Cl(0,8)
8-Periodicity allows formation of the tensor products of copies of Cl(1,25) and therefore
the Completion of Union of All Tensor Products of Cl(1,25)
which is the String Theory formulation of the hyperfinite AQFT
with Real / Octonionic structure inherited from Cl(0,8) and also Quaternionic structure
due to Cl(1,25) = Cl(1,9) x Cl(0,8) x Cl(0,8) and Cl(1,9) = Cl(1,5) x Cl(0,4) =
= Cl(2,4) x Cl(0,4) where the vector space of Cl(2,4) is 6-dim Conformal Spacetime
(see "Clifford Algebras and the Classical Groups" by Ian Porteous
and his Chapter 2 of "Lectures on Clifford (Geometric) Algebras and Applications")

The overall structure of $Cl(160-E8)$ AQFT is similar to the Many-Worlds picture described by David Deutsch in his 1997 book "The Fabric of Reality" said (pages 276-283): "... there is no fundamental demarcation between snapshots of other times and snapshots of other universes ... Other times are just special cases of other universes ... Suppose ... we toss a coin ... Each point in the diagram represents one snapshot

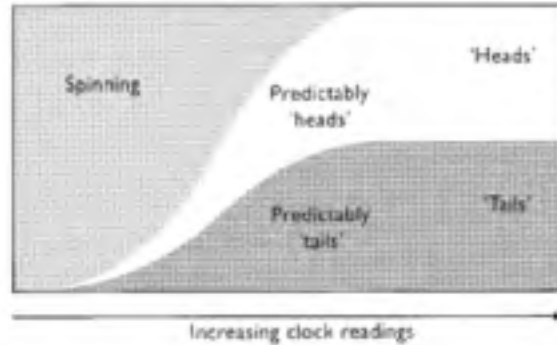

... in the multiverse there are far too many snapshots for clock readings alone to locate a snapshot relative to the others. To do that, we need to consider the intricate detail of which snapshots determine which others. ...

in some regions of the multiverse, and in some places in space, the snapshots of some physical objects do fall, for a period, into chains, each of whose members determines all the others to a good approximation ...".

The Real Clifford Algebra $Cl(1,25)$ containing $E8$ for the Local Lagrangian of a Region is equivalent to a "snapshot" of the Deutsch "multiverse".

The completion of the union of all tensor products of all $Cl(1,25)$ $E8$ Local Lagrangian Regions forms a generalized hyperfinite II_1 von Neumann factor AQFT and emergently self-assembles into a structure = Deutsch multiverse.

For the $Cl(1,25)$ $E8$ model AQFT to be realistic, it must be consistent with EPR entanglement relations. Joy Christian in arXiv 0904.4259 said: "... a [geometrically] correct local-realistic framework ... provides exact, deterministic, and local underpinnings ... The alleged non-localities ... result from misidentified [geometries] of the EPR elements of reality. ... The correlations are ... the classical correlations [such as those] among the points of a 3 or 7-sphere ... S^3 and S^7 ... are ... parallelizable ... The correlations ... can be seen most transparently in the elegant language of Clifford algebra ...".

Since $E8$ is a Lie Group and therefore parallelizable and lives in Clifford Algebra $Cl(1,25)$, **the $Cl(1,25)$ $E8$ model is consistent with EPR.**

The Creation-Annihilation Operator structure of $Cl(1,25)$ E8 AQFT is given by the Maximal Contraction of E8 = semidirect product $A7 \times h92$ where $h92 = 92+1+92 = 185$ -dim Heisenberg algebra and $A7 = 63$ -dim $SL(8)$ The Maximal E8 Contraction $A7 \times h92$ can be written as a 5-Graded Lie Algebra

$$28 + 64 + (SL(8,R) + 1) + 64 + 28$$

$$\text{Central Even Grade } 0 = SL(8,R) + 1$$

The 1 is a scalar and $SL(8,R) = Spin(8) + \text{Traceless Symmetric } 8 \times 8 \text{ Matrices}$, so $SL(8,R)$ represents a local 8-dim SpaceTime in Polar Coordinates.

$$\text{Odd Grades } -1 \text{ and } +1 = 64 + 64$$

Each = $64 = 8 \times 8 = \text{Creation/Annihilation Operators for 8 components of 8 Fundamental Fermions}$.

$$\text{Even Grades } -2 \text{ and } +2 = 28 + 28$$

Each = Creation/Annihilation Operators for 28 Gauge Bosons of Gravity + Standard Model.

The $Cl(1,25)$ E8 AQFT inherits structure from the $Cl(1,25)$ - 8 Local Lagrangian

$$\int \text{Gauge Gravity} + \text{Standard Model} + \text{Fermion Particle-AntiParticle}$$

8-dim SpaceTime .

The $Cl(1,25)$ -E8 generalized Hyperfinite II1 von Neumann factor Algebraic Quantum Field Theory is based on the Completion of the Union of all Tensor Products of the form

$$Cl(1,25) \times \dots (N \text{ times tensor product}) \dots \times Cl(1,25)$$

For $N = 2^8 = 256$ the copies of $Cl(1,25)$ are on the 256 vertices of the 8-dim HyperCube



For $N = 2^{16} = 65,536 = 4^8$ the copies of $Cl(1,25)$ fill in the 8-dim HyperCube as described by William Gilbert's web page: "... The n-bit reflected binary Gray code will describe a path on the edges of an n-dimensional cube that can be used as the initial stage of a Hilbert curve that will fill an n-dimensional cube. ...".

The vertices of the Hilbert curve are at the centers of the 2^8 sub-8-HyperCubes whose edge lengths are $1/2$ of the edge lengths of the original 8-dim HyperCube

As N grows, the copies of $Cl(1,25)$ continue to fill the 8-dim HyperCube of E_8 SpaceTime

using higher Hilbert curve stages from the 8-bit reflected binary Gray code subdividing the initial 8-dim HyperCube into more and more sub-HyperCubes.

If edges of sub-HyperCubes, equal to the distance between adjacent copies of $Cl(1,25)$, remain constantly at the Planck Length, then the

full 8-dim HyperCube of our Universe expands as N grows to 2^{16} and beyond

similarly to the way shown by this 3-HyperCube example for $N = 2^3, 4^3, 8^3$

from William Gilbert's web page:



**The Union of all $Cl(1,25)$ tensor products is
the Union of all subdivided 8-HyperCubes
and**

**their Completion is a huge superposition of 8-HyperCube Continuous Volumes
which Completion belongs to the Third Grothendieck Universe.**

AQFT Quantum Code

Cerf and Adami in quantum-ph/9512022 describe virtual qubit-anti-qubit pairs (they call them ebit-anti-ebitpairs) that are related to negative conditional entropies for quantum entangled systems and are similar to fermion particle-antiparticle pairs. Therefore quantum information processes can be described by particle-antiparticle diagrams much like particle physics diagrams and

the Algebraic Quantum Field Theory of the $Cl(1,25)$ E8 Physics Model should have a Quantum Code Information System that is based on structure of a unit cell in 26D String Theory represented by Real Clifford Algebra $Cl(0,8) \times Cl(0,8) \times Cl(0,8) = Cl(0,24)$
(see Appendix - Details of World-Line String Bohm Quantum Theory)

Since Quantum Reed-Muller code $[[256, 0, 24]]$ corresponds to Real Clifford Algebra $Cl(0,8)$

Tensor Product Quantum Reed-Muller code $[[256, 0, 24]]$ x $[[256, 0, 24]]$ x $[[256, 0, 24]]$ corresponds to

AQFT (Algebraic Quantum Field Theory) hyperfinite von Neumann factor algebra that is Completion of the Union of All Tensor Products of $Cl(1,25)$

Quantum Reed-Muller code $[[256, 0, 24]]$ is described in quantum-ph/9608026 by Steane as mapping a quantum state space of 256 qubits into 256 qubits, correcting $((24-1)/2) = 11$ errors, and detecting $24/2 = 12$ errors.

Let $C(n,t) = n! / t! (n-t)!$

Then

$[[256, 0, 24]]$ is of the form

$$\begin{aligned} & [[2^n, \quad 2^n - C(n,t) - 2 \sum_{0 \leq k \leq t-1} C(n,k), \quad 2^t + 2^{t-1}]] \\ & [[2^8, \quad 2^8 - C(8,4) - 2 \sum_{0 \leq k \leq 3} C(8,k), \quad 2^4 + 2^{4-1}]] \\ & [[2^8, \quad 2^8 - 70 - (1+8+28+56) - (1+8+28+56), \quad 16 + 8]] \\ & [[256, \quad 256 - (1+8+28+56+70+56+28+8+1), \quad 16 + 8]] \\ & [[256, \quad 16 \times 16 - \sum_{0 \leq k \leq 8} 8! / 8^{k-1} \cdot (k) \cdot 16, \quad 16 + 8]] \end{aligned}$$

The quantum code $[[256, 0, 24]]$ can be constructed from the classical Reed-Muller code (256, 93, 32) of the form

$$\begin{aligned} & (2^8, \quad 2^8 - \sum_{0 \leq k \leq t} C(n,k), \quad 2^{t+1}) \\ & (2^8, \quad 2^8 - \sum_{0 \leq k \leq 4} C(n,k), \quad 2^5) \\ & (2^8, \quad 2^8 - (70+56+28+8+1), \quad 32) \\ & (2^8, \quad 1+8+28+56, \quad 32) \end{aligned}$$

To construct the quantum code $[[256, 0, 24]]$:

First, form a quantum code generator matrix

from the 128×256 generator matrix G of the classical code $(256, 93, 32)$:

$$\begin{array}{c} | \quad | \quad | \\ | G | 0 | \\ | \quad | \quad | \\ | 0 | G | \\ | \quad | \quad | \end{array}$$

Second, form the generator matrix of a quantum code of distance 16

by adding to the quantum generator matrix a matrix D_x such that

G and D_x together generate the classical Reed-Muller code $(256, 163, 16)$:

$(2^8, 1+8+28+56+70, 16)$:

$$\begin{array}{c} | \quad | \quad | \\ | G \quad | 0 | \\ | \quad | \quad | \\ | 0 \quad | G | \\ | \quad | \quad | \\ | D_x \quad | 0 | \\ | \quad | \quad | \end{array}$$

This quantum code has been made by combining the classical codes

$(256, 93, 32)$ and $(256, 163, 16)$, so that it is of the form

$$[[256, 93 + 163 - 256, \min(32, 16)]] = [[256, 0, 16]] .$$

It is close to what we want, but has distance 16.

For the third and final step, increase the distance to $16+8 = 24$

by adding D_z to the quantum generator matrix:

$$\begin{array}{c} | \quad | \quad | \\ | G | 0 | \\ | \quad | \quad | \\ | 0 | G | \\ | \quad | \quad | \\ | D_x | D_z | \\ | \quad | \quad | \end{array}$$

This is the generator matrix of the quantum code $[[256, 0, 24]]$

as constructed by Steane.

The two classical Reed-Muller codes used to build $[[256, 0, 24]]$ are $(256, 163, 32)$ and $(256, 93, 16)$, classical Reed-Muller codes of orders 4 and 3, which are dual to each other. Due to the nested structure of Reed-Muller codes, they contain the Reed-Muller codes of orders 2, 1, and 0 :

Classical Reed-Muller Codes of Length $2^8 = 256$	Order
$(256, 1+8+28+56+70+56+28+8+1, 1)$	8
$(256, 1+8+28+56+70+56+28+8, 2)$	7
$(256, 1+8+28+56+70+56+28, 4)$	6
$(256, 1+8+28+56+70+56, 8)$	5
$(256, 1+8+28+56+70, 16)$	4
$(256, 1+8+28+56, 32)$	3
$(256, 1+8+28, 64)$	2
$(256, 1+8, 128)$	1
$(256, 1, 256)$	0

In the Lagrangian of the $CI(1,25)$ E8 Physics Model

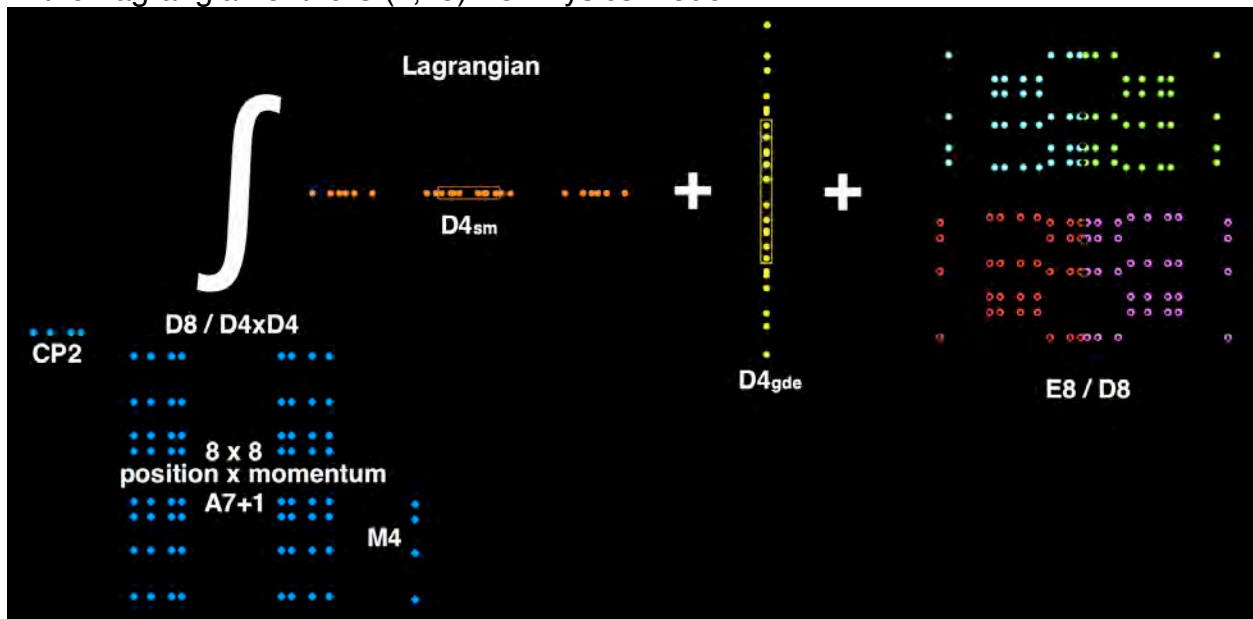

the Higgs scalar prior to dimensional reduction corresponds to the 0th order classical Reed-Muller code $(256, 1, 256)$, the classical repetition code;

the 8-dimensional vector spacetime

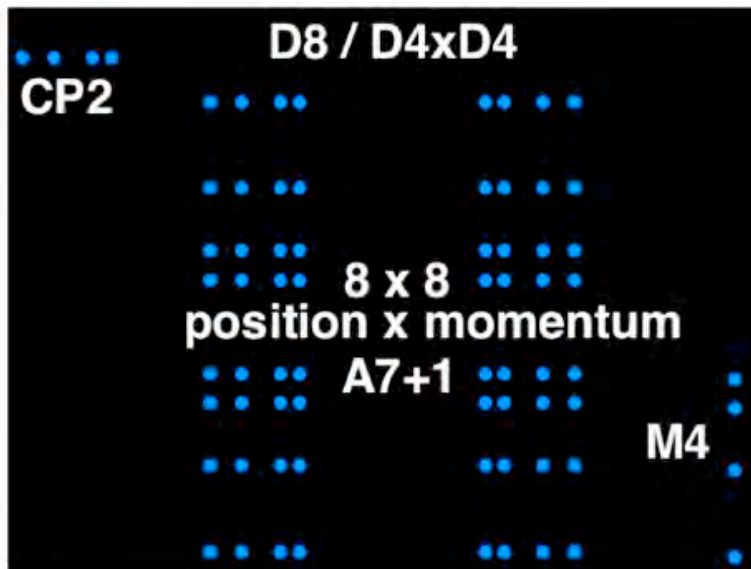

prior to dimensional reduction corresponds to non-0th-order part of the 1st order classical Reed-Muller code (256, 9, 128), which is dual to the 6th order classical Reed-Muller code (256, 247, 4), which is the extended Hamming code, extended from the binary Hamming code (255, 247, 3), which is dual to the simplex code (255, 8, 128) ;

the 28-dimensional bivector adjoint gauge boson spaces

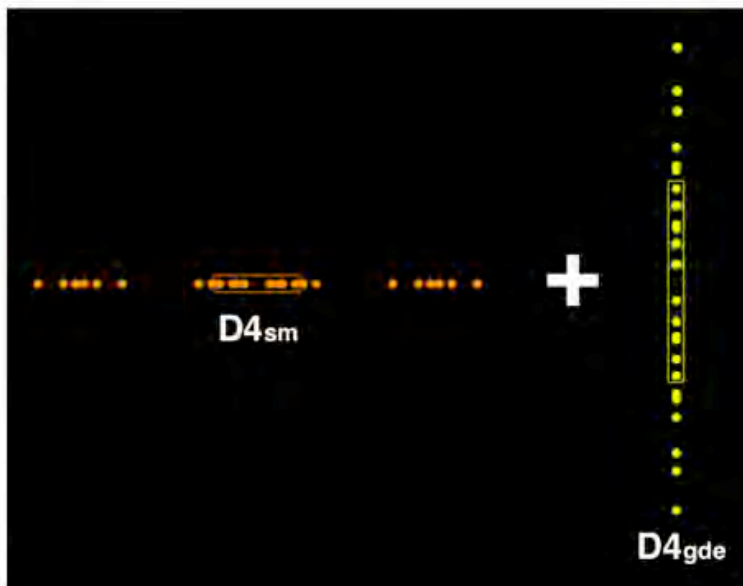

prior to dimensional reduction correspond to the non-1st-order part of the 2nd order classical Reed-Muller code (256, 37, 64) .

The 8 first generation fermion particles and 8 first generation fermion antiparticles of the 16-dim full spinor representation of the 256-dimensional $Cl(0,8)$ Clifford algebra

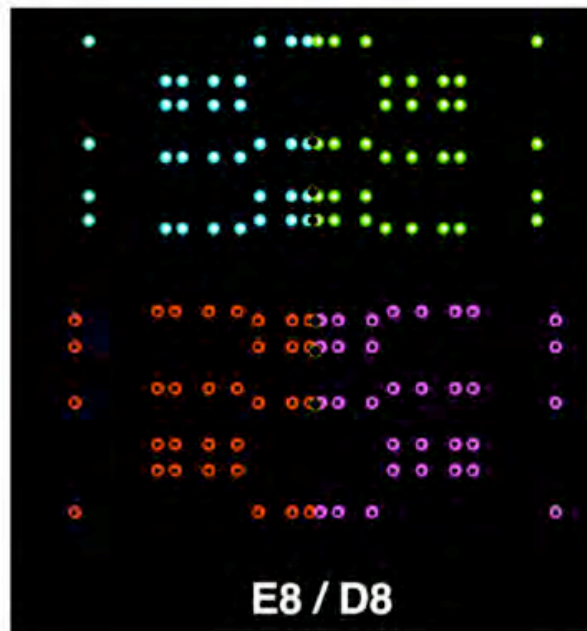

correspond to the distance of the classical Reed-Muller code (256, 93, 16), and to the 16-dimensional Barnes-Wall lattice Λ_{16} , which lattice comes from the (16,5,8) Reed-Muller code. Each Λ_{16} vertex has 4320 nearest neighbors.

The other 8 of the $16+8 = 24$ distance of the quantum Reed-Muller code $[[256, 0, 24]]$ corresponds to the 8-dimensional vector spacetime, and to the 8-dimensional E_8 lattice which comes from the (8,4,4) Hamming code, with weight distribution $0(1) 4(14) 8(1)$. It can also be constructed from the repetition code (8,1,1).

The dual of (8,1,1) is (8,7,2), a zero-sum even weight code, containing all binary vectors with an even number of 1s.

Each E_8 lattice vertex has 240 nearest neighbors. In Euclidean R_8 , there is only one way to arrange 240 spheres so that they all touch one sphere, and only one way to arrange 56 spheres so that they all touch a set of two spheres in contact with each other, and so forth, giving the following classical spherical codes:

(8,240,1/2), (7,56,1/3), (6,27,1/4), (5,16,1/5), (4,10,1/6), and (3,6,1/7).

(If you use an Octonion Integral Domain instead of Euclidean R_8 without multiplication then there are 7 algebraically independent ways to arrange the 240 spheres.)

The total 24 distance of the quantum Reed-Muller code $[[256, 0, 24]]$

corresponds to the 24-dimensional Leech lattice,

and to the classical extended Golay code (24, 12, 8)

in which lattice each vertex has 196,560 nearest neighbors. In Euclidean R_{24} , there is only one way to arrange 196,560 spheres so that they all touch one sphere, and only one way to arrange 4600 spheres so that they all touch a set of two spheres in contact with each other, and so forth, giving the following classical spherical codes: (24,196560,1/2), (23,4600,1/3), (22,891,1/4), (21,336,1/5), (20,170,1/6),

Octonionic to Quaternionic Transition at End of Inflation

To make contact with conventional physics see what happens at the End of Inflation when Octonionic Structure is broken to Quaternionic.

First the Base Manifold goes from Octonionic Lie Sphere Shilov Boundary $RP1 \times S7$

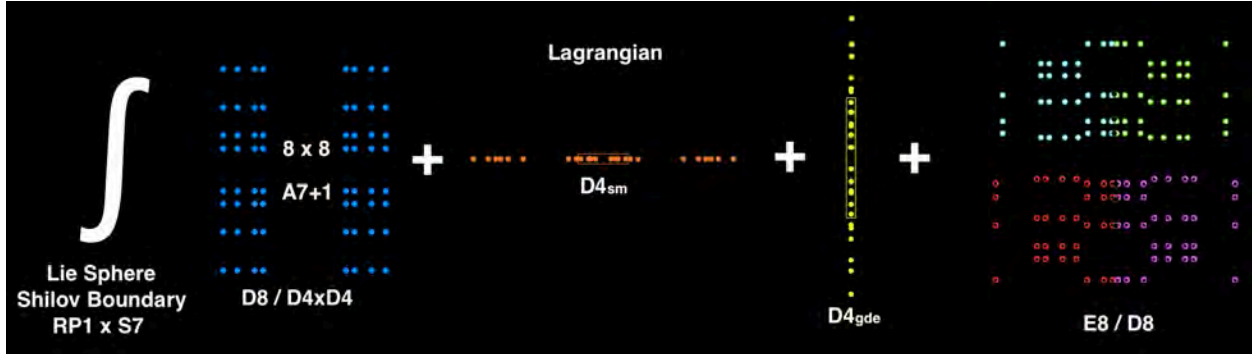

to Quaternionic $M4 \times CP2$ with $M4 =$ Lie Sphere Shilov Boundary $RP1 \times S3$
and $CP2 = SU(3) / SU(2) \times U(1)$



which causes the 8 algebraically independent Octonionic $E8$ Lattices = $D+8$ Lattices to collapse into one Quaternionic $D+4$ Hyperdiamond Lattice = $Z4$ Lattice the even vertices of which are a $D4$ Lattice = Integral Quaternions

(Note that in the $D+4$ Lattice each power-of-2 layer of norm 2^n has 24 vertices whereas the $E8$ Lattices has not that periodicity.)

so that the $D8 / D4 \times D4$ term in the 8-dim Lagrangian goes away

Then the Octonionic base manifold splits into its Associative and Coassociative parts as Kaluza-Klein $M4 \times CP2$ which geometrically produces the Higgs and the Second and Third Generations of fermions as shown on the following page:

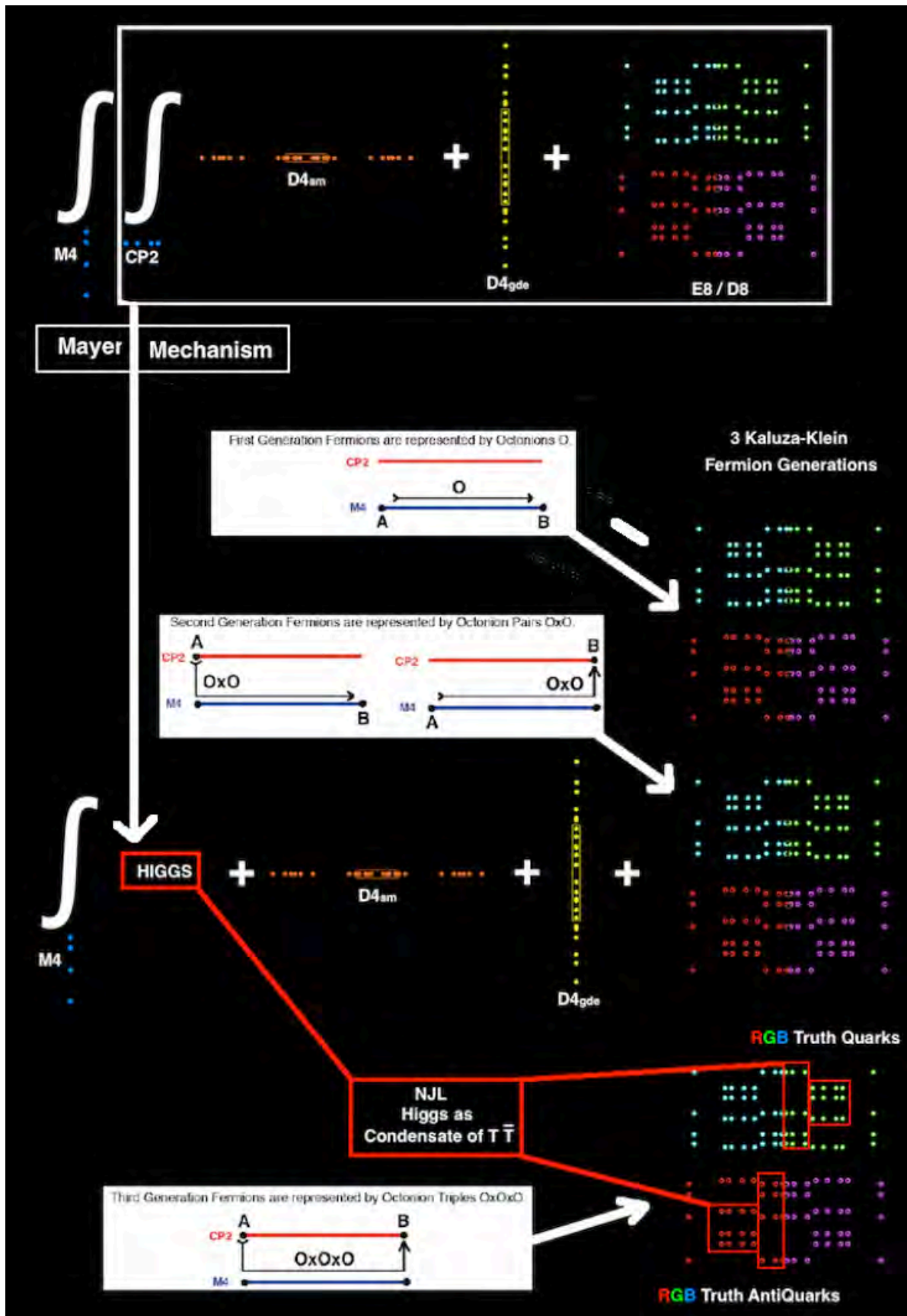

Nambu - Jona-Lasinio Truth Quark-AntiQuark Condensate Higgs

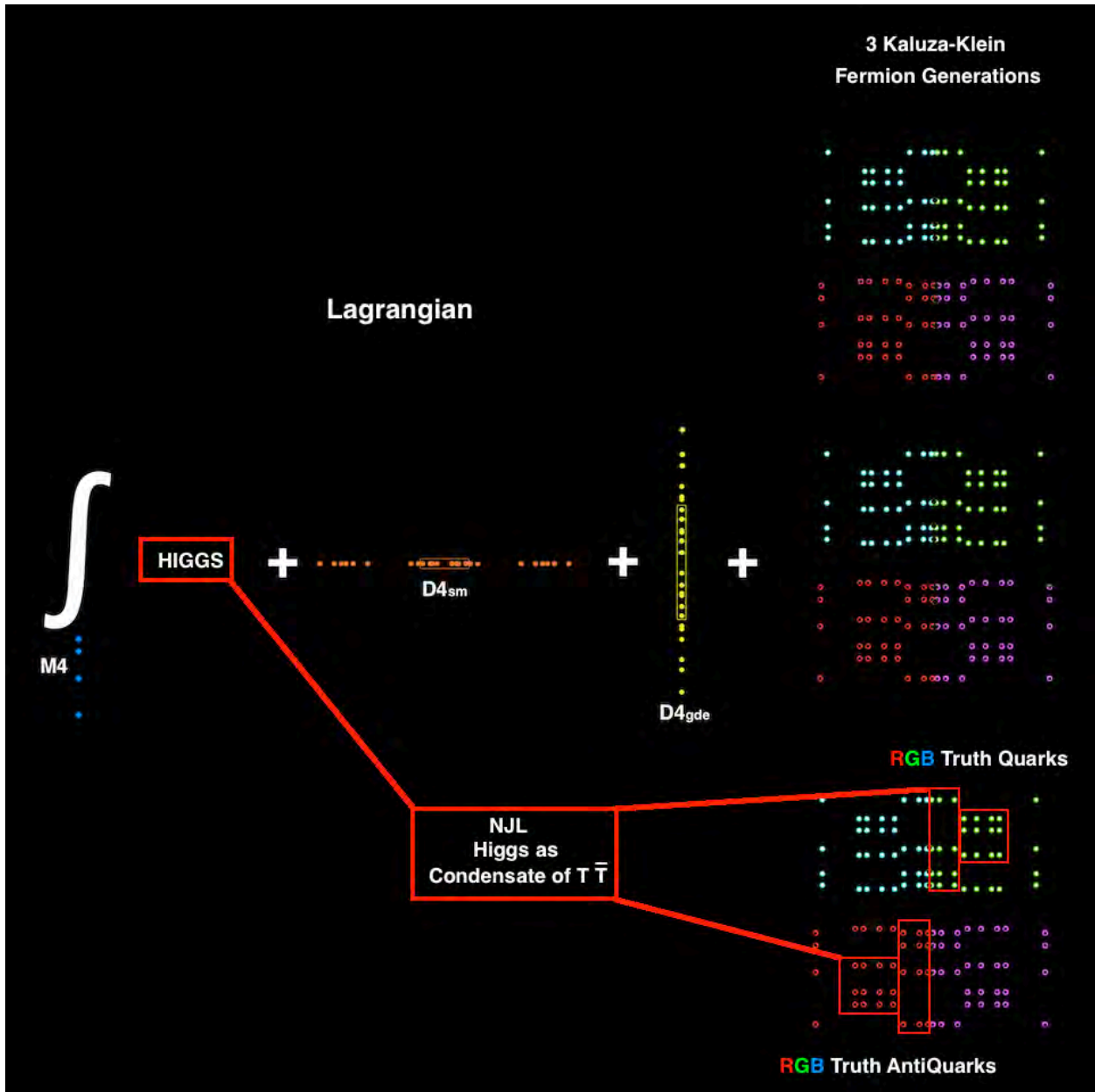

forms a Higgs-Tquark NJL-type system with 3 Mass States

CMS Consensus 1 Mass State:

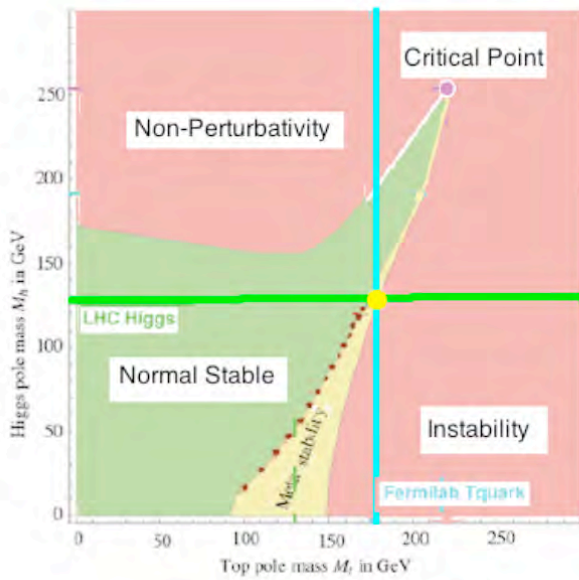

Nambu - Jona-Lasinio 3 Mass States:

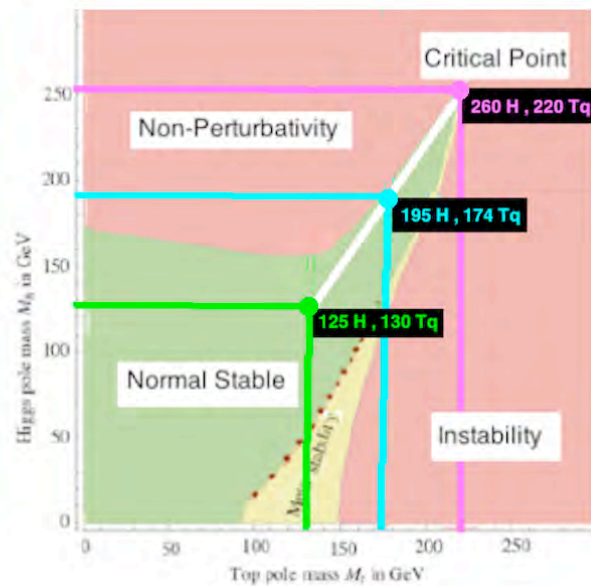

When I put up a blog guest post and comment at http://www.science20.com/tommaso_dorigoguest_post_tony_smith_one_or_three_higgs_bosons-232097 saying that CMS histograms indicated the two higher-mass Higgs boson mass states

although the post and comment were read by many people NOBODY put up any other comment on the blog

which led me to think that CMS was telling people to NOT comment on my post. My thought was confirmed by an email (from a CMS member) saying:

“... The silencing is a sort of self censorship.
There is an agreed upon interpretation of the results
and members of the collaborations cannot publically express criticism of it. ...”.

Here are some details of the 3 Nambu-Jona-Lasinio states:

The Green Dot ● where the White Line originates in our Ordinary Phase is the **Low-mass state of a 130 GeV Truth Quark and a 125 GeV Higgs.**

The 130 GeV Tquark mass is also predicted by Connes’s NCG (NonCommutative Geometry) by the formula $M_t = \sqrt{8/3} M_w$

The Cyan Dot  where the White Line hits the Triviality Boundary leaving the Ordinary Phase is the **Middle-mass state of a 174 GeV Truth Quark and Higgs around 200 GeV**. It corresponds to the Higgs mass calculated by Hashimoto, Tanabashi, and Yamawaki in hep-ph/0311165 where they say:

"... We perform the most attractive channel (MAC) analysis in the top mode standard model with TeV-scale extra dimensions, where the standard model gauge bosons and the third generation of quarks and leptons are put in $D(=6,8,10,\dots)$ dimensions. In such a model, bulk gauge couplings rapidly grow in the ultraviolet region. In order to make the scenario viable, only the attractive force of the top condensate should exceed the critical coupling, while other channels such as the bottom and tau condensates should not. We then find that the top condensate can be the MAC for $D=8$... We predict masses of the top (m_t) and the Higgs (m_H) ... based on the renormalization group for the top Yukawa and Higgs quartic couplings with the compositeness conditions at the scale where the bulk top condenses ... for ... [Kaluza-Klein type] ... dimension... $D=8$... $m_t = 172-175$ GeV and $m_H=176-188$ GeV ...".

As to composite Higgs and the Triviality boundary, Pierre Ramond says in his book *Journeys Beyond the Standard Model* (Perseus Books 1999) at pages 175-176: "... The Higgs quartic coupling has a complicated scale dependence. It evolves according to $d\lambda/dt = (1/16\pi^2)\beta_\lambda$ where the one loop contribution is given by $\beta_\lambda = 12\lambda^2 - \dots - 4H$... The value of λ at low energies is related [to] the physical value of the Higgs mass according to the tree level formula $m_H = v\sqrt{2\lambda}$ while the vacuum value is determined by the Fermi constant ... for a fixed vacuum value v , let us assume that the Higgs mass and therefore λ is large. In that case, β_λ is dominated by the λ^2 term, which drives the coupling towards its Landau pole at higher energies. Hence the higher the Higgs mass, the higher λ is and the closer [r] the Landau pole to experimentally accessible regions.

This means that for a given (large) Higgs mass, we expect the standard model to enter a strong coupling regime at relatively low energies, losing in the process our ability to calculate. This does not necessarily mean that the theory is incomplete, only that we can no longer handle it ... it is natural to think that this effect is caused by new strong interactions, and that the Higgs actually is a composite ...

The resulting bound on λ is sometimes called the triviality bound.

The reason for this unfortunate name (the theory is anything but trivial) stems from lattice studies where the coupling is assumed to be finite everywhere; in that case the coupling is driven to zero, yielding in fact a trivial theory.

In the standard model λ is certainly not zero. ...".

The Magenta Dot  at the end of the White Line is the **High-mass state of a 220 GeV Truth Quark and a 240 GeV Higgs**. It is at the critical point of the Higgs-Tquark System with respect to Vacuum Instability and Triviality. It corresponds to the description in hep-ph/9603293 by Koichi Yamawaki of the Bardeen-Hill-Lindner model: "... the BHL formulation of the top quark condensate ... start[s] with the SM Lagrangian which includes explicit Higgs field at the Lagrangian level ... BHL is crucially based on the perturbative picture ...[which]... breaks down at high energy near the compositeness scale Λ ... [10^{19} GeV]... there must be a certain matching scale $\Lambda_{\text{Matching}}$ such that the perturbative picture (BHL) is valid for $\mu < \Lambda_{\text{Matching}}$, while only the nonperturbative picture (MTY) becomes consistent for $\mu > \Lambda_{\text{Matching}}$... However, thanks to the presence of a quasi-infrared fixed point, BHL prediction is numerically quite stable against ambiguity at high energy region, namely, rather independent of whether this high energy region is replaced by MTY or something else. ... Then we expect $m_t = m_t(\text{BHL}) = \dots = 1/(\sqrt{2}) y_{\text{bar}} v$ within 1-2%, where y_{bar} is the quasi-infrared fixed point given by $\text{Beta}(y_{\text{bar}}) = 0$ in ... the one-loop RG equation ... The composite Higgs loop changes y_{bar}^2 by roughly the factor $N_c/(N_c + 3/2) = 2/3$ compared with the MTY value, i.e., 250 GeV \rightarrow 250 x $\sqrt{2/3} = 204$ GeV, while the electroweak gauge boson loop with opposite sign pulls it back a little bit to a higher value. The BHL value is then given by $m_t = 218 \pm 3$ GeV, at $\Lambda = 10^{19}$ GeV. The Higgs boson was predicted as a $t\bar{t}$ bound state with a mass $M_H = 2m_t$ based on the pure NJL model calculation. Its mass was also calculated by BHL through the full RG equation ... the result being ... $M_H / m_t = 1.1$) at $\Lambda = 10^{19}$ GeV the top quark condensate proposed by Miransky, Tanabashi and Yamawaki (MTY) and by Nambu independently ... entirely replaces the standard Higgs doublet by a composite one formed by a strongly coupled short range dynamics (four-fermion interaction) which triggers the top quark condensate. The Higgs boson emerges as a $t\bar{t}$ bound state and hence is deeply connected with the top quark itself. ... MTY introduced explicit four-fermion interactions responsible for the top quark condensate in addition to the standard gauge couplings. Based on the explicit solution of the ladder SD equation, MTY found that even if all the dimensionless four-fermion couplings are of $O(1)$, only the coupling larger than the critical coupling yields non-zero (large) mass ... The model was further formulated in an elegant fashion by Bardeen, Hill and Lindner (BHL) in the SM language, based on the RG equation and the compositeness condition. BHL essentially incorporates $1/N_c$ sub-leading effects such as those of the composite Higgs loops and ... gauge boson loops which were disregarded by the MTY formulation. We can explicitly see that BHL is in fact equivalent to MTY at $1/N_c$ -leading order. Such effects turned out to reduce the above MTY value 250 GeV down to 220 GeV ...".

CMS in arXiv 1804.01939 showed a 4 lepton histogram of 35.9 fb⁻¹ at 13 TeV for 2016 with 10 GeV bins and a log scale. With 10 GeV bins the background is very smooth and the two peaks at 205 GeV and 265 GeV are obviously there

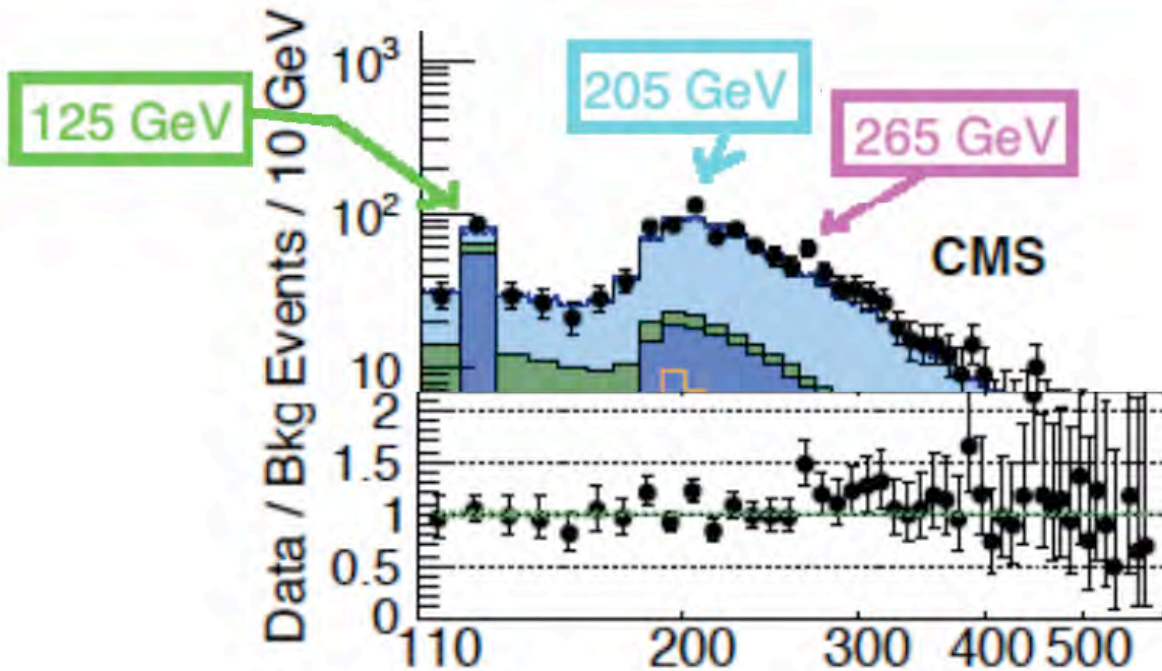
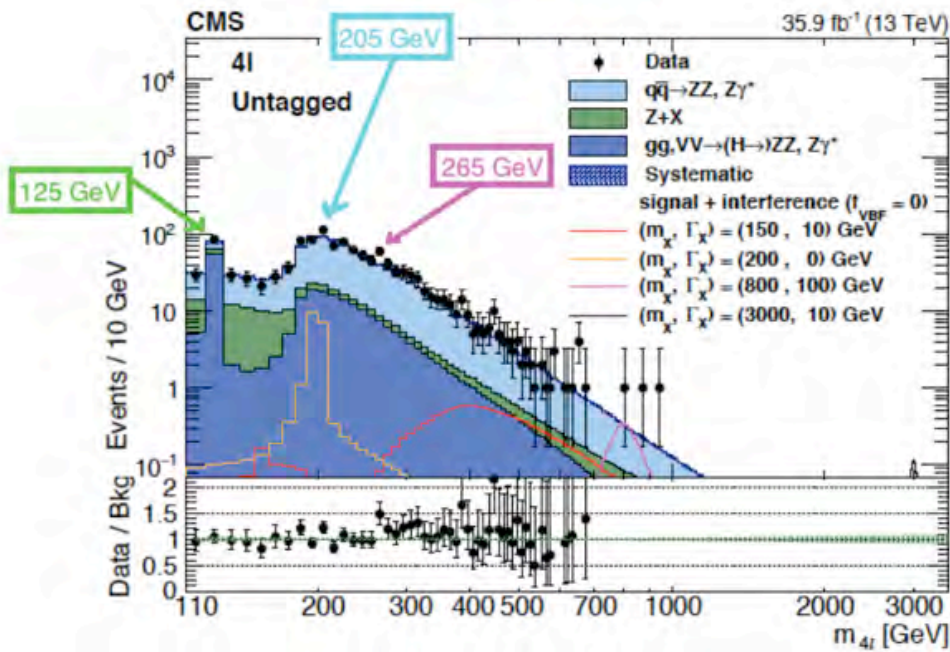

For the same 35.9 fb⁻¹ at 13 TeV 2016 data CMS PAS HIG-17-012 showed

a 4 lepton linear scale histogram with 5 GeV bins.

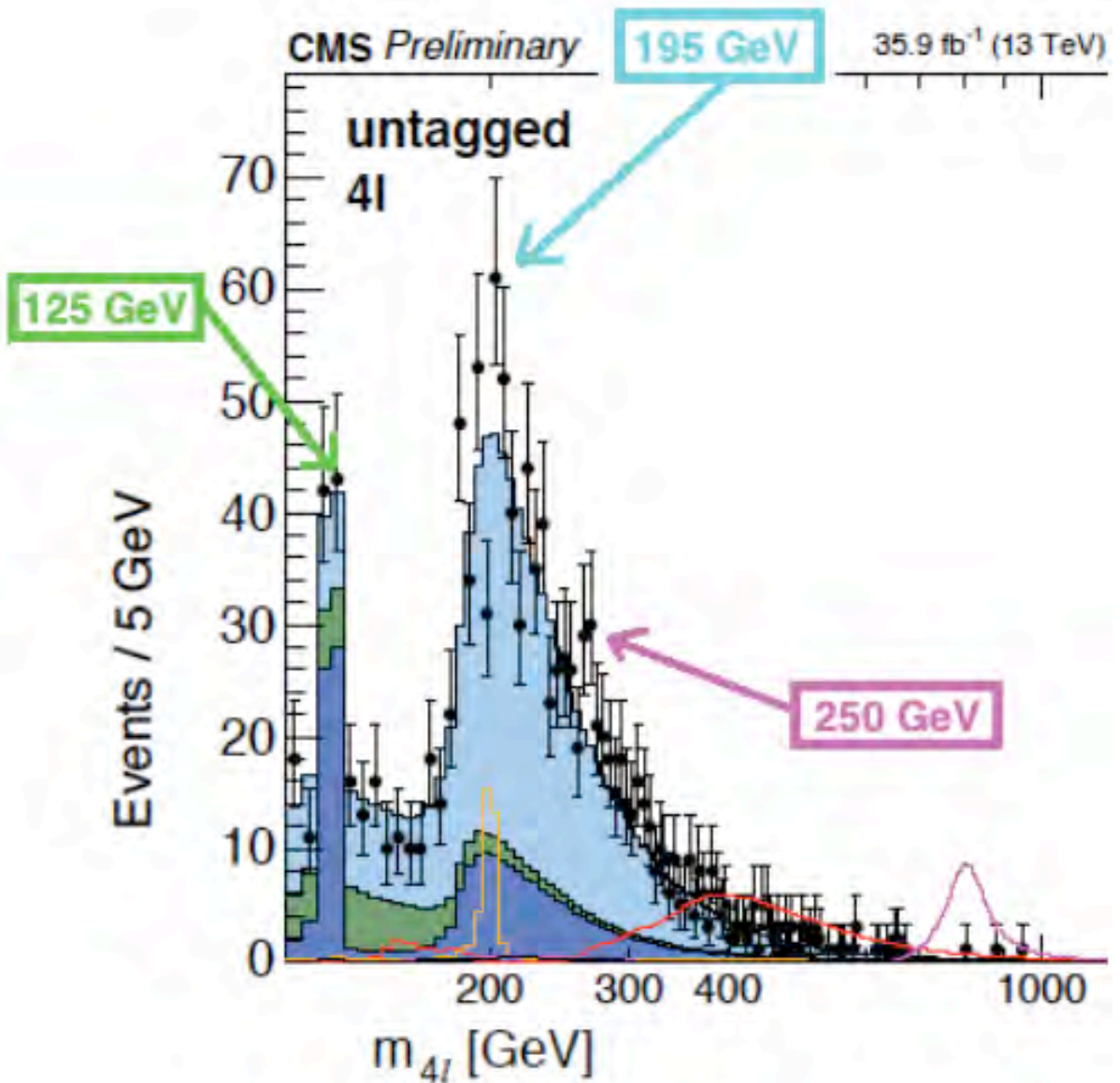

With 5 GeV bins the background has a lot of fluctuations that not only make the background seem noisy but also obscures the 205 GeV and 245 GeV peaks of the 2016 histogram.

When you combine 5 GeV bins pairwise to 10 GeV bins for all bins except the peak bins at 195 GeV and 250 GeV of the 2016 linear histogram.

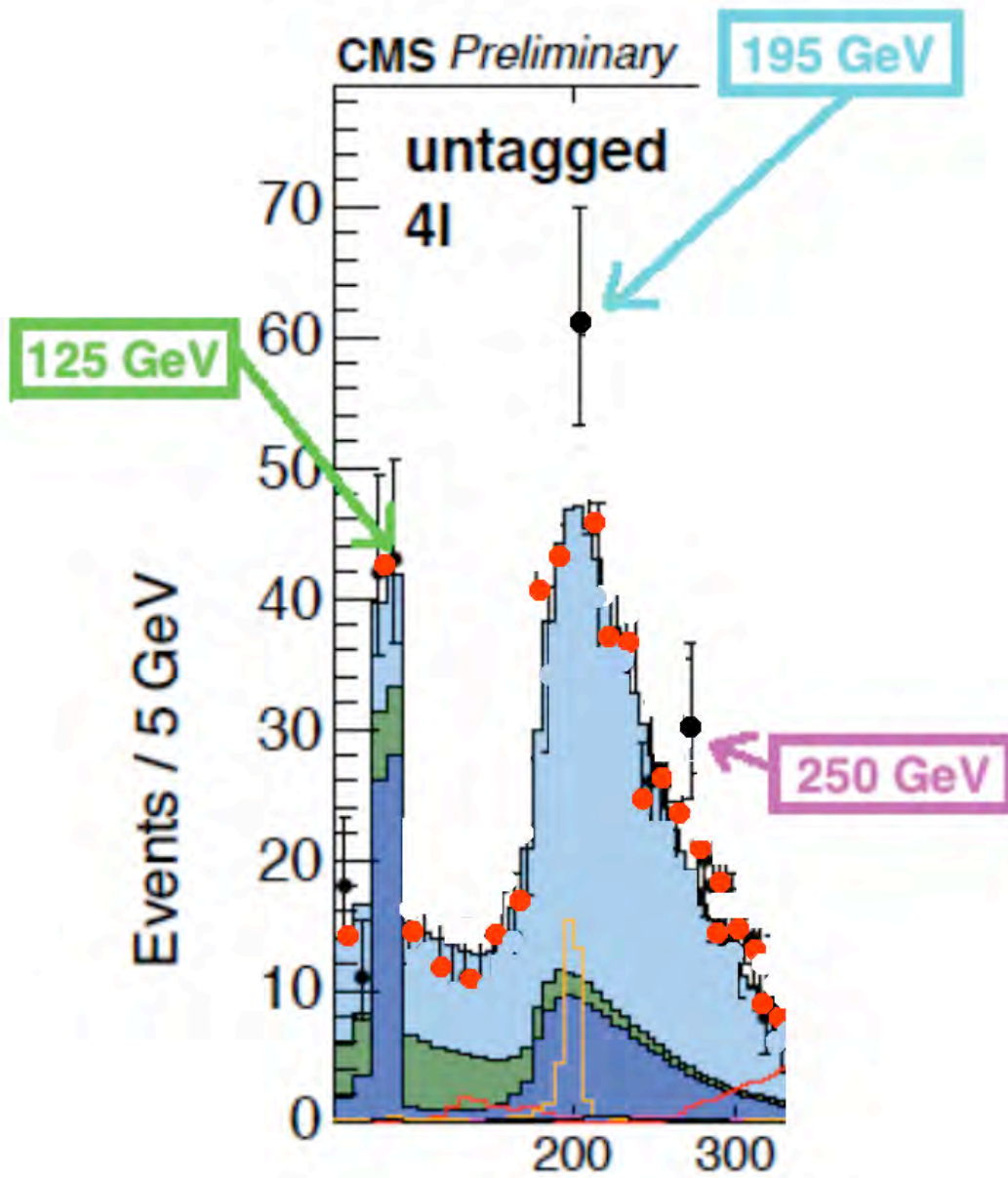

the background becomes smooth (just like CMS showed when it used 10 GeV bins) and the peaks at 195 GeV and 250 GeV become obvious and even the 125 GeV peak seems to be naturally a 10 GeV pair of bins instead of a single 5 GeV bin.

CMS HIG-19-001-pas dated 2019/03/22 figure 7 (left) shows
 "... Distribution of the reconstructed four-lepton invariant mass m_{4l} up to 500 GeV ...
 with full Run 2 data. ... 137.1 fb⁻¹ 2016+2017+2018 (13 TeV) ... Events / 4 GeV ...

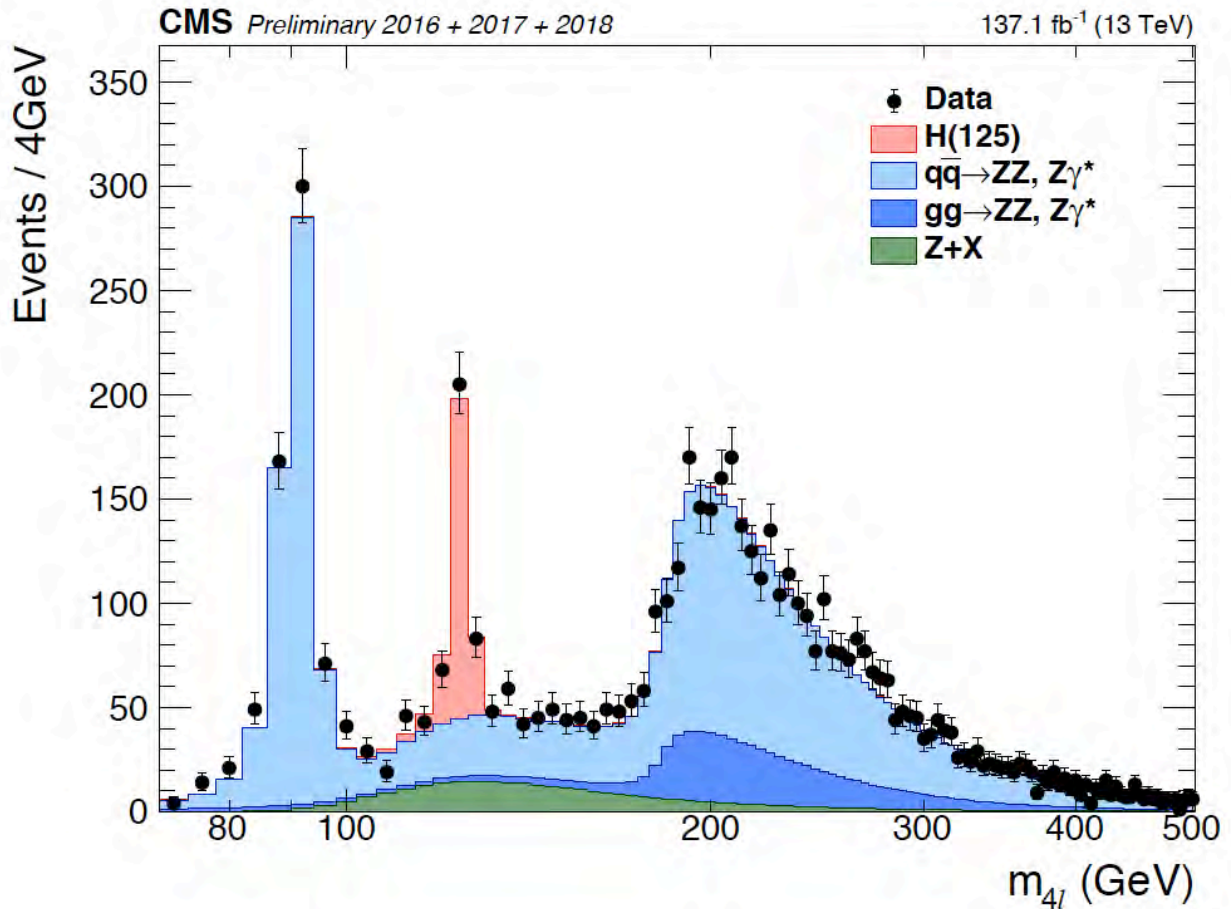

In my view the Higgs mass peaks at 125 GeV and 256 GeV
 are also shown in the full Run 2 histogram
 but
 the analysis is complicated by combining data from 2016 and 2017 with 2018
 as there seem to be some differences in the way data was processed and analyzed.
 The first things to take into account are the facts that
 the 125 GeV bin (4 GeV) seems to be part of a cluster of 5 bins (4 GeV each)
 and
 the 256 GeV bin (4 GeV) seems to be part of a cluster of 8 bins (4 GeV each)
 so

I did pairwise combination of 4 GeV bins to 8 GeV bins
 in the range from about 150 GeV to about 300 GeV
 for 4 GeV bins outside those clusters
 with the combined bin data points shown as red dots

with the result that the two clusters are clearly exceptional and the red-dot background is nice and smooth

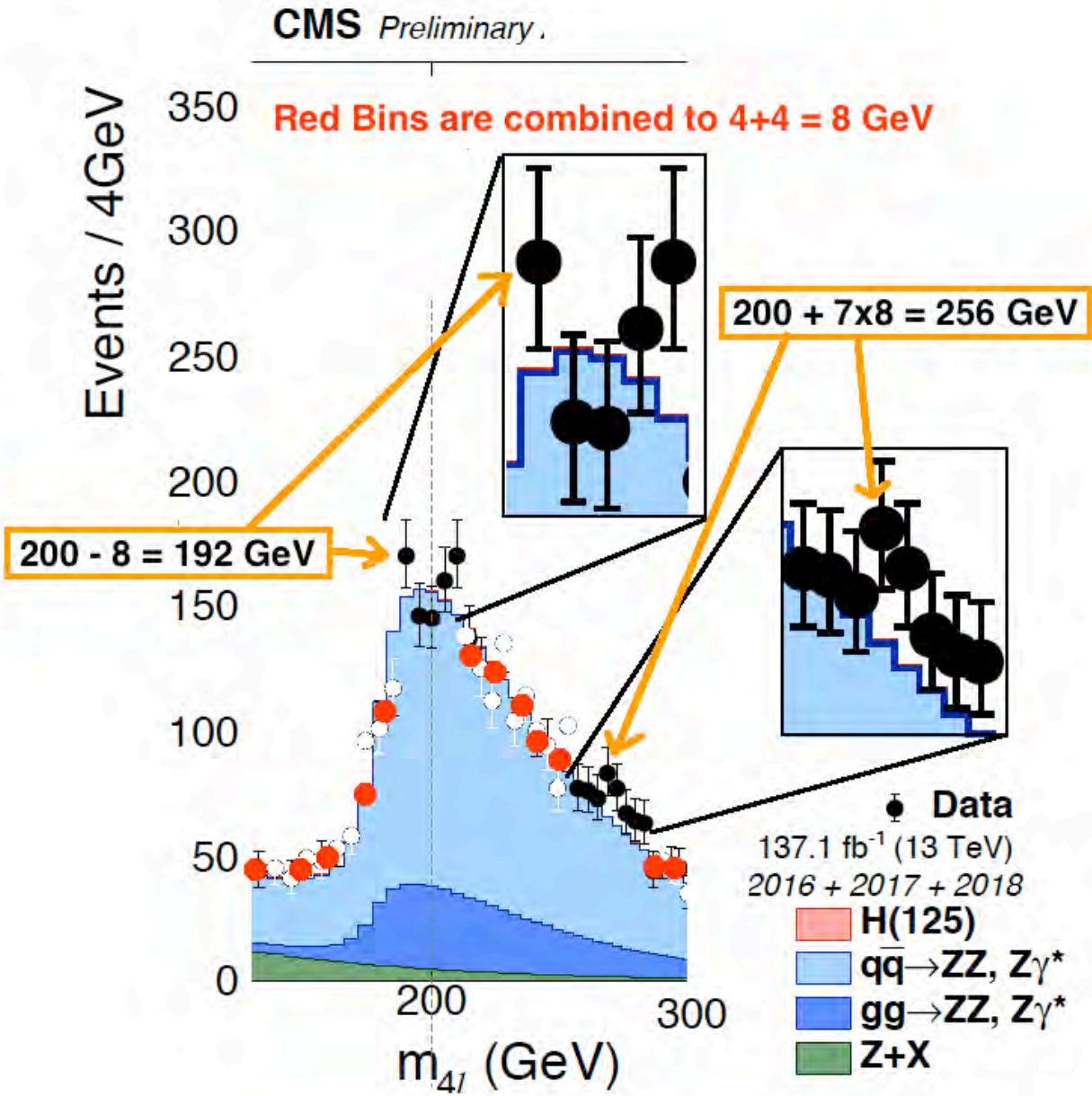

The next steps are to analyze the two clusters in detail

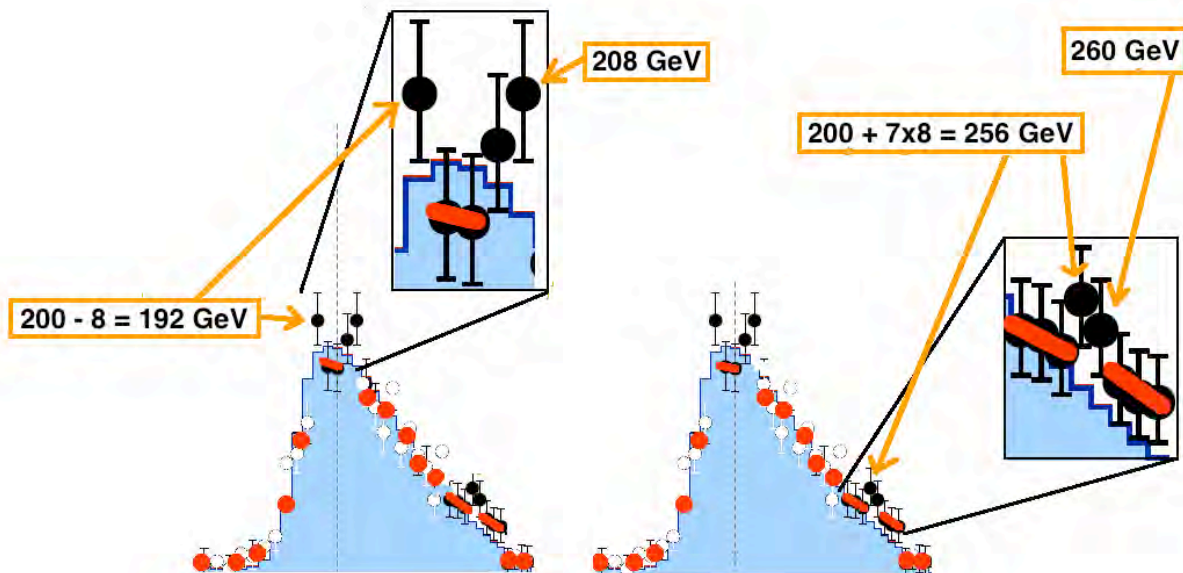

The cluster with the 192 GeV peak has 5 bins (4 GeV each).
 The 192 GeV bin is the peak seen in the 2018 histogram.
 The 196 GeV and 200 GeV bins are consistent with pure background.
 The 204 GeV and 208 GeV bins are consistent with
 the 205 GeV peak in Figure 2 (upper left) of the CMS paper at arXiv 1804.01939
 The cluster with the 256 GeV peak has 8 bins (4 GeV each).
 The 244 GeV and 248 and 252 GeV bins are consistent with pure background.
 The 256 GeV bin is the peak seen in the 2018 histogram.
 The 260 GeV bin is consistent with
 the 265 GeV peak in Figure 2 (upper left) of the CMS paper at arXiv 1804.01939
 The 264 GeV and 268 GeV and 272 GeV bins are consistent with pure background.
 Therefore, taking into account
 the need to combine 4 GeV bins into 8 GeV bins to get a smooth background
 and
 the fact that the 2016+2017+2018 histogram must deal with possibly varying
 methods of data collection and analysis for 35.9 fb⁻¹ from 2016 and 58.7 fb⁻¹ from 2018
 plus 2017 data, all to be combined into 137.1 fb⁻¹ for the 2016+2017+2018 histogram,

**it seems to me that the CMS 137.1 fb⁻¹ 2016+2017+2018 histogram also supports
 the Higgs and the Truth Quark
 as a Nambu-Jona-Lasinio type system with three mass states**

What about the Truth Quark ?

The Official Consensus of Fermilab is that the low-mass green peaks of the CDF and D0 semi-leptonic histograms (and the high-mass magenta peaks which are indeed less prominent) are only statistical fluctuations.

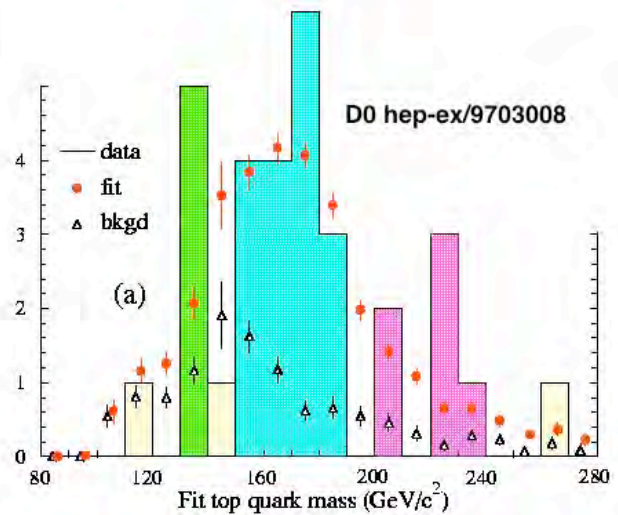
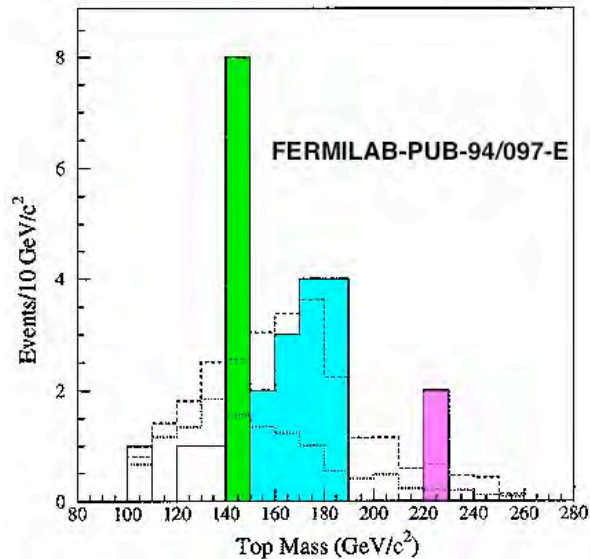

Tommaso Dorigo said that **the significance of such similar green peaks being seen by both CDF and D0, consistent with my model prediction, is 4 sigma.**

In light of that, and other details of Fermilab data analysis that I have described in viXra 1804.0121 and other papers, I think that accurate analysis of Fermilab data will support a Truth Quark - Higgs 3-mass-state Nambu-Jona-Lasinio System.

In his 1997 Ph.D. thesis FERMILAB-THESIS-1997-28

https://www-d0.fnal.gov/results/publications_talks/thesis/varnes/thesis.ps

Erich Ward Varne (page 159) said:

"... distributions for the dilepton candidates. For events with more than two jets, the dashed curves show the results of considering only the two highest ET jets in the reconstruction ...

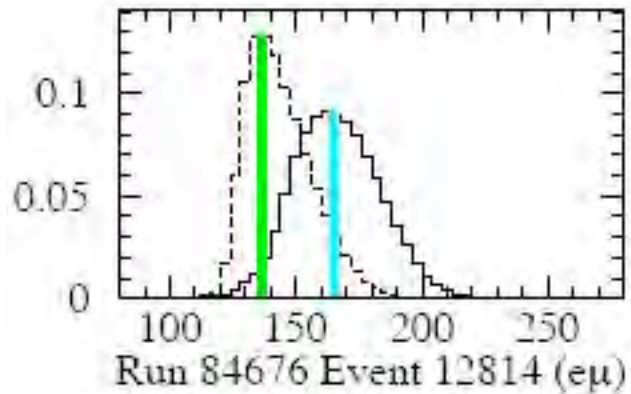

..." (colored bars added by me)

The event for all 3 jets (solid curve) seems to me to correspond to

decay of a middle (cyan) T-quark state

with one of the 3 jets corresponding to

decay from the Triviality boundary to the Normal Stable Region (green) T-quark state,

whose immediately subsequent decay corresponds to the 2-jet (dashed curve) event at the low (green) energy level.

In the Varne thesis there is one dilepton event with 3 jets (solid curve)

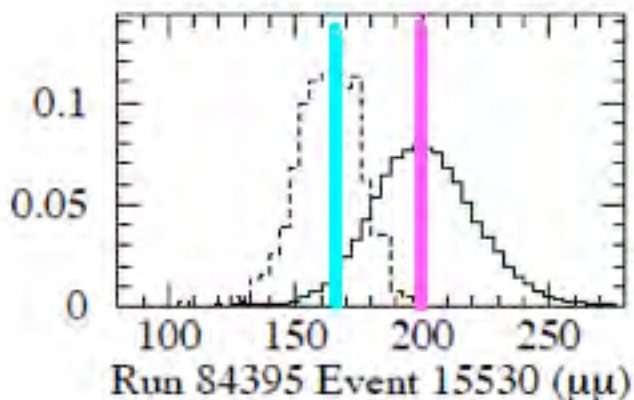

that seems to me to correspond to decay of a high (magenta) T-quark state

with one of the 3 jets corresponding to

decay from the Critical Point down to the Triviality Boundary (cyan) T-quark state,

whose immediately subsequent decay corresponds to the 2-jet (dashed curve) event.

Dilepton data are described by Erich Ward Varne in Chapter 8 of his 1997 UC Berkeley PhD thesis about D0 data at Fermilab:

"... there are six t-tbar candidate events in the dilepton final states ... Three of the events contain three jets, and in these cases the results of the fits using only the leading two jets and using all combinations of three jets are given ...".

There being only 6 dilepton events in Figure 8.1 of Varnes's PhD thesis

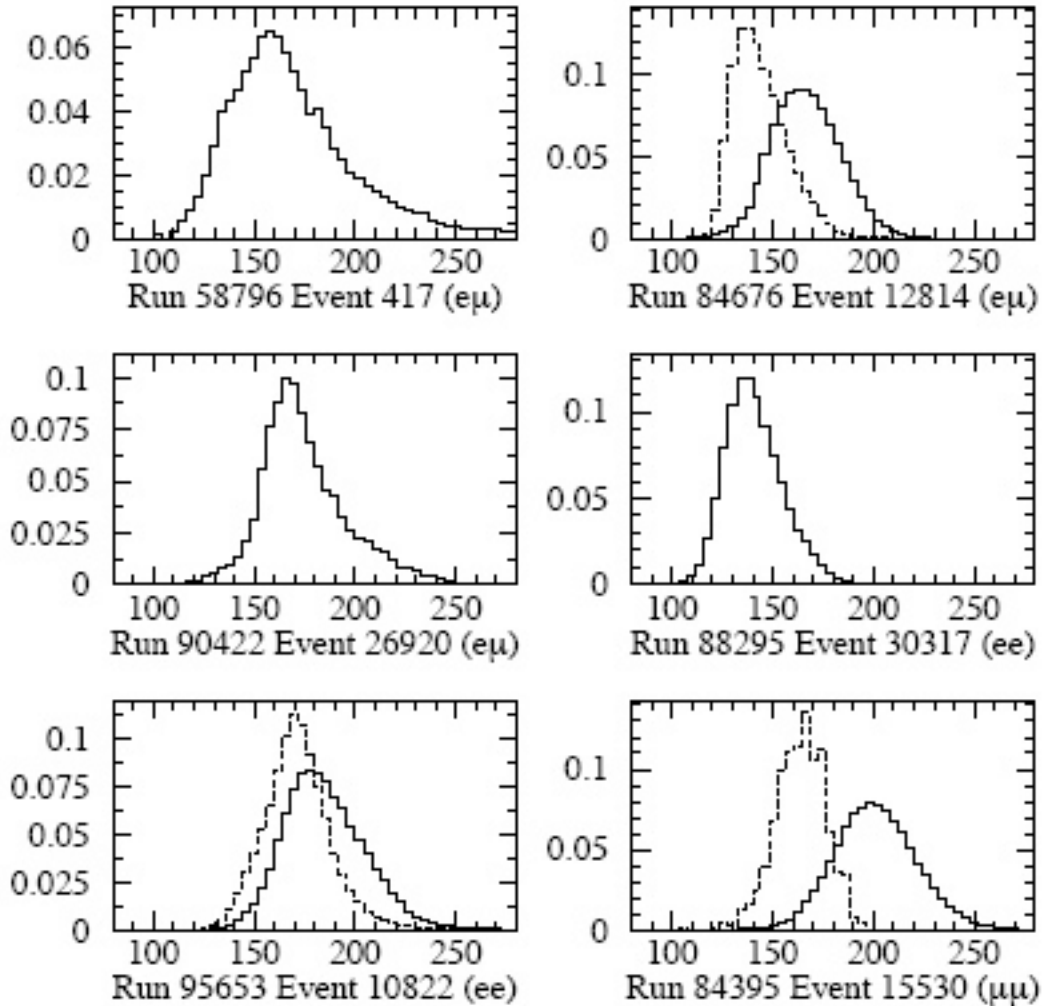

Figure 8.1: $\mathcal{W}(m_l)$ distributions for the dilepton candidates. For events with more than two jets, the dashed curves show the results of considering only the two highest E_T jets in the reconstruction.

it is reasonable to discuss each of them,
 so (mass is roughly estimated by me looking at the histograms) here they are:
 Run 58796 Event 417 (e mu) - 2 jets - 160 GeV
 Run 90422 Event 26920 (e mu) - 2 jets - 170 GeV
 Run 88295 Event 30317 (e e) - 2 jets - 135 GeV

Run 84676 Event 12814 (e mu) - more than 2 jets - 165 GeV -
highest 2 jets - 135 GeV

Run 95653 Event 10822 (e e) - more than 2 jets - 180 GeV - highest 2 jets - 170 GeV

Run 84395 Event 15530 (mu mu) - more than 2 jets - 200 GeV -
highest 2 jets - 165 GeV

In terms of 3 Truth Quark mass states - High around 220 GeV or so -

Middle around 174 GeV or so - Low around 130-145 GeV or so - those look like:

Run 58796 Event 417 (e mu) - direct 2-jet decay of Middle

Run 90422 Event 26920 (e mu) - direct 2-jet decay of Middle

Run 88295 Event 30317 (e e) - direct 2-jet decay of Low

Run 84676 Event 12814 (e mu) - decay of Middle to Low then 2-jet decay of Low

Run 95653 Event 10822 (e e) - decay of High to Middle then 2-jet decay of Middle

Run 84395 Event 15530 (mu mu) - decay of High to Middle then 2-jet decay of Middle

The 1997 UC Berkeley PhD thesis of Erich Ward Varnes says:

“... the leptonic decays of the t tbar events are divided into two broad categories:
the lepton plus jets and dilepton channels.

The former has the advantage of a large branching ratio, accounting for about 30% of
all t tbar decays, with the disadvantage that electroweak processes or detector
misidentification of fina-state particle can mimic the t tbar signal relatiely frequently.

Conversely,

the dilepton channels have lower backgrounds, but account for only 5% of all decays.

...

The kinematic selection of dilepton events is summarized in Table 5.2 ...

	$e\bar{e}$	$e\mu$	$\mu\mu$
Leptons	$E_T > 20 \text{ GeV}$ $ \eta < 2.5$	$E_T(e) > 15 \text{ GeV}$, $p_T(\mu) > 15 \text{ GeV}/c$ $ \eta(e) < 2.5$	$p_T(\mu) > 15 \text{ GeV}/c$
Jets	≥ 2 with $E_T > 20 \text{ GeV}$ and $ \eta < 2.5$		
\cancel{E}_T	$> 25 \text{ GeV}$	$\cancel{E}_T > 20 \text{ GeV}$ $\cancel{E}_T^{\text{cal}} > 10 \text{ GeV}$	N/A
H_T^c	$> 120 \text{ GeV}$	$> 120 \text{ GeV}$	$> 100 \text{ GeV}$

Table 5.2: Kinematic cuts for the dilepton event selection. The cut used in place of \cancel{E}_T to reject $Z \rightarrow \mu\mu$ events is described in the text, as is the H_T^c variable. Also, the muon η cut is run-dependent, as detailed in Chapter 4.

In the dilepton channels, one expects the final state to consist of two charged leptons, two neutrinos, and two b jets (see Fig. 6.1)

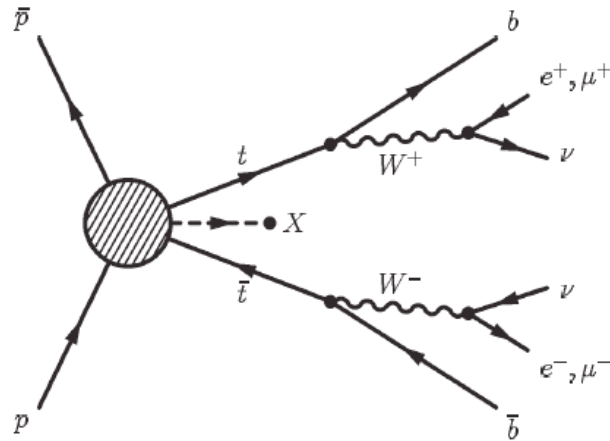

Figure 6.1: Schematic representation of $t\bar{t}$ production and decay in the dilepton channels.

so that the final state is completely specified by knowledge of the energy four-vectors of these six particles ... there are ... kinematic constraints:

The invariant mass of each lepton and neutrino pair is equal to the W mass.

The masses of the reconstructed t and tbar in the event are equal.

...

Figure 8.1: $W(m_t)$ distributions for the dilepton candidates. For events with more than two jets, the dashed curves show the results of considering only the two highest ET jets in the reconstruction ...

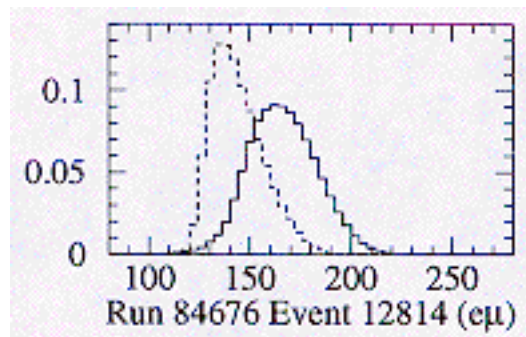

Run 84676 Event 12814					z vertex: -6.17 cm		
Object	E	E_x	E_y	E_z	E_T	η	ϕ
Electron	81.3	-75.4	-1.1	-30.2	74.5	-0.39	3.16
Muon	30.2	-25.2	10.6	-12.8	27.4	-0.45	2.75
\vec{E}_T	-	62.0	5.2	-	62.3	-	0.08
Jet 1	93.8	38.0	-83.7	-15.6	91.9	-0.17	5.14
	(95.9)	(38.9)	(-85.6)	(-16.0)	(94.0)		
Jet 2	37.8	13.9	32.3	-11.2	35.2	-0.31	1.17
	(38.8)	(14.2)	(33.1)	(-11.4)	(36.0)		
Jet 3	31.4	-1.6	28.6	11.6	28.7	0.39	1.63
	(32.2)	(-1.6)	(29.3)	(11.9)	(29.4)		

... "

If the t and tbar are both in the 130 GeV mass state then the decay is simple with 2 jets:

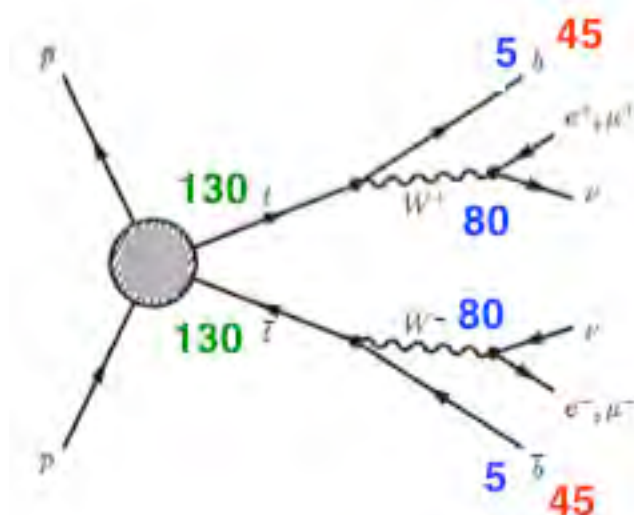

and both jets are highly constrained as being related to the W - b decay process so it is reasonable to expect that the 130 GeV decay events would fall in the narrow width of a single 10 GeV histogram bin.

(In these two diagrams I have indicated energies only approximately for t and tbar mass states (cyan and green) and W and b-quark (blue) and jets (red). Actual kinematic data may vary from the idealized numbers on the diagrams, but they should give similar physics results.)

If the t and tbar are both in the 173 GeV mass state (as, for example, in Run 84676 Event 12814 (e mu) described above) the decay has two stages and 3 jets:

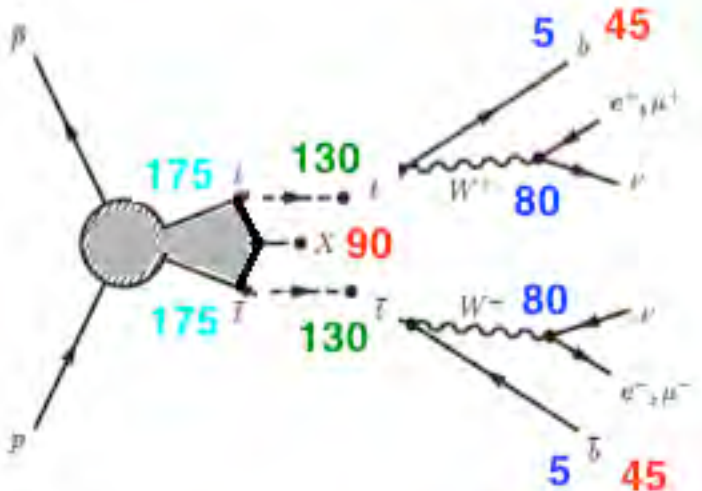

First, the 175 GeV t and tbar both decay to the 130 GeV state, emitting a jet. Then, the 130 GeV t and tbar decay by the simple 2-jet process. The first jet is a process of the Higgs - T-quark condensate system of E8 Physics and is not a W -b decay process so it is not so highly constrained and it is reasonable to expect that the 175 GeV decay events would appear to have a larger (on the order of 40 GeV) width.

As to t and $tbar$ being the high T -quark mass state (around 225 GeV) there would be a third stage for decay from 225 GeV to 175 GeV with a fourth jet carrying around 100 GeV of decay energy. In the Varnes thesis there is one dilepton event

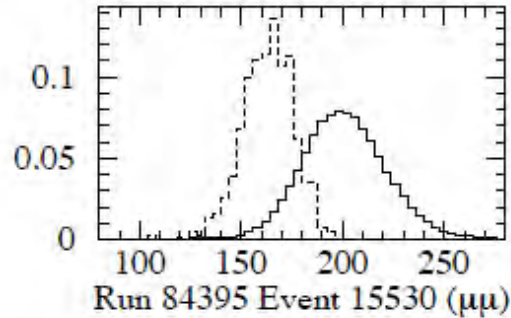

Run 84395 Event 15530					z vertex: 5.9 cm		
Object	E	E_x	E_y	E_z	E_T	η	ϕ
Muon 1	68.6	-63.9	12.7	-21.4	65.1	-0.32	2.94
Muon 2	34.9	-16.0	31.0	1.9	34.9	0.05	2.05
\cancel{E}_T	-	71.2	53.2	-	88.9	-	0.64
Jet 1	146.1 (153.5)	32.1 (33.8)	-98.2 (-103.1)	-102.4 (-107.6)	103.3 (108.5)	-0.88	5.03
Jet 2	35.1 (37.2)	-8.6 (-9.1)	21.4 (22.7)	26.2 (27.7)	23.1 (24.5)	0.97	1.95
Jet 3	47.1 (52.3)	-7.6 (-8.4)	-16.8 (-18.6)	43.0 (47.8)	18.4 (20.5)	1.58	4.29

that seems me to represent that third stage of decay from 225 GeV to 175 GeV. Since it is described as a 3-jet event and not a 4-jet event as I would have expected, my guess is that the third and fourth jets of my model were not distinguished by the experiment so that they appeared to be one third jet.

D0 hep-ex/9801025 - 5 tagged lepton + jets give Tquark mass 130-150 GeV for 3 of the events

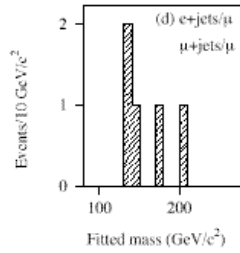

of the total of 91 candidate events, 31 survived Chi-squared less than 10 cut and also survived the Low Bias selection cut, all three Tquark states observed

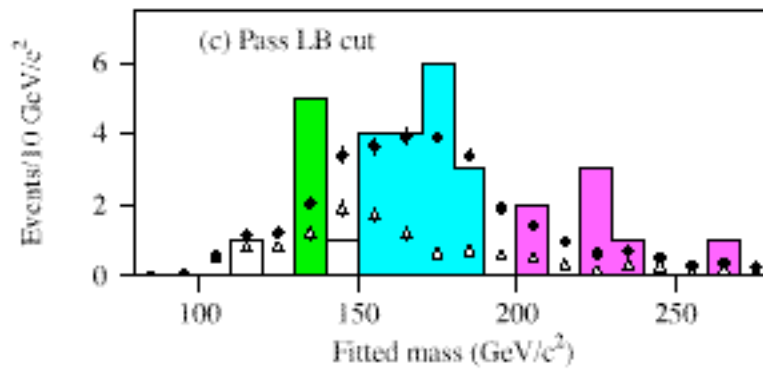

Dalitz, Goldstein hep-ph/9802249 - 11 additional CDF dilepton events which have become available since the 1997 Electron-Photon conference in Hamburg are Low and Middle-mass Tquark states:

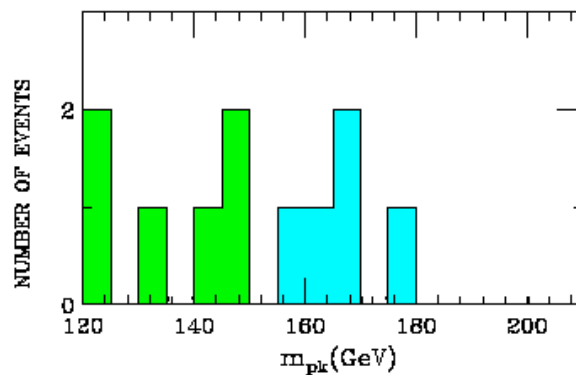

The distribution of m_{pl} values determined from 11 CDF dilepton events available empirically.

CDF hep-ex/9810029 - CDF “present[s] a new measurement of the top quark mass ... [that] supersedes [CDF’s] previously reported result in the dilepton channel” which revision seems to me to be cutting the lowest 3 of the 11 original events

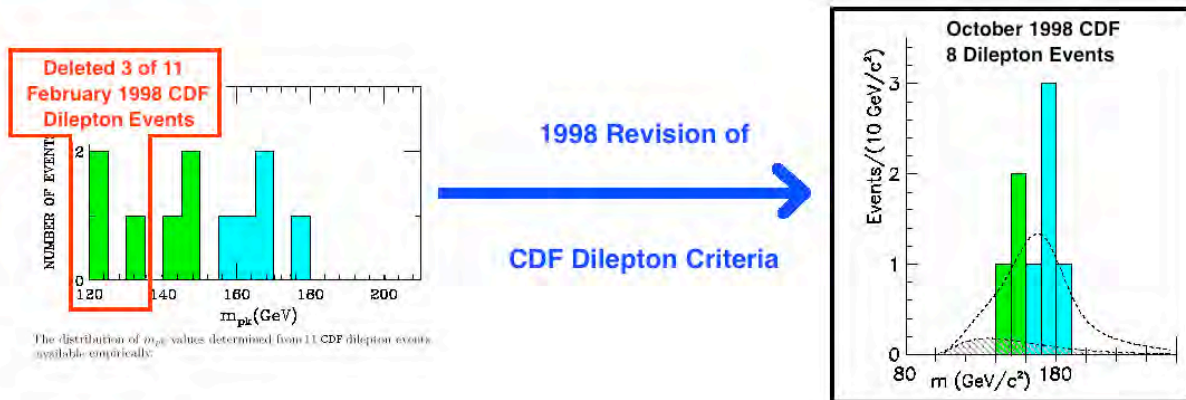

as part of a Fermilab policy of ignoring the Low-mass Tquark state.

Kent Staley in “**The Evidence for the Top Quark**” (Cambridge 2004) said:

“... CDF searched for the top [quark] ... in ... the “dilepton” mode ...

Kumi Kondo's Dynamical Likelihood Method ... found that ... the lone dilepton candidate found during the 1988-9 run ... could be reconstructed with his method as the decay of a top-antitop pair, with a top mass of around 130 GeV/c² ...

Goldstein, Sliwa, and Dalitz ... were trying to apply their method to the first CDF dilepton event, the same published e-mu event from the 1988-9 run that Kondo had analyzed ...

In February 1992 ... Goldstein and Sliwa were invited to present their method ... at a meeting of the heavy flavors group ... Sliwa showed ... a bump ... at a top-quark mass of about 120 GeV/c² ... in May 1992 ... Goldstein, Sliwa, and Dalitz ... present[ed] ... analysis of data from ... 1988-9 ...[saying]... “The plots show very clearly a well separated enhancement around $M_t = 135$ GeV in the accumulated probability distributions, as expected by the Monte Carlo studies” ...

The top mass estimates from the Dalitz-Goldstein-Sliwa analysis ... consistently fell into the 130-140 GeV/c² range ...

considerably lower than the later estimate of 174 GeV/c²

that appeared in CDF’s paper claiming evidence for the top quark ...”.

Two issues that arose for Fermilab were:

1 - Physics Issue - Does the 130 GeV Truth Quark Low Mass State exist

and did the Kondo and/or Sliwa-Goldstein-Dalitz Likelihood Method find it ?

2 - Bureaucratic Issue - Was Sliwa’s sharing of CDF data with Goldstein and Dalitz a serious violation of an unwritten ethical code ?

Fermilab was in position to decide which of the issues should be pursued or suppressed. It could have decided to pursue both issues, but it did not.

It decided to suppress the Physics Issue (and the Truth Quark Low Mass State) so that individual outsiders (and their ideas) would go away.

It decided to pursue the Bureaucratic Issue because that allowed Fermilab to use its jobs-funding power to enforce its consensus view.

Two D4 of D8 / D4xD4

M4 for Gravity+Dark Energy and CP2 for Standard Model

By 8-Periodicity for Real Clifford Algebras $Cl(16) = \text{tensor product } Cl(8) \times Cl(8)$.
Each of the two $Cl(8)$ contains one of the two D4 of D8 / D4xD4 in E8.

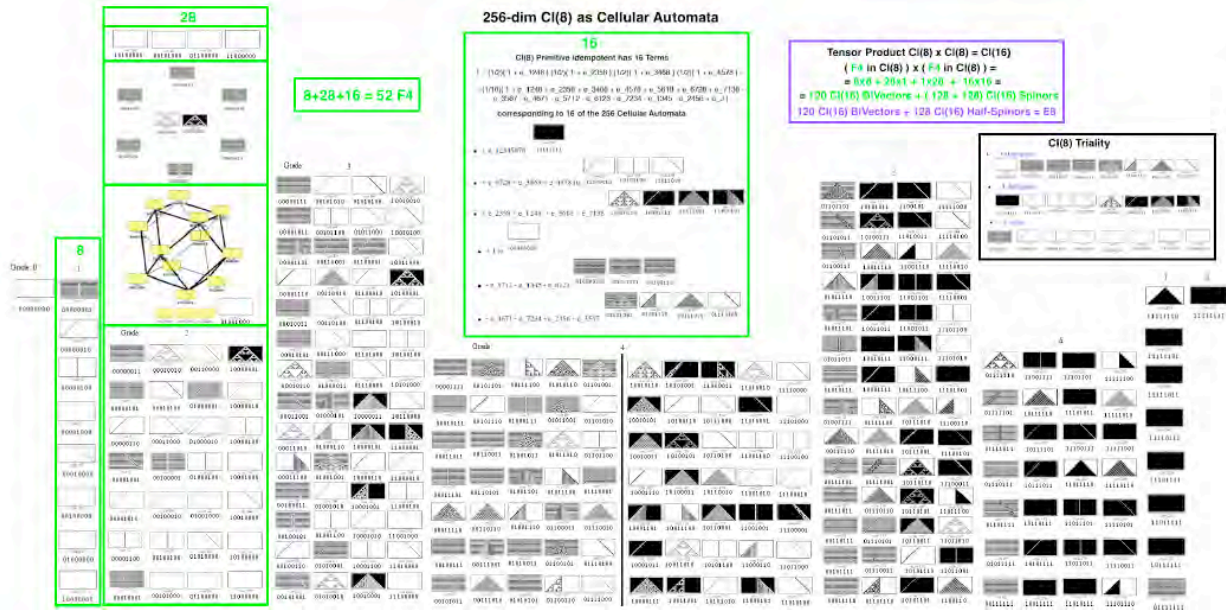

The 256 Elementary Cellular Automata correspond to the 256-dim $Cl(8)$ Clifford Algebra with graded structure 1 8 28 56 (35+35=70) 56 28 8 1

The 28 BiVectors have clear physical interpretation as Ghosts plus Gauge Bosons of Gravity+Dark Energy (16) and of the Standard Model (12)

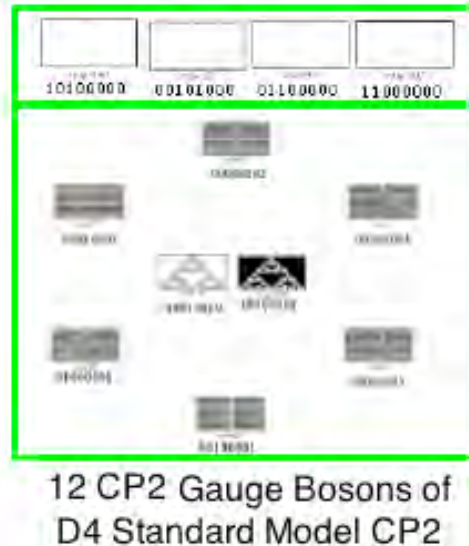

D4 of M4 and Gravity+Dark Energy

Then one of the two D4 Spin(8) is forced to act primarily on the M4 with 16 of its 28 generators being gauge bosons of Gravity+Dark Energy and the other 12 playing reduced role of Standard Model ghosts



The 24 Yellow Root Vectors of the D4 of E8 Gravity + Standard Model Ghosts are on the Vertical Y-axis.

The 4 Cartan Subalgebra elements of D4 of E8 Gravity + Standard Model Ghosts correspond to half of the 8 Cartan Subalgebra elements of E8.

In the Initial and Inflation Octonionic Phases of Our Universe

the 24+4 = 28 generators of D4 of E8 Gravity + Standard Model Ghosts act as a Spin(8) Gauge Group rotating all 8 dimensions of Octonionic Spacetime into each other.

In the Post-Inflation Quaternionic Phase of Our Universe

8-dim Octonionic Spacetime splits into (4+4)-dim M4 x CP2 Kaluza-Klein Spacetime
12 generators in the Yellow Box represent the 12 Root Vectors of the Conformal Gauge Group SU(2,2) = Spin(2,4) of Conformal Gravity + Dark Energy

The 4 Cartan Subalgebra elements of SU(2,2)xU(1) = U(2,2) correspond to the 4 Cartan Subalgebra elements of D4 of E8 Gravity + Standard Model Ghosts and to the other half of the 8 Cartan Subalgebra elements of E8.

The other 24-12 = 12 Yellow Root Vectors represent Ghosts of 12D Standard Model whose Gauge Groups are SU(3) SU(2) U(1)

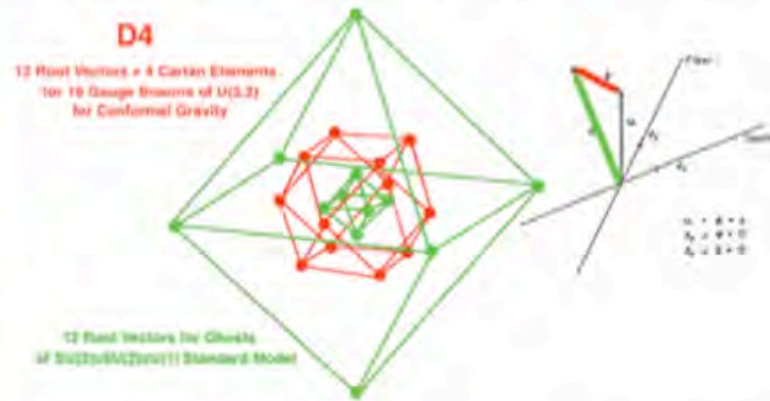

Gravity and Dark Energy come from D4 Conformal Subgroup SU(2,2) = Spin(2,4)

SU(2,2) = Spin(2,4) has 15 generators:

1 Dilation representing Higgs Ordinary Matter

4 Translations representing Primordial Black Hole Dark Matter

10 = 4 Special Conformal + 6 Lorentz representing Dark Energy
(see Irving Ezra Segal, "Mathematical Cosmology and Extragalactic Astronomy" (Academic 1976))

The basic ratio Dark Energy : Dark Matter : Ordinary Matter = 10:4:1 = 0.67 : 0.27 : 0.06
When the dynamics of our expanding universe are taken into account, the ratio is calculated to be 0.75 : 0.21 : 0.04

D4 of CP2 and Standard Model

The other D4 Spin(8) is forced to act primarily on the CP2 with 12 of its 28 generators being gauge bosons of Standard Model and the other 16 playing reduced role of Gravity+Dark Energy ghosts. Since CP2 = SU(3) / SU(2)xU(1) the Color SU(3) acts as a conventional gauge group but the ElectroWeak SU(2)xU(1) of CP2 acts as torsion which accounts for its chirality. The 24 Orange Root Vectors of the D4 of E8 Standard Model + Gravity Ghosts are on the Horizontal X-axis.

The 4 Cartan Subalgebra elements of D4 of E8 Standard Model + Gravity Ghosts correspond to half of the 8 Cartan Subalgebra elements of E8.

In the Initial and Inflation Octonionic Phases of Our Universe

the 24+4 = 28 generators of D4 of E8 Standard Model + Gravity Ghosts act as a Spin(8) Gauge Group rotating all 8 Fermion types into each other.



In the Post-Inflation Quaternionic Phase of Our Universe

8-dim Octonionic Spacetime splits into (4+4)-dim M4 x CP2 Kaluza-Klein Spacetime. 8 generators in the Orange Box represent the 8 Root Vectors of the Standard Model Gauge Groups SU(3) SU(2) U(1). Their 4 Cartan Subalgebra elements correspond to the 4 Cartan Subalgebra elements of D4 of E8 Standard Model + Gravity Ghosts and to half of the 8 Cartan Subalgebra elements of E8. The other 24-8 = 16 Orange Root Vectors represent Ghosts of 16D U(2,2) which contains the Conformal Group Spin(2,4) that produces Gravity + Dark Energy by the MacDowell-Mansouri mechanism. Standard Model Gauge groups come from CP2 = SU(3) / SU(2) x U(1) (as described by Batakis in Class. Quantum Grav. 3 (1986) L99-L105)

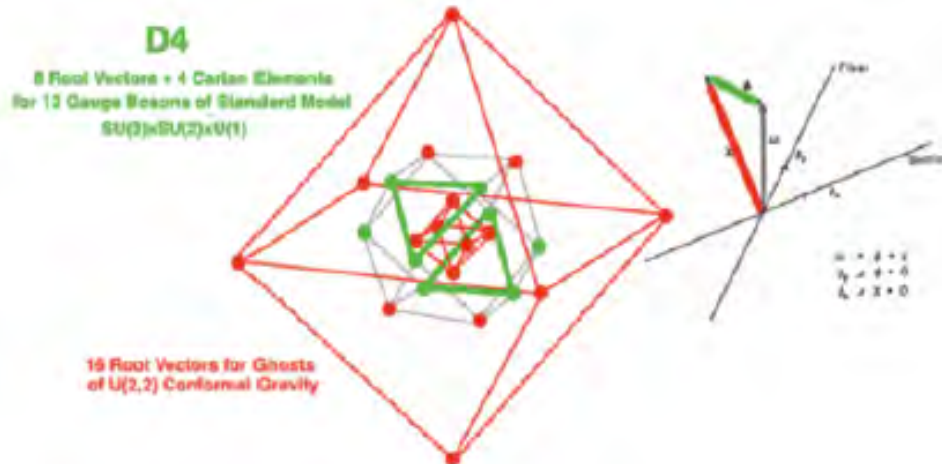

The 24-8 = 16 D4 of CP2 Root Vectors represent Ghosts of U(2,2) Conformal Gravity. Jean Thierry-Mieg in J. Math. Phys. 21 (1980) 2834-2838 said: "... The ghost and the gauge field: The single lines represent a local coordinate system of a principal fiber bundle of base space-time. The double lines are 1 forms. The connection of the principle bundle w is assumed to be vertical. Its contravariant components PHI and X are recognized ... as the Yang-Mills gauge field and the Faddeev-Popov ghost form ..."

Schwinger Sources

In E8-CI(16) Physics, elementary particles are not point particles in or with smooth manifold structures but are finite Schwinger Source regions with size scale from Planck 10^{-33} cm to Source Region Boundaries at scale 10^{-24} cm.

At scales larger than 10^{-24} cm spacetime and other relevant structures can be usefully and accurately considered to be smooth manifolds, thus permitting use of Armand Wyler's methods of calculating force strengths, particle masses, etc.

At Schwinger Source scales Planck 10^{-33} cm to scale 10^{-24} cm the internal structure of Schwinger Sources is QuasiCrystal Lattice derived from E8 Lattices, permitting Indra's Net BlockChain Physics of Schwinger Source Indra Jewels.

Visualization of Schwinger Sources How to Visualize a Schwinger Source in 7 Steps:

First, look at the 240-vertex E8 Root Vector representation of the Valence Fermion of the Schwinger Source Cloud. It is two 600-cells, each with 120 vertices:

H4 M4 representing Conformal Gravity and the M4 part of $M4 \times CP2$ Kaluza-Klein
where M4 = 4D Minkowski Physical Spacetime

and

H4 CP2 representing the Standard Model and the CP2 part of $M4 \times CP2$
where CP2 = $SU(3) / SU(2) \times U(1)$ Internal Symmetry Space

The H4 M4 600-cell is larger than the H4 CP2 600-cell by the Golden Ratio

E8 240 Root Vectors =

= H4M4 120

+

H4CP2 120

Conformal Gravity 600-Cell
with
M4 Physical SpaceTime

Standard Model 600-Cell
with
CP2 Internal Symmetry Space

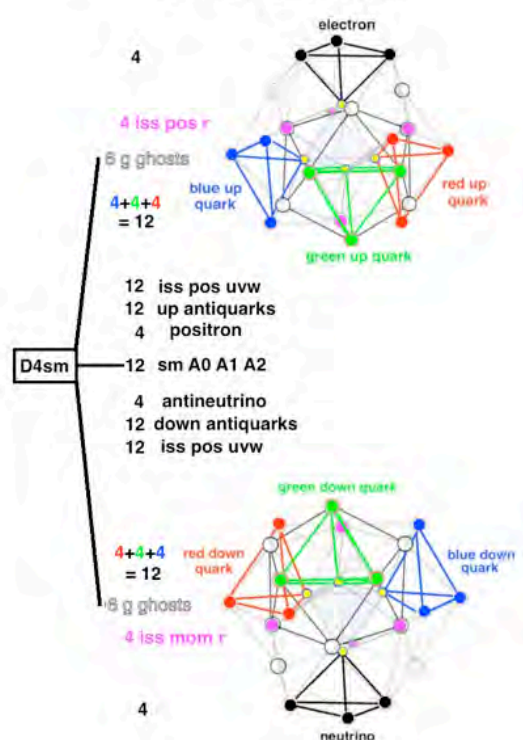
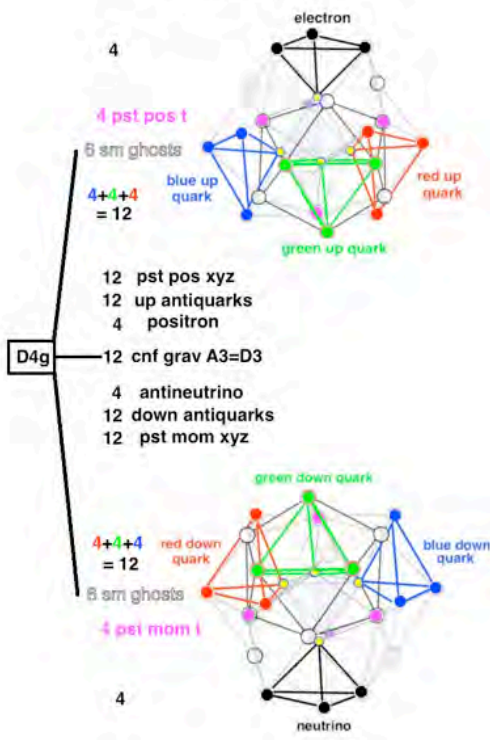

Each First-Generation Fermion is represented by a 4-vertex Tetrahedron in the H4 M4 600-cell and in the H4 CP2 600-cell.

The Valence Fermion is represented as the corresponding two Tetrahedra being activated.

Second, look only at the H4 M4 600-cell to see how the Valence Fermion looks in M4 Minkowski Physical Spacetime:

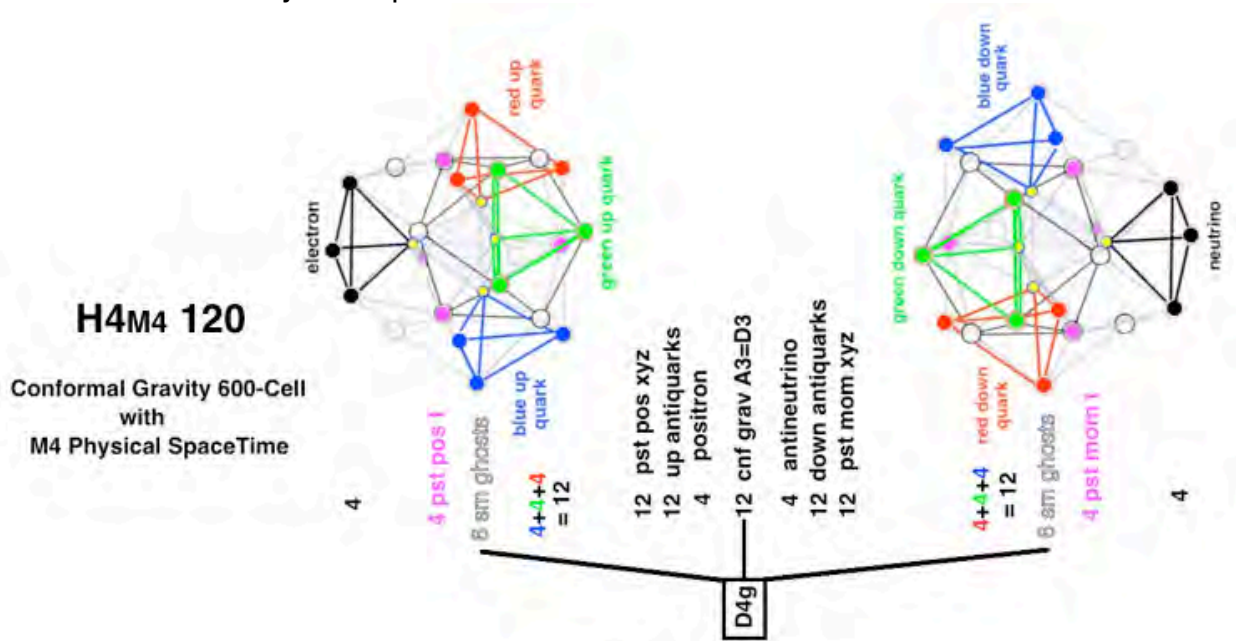

Third, look at the Fibonacci Shell Structure of the M4 part of the Schwinger Source Cloud

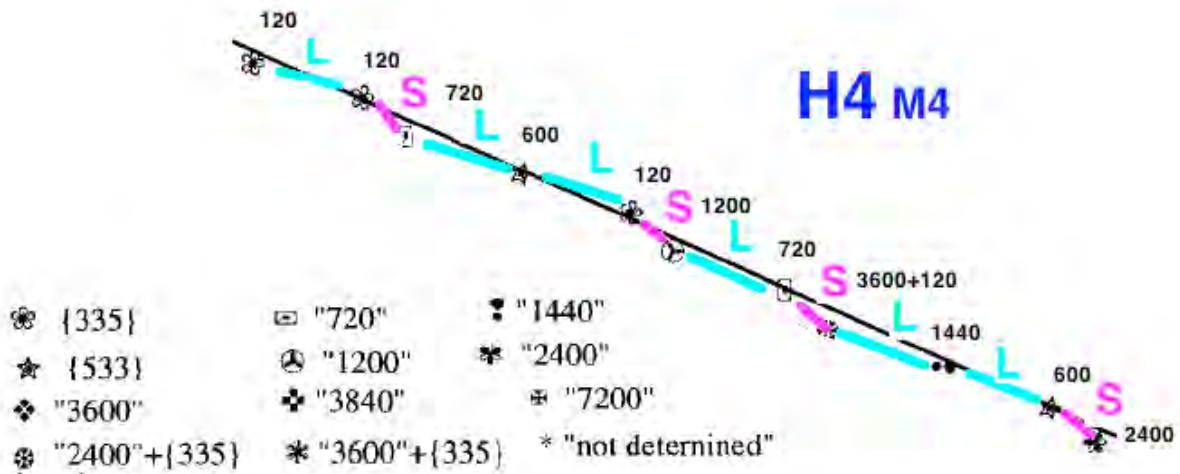

Fourth, look only at the H4 CP2 600-cell to see how the Valence Fermion looks in CP2 Internal Symmetry Space:

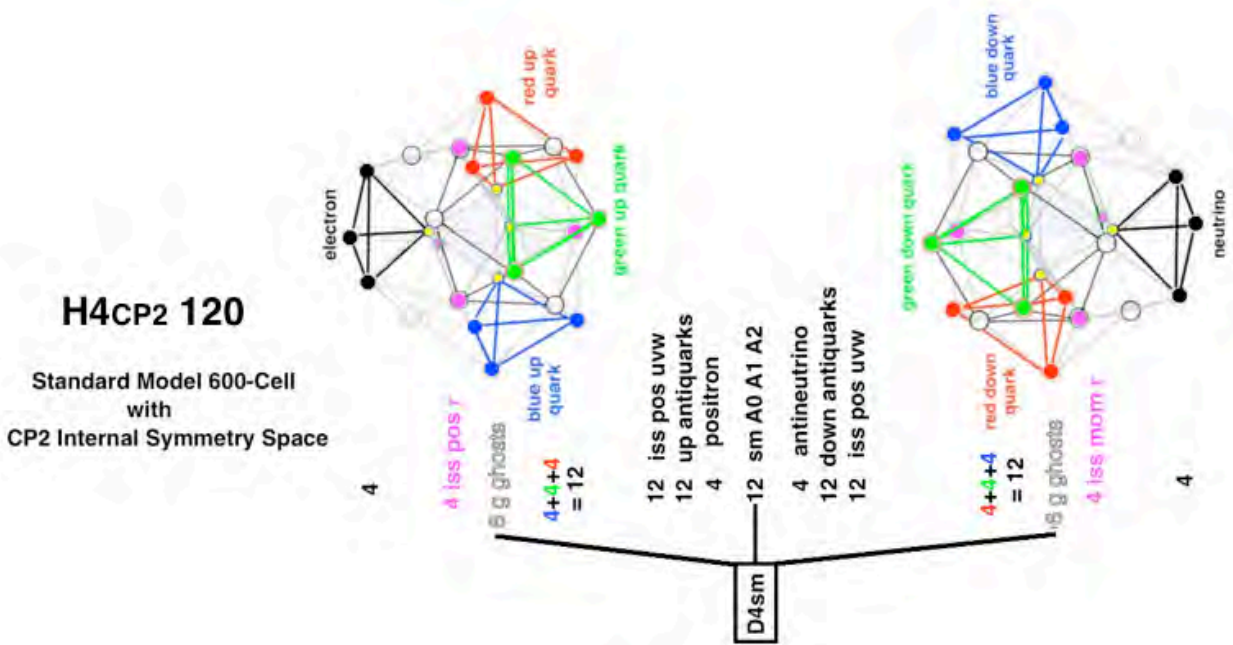

Fifth, look at the Fibonacci Shell Structure of the CP2 part of the Schwinger Source Cloud

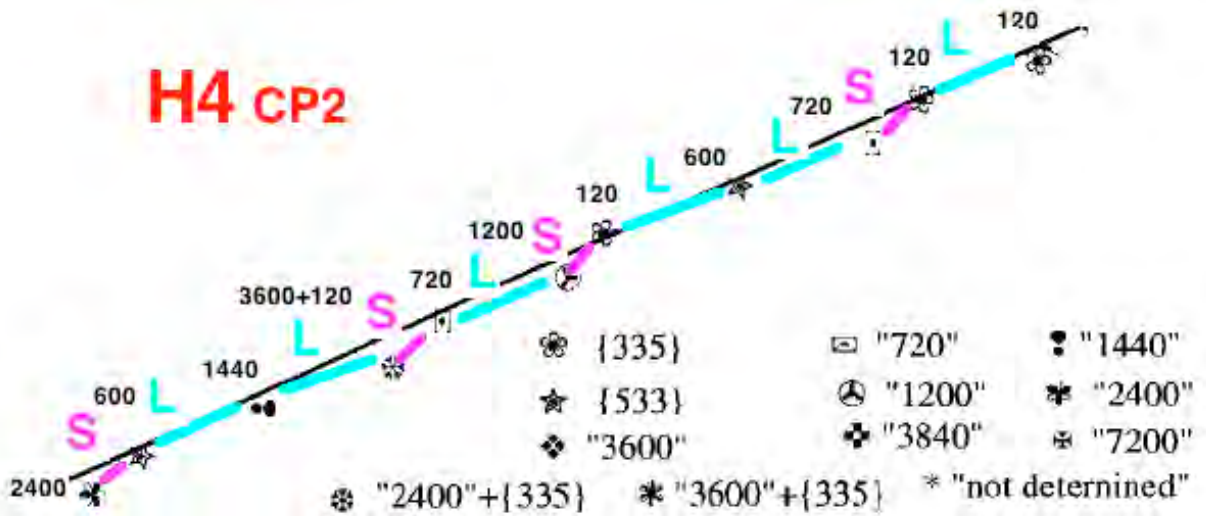

Sixth,
look at the combined Shell Structures of H4 M4 and H4 CP2:

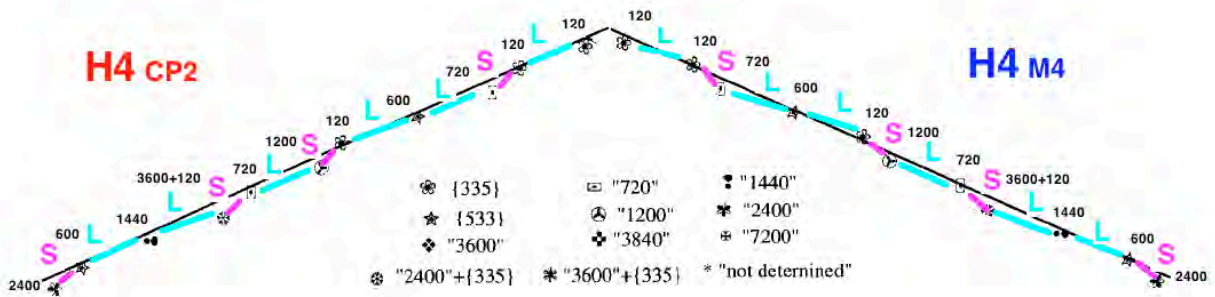

At this stage, you see the M4 and CP2 parts of the Schwinger Source Cloud
but
you have not yet seen the full E8 Schwinger Source Cloud.
For that, you need to go to the 7th Step:

Seventh,
combine the H4 M4 and H4 CP2 parts to form the full E8 Schwinger Source:

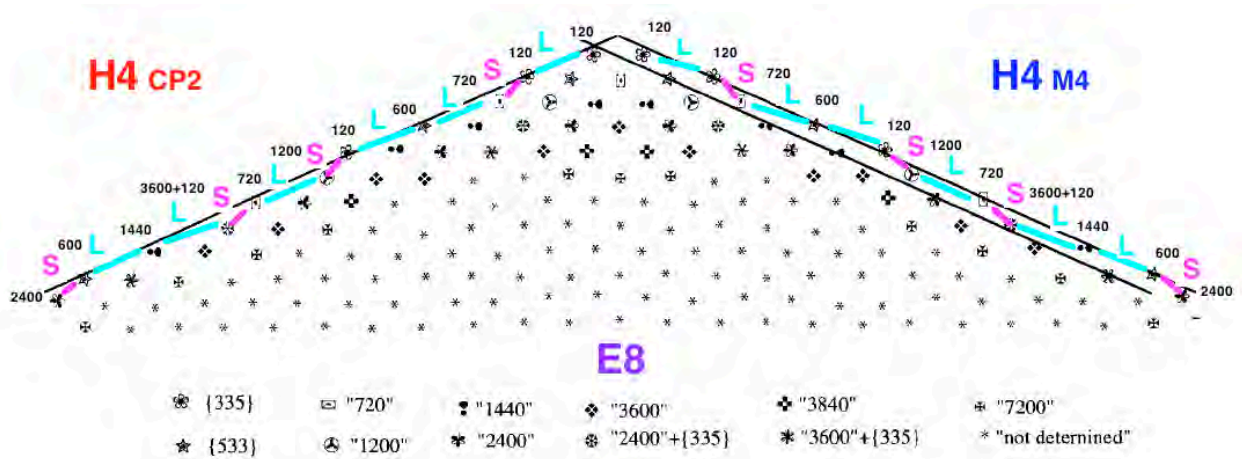

How does the Schwinger Source look on larger scales ?

In the 4D M4 Minkowski Physical Spacetime part of M4 x CP2 Kaluza-Klein it looks like a Gravitational Black Hole.

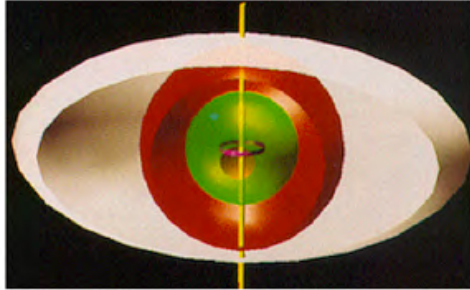

Ergosphere (white), Outer Event Horizon (red), Inner Event Horizon (green), and Ring Singularity (purple)
from Black Holes - A Traveller's Guide, by Clifford Pickover (Wiley 1996).

**David Finkelstein invented the one-way membrane of the Black Hole.
David's Black Hole can be generalized to deal with Spin
and the. (-1 +1) Charge of the U(2) ElectroWeak Force**

The generalization is called a Kerr-Newman Black Hole,

The Zeldovich-Hawking Process,
in which a Virtual Particle-AntiParticle Pair near the Event Horizon can be separated
with one of the Virtual Pair going into the Black Hole
and
the other going into External Spacetime,

can be applied to Quark-AntiQuark Virtual Pairs showing that

a Black Hole can carry Color Charge of the SU(3) Color Force.

What is the Geometrical Symmetry Structure of each type of Schwinger Source?

Neutrino:

Volume in 4D Minkowski M4 is Complex Bounded Domain type IV4
with Symmetric Space Spin(6) / Spin(4)xU(1) Lie Ball
and Shilov Boundary RP1 x S3 Lie Sphere

Volume in 8D is Complex Bounded Domain type IV8
with Symmetric Space Spin(10) / Spin(8)xU(1) Lie Ball
and Shilov Boundary RP1 x S7 Lie Sphere

By Triality the 8D M4 Spacetime Shilov Boundary Lie Sphere
is isomorphic to the 8D CP2 Fermion Particle Symmetry Space
Lie Sphere RP1 x S7 Shilov Boundary
with basis $\{1, i, j, k, E, I, J, K\} = \{Nu, rDQ, gDQ, bDq, E, rUQ, gUQ, bUQ\}$
and
to the corresponding
8D CP2 Fermion AntiParticle Symmetry Space

Conformal Gravity has 15 generators.
1 is the Dilaton corresponding to the Higgs
4 are Special Conformal corresponding to Dark Energy
10 are anti-deSitter for Einstein-Hilbert Gravity
2 of the 10 are Cartan Subalgebra
8 of the 10 can carry Charges
6 of the 8 carry SU(3) Color Charge (R G B)
2 of the 8 can carry U(2) ElectroWeak Charge (-1 +1)
1 of the 2 carries Charge 0 of the Neutrino
which gives the Neutrino mass formula a Graviton factor of 0
so that the tree-level Neutrino mass is Zero.

The Neutrino is only related to the RP1 of $S^7 \times RP^1$
because the Neutrino carries only no Charge
so
the Neutrino should have at tree level
a spinor manifold volume factor $V(Q_{\text{neutrino}})$ of unit volume of Zero.

Electron:

Volume in 4D Minkowski M4 is Complex Bounded Domain type IV4
with Symmetric Space $\text{Spin}(6) / \text{Spin}(4) \times \text{U}(1)$ Lie Ball
and Shilov Boundary $\text{RP}^1 \times \text{S}^3$ Lie Sphere

Volume in 8D is Complex Bounded Domain type IV8
with Symmetric Space $\text{Spin}(10) / \text{Spin}(8) \times \text{U}(1)$ Lie Ball
and Shilov Boundary $\text{RP}^1 \times \text{S}^7$ Lie Sphere

By Triality the 8D M4 Spacetime Shilov Boundary Lie Sphere
is isomorphic to the 8D CP2 Fermion Particle Symmetry Space
Lie Sphere $\text{RP}^1 \times \text{S}^7$ Shilov Boundary
with basis $\{1, i, j, k, E, I, J, K\} = \{\text{Nu}, \text{rDQ}, \text{gDQ}, \text{bDq}, \text{E}, \text{rUQ}, \text{gUQ}, \text{bUQ}\}$
and
to the corresponding
8D CP2 Fermion AntiParticle Symmetry Space

Conformal Gravity has 15 generators.
1 is the Dilaton corresponding to the Higgs
4 are Special Conformal corresponding to Dark Energy
10 are anti-deSitter for Einstein-Hilbert Gravity
2 of the 10 are Cartan Subalgebra
8 of the 10 can carry Charges
6 of the 8 carry SU(3) Color Charge (R G B)
2 of the 8 can carry U(2) ElectroWeak Charge (-1 +1)
1 of the 2 carries Charge +1 of the Electron
which gives the Electron mass formula a Graviton factor of 1.

The Electron is only related to the equatorial $\text{S}^1 = \text{U}(1)$ of the S^7 of $\text{S}^7 \times \text{RP}^1$
because the Electron carries only U(1) ElectroWeak Charge
so
the Electron should have
a spinor manifold volume factor $V(\text{Qelectron})$ of unit volume of $\text{S}^1 = \text{U}(1)$.

Down Quark (either Red, Green, or Blue):

Volume in 4D Minkowski M4 is Complex Bounded Domain type IV4
with Symmetric Space Spin(6) / Spin(4)xU(1) Lie Ball
and Shilov Boundary RP1 x S3 Lie Sphere

Volume in 8D is Complex Bounded Domain type IV8
with Symmetric Space Spin(10) / Spin(8)xU(1) Lie Ball
and Shilov Boundary RP1 x S7 Lie Sphere

By Triality the 8D M4 Spacetime Shilov Boundary Lie Sphere
is isomorphic to the 8D CP2 Fermion Particle Symmetry Space
Lie Sphere RP1 x S7 Shilov Boundary
with basis $\{1, i, j, k, E, I, J, K\} = \{N_u, rDQ, gDQ, bDq, E, rUQ, gUQ, bUQ\}$
and

to the corresponding
8D CP2 Fermion AntiParticle Symmetry Space

Conformal Gravity has 15 generators.
1 is the Dilaton corresponding to the Higgs
4 are Special Conformal corresponding to Dark Energy
10 are anti-deSitter for Einstein-Hilbert Gravity
2 of the 10 are Cartan Subalgebra
8 of the 10 can carry Charges
6 of the 8 carry SU(3) Color Charge (R G B)
which gives the Down Quark mass formula a Graviton factor of 6.

The Down Quarks correspond to Octonions i, j, k
which, by gluon interactions, can be taken into each other.

By also using weak boson interactions,
they can also be taken into I, J, and K, the red, blue, and green Up Quarks.
Given the Up and Down quarks, Pions can be formed from quark-antiquark pairs,
and the Pions can decay to produce electrons and neutrinos.

Therefore the Down Quarks are related to all parts of $S^7 \times RP^1$,
the compact manifold corresponding to $\{ 1, i, j, k, E, I, J, K \}$
and therefore a Down Quark should have

a spinor manifold volume factor $V(Q_{\text{down quark}})$ of the volume of $S^7 \times RP^1$.

The ratio of the Down Quark spinor manifold volume factor
to the Electron spinor manifold volume factor is

$$V(Q_{\text{down quark}}) / V(Q_{\text{electron}}) = V(S^7 \times RP^1) / 1 = \pi^5 / 3.$$

Since the first generation graviton factor is 6 for Down Quarks and 1 for Electron
 $m_d / m_e = 6 V(S^7 \times RP^1) = 2 \pi^5 = 612.03937$

Up Quark (either Red, Green, or Blue):

Volume in 4D Minkowski M4 is Complex Bounded Domain type IV4
with Symmetric Space Spin(6) / Spin(4)xU(1) Lie Ball
and Shilov Boundary RP1 x S3 Lie Sphere

Volume in 8D is Complex Bounded Domain type IV8
with Symmetric Space Spin(10) / Spin(8)xU(1) Lie Ball
and Shilov Boundary RP1 x S7 Lie Sphere

By Triality the 8D M4 Spacetime Shilov Boundary Lie Sphere
is isomorphic to the 8D CP2 Fermion Particle Symmetry Space
Lie Sphere RP1 x S7 Shilov Boundary
with basis $\{1, i, j, k, E, I, J, K\} = \{N_u, rDQ, gDQ, bDq, E, rUQ, gUQ, bUQ\}$
and
to the corresponding
8D CP2 Fermion AntiParticle Symmetry Space

Conformal Gravity has 15 generators.
1 is the Dilaton corresponding to the Higgs
4 are Special Conformal corresponding to Dark Energy
10 are anti-deSitter for Einstein-Hilbert Gravity
2 of the 10 are Cartan Subalgebra
8 of the 10 can carry Charges
6 of the 8 carry SU(3) Color Charge (R G B)
which gives the Up Quark mass formula a Graviton factor of 6.

As the up quarks correspond to I, J, and K,
which are the octonion transforms under E of i, j, and k of the down quarks,
the up quarks and down quarks have the same constituent mass
 $\mu_u = \mu_d$.

Antiparticles have the same mass as the corresponding particles.

Since the model only gives ratios of masses,
the mass scale is fixed so that the electron mass $m_e = 0.5110$ MeV.
Then, the constituent mass of the down quark is $m_d = 312.75$ MeV,
and the constituent mass for the up quark is $m_u = 312.75$ MeV.
These results when added up give a total mass of first generation fermion particles:
 $\Sigma m_{f1} = 1.877$ GeV

The proton mass is taken to be
the sum of the constituent masses of its constituent quarks
so
 $m_{\text{proton}} = m_u + m_u + m_d = 938.25$ MeV
which is close to the experimental value of 938.27 MeV.

Second and Third Generation Fermions:

First Generation Fermions are represented by Octonions with 8 basis elements { 1, i, j, k, E, I, J, K }

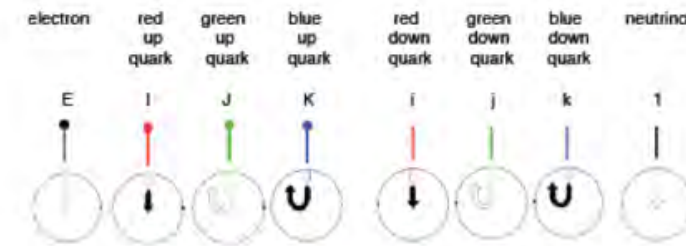

1 = 1 = Neutrino

1 = E = electron

3 = i, j, k = Down Quarks (r,g,b = 3)

3 = I, J, K = Up Quarks (r,g,b = 3)

Second Generation Fermions are represented by Pairs of Octonions with $8 \times 8 = 64$ basis elements

1 = {11} = Mu Neutrino

3 = 2+1 = {1E, E1, EE} = Muon

9 = 3x3 = {1r, r1, rr or 1g, g1, gg or 1b, b1, bb} = Strange Quarks (r,g,b = 3)

51 = 17x3 = Charm Quarks (r,g,b = 3)

Example: Blue Charm Quark

Rules: a Pair belongs to the Blue Charm Quark if:

1 - There is at least one Blue element and the other element is Blue or Colorless (black) and at least one element is NonAssociative (that is, is either E or I or J or K)

2 - There is one Red element and one Green element (Red x Green = Blue).



Third Generation Fermions are represented by Triples of Octonions
with $8 \times 8 \times 8 = 512$ basis elements

$$\begin{aligned}
 1 &= \{111\} = \text{Tau Neutrino} \\
 7 &= 3+3+1 = \{11E, 1E1, E11, EE1, E1E, 1EE, EEE\} = \text{Tauon} \\
 21 &= 7 \times 3 = \text{Beauty Quarks } (r, g, b = 3) \\
 483 &= 161 \times 3 = 23 \times 7 \times 3 = \text{Truth Quarks } (r, g, b = 3)
 \end{aligned}$$

Example: Blue Truth Quark

Rules: a Triple belongs to the Blue Truth Quark if:

- 1 - There is at least one Blue element and all other elements are Blue or Colorless (black) and at least one element is NonAssociative (that is, is either E or I or J or K)
- 2 - There is one Red element and one Green element and the other element is Colorless (Red x Green = Blue)
- 3 - The Triple has one element each that is Red, Green, or Blue, in which case the color of the Third element (for Third Generation) is determinative and must be Blue.

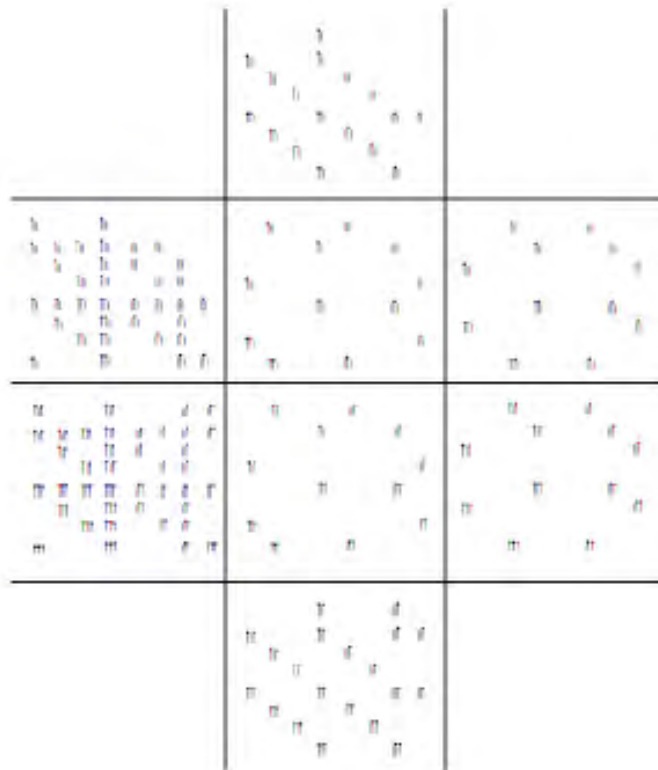

Photon

The Standard Model U(1) Electromagnetic Force bosons (photons) live in a U(1) subalgebra of the U(2) local group of $CP^2 = SU(3) / U(2)$
They "see" M4 Physical spacetime as four 1-sphere circles $S^1 \times S^1 \times S^1 \times S^1 = T^4$
($T^4 = 4$ -torus) each of whose dimension is 1 and has volume 2π

Their part of the Physical Lagrangian is

$\int_{T^4} (\text{U(1) Electromagnetism Gauge Boson Term})$
an integral over SpaceTime T^4 .

Schwinger Source for U(1) photons that carry no charge,
so the Complex Bounded Domains and Shilov Boundaries can be set equal to 1
and the Electromagnetic Force Strength is given by
the SpaceTime T^4 volume.

One fourth of the Electromagnetic Force Strength is give by 2π .

The total Electromagnetic Force Strength
relative to the geometric strength of Einstein-Hilbert Gravity is $1/137.03608$

The force strength is given at the characteristic energy level
of the generalized Bohr radius which for U(1) Electromagnetism is about 4KeV.

Weak Boson

The Standard Model SU(2) Weak Force bosons live in a SU(2) subalgebra of the U(2) local group of CP2 = SU(3) / U(2). They "see" M4 Physical spacetime as two 2-spheres S2 x S2 each of whose dimension is 2 and each of whose volume is 4 pi

Their part of the Physical Lagrangian is

$$\int_{S^2 \times S^2} \text{SU(2) Weak Force Gauge Boson Term}$$

an integral over SpaceTime S2 x S2.

Schwinger Source for SU(2) Weak Force bosons is the Complex Bounded Domain is two copies of IV3 Lie Ball each with Symmetric Space Lie Sphere Spin(5) / Spin(3)xU(1) and volume pi^3 / 24 and Shilov Boundary RP1 x S2 with volume 4 pi^2

Due to the action of the Higgs mechanism, for the Weak Force, the effective force strength that we see in our experiments is suppressed by the Weak Boson masses squared (1 / (MW+^2 + MW-^2 + MWO^2)). The unsuppressed Weak Force strength is the Geometric Part of the force strength.

One half of the Geometric Weak Force Strength is given by (4 pi) (4 pi^2) / (pi^3 / 24)^(1 / 2)

(pi^3 / 24)^(1 / 2) = (Vol(IV3))^(1 / 2) is a dimensional normalization factor to reconcile the dimensionality of the Internal Symmetry Space Bounded Domain with the dimensionality of Spacetime Lagrangian Base Manifold.

The geometric force strength, relative to the geometric strength of Einstein-Hilbert Gravity, of the Weak Force is 0.2535

The total force strength of the SU(2) Weak Force, including the suppression factor of the Weak Boson masses squared, is given by $G_w \times M_{\text{proton}}^2 = \text{about } 1.05 \times 10^{-5}$

Note that MWO is the mass of the SU(2) WO Weak boson that combines with the U(1) boson by the Higgs mechanism to form the Zo Weak boson and the Photon. MWO is about 98 GeV, MW+ = MW- is about 80 GeV, MZo is about 92 GeV, and the Photon is massless.

Gluon

The Standard Model SU(3) Color Force bosons (gluons) live in a SU(3) subalgebra of the SU(4) subalgebra of $D4 = Spin(8)$. They "see" M4 Physical spacetime as the complex projective plane CP2 whose dimension is 4 and whose volume is $8 \pi^2 / 3$

Their part of the Physical Lagrangian is

\int_{CP2} SU(3) Color Force Gauge Boson Term
CP2
an integral over SpaceTime CP2.

Schwinger Source for SU(3) Color Force bosons (gluons) is the Complex Bounded Domain B6 (ball) with Symmetric Space SU(4) / SU(3)xU(1) and volume $\pi^3 / 6$ and Shilov Boundary S5 with volume $4 \pi^3$

The Color Force Strength is given by
(Vol(CP2)) (Vol(S5) / Vol(B6)^(1 / 4))

$Vol(B6)^(1 / 4)$ is a dimensional normalization factor to reconcile the dimensionality of the Internal Symmetry Space Bounded Domain with the dimensionality of Spacetime Lagrangian Base Manifold.

The force strength, relative to the geometric strength of Einstein-Hilbert Gravity, of the SU(3) Color Force is 0.6286 at the characteristic energy level of the Color Force (about 245 MeV).

The color force strength was calculated using a simple perturbative QCD renormalization group equation at various energies, with the following results:
Energy Level Color Force Strength

245 MeV	0.6286
5.3 GeV	0.166
34 GeV	0.121
91 GeV	0.106

Taking other effects, such as Nonperturbative QCD, into account, should give a Color Force Strength of about 0.125 at about 91 GeV

Note (thanks to Carlos Castro for noticing these) that the volume listed for S5 is for a squashed S5, a Shilov boundary of the complex domain corresponding to the symmetric space SU(4) / SU(3) x U(1) and also that the volume listed for CP2 is unconventional, but physically justified by noting that S4 and CP2 can be seen as having the same physical volume, with the only difference being structure at infinity.

Conformal Graviton

The Gravity Gauge Bosons (Schwinger-Euclidean versions) live in a Spin(5) subalgebra of the Spin(6) Conformal subalgebra of $D4 = Spin(8)$. They "see" M4 Physical spacetime as the 4-sphere S^4 whose dimension is 4 and whose volume is $8 \pi^2 / 3$

Their part of the Physical Lagrangian is

\int_{S^4} Gravity Gauge Boson Term
 S^4 .
 an integral over SpaceTime S^4 .

Schwinger Source for Spin(5) MacDowell-Mansouri Gravity bosons is the Complex Bounded Domain IV5 Lie Ball with Symmetric Space Lie Sphere Spin(7) / Spin(5)xU(1) and volume $\pi^5 / 2^4 5!$ and Shilov Boundary $RP^1 \times S^4$ with volume $8 \pi^3 / 3$

Due to Stabilization of Condensate SpaceTime by virtual Planck Mass Gravitational Black Holes, the effective force strength of Gravity that we see in our experiments is suppressed by the square of the Planck Mass ($1 / M_{\text{planck}}^2$). The unsuppressed Gravity force strength is the Geometric Part of the force strength.

The Geometric Einstein-Hilbert Gravity Strength is given by
 ($\text{Vol}(S^4)$) ($\text{Vol}(IV5) / \text{Vol}(RP^1 \times S^4)^{1/4}$)

$\text{Vol}(RP^1 \times S^4)^{1/4}$ is a dimensional normalization factor to reconcile the dimensionality of the Internal Symmetry Space Bounded Domain with the dimensionality of Spacetime Lagrangian Base Manifold.

The geometric force strength, relative to the geometric strength of Einstein-Hilbert Gravity, of Spin(5) MacDowell-Mansouri Gravity is obviously 1.

The total force strength G_{grav} of Spin(5) MacDowell-Mansouri Gravity, including the Planck Mass squared suppression factor, is given by
 $G_{\text{grav}} \times M_{\text{proton}}^2 = \text{about } 5 \times 10^{(-39)}$

Higgs

Higgs = Fermion Particle-AntiParticle Condensate,
especially Truth Quark - Truth AntiQuark

Quantum Bohmion

Quantum Bohmion = spin-2 traceless of 26D World-Line-String Theory

Quantum Kernel Functions and Schwinger Source Green's Functions

Fock "Fundamental of Quantum Mechanics" (1931) showed that it requires Linear Operators "... represented by a definite integral [of a]... kernel ... function ...".

Hua "Harmonic Analysis of Functions of Several Complex Variables in the Classical Domains" (1958) showed Kernel Functions for Complex Classical Domains.

Schwinger (1951 - see Schweber, PNAS 102, 7783-7788) "... introduced a description in terms of Green's functions, what Feynman had called propagators ... The Green's functions are vacuum expectation values of time-ordered Heisenberg operators, and the field theory can be defined non-perturbatively in terms of these functions ...[which]... gave deep structural insights into QFTs; in particular ... the structure of the Green's functions when their variables are analytically continued to complex values ...".

Wolf (J. Math. Mech 14 (1965) 1033-1047) showed that the Classical Domains (complete simply connected Riemannian symmetric spaces) representing 4-dim Spacetime with Quaternionic Structure are:

$$\begin{aligned} S^1 \times S^1 \times S^1 \times S^1 &= 4 \text{ copies of } U(1) \\ S^2 \times S^2 &= 2 \text{ copies of } SU(2) \\ CP^2 &= SU(3) / SU(2) \times U(1) \\ S^4 = Spin(5) / Spin(4) &= \text{Euclidean version of } Spin(2,3) / Spin(1,3) \end{aligned}$$

Armand Wyler (1971 - C. R. Acad. Sc. Paris, t. 271, 186-188) showed how to use **Green's Functions = Kernel Functions** of Classical Domain structures characterizing **Sources = Leptons, Quarks, and Gauge Bosons,** to calculate **Particle Masses and Force Strengths**

Schwinger (1969 - see physics/0610054) said: "... operator field theory ... replace[s] the particle with ... properties ... distributed throughout ... small volumes of three-dimensional space ... particles ... must be created ... even though we vary a number of experimental parameters ... The properties of the particle ... remain the same ... We introduce a quantitative description of the particle source in terms of a source function ... we do not have to claim that we can make the source arbitrarily small ... the experimenter... must detect the particles ...[by]... collision that annihilates the particle ... the source ... can be ... an abstraction of an annihilation collision, with the source acting negatively, as a sink ... The basic things are ... the source functions ... describing the intermediate propagation of the particle ...".

Creation and Annihilation operators indicate a Clifford Algebra, and 8-Periodicity shows that the basic Clifford Algebra is formed by tensor products of 256-dim $Cl(8)$ such as $Cl(8) \times Cl(8) = Cl(16)$ containing 248-dim $E_8 = 120\text{-dim } D_8 + 128\text{-dim } D_8$ half-spinor whose maximal contraction is a realistic generalized Heisenberg Algebra

$$h_{92} \times A_7 = 5\text{-graded } 28 + 64 + ((SL(8, R) + 1) + 64 + 28$$

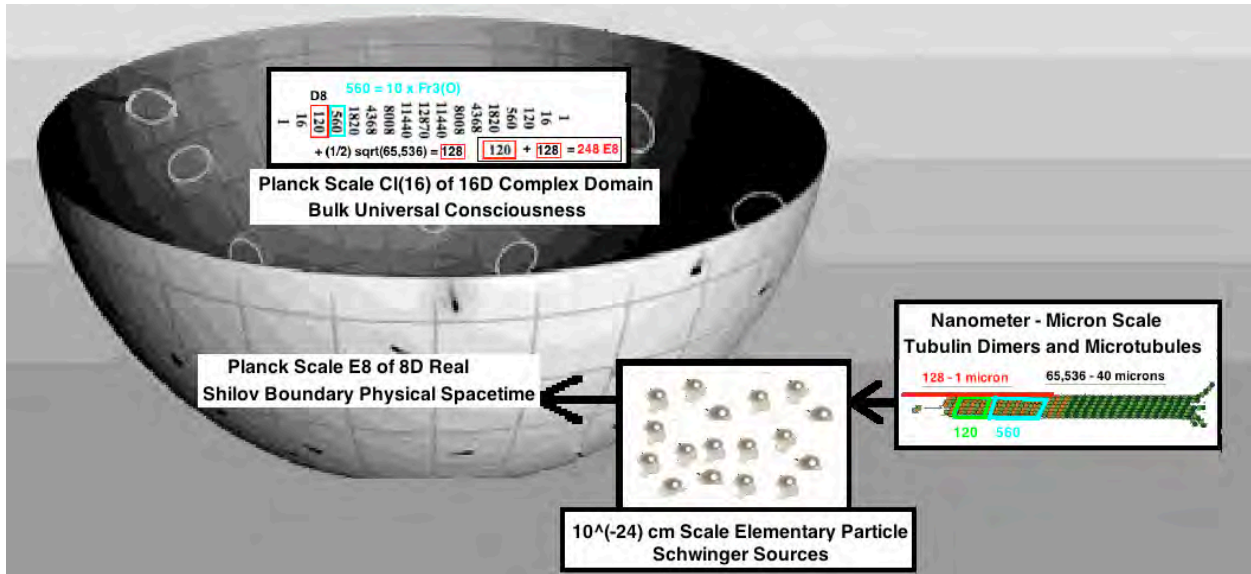

In E8-Cl(16) Physics **Spacetime is the 8-dimensional Shilov Boundary RP1 x S7** of the **Type IV8 Bounded Complex Domain Bulk Space** of the Symmetric Space Spin(10) / Spin(8)xU(1) which **Bulk Space** has 16 Real dimensions and is the Vector Space of the Real Clifford Algebra Cl(16).

By 8-Periodicity,

Cl(16) = tensor product Cl(8) x Cl(8) = Real 256x256 Matrix Algebra M(R,256) and so has 256x256 = 65,536 elements.

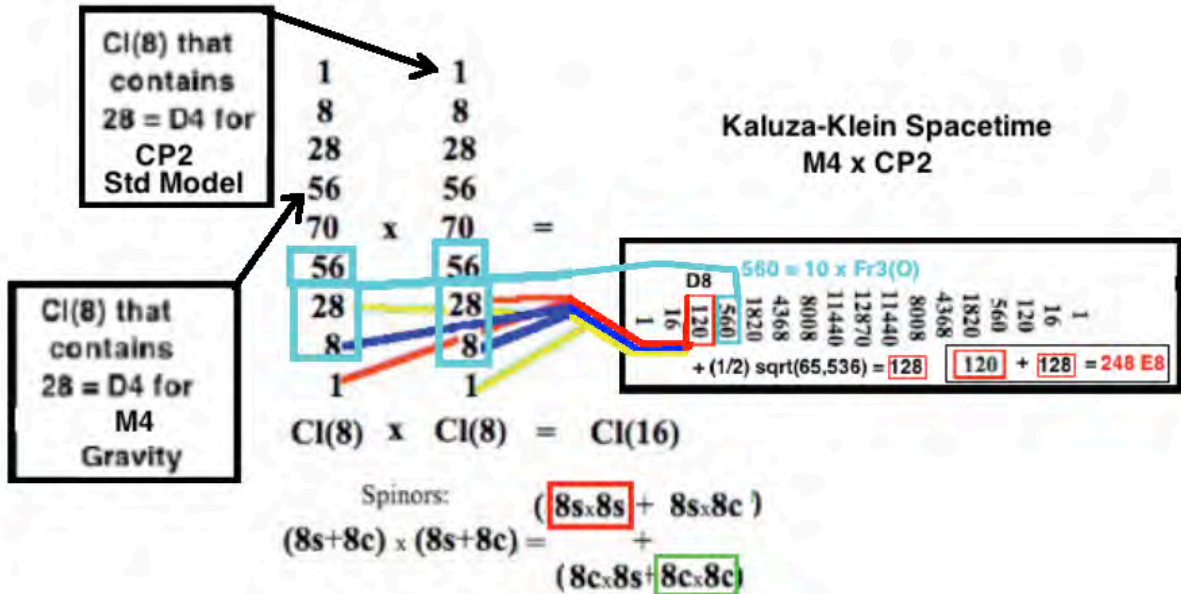

Cl(8) has 8 Vectors, 28 BiVectors, and 16 Spinors with 8+28+16 = 52 = F4 Lie Algebra and has 56 TriVectors for the Fr3(O) Freudenthal Algebra of World-Line String Theory.

Cl(16) has 120 BiVectors, and 128 Half-Spinors with 120+128 = 248 = E8 Lie Algebra, and has 560 TriVectors for 10 copies of Fr3(O).

The 248 E8 elements of Cl(16) define a Lagrangian for the Standard Model and for Gravity - Dark Energy so that $65,536 - 248 - 560 = 64,728$ elements of Cl(16) can carry Bits of Information.

The Complex Bulk Space Cl(16) contains the Maximal Contraction of E8 which is $H_{92} + A_7$ a generalized Heisenberg Algebra of Quantum Creation-Annihilation Operators with graded structure

$$28 + 64 + ((SL(8,R)+1) + 64 + 28$$

We live in the Physical Minkowski M4 part of Kaluza-Klein M4 x CP2 structure of RP1 x S7 **Boundary**.

(where CP2 = SU(3) / SU(2)xU(1) is Internal Symmetry Space of Standard Model gauge groups)

Our Consciousness is based on Binary States of Tubulin Dimers (each 4x4x8 nm size) in Microtubules.

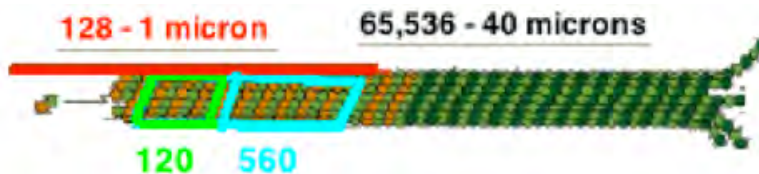

Microtubules are cylinders of sets of 13 Dimers with maximal length about 40,000 nm so that each Microtubule can contain about $13 \times 40,000 / 8 = 65,000$ Bits of Information. The Physical Boundary in which we live is a Real Shilov Boundary in which E8 is manifested as Lagrangian Structure of Real Forms of E8 with Lagrangian Symmetric Space structure:

E8 / D8 = (OxO)P2 for 8 First-Generation Fermion Particles and 8 First-Generation Fermion AntiParticles (8 components of each)
D8 / D4 x D4 for 8-dim spacetime paths, one for each of 8 Fermion Types
D4 for Standard Model Gauge Bosons and Gravity - Dark Energy Ghosts
D4 for Gravity - Dark Energy Gauge Bosons, Propagator Phase, and Standard Model Ghosts

Microtubule Information in the Physical Shilov Boundary has Resonant Connection to Cl(16) Information in Bulk Complex Domain Spacetime by the spin-2 Bohm Quantum Potential with Sarfatti Back-Reaction of 26D String Theory of World-Lines consistent with Poisson Kernel as derivative of Green's function.

The Bulk Space Complex Domain Type IV8 corresponds to the Symmetric Space Spin(10) / Spin(8)xU(1) and is a Lie Ball whose Shilov Boundary RP1 x S7 is a Lie Sphere 8-dim Spacetime. It is related to the Stiefel Manifold $V(10,2) = Spin(10) / Spin(8)$ of dimension $20-3 = 17$ by the fibration

$$Spin(10) / Spin(8)xU(1) \rightarrow V(10,2) \rightarrow U(1)$$

It can also be seen as a tube $z = x + iy$ whose imaginary part is physically inverse momentum so that its points give both position and momentum (see R. **Coquereaux** Nuc. Phys. B. 18B (1990) 48-52 "Lie Balls and Relativistic Quantum Fields").

In "Harmonic Analysis of Functions of Several Complex Variables in the Classical Domains" L. K. **Hua** said: "... Editor's Foreword ... M. I. Graev ...

Poisson kernel can be defined in group-theoretic terms. Let \mathfrak{R} be one of the domains considered in the book, and \mathfrak{C} its characteristic manifold. Let z be a point in \mathfrak{R} and C_z the group of those analytic automorphisms of \mathfrak{R} which leave z invariant. It can be shown that the group C_z is transitive on \mathfrak{C} , i.e., transforms any point of \mathfrak{C} into any other point. The measure on \mathfrak{C} which is invariant under the transformations in C_z is then simply equal to the Poisson kernel.

...[Characteristic Manifold = Shilov Boundary]...

In 1935, E. Cartan [1] proved that there exist only six types of irreducible homogeneous bounded symmetric domains. Beside the four types, RI, RII, RIII, RIV there exist only two; their dimensions are 16 and 27.
 [16-Complex-Dimensional $E_6 / Spin(10) \times U(1) = (C \times O)P_2$
 27-Complex-Dimensional $E_7 / E_6 \times U(1) = J(3, (C \times O))$]

The domain \mathfrak{R}_{IV} of n -dimensional ($n > 2$) vectors

$$z = (z_1, z_2, \dots, z_n)$$

(z_k are complex numbers) satisfying the conditions:

$$|zz'|^2 + 1 - 2zz' > 0, \quad |zz'| < 1.$$

The complex dimension of the four domains is $mn, n(n+1)/2, n(n-1)/2, n$.

The author has shown (cf. L. K. Hua [3]) that \mathfrak{R}_{IV} can also be regarded as a homogeneous space of $2 \times n$ real matrices. Therefore, the study of all these domains can be reduced to a study of the geometry of matrices.

The manifolds $\mathfrak{C}_I, \mathfrak{C}_{II}, \mathfrak{C}_{III}$ and \mathfrak{C}_{IV} have real dimension $m(2n-m), n(n+1)/2, n(n-1)/2 + (1+(-1)^n)(n-1)/2$ and n , respectively.

The characteristic manifold of the domain \mathfrak{R}_{IV} consists of vectors of the form $e^{i\theta}x$, where $0 \leq \theta \leq \pi$, and $x = (x_1, \dots, x_n)$ is a real vector which satisfies the condition $xx' = 1$.

$$H(z, \theta, x) = \frac{1}{V(\mathfrak{C}_{IV}) [(x - e^{-i\theta}z)(x - e^{-i\theta}z)']^{n/2}},$$

the magnitude of the volume $V(\mathfrak{C}_{IV})$:
$$V(\mathfrak{C}_{IV}) = \frac{2\pi^{\frac{n}{2}+1}}{\Gamma\left(\frac{n}{2}\right)}.$$

The Bergman kernel of the domain \mathfrak{R}_{IV} is

$$\frac{1}{V(\mathfrak{R}_{IV})} (1 + |zz'|^2 - 2\bar{z}z')^{-n},$$

where, $V(\mathfrak{R}_{IV}) = \frac{\pi^n}{2^{n-1} \cdot n!}.$

THE POISSON KERNEL FOR \mathfrak{R}_{IV}

$$P(z, \xi) = \frac{1}{V(\mathfrak{R}_{IV})} \cdot \frac{(1 + |zz'|^2 - 2\bar{z}z')^{\frac{n}{2}}}{|(z - \xi)(z - \xi)'|^n},$$

where $\xi \in \mathfrak{E}_{IV}.$

HARMONIC ANALYSIS ON LIE SPHERES

$$\int_{\mathfrak{R}_{IV}} |zz'|^{2l} \Phi_{f-2l}(z, \bar{z}) \bar{z}$$

$$= (N_{f-2l} - N_{f-2l-2}) \frac{l \Gamma(n) \Gamma\left(\frac{n}{2} + 1\right) \Gamma\left(f + \frac{n}{2} - l\right)}{2\pi^{\frac{n}{2}} \Gamma\left(l + \frac{n}{2} + 1\right) \Gamma(f + n - l)} V(\mathfrak{R}_{IV}).$$

...".

In Annals of Mathematics 55 (1952) 19-33 P. R. **Garabedian** said “...

we turn here to a more direct development of the theory of boundary value problems associated with the Cauchy-Riemann equations for analytic functions of several complex variables.

This boundary value problem is solved by means of a Dirichlet principle, and we introduce a Green's function in terms of which the solution can be expressed as a boundary integral. A formula giving the Bergman kernel function for several variables [1] in terms of this Green's function is obtained, and we thus generalize known theorems from the theory of functions of one complex variable

for analytic functions of several complex variables.

Bergman [1] defines a kernel function $k(z, t)$, analytic in z and \bar{t} for $z, t \in D$

THEOREM 3. *The analytic kernel function $k(z, t)$ with*

$$g(t) = \int_D g(z) \overline{k(z, t)} d\tau$$

for each analytic function g in D has the representation

$k(z, t) = \Delta_z \theta(z, t)$ in terms of the Green's function $\theta(z, t)$.

...”

E8 Physics constructs the **Lagrangian** integral such that the **mass m emerges as the integral over the Schwinger Source spacetime region** of its Kerr-Newman cloud of virtual particle/antiparticle pairs plus the Valence Fermion so that the volume of the Schwinger Source fermion defines its mass, which, being dressed with the particle/antiparticle pair cloud, gives **quark mass as constituent mass**.

The problem of the determination of the quark masses is not trivial. We can define as a “current” quark mass the mass entering in the Lagrangian (or Hamiltonian) representation of a hadron; this comes out to be of the order of some MeV/c^2 for u, d quarks, and $\sim 0.2 \text{ GeV}/c^2$ for s quarks. However, the strong field surrounds the quarks in such a way that they acquire a “constituent” (effective) mass including the equivalent of the color field; this comes out to be of the order of some $300 \text{ MeV}/c^2$ for u, d quarks, and $\sim 0.5 \text{ GeV}/c^2$ for s quarks. Current quark masses are almost the same as constituent quark mass for heavy quarks. Alessandro De Angelis · Mário Pimenta

Introduction to Particle and Astroparticle Physics Second Edition

Armand Wyler used Harmonic Geometry to calculate:

Fermion masses as a product of four factors:

$$V(\text{Qfermion}) \times N(\text{Graviton}) \times N(\text{octonion}) \times \text{Sym}$$

$V(\text{Qfermion})$ is the volume of the part of the half-spinor fermion particle manifold $S^7 \times \mathbb{R}P^1$ related to the fermion particle by photon, weak boson, or gluon interactions.

$N(\text{Graviton})$ is the number of types of $\text{Spin}(0,5)$ graviton related to the fermion.

$N(\text{octonion})$ is an octonion number factor relating up-type quark masses to down-type quark masses in each generation.

Sym is an internal symmetry factor, relating 2nd and 3rd generation massive leptons to first generation fermions. It is not used in first-generation calculations.

Force Strengths are made up of two parts:

- the relevant spacetime manifold of gauge group global action
 - the U(1) photon sees 4-dim spacetime as $T^4 = S^1 \times S^1 \times S^1 \times S^1$
 - the SU(2) weak boson sees 4-dim spacetime as $S^2 \times S^2$
 - the SU(3) weak boson sees 4-dim spacetime as CP^2
 - the Spin(5) of gravity sees 4-dim spacetime as S^4
- and

the volume of the Shilov boundary corresponding to the symmetric space with local symmetry of the gauge boson. The nontrivial Shilov boundaries are:

for SU(2) Shilov = $RP^1 \times S^2$

for SU(3) Shilov = S^5

for Spin(5) Shilov = $RP^1 \times S^4$

Schwinger Sources as described above are continuous manifold structures of Bounded Complex Domains and their Shilov Boundaries but the E8-Cl(16) model at the Planck Scale has spacetime condensing out of Clifford structures forming a Lorentz Leech lattice underlying 26-dim String Theory of World-Lines

with $8 + 8 + 8 = 24$ -dim of fermion particles and antiparticles and of spacetime.

The automorphism group of a single 26-dim String Theory cell modulo the Leech lattice is the Monster Group of order about 8×10^{53} .

The Monster Group is of order

8080 , 17424, 79451, 28758, 86459, 90496, 17107, 57005, 75436, 80000, 00000
=

$2^{46} \cdot 3^{20} \cdot 5^9 \cdot 7^6 \cdot 11^2 \cdot 13^3 \cdot 17 \cdot 19 \cdot 23 \cdot 29 \cdot 31 \cdot 41 \cdot 47 \cdot 59 \cdot 71$

or about 8×10^{53}

This chart (from Wikipedia) shows the Monster M and other Sporadic Finite Groups

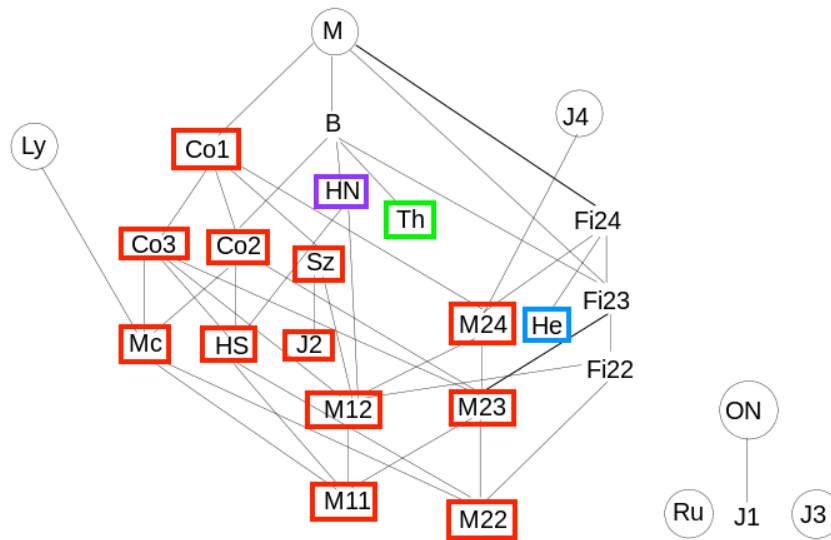

The order of Co1 is $2^{21} \cdot 3^9 \cdot 5^4 \cdot 7^2 \cdot 11 \cdot 13 \cdot 23$ or about 4×10^{18} .

Aut(Leech Lattice) = double cover of Co1.

The order of the double cover $2 \cdot \text{Co1}$ is $2^{22} \cdot 3^9 \cdot 5^4 \cdot 7^2 \cdot 11 \cdot 13 \cdot 23$ or about 0.8×10^{19} .

Taking into account the non-sporadic part of the Leech Lattice symmetry

according to the ATLAS at brauer.maths.qmul.ac.uk/Atlas/v3/spor/M/

the Schwinger Source Kerr-Newman Cloud Symmetry $s 2^{(1+24)} \cdot \text{Co1}$

of order $139511839126336328171520000 = 1.4 \times 10^{26}$

Co1 and its subgroups account for 12 of the 19 subgroups of the Monster M.

Of the remaining 7 subgroups, Th and He are independent of the Co1 related

subgroups and HN has substantial independent structure.

Th = Thompson Group. Wikipedia says "... Th ... was ... constructed ... as the automorphism group of a certain lattice in the 248-dimensional Lie algebra of E8.

It does not preserve the Lie bracket of this lattice, but

does preserve the Lie bracket mod 3, so is a subgroup of the Chevalley group E8(3).

The subgroup preserving the Lie bracket (over the integers) is a maximal

subgroup of the Thompson group called the Dempwolff group (which unlike the

Thompson group is a subgroup of the compact Lie group E8) ...

the Thompson group acts on a vertex operator algebra over the field with 3 elements.

This vertex operator algebra contains the E8 Lie algebra over \mathbf{F}_3 ,

giving the embedding of Th into E8(3) ...

The Schur multiplier and the outer automorphism group of ... Th ... are both trivial.

Th is a sporadic simple group of order $215 \cdot 310 \cdot 53 \cdot 72 \cdot 13 \cdot 19 \cdot 31$

$= 90745943887872000 \approx 9 \times 10^{16}$...".

He = Held Group. Wikipedia says "... The smallest faithful complex representation has dimension 51; there are two such representations that are duals of each other.

It centralizes an element of order 7 in the Monster group. ...

the prime 7 plays a special role in the theory of the group ...

the smallest representation of the Held group over any field is

the 50 dimensional representation over the field with 7 elements ...

He ... acts naturally on a vertex operator algebra over the field with 7 elements ...

The outer automorphism group has order 2 and the Schur multiplier is trivial. ...

He is a sporadic simple group of order $210 \cdot 33 \cdot 52 \cdot 73 \cdot 17$

$= 4030387200 \approx 4 \times 10^9$...".

HN = Harada-Norton Group. Wikipedia says "... The prime 5 plays a special role ...

it centralizes an element of order 5 in ... the Monster group ...and as a result acts

naturally on a vertex operator algebra over the field with 5 elements ... it acts on

a 133 dimensional algebra over \mathbf{F}_5 with a commutative but nonassociative product ...

Its Schur multiplier is trivial and its outer automorphism group has order 2 ...

HN is a sporadic simple group of order $2^{14} \cdot 3^6 \cdot 5^6 \cdot 7 \cdot 11 \cdot 19$

$= 273030912000000 \approx 3 \times 10^{14}$...

HN has an involution whose centralizer is of the form $2.HS.2$, where HS is the Higman-Sims group ... of order $2^9 \cdot 3^2 \cdot 5^3 \cdot 7 \cdot 11 = 44352000 \approx 4 \times 10^7$... [whose] Schur multiplier has order 2 ... [and whose] outer automorphism group has order 2 ... HS is ... a subgroup of ... the Conway groups Co0, Co2 and Co3 ...”.

Co1 x Th x He x HN / HS together have order about $4 \times 9 \times 4 \times 10^{(18+16+9+7)}$
 = about 10^{52} which is close to the order of M = about 10^{54} .

The components of the Monster Group describe the composition of Schwinger Sources:

Co1 gives the number of particles in the Schwinger Source Kerr-Newman Cloud emanating from a Valence particle in a Planck-scale cell of E8 Physics SpaceTime.

Th gives the 3-fold E8 Triality structure relating 8-dim SpaceTime to First-Generation Fermion Particles and AntiParticles.

He gives the 7-fold algebraically independent Octonion Imaginary E8 Integral Domains that make up 7 of the 8 components of Octonion Superposition E8 SpaceTime.

HN / HS gives the 5-fold symmetry of 120-element Binary Icosahedral E8 McKay Group beyond the 24-element Binary Tetrahedral E6 McKay Group at which level the Shilov Boundaries of Bounded Complex Domains emerge to describe SpaceTime and Force Strengths and Particle Masses.

When a fermion particle/antiparticle appears in E8 spacetime it does not remain a single Planck-scale entity because **Tachyons create a cloud of particles/antiparticles**. The cloud is one Planck-scale Fundamental Fermion Valence Particle plus an effectively neutral cloud of particle/antiparticle pairs forming a Kerr-Newman black hole. That cloud constitutes the **Schwinger Source**. Its **structure comes from the 24-dim Leech lattice part of the Monster Group which is**

$2^{(1+24)}$ times the double cover of Co1, for a total order of about 10^{26} .

Since a Leech lattice is based on copies of an E8 lattice and since there are 7 distinct E8 integral domain lattices there are 7 (or 8 if you include a non-integral domain E8 lattice) distinct Leech lattices. The physical Leech lattice is a superposition of them, effectively adding a factor of 8 to the order.

The volume of the Kerr-Newman Cloud is on the order of 10^{27} x Planck scale, so the Kerr-Newman Cloud **Source should contain about 10^{27} particle/antiparticle pairs and its size should be about $10^{(27/3)} \times 1.6 \times 10^{(-33)}$ cm = roughly $10^{(-24)}$ cm.**

Schwinger Source QuasiCrystal Internal Structure

Above the scale of Schwinger Sources (10^{-24} cm) E8-CI(16) Physics structures such as Spacetime, Symmetric Spaces, and Bounded Complex Domains and their Shilov Boundaries, are well approximated by smooth manifolds so that the geometric techniques of Amand Wyler give good results for force strengths, particle masses, etc.

Below the scale of Schwinger Sources (10^{-24} cm down to Planck 10^{-33} cm) the fundamental structures are E8 lattices and QuasiCrystals derived therefrom. Planck Scale is about 10^{-33} cm. Schwinger Souce Scale is about 10^{-24} cm, a scale about 10^9 larger than the Planck Scale.

The 240 E8 Root Vector Vertices of each cell of 8D E8-CI(16) Physics Spacetime can be represented in 2D as done by Ray Aschheim

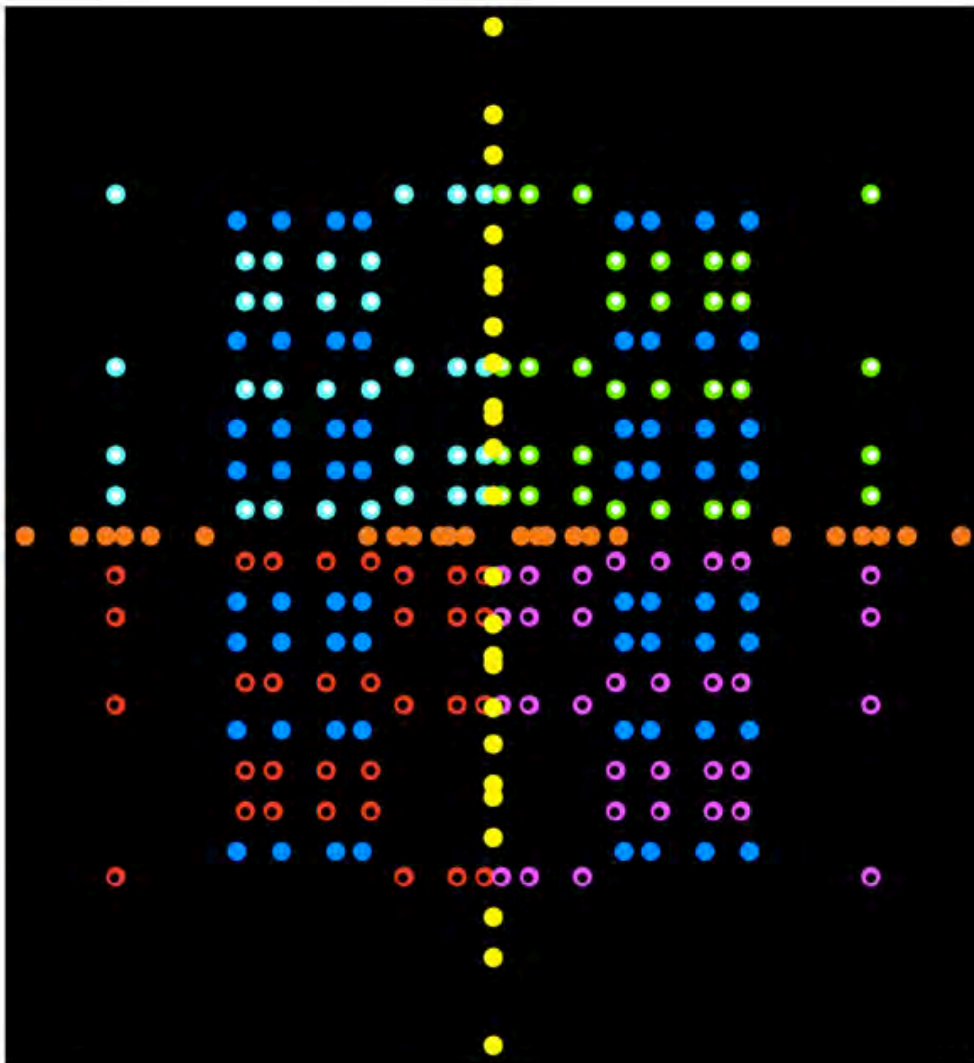

The E8-CI(16) Physical interpretation of the 240 E8 Root Vectors is

E8 / D8 for 8-dim Spacetime components of 8+8 First-Generation Fermions

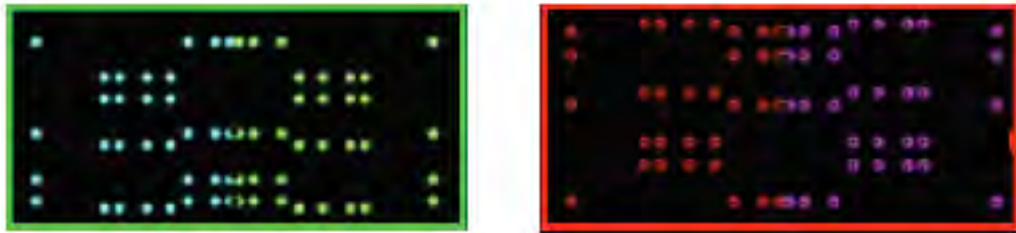

Green and Cyan dots with white centers (32+32 = 8x8 dots)
for Fermion Particles
and
Red and Magenta dots with black centers (32+32 = 8x8 dots)
for Fermion AntiParticles

D8 / D4 x D4 for Spacetime Superposition of 8 types of E8 Lattice

The 64 generators (8x8 = 64 blue dots) correspond to an 8-dim base manifold of an E8 Lagrangian in which Spacetime 8V of 26D String Theory is represented by 8-branes whose Planck-Scale Lattice Structure is that of a superposition of 8 types of E8 Lattice: 7 E8 Integral Domains corresponding to the 7 Imaginary Octonion Basis Elements and 1 E8 Lattice (not an Integral Domain - Kirmse's Mistake) corresponding to the Octonion Real Axis. The 64 Blue Root Vectors of the space D8 / D4 x D4 also represent the $A_{7+1} = SL(8, R) + 1$ in the Maximal Contraction Heisenberg Algebra of E8 with structure $28 + 64 + (A_{7+1}) = 64 + 28$ where A_7 is Unimodular $SL(8, R)$ Gravity.

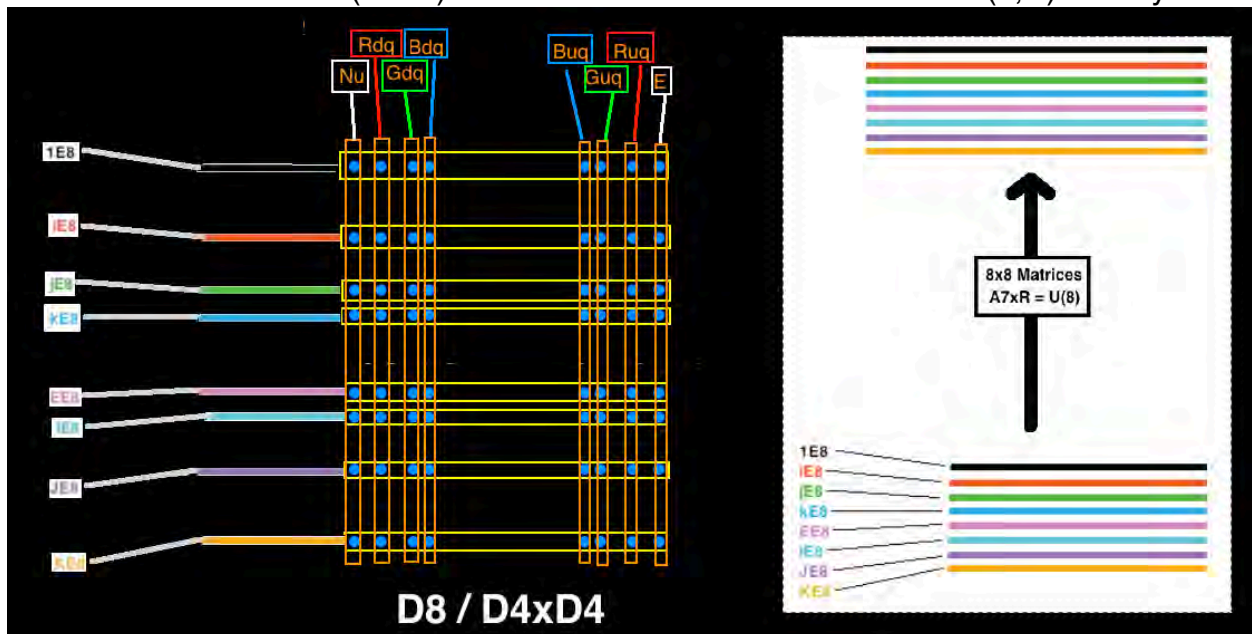

The map from one 8-brane superposition to the next is by 8x8 Matrices representing the central grade-0 part A_{7+1} of the Heisenberg Maximal Contraction Algebra of E8,

D4 for Gravity - Dark Energy Gauge Bosons and Standard Model Ghosts



The 24 Yellow Root Vectors of the D4 of E8 Gravity + Standard Model Ghosts are on the Vertical Y-axis.

12 of them in the Yellow Box represent the 12 Root Vectors of the Conformal Gauge Group $SU(2,2) = Spin(2,4)$ of Conformal Gravity + Dark Energy.

The 4 Cartan Subalgebra elements of $SU(2,2) \times U(1) = U(2,2)$ correspond to the 4 Cartan Subalgebra elements of D4 of E8 Gravity + Standard Model Ghosts and to the other half of the 8 Cartan Subalgebra elements of E8.

The other $24 - 12 = 12$ Yellow Root Vectors represent Ghosts of 12D Standard Model whose Gauge Groups are $SU(3) SU(2) U(1)$.

Gravity and Dark Energy come from its Conformal Subgroup $SU(2,2) = Spin(2,4)$
(see Appendix - Details of Conformal Gravity and ratio DE : DM : OM)

$SU(2,2) = Spin(2,4)$ has 15 generators:

1 Dilation representing Higgs Ordinary Matter

4 Translations representing Primordial Black Hole Dark Matter

10 = 4 Special Conformal + 6 Lorentz representing Dark Energy
(see Irving Ezra Segal, "Mathematical Cosmology and Extragalactic Astronomy" (Academic 1976))

The basic ratio Dark Energy : Dark Matter : Ordinary Matter = 10:4:1 = 0.67 : 0.27 : 0.06
When the dynamics of our expanding universe are taken into account, the ratio is calculated to be **0.75 : 0.21 : 0.04**

The $U(1)$ of $SU(2,2) \times U(1) = U(2,2)$ represents the Propagator Phase Internal Clock

D4 for Standard Model Gauge Bosons and Gravity - Dark Energy Ghosts

The 24 Orange Root Vectors of the D4 of E8 Standard Model + Gravity Ghosts are on the Horizontal X-axis.



8 of them in the Orange Box represent the 8 Root Vectors of the Standard Model Gauge Groups SU(3) SU(2) U(1).

Their 4 Cartan Subalgebra elements correspond to the 4 Cartan Subalgebra elements of D4 of E8 Standard Model + Gravity Ghosts and to half of the 8 Cartan Subalgebra elements of E8.

The other 24-8 = 16 Orange Root Vectors represent Ghosts of 16D U(2,2) which contains the Conformal Group SU(2,2) = Spin(2,4) that produces Gravity + Dark Energy by the MacDowell-Mansouri mechanism.

Standard Model Gauge groups come from CP2 = SU(3) / SU(2) x U(1)

(as described by Batakis in Class. Quantum Grav. 3 (1986) L99-L105)

Electroweak SU(2) x U(1) is gauge group as isotropy group of CP2.

SU(3) is global symmetry group of CP2 but due to Kaluza-Klein M4 x CP2 structure of compact CP2 at every M4 spacetime point, it acts as Color gauge group with respect to M4.

Here is how the 240 E8 Root Vectors define an 8D Lagrangian:

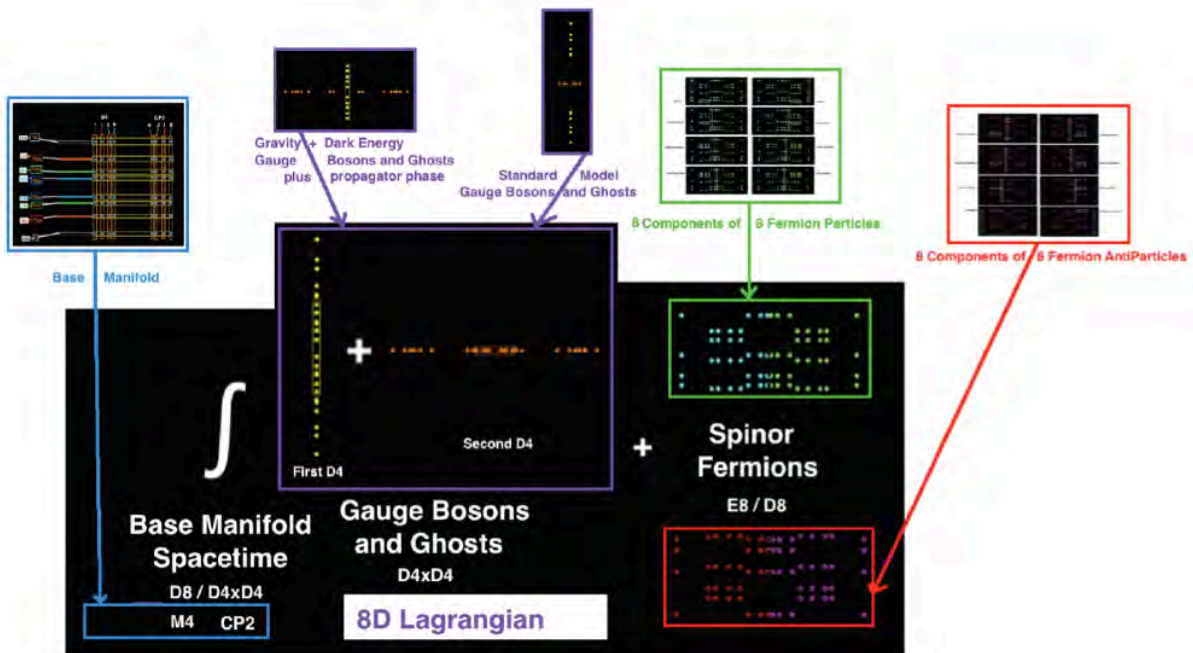

Here is how the 8D Lagrangian goes to 4D Lagrangian of M4 x CP2 Kaluza-Klein so that the Higgs and Fermion Generations 2 and 3 emerge:

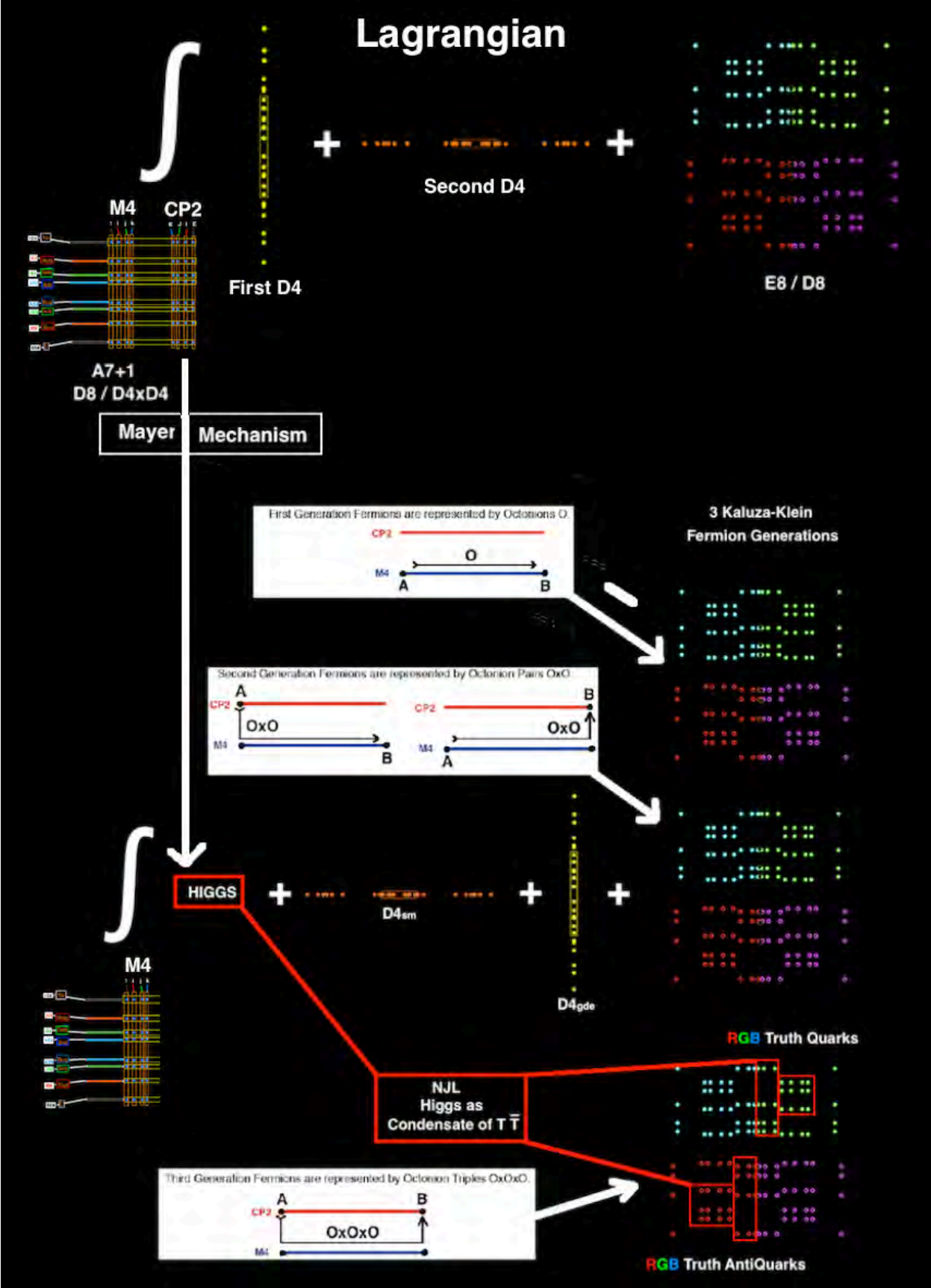

This mapping of the shell structure of a full E8 Lattice is adapted from the book "Geometrical Frustration" by Sadoc and Mosseri

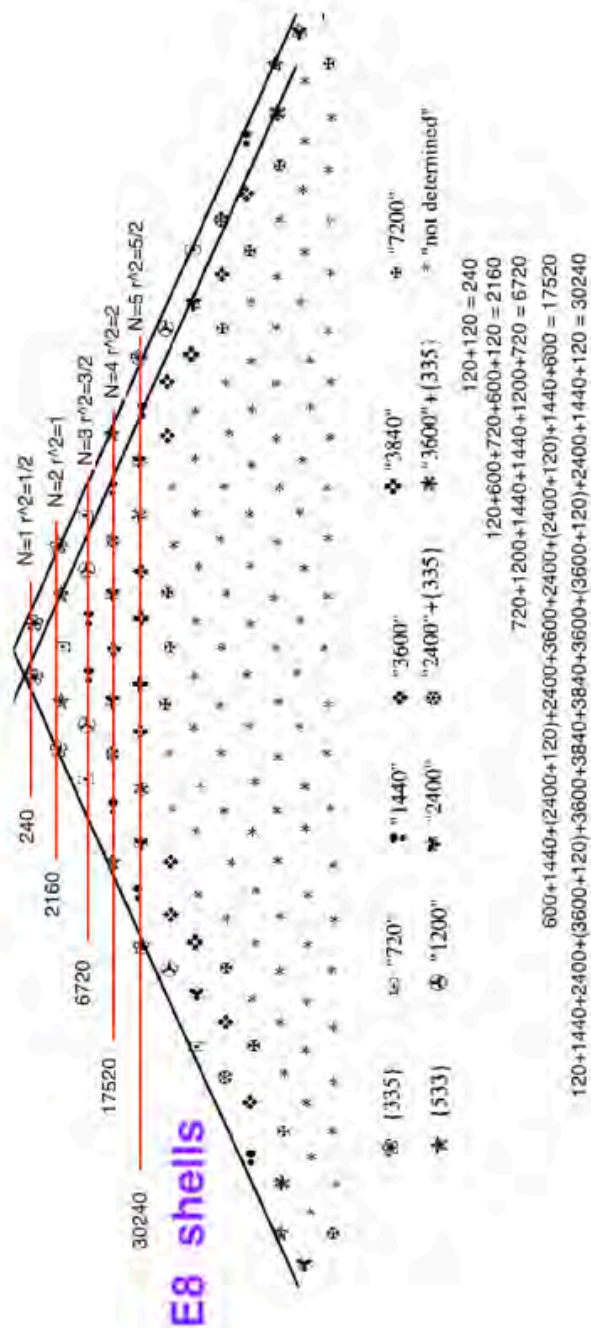

If you consider only the Root Vectors neighboring the Origin of the Lattices,
 that is, only the first Lattice shell, then you see that
 the 240 Root Vectors of E8 are made up of two copies of the 120 Root Vectors of H4

One H4 describes the Standard Model and is related to CP2 of M4 x CP2 Kaluza-Klein.

The other describes Conformal Gravity + Dark Energy and U(1) Propagator Phase
 and is related to M4 of M4 x CP2 Kaluza-Klein.

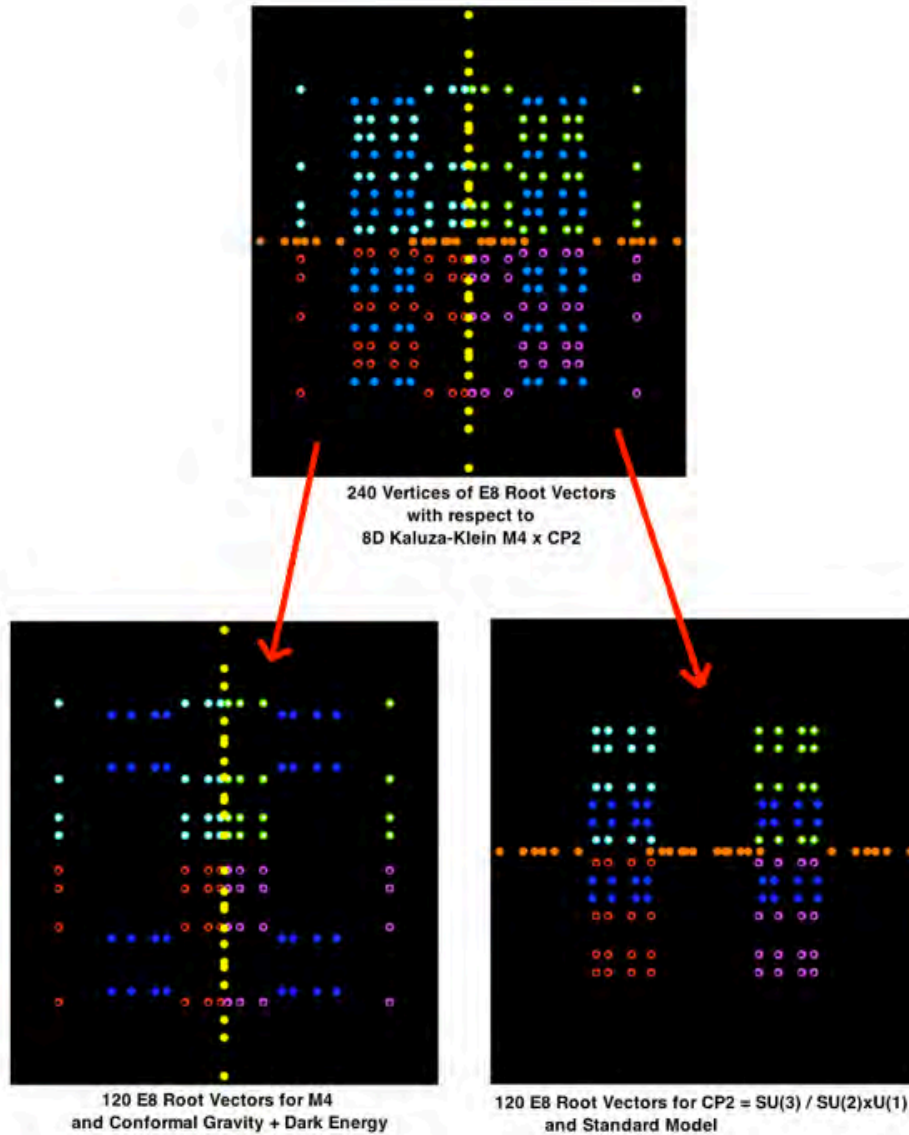

The 120 Root Vectors for H4 tiling of M4 Minkowski Physical Spacetime (H4 M4)
 and
 the 120 Root Vectors for H4 tiling of CP2 Internal Symmetry Space (H4 CP2)
 form two 600-cells, one with Golden Ratio edge length (define it to be for M4)
 and the other with Unit edge length (define it to be for CP2)

To see the internal structure of a Schwinger Source look at the M4 part of M4 x CP2 Kaluza-Klein Spacetime and choose a Fermion Type whose Schwinger Source structure you want to see (for example, Electron).

First, chose only those E8 Lattice vertices with CP2 coordinates = zero so that you have only M4 coordinates being non-zero. Here is a schematic diagram of how E8 Lattice breaks down into H4 CP2 Lattice and H4 M4 Lattice

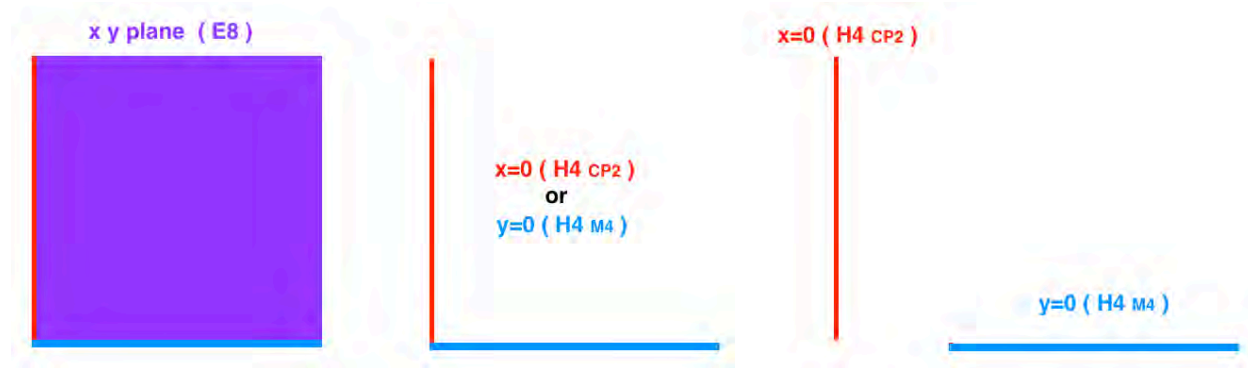

Then project from 8D E8 Lattice space to 4D H4 Lattice space for M4 in which each 4D H4 Lattice vertex is surrounded by 120 vertices at Golden Ratio distance from the origin point.

Then select the Fermion (Electron in this example) that is located at the M4 coordinates of the origin point.

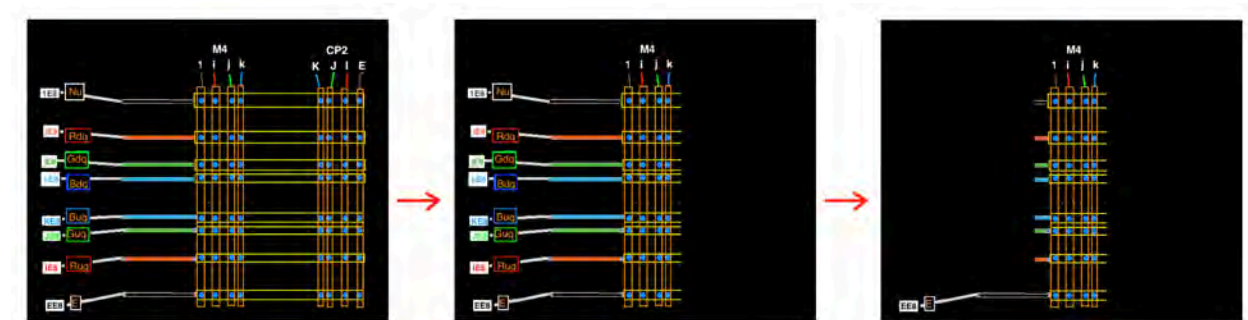

The image on the far right is the representation of

a Valence Electron at the M4 coordinates of the origin point

which is surrounded by its 120 nearest-neighbor vertices which are all at Golden Ratio distance and which form a 600-cell

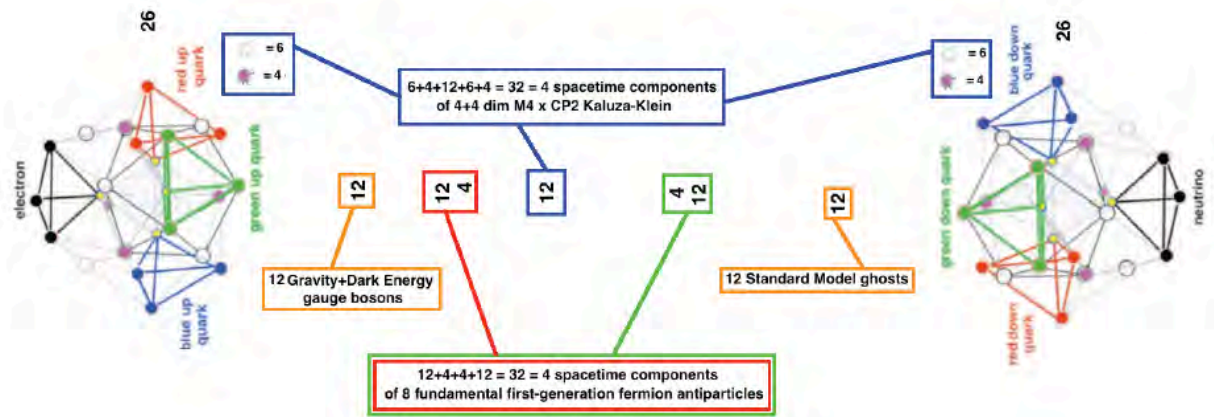

in which the Electron and its M4 coordinates are represented by the Tetrahedron of 4 vertices at the top (far left) of the 600-cell.

A more detailed view how full E8 Lattice breaks down into full H4 CP2 Qiasicrystal Lattice and full H4 M4 Quasicrystal Lattice is shown on the following page, where you can see some interesting phenomena, such as:

The E8 lattice (interior of the diagram) is periodic, a property inherited from its 8-dimensional structure.

Both the H4 M4 and H4 CP2 Lattices are Fibonacci-type Quasicrystals with chain structure L S L L S L S L L S ... inherited from the fact that some E8 lattice lines are longer than the preceding line by 2 and others are longer by 4.

All the things in the H4 M4 Fibonacci Chain are Golden Ratio larger than the corresponding things in the H4 CP2 Fibonacci Chain.

The H4 CP2 Quasicrystal determines the Standard Model Internal Symmetry of its Schwinger Source through $CP2 = SU(3) / SU(2) \times U(1)$.

The H4 M4 Quasicrystal determines the Spacetime Properties, including filling the volume, of the Schwinger Source through the Conformal $U(2,2)$ symmetry.

The size and volume of the Schwinger Source (10^{-24} cm and 10^{27} particle-antiparticle pairs) is imposed on the H4 M4 Quasicrystal by the Monster symmetry of Lattice Spacetime at the Planck scale, and then imposed on the H4 CP2 Quasicrystal by symmetry with H4 M4.

The Indra Net mirroring ability of each of the 10^{27} virtual elements of a Schwinger Source is of the order of the Monster Group of the Spacetime Lattice Cell of the Valence H4 M4 600-cell which is on the order of 10^{53} , so that the total mirroring capacity of a single Schwinger Source is $10^{27} \times 10^{53} = 10^{80}$ which is enough mirroring capacity to maintain an Indra's Net Blockchain System of all the particles in Our Universe.

H4 CP2

H4 M4

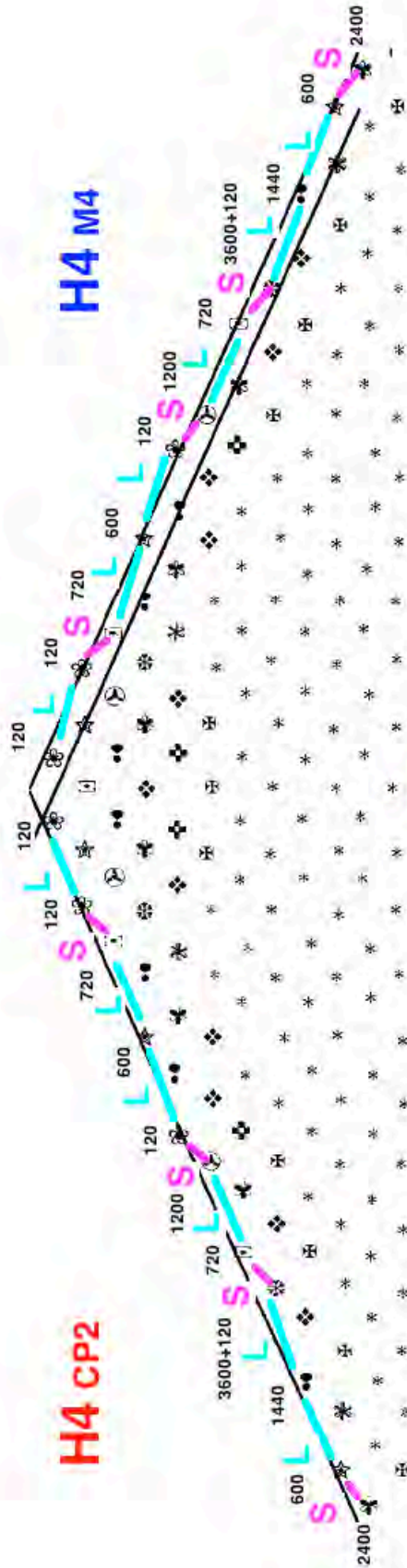

☉ {335}

☉ "720"

☉ "1440"

☉ "3600"

☉ "3840"

☉ "7200"

★ {533}

☉ "1200"

☉ "2400"

☉ "2400"+{335}

☉ "3600"+{335}

* "not determined"

Indra's Net of Schwinger Sources

Each Schwinger Source particle-antiparticle pair should see (with Bohm Potential) the rest of our Universe in the perspective of 8×10^{53} Monster Symmetry so a **Schwinger Source acting as a Jewel of Indra's Net** of Schwinger Source Bohm Quantum Blockchain Physics (viXra 1801.0086)
can see / reflect $10^{27} \times 8 \times 10^{53} = 8 \times 10^{80}$ Other Schwinger Source Jewels of Indra's Net.

How many Schwinger Sources are in the Indra's Net of Our Universe ?

Based on gr-qc/0007006 by Paola Zizzi, the Inflation Era of Our Universe ended with Quantum Decoherence when its number of qubits reached 2^{64} for $Cl(64) = Cl(8)^8$ self-reflexivity whereby each $Cl(8)$ 8-Periodicity component corresponded to each basis element of the $Cl(8)$ Vector Space.

At the End of Inflation, each of the 2^{64} qubits transforms into 2^{64} elementary first-generation fermion particle-antiparticle pairs. The resulting $2^{64} \times 2^{64}$ pairs constitute a Zizzi Quantum Register of order $2^{64} \times 2^{64} = 2^{128}$.

At Reheating time $T_n = (n+1) T_{Planck}$ the Register has $(n+1)^2$ qubits so at Reheating Our Universe has $(2^{128})^2 = 2^{256} = 10^{77}$ qubits and since each qubit corresponds to fermion particle-antiparticle pairs that average about 0.66 GeV so

the number of particles in our Universe at Reheating is about 10^{77} nucleons which, being less than 10^{80} , can be reflected by Schwinger Source Indra Jewels.

The Reheating process raises the energy/temperature at Reheating to $E_{reh} = 10^{14}$ GeV, the geometric mean of the $E_{Planck} = 10^{19}$ GeV and $E_{decoh} = 10^{10}$ GeV.

After Reheating, our Universe enters the Radiation-Dominated Era, and, since there is no continuous creation, particle production stops, so the **10^{77} nucleon Baryonic Mass of our Universe has been mostly constant since Reheating**

Indra's Net

"... "Indra's net" is the net of the Vedic deva Indra, whose net hangs over his palace on Mount Meru, the axis mundi of Buddhist and Hindu cosmology. In this metaphor, Indra's net has a multifaceted jewel at each vertex, and each jewel is reflected in all of the other jewels ... the image of "Indra's net" is used to describe the interconnectedness of the universe ... Francis H Cook describes Indra's net thus:
"Far away in the heavenly abode of the great god Indra, there is a wonderful net ... a single glittering jewel in each "eye" of the net ... in ... each of the jewels ... its polished surface ... reflect[s] all the other jewels in the net ... Not only that, but each of the jewels reflected in this one jewel is also reflecting all the other jewels ..."

Image from <https://brightwayzen.org/meetings-placeholder/indras-net-honoring-interdependence-scales/> :

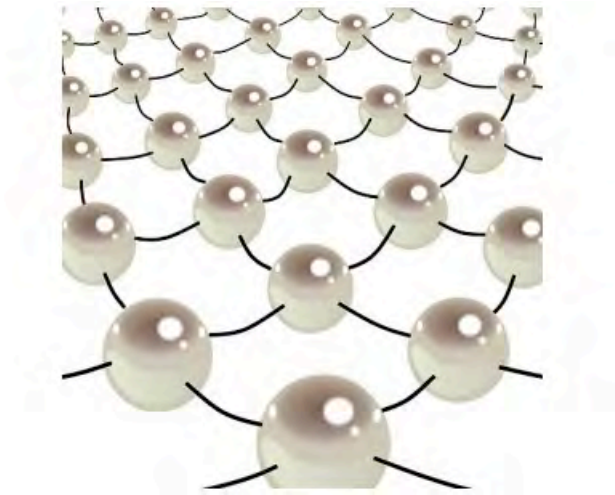

In E8-Cl(16) Physics each Indra Jewel is a Schwinger Source.

26D Freudenthal Fr₃(O) String Theory - Bohm Quantum Potential

To understand **Schwinger Sources of E8 Physics start with 26D String Theory:**
interpret **Strings as World-Lines** of Particles and
spin-2 String Theory 24x24 symmetric matrices
as carriers of **Bohm Quantum Potential** (not gravitons).

Luis E. Ibanez and Angel M. Uranga in “String Theory and Particle Physics” said:
“... String theory proposes ... small one-dimensional extended objects, strings,
of typical size $L_s = 1/M_s$, with M_s known as the string scale ...
As a string evolves in time, it sweeps out a two-dimensional surface in spacetime,
known as the worldsheet, which is the analog of the ... worldline of a point particle ...
for the bosonic string theory ... the classical string action is the total area spanned by
the worldsheet ... This is the ... Nambu– Goto action ...”.



(images adapted from “String Theory and Particle Physics” by Ibanez and Uranga)
In my unconventional view the red line and the green line are different strings/
worldlines/histories and the world-sheet is the minimal surface connecting them,
carrying the Bohm Potential.

The t world-sheet coordinate is for Time of the string-world-line history.

The σ world-sheet coordinate is for Bohm Potential Gauge Boson at a given Time.

Further, Ibanez and Uranga also said:

“... The string ground state corresponds to a 26d spacetime tachyonic scalar field $T(x)$. This tachyon ... is ... unstable

...

The massless two-index tensor splits into irreducible representations of $SO(24)$... Its trace corresponds to a scalar field, the dilaton ϕ , whose vev fixes the string interaction coupling constant g_s

...

the antisymmetric part is the 26d 2-form field BMN

...

The symmetric traceless part is the 26d graviton GMN ...”.

My interpretation of the symmetric traceless part differs from that of Ibanez and Uranga in that it is the carrier of the Bohm Quantum Potential.

Closed string tachyons localized at orbifolds of fermions produce virtual clouds of particles / antiparticles that dress fermions.

Dilatons are Goldstone bosons of spontaneously broken scale invariance that (analogous to Higgs) go from mediating a long-range scalar gravity-type force to the nonlocality of the Bohm-Sarfatti Quantum Potential.

The antisymmetric $SO(24)$ little group is related to the Monster automorphism group that is the symmetry of each cell of Planck-scale local lattice structure.

Joe Polchinski in “String Theory, Volume 1, An Introduction to the Bosonic String” said: “... we find at $m^2 = -4/\alpha'$ the tachyon, and at $m^2 = 0$ the 24×24 states of the graviton, dilaton, and antisymmetric tensor ...”.

My interpretation of what Polchinski describes as the graviton differs from that of Polchinski in that it is the carrier of the Bohm Quantum Potential.

The 24×24 Real Symmetric Matrices form the Jordan Algebra $J(24, R)$. 24 -Real-dim space has a natural Octonionic structure of 3 -Octonionic-dim space. The corresponding Jordan Algebra is $J(3, O) = 3 \times 3$ Hermitian Octonion matrices. **Their 26-dim traceless part $J(3, O)_o$ describes the 26-dim Bosonic String Theory and the algebra of its Quantum States, so that**

the 24×24 traceless symmetric spin-2 particle is the Quantum Bohmion that carries the Bohm Quantum Potential for interactions among Strings = World-Line Histories of Schwinger Sources.

Blockchain Structure of Bohm Quantum Potential

Andrew Gray in arXiv quant-ph/9712037 said:

“... probabilities are ... assigned to entire fine-grained histories ...
base[d] ... on the Feynman path integral formulation ...”

so in E8 Physics the Indra's Net of Schwinger Source Jewels
would not have Bohm Quantum Potential interactions between two Jewels,
rather **the interactions would be between the two entire World-Line History Strings**



(image adapted from <http://www.blockchaintechnologies.com/>)

According to <https://hbr.org/2017/01/the-truth-about-blockchain> “... **How Blockchain Works ...**

1. Distributed Database

Each party on a blockchain has access to the entire database and its complete history. No single party controls the data or the information. Every party can verify the records of its transaction partners directly, without an intermediary.

2. Peer-to-Peer Transmission

Communication occurs directly between peers instead of through a central node. Each node stores and forwards information to all other nodes.

3. Transparency with Pseudonymity

Every transaction and its associated value are visible to anyone with access to the system. Each node, or user, on a blockchain has a unique 30-plus-character alphanumeric address that identifies it. Users can choose to remain anonymous or provide proof of their identity to others. Transactions occur between blockchain addresses.

4. Irreversibility of Records

Once a transaction is entered in the database and the accounts are updated, the records cannot be altered, because they're linked to every transaction record that came before them (hence the term “chain”). Various computational algorithms and approaches are deployed to ensure that the recording on the database is permanent, chronologically ordered, and available to all others on the network.

5. Computational Logic

The digital nature of the ledger means that blockchain transactions can be tied to computational logic and in essence programmed. So users can set up algorithms and rules that automatically trigger transactions between nodes. ...”.

With respect to Bohm Quantum Potential of E8 Physics Schwinger Sources there is no Human directly controlling any Event / Interaction / Transaction, as they are all completely controlled by the Laws of Physics which define “algorithms and rules that automatically trigger transactions between nodes” .

Each Node is a Schwinger Source that is connected by Bohm Quantum Potential to all other Schwinger Source Nodes in our Universe and governed by the “algorithms and rules” of the E8 Physics Lagrangian and the Algebraic Quantum Field Theory arising from the completion of the union of all tensor products of copies of $Cl(16)$ each copy of $Cl(16)$ containing E8 and the E8 Lagrangian.

According to <http://www.blockchaintechnologies.com/> “... A blockchain is a type of distributed ledger, comprised of unchangable, digitally recorded data in packages called *blocks*. These digitally recorded "blocks" of data is stored in a linear *chain* ...



... A distributed ledger is a consensus of replicated, shared, and synchronized digital data geographically spread across multiple sites, countries, and/or institutions ...”

or, in the case of the E8 Physics Indra’s Net of Schwinger Source Jewels, spread across the entirety of our Universe.

The idea of Schwinger Sources as more than mere points is in David Finkelstein’s Space-Time Code 1968 in which David said “... “... What is too simple about general relativity is the space-time point ... each point of space-time is some kind of assembly of some kind of thing ... Each point, as Feynman once put it, has to remember with precision the values of indefinitely many fields describing many elementary particles; has to have data inputs and outputs connected to neighboring points; has to have a little arithmetic element to satisfy the field equations; and all in all might just as well be a complete computer ...”.

Wyler Force Strength and Mass Calculation

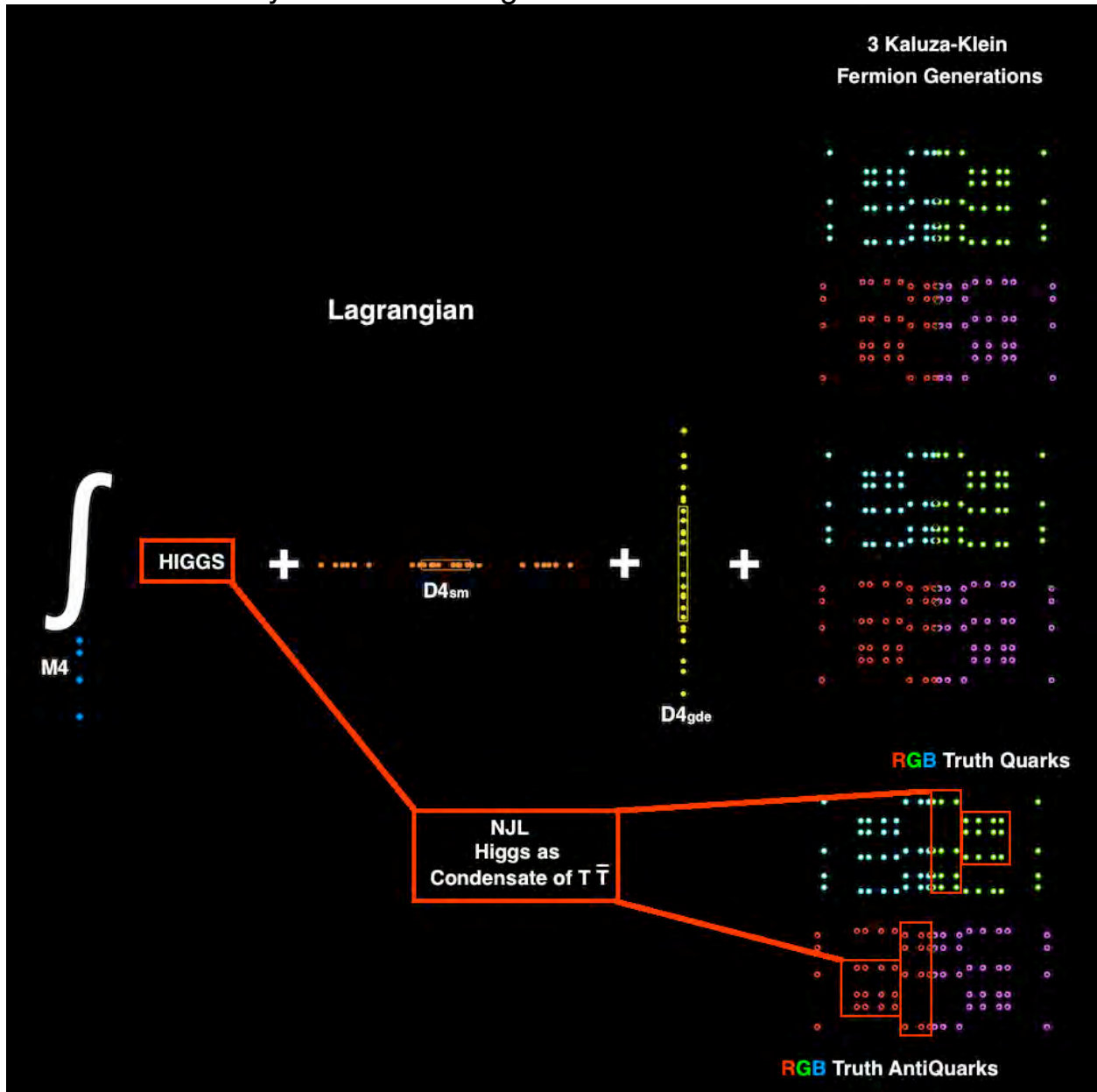

The E8 model constructs the Lagrangian integral such that the mass m emerges as the integral over the Schwinger Source spacetime region of its Kerr-Newman cloud of virtual particle/antiparticle pairs plus the valence fermion so that the volume of the Schwinger Source fermion defines its mass, which, being dressed with the particle/antiparticle pair cloud, gives quark mass as constituent mass.

Fermion Schwinger Sources correspond to the Lie Sphere Symmetric space

$$\text{Spin}(10) / \text{Spin}(8) \times U(1)$$

with Bounded Complex Domain $D8$ of type $IV8$ and Shilov Boundary $Q8 = RP1 \times S7$ which has local symmetry of the $\text{Spin}(8)$ gauge group from which the first generation spinor fermions are formed as **+half-spinor** and **-half-spinor** spaces

For the Gauge Gravity and Standard Model Gauge Bosons the process of breaking Octonionic 8-dim SpaceTime down to Quaternionic (4+4)-dim M4 x CP2 Kaluza-Klein creates differences in the way gauge bosons "see" 4-dim Physical SpaceTime. There are 4 equivalence classes of 4-dimensional Riemannian Symmetric Spaces with Quaternionic structure consistent with 4-dim Physical SpaceTime:

S_4 = 4-sphere = Spin(5) / Spin(4) where Spin(5) = Schwinger-Euclidean version of the Anti-DeSitter subgroup of the Conformal Group that gives **MacDowell-Mansouri Gravity**

CP_2 = complex projective 2-space = SU(3) / U(2) with **the SU(3) of the Color Force**

$S_2 \times S_2$ = SU(2)/U(1) x SU(2)/U(1) with two copies of **the SU(2) of the Weak Force**

$S_1 \times S_1 \times S_1 \times S_1$ = U(1) x U(1) x U(1) x U(1) = 4 copies of **the U(1) of the EM Photon** (1 copy for each of the 4 covariant components of the Photon)

The Gravity Gauge Bosons (Schwinger-Euclidean versions) live in a Spin(5) subalgebra of the Spin(6) Conformal subalgebra of D4 = Spin(8). They "see" M4 Physical spacetime as the 4-sphere S4 so that their part of the Physical Lagrangian is

\int Gravity Gauge Boson Term

S4 .

an integral over SpaceTime S4.

The Schwinger Sources for GRb bosons are the Complex Bounded Domains and Shilov Boundaries for Spin(5) MacDowell-Mansouri Gravity bosons.

However, due to Stabilization of Condensate SpaceTime

by virtual Planck Mass Gravitational Black Holes,

for Gravity, the effective force strength that we see in our experiments

is not just composed of the S4 volume and the Spin(5) Schwinger Source volume, but is suppressed by the square of the Planck Mass.

The unsuppressed Gravity force strength is the Geometric Part of the force strength.

The Standard Model SU(3) Color Force bosons live in a SU(3) subalgebra of the SU(4) subalgebra of D4 = Spin(8). They "see" M4 Physical spacetime as the complex projective plane CP2 so that their part of the Physical Lagrangian is

\int SU(3) Color Force Gauge Boson Term
CP2 .

an integral over SpaceTime CP2.

The Schwinger Sources for SU(3) bosons are the Complex Bounded Domains and Shilov Boundaries for SU(3) Color Force bosons. The Color Force Strength is given by the SpaceTime CP2 volume and the SU(3) Schwinger Source volume.

Note that since the Schwinger Source volume is dressed with the particle/antiparticle pair cloud, the calculated force strength is for the characteristic energy level of the Color Force (about 245 MeV).

The Standard Model SU(2) Weak Force bosons live in a SU(2) subalgebra of the U(2) local group of CP2 = SU(3) / U(2) They "see" M4 Physical spacetime as two 2-spheres S2 x S2 so that their part of the Physical Lagrangian is

\int SU(2) Weak Force Gauge Boson Term
S2xS2 .

an integral over SpaceTime S2xS2.

The Schwinger Sources for SU(2) bosons are the Complex Bounded Domains and Shilov Boundaries for SU(2) Weak Force bosons. However, due to the action of the Higgs mechanism, for the Weak Force, the effective force strength that we see in our experiments is not just composed of the S2xS2 volume and the SU(2) Schwinger Source volume, but is suppressed by the square of the Weak Boson masses.

The unsuppressed Weak Force strength is the Geometric Part of the force strength.

The Standard Model U(1) Electromagnetic Force bosons (photons) live in a U(1) subalgebra of the U(2) local group of CP2 = SU(3) / U(2) They "see" M4 Physical spacetime as four 1-sphere circles S1xS1xS1xS1 = T4 (T4 = 4-torus) so that their part of the Physical Lagrangian is

\int (U(1) Electromagnetism Gauge Boson Term
T4 .

an integral over SpaceTime T4.

The Schwinger Sources for U(1) photons are the Complex Bounded Domains and Shilov Boundaries for U(1) photons. The Electromagnetic Force Strength is given by the SpaceTime T4 volume and the U(1) Schwinger Source volume.

Force Strength and Boson Mass Calculation

The Force Strength is made up of two parts:
the relevant spacetime manifold of gauge group global action
and
the relevant symmetric space manifold of gauge group local action.

The 4-dim spacetime Lagrangian **GG SM** gauge boson term is:
the integral over spacetime as seen by gauge boson acting globally
of the gauge force term of the gauge boson acting locally
for the gauge bosons of each of the four forces:

U(1) for electromagnetism
SU(2) for weak force
SU(3) for color force

Spin(5) - compact version of antiDeSitter Spin(2,3) subgroup of Conformal Spin(2,4) for gravity by the MacDowell-Mansouri mechanism.

In the conventional picture,
for each gauge force the gauge boson force term contains the force strength,
which in Feynman's picture is the amplitude to emit a gauge boson,
and can also be thought of as the probability = square of amplitude,
in an explicit (like $g |F|^2$) or an implicit (incorporated into the $|F|^2$) form.
Either way, the conventional picture is that the force strength g is an ad hoc inclusion.

The E8 model does not put in force strength g ad hoc,
but constructs the integral such that
the force strength emerges naturally from the geometry of each gauge force.

To do that, for each gauge force:

1 - make the spacetime over which the integral is taken be spacetime as it is seen by that gauge boson, that is, in terms of the symmetric space with global symmetry of the gauge boson:

the U(1) photon sees 4-dim spacetime as $T^4 = S^1 \times S^1 \times S^1 \times S^1$
the SU(2) weak boson sees 4-dim spacetime as $S^2 \times S^2$
the SU(3) weak boson sees 4-dim spacetime as CP^2
the Spin(5) of gravity sees 4-dim spacetime as S^4

2 - make the gauge boson force term have the volume of the Shilov boundary corresponding to the symmetric space with local symmetry of the gauge boson.
The nontrivial Shilov boundaries are:

for SU(2) Shilov = $RP^1 \times S^2$
for SU(3) Shilov = S^5
for Spin(5) Shilov = $RP^1 \times S^4$

The result is (ignoring technicalities for exposition) the geometric factor for force strengths.

Each gauge group is the global symmetry of a symmetric space

$$\begin{aligned} S1 & \text{ for } U(1) \\ S2 & = SU(2)/U(1) = Spin(3)/Spin(2) \text{ for } SU(2) \\ CP2 & = SU(3)/SU(2) \times U(1) \text{ for } SU(3) \\ S4 & = Spin(5)/Spin(4) \text{ for } Spin(5) \end{aligned}$$

Each gauge group is the local symmetry of a symmetric space

$$\begin{aligned} & U(1) \text{ for itself} \\ & SU(2) \text{ for } Spin(5) / SU(2) \times U(1) \\ & SU(3) \text{ for } SU(4) / SU(3) \times U(1) \\ & Spin(5) \text{ for } Spin(7) / Spin(5) \times U(1) \end{aligned}$$

The nontrivial local symmetry symmetric spaces correspond to bounded complex domains

$$\begin{aligned} SU(2) \text{ for } Spin(5) / SU(2) \times U(1) & \text{ corresponds to } IV3 \\ SU(3) \text{ for } SU(4) / SU(3) \times U(1) & \text{ corresponds to } B^6 \text{ (ball)} \\ Spin(5) \text{ for } Spin(7) / Spin(5) \times U(1) & \text{ corresponds to } IV5 \end{aligned}$$

The nontrivial bounded complex domains have Shilov boundaries

$$\begin{aligned} SU(2) \text{ for } Spin(5) / SU(2) \times U(1) & \text{ corresponds to } IV3 \text{ Shilov} = RP^1 \times S^2 \\ SU(3) \text{ for } SU(4) / SU(3) \times U(1) & \text{ corresponds to } B^6 \text{ (ball) Shilov} = S^5 \\ Spin(5) \text{ for } Spin(7) / Spin(5) \times U(1) & \text{ corresponds to } IV5 \text{ Shilov} = RP^1 \times S^4 \end{aligned}$$

Very roughly, think of the force strength as

integral over global symmetry space of physical (ie Shilov Boundary) volume = strength of the force.

That is:

the geometric strength of the force is given by the product of the volume of a 4-dim thing with global symmetry of the force and the volume of the Shilov Boundary for the local symmetry of the force.

When you calculate the product volumes (using some tricky normalization stuff), you see that roughly:

Volume product for gravity is the largest volume

so since (as Feynman says) force strength = probability to emit a gauge boson means that the highest force strength or probability should be 1

the gravity Volume product is normalized to be 1, and so (approximately):

$$\begin{aligned} \text{Volume product for gravity} & = 1 \\ \text{Volume product for color} & = 2/3 \\ \text{Volume product for weak} & = 1/4 \\ \text{Volume product for electromagnetism} & = 1/137 \end{aligned}$$

There are two further main components of a force strength:

- 1 - for massive gauge bosons, a suppression by a factor of $1 / M^2$
- 2 - renormalization running (important for color force)

Consider Massive Gauge Bosons:

Gravity as curvature deformation of SpaceTime, with SpaceTime as a condensate of Planck-Mass Black Holes, must be carried by virtual Planck-mass black holes, so that the geometric strength of gravity should be reduced by $1/M_p^2$

The weak force is carried by weak bosons,

so that the geometric strength of the weak force should be reduced by $1/M_W^2$

That gives the result (approximate):

$$\begin{aligned} \text{gravity strength} &= G \text{ (Newton's } G\text{)} \\ \text{color strength} &= 2/3 \\ \text{weak strength} &= G_F \text{ (Fermi's weak force } G\text{)} \\ \text{electromagnetism} &= 1/137 \end{aligned}$$

Consider Renormalization Running for the Color Force:: That gives the result:

$$\begin{aligned} \text{gravity strength} &= G \text{ (Newton's } G\text{)} \\ \text{color strength} &= 1/10 \text{ at weak boson mass scale} \\ \text{weak strength} &= G_F \text{ (Fermi's weak force } G\text{)} \\ \text{electromagnetism} &= 1/137 \end{aligned}$$

The use of compact volumes is itself a calculational device, because it would be more nearly correct, instead of the integral over the compact global symmetry space of the compact physical (ie Shilov Boundary) volume=strength of the force to use the integral over the hyperbolic spacetime global symmetry space of the noncompact invariant measure of the gauge force term.

However, since the strongest (gravitation) geometric force strength is to be normalized to 1, the only thing that matters is ratios, and the compact volumes (finite and easy to look up in the book by Hua) have the same ratios as the noncompact invariant measures.

In fact, I should go on to say that continuous spacetime and gauge force geometric objects are themselves also calculational devices, and that it would be even more nearly correct to do the calculations with respect to a discrete generalized hyperdiamond Feynman checkerboard.

Here are more detailed force strength calculations:

The force strength of a given force is

$$\text{alphaforce} = (1 / \text{Mforce}^2) (\text{Vol}(\text{MISforce})) (\text{Vol}(\text{Qforce}) / \text{Vol}(\text{Dforce})^{(1 / \text{mforce})})$$

where:

alphaforce represents the force strength;

Mforce represents the effective mass;

MISforce represents the relevant part of the target Internal Symmetry Space;

Vol(MISforce) stands for volume of MISforce and is sometimes also denoted by Vol(M);

Qforce represents the link from the origin to the relevant target for the gauge boson;

Vol(Qforce) stands for volume of Qforce;

Dforce represents the complex bounded homogeneous domain of which Qforce is the Shilov boundary;

mforce is the dimensionality of Qforce, which is

4 for Gravity and the Color force,

2 for the Weak force (which therefore is considered to have two copies of QW for SpaceTime),

1 for Electromagnetism (which therefore is considered to have four copies of QE for SpaceTime)

$\text{Vol}(\text{Dforce})^{(1 / \text{mforce})}$ stands for a dimensional normalization factor (to reconcile the dimensionality of the Internal Symmetry Space of the target vertex with the dimensionality of the link from the origin to the target vertex).

The Qforce, Hermitian symmetric space, and Dforce manifolds for the four forces are:

Spin(5)	Spin(7) / Spin(5)xU(1)	IV5	4	RP ¹ xS ⁴
SU(3)	SU(4) / SU(3)xU(1)	B ⁶ (ball)	4	S ⁵
SU(2)	Spin(5) / SU(2)xU(1)	IV3	2	RP ¹ xS ²
U(1)	-	-	1	-

The geometric volumes needed for the calculations are mostly taken from the book Harmonic Analysis of Functions of Several Complex Variables in the Classical Domains (AMS 1963, Moskva 1959, Science Press Peking 1958) by L. K. Hua [unit radius scale].

Force	M	Vol(M)
gravity	S^4	$8\pi^2/3$ - S^4 is 4-dimensional
color	CP^2	$8\pi^2/3$ - CP^2 is 4-dimensional
weak	$S^2 \times S^2$	$2 \times 4\pi$ - S^2 is a 2-dim boundary of 3-dim ball 4-dim $S^2 \times S^2$ = topological boundary of 6-dim 2-polyball Shilov Boundary of 6-dim 2-polyball = $S^2 + S^2$ = = 2-dim surface frame of 4-dim $S^2 \times S^2$
e-mag	T^4	$4 \times 2\pi$ - S^1 is 1-dim boundary of 2-dim disk 4-dim $T^4 = S^1 \times S^1 \times S^1 \times S^1$ = topological boundary of 8-dim 4-polydisk Shilov Boundary of 8-dim 4-polydisk = $S^1 + S^1 + S^1 + S^1$ = = 1-dim wire frame of 4-dim T^4

Note (thanks to Carlos Castro for noticing this) also that the volume listed for CP^2 is unconventional, but physically justified by noting that S^4 and CP^2 can be seen as having the same physical volume, with the only difference being structure at infinity.

Note that for U(1) electromagnetism, whose photon carries no charge, the factors Vol(Q) and Vol(D) do not apply and are set equal to 1, and from another point of view, the link manifold to the target vertex is trivial for the abelian neutral U(1) photons of Electromagnetism, so we take QE and DE to be equal to unity.

Force	M	Vol(M)	Q	Vol(Q)	D	Vol(D)
gravity	S^4	$8\pi^2/3$	$RP^1 \times S^4$	$8\pi^3/3$	IV_5	$\pi^5/2^4 5!$
color	CP^2	$8\pi^2/3$	S^5	$4\pi^3$	$B^6(\text{ball})$	$\pi^3/6$
Weak	$S^2 \times S^2$	$2 \times 4\pi$	$RP^1 \times S^2$	$4\pi^2$	IV_3	$\pi^3/24$
e-mag	T^4	$4 \times 2\pi$	-	-	-	-

Note (thanks to Carlos Castro for noticing this) that the volume listed for S^5 is for a squashed S^5 , a Shilov boundary of the complex domain corresponding to the symmetric space $SU(4) / SU(3) \times U(1)$.

Using the above numbers, the results of the calculations are the relative force strengths at the characteristic energy level of the generalized Bohr radius of each force:

Spin(5)	gravity	approx 10^{19} GeV	1	$G G m_{\text{proton}}^2$	approx 5×10^{-39}
SU(3)	color	approx 245 MeV	0.6286		0.6286
SU(2)	weak	approx 100 GeV	0.2535	$G W m_{\text{proton}}^2$	approx 1.05×10^{-5}
U(1)	e-mag	approx 4 KeV	1/137.03608		1/137.03608

The force strengths are given at the characteristic energy levels of their forces, because the force strengths run with changing energy levels.

The effect is particularly pronounced with the color force.

The color force strength was calculated using a simple perturbative QCD renormalization group equation at various energies, with the following results:

Energy Level	Color Force Strength
245 MeV	0.6286
5.3 GeV	0.166
34 GeV	0.121
91 GeV	0.106

Taking other effects, such as Nonperturbative QCD, into account, should give a Color Force Strength of about 0.125 at about 91 GeV

Higgs, W+, W-, Z0:

As with forces strengths, the calculations produce ratios of masses, so that only one mass need be chosen to set the mass scale.

In the CI(1,25) E8 model, the value of the fundamental mass scale vacuum expectation value $v = \langle \text{PHI} \rangle$ of the Higgs scalar field is set to be the sum of the physical masses of the weak bosons, W+, W-, and Z0, whose tree-level masses will then be shown by ratio calculations to be 80.326 GeV, 80.326 GeV, and 91.862 GeV, respectively, and therefore the electron mass will be 0.5110 MeV.

The relationship between the Higgs mass and v is given by the Ginzburg-Landau term from the Mayer Mechanism as

$$(1/4) \text{Tr} ([\text{PHI} , \text{PHI}] - \text{PHI})^2$$

or, i

n the notation of quant-ph/9806009 by Guang-jiong Ni

$$(1/4!) \lambda \text{PHI}^4 - (1/2) \sigma \text{PHI}^2$$

where the Higgs mass $M_H = \sqrt{2 \sigma}$

Ni says:

"... the invariant meaning of the constant λ in the Lagrangian is not the coupling constant, the latter will change after quantization ... The invariant meaning of λ is nothing but the ratio of two mass scales:

$$\lambda = 3 (M_H / \text{PHI})^2$$

which remains unchanged irrespective of the order ...".

Since $\langle \text{PHI} \rangle^2 = v^2$, if $v = 252.514$ GeV and $\lambda = 1$ for a single-mass-state Higgs,

$$1 = \sqrt{3} M_H / v \quad \text{so that} \quad M_H = 252.514 / \sqrt{3} = 145.789 \text{ GeV}$$

However, for 3-mass-state Higgs as Nambu - Jona-Lasinio Tquark condensate

$\lambda = (\cos(\pi / 6))^2 = 0.866^2$ we have

$$M_H^2 / v^2 = (\cos(\pi / 6))^2 / 3$$

In CI(16) Physics, the fundamental mass scale vacuum expectation value v of the Higgs scalar field is the fundamental mass parameter that is to be set to define all other masses by the mass ratio formulas of the model and v is set to be 252.514 GeV and we have

$$M_H = v \cos(\pi / 6) / \sqrt{3} = 126.257 \text{ GeV}$$

This is the value of the Low Mass State of the Higgs observed by the LHC.

Middle and High Mass States come from a Higgs-Tquark Condensate System.

The Middle and High Mass States may have been observed by the LHC at 20% of the Low Mass State cross section, and that may be confirmed by the LHC 2015-1016 run.

A Non-Condensate Higgs is represented by a Higgs at a point in M4 that is connected to a Higgs representation in CP2 ISS by a line whose length represents the Higgs mass with $\lambda = 1 = 1^2$ and Higgs mass $M_H = v / \sqrt{3} = 145.789 \text{ GeV}$

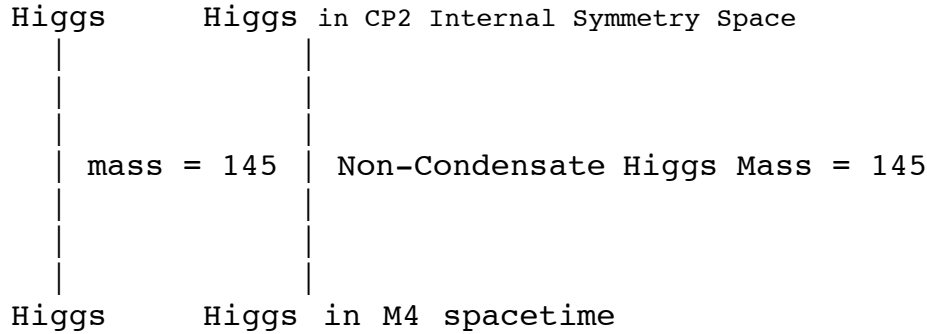

However, in Cl(16) Physics, the Higgs has structure of a Tquark condensate

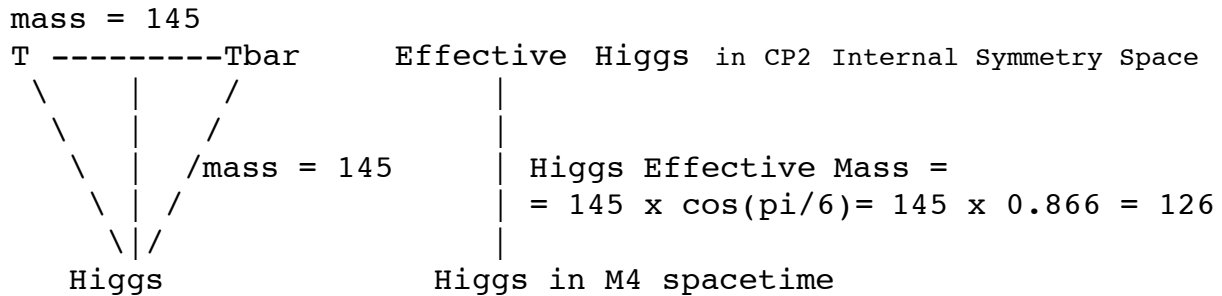

in which the Higgs at a point in M4 is connected to a T and Tbar in CP2 ISS so that the vertices of the Higgs-T-Tbar system are connected by lines forming an equilateral triangle composed of 2 right triangles (one from the CP2 origin to the T and to the M4 Higgs and another from the CP2 origin to the Tbar and to the M4 Higgs). In the T-quark condensate picture $\lambda = 1^2 = \lambda(T) + \lambda(H) = (\sin(\pi/6))^2 + (\cos(\pi/6))^2$ and $\lambda(H) = (\cos(\pi/6))^2$

Therefore the Effective Higgs mass observed by LHC is:

$$\text{Higgs Mass} = 145.789 \times \cos(\pi/6) = 126.257 \text{ GeV.}$$

To get **W-boson masses**,

denote the 3 SU(2) high-energy weak bosons
(massless at energies higher than the electroweak unification)

by W_+ , W_- , and W_0 ,

corresponding to the massive physical weak bosons W_+ , W_- , and Z_0 .

The triplet $\{ W_+, W_-, W_0 \}$ couples directly with the $T - T_{bar}$ quark-antiquark pair,
so that the total mass of the triplet $\{ W_+, W_-, W_0 \}$ at the electroweak unification
is equal to the total mass of a $T - T_{bar}$ pair, 259.031 GeV.

The triplet $\{ W_+, W_-, Z_0 \}$ couples directly with the Higgs scalar,
which carries the Higgs mechanism by which the W_0 becomes the physical Z_0 ,
so that the total mass of the triplet $\{ W_+, W_-, Z_0 \}$
is equal to the vacuum expectation value v of the Higgs scalar field, $v = 252.514$ GeV.

What are individual masses of members of the triplet $\{ W_+, W_-, Z_0 \}$?

First, look at the triplet $\{ W_+, W_-, W_0 \}$ which can be represented by the 3-sphere S^3 .
The Hopf fibration of S^3 as

$$S^1 \rightarrow S^3 \rightarrow S^2$$

gives a decomposition of the W bosons into the neutral W_0 corresponding to S^1
and the charged pair W_+ and W_- corresponding to S^2 .

The mass ratio of the sum of the masses of W_+ and W_- to the mass of W_0
should be the volume ratio of the S^2 in S^3 to the S^1 in S^3 .

The unit sphere S^3 in R^4 is normalized by $1 / 2$.

The unit sphere S^2 in R^3 is normalized by $1 / \sqrt{3}$.

The unit sphere S^1 in R^2 is normalized by $1 / \sqrt{2}$.

The ratio of the sum of the W_+ and W_- masses to the W_0 mass should then be
 $(2 / \sqrt{3}) V(S^2) / (2 / \sqrt{2}) V(S^1) = 1.632993$

Since the total mass of the triplet $\{ W_+, W_-, W_0 \}$ is 259.031 GeV,
the total mass of a $T - T_{bar}$ pair, and the charged weak bosons have equal mass,
we have

$$M_{W_+} = M_{W_-} = 80.326 \text{ GeV and } M_{W_0} = 98.379 \text{ GeV.}$$

The charged W_{\pm} neutrino-electron interchange must be symmetric
with the electron-neutrino interchange, so that the tree-level absence
of right-handed neutrino particles requires that

the charged W_{\pm} SU(2) weak bosons act only on left-handed electrons.

Each gauge boson must act consistently on the entire Dirac fermion particle sector,
so that the
charged W_{\pm} SU(2) weak bosons act only on left-handed fermion particles of all types.

The neutral W_0 weak boson does not interchange Weyl neutrinos with Dirac fermions, and so is not restricted to left-handed fermions, but also has a component that acts on both types of fermions, both left-handed and right-handed, conserving parity.

However, the neutral W_0 weak bosons are related to the charged $W_{+/-}$ weak bosons by custodial $SU(2)$ symmetry, so that the left-handed component of the neutral W_0 must be equal to the left-handed (entire) component of the charged $W_{+/-}$.

Since the mass of the W_0 is greater than the mass of the $W_{+/-}$, there remains for the W_0 a component acting on both types of fermions.

Therefore the full W_0 neutral weak boson interaction is proportional to $(M_{W_{+/-}}^2 / M_{W_0}^2)$ acting on left-handed fermions and $(1 - (M_{W_{+/-}}^2 / M_{W_0}^2))$ acting on both types of fermions.

If $(1 - (M_{W_{+/-}}^2 / M_{W_0}^2))$ is defined to be $\sin(\theta_w)^2$ and denoted by K , and if the strength of the $W_{+/-}$ charged weak force (and of the custodial $SU(2)$ symmetry) is denoted by T , then the W_0 neutral weak interaction can be written as $W_0L = T + K$ and $W_0LR = K$.

Since the W_0 acts as W_0L with respect to the parity violating $SU(2)$ weak force and as W_0LR with respect to the parity conserving $U(1)$ electromagnetic force, the W_0 mass m_{W_0} has two components: the parity violating $SU(2)$ part m_{W_0L} that is equal to $M_{W_{+/-}}$ and the parity conserving part M_{W_0LR} that acts like a heavy photon.

As $M_{W_0} = 98.379 \text{ GeV} = M_{W_0L} + M_{W_0LR}$, and as $M_{W_0L} = M_{W_{+/-}} = 80.326 \text{ GeV}$, we have $M_{W_0LR} = 18.053 \text{ GeV}$.

Denote by $\alpha_E = e^2$ the force strength of the weak parity conserving $U(1)$ electromagnetic type force that acts through the $U(1)$ subgroup of $SU(2)$.

The electromagnetic force strength $\alpha_E = e^2 = 1 / 137.03608$ was calculated above using the volume $V(S^1)$ of an S^1 in R^2 , normalized by $1 / \sqrt{2}$.

The α_E force is part of the $SU(2)$ weak force whose strength $\alpha_W = w^2$ was calculated above using the volume $V(S^2)$ of an $S^2 \subset R^3$, normalized by $1 / \sqrt{3}$.

Also, the electromagnetic force strength $\alpha_E = e^2$ was calculated above using a 4-dimensional spacetime with global structure of the 4-torus T^4 made up of four S^1 1-spheres, while the $SU(2)$ weak force strength $\alpha_W = w^2$ was calculated above using two 2-spheres $S^2 \times S^2$, each of which contains one 1-sphere of the α_E force.

Therefore

$$\begin{aligned} *alphaE &= alphaE (\sqrt{ 2 } / \sqrt{ 3 })(2 / 4) = alphaE / \sqrt{ 6 } , \\ *e &= e / (4th \text{ root of } 6) = e / 1.565 , \end{aligned}$$

and

the mass mW0LR must be reduced to an effective value

$$M_W0LReff = M_W0LR / 1.565 = 18.053/1.565 = 11.536 \text{ GeV}$$

for the *alphaE force to act like an electromagnetic force in the E8 model:

$$*e M_W0LR = e (1/5.65) M_W0LR = e M_Z0,$$

where the physical effective neutral weak boson is denoted by Z0.

Therefore, the correct Cl(1,25) E8 model values for weak boson masses and the Weinberg angle theta_w are:

$$M_W+ = M_W- = 80.326 \text{ GeV};$$

$$M_Z0 = 80.326 + 11.536 = 91.862 \text{ GeV};$$

$$\text{Sin}(\text{theta}_w)^2 = 1 - (M_W+/- / M_Z0)^2 = 1 - (6452.2663 / 8438.6270) = 0.235.$$

Radiative corrections are not taken into account here, and may change these tree- level values somewhat.

Fermion Mass Calculations

In Cl(16) Physics, the first generation spinor fermions are seen as +half-spinor and -half-spinor spaces of $Cl(1,7) = Cl(8)$.

Due to Triality, Spin(8) can act on those 8-dimensional half-spinor spaces similarly to the way it acts on 8-dimensional vector spacetime.

Take the spinor fermion volume to be the Shilov boundary corresponding to the same symmetric space on which Spin(8) acts as a local gauge group that is used to construct 8-dimensional vector spacetime:

the symmetric space $Spin(10) / Spin(8) \times U(1)$
corresponding to a bounded domain of type IV8
whose Shilov boundary is $RP^1 \times S^7$

Since all first generation fermions see the spacetime over which the integral is taken in the same way (unlike what happens for the force strength calculation), the only geometric volume factor relevant for calculating first generation fermion mass ratios is in the spinor fermion volume term.

Cl(16) Physics Fermions correspond to Schwinger Sources, so the quark mass in Cl(16) Physics is a constituent mass.

Fermion masses are calculated as a product of four factors:

$$V(Q\text{fermion}) \times N(\text{Graviton}) \times N(\text{octonion}) \times \text{Sym}$$

$V(Q\text{fermion})$ is the volume of the part of the half-spinor fermion particle manifold $S^7 \times RP^1$ related to the fermion particle by photon, weak boson, or gluon interactions.

$N(\text{Graviton})$ is the number of types of Spin(0,5) graviton related to the fermion. The 10 gravitons correspond to the 10 infinitesimal generators of $Spin(0,5) = Sp(2)$. 2 of them are in the Cartan subalgebra.

6 of them carry color charge, and therefore correspond to quarks.

The remaining 2 carry no color charge, but may carry electric charge and so may be considered as corresponding to electrons.

One graviton takes the electron into itself, and the other can only take the first generation electron into the massless electron neutrino. Therefore only one graviton should correspond to the mass of the first-generation electron. The graviton number ratio of the down quark to the first-generation electron is therefore $6/1 = 6$.

$N(\text{octonion})$ is an octonion number factor relating up-type quark masses to down-type quark masses in each generation.

Sym is an internal symmetry factor, relating 2nd and 3rd generation massive leptons to first generation fermions. It is not used in first-generation calculations.

3 Generation Fermion Combinatorics

First Generation (8)

(geometric representation of Octonions is from arXiv 1010.2979)

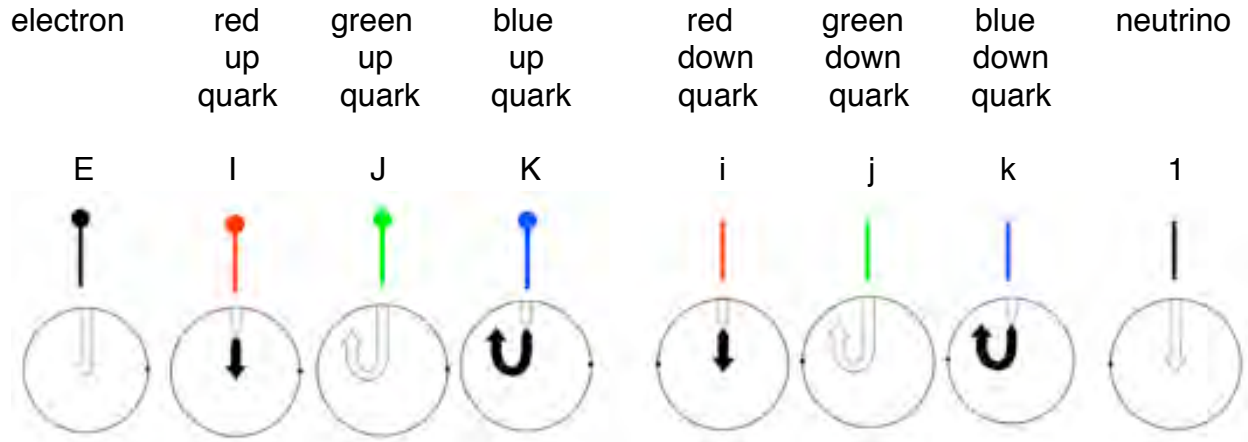

Second Generation (64)

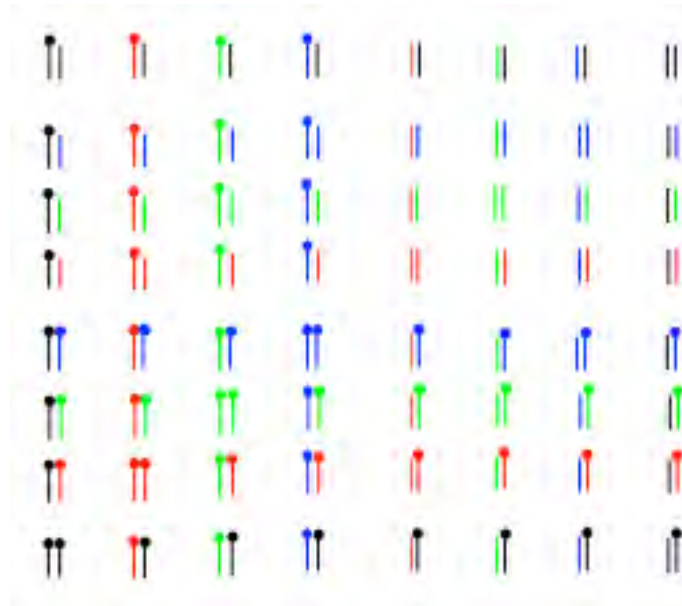

Mu Neutrino (1)

Rule: a Pair belongs to the Mu Neutrino if:

All elements are Colorless (black)

and all elements are Associative

(that is, is 1 which is the only Colorless Associative element) .

Muon (3)

Rule: a Pair belongs to the Muon if:
All elements are Colorless (black)
and at least one element is NonAssociative
(that is, is E which is the only Colorless NonAssociative element).

Blue Strange Quark (3)

Rule: a Pair belongs to the Blue Strange Quark if:
There is at least one Blue element and the other element is Blue or Colorless (black)
and all elements are Associative (that is, is either 1 or i or j or k).

Blue Charm Quark (17)

- Rules: a Pair belongs to the Blue Charm Quark if:
- 1 - There is at least one Blue element and the other element is Blue or Colorless (black) and at least one element is NonAssociative (that is, is either E or I or J or K)
 - 2 - There is one Red element and one Green element (Red x Green = Blue).



(Red and Green Strange and Charm Quarks follow similar rules)

Third Generation (512)

	<table border="1"> <tbody> <tr><td>Tt</td><td>Tt</td><td>Tt</td><td>Tt</td><td>Tt</td><td>Tt</td><td>Tt</td><td>Tt</td></tr> <tr><td>Tt</td><td>Tt</td><td>Tt</td><td>Tt</td><td>Tt</td><td>Tt</td><td>Tt</td><td>Tt</td></tr> <tr><td>Tt</td><td>Tt</td><td>Tt</td><td>Tt</td><td>Tt</td><td>Tt</td><td>Tt</td><td>Tt</td></tr> <tr><td>Tt</td><td>Tt</td><td>Tt</td><td>Tt</td><td>Tt</td><td>Tt</td><td>Tt</td><td>Tt</td></tr> <tr><td>Tt</td><td>Tt</td><td>Tt</td><td>Tt</td><td>Tt</td><td>Tt</td><td>Tt</td><td>Tt</td></tr> <tr><td>Tt</td><td>Tt</td><td>Tt</td><td>Tt</td><td>Tt</td><td>Tt</td><td>Tt</td><td>Tt</td></tr> <tr><td>Tt</td><td>Tt</td><td>Tt</td><td>Tt</td><td>Tt</td><td>Tt</td><td>Tt</td><td>Tt</td></tr> <tr><td>Tt</td><td>Tt</td><td>Tt</td><td>Tt</td><td>Tt</td><td>Tt</td><td>Tt</td><td>Tt</td></tr> </tbody> </table>	Tt	Tt	Tt	Tt	Tt	Tt	Tt	Tt	Tt	Tt	Tt	Tt	Tt	Tt	Tt	Tt	Tt	Tt	Tt	Tt	Tt	Tt	Tt	Tt	Tt	Tt	Tt	Tt	Tt	Tt	Tt	Tt	Tt	Tt	Tt	Tt	Tt	Tt	Tt	Tt	Tt	Tt	Tt	Tt	Tt	Tt	Tt	Tt	Tt	Tt	Tt	Tt	Tt	Tt	Tt	Tt	Tt	Tt	Tt	Tt	Tt	Tt	Tt	Tt																																																																																																																																	
Tt	Tt	Tt	Tt	Tt	Tt	Tt	Tt																																																																																																																																																																																											
Tt	Tt	Tt	Tt	Tt	Tt	Tt	Tt																																																																																																																																																																																											
Tt	Tt	Tt	Tt	Tt	Tt	Tt	Tt																																																																																																																																																																																											
Tt	Tt	Tt	Tt	Tt	Tt	Tt	Tt																																																																																																																																																																																											
Tt	Tt	Tt	Tt	Tt	Tt	Tt	Tt																																																																																																																																																																																											
Tt	Tt	Tt	Tt	Tt	Tt	Tt	Tt																																																																																																																																																																																											
Tt	Tt	Tt	Tt	Tt	Tt	Tt	Tt																																																																																																																																																																																											
Tt	Tt	Tt	Tt	Tt	Tt	Tt	Tt																																																																																																																																																																																											
<table border="1"> <tbody> <tr><td>Tt</td><td>Tt</td><td>Tt</td><td>Tt</td><td>Tt</td><td>Tt</td><td>Tt</td><td>Tt</td></tr> <tr><td>Tt</td><td>Tt</td><td>Tt</td><td>Tt</td><td>Tt</td><td>Tt</td><td>Tt</td><td>Tt</td></tr> <tr><td>Tt</td><td>Tt</td><td>Tt</td><td>Tt</td><td>Tt</td><td>Tt</td><td>Tt</td><td>Tt</td></tr> <tr><td>Tt</td><td>Tt</td><td>Tt</td><td>Tt</td><td>Tt</td><td>Tt</td><td>Tt</td><td>Tt</td></tr> <tr><td>Tt</td><td>Tt</td><td>Tt</td><td>Tt</td><td>Tt</td><td>Tt</td><td>Tt</td><td>Tt</td></tr> <tr><td>Tt</td><td>Tt</td><td>Tt</td><td>Tt</td><td>Tt</td><td>Tt</td><td>Tt</td><td>Tt</td></tr> <tr><td>Tt</td><td>Tt</td><td>Tt</td><td>Tt</td><td>Tt</td><td>Tt</td><td>Tt</td><td>Tt</td></tr> <tr><td>Tt</td><td>Tt</td><td>Tt</td><td>Tt</td><td>Tt</td><td>Tt</td><td>Tt</td><td>Tt</td></tr> </tbody> </table>	Tt	Tt	Tt	Tt	Tt	Tt	Tt	Tt	Tt	Tt	Tt	Tt	Tt	Tt	Tt	Tt	Tt	Tt	Tt	Tt	Tt	Tt	Tt	Tt	Tt	Tt	Tt	Tt	Tt	Tt	Tt	Tt	Tt	Tt	Tt	Tt	Tt	Tt	Tt	Tt	Tt	Tt	Tt	Tt	Tt	Tt	Tt	Tt	Tt	Tt	Tt	Tt	Tt	Tt	Tt	Tt	Tt	Tt	Tt	Tt	Tt	Tt	Tt	Tt	<table border="1"> <tbody> <tr><td>Tt</td><td>Tt</td><td>Tt</td><td>Tt</td><td>Tt</td><td>Tt</td><td>Tt</td><td>Tt</td></tr> <tr><td>Tt</td><td>Tt</td><td>Tt</td><td>Tt</td><td>Tt</td><td>Tt</td><td>Tt</td><td>Tt</td></tr> <tr><td>Tt</td><td>Tt</td><td>Tt</td><td>Tt</td><td>Tt</td><td>Tt</td><td>Tt</td><td>Tt</td></tr> <tr><td>Tt</td><td>Tt</td><td>Tt</td><td>Tt</td><td>Tt</td><td>Tt</td><td>Tt</td><td>Tt</td></tr> <tr><td>Tt</td><td>Tt</td><td>Tt</td><td>Tt</td><td>Tt</td><td>Tt</td><td>Tt</td><td>Tt</td></tr> <tr><td>Tt</td><td>Tt</td><td>Tt</td><td>Tt</td><td>Tt</td><td>Tt</td><td>Tt</td><td>Tt</td></tr> <tr><td>Tt</td><td>Tt</td><td>Tt</td><td>Tt</td><td>Tt</td><td>Tt</td><td>Tt</td><td>Tt</td></tr> <tr><td>Tt</td><td>Tt</td><td>Tt</td><td>Tt</td><td>Tt</td><td>Tt</td><td>Tt</td><td>Tt</td></tr> </tbody> </table>	Tt	Tt	Tt	Tt	Tt	Tt	Tt	Tt	Tt	Tt	Tt	Tt	Tt	Tt	Tt	Tt	Tt	Tt	Tt	Tt	Tt	Tt	Tt	Tt	Tt	Tt	Tt	Tt	Tt	Tt	Tt	Tt	Tt	Tt	Tt	Tt	Tt	Tt	Tt	Tt	Tt	Tt	Tt	Tt	Tt	Tt	Tt	Tt	Tt	Tt	Tt	Tt	Tt	Tt	Tt	Tt	Tt	Tt	Tt	Tt	Tt	Tt	Tt	Tt	<table border="1"> <tbody> <tr><td>Tt</td><td>Tt</td><td>Tt</td><td>Tt</td><td>Tt</td><td>Tt</td><td>Tt</td><td>Tt</td></tr> <tr><td>Tt</td><td>Tt</td><td>Tt</td><td>Tt</td><td>Tt</td><td>Tt</td><td>Tt</td><td>Tt</td></tr> <tr><td>Tt</td><td>Tt</td><td>Tt</td><td>Tt</td><td>Tt</td><td>Tt</td><td>Tt</td><td>Tt</td></tr> <tr><td>Tt</td><td>Tt</td><td>Tt</td><td>Tt</td><td>Tt</td><td>Tt</td><td>Tt</td><td>Tt</td></tr> <tr><td>Tt</td><td>Tt</td><td>Tt</td><td>Tt</td><td>Tt</td><td>Tt</td><td>Tt</td><td>Tt</td></tr> <tr><td>Tt</td><td>Tt</td><td>Tt</td><td>Tt</td><td>Tt</td><td>Tt</td><td>Tt</td><td>Tt</td></tr> <tr><td>Tt</td><td>Tt</td><td>Tt</td><td>Tt</td><td>Tt</td><td>Tt</td><td>Tt</td><td>Tt</td></tr> <tr><td>Tt</td><td>Tt</td><td>Tt</td><td>Tt</td><td>Tt</td><td>Tt</td><td>Tt</td><td>Tt</td></tr> </tbody> </table>	Tt	Tt	Tt	Tt	Tt	Tt	Tt	Tt	Tt	Tt	Tt	Tt	Tt	Tt	Tt	Tt	Tt	Tt	Tt	Tt	Tt	Tt	Tt	Tt	Tt	Tt	Tt	Tt	Tt	Tt	Tt	Tt	Tt	Tt	Tt	Tt	Tt	Tt	Tt	Tt	Tt	Tt	Tt	Tt	Tt	Tt	Tt	Tt	Tt	Tt	Tt	Tt	Tt	Tt	Tt	Tt	Tt	Tt	Tt	Tt	Tt	Tt	Tt	Tt
Tt	Tt	Tt	Tt	Tt	Tt	Tt	Tt																																																																																																																																																																																											
Tt	Tt	Tt	Tt	Tt	Tt	Tt	Tt																																																																																																																																																																																											
Tt	Tt	Tt	Tt	Tt	Tt	Tt	Tt																																																																																																																																																																																											
Tt	Tt	Tt	Tt	Tt	Tt	Tt	Tt																																																																																																																																																																																											
Tt	Tt	Tt	Tt	Tt	Tt	Tt	Tt																																																																																																																																																																																											
Tt	Tt	Tt	Tt	Tt	Tt	Tt	Tt																																																																																																																																																																																											
Tt	Tt	Tt	Tt	Tt	Tt	Tt	Tt																																																																																																																																																																																											
Tt	Tt	Tt	Tt	Tt	Tt	Tt	Tt																																																																																																																																																																																											
Tt	Tt	Tt	Tt	Tt	Tt	Tt	Tt																																																																																																																																																																																											
Tt	Tt	Tt	Tt	Tt	Tt	Tt	Tt																																																																																																																																																																																											
Tt	Tt	Tt	Tt	Tt	Tt	Tt	Tt																																																																																																																																																																																											
Tt	Tt	Tt	Tt	Tt	Tt	Tt	Tt																																																																																																																																																																																											
Tt	Tt	Tt	Tt	Tt	Tt	Tt	Tt																																																																																																																																																																																											
Tt	Tt	Tt	Tt	Tt	Tt	Tt	Tt																																																																																																																																																																																											
Tt	Tt	Tt	Tt	Tt	Tt	Tt	Tt																																																																																																																																																																																											
Tt	Tt	Tt	Tt	Tt	Tt	Tt	Tt																																																																																																																																																																																											
Tt	Tt	Tt	Tt	Tt	Tt	Tt	Tt																																																																																																																																																																																											
Tt	Tt	Tt	Tt	Tt	Tt	Tt	Tt																																																																																																																																																																																											
Tt	Tt	Tt	Tt	Tt	Tt	Tt	Tt																																																																																																																																																																																											
Tt	Tt	Tt	Tt	Tt	Tt	Tt	Tt																																																																																																																																																																																											
Tt	Tt	Tt	Tt	Tt	Tt	Tt	Tt																																																																																																																																																																																											
Tt	Tt	Tt	Tt	Tt	Tt	Tt	Tt																																																																																																																																																																																											
Tt	Tt	Tt	Tt	Tt	Tt	Tt	Tt																																																																																																																																																																																											
Tt	Tt	Tt	Tt	Tt	Tt	Tt	Tt																																																																																																																																																																																											
<table border="1"> <tbody> <tr><td>Tt</td><td>Tt</td><td>Tt</td><td>Tt</td><td>Tt</td><td>Tt</td><td>Tt</td><td>Tt</td></tr> <tr><td>Tt</td><td>Tt</td><td>Tt</td><td>Tt</td><td>Tt</td><td>Tt</td><td>Tt</td><td>Tt</td></tr> <tr><td>Tt</td><td>Tt</td><td>Tt</td><td>Tt</td><td>Tt</td><td>Tt</td><td>Tt</td><td>Tt</td></tr> <tr><td>Tt</td><td>Tt</td><td>Tt</td><td>Tt</td><td>Tt</td><td>Tt</td><td>Tt</td><td>Tt</td></tr> <tr><td>Tt</td><td>Tt</td><td>Tt</td><td>Tt</td><td>Tt</td><td>Tt</td><td>Tt</td><td>Tt</td></tr> <tr><td>Tt</td><td>Tt</td><td>Tt</td><td>Tt</td><td>Tt</td><td>Tt</td><td>Tt</td><td>Tt</td></tr> <tr><td>Tt</td><td>Tt</td><td>Tt</td><td>Tt</td><td>Tt</td><td>Tt</td><td>Tt</td><td>Tt</td></tr> <tr><td>Tt</td><td>Tt</td><td>Tt</td><td>Tt</td><td>Tt</td><td>Tt</td><td>Tt</td><td>Tt</td></tr> </tbody> </table>	Tt	Tt	Tt	Tt	Tt	Tt	Tt	Tt	Tt	Tt	Tt	Tt	Tt	Tt	Tt	Tt	Tt	Tt	Tt	Tt	Tt	Tt	Tt	Tt	Tt	Tt	Tt	Tt	Tt	Tt	Tt	Tt	Tt	Tt	Tt	Tt	Tt	Tt	Tt	Tt	Tt	Tt	Tt	Tt	Tt	Tt	Tt	Tt	Tt	Tt	Tt	Tt	Tt	Tt	Tt	Tt	Tt	Tt	Tt	Tt	Tt	Tt	Tt	Tt	<table border="1"> <tbody> <tr><td>Tt</td><td>Tt</td><td>Tt</td><td>Tt</td><td>Tt</td><td>Tt</td><td>Tt</td><td>Tt</td></tr> <tr><td>Tt</td><td>Tt</td><td>Tt</td><td>Tt</td><td>Tt</td><td>Tt</td><td>Tt</td><td>Tt</td></tr> <tr><td>Tt</td><td>Tt</td><td>Tt</td><td>Tt</td><td>Tt</td><td>Tt</td><td>Tt</td><td>Tt</td></tr> <tr><td>Tt</td><td>Tt</td><td>Tt</td><td>Tt</td><td>Tt</td><td>Tt</td><td>Tt</td><td>Tt</td></tr> <tr><td>Tt</td><td>Tt</td><td>Tt</td><td>Tt</td><td>Tt</td><td>Tt</td><td>Tt</td><td>Tt</td></tr> <tr><td>Tt</td><td>Tt</td><td>Tt</td><td>Tt</td><td>Tt</td><td>Tt</td><td>Tt</td><td>Tt</td></tr> <tr><td>Tt</td><td>Tt</td><td>Tt</td><td>Tt</td><td>Tt</td><td>Tt</td><td>Tt</td><td>Tt</td></tr> <tr><td>Tt</td><td>Tt</td><td>Tt</td><td>Tt</td><td>Tt</td><td>Tt</td><td>Tt</td><td>Tt</td></tr> </tbody> </table>	Tt	Tt	Tt	Tt	Tt	Tt	Tt	Tt	Tt	Tt	Tt	Tt	Tt	Tt	Tt	Tt	Tt	Tt	Tt	Tt	Tt	Tt	Tt	Tt	Tt	Tt	Tt	Tt	Tt	Tt	Tt	Tt	Tt	Tt	Tt	Tt	Tt	Tt	Tt	Tt	Tt	Tt	Tt	Tt	Tt	Tt	Tt	Tt	Tt	Tt	Tt	Tt	Tt	Tt	Tt	Tt	Tt	Tt	Tt	Tt	Tt	Tt	Tt	Tt	<table border="1"> <tbody> <tr><td>Tt</td><td>Tt</td><td>Tt</td><td>Tt</td><td>Tt</td><td>Tt</td><td>Tt</td><td>Tt</td></tr> <tr><td>Tt</td><td>Tt</td><td>Tt</td><td>Tt</td><td>Tt</td><td>Tt</td><td>Tt</td><td>Tt</td></tr> <tr><td>Tt</td><td>Tt</td><td>Tt</td><td>Tt</td><td>Tt</td><td>Tt</td><td>Tt</td><td>Tt</td></tr> <tr><td>Tt</td><td>Tt</td><td>Tt</td><td>Tt</td><td>Tt</td><td>Tt</td><td>Tt</td><td>Tt</td></tr> <tr><td>Tt</td><td>Tt</td><td>Tt</td><td>Tt</td><td>Tt</td><td>Tt</td><td>Tt</td><td>Tt</td></tr> <tr><td>Tt</td><td>Tt</td><td>Tt</td><td>Tt</td><td>Tt</td><td>Tt</td><td>Tt</td><td>Tt</td></tr> <tr><td>Tt</td><td>Tt</td><td>Tt</td><td>Tt</td><td>Tt</td><td>Tt</td><td>Tt</td><td>Tt</td></tr> <tr><td>Tt</td><td>Tt</td><td>Tt</td><td>Tt</td><td>Tt</td><td>Tt</td><td>Tt</td><td>Tt</td></tr> </tbody> </table>	Tt	Tt	Tt	Tt	Tt	Tt	Tt	Tt	Tt	Tt	Tt	Tt	Tt	Tt	Tt	Tt	Tt	Tt	Tt	Tt	Tt	Tt	Tt	Tt	Tt	Tt	Tt	Tt	Tt	Tt	Tt	Tt	Tt	Tt	Tt	Tt	Tt	Tt	Tt	Tt	Tt	Tt	Tt	Tt	Tt	Tt	Tt	Tt	Tt	Tt	Tt	Tt	Tt	Tt	Tt	Tt	Tt	Tt	Tt	Tt	Tt	Tt	Tt	Tt
Tt	Tt	Tt	Tt	Tt	Tt	Tt	Tt																																																																																																																																																																																											
Tt	Tt	Tt	Tt	Tt	Tt	Tt	Tt																																																																																																																																																																																											
Tt	Tt	Tt	Tt	Tt	Tt	Tt	Tt																																																																																																																																																																																											
Tt	Tt	Tt	Tt	Tt	Tt	Tt	Tt																																																																																																																																																																																											
Tt	Tt	Tt	Tt	Tt	Tt	Tt	Tt																																																																																																																																																																																											
Tt	Tt	Tt	Tt	Tt	Tt	Tt	Tt																																																																																																																																																																																											
Tt	Tt	Tt	Tt	Tt	Tt	Tt	Tt																																																																																																																																																																																											
Tt	Tt	Tt	Tt	Tt	Tt	Tt	Tt																																																																																																																																																																																											
Tt	Tt	Tt	Tt	Tt	Tt	Tt	Tt																																																																																																																																																																																											
Tt	Tt	Tt	Tt	Tt	Tt	Tt	Tt																																																																																																																																																																																											
Tt	Tt	Tt	Tt	Tt	Tt	Tt	Tt																																																																																																																																																																																											
Tt	Tt	Tt	Tt	Tt	Tt	Tt	Tt																																																																																																																																																																																											
Tt	Tt	Tt	Tt	Tt	Tt	Tt	Tt																																																																																																																																																																																											
Tt	Tt	Tt	Tt	Tt	Tt	Tt	Tt																																																																																																																																																																																											
Tt	Tt	Tt	Tt	Tt	Tt	Tt	Tt																																																																																																																																																																																											
Tt	Tt	Tt	Tt	Tt	Tt	Tt	Tt																																																																																																																																																																																											
Tt	Tt	Tt	Tt	Tt	Tt	Tt	Tt																																																																																																																																																																																											
Tt	Tt	Tt	Tt	Tt	Tt	Tt	Tt																																																																																																																																																																																											
Tt	Tt	Tt	Tt	Tt	Tt	Tt	Tt																																																																																																																																																																																											
Tt	Tt	Tt	Tt	Tt	Tt	Tt	Tt																																																																																																																																																																																											
Tt	Tt	Tt	Tt	Tt	Tt	Tt	Tt																																																																																																																																																																																											
Tt	Tt	Tt	Tt	Tt	Tt	Tt	Tt																																																																																																																																																																																											
Tt	Tt	Tt	Tt	Tt	Tt	Tt	Tt																																																																																																																																																																																											
Tt	Tt	Tt	Tt	Tt	Tt	Tt	Tt																																																																																																																																																																																											
	<table border="1"> <tbody> <tr><td>Tt</td><td>Tt</td><td>Tt</td><td>Tt</td><td>Tt</td><td>Tt</td><td>Tt</td><td>Tt</td></tr> <tr><td>Tt</td><td>Tt</td><td>Tt</td><td>Tt</td><td>Tt</td><td>Tt</td><td>Tt</td><td>Tt</td></tr> <tr><td>Tt</td><td>Tt</td><td>Tt</td><td>Tt</td><td>Tt</td><td>Tt</td><td>Tt</td><td>Tt</td></tr> <tr><td>Tt</td><td>Tt</td><td>Tt</td><td>Tt</td><td>Tt</td><td>Tt</td><td>Tt</td><td>Tt</td></tr> <tr><td>Tt</td><td>Tt</td><td>Tt</td><td>Tt</td><td>Tt</td><td>Tt</td><td>Tt</td><td>Tt</td></tr> <tr><td>Tt</td><td>Tt</td><td>Tt</td><td>Tt</td><td>Tt</td><td>Tt</td><td>Tt</td><td>Tt</td></tr> <tr><td>Tt</td><td>Tt</td><td>Tt</td><td>Tt</td><td>Tt</td><td>Tt</td><td>Tt</td><td>Tt</td></tr> <tr><td>Tt</td><td>Tt</td><td>Tt</td><td>Tt</td><td>Tt</td><td>Tt</td><td>Tt</td><td>Tt</td></tr> </tbody> </table>	Tt	Tt	Tt	Tt	Tt	Tt	Tt	Tt	Tt	Tt	Tt	Tt	Tt	Tt	Tt	Tt	Tt	Tt	Tt	Tt	Tt	Tt	Tt	Tt	Tt	Tt	Tt	Tt	Tt	Tt	Tt	Tt	Tt	Tt	Tt	Tt	Tt	Tt	Tt	Tt	Tt	Tt	Tt	Tt	Tt	Tt	Tt	Tt	Tt	Tt	Tt	Tt	Tt	Tt	Tt	Tt	Tt	Tt	Tt	Tt	Tt	Tt	Tt	Tt																																																																																																																																	
Tt	Tt	Tt	Tt	Tt	Tt	Tt	Tt																																																																																																																																																																																											
Tt	Tt	Tt	Tt	Tt	Tt	Tt	Tt																																																																																																																																																																																											
Tt	Tt	Tt	Tt	Tt	Tt	Tt	Tt																																																																																																																																																																																											
Tt	Tt	Tt	Tt	Tt	Tt	Tt	Tt																																																																																																																																																																																											
Tt	Tt	Tt	Tt	Tt	Tt	Tt	Tt																																																																																																																																																																																											
Tt	Tt	Tt	Tt	Tt	Tt	Tt	Tt																																																																																																																																																																																											
Tt	Tt	Tt	Tt	Tt	Tt	Tt	Tt																																																																																																																																																																																											
Tt	Tt	Tt	Tt	Tt	Tt	Tt	Tt																																																																																																																																																																																											

Tau Neutrino (1)

Rule: a Triple belongs to the Tau Neutrino if:
 All elements are Colorless (black)
 and all elements are Associative
 (that is, is 1 which is the only Colorless Associative element)

Tauon (7)

Rule: a Triple belongs to the Tauon if:
 All elements are Colorless (black)
 and at least one element is NonAssociative (that is, is E which is the only Colorless NonAssociative element)

Blue Beauty Quark (7)

Rule: a Triple belongs to the Blue Beauty Quark if:

There is at least one Blue element and all other elements are Blue or Colorless (black) and all elements are Associative (that is, is either 1 or i or j or k).

Blue Truth Quark (161)

Rules: a Triple belongs to the Blue Truth Quark if:

1 - There is at least one Blue element and all other elements are Blue or Colorless (black)

and at least one element is NonAssociative (that is, is either E or I or J or K)

2 - There is one Red element and one Green element and the other element is Colorless (Red x Green = Blue)

3 - The Triple has one element each that is Red, Green, or Blue, in which case the color of the Third element (for Third Generation) is determinative and must be Blue.

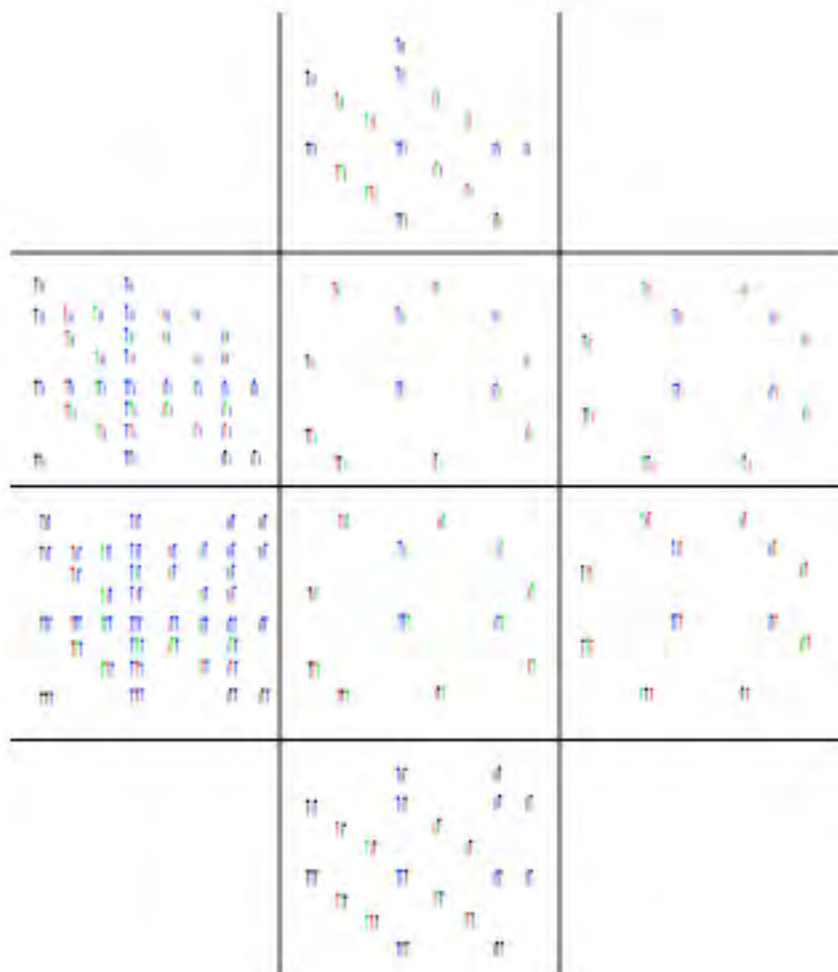

(Red and Green Beauty and Truth Quarks follow similar rules)

The first generation down quark constituent mass : electron mass ratio is:

The electron, E, can only be taken into the tree-level-massless neutrino, 1, by photon, weak boson, and gluon interactions.

The electron and neutrino, or their antiparticles, cannot be combined to produce any of the massive up or down quarks.

The neutrino, being massless at tree level, does not add anything to the mass formula for the electron.

Since the electron cannot be related to any other massive Dirac fermion, its volume $V(Q_{\text{electron}})$ is taken to be 1.

Next consider a red down quark i.

By gluon interactions, i can be taken into j and k, the blue and green down quarks.

By also using weak boson interactions,

it can also be taken into l, J, and K, the red, blue, and green up quarks.

Given the up and down quarks, pions can be formed from quark-antiquark pairs, and the pions can decay to produce electrons and neutrinos.

Therefore the red down quark (similarly, any down quark)

is related to all parts of $S^7 \times RP^1$,

the compact manifold corresponding to $\{ 1, i, j, k, E, l, J, K \}$

and therefore

a down quark should have

a spinor manifold volume factor $V(Q_{\text{down quark}})$ of the volume of $S^7 \times RP^1$.

The ratio of the down quark spinor manifold volume factor

to the electron spinor manifold volume factor is

$$V(Q_{\text{down quark}}) / V(Q_{\text{electron}}) = V(S^7 \times RP^1) / 1 = \pi^5 / 3.$$

Since the first generation graviton factor is 6,

$$m_d / m_e = 6 V(S^7 \times RP^1) = 2 \pi^5 = 612.03937$$

As the up quarks correspond to l, J, and K, which are the octonion transforms under E of i, j, and k of the down quarks, the up quarks and down quarks have the same constituent mass

$$m_u = m_d.$$

Antiparticles have the same mass as the corresponding particles.

Since the model only gives ratios of masses,

the mass scale is fixed so that the electron mass $m_e = 0.5110 \text{ MeV}$.

Then, the constituent mass of the down quark is $m_d = 312.75 \text{ MeV}$,

and the constituent mass for the up quark is $m_u = 312.75 \text{ MeV}$.

These results when added up give a total mass of first generation fermion particles:

$$\Sigma_{\text{maf1}} = 1.877 \text{ GeV}$$

As the proton mass is taken to be the sum of the constituent masses of its constituent quarks

$$m_{\text{proton}} = m_u + m_u + m_d = 938.25 \text{ MeV}$$

which is close to the experimental value of 938.27 MeV.

The third generation fermion particles correspond to triples of octonions. There are $8^3 = 512$ such triples.

The triple $\{ 1, 1, 1 \}$ corresponds to the tau-neutrino.

The other 7 triples involving only 1 and E correspond to the tauon:

$\{ E, E, E \}$
 $\{ E, E, 1 \}$
 $\{ E, 1, E \}$
 $\{ 1, E, E \}$
 $\{ 1, 1, E \}$
 $\{ 1, E, 1 \}$
 $\{ E, 1, 1 \}$

The symmetry of the 7 tauon triples is the same as the symmetry of the first generation tree-level-massive fermions, 3 down, quarks, the 3 up quarks, and the electron, so by the Sym factor the tauon mass should be the same as the sum of the masses of the first generation massive fermion particles.

Therefore the tauon mass is calculated at tree level as 1.877 GeV.

The calculated tauon mass of 1.88 GeV is a sum of first generation fermion masses, all of which are valid at the energy level of about 1 GeV.

However, as the tauon mass is about 2 GeV, the effective tauon mass should be renormalized from the energy level of 1 GeV at which the mass is 1.88 GeV to the energy level of 2 GeV. Such a renormalization should reduce the mass.

If the renormalization reduction were about 5 percent, the effective tauon mass at 2 GeV would be about 1.78 GeV. The 1996 Particle Data Group Review of Particle Physics gives a tauon mass of 1.777 GeV.

All triples corresponding to the tau and the tau-neutrino are colorless.

The beauty quark corresponds to 21 triples.
They are triples of the same form as the 7 tauon triples involving 1 and E,
but for 1 and I, 1 and J, and 1 and K,
which correspond to the red, green, and blue beauty quarks,
respectively.

The seven red beauty quark triples correspond to the seven tauon triples,
except that
the beauty quark interacts with 6 Spin(0,5) gravitons
while the tauon interacts with only two.

The red beauty quark constituent mass should be the tauon mass times
the third generation graviton factor $6/2 = 3$,
so the red beauty quark mass is $m_b = 5.63111$ GeV.

The blue and green beauty quarks are similarly determined to also be 5.63111 GeV.

The calculated beauty quark mass of 5.63 GeV is a constituent mass,
that is, it corresponds to the conventional pole mass plus 312.8 MeV.
Therefore, the calculated beauty quark mass of 5.63 GeV
corresponds to a conventional pole mass of 5.32 GeV.

The 1996 Particle Data Group Review of Particle Physics gives
a lattice gauge theory beauty quark pole mass as 5.0 GeV.

The pole mass can be converted to an MSbar mass
if the color force strength constant α_s is known.
The conventional value of α_s at about 5 GeV is about 0.22.

Using $\alpha_s(5 \text{ GeV}) = 0.22$, a pole mass of 5.0 GeV
gives an MSbar 1-loop beauty quark mass of 4.6 GeV,
and
an MSbar 1,2-loop beauty quark mass of 4.3, evaluated at about 5 GeV.

If the MSbar mass is run from 5 GeV up to 90 GeV,
the MSbar mass decreases by about 1.3 GeV,
giving an expected MSbar mass of about 3.0 GeV at 90 GeV.

DELPHI at LEP has observed the Beauty Quark
and found a 90 GeV MSbar beauty quark mass of about 2.67 GeV,
with error bars ± 0.25 (stat) ± 0.34 (frag) ± 0.27 (theo).

The theoretical model calculated Beauty Quark mass of 5.63 GeV corresponds to a pole mass of 5.32 GeV, which is somewhat higher than the conventional value of 5.0 GeV.

However, the theoretical model calculated value of the color force strength constant α_s at about 5 GeV is about 0.166, while the conventional value of the color force strength constant α_s at about 5 GeV is about 0.216, and the theoretical model calculated value of the color force strength constant α_s at about 90 GeV is about 0.106, while the conventional value of the color force strength constant α_s at about 90 GeV is about 0.118.

The theoretical model calculations gives a Beauty Quark pole mass (5.3 GeV) that is about 6 percent higher than the conventional Beauty Quark pole mass (5.0 GeV), and a color force strength α_s at 5 GeV (0.166) such that $1 + \alpha_s = 1.166$ is about 4 percent lower than the conventional value of $1 + \alpha_s = 1.216$ at 5 GeV.

Triples of the type $\{ 1, I, J \}$, $\{ I, J, K \}$, etc., do not correspond to the beauty quark, but to the truth quark. The truth quark corresponds to those $512 - 1 - 7 - 21 = 483$ triples, so the constituent mass of the red truth quark is $161 / 7 = 23$ times the red beauty quark mass, and the red T-quark mass is $m_t = 129.5155$ GeV

The blue and green truth quarks are similarly determined to also be 129.5155 GeV.

This is the value of the Low Mass State of the Truth calculated in Cl(16) Physics. The Middle Mass State of the Truth Quark has been observed by Fermilab since 1994. **The Low and High Mass States of the Truth Quark have, in my opinion, also been observed by Fermilab but the Fermilab and CERN establishments disagree.**

All other masses than the electron mass (which is the basis of the assumption of the value of the Higgs scalar field vacuum expectation value $v = 252.514$ GeV), including the Higgs scalar mass and Truth quark mass, are calculated (not assumed) masses in Cl(16) Physics. These results when added up give a total mass of third generation fermion particles:

$$\mathbf{\Sigma_{maf3} = 1,629 \text{ GeV}}$$

The second generation fermion particles correspond to pairs of octonions.
There are $8^2 = 64$ such pairs.

The pair $\{ 1, 1 \}$ corresponds to the mu-neutrino.

The pairs $\{ 1, E \}$, $\{ E, 1 \}$, and $\{ E, E \}$ correspond to the muon.

For the Sym factor, compare the symmetries of the muon pairs to the symmetries of the first generation fermion particles:
The pair $\{ E, E \}$ should correspond to the E electron.
The other two muon pairs have a symmetry group S_2 , which is $1/3$ the size of the color symmetry group S_3 which gives the up and down quarks their mass of 312.75 MeV.

Therefore the mass of the muon should be the sum of the $\{ E, E \}$ electron mass and the $\{ 1, E \}$, $\{ E, 1 \}$ symmetry mass, which is $1/3$ of the up or down quark mass. Therefore, $m_{\mu} = 104.76$ MeV .

According to the 1998 Review of Particle Physics of the Particle Data Group, the experimental muon mass is about 105.66 MeV which may be consistent with radiative corrections for the calculated tree-level $m_{\mu} = 104.76$ MeV as Bailin and Love, in "Introduction to Gauge Field Theory", IOP (rev ed 1993), say: "... considering the order alpha radiative corrections to muon decay ... Numerical details are contained in Sirlin ... 1980 Phys. Rev. D 22 971 ... who concludes that the order alpha corrections have the effect of increasing the decay rate about 7% compared with the tree graph prediction ...". Since the decay rate is proportional to m_{μ}^5 the corresponding effective increase in muon mass would be about 1.36%, which would bring 104.8 MeV up to about 106.2 MeV.

All pairs corresponding to the muon and the mu-neutrino are colorless.

The red, blue and green strange quark each corresponds to the 3 pairs involving 1 and i, j, or k.

The red strange quark is defined as the three pairs $\{ 1, i \}$, $\{ i, 1 \}$, $\{ i, i \}$ because i is the red down quark.

Its mass should be the sum of two parts:
the $\{ i, i \}$ red down quark mass, 312.75 MeV, and
the product of the symmetry part of the muon mass, 104.25 MeV,
times the graviton factor.

Unlike the first generation situation,
massive second and third generation leptons can be taken,
by both of the colorless gravitons that may carry electric charge,
into massive particles.

Therefore the graviton factor for the second and third generations is $6/2 = 3$.

So the symmetry part of the muon mass times the graviton factor 3 is 312.75 MeV, and
the red strange quark constituent mass is $m_s = 312.75 \text{ MeV} + 312.75 \text{ MeV} = 625.5 \text{ MeV}$

The blue strange quarks correspond to the three pairs involving j,
the green strange quarks correspond to the three pairs involving k,
and their masses are similarly determined to also be 625.5 MeV.
The charm quark corresponds to the remaining $64 - 1 - 3 - 9 = 51$ pairs.

Therefore, the mass of the red charm quark should be the sum of two parts:
the $\{ i, i \}$, red up quark mass, 312.75 MeV;
and
the product of the symmetry part of the strange quark mass, 312.75 MeV,
and the charm to strange octonion number factor $51 / 9$,
which product is 1,772.25 MeV.

Therefore the red charm quark constituent mass is
 $m_c = 312.75 \text{ MeV} + 1,772.25 \text{ MeV} = 2.085 \text{ GeV}$

The blue and green charm quarks are similarly determined to also be 2.085 GeV.

The calculated Charm Quark mass of 2.09 GeV is a constituent mass,
that is, it corresponds to the conventional pole mass plus 312.8 MeV.

Therefore, the calculated Charm Quark mass of 2.09 GeV corresponds to a
conventional pole mass of 1.78 GeV.

The 1996 Particle Data Group Review of Particle Physics gives a range for the
Charm Quark pole mass from 1.2 to 1.9 GeV.

The pole mass can be converted to an MSbar mass if the color force strength constant α_s is known.

The conventional value of α_s at about 2 GeV is about 0.39, which is somewhat lower than the theoretical model value.

Using $\alpha_s(2 \text{ GeV}) = 0.39$, a pole mass of 1.9 GeV gives an MSbar 1-loop mass of 1.6 GeV, evaluated at about 2 GeV.

These results when added up give a total mass of second generation fermion particles:

$$\mathbf{\Sigma_{f2} = 32.9 \text{ GeV}}$$

Kobayashi-Maskawa Parameters

In Cl(16) Physics the KM Unitarity Triangle angles can be seen on the Stella Octangula

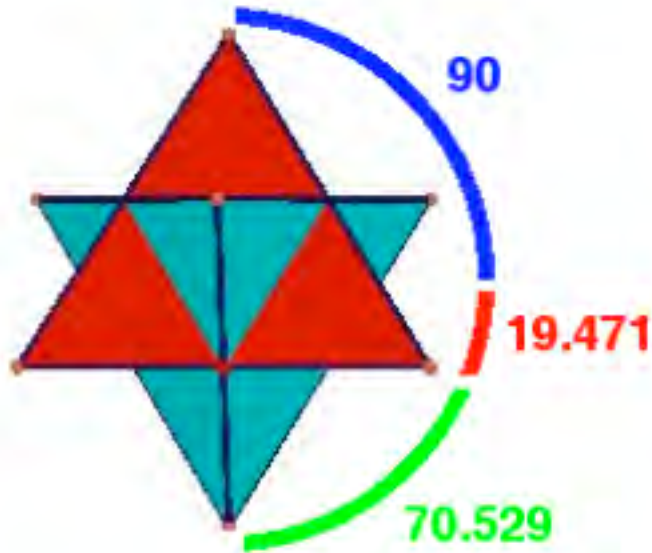

The Kobayashi-Maskawa parameters are determined in terms of the sum of the masses of the 30 first-generation fermion particles and antiparticles, denoted by

$$S_{mf1} = 7.508 \text{ GeV},$$

and the similar sums for second-generation and third-generation fermions, denoted by

$$S_{mf2} = 32.94504 \text{ GeV} \text{ and } S_{mf3} = 1,629.2675 \text{ GeV}.$$

The resulting KM matrix is:

d		s	b
u	0.975	0.222 0.00249	-0.00388i
c	-0.222 -0.000161i	0.974 -0.0000365i	0.0423
t	0.00698 -0.00378i	-0.0418 -0.00086i	0.999

**Below the energy level of ElectroWeak Symmetry Breaking
the Higgs mechanism gives mass to particles.**

According to a Review on the Kobayashi-Maskawa mixing matrix by Ceccucci, Ligeti, and Sakai in the 2010 Review of Particle Physics (note that I have changed their terminology of CKM matrix to the KM terminology that I prefer because I feel that it was Kobayashi and Maskawa, not Cabibbo, who saw that 3x3 was the proper matrix structure): "... the charged-current W_{\pm} interactions couple to the ... quarks with couplings given by ...

$$\begin{matrix} V_{ud} & V_{us} & V_{ub} \\ V_{cd} & V_{cs} & V_{cb} \\ V_{td} & V_{ts} & V_{tb} \end{matrix}$$

This Kobayashi-Maskawa (KM) matrix is a 3x3 unitary matrix. It can be parameterized by three mixing angles and the CP-violating KM phase ... The most commonly used unitarity triangle arises from $V_{ud} V_{ub}^* + V_{cd} V_{cb}^* + V_{td} V_{tb}^* = 0$, by dividing each side by the best-known one, $V_{cd} V_{cb}^*$

... $\bar{\rho} + i\bar{\eta} = -(V_{ud} V_{ub}^*) / (V_{cd} V_{cb}^*)$ is phase-convention-independent ...

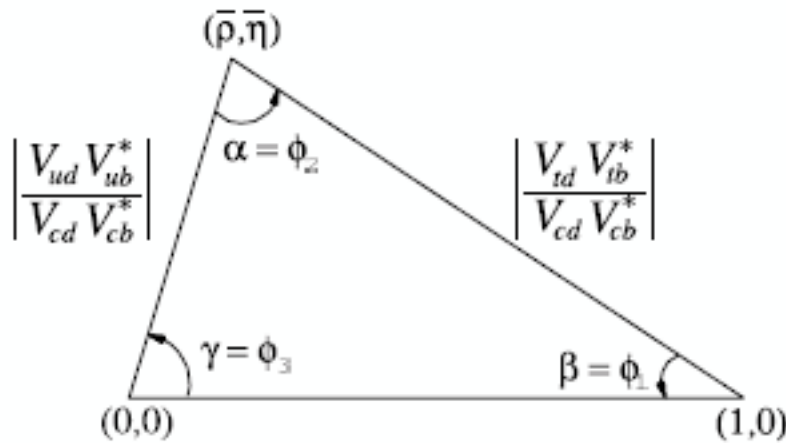

Figure 11.1: Sketch of the unitarity triangle.

... $\sin 2\beta = 0.673 \pm 0.023$... $\alpha = 89.0 + 4.4 - 4.2$ degrees ... $\gamma = 73 + 22 - 25$ degrees ... The sum of the three angles of the unitarity triangle, $\alpha + \beta + \gamma = (183 + 22 - 25)$ degrees, is ... consistent with the SM expectation. ...

The area... of ...[the]... triangle...[is]... half of the Jarlskog invariant, J , which is a phase-convention-independent measure of CP violation, defined by $\text{Im } V_{ij} V_{kl} V_{il}^* V_{kj}^* = J \sum_{(m,n)} \epsilon_{ikm} \epsilon_{jln}$

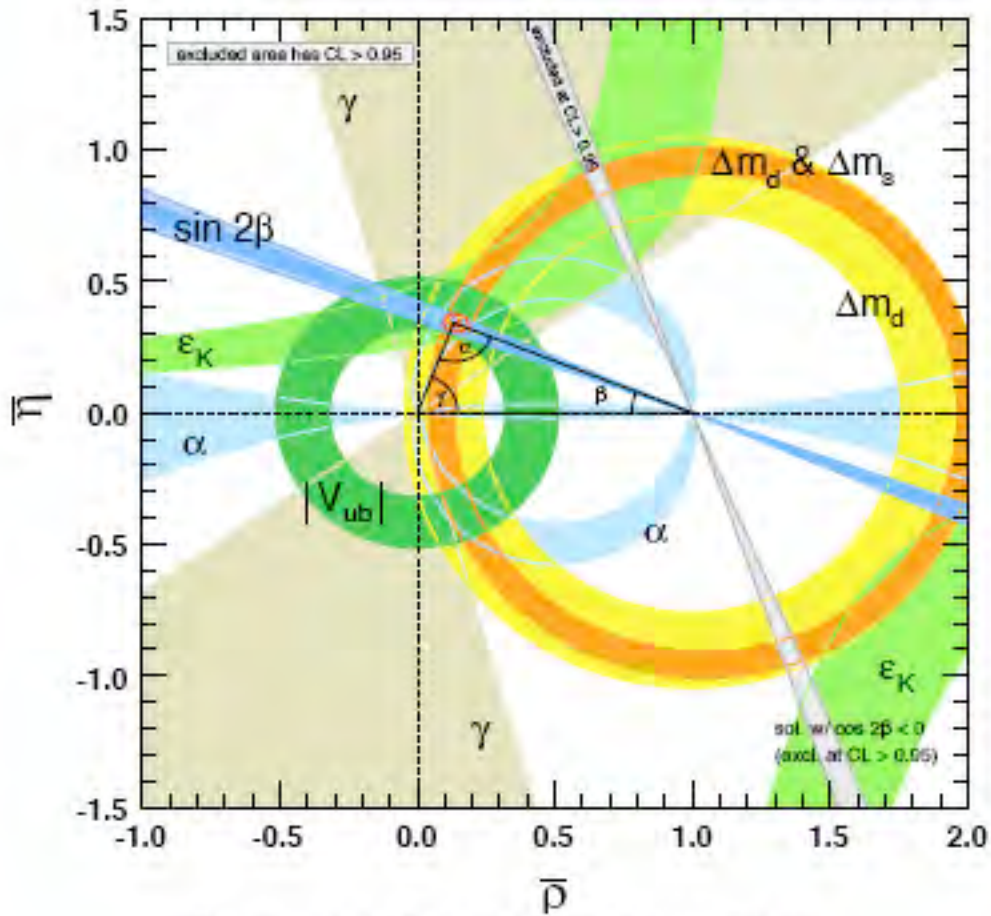

Figure 11.2: Constraints on the $\bar{\rho}, \bar{\eta}$ plane.
The shaded areas have 95% CL.

The fit results for the magnitudes of all nine KM elements are ...

0.97428 ± 0.00015	0.2253 ± 0.0007	$0.00347 +0.00016 -0.00012$
0.2252 ± 0.0007	$0.97345 +0.00015 -0.00016$	$0.0410 +0.0011 -0.0007$
$0.00862 +0.00026 -0.00020$	$0.0403 +0.0011 -0.0007$	$0.999152 +0.000030 -0.000045$

and the Jarlskog invariant is $J = (2.91 +0.19 -0.11) \times 10^{-5}$".

**Above the energy level of ElectroWeak Symmetry Breaking
particles are massless.**

Kea (Marni Sheppeard) proposed
that in the Massless Realm the mixing matrix might be democratic.
In Z. Phys. C - Particles and Fields 45, 39-41 (1989) Koide said: "...
the mass matrix ... MD ... of the type ... $1/3 \times m \times$

$$\begin{matrix} 1 & 1 & 1 \\ 1 & 1 & 1 \\ 1 & 1 & 1 \end{matrix}$$

... has name... "democratic" family mixing ...
the ... democratic ... mass matrix can be diagonalized by the transformation matrix A ...

$$\begin{matrix} 1/\sqrt{2} & -1/\sqrt{2} & 0 \\ 1/\sqrt{6} & 1/\sqrt{6} & -2/\sqrt{6} \\ 1/\sqrt{3} & 1/\sqrt{3} & 1/\sqrt{3} \end{matrix}$$

as $A M D A^t =$

$$\begin{matrix} 0 & 0 & 0 \\ 0 & 0 & 0 \\ 0 & 0 & m \end{matrix}$$

...".

Up in the Massless Realm you might just say that there is no mass matrix,
just a democratic mixing matrix of the form $1/3 \times$

$$\begin{matrix} 1 & 1 & 1 \\ 1 & 1 & 1 \\ 1 & 1 & 1 \end{matrix}$$

with no complex stuff and no CP violation in the Massless Realm.

When go down to our Massive Realm by ElectroWeak Symmetry Breaking
then you might as a first approximation use $m = 1$
so that all the mass first goes to the third generation as

$$\begin{matrix} 0 & 0 & 0 \\ 0 & 0 & 0 \\ 0 & 0 & 1 \end{matrix}$$

which is physically like the Higgs being a T-Tbar quark condensate.

Consider a 3-dim Euclidean space of generations:

The case of mass only going to one generation
can be represented as a line or 1-dimensional simplex



in which the blue mass-line covers the entire black simplex line.

If mass only goes to one other generation
that can be represented by a red line extending to a second dimension
forming a small blue-red-black triangle

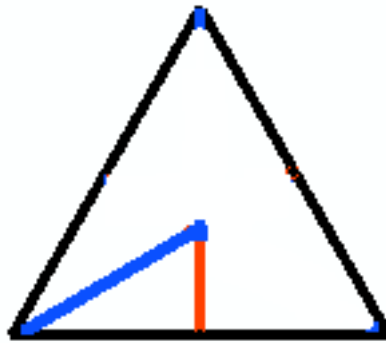

that can be extended by reflection to form six small triangles making up a large triangle

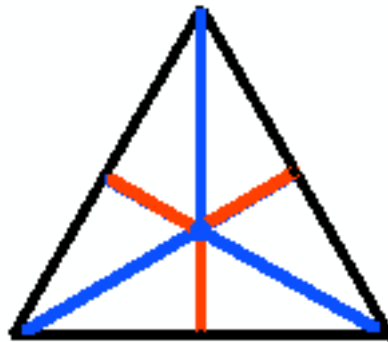

Each of the six component triangles has 30-60-90 angle structure:



If mass goes on further to all three generations that can be represented by a green line extending to a third dimension

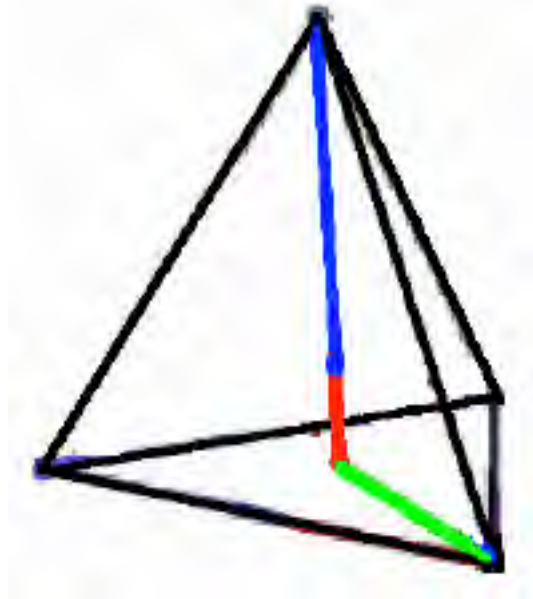

If you move the blue line from the top vertex to join the green vertex

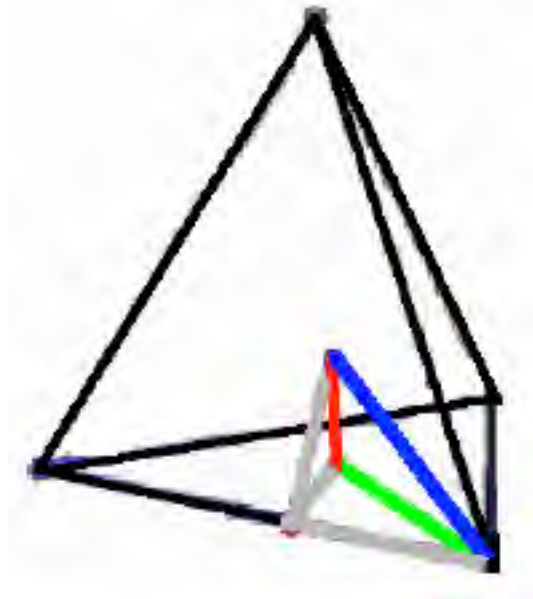

you get a small blue-red-green-gray-gray-gray tetrahedron that can be extended by reflection to form 24 small tetrahedra making up a large tetrahedron.

Reflection among the 24 small tetrahedra corresponds to the $12+12 = 24$ elements of the Binary Tetrahedral Group.

The basic blue-red-green triangle of the basic small tetrahedron

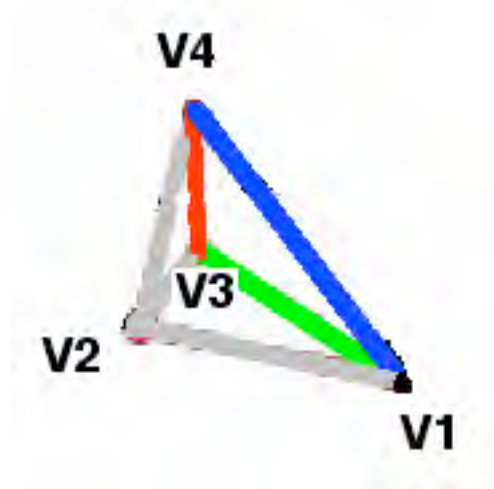

has the angle structure of the K-M Unitary Triangle.

Using data from R. W. Gray's "Encyclopedia Polyhedra: A Quantum Module" with lengths

$$V1.V2 = (1/2) EL \equiv \text{Half of the regular Tetrahedron's edge length.}$$

$$V1.V3 = (1 / \sqrt{3}) EL \approx 0.577\ 350\ 269\ EL$$

$$V1.V4 = 3 / (2 \sqrt{6}) EL \approx 0.612\ 372\ 436\ EL$$

$$V2.V3 = 1 / (2 \sqrt{3}) EL \approx 0.288\ 675\ 135\ EL$$

$$V2.V4 = 1 / (2 \sqrt{2}) EL \approx 0.353\ 553\ 391\ EL$$

$$V3.V4 = 1 / (2 \sqrt{6}) EL \approx 0.204\ 124\ 145\ EL$$

the Unitarity Triangle angles are:

$$\beta = V3.V1.V4 = \arccos(2 \sqrt{2} / 3) \approx 19.471\ 220\ 634\ \text{degrees so } \sin 2\beta = 0.6285$$

$$\alpha = V1.V3.V4 = 90\ \text{degrees}$$

$$\gamma = V1.V4.V3 = \arcsin(2 \sqrt{2} / 3) \approx 70.528\ 779\ 366\ \text{degrees}$$

which is substantially consistent with the 2010 Review of Particle Properties

$$\sin 2\beta = 0.673 \pm 0.023 \text{ so } \beta = 21.1495\ \text{degrees}$$

$$\alpha = 89.0\ +4.4\ -4.2\ \text{degrees}$$

$$\gamma = 73\ +22\ -25\ \text{degrees}$$

and so also consistent with the Standard Model expectation.

The constructed Unitarity Triangle angles can be seen on the Stella Octangula configuration of two dual tetrahedra (image from gauss.math.nthu.edu.tw):

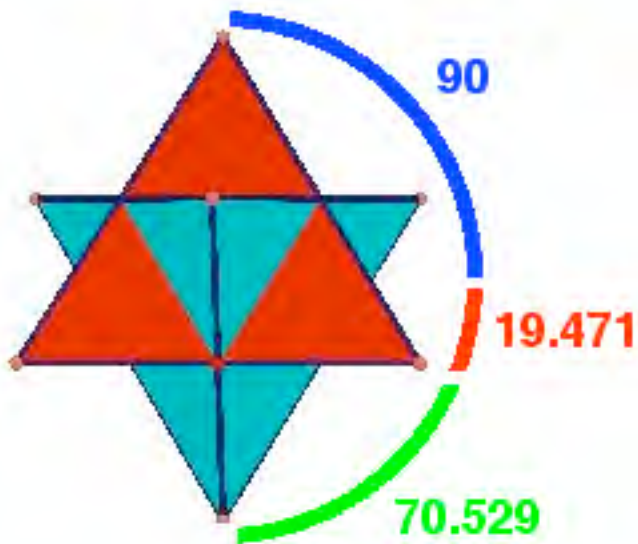

In the $Cl(1,25)$ E8 model the Kobayashi-Maskawa parameters are determined in terms of the sum of the masses of the 30 first-generation fermion particles and antiparticles, denoted by $S_{mf1} = 7.508$ GeV,

and the similar sums for second-generation and third-generation fermions, denoted by $S_{mf2} = 32.94504$ GeV and $S_{mf3} = 1,629.2675$ GeV.

The reason for using sums of all fermion masses (rather than sums of quark masses only) is that all fermions are in the same spinor representation of Spin(8), and the Spin(8) representations are considered to be fundamental.

The following formulas use the above masses to calculate Kobayashi-Maskawa parameters:

phase angle $d_{13} = \gamma = 70.529$ degrees

$$\sin(\theta_{12}) = s_{12} = [m_e + 3m_d + 3m_\mu] / \sqrt{[m_e^2 + 3m_d^2 + 3m_\mu^2] + [3m_\nu^2 + 3m_s^2 + 3m_c^2]} = 0.222198$$

$$\sin(\theta_{13}) = s_{13} = [m_e + 3m_d + 3m_\mu] / \sqrt{[m_e^2 + 3m_d^2 + 3m_\mu^2] + [3m_\nu^2 + 3m_b^2 + 3m_t^2]} = 0.004608$$

$$\sin(\theta_{23}) = [3m_\nu + 3m_s + 3m_c] / \sqrt{[3m_\nu^2 + 3m_b^2 + 3m_t^2] + [3m_\nu^2 + 3m_s^2 + 3m_c^2]}$$

$$\sin(\theta_{23}) = s_{23} = \sin(\theta_{23}) \sqrt{(\Sigma_{f2} / \Sigma_{f1})} = 0.04234886$$

The factor $\sqrt{(\Sigma_{f2} / \Sigma_{f1})}$ appears in s_{23} because an s_{23} transition is to the second generation and not all the way to the first generation, so that the end product of an s_{23} transition has a greater available energy than s_{12} or s_{13} transitions by a factor of $\Sigma_{f2} / \Sigma_{f1}$.

Since the width of a transition is proportional to the square of the modulus of the relevant KM entry and the width of an s_{23} transition has greater available energy than the s_{12} or s_{13} transitions by a factor of $\Sigma_{f2} / \Sigma_{f1}$ the effective magnitude of the s_{23} terms in the KM entries is increased by the factor $\sqrt{(\Sigma_{f2} / \Sigma_{f1})}$.

The Chau-Keung parameterization is used, as it allows the K-M matrix to be represented as the product of the following three 3x3 matrices:

$$\begin{pmatrix} 1 & 0 & 0 \\ 0 & \cos(\theta_{23}) & \sin(\theta_{23}) \\ 0 & -\sin(\theta_{23}) & \cos(\theta_{23}) \end{pmatrix}$$

$$\begin{pmatrix} \cos(\theta_{13}) & 0 & \sin(\theta_{13})\exp(-i d_{13}) \\ 0 & 1 & 0 \\ -\sin(\theta_{13})\exp(i d_{13}) & 0 & \cos(\theta_{13}) \end{pmatrix}$$

$$\begin{pmatrix} \cos(\theta_{12}) & \sin(\theta_{12}) & 0 \\ -\sin(\theta_{12}) & \cos(\theta_{12}) & 0 \\ 0 & 0 & 1 \end{pmatrix}$$

The resulting Kobayashi-Maskawa parameters
for W^+ and W^- charged weak boson processes, are:

	d	s	b
u	0.975	0.222	0.00249 -0.00388i
c	-0.222 -0.000161i	0.974 -0.0000365i	0.0423
t	0.00698 -0.00378i	-0.0418 -0.00086i	0.999

The matrix is labelled by either (u c t) input and (d s b) output,
or, as above, (d s b) input and (u c t) output.

For Z^0 neutral weak boson processes, which are suppressed by the GIM
mechanism of cancellation of virtual subprocesses, the matrix is labelled by either
(u c t) input and (u'c't') output, or, as below, (d s b) input and (d's'b') output:

	d	s	b
d'	0.975	0.222	0.00249 -0.00388i
s'	-0.222 -0.000161i	0.974 -0.0000365i	0.0423
b'	0.00698 -0.00378i	-0.0418 -0.00086i	0.999

Since neutrinos of all three generations are massless at tree level,
the lepton sector has no tree-level K-M mixing.

In hep-ph/0208080, Yosef Nir says: "... Within the Standard Model,
the only source of CP violation is the Kobayashi-Maskawa (KM) phase ...
The study of CP violation is, at last, experiment driven. ...
The CKM matrix provides a consistent picture
of all the measured flavor and CP violating processes. ...
There is no signal of new flavor physics. ...
Very likely,
the KM mechanism is the dominant source of CP violation in flavor changing processes.
... The result is consistent with the SM predictions. ...".

Neutrino Masses Beyond Tree Level

Consider the three generations of neutrinos:
nu_e (electron neutrino); nu_mu (muon neutrino); nu_tau
and three neutrino mass states: nu_1 ; nu_2 : nu_3
and
the division of 8-dimensional spacetime into
4-dimensional physical Minkowski spacetime
plus
4-dimensional CP2 internal symmetry space.

The heaviest mass state nu_3 corresponds to a neutrino
whose propagation begins and ends in CP2 internal symmetry
space, lying entirely therein. According to the Cl(1,25) E8 model
the mass of nu_3 is zero at tree-level
but it picks up a first-order correction
propagating entirely through internal symmetry space by merging
with an electron through the weak and electromagnetic forces,
effectively acting not merely as a point
but
as a point plus an electron loop at beginning and ending points
so
the first-order corrected mass of nu_3 is given by
 $M_{\nu_3} \times (1/\sqrt{2}) = M_e \times GW(m_{\text{proton}}^2) \times \alpha_E$
where the factor $(1/\sqrt{2})$ comes from the Ut3 component
of the neutrino mixing matrix
so that

$$\begin{aligned} M_{\nu_3} &= \sqrt{2} \times M_e \times GW(m_{\text{proton}}^2) \times \alpha_E = \\ &= 1.4 \times 5 \times 10^5 \times 1.05 \times 10^{(-5)} \times (1/137) \text{ eV} = \\ &= 7.35 / 137 = 5.4 \times 10^{(-2)} \text{ eV}. \end{aligned}$$

The neutrino-plus-electron loop can be anchored by weak force
action through any of the 6 first-generation quarks
at each of the beginning and ending points, and that the
anchor quark at the beginning point can be different from
the anchor quark at the ending point,
so that there are $6 \times 6 = 36$ different possible anchorings.

The intermediate mass state ν_2 corresponds to a neutrino whose propagation begins or ends in CP2 internal symmetry space and ends or begins in M4 physical Minkowski spacetime, thus having only one point (either beginning or ending) lying in CP2 internal symmetry space where it can act not merely as a point but as a point plus an electron loop.

According to the Cl(1,25) E8 model the mass of ν_2 is zero at tree-level but it picks up a first-order correction at only one (but not both) of the beginning or ending points so that so that there are 6 different possible anchorings for ν_2 first-order corrections, as opposed to the 36 different possible anchorings for ν_3 first-order corrections, so that the first-order corrected mass of ν_2 is less than the first-order corrected mass of ν_3 by a factor of 6, so

the first-order corrected mass of ν_2 is

$$M_{\nu_2} = M_{\nu_3} / \text{Vol}(\text{CP}2) = 5.4 \times 10^{(-2)} / 6$$

$$= 9 \times 10^{(-3)} \text{eV}.$$

The low mass state ν_1 corresponds to a neutrino whose propagation begins and ends in physical Minkowski spacetime. thus having only one anchoring to CP2 interna symmetry space.

According to the Cl(1,25) E8 model the mass of ν_1 is zero at tree-level but it has only 1 possible anchoring to CP2 as opposed to the 36 different possible anchorings for ν_3 first-order corrections or the 6 different possible anchorings for ν_2 first-order corrections so that the first-order corrected mass of ν_1 is less than the first-order corrected mass of ν_2 by a factor of 6, so

the first-order corrected mass of ν_1 is

$$M_{\nu_1} = M_{\nu_2} / \text{Vol}(\text{CP}2) = 9 \times 10^{(-3)} / 6$$

$$= 1.5 \times 10^{(-3)} \text{eV}.$$

Therefore:

$$\begin{aligned} \text{the mass-squared difference } D(M_{23}^2) &= M_{\nu_3}^2 - M_{\nu_2}^2 = \\ &= (2916 - 81) \times 10^{-6} \text{ eV}^2 = \\ &= 2.8 \times 10^{-3} \text{ eV}^2 \end{aligned}$$

and

$$\begin{aligned} \text{the mass-squared difference } D(M_{12}^2) &= M_{\nu_2}^2 - M_{\nu_1}^2 = \\ &= (81 - 2) \times 10^{-6} \text{ eV}^2 = \\ &= 7.9 \times 10^{-5} \text{ eV}^2 \end{aligned}$$

The 3x3 unitary neutrino mixing matrix neutrino mixing matrix U

	nu ₁	nu ₂	nu ₃
nu _e	Ue1	Ue2	Ue3
nu _μ	Um1	Um2	Um3
nu _τ	Ut1	Ut2	Ut3

can be parameterized (based on the 2010 Particle Data Book)
by 3 angles and 1 Dirac CP violation phase

$$U = \begin{pmatrix} c_{12} c_{13} & s_{12} c_{13} & s_{13} e^{-i\delta} \\ -s_{12} c_{23} - c_{12} s_{23} s_{13} e^{i\delta} & c_{12} c_{23} - s_{12} s_{23} s_{13} e^{i\delta} & s_{23} c_{13} \\ s_{12} s_{23} - c_{12} c_{23} s_{13} e^{i\delta} & -c_{12} s_{23} - s_{12} c_{23} s_{13} e^{i\delta} & c_{23} c_{13} \end{pmatrix}$$

where $c_{ij} = \cos(\theta_{ij})$, $s_{ij} = \sin(\theta_{ij})$

The angles are

$$\theta_{23} = \pi/4 = 45 \text{ degrees}$$

because

ν_3 has equal components of ν_m and ν_t so that $U_{m3} = U_{t3} = 1/\sqrt{2}$ or, in conventional notation, mixing angle $\theta_{23} = \pi/4$

$$\text{so that } \cos(\theta_{23}) = 0.707 = \sqrt{2}/2 = \sin(\theta_{23})$$

$$\theta_{13} = 9.594 \text{ degrees} = \arcsin(1/6)$$

$$\text{and } \cos(\theta_{13}) = 0.986$$

because $\sin(\theta_{13}) = 1/6 = 0.167 = |U_{e3}| = \text{fraction of } \nu_3 \text{ that is } \nu_e$

$$\theta_{12} = \pi/6 = 30 \text{ degrees}$$

because

$\sin(\theta_{12}) = 0.5 = 1/2 = U_{e2} = \text{fraction of } \nu_2 \text{ begin/end points}$

that are in the physical spacetime where massless ν_e lives

$$\text{so that } \cos(\theta_{12}) = 0.866 = \sqrt{3}/2$$

$d = 70.529 \text{ degrees}$ is the Dirac CP violation phase

$$e^{i(70.529)} = \cos(70.529) + i \sin(70.529) = 0.333 + 0.943 i$$

This is because the neutrino mixing matrix has 3-generation structure

and so has the same phase structure as the KM quark mixing matrix

in which the Unitarity Triangle angles are:

$$\beta = V_3.V_1.V_4 = \arccos(2 \sqrt{2} / 3) \cong 19.471 \ 220 \ 634 \text{ degrees so } \sin 2\beta = 0.6285$$

$$\alpha = V_1.V_3.V_4 = 90 \text{ degrees}$$

$$\gamma = V_1.V_4.V_3 = \arcsin(2 \sqrt{2} / 3) \cong 70.528 \ 779 \ 366 \text{ degrees}$$

The constructed Unitarity Triangle angles can be seen on the Stella Octangula configuration of two dual tetrahedra (image from gauss.math.nthu.edu.tw):

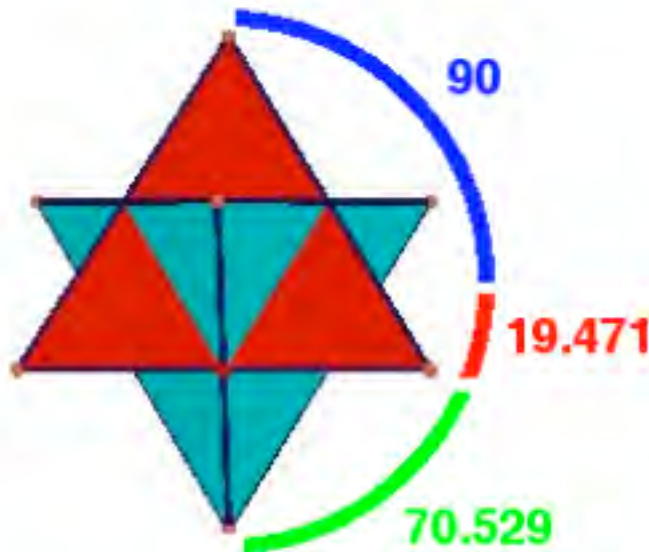

Then we have for the neutrino mixing matrix:

	nu_1	nu_2	nu_3
nu_e	0.866 x 0.986	0.50 x 0.986	0.167 x e-id
nu_m	-0.5 x 0.707 -0.866 x 0.707 x 0.167 x eid	0.866 x 0.707 -0.5 x 0.707 x 0.167 x eid	0.707 x 0.986
nu_t	0.5 x 0.707 -0.866 x 0.707 x 0.167 x eid	-0.866 x 0.707 -0.5 x 0.707 x 0.167 x eid	0.707 x 0.986

	nu_1	nu_2	nu_3
nu_e	0.853	0.493	0.167 e-id
nu_m	-0.354 -0.102 eid	0.612 -0.059 eid	0.697
nu_t	0.354 -0.102 eid	-0.612 -0.059 eid	0.697

Since $e^{i(70.529)} = \cos(70.529) + i \sin(70.529) = 0.333 + 0.943 i$
and $.333e^{-i(70.529)} = \cos(70.529) - i \sin(70.529) = 0.333 - 0.943 i$

	nu_1	nu_2	nu_3
nu_e	0.853	0.493	0.056 - 0.157 i
nu_m	-0.354 -0.034 - 0.096 i	0.612 -0.020 - 0.056 i	0.697
nu_t	0.354 -0.034 - 0.096 i	-0.612 -0.020 - 0.056 i	0.697

for a result of

	nu_1	nu_2	nu_3
nu_e	0.853	0.493	0.056 - 0.157 i
nu_m	-0.388 - 0.096 i	0.592 - 0.056 i	0.697
nu_t	0.320 - 0.096 i	0.632 - 0.056 i	0.697

which is consistent with the approximate experimental values of mixing angles shown in the Michaelmas Term 2010 Particle Physics handout of Prof Mark Thomson if the matrix is modified by taking into account the March 2012 results from Daya Bay observing non-zero $\theta_{13} = 9.54$ degrees.

Proton-Neutron Mass Difference

An up valence quark, constituent mass 313 Mev,
does not often swap places with a 2.09 Gev charm sea quark,
but
a 313 Mev down valence quark
can more often swap places with a 625 Mev strange sea quark.

Therefore the Quantum color force
constituent mass of the down valence quark is heavier by about

$$(m_s - m_d) (m_d/m_s)^2 a(w) |V_{ds}| = 312 \times 0.25 \times 0.253 \times 0.22 \text{ Mev} = 4.3 \text{ Mev},$$

(where $a(w) = 0.253$ is the geometric part of the weak force strength
and $|V_{ds}| = 0.22$ is the magnitude
of the K-M parameter mixing first generation down and second generation strange)

so that the Quantum color force constituent mass Q_{md} of the down quark is

$$Q_{md} = 312.75 + 4.3 = 317.05 \text{ MeV}.$$

Similarly, the up quark Quantum color force mass increase is about

$$(m_c - m_u) (m_u/m_c)^2 a(w) |V_{uc}| = 1777 \times 0.022 \times 0.253 \times 0.22 \text{ Mev} = 2.2 \text{ Mev},$$

(where $|V_{uc}| = 0.22$ is the magnitude
of the K-M parameter mixing first generation up and second generation charm)

so that the Quantum color force constituent mass Q_{mu} of the up quark is

$$Q_{mu} = 312.75 + 2.2 = 314.95 \text{ MeV}.$$

Therefore, the Quantum color force Neutron-Proton mass difference is

$$m_N - m_P = Q_{md} - Q_{mu} = 317.05 \text{ Mev} - 314.95 \text{ Mev} = 2.1 \text{ Mev}.$$

Since the electromagnetic Neutron-Proton mass difference is roughly

$$m_N - m_P = -1 \text{ MeV}$$

the total theoretical Neutron-Proton mass difference is

$$m_N - m_P = 2.1 \text{ Mev} - 1 \text{ Mev} = 1.1 \text{ Mev},$$

an estimate that is comparable to the experimental value of 1.3 Mev.

Pion as Sine-Gordon Breather

The quark content of a charged pion is a quark - antiquark pair: either Up plus antiDown or Down plus antiUp. Experimentally, its mass is about 139.57 MeV.

The quark is a Schwinger Source Kerr-Newman Black Hole with constituent mass M 312 MeV.

The antiquark is also a Schwinger Source Kerr-Newman Black Hole, with constituent mass M 312 MeV.

According to section 3.6 of Jeffrey Winicour's 2001 Living Review of the Development of Numerical Evolution Codes for General Relativity (see also a 2005 update):

"... The black hole event horizon associated with ... slightly broken ... degeneracy [of the axisymmetric configuration]... reveals new features not seen in the degenerate case of the head-on collision ... If the degeneracy is slightly broken, the individual black holes form with spherical topology but as they approach, tidal distortion produces two sharp pincers on each black hole just prior to merger. ...

Tidal distortion of approaching black holes ... Formation of sharp pincers just prior to merger ..

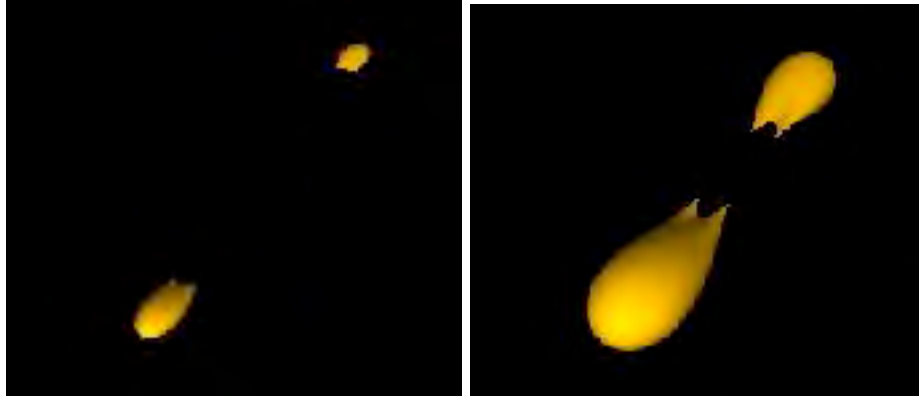

... toroidal stage just after merger ...



At merger, the two pincers join to form a single ... toroidal black hole.

The inner hole of the torus subsequently [begins to] close... up (superluminally) ... [If the closing proceeds to completion, it]... produce[s] first a peanut shaped black hole and finally a spherical black hole. ...".

In the physical case of quark and antiquark forming a pion, the toroidal black hole remains a torus.

The torus is an event horizon and therefore is not a 2-spacelike dimensional torus, but is a (1+1)-dimensional torus with a timelike dimension.

The effect is described in detail in Robert Wald's book General Relativity (Chicago 1984). It can be said to be due to extreme frame dragging, or to timelike translations becoming spacelike as though they had been Wick rotated in Complex SpaceTime.

As Hawking and Ellis say in The LargeScale Structure of Space-Time (Cambridge 1973):

"... The surface $r = r_+$ is ... the event horizon ... and is a null surface ...

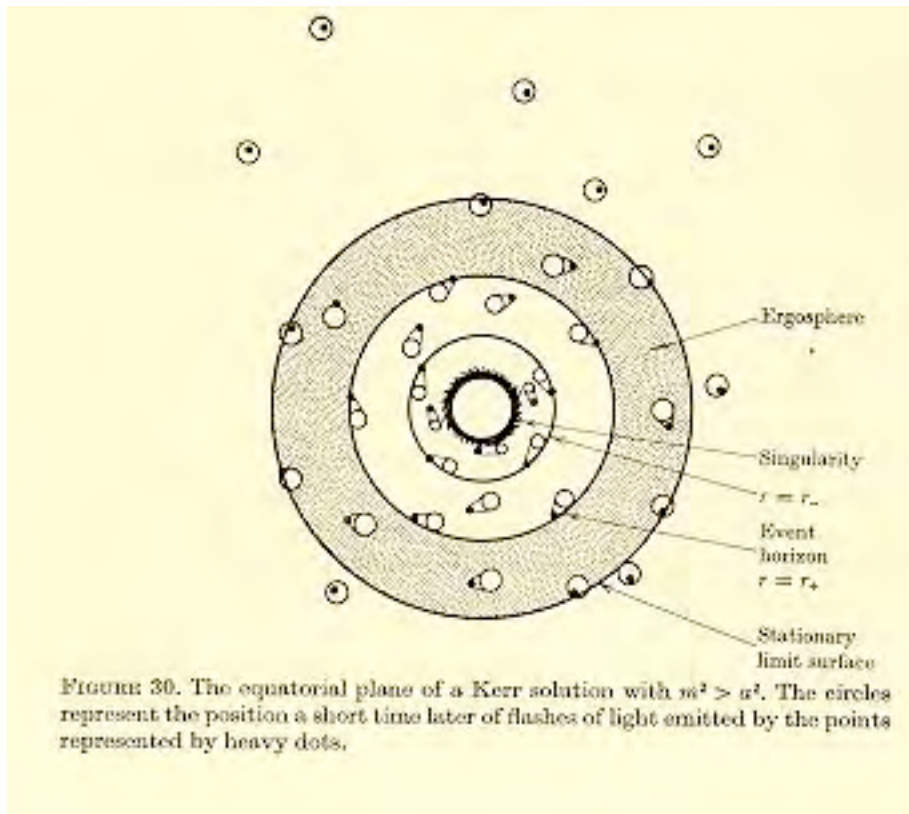

... On the surface $r = r_+$ the wavefront corresponding to a point on this surface lies entirely within the surface. ...".

A (1+1)-dimensional torus with a timelike dimension can carry a Sine-Gordon Breather. The soliton and antisoliton of a Sine-Gordon Breather correspond to the quark and antiquark that make up the pion, analogous to the Massive Thirring Model.

Sine-Gordon Breathers are described by Sidney Coleman in his Erica lecture paper Classical Lumps and their Quantum Descendants (1975), reprinted in his book Aspects of Symmetry (Cambridge 1985), where he writes the Lagrangian for the Sine-Gordon equation as (Coleman's eq. 4.3):

$$L = (1 / B^2) ((1/2) (df)^2 + A (\cos(f) - 1))$$

Coleman says: "... We see that, in classical physics, B is an irrelevant parameter: if we can solve the sine-Gordon equation for any non-zero B, we can solve it for any other B.

The only effect of changing B is the trivial one of changing the energy and momentum assigned to a given solution of the equation. This is not true in quantum physics, because the relevant object for quantum physics is not L but [eq. 4.4]

$$L / \hbar = (1 / (B^2 \hbar)) ((1/2) (df)^2 + A (\cos(f) - 1))$$

An other way of saying the same thing is to say that in quantum physics we have one more dimensional constant of nature, Planck's constant, than in classical physics. ... the classical limit, vanishing \hbar , is exactly the same as the small-coupling limit, vanishing B ... from now on I will ... set \hbar equal to one. ...

... the sine-Gordon equation ...[has]... an exact periodic solution ...[eq. 4.59]...

$$f(x, t) = (4 / B) \arctan((n \sin(w t) / \cosh(n w x))$$

where [eq. 4.60] $n = \sqrt{ A - w^2 } / w$ and w ranges from 0 to A.

This solution has a simple physical interpretation ... a soliton far to the left ...[and]... an antisoliton far to the right. As $\sin(w t)$ increases, the soliton and antisoliton move farther apart from each other. When $\sin(w t)$ passes through one, they turn around and begin to approach one another. As $\sin(w t)$ comes down to zero ... the soliton and antisoliton are on top of each other ... when $\sin(w t)$ becomes negative .. the soliton and antisoliton have passed each other.

... Thus, Eq. (4.59) can be thought of as a soliton and an antisoliton oscillation about their common center-of-mass. For this reason, it is called 'the doublet [or Breather] solution'. ... the energy of the doublet ...[eq. 4.64]

$$E = 2 M \sqrt{ 1 - (w^2 / A) }$$

where [eq. 4.65] $M = 8 \sqrt{ A } / B^2$ is the soliton mass.

Note that the mass of the doublet is always less than twice the soliton mass, as we would expect from a soliton-antisoliton pair. ...

Dashen, Hasslacher, and Neveu ... Phys. Rev. D10, 4114; 4130; 4138 (1974).
 ...[found that]... there is only a single series of bound states, labeled by the integer N ...
 The energies ... are ... [eq. 4.82]

$$E_N = 2 M \sin(B'^2 N / 16)$$

where $N = 0, 1, 2 \dots < 8 \pi / B'^2$, [eq. 4.83]

$B'^2 = B^2 / (1 - (B^2 / 8 \pi))$ and M is the soliton mass.

M is not given by Eq. (4.65), but is the soliton mass corrected by the DHN formula, or, equivalently, by the first-order weak coupling expansion. ...

I have written the equation in this form .. to eliminate A, and thus avoid worries about renormalization conventions.

Note that the DHN formula is identical to the Bohr-Sommerfeld formula, except that B is replaced by B'.

Bohr and Sommerfeld[s] ... quantization formula says that if we have a one-parameter family of periodic motions, labeled by the period, T, then an energy eigenstate occurs whenever [eq. 4.66]

$$[\text{Integral from 0 to T}](dt p \dot{q} = 2 \pi N,$$

where N is an integer. ... Eq.(4.66) is cruder than the WKB formula, but it is much more general;

it is always the leading approximation for any dynamical system ...

Dashen et al speculate that Eq. (4.82) is exact. ...

the sine-Gordon equation is equivalent ... to the massive Thirring model.

This is surprising,

because the massive Thirring model is a canonical field theory

whose Hamiltonian is expressed in terms of fundamental Fermi fields only.

Even more surprising, when $B^2 = 4 \pi$, that sine-Gordon equation is equivalent to a free massive Dirac theory, in one spatial dimension. ...

Furthermore, we can identify the mass term in the Thirring model with the sine-Gordon interaction, [eq. 5.13]

$$M = - (A / B^2) N_m \cos(B f)$$

.. to do this consistently ... we must say [eq. 5.14]

$$B^2 / (4 \pi) = 1 / (1 + g / \pi)$$

....[where]... g is a free parameter, the coupling constant [for the Thirring model]...

Note that if $B^2 = 4 \pi$, $g = 0$,

and the sine-Gordon equation is the theory of a free massive Dirac field. ...

It is a bit surprising to see a fermion appearing as a coherent state of a Bose field.

Certainly this could not happen in three dimensions,

where it would be forbidden by the spin-statistics theorem.

However, there is no spin-statistics theorem in one dimension,

for the excellent reason that there is no spin. ...

the lowest fermion-antifermion bound state of the massive Thirring model

is an obvious candidate for the fundamental meson of sine-Gordon theory. ...

equation (4.82) predicts that

all the doublet bound states disappear when B^2 exceeds 4π .

This is precisely the point where the Thirring model interaction switches from attractive to repulsive. ... these two theories ... the massive Thirring model .. and ... the sine-Gordon equation ... define identical physics. ...

I have computed the predictions of ...[various]... approximation methods for the ration of the soliton mass to the meson mass for three values of B^2 : 4π (where the qualitative picture of the soliton as a lump totally breaks down), 2π , and π . At 4π we know the exact answer ... I happen to know the exact answer for 2π , so I have included this in the table. ...

Method	$B^2 = \pi$	$B^2 = 2\pi$	$B^2 = 4\pi$
Zeroth-order weak coupling expansion eq2.13b	2.55	1.27	0.64
Coherent-state variation	2.55	1.27	0.64
First-order weak coupling expansion	2.23	0.95	0.32
Bohr-Sommerfeld eq4.64	2.56	1.31	0.71
DHN formula eq4.82	2.25	1.00	0.50
Exact	?	1.00	0.50

...[eq. 2.13b]

$$E = 8 \sqrt{A} / B^2$$

...[is the]... energy of the lump ... of sine-Gordon theory ... frequently called 'soliton...' in the literature ...

[Zeroth-order is the classical case, or classical limit.] ...

... Coherent-state variation always gives the same result as the ... Zeroth-order weak coupling expansion

The ... First-order weak-coupling expansion ... explicit formula ... is $(8 / B^2) - (1 / \pi)$".

Using the $Cl(1,25)$ E8 model constituent mass of the Up and Down quarks and antiquarks, about 312.75 MeV, as the soliton and antisoliton masses, and setting $B^2 = \pi$ and using the DHN formula, the mass of the charged pion is calculated to be $(312.75 / 2.25)$ MeV = 139 MeV which is close to the experimental value of about 139.57 MeV.

Why is the value $B^2 = \pi$ the special value that gives the pion mass ?

(or, using Coleman's eq. (5.14), the Thirring coupling constant $g = 3\pi$)

Because $B^2 = \pi$ is where the First-order weak coupling expansion substantially coincides with the (probably exact) DHN formula. In other words,

The physical quark - antiquark pion lives where the first-order weak coupling expansion is exact.

Planck Mass as Superposition Fermion Condensate

At a single spacetime vertex, a Planck-mass black hole is the Many-Worlds quantum sum of all possible virtual first-generation particle-antiparticle fermion pairs allowed by the Pauli exclusion principle to live on that vertex.

Once a Planck-mass black hole is formed, it is stable in the E8 model. Less mass would not be gravitationally bound at the vertex. More mass at the vertex would decay by Hawking radiation.

There are 8 fermion particles and 8 fermion antiparticles for a total of 64 particle-antiparticle pairs. Of the 64 particle-antiparticle pairs, 12 are bosonic pions.

A typical combination should have about 6 pions so it should have a mass of about $.14 \times 6 \text{ GeV} = 0.84 \text{ GeV}$.

Just as the pion mass of $.14 \text{ GeV}$ is less than the sum of the masses of a quark and an antiquark, pairs of oppositely charged pions may form a bound state of less mass than the sum of two pion masses.

If such a bound state of oppositely charged pions has a mass as small as $.1 \text{ GeV}$, and if the typical combination has one such pair and 4 other pions, then the typical combination could have a mass in the range of 0.66 GeV .

Summing over all 2^{64} combinations, the total mass of a one-vertex universe should give a Planck mass roughly around $0.66 \times 2^{64} = 1.217 \times 10^{19} \text{ GeV}$.

The value for the Planck mass given in by the 1998 Particle Data Group is $1.221 \times 10^{19} \text{ GeV}$.

Conformal Gravity+Dark Energy and DE : DM : OM

MacDowell-Mansouri Gravity is described by Rabindra Mohapatra in section 14.6 of his book "Unification and Supersymmetry":

§14.6. Local Conformal Symmetry and Gravity

Before we study supergravity, with the new algebraic approach developed, we would like to discuss how gravitational theory can emerge from the gauging of conformal symmetry. For this purpose we briefly present the general notation for constructing gauge covariant fields. The general procedure is to start with the Lie algebra of generators X_A of a group

$$[X_A, X_B] = f_{AB}^C X_C, \quad (14.6.1)$$

where f_{AB}^C are structure constants of the group. We can then introduce a gauge field connection h_μ^A as follows:

$$h_\mu \equiv h_\mu^A X_A. \quad (14.6.2)$$

Let us denote the parameter associated with X_A by ε^A . The gauge transformations on the fields h_μ^A are given as follows:

$$\delta h_\mu^A = \partial_\mu \varepsilon^A + h_\mu^B \varepsilon^C f_{CB}^A \equiv (D_\mu \varepsilon)^A. \quad (14.6.3)$$

We can then define a covariant curvature

$$R_{\mu\nu}^A = \partial_\nu h_\mu^A - \partial_\mu h_\nu^A + h_\nu^B h_\mu^C f_{CB}^A. \quad (14.6.4)$$

Under a gauge transformation

$$\delta_{\text{gauge}} R_{\mu\nu}^A = R_{\mu\nu}^B \varepsilon^C f_{CB}^A. \quad (14.6.5)$$

We can then write the general gauge invariant action as follows:

$$I = \int d^4x Q_{AB}^{\mu\nu\sigma\tau} R_{\mu\nu}^A R_{\sigma\tau}^B. \quad (14.6.6)$$

Let us now apply this formalism to conformal gravity. In this case

$$h_\mu = P_\mu e_\nu^n + M_{nm} \omega_\mu^{nm} + K_\mu f_\nu^n + D b_\mu. \quad (14.6.7)$$

The various $R_{\mu\nu}$ are

$$R_{\mu\nu}(P) = \partial_\nu e_\mu^n - \partial_\mu e_\nu^n + \omega_\mu^{mn} e_\nu^n - \omega_\nu^{mn} e_\mu^n - b_\mu e_\nu^n + b_\nu e_\mu^n, \quad (14.6.8)$$

$$R_{\mu\nu}(M) = \partial_\nu \omega_\mu^{mn} - \partial_\mu \omega_\nu^{mn} - \omega_\nu^{mp} \omega_\mu^{nq} - \omega_\mu^{mp} \omega_\nu^{nq} - 4(e_\mu^n f_\nu^n - e_\nu^n f_\mu^n), \quad (14.6.9)$$

$$R_{\mu\nu}(K) = \partial_\nu f_\mu^n - \partial_\mu f_\nu^n - b_\mu f_\nu^n + b_\nu f_\mu^n + \omega_\mu^{mn} f_\nu^n - \omega_\nu^{mn} f_\mu^n, \quad (14.6.10)$$

$$R_{\mu\nu}(D) = \partial_\nu b_\mu - \partial_\mu b_\nu + 2e_\mu^n f_\nu^n - 2e_\nu^n f_\mu^n. \quad (14.6.11)$$

The gauge invariant Lagrangian for the gravitational field can now be written down, using eqn. (14.6.6), as

$$S = \int d^4x \varepsilon_{\mu\nu\sigma\tau} \varepsilon^{\mu\nu\sigma\tau} R_{\mu\nu}^{\alpha\beta}(M) R_{\sigma\tau}^{\gamma\delta}(M). \quad (14.6.12)$$

We also impose the constraint that

$$R_{\mu\nu}(P) = 0, \quad (14.6.13)$$

which expresses ω_a^{mn} as a function of (e, b) . The reason for imposing this constraint has to do with the fact that P_m transformations must be eventually identified with coordinate transformation. To see this point more explicitly let us consider the vierbein e_a^μ . Under coordinate transformations

$$\delta_{GC}(\xi^\nu)e_a^\mu = \partial_\nu \xi^\lambda e_\lambda^\mu + \xi^\lambda \partial_\lambda e_a^\mu. \quad (14.6.14)$$

Using eqn. (14.6.8) we can rewrite

$$\delta_{GC}(\xi^\nu)e_a^\mu = \delta_P(\xi^\nu)e_a^\mu + \delta_M(\xi^\nu \omega^{mn})e_a^\mu + \delta_D(\xi^\nu b) e_a^\mu + \xi^\nu R_{\nu\alpha}^\mu(P),$$

where

$$\delta_P(\xi^\nu)e_a^\mu = \partial_\nu \xi^\mu + \xi^\nu \omega_a^{\mu\nu} + \xi^{\nu\alpha} b_\alpha. \quad (14.6.15)$$

If $R^{\mu\nu}(P) = 0$, the general coordinate transformation becomes related to a set of gauge transformations via eqn. (14.6.15).

At this point we also wish to point out how we can define the covariant derivative. In the case of internal symmetries $D_\mu = \partial_\mu - iX_A h_\mu^A$; now since momentum is treated as an internal symmetry we have to give a rule. This follows from eqn. (14.6.15) by writing a redefined translation generator \tilde{P} such that

$$\delta_{\tilde{P}}(\xi) = \delta_{GC}(\xi^\nu) - \sum_A \delta_A(\xi^{\nu\alpha} h_\alpha^A), \quad (14.6.16)$$

where A' goes over all gauge transformations excluding translation. The rule is

$$\delta_{\tilde{P}}(\xi^{\nu\alpha})\phi = \xi^{\nu\alpha} D_\alpha^C \phi. \quad (14.6.17)$$

We also wish to point out that for fields which carry spin or conformal charge, only the intrinsic parts contribute to D_α^C and the orbital parts do not play any role.

Coming back to the constraints we can then vary the action with respect to f_a^m to get an expression for it, i.e.,

$$e_a^\nu f_{\nu m} = -\frac{1}{4}[e_a^\lambda e_{\nu\lambda} R_{\lambda\alpha}^{\nu\alpha} - \frac{1}{6}g_{\mu\nu} R], \quad (14.6.18)$$

where f_a^m has been set to zero in R written in the right-hand side.

This eliminates (from the theory the degrees of freedom) ω_a^{mn} and f_a^m and we are left with e_a^μ and b_μ . Furthermore, these constraints will change the transformation laws for the dependent fields so that the constraints do not change.

Let us now look at the matter coupling to see how the familiar gravity theory emerges from this version. Consider a scalar field ϕ . It has conformal weight $\lambda = 1$. So we can write a covariant derivative for it, eqn. (14.6.17)

$$D_\mu^C \phi = \partial_\mu \phi - \phi b_\mu. \quad (14.6.19)$$

We note that the conformal charge of ϕ can be assumed to be zero since $K_m = x^2 \partial$ and is the dimension of inverse mass. In order to calculate $\square^C \phi$ we

start with the expression for d'Alembertian in general relativity

$$\frac{1}{e} \partial_\nu (g^{\mu\nu} e D_\mu^c \phi). \quad (14.6.20)$$

The only transformations we have to compensate for are the conformal transformations and the scale transformations. Since

$$\delta b_\mu = -2\xi_k^m e_{m\mu}, \quad \delta(\phi b_\mu) = \phi \delta b_\mu = -2\phi f_\mu^m e_m^\nu = +\frac{1}{2} \phi R, \quad (14.6.21)$$

where, in the last step, we have used the constraint equation (14.6.18). Putting all these together we find

$$\square^c \phi = \frac{1}{e} \partial_\nu (g^{\mu\nu} e D_\mu^c \phi) + b_\mu D_\mu^c \phi + \frac{1}{2} \phi R. \quad (14.6.22)$$

Thus, the Lagrangian for conformal gravity coupled to matter fields can be written as

$$S = \int e d^4x \frac{1}{2} \phi \square^c \phi. \quad (14.6.23)$$

Now we can use conformal transformation to gauge $b_\mu = 0$ and local scale transformation to set $\phi = \kappa^{-1}$ leading to the usual Hilbert action for gravity. To summarize, we start with a Lagrangian invariant under full local conformal symmetry and fix conformal and scale gauge to obtain the usual action for gravity. We will adopt the same procedure for supergravity. An important technical point to remember is that, \square^c , the conformal d'Alembertian contains R , which for constant ϕ , leads to gravity. We may call ϕ the auxiliary field.

After the scale and conformal gauges have been fixed, the conformal Lagrangian becomes a de Sitter Lagrangian.

Einstein-Hilbert gravity can be derived from the de Sitter Lagrangian, as was first shown by MacDowell and Mansouri (Phys. Rev. Lett. 38 (1977) 739).

(Frank Wilczek, in hep-th/9801184 says that the MacDowell-Mansouri "... approach to casting gravity as a gauge theory was initiated by MacDowell and Mansouri ...

S. MacDowell and F. Mansouri, Phys. Rev. Lett. 38 739 (1977) ... ,

and independently Chamseddine and West ... A. Chamseddine and P. West Nucl. Phys. B 129, 39 (1977); also quite relevant is A. Chamseddine, Ann. Phys. 113, 219 (1978). ...".)

**The minimal group required to produce Gravity,
and therefore the group that is used in calculating Force Strengths,
is the [anti] de Sitter group,** as is described by

Freund in chapter 21 of his book Supersymmetry (Cambridge 1986) (chapter 21 is a Non-Supersymmetry chapter leading up to a Supergravity description in the following chapter 22):

"... Einstein gravity as a gauge theory ... we expect a set of gauge fields w^{ab}_u for the Lorentz group and a further set e^a_u for the translations, ...

Everybody knows though, that Einstein's theory contains but one spin two field, originally chosen by Einstein as $g_{uv} = e^a_u e^b_v n_{ab}$ (n_{ab} = Minkowski metric).

What happened to the w^{ab}_u ?

The field equations obtained from the Hilbert-Einstein action by varying the w^{ab}_u are algebraic in the w^{ab}_u ... permitting us to express the w^{ab}_u in terms of the e^a_u ... The w do not propagate ...

We start from the four-dimensional de-Sitter algebra ... $so(3,2)$.

Technically this is the anti-de-Sitter algebra ...

We envision space-time as a four-dimensional manifold M .

At each point of M we have a copy of $SO(3,2)$ (a fibre ...) ...

and we introduce the gauge potentials (the connection) $h^A_\mu(x)$

$A = 1, \dots, 10$, $\mu = 1, \dots, 4$. Here x are local coordinates on M .

From these potentials h^A_μ we calculate the field-strengths

(curvature components) [let $@$ denote partial derivative]

$R^A_{\mu\nu} = @_\mu h^A_\nu - @_\nu h^A_\mu + f^A_{BC} h^B_\mu h^C_\nu$

...[where]... the structure constants f^C_{AB} ...[are for]... the anti-de-Sitter algebra

We now wish to write down the action S as an integral over

the four-manifold M ... $S(Q) = \text{INTEGRAL}_M R^A \wedge R^B Q_{AB}$

where Q_{AB} are constants ... to be chosen ... we require

... the invariance of $S(Q)$ under local Lorentz transformations

... the invariance of $S(Q)$ under space inversions ...

...[AFTER A LOT OF ALGEBRA NOT SHOWN IN THIS QUOTE]...

we shall see ...[that]... the action becomes invariant

under all local [anti]de-Sitter transformations ...[and]... we recognize ... t

he familiar Hilbert-Einstein action with cosmological term in vierbein notation ...

Variation of the vierbein leads to the Einstein equations with cosmological term.

Variation of the spin-connection ... in turn ... yield the torsionless Christoffel

connection ... the torsion components ... now vanish.

So at this level full $sp(4)$ invariance has been checked.

... Were it not for the assumed space-inversion invariance ...

we could have had a parity violating gravity. ...

Unlike Einstein's theory ...[MacDowell-Mansouri]... does not require Riemannian invertibility of the metric. ... the solution has torsion ... produced by an interference between parity violating and parity conserving amplitudes.

Parity violation and torsion go hand-in-hand.

Independently of any more realistic parity violating solution of the gravity

equations this raises the cosmological question whether

the universe as a whole is in a space-inversion symmetric configuration. ...".

According to gr-qc/9809061 by R. Aldrovandi and J. G. Peireira:

"... If the fundamental spacetime symmetry of the laws of Physics is that given by the de Sitter instead of the Poincare group, the P-symmetry of the weak cosmological-constant limit and the Q-symmetry of the strong cosmological constant limit can be considered as limiting cases of the fundamental symmetry. ...

... N ... [is the space]... whose geometry is gravitationally related to an infinite cosmological constant ... [and]... is a 4-dimensional cone-space in which $ds = 0$, and whose group of motion is Q. Analogously to the Minkowski case, N is also a homogeneous space, but now under the kinematical group Q, that is, $N = Q/L$ [where L is the Lorentz Group of Rotations and Boosts]. In other words, the point-set of N is the point-set of the special conformal transformations.

Furthermore, the manifold of Q is a principal bundle $P(Q/L, L)$, with $Q/L = N$ as base space and L as the typical fiber. The kinematical group Q, like the Poincare group, has the Lorentz group L as the subgroup accounting for both the isotropy and the equivalence of inertial frames in this space. However, the special conformal transformations introduce a new kind of homogeneity. Instead of ordinary translations, all the points of N are equivalent through special conformal transformations. ...

... Minkowski and the cone-space can be considered as dual to each other, in the sense that their geometries are determined respectively by a vanishing and an infinite cosmological constants. The same can be said of their kinematical group of motions: P is associated to a vanishing cosmological constant and Q to an infinite cosmological constant.

The dual transformation connecting these two geometries is the spacetime inversion $x^u \rightarrow x^u / \sigma^2$. Under such a transformation, the Poincare group P is transformed into the group Q, and the Minkowski space M becomes the conespace N. The points at infinity of M are concentrated in the vertex of the conespace N, and those on the light-cone of M becomes the infinity of N. It is concepts of space isotropy and equivalence between inertial frames in the conespace N are those of special relativity. The difference lies in the concept of uniformity as it is the special conformal transformations, and not ordinary translations, which act transitively on N. ..."

Gravity and the Cosmological Constant come from the MacDowell-Mansouri Mechanism and the 15-dimensional Spin(2,4) = SU(2,2) Conformal Group, which is made up of:

**3 Rotations
3 Boosts
4 Translations
4 Special Conformal transformations
1 Dilatation**

The **Cosmological Constant / Dark Energy** comes from the **10 Rotation, Boost, and Special Conformal generators** of the Conformal Group Spin(2,4) = SU(2,2), so the fractional part of our Universe of the Cosmological Constant should be **about 10 / 15 = 67% for tree level.**

Black Holes, including **Dark Matter Primordial Black Holes**, are curvature singularities in our 4-dimensional physical spacetime, and since Einstein-Hilbert curvature comes from the **4 Translations** of the 15-dimensional Conformal Group Spin(2,4) = SU(2,2) through the MacDowell-Mansouri Mechanism (in which the generators corresponding to the 3 Rotations and 3 Boosts do not propagate), the fractional part of our Universe of Dark Matter Primordial Black Holes should be **about 4 / 15 = 27% at tree level.**

Since **Ordinary Matter** gets mass from the Higgs mechanism which is related to the **1 Scale Dilatation** of the 15-dimensional Conformal Group Spin(2,4) = SU(2,2), the fractional part of our universe of Ordinary Matter should be **about 1 / 15 = 6% at tree level.**

However,
as Our Universe evolves the Dark Energy, Dark Matter, and Ordinary Matter densities evolve at different rates,
so that the differences in evolution must be taken into account from the initial End of Inflation to the Present Time.

Without taking into account any evolutionary changes with time,
our Flat Expanding Universe should have roughly:

**67% Cosmological Constant
27% Dark Matter - possibly primordial stable Planck mass black holes
6% Ordinary Matter**

As Dennis Marks pointed out to me,
 since density ρ is proportional to $(1+z)^3(1+w)$ for red-shift factor z
 and a constant equation of state w :
 $w = -1$ for Λ and the average overall density of Λ Dark Energy remains constant
 with time and the expansion of our Universe;
 and
 $w = 0$ for nonrelativistic matter so that the overall average density of Ordinary
 Matter declines as $1 / R^3$ as our Universe expands;
 and
 $w = 0$ for primordial black hole dark matter - stable Planck mass black holes - so
 that Dark Matter also has density that declines as $1 / R^3$ as our Universe expands;
 so that the ratio of their overall average densities must vary with time, or scale
 factor R of our Universe, as it expands.
 Therefore,
 the above calculated ratio $0.67 : 0.27 : 0.06$ is valid
 only for a particular time, or scale factor, of our Universe.

When is that time ? Further, what is the value of the ratio now ?

Since WMAP observes Ordinary Matter at 4% NOW,
 the time when Ordinary Matter was 6% would be
 at redshift z such that
 $1 / (1+z)^3 = 0.04 / 0.06 = 2/3$, or $(1+z)^3 = 1.5$, or $1+z = 1.145$, or $z = 0.145$.
 To translate redshift into time,
 in billions of years before present, or Gy BP, use this chart

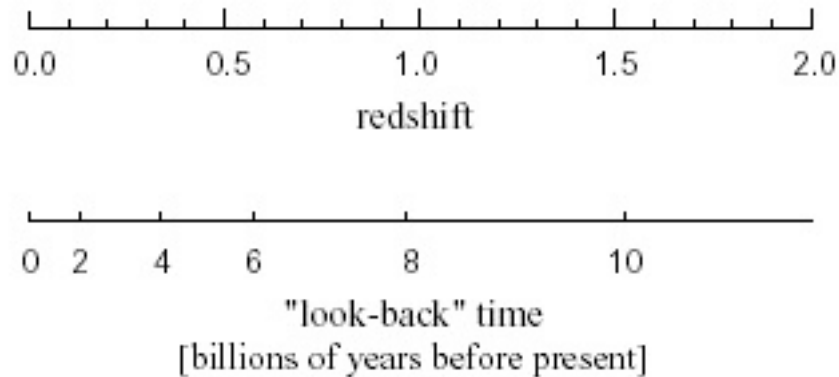

from a www.supernova.lbl.gov file SNAPoverview.pdf to see that
 the time when Ordinary Matter was 6%
 would have been a bit over 2 billion years ago, or 2 Gy BP.

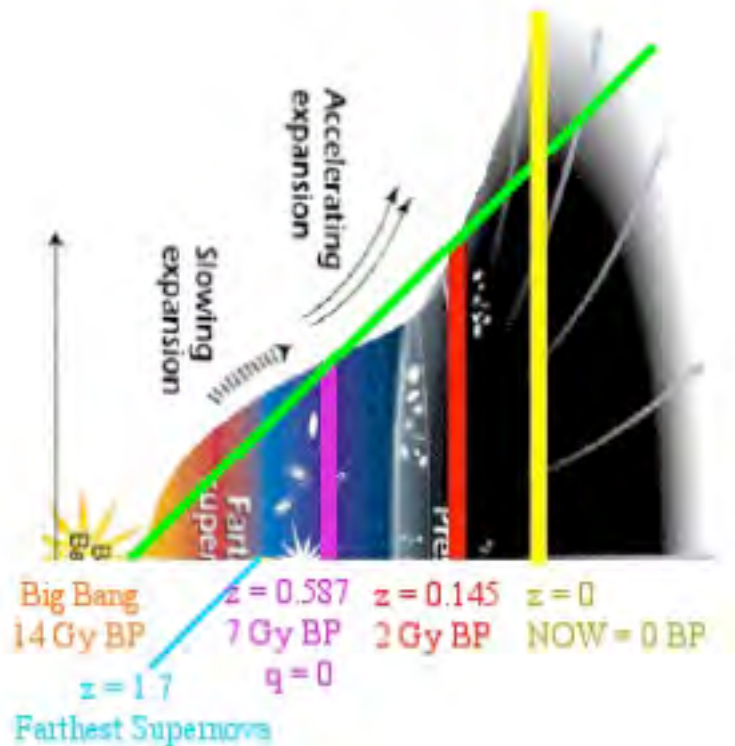

In the diagram, there are four Special Times in the history of our Universe: the Big Bang Beginning of Inflation (about 13.7 Gy BP);

1 - the End of Inflation = Beginning of Decelerating Expansion (beginning of green line also about 13.7 Gy BP);

2 - the End of Deceleration ($q=0$) = Inflection Point = Beginning of Accelerating Expansion (purple vertical line at about $z = 0.587$ and about 7 Gy BP).

According to a hubblesite web page credited to Ann Feild, the above diagram "... reveals changes in the rate of expansion since the universe's birth 15 billion years ago. The more shallow the curve, the faster the rate of expansion. The curve changes noticeably about 7.5 billion years ago, when objects in the universe began flying apart as a faster rate. ...".

According to a CERN Courier web page: "... Saul Perlmutter, who is head of the Supernova Cosmology Project ... and his team have studied altogether some 80 high red-shift type Ia supernovae. Their results imply that the universe was decelerating for the first half of its existence, and then began accelerating approximately 7 billion years ago. ...".

According to astro-ph/0106051 by Michael S. Turner and Adam G. Riess: "... current supernova data ... favor deceleration at $z > 0.5$... SN 1997ff at $z = 1.7$ provides direct evidence for an early phase of slowing expansion if the dark energy is a cosmological constant ...".

3 - the Last Intersection of the Accelerating Expansion of our Universe of Linear Expansion (green line) with the Third Intersection (at red vertical line at $z = 0.145$ and about 2 Gy BP), which is also around the times of the beginning of the Proterozoic Era and Eukaryotic Life, Fe₂O₃ Hematite ferric iron Red Bed formations, a Snowball Earth, and the start of the Oklo fission reactor. 2 Gy is also about 10 Galactic Years for our Milky Way Galaxy and is on the order of the time for the process of a collision of galaxies.

4 - Now.

Those four Special Times define four Special Epochs:

The Inflation Epoch, beginning with the Big Bang and ending with the End of Inflation. The Inflation Epoch is described by Zizzi Quantum Inflation ending with Self-Decoherence of our Universe (see gr-qc/0007006).

The Decelerating Expansion Epoch, beginning with the Self-Decoherence of our Universe at the End of Inflation. During the Decelerating Expansion Epoch, the Radiation Era is succeeded by the Matter Era, and the Matter Components (Dark and Ordinary) remain more prominent than they would be under the "standard norm" conditions of Linear Expansion.

The Early Accelerating Expansion Epoch, beginning with the End of Deceleration and ending with the Last Intersection of Accelerating Expansion with Linear Expansion. During Accelerating Expansion, the prominence of Matter Components (Dark and Ordinary) declines, reaching the "standard norm" condition of Linear Expansion at the end of the Early Accelerating Expansion Epoch at the Last Intersection with the Line of Linear Expansion.

The Late Accelerating Expansion Epoch, beginning with the Last Intersection of Accelerating Expansion and continuing forever, with New Universe creation happening many times at Many Times. During the Late Accelerating Expansion Epoch, the Cosmological Constant Λ is more prominent than it would be under the "standard norm" conditions of Linear Expansion.

Now happens to be about 2 billion years into the Late Accelerating Expansion Epoch.

What about Dark Energy : Dark Matter : Ordinary Matter now ?

As to how the Dark Energy Λ and Cold Dark Matter terms have evolved during the past 2 Gy, a rough estimate analysis would be:

Λ and CDM would be effectively created during expansion in their natural ratio $67 : 27 = 2.48 = 5 / 2$, each having proportionate fraction $5 / 7$ and $2 / 7$, respectively; CDM Black Hole decay would be ignored; and pre-existing CDM Black Hole density would decline by the same $1 / R^3$ factor as Ordinary Matter, from 0.27 to $0.27 / 1.5 = 0.18$.

The Ordinary Matter excess $0.06 - 0.04 = 0.02$ plus the first-order CDM excess $0.27 - 0.18 = 0.09$ should be summed to get a total first-order excess of 0.11 , which in turn should be distributed to the Λ and CDM factors in their natural ratio $67 : 27$, producing, for NOW after 2 Gy of expansion:

CDM Black Hole factor = $0.18 + 0.11 \times 2/7 = 0.18 + 0.03 = 0.21$
for a total calculated Dark Energy : Dark Matter : Ordinary Matter ratio for now of

$$0.75 : 0.21 : 0.04$$

so that the present ratio of $0.73 : 0.23 : 0.04$ observed by WMAP seems to me to be substantially consistent with the cosmology of the E8 model.

2013 Planck Data (arxiv 1303.5062) showed "... anomalies ... previously observed in the WMAP data ... alignment between the quadrupole and octopole moments ... asymmetry of power between two ... hemispheres ... Cold Spot ... are now confirmed at ... 3 sigma ... but a higher level of confidence ...".

E8 model rough evolution calculation is: DE : DM : OM = 75 : 20 : 05

WMAP: DE : DM : OM = 73 : 23 : 04

Planck: DE : DM : OM = 69 : 26 : 05

basic unevolved E8 Conformal calculation: DE : DM : OM = 67 : 27 : 06

Since uncertainties are substantial, I think that there is reasonable consistency.

Calculation Results

Here is a summary of Cl(16) Physics model calculation results. Since ratios are calculated, values for one particle mass and one force strength are assumed. Quark masses are constituent masses. Most of the calculations are tree-level, so more detailed calculations might be even closer to observations.

Dark Energy : Dark Matter : Ordinary Matter = 0.75 : 0.21 : 0.04

Fermions as Schwinger Sources have geometry of Complex Bounded Domains with Kerr-Newman Black Hole structure size about 10^{-24} cm.

Particle/Force	Tree-Level	Higher-Order
e-neutrino	0	0 for nu_1
mu-neutrino	0	9×10^{-3} eV for nu_2
tau-neutrino	0	5.4×10^{-2} eV for nu_3
electron	0.5110 MeV	
down quark	312.8 MeV	charged pion = 139 MeV
up quark	312.8 MeV	proton = 938.25 MeV
		neutron - proton = 1.1 MeV
muon	104.8 MeV	106.2 MeV
strange quark	625 MeV	
charm quark	2090 MeV	
tauon	1.88 GeV	
beauty quark	5.63 GeV	
truth quark (low state)	130 GeV	(middle state) 174 GeV (high state) 220 GeV
W+	80.326 GeV	
W-	80.326 GeV	
W0	98.379 GeV	Z0 = 91.862 GeV
Mplanck	1.217×10^{19} GeV	
Higgs VEV (assumed)	252.5 GeV	
Higgs (low state)	125 GeV	(middle state) 195 GeV (high state) 250 GeV

Particle/Force	Tree-Level	Higher-Order
Gravity G_g (assumed) 1 (G_g)($M_{\text{proton}}^2 / M_{\text{planck}}^2$)		5×10^{-39}
EM fine structure	1/137.03608	
Weak G_w $G_w(M_{\text{proton}}^2 / (M_{W^+}^2 + M_{W^-}^2 + M_{Z^0}^2))$	0.2535	1.05×10^{-5}
Color Force at 0.245 GeV	0.6286	0.106 at 91 GeV

Kobayashi-Maskawa parameters for W^+ and W^- processes are:

	d	s	b
u	0.975	0.222	0.00249 -0.00388i
c	-0.222 -0.000161i	0.974 -0.0000365i	0.0423
t	0.00698 -0.00378i	-0.0418 -0.00086i	0.999

The phase angle d_{13} is taken to be 1 radian.

Coleman-Mandula

Lagrangian has 8-dim Lorentz structure satisfying Coleman-Mandula because its Fermionic fundamental spinor representations are built with respect to spinor representations for 8-dim Spin(1,7) spacetime - see Steven Weinberg, "The Quantum Theory of Fields" Volume III

Chirality

Lagrangian is Chiral because

E8 contains Cl(16) half-spinors (64+64) for a Fermion Generation but does not contain Cl(16) Mirror Fermion AntiGeneration half-spinors.

Fermion +half-spinor Particles with high enough velocity are seen as left-handed.

Fermion -half-spinor AntiParticles with high enough velocity are seen as right-handed.

Spin-Statistics

Lagrangian obeys Spin-Statistics because the CP2 part of M4xCP2 Kaluza-Klein has index structure Euler number $2+1 = 3$ and Atiyah-Singer index $-1/8$ which is not the net number of generations because CP2 has no spin structure but you can use a generalized spin structure (Hawking and Pope (Phys. Lett. 73B (1978) 42-44)) to get (for integral m) the generalized CP2 index $n_R - n_L = (1/2) m (m+1)$

Prior to Dimensional Reduction from Octonionic Spacetime:

$$m = 1, n_R - n_L = (1/2) \times 1 \times 2 = 1 \text{ for 1 generation}$$

After Reduction to Quaternionic 4+4 Kaluza-Klein:

$$m = 2, n_R - n_L = (1/2) \times 2 \times 3 = 3 \text{ for 3 generations}$$

Hawking and Pope say: "Generalized Spin Structures in Quantum Gravity ...what happens in CP2 ... one could replace the electromagnetic field by a Yang-Mills field whose group G had a double covering $G\sim$. The fermion field would have to occur in representations which changed sign under the non-trivial element of the kernel of the projection ... $G\sim \rightarrow G$ while the bosons would have to occur in representations which did not change sign ...".

For E8 physics gauge bosons are in the $28+28=56$ -dim D4xD4 subalgebra. D4 = SO(8) is the Hawking-Pope G with double covering $G\sim = \text{Spin}(8)$. The 8 fermion particles / antiparticles are D4 half-spinors represented within E8 by anti-commutators and so do change sign while the 28 gauge bosons are D4 adjoint represented within E8 by commutators and so do not change sign.

E8 Lagrangian inherits from F4 the property whereby its Spinor Part need not be written as Commutators but can also be written in terms of Fermionic AntiCommutators - see Pierre Ramond hep-th/0112261 - also, F4 lives in Cl(8) as Vectors + BiVectors + Spinors and by 8-Periodicity Cl(16) = tensor product Cl(8) x Cl(8) and E8 lives in Cl(16) as BiVectors + half-Spinors.

3 Generations

When 8-dim Octonionic Symmetry of Spacetime breaks down below Planck Energy to (4+4)-dim Quaternionic M4 x CP2 Kaluza-Klein with CP2 = SU(3) / SU(2) x U(1) the Higgs and Second and Third Generation Fermions emerge.

In Kaluza-Klein M4 x CP2 there are 3 possibilities for a Fermion represented by an Octonion O basis element to go from point A to point B:

1 - A and B are both in M4: First Generation Fermion = Octonion O



2 - Either A or B, but not both, is in CP2: Second Generation Fermion = OxO Pair

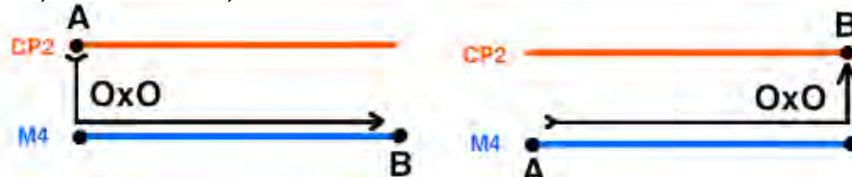

3 - Both A and B are in CP2: Third Generation Fermion = OxOxO Triple of Octonions

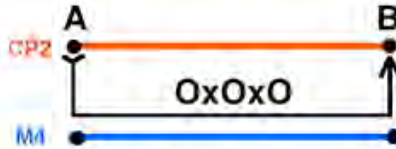

The Higgs and the Truth Quark form a Nambu-Jona-Lasinio System with 3 Mass States and the Higgs as Fermion Condensate dominated by the very massive (relative to other Fermions) Truth Quark

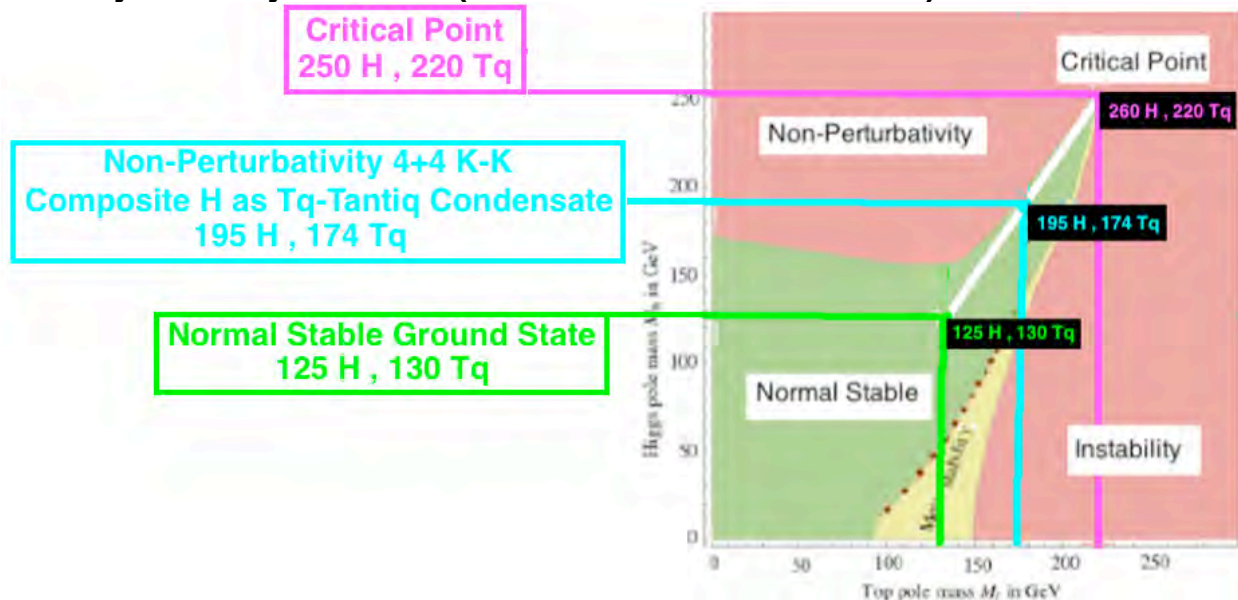

Cl(16) TriVectors

560 TriVectors of Cl(16) represent 10 copies of 56-dim Fr3(O)
 56-dim Fr3(O) = Freudenthal Algebra of Zorn vector-matrices

$$\begin{array}{ccc}
 & & d \quad S_+ \quad V \\
 & & S_+^* \quad e \quad S_- \\
 a & & V^* \quad S_-^* \quad f \\
 \\
 d' & S_+^* & V'^* \\
 S_+' & e' & S_-'^* \\
 V' & S_-'^* & f' \\
 & & b
 \end{array}$$

where a, b, d, e, and f are real numbers; S_+ , V , S_- , S_+' , V' , and $S_-'^*$ are Octonions; and * denotes conjugation.

$$\begin{array}{ccc}
 d & S_+ & V \\
 S_+^* & e & S_- \\
 V^* & S_-^* & f
 \end{array}$$

is 27-dim J3(O) = 3x3 Hermitian Octonion Matrices whose traceless part is 26-dim J3(O) that describes

26D String Theory with Strings = World-Lines and

V = 8-dim Spacetime

the 8-real-dim space $RP^1 \times S^7$ that is the Shilov Boundary of the 16-real-dim $IV(8,2)$ Bounded Domain (tube type) of the BDI Symmetric Space $Spin(10) / Spin(8) \times U(1)$

S+ = 8 +half-Spinor Fermion Particles

the real part $RP^1 \times S^7$ of the Complex Shilov Boundary S of the 32-real-dim V non-tube type bounded Domain $(C \times O)P_2$ of the EIII Symmetric Space $E_6 / Spin(10) \times U(1)$.

S- = 8 - half-Spinor Fermion AntiParticles

$RP^1 \times S^7$ in the Complex part of the Shilov Boundary S of the 32-real-dim V non-tube type bounded Domain $(C \times O)P_2$ of the EIII Symmetric Space $E_6 / Spin(10) \times U(1)$

With **S+** and **S-** Fermions propagating in **V** Spacetime,
Strings are physically interpreted as World-Lines,

according to David Finkelstein's idea ("Space-Time Code. III" Phys. Rev. D (1972) 2922-2931)

"... According to relativity, the world is a collection of processes (events) with an unexpectedly unified causal or chronological structure. Then an object is secondary ... [to]... a long causal sequence of processes, world line. ... [if] we assemble these ... into chromosomelike code sequences ... and braid and cross-link these strands to make more complex objects and their interactions ...[then]... The idea of the quantum jump comes into its own, and reigns supreme, even over space and time. ...".

Andrew Gray (quant-ph/9712037v2) said:

"... A new formulation of quantum mechanics ... assign[s] ... probabilities ... to entire fine-grained histories ... [It] is fully relativistic and applicable to multi-particle systems ...[and]... makes the same experimental predictions as quantum field theory ...

consider space and time cut up into small volume elements

... and then take the limit as ... volume ... $\rightarrow 0$...
 get the final amplitude ... by considering all possible distributions at a time t earlier ...
 for each such distribution the amplitude for it to occur [is] multiplied by the amplitude to get ... the final distribution ... **the interference factor ... is a measure of how much interference between the different possible histories that contain the distribution of interest there is at each time ... This result is the ... Feynman amplitude squared times the product of all the interference factors ...**”.

Luis E. Ibanez and Angel M. Uranga in “String Theory and Particle Physics” said:

“... String theory proposes ... small one-dimensional extended objects, strings, of typical size $L_s = 1/M_s$, with M_s known as the string scale ... As a string evolves in time, it sweeps out a two-dimensional surface in spacetime, known as the worldsheet, which is the analog of the ... worldline of a point particle ... for the bosonic string theory ... the classical string action is the total area spanned by the worldsheet ... This is the ... Nambu– Goto action ...”.

Consider the Gray Fine-Grained History to be a World-Line String.



**The Gray Fine-Grained History Quantum Theory
 is equivalent to
 the Nambu-Goto action of 26D String Theory.**

**Nambu-Goto 24x24 traceless spin-2 particle
 is
 Quantum Bohmion carrier of Bohm Quantum Potential**

Ibanez and Uranga also said:

“... The string groundstate corresponds to a 26d spacetime tachyonic scalar field $T(x)$. This **tachyon** ... is ... unstable

...

The massless two-index tensor splits into irreducible representations of $SO(24)$...

Its **trace** corresponds to a scalar field, the **dilaton** ϕ , whose vev fixes the string interaction coupling constant g_s

...

the **antisymmetric** part is the 26d 2-form field BMN

...

The **symmetric traceless** part is the 26d ... GMN ...”.

Tachyons localized at Orbifolds of Fermions produce virtual clouds of particles / antiparticles that dress Fermions as Schwinger Sources.

Dilatons are Goldstone bosons of spontaneously broken scale invariance that

(analogous to Higgs) go from mediating a long-range scalar gravity-type force to the nonlocality of the Bohm-Sarfatti Quantum Potential.

The **antisymmetric** $SO(24)$ little group is related to the Monster automorphism group that is the symmetry of each cell of Planck-scale local lattice structure.

The **symmetric traceless part is the Bohmion** carrier of the Bohm Quantum Potential. It has spin-2.

Of the 26 dimensions,
16 are for Orbifolded First Generation Fermion Particles (8 types) and AntiParticles (8 types)
and 4 are for CP^2 Internal Symmetry Space of $M_4 \times CP^2$ Kaluza-Klein.

The remaining $26-16-4 = 6$ dimensions are the Conformal Physical Spacetime with $Spin(2,4) = SU(2,2)$ symmetry that produces M_4 Minkowski Physical Spacetime.

Joseph Polchinski, in his books String Theory vols. I and II(Cambridge 1998), says: "... the **closed ... unoriented ... bosonic string ... theory** has the maximal 26-dimensional Poincare invariance ... It is possible to have a consistent theory ...[with]... the **dilaton** ... the **[string-]graviton** ...[and]... the **tachyon** ...[whose]... negative mass-squared means that the no-string 'vacuum' is actually unstable ... "

The **dilaton** of Cl(16) Physics sets the Planck scale as the scale for the 16 dimensions that are orbifolded fermion particles and anti-particles and the 4 dimensions of the CP2 Internal Symmetry Space of M4xCP2 spacetime. The remaining $26-16-4 = 6$ dimensions are the Conformal Physical Spacetime with $\text{Spin}(2,4) = \text{SU}(2,2)$ symmetry that produces M4 Physical Spacetime

Cl(16) Physics 26D String Theory Spacetime
10D = 6D Conformal Spacetime + 4D Compact CP2 Internal Symmetry Space
with CP2 = SU(3) / SU(2)xU(1) as unique Compactification
which specifies Gauge Groups of the Standard Model.

If Strings = World Lines and World Lines are past and future histories of particles, then **spin-2 string entities carry Bohm Quantum Potential** with Sarfatti Back-Reaction related to Cramer Transaction Quantum Theory.

Roger Penrose in "Road to Reality" (Knopf 2004) says: "... **quantum** mechanics ... alternates between ... **unitary** evolution **U** ... and state reduction **R** ... quantum state **reduction** ... is ... **objective** ... **OR** ... it is always a gravitational phenomenon ... [A] conscious event ... would be ... orchestrated **OR** ... of ... large-scale quantum coherence ... of ... microtubules ...".

String-Gravity produces Sarfatti-Bohm Quantum Potential with Back-Reaction.

It is distinct from the MacDowell-Mansouri Gravity of stars and planets.

The **tachyon** produces the instability of a truly empty vacuum state with no strings. It is natural, because if our Universe were ever to be in a state with no strings, then tachyons would create strings = World Lines thus filling our Universe with the particles and World-Lines = strings that we see. Something like this is necessary for particle creation in the Inflationary Era of non-unitary Octonionic processes.

Our construction of a 26D String Theory consistent with Cl(16) Physics uses a structure that is not well-known, so I will mention it here before we start:

There are 7 independent E8 lattices, each corresponding to one of the 7 imaginary octonions denoted by iE8, jE8, kE8, EE8, IE8, JE8, and KE8 and related to both D8 adjoint and half-spinor parts of E8 and with 240 first-shell vertices. An 8th E8 lattice 1E8 with 240 first-shell vertices related to the D8 adjoint part of E8 is related to the 7 octonion imaginary lattices (viXra 1301.0150v2) .

It can act as an effectively independent lattice as part of the basis subsets {1E8,EE8} or {1E8,iE8,jE8,kE8}.

With that in mind, here is the construction:

Step 1:

Consider the 26 Dimensions of Bosonic String Theory as the 26-dimensional traceless part $J_3(O)_o$

$$\begin{array}{ccc} a & O_+ & O_v \\ O_+^* & b & O_- \\ O_v^* & O_-^* & -a-b \end{array}$$

(where O_v , O_+ , and O_- are in Octonion space with basis $\{1, i, j, k, E, I, J, K\}$ and a and b are real numbers with basis $\{1\}$) of the 27-dimensional Jordan algebra $J_3(O)$ of 3×3 Hermitian Octonion matrices.

Step 2:

Take a D3 brane to correspond to the Imaginary Quaternionic associative subspace spanned by $\{i, j, k\}$ in the 8-dimensional Octonionic O_v space.

Step 3:

Compactify the 4-dimensional co-associative subspace spanned by $\{E, I, J, K\}$ in the Octonionic O_v space as a $CP^2 = SU(3)/U(2)$, with its 4 world-brane scalars corresponding to the 4 covariant components of a Higgs scalar. Add this subspace to D3, to get D7.

Step 4:

Orbifold the 1-dimensional Real subspace spanned by $\{1\}$ in the Octonionic O_v space by the discrete multiplicative group $Z_2 = \{-1, +1\}$, with its fixed points $\{-1, +1\}$ corresponding to past and future time. This discretizes time steps and gets rid of the world-brane scalar corresponding to the subspace spanned by $\{1\}$ in O_v . It also gives our brane a 2-level timelike structure, so that its past can connect to the future of a preceding brane and its future can connect to the past of a succeeding brane.

Add this subspace to D7, to get D8.

D8, our basic Brane, looks like two layers (past and future) of D7s.

Beyond D8 our String Theory has $26 - 8 = 18$ dimensions, of which $25 - 8$ have corresponding world-brane scalars:

8 world-brane scalars for Octonionic O_+ space;

8 world-brane scalars for Octonionic O_- space;

1 world-brane scalars for real a space; and

1 dimension, for real b space, in which the D8 branes containing spacelike D3s are stacked in timelike order.

Step 5:

To get rid of the world-brane scalars corresponding to the Octonionic O_+ space, orbifold it by the 16-element discrete multiplicative group

$$\text{Oct16} = \{+/-1, +/-i, +/-j, +/-k, +/-E, +/-I, +/-J, +/-K\}$$

to reduce O_+ to 16 singular points $\{-1, -i, -j, -k, -E, -I, -J, -K, +1, +i, +j, +k, +E, +I, +J, +K\}$.

Let the 8 O_+ singular points $\{-1, -i, -j, -k, -E, -I, -J, -K\}$ correspond to the fundamental fermion particles
{neutrino, red up quark, green up quark, blue up quark,
electron, red down quark, green down quark, blue down quark}
located on the past D7 layer of D8.

Let the 8 O_+ singular points $\{+1, +i, +j, +k, +E, +I, +J, +K\}$ correspond to the fundamental fermion particles
{neutrino, red up quark, green up quark, blue up quark,
electron, red down quark, green down quark, blue down quark}
located on the future D7 layer of D8.

The 8 components of the 8 fundamental first-generation fermion particles = $8 \times 8 = 64$ correspond to the 64 of the 128-dim half-spinor D8 part of E8.

This gets rid of the 8 world-brane scalars corresponding to O_+ , and leaves:

8 world-brane scalars for Octonionic O_- space;

1 world-brane scalars for real a space; and

1 dimension, for real b space, in which the D8 branes containing spacelike D3s are stacked in timelike order.

Step 6:

To get rid of the world-brane scalars corresponding to the Octonionic O_- space, orbifold it by the 16-element discrete multiplicative group

$$\text{Oct16} = \{+/-1, +/-i, +/-j, +/-k, +/-E, +/-I, +/-J, +/-K\}$$

to reduce O_- to 16 singular points $\{-1, -i, -j, -k, -E, -I, -J, -K, +1, +i, +j, +k, +E, +I, +J, +K\}$.

Let the 8 O_- singular points $\{-1, -i, -j, -k, -E, -I, -J, -K\}$ correspond to the fundamental fermion anti-particles {anti-neutrino, red up anti-quark, green up anti-quark, blue up anti-quark, positron, red down anti-quark, green down anti-quark, blue down anti-quark}
located on the past D7 layer of D8.

Let the 8 O_- singular points $\{+1, +i, +j, +k, +E, +I, +J, +K\}$ correspond to the fundamental fermion anti-particles {anti-neutrino, red up anti-quark, green up anti-quark, blue up anti-quark, positron, red down anti-quark, green down anti-quark, blue down anti-quark}
located on the future D7 layer of D8.

The 8 components of 8 fundamental first-generation fermion anti-particles = $8 \times 8 = 64$ correspond to the 64 of the 128-dim half-spinor D8 part of E8.

This gets rid of the 8 world-brane scalars corresponding to O_- , and leaves:

1 world-brane scalars for real a space; and

1 dimension, for real b space, in which the D8 branes containing spacelike D3s are stacked in timelike order.

Step 7:

Let the 1 world-brane scalar for real a space correspond to a Bohm-type Quantum Potential acting on strings in the stack of D8 branes.
Interpret strings as world-lines in the Many-Worlds, short strings representing virtual particles and loops.

Step 8:

Fundamentally, physics is described on HyperDiamond Lattice structures. There are 7 independent E8 lattices, each corresponding to one of the 7 imaginary octonions. denoted by $iE8$, $jE8$, $kE8$, $EE8$, $IE8$, $JE8$, and $KE8$ and related to both D8 adjoint and half-spinor parts of E8 and with 240 first-shell vertices. An 8th 8-dim lattice $1E8$ with 240 first-shell vertices related to the E8 adjoint part of E8 is related to the 7 octonion imaginary lattices. Give each D8 brane structure based on Planck-scale E8 lattices so that each D8 brane is a superposition/intersection/coincidence of the eight E8 lattices. (see viXra 1301.0150)

Step 9:

Since Polchinski says "... If r D-branes coincide ... there are r^2 vectors, forming the adjoint of a $U(r)$ gauge group ...", make the following assignments:

a gauge boson emanating from D8 from its $1E8$ and $EE8$ lattices is a $U(2)$ ElectroWeak boson thus accounting for the photon and $W+$, $W-$ and $Z0$ bosons.

a gauge boson emanating from D8 from its $IE8$, $JE8$, and $KE8$ lattices is a $U(3)$ Color Gluon boson thus accounting for the 8 Color Force Gluon bosons.

The $4+8 = 12$ bosons of the Standard Model Electroweak and Color forces correspond to 12 of the 28 dimensions of 28-dim $Spin(8)$ that corresponds to one of the 28 of the 120-dim adjoint D8 parts of E8.

a gauge boson emanating from D8 from its $1E8$, $iE8$, $jE8$, and $kE8$ lattices is a $U(2,2)$ boson for conformal $U(2,2) = Spin(2,4) \times U(1)$ MacDowell-Mansouri gravity plus conformal structures consistent with the Higgs mechanism and with observed Dark Energy, Dark Matter, and Ordinary matter.

The 16-dim $U(2,2)$ is a subgroup of 28-dim $Spin(2,6)$ that corresponds to the other 28 of the 120-dim adjoint D8 part of E8.

Step 10:
Since Polchinski says

"... there will also be r^2 massless scalars from the components normal to the D-brane. ... the collective coordinates ... X^u ... for the embedding of n D-branes in spacetime are now enlarged to $n \times n$ matrices.

This 'noncommutative geometry' ...[may be]... an important hint about the nature of spacetime. ...",

make the following assignment:

The 8×8 matrices for the collective coordinates linking a D8 brane to the next D8 brane in the stack are needed to connect the eight E_8 lattices of the D8 brane to the eight E_8 lattices of the next D8 brane in the stack.

The $8 \times 8 = 64$ correspond to the 64 of the 120 adjoint D8 part of E_8 .

We have now accounted for all the scalars
and

have shown that the model has the physics content of the realistic $Cl(16)$ Physics model with Lagrangian structure based on $E_8 = (28 + 28 + 64) + (64 + 64)$

and

AQFT structure based on $Cl(1,25)$ with real Clifford Algebra periodicity and generalized Hyperfinite II₁ von Neumann factor algebra.

26D String Theory structure can also be formulated directly in the Root Vector picture using redundancy in the E8 description of Quantum States:

Fermion components carry 8-dim Spacetime information

so $E8 / D8 = 8 \times 8 + 8 \times 8$ can be reduced to $8+8$

Spacetime position and momentum are redundant

so $D8 / D4 \times D4 = 8 \times 8$ can be reduced to 8

Gauge Bosons and Ghosts are redundant

so $D4 \times D4 = 28+28$ can be reduced to $28 = 16$ for Gravity + 12 for Standard Model

Elimination of Redundancy gives $8+8 + 8 + 28 = 52$ -dim F4 with 48 Root Vectors forming a 24-cell plus its dual

52-dim F4 has 26-dim smallest non-trivial representation which has structure of

$J(3,O)_o$ = traceless part of 27-dim exceptional Jordan Algebra $J(3,O)$ and is

the minimal structure containing the basic information of Cl(16) Physics.

so

Cl(16) Physics Quantum Theory can be formulated in terms of 26-dim $J(3,O)_o$.

The Cl(1,25) E8 AQFT inherits structure from the Cl(1,25) E8 Local Lagrangian

$$\int_{8\text{-dim SpaceTime}} \text{Gauge Gravity} + \text{Standard Model} + \text{Fermion Particle-AntiParticle}$$

whereby World-Lines of Particles are represented by Strings moving in a space whose dimensionality includes $8v = 8$ -dim SpaceTime Dimensions + $8s+$ = 8 Fermion Particle Types + $8s-$ = 8 Fermion AntiParticle Types combined in the traceless part $J(3,O)_o$ of the 3x3 Octonion Hermitian Jordan Algebra

a	$8s+$	$8v$
$8s+^*$	b	$8s-$
$8v^*$	$8s-^*$	-a-b

which has total dimension $8v + 8s+ + 8s- + 2 = 26$ and is the space of a 26D String Theory with Strings seen as World-Lines.

$24 = 8v + 8s+ + 8s-$ of the 26 dimensions of 26D String Theory correspond to $24 \times 8 = 192$ of the 240 E8 Root Vectors by representing the $8v + 8s+ + 8s-$ as superpositions of their respective 8 components

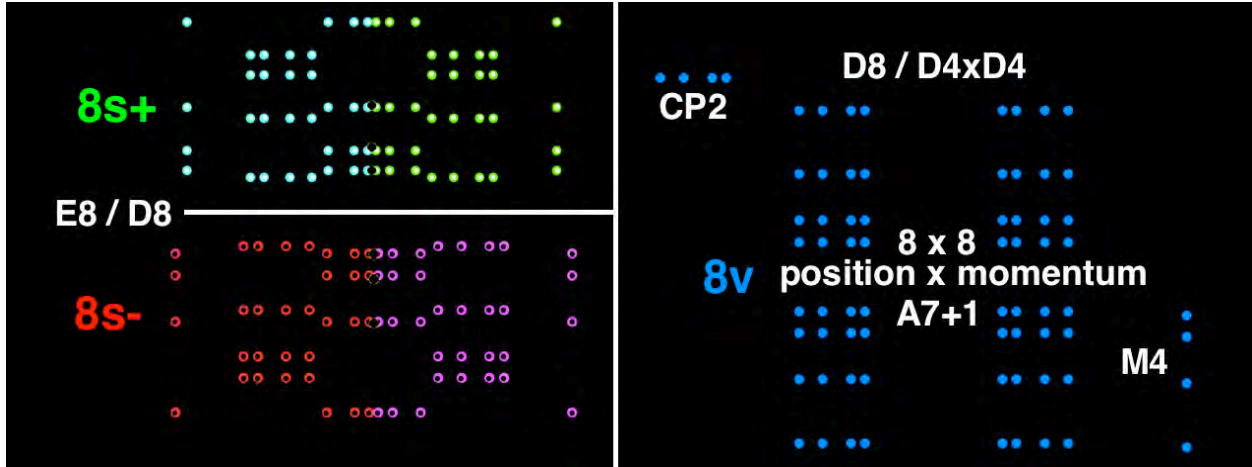

8v SpaceTime is represented by D8 branes. A D8 brane has Planck-Scale Lattice Structure superpositions of 8 types of E8 Lattice denoted by 1E8, iE8, jE8, kE8, EE8, IE8, JE8, KE8



A single Snapshot of SpaceTime is represented by a D8 brane at each point of which is placed Fermion Particles or AntiParticles represented by 8+8 = 16 orbifolded dimensions of the 26 dimensions of 26D String Theory.

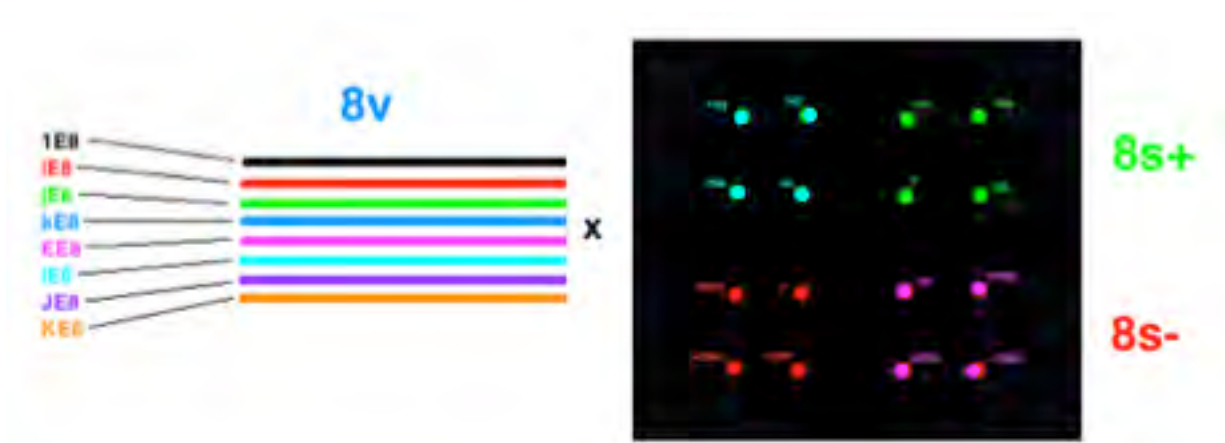

It is necessary to patch together SpaceTime Snapshots to form a Global Structure describing a Many-Worlds Global Algebraic Quantum Field Theory (AQFT) whose structure is described by Deutsch in "The Fabric of Reality" (Penguin 1997 pp. 276-283): "... there is no fundamental demarcation between snapshots of other times and snapshots of other universes ... Other times are just special cases of other universes ... Suppose ... we toss a coin ... Each point in the diagram represents one snapshot ... in the multiverse there are far too many snapshots for clock readings alone to locate a snapshot relative to the others. To do that, we need to consider the intricate detail of which snapshots determine which others. ...

in some regions of the multiverse, and in some places in space, the snapshots of some physical objects do fall, for a period, into chains, each of whose members determines all the others to a good approximation ...".

The Many-Worlds Snapshots are structured as a 26-dim Lorentz Leech Lattice of 26D String Theory parameterized by the a and b of $J(3,0)_0$ as indicated in this 64-element subset of Snapshots

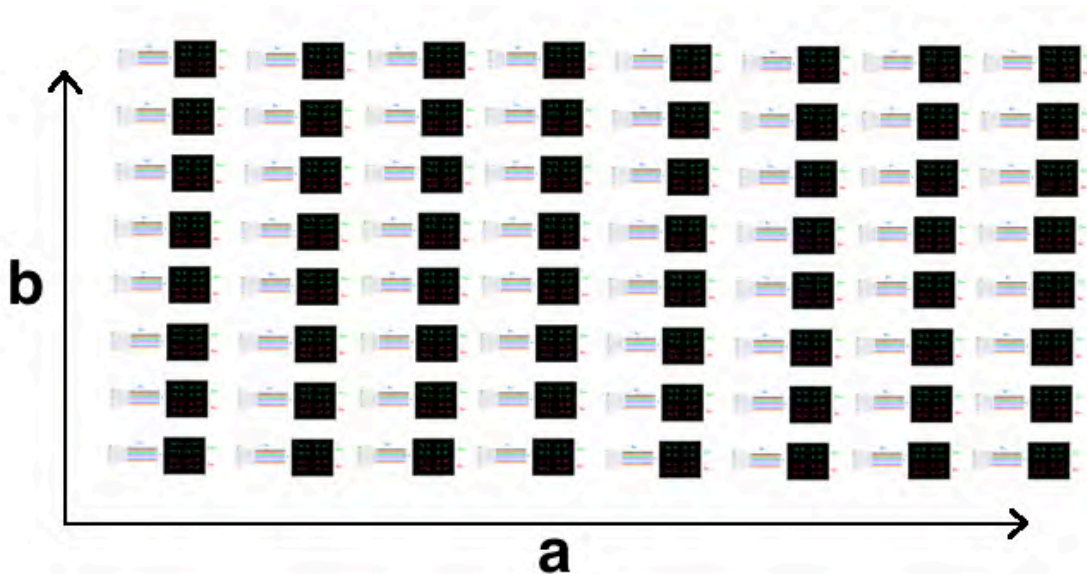

The $240 - 192 = 48 = 24+24$ Root Vector Vertices of E_8 that do not represent the 8-dim D8 brane or the $8+8 = 16$ dim of Orbifolds for Fermions do represent the **Gauge Bosons (and their Ghosts) of $Cl(16)$ Physics:**

Gauge Bosons from $1E_8$, iE_8 , jE_8 , and kE_8 parts of a D8 give **$U(2,2)$ Conformal Gravity**

Gauge Bosons from EE_8 part of a D8 give **$U(2)$ Electroweak Force**

Gauge Bosons from IE_8 , JE_8 , and KE_8 parts of a D8 give **$SU(3)$ Color Force**



Each Deutsch chain of determination represents a World-Line of Particles / AntiParticles corresponding to a String of 26D String Theory such as the red line in this 64-element subset of Snapshots

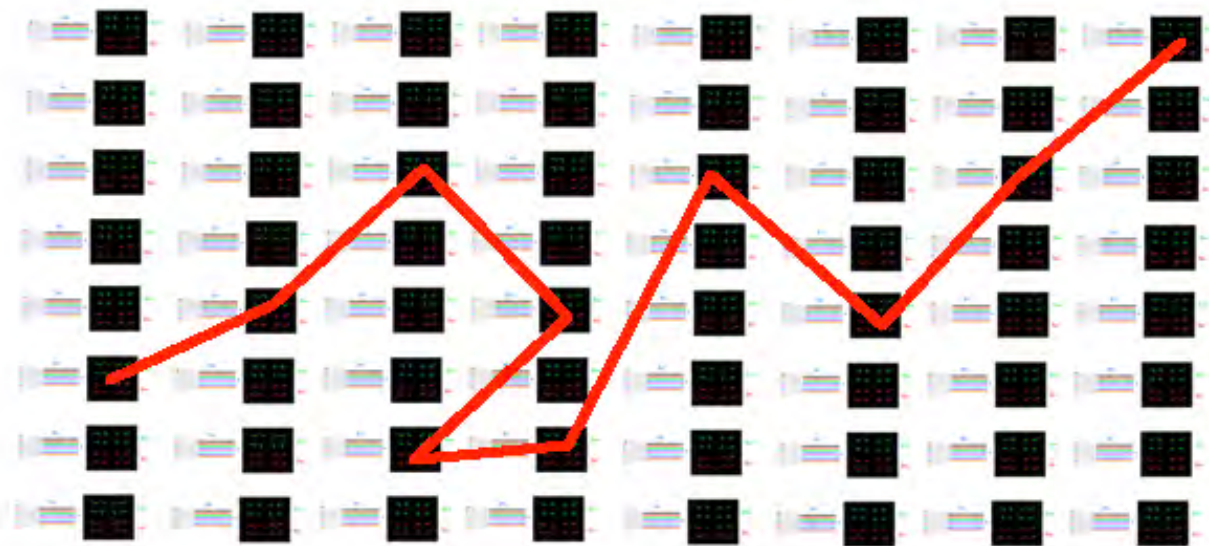

26D String Theory is the Theory of Interactions of Strings = World-Lines.

Interactions of World-Lines can describe Quantum Theory

according to Andrew Gray (arXiv quant-ph/9712037): "... probabilities are ... assigned to entire fine-grained histories ... base[d] ... on the Feynman path integral formulation ...

The formulation is fully relativistic and applicable to multi-particle systems.

It ... makes the same experimental predictions as quantum field theory ...".

Green, Schwarz, and Witten say in their book "Superstring Theory" vol. 1 (Cambridge 1986)

"... For the ... closed ... bosonic string [**26D String Theory**] The first excited level ... consists of ... the ground state ... tachyon ... and ... a scalar ... 'dilaton' ... and ...

SO(24) ... little group of a ...[26-dim]... massless particle ... and ...

a ... massless ... spin two state ...".

Closed string tachyons localized at orbifolds of fermions produce virtual clouds of particles / antiparticles that dress fermions.

Dilatons are Goldstone bosons of spontaneously broken scale invariance that (analogous to Higgs) go from mediating a long-range scalar gravity-type force to the nonlocality of the Bohm-Sarfatti Quantum Potential.

The SO(24) little group is related to the Monster automorphism group that is the symmetry of each cell of Planck-scale local lattice structure.

The massless spin 2 state = Bohmion = Carrier of the Bohm Force of the Bohm Quantum Potential.

The Creation-Annihilation Operator structure of the Bohm Quantum Potential of 26D String Theory is given by the

Maximal Contraction of E_8 = semidirect product $A_7 \times h_{92}$
 where $h_{92} = 92+1+92 = 185$ -dim Heisenberg algebra and $A_7 = 63$ -dim $SL(8)$

The Maximal E_8 Contraction $A_7 \times h_{92}$ can be written as a 5-Graded Lie Algebra

$$28 + 64 + (SL(8,R) + 1) + 64 + 28$$

$$\text{Central Even Grade } 0 = SL(8,R) + 1$$

The 1 is a scalar and $SL(8,R) = Spin(8) + \text{Traceless Symmetric } 8 \times 8 \text{ Matrices}$,
 so $SL(8,R)$ represents a local 8-dim SpaceTime in Polar Coordinates.

$$\text{Odd Grades } -1 \text{ and } +1 = 64 + 64$$

Each = $64 = 8 \times 8 = \text{Creation/Annihilation Operators for 8 components of 8 Fundamental Fermions}$.

$$\text{Even Grades } -2 \text{ and } +2 = 28 + 28$$

Each = Creation/Annihilation Operators for 28 Gauge Bosons of Gravity + Standard Model.

The 8×8 matrices linking one D_8 to the next D_8 of a World-Line String
 give $A_7 \times R = U(8)$ representing **Position x Momentum**

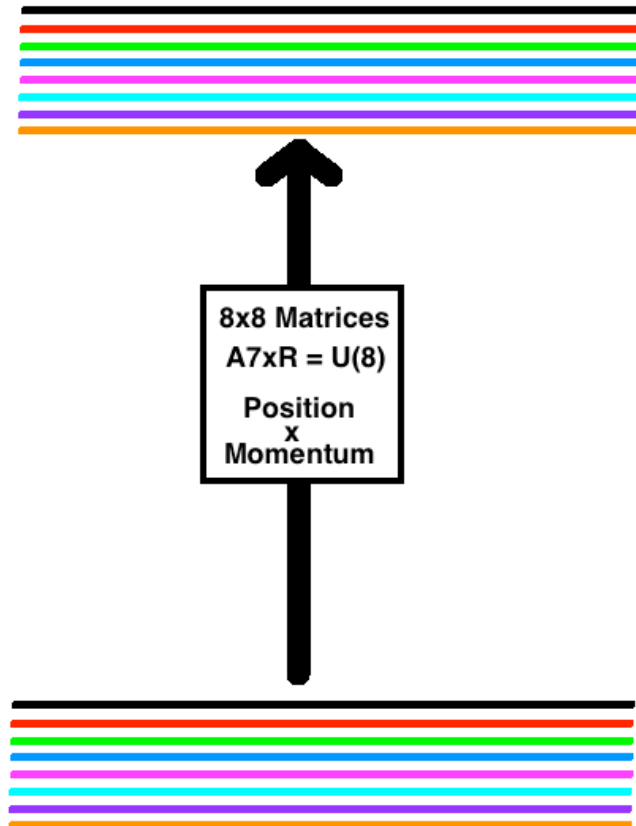

Roderick Sutherland (arXiv 1509.02442) gave a Lagrangian for the Bohm Potential saying: "... This paper focuses on interpretations of QM in which the underlying reality is taken to consist of particles have definite trajectories at all times ... An example ... is the Bohm model ... This paper ... provid[es]... a Lagrangian ...[for]... the unfolding events describing more than one particle while maintaining a relativistic description requires the introduction of final boundary conditions as well as initial, thereby entailing retrocausality ...

In addition ... the Lagrangian approach pursued here to describe particle trajectories also entails the natural inclusion of an accompanying field to influence the particle's motion away from classical mechanics and reproduce the correct quantum predictions. In so doing, it is ... providing a physical explanation for why quantum phenomena exist at all ... the particle is seen to be

the source of a field which alters the particle's trajectory via self-interaction ...

The Dirac case ... each particle in an entangled many-particle state will be described by an individual Lagrangian density ... of the form:

$$\mathcal{L} = \text{Re} \left[\frac{1}{\langle f|i \rangle} \left(-i\bar{\Psi}_f \gamma^\alpha \partial_\alpha \Psi_i + m\bar{\Psi}_f \Psi_i \right) \right] \mp \sigma_0 \rho_0 \left| \mathbf{u}_\alpha \mathbf{u}^\alpha \right|^{1/2} + \sigma_0 \mathbf{u}_\alpha \mathbf{j}^\alpha$$

... the ...[first]... term ...[is]... the ... Lagrangian densities for the PSI field alone ...

... sigma_o is the rest density distribution of the particle through space ... j is the current density ...

... rho_o and u are the rest density and 4-velocity of the probability flow ...".

Jack Sarfatti extended the Sutherland Lagrangian to include Back-Reaction entanglement.

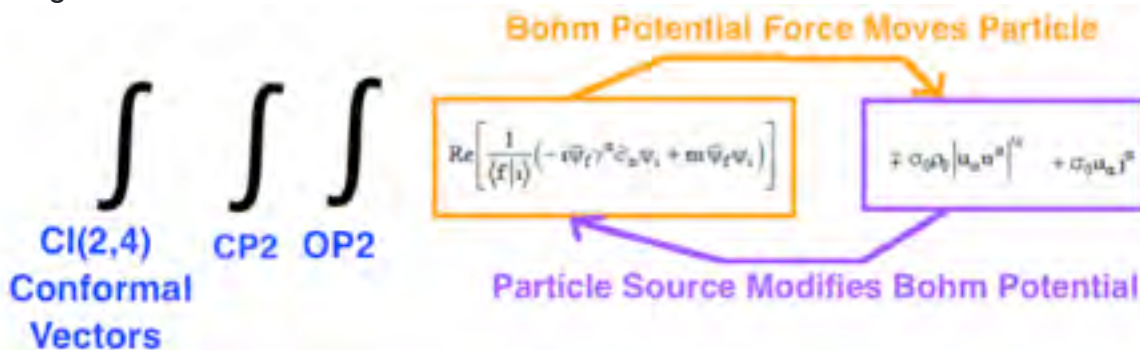

where a, b and VM4 form CI(2,4) vectors and VCP2 forms CP2 and S+ and S- form OP2 so that

26D = 16D orbifolded fermions + 10D and 10D = 6D Conformal Space + 4D CP2 ISS (ISS = Internal Symmetry Space and 6D Conformal contains 4D M4 of Kaluza-Klein M4xCP2)

saying (linkedin.com Pulse 13 January 2016): "... the reason entanglement cannot be used as a direct messaging channel between subsystems of an entangled complex quantum system, is the lack of direct back-reaction of the classical particles and classical local gauge fields on their shared entangled Bohmian quantum information pilot wave ... Roderick. I. Sutherland ... using Lagrangian field theory, shows how to make the original 1952 Bohm pilot-wave theory completely relativistic,

and how to avoid the need for configuration space for many-particle entanglement.

The trick is that final boundary conditions on the action

as well as initial boundary conditions influence what happens in the present.

The general theory is "post-quantum" ... and it is non-statistical ...

There is complete two-way action-reaction between quantum pilot waves

and the classical particles and classical local gauge fields ...

orthodox statistical quantum theory, with no-signaling ...[is derived]... in two steps,

first arbitrarily set the back-reaction (of particles and classical gauge field on their pilot

waves) to zero. This is analogous to setting the curvature equal to zero in general

relativity, or more precisely in setting G to zero.

Second, integrate out the final boundary information, thereby adding the statistical Born

rule to the mix. ...

the mathematical condition for zero post-quantum back-reaction of particles and

classical fields (aka "beables" J.S. Bell's term) is exactly de Broglie's guidance

constraint. That is, in the simplest case, the classical particle velocity is proportional to

the gradient of the phase of the quantum pilot wave. It is for this reason, that the

independent existence of the classical beables can be ignored in most quantum

calculations.

However, orthodox quantum theory assumes that the quantum system is

thermodynamically closed between strong von Neumann projection measurements that

obey the Born probability rule.

The new post-quantum theory in the equations of Sutherland, prior to taking the limit of

orthodox quantum theory, should apply to pumped open dissipative structures. Living

matter is the prime example. This is a clue that should not be ignored. ...".

Jack Sarfatti (email 31 January 2016) said: "... Sabine [Hossenfelder]'s argument ...

"... two types of fundamental laws ... appear in contemporary theories.

One type is deterministic, which means that the past entirely predicts the future.

There is no free will in such a fundamental law because there is no freedom.

The other type of law we know appears in quantum mechanics and has an

indeterministic component which is random. This randomness cannot be influenced by

anything, and in particular it cannot be influenced by you, whatever you think "you" are.

There is no free will in such a fundamental law because there is no "will" - there is just

some randomness sprinkled over the determinism.

In neither case do you have free will in any meaningful way."

... However ...[There is a Third Way]...

post-quantum theory with action-reaction between

quantum information pilot wave and its be-able is compatible with free will. ...".

Cl(1,25) AQFT

The 560 TriVectors of Cl(16) are 10 copies of $56 = \text{Fr}_3(\mathbb{O})$

$\text{Fr}_3(\mathbb{O})$ is Complexification of $\text{J}_3(\mathbb{O})$

$\mathbb{V} = \text{Fr}_3(\mathbb{O})$ Spacetime is a Superposition of 8 E8 8-dim Spacetime Lattices
(7 being Integral Domains)

Each Fermion Type propagates within its own E8 Lattice within the Superposition which accounts for 8 of the 10 copies of $\text{Fr}_3(\mathbb{O})$

The other 2 copies of $\text{Fr}_3(\mathbb{O})$ correspond to the 2 diagonal elements d and f which describe the 10-dim $\text{R}(1,9)$ space that is Conformal over 8-dim $\text{R}(0,8)$ space which has Clifford Algebra $\text{Cl}(0,8) = \text{Cl}(1,7)$ of $\text{RP}^1 \times \text{S}^7$

The two copies of $\text{J}_3(\mathbb{O})$ within each $\text{Fr}_3(\mathbb{O})$ correspond to Real and Imaginary 26D String Theories where

the Real Part represents the Shilov Boundary
of the Bulk Complex Bounded Domain.

The Clifford Algebra of 26D String Theory is $\text{Cl}(1,25)$

$\text{Cl}(1,25) = \text{M}(2, \text{Cl}(0,24)) = 2 \times 2$ matrices with entries in $\text{Cl}(0,24) =$
 $=$ Conformal Structure over $\text{Cl}(0,24)$

$\text{Cl}(0,24) = \text{Cl}(0,8) \times \text{Cl}(0,16)$

$\text{Cl}(0,16)$ has 16-dim Barnes-Wall Lattice Structure

$\text{Cl}(0,8)$ has 8-dim E8 Lattice Structure

so

$\text{Cl}(0,24)$ has 24-dim Leech Lattice Structure

and

$\text{Cl}(1,25) = \text{M}(2, \text{Cl}(0,24))$ has Lorentz Leech Lattice Structure
with Monster Group Symmetry of each Lattice Cell

Since all matrix entries are $\text{Cl}(0,24) =$ tensor product of 3 copies of $\text{Cl}(0,8)$
8-Periodicity allows formation of the tensor products of copies of $\text{Cl}(1,25)$

One $Cl(1,25)$ containing one $Cl(0,16)$ containing one E_8 gives a Lagrangian description of one local spacetime neighborhood.

To get a realistic global spacetime structure, take the tensor product $Cl(1,25) \times \dots \times Cl(1,25)$ with all E_8 local 8-dim Octonionic spacetimes consistently aligned as described by [64-dim \$D_8 / D_4 \times D_4\$](#) (this visualization uses hexagonal 2D projection of the 240 E_8 root vectors)

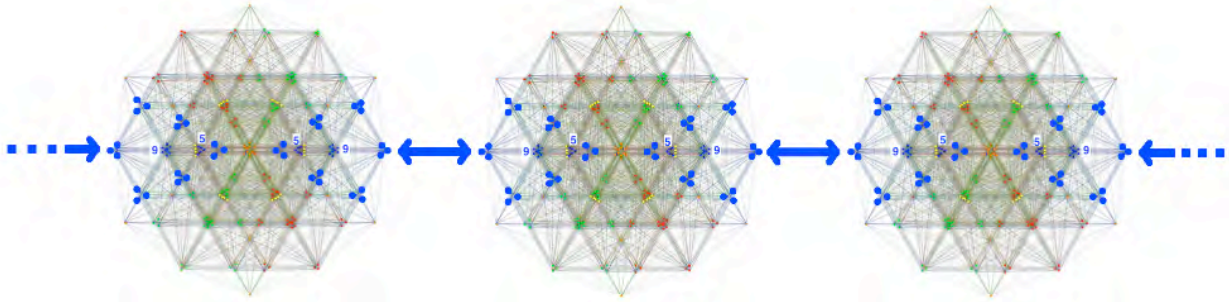

Completion of the Union of all Tensor Products of the form $Cl(1,25) \times \dots$ (N times tensor product) $\dots \times Cl(1,25)$ gives an Algebraic Quantum Field Theory (AQFT)

For $N = 2^8 = 256$ the copies of $Cl(1,25)$ are on the 256 vertices of the 8-dim HyperCube

For $N = 2^{16} = 65,536 = 4^8$ the copies of $Cl(1,25)$ fill in the 8-dim HyperCube as described by William Gilbert's web page: "... The n-bit reflected binary [Gray](#) code will describe a path on the edges of an n- dimensional cube that can be used as the initial stage of a Hilbert curve that will fill an n-dimensional cube. ...".

The vertices of the Hilbert curve are at the centers of the 2^8 sub-8-HyperCubes whose edge lengths are $1/2$ of the edge lengths of the original 8-dim HyperCube

As N grows, the copies of $Cl(1,25)$ continue to fill the 8-dim HyperCube of E_8 SpaceTime using higher Hilbert curve stages from the 8-bit reflected binary Gray code subdividing the initial 8-dim HyperCube into more and more sub-HyperCubes.



If edges of sub-HyperCubes, equal to the distance between adjacent copies of $Cl(1,25)$, remain constantly at the Planck Length, then the full 8-dim HyperCube of our Universe expands as N grows to 2^{16} and beyond similarly to the way shown by this 3-HyperCube example for $N = 2^3, 4^3, 8^3$ from Wiliam Gilbert's web page:



The Algebraic Quantum Field Theory (AQFT) structure of the Bohm Quantum Potential of 26D String Theory is given by the $Cl(16)$ Physics Local Lagrangian

$$\int_{8\text{-dim SpaceTime}} \text{Gauge Gravity} + \text{Standard Model} + \text{Fermion Particle-AntiParticle}$$

and by 8-Periodicity of Real Clifford Algebras,
as the **Completion of the Union of all Tensor Products of the form**

$$Cl(1,25) \times \dots (N \text{ times tensor product}) \dots \times Cl(1,25)$$

which is analogous to Fock Space Hyperfinite II₁ von Neumann factor algebra that is based on 2-Periodicity of Complex Clifford Algebras.

For $N = 2^8 = 256$ the copies of $Cl(1,25)$ are on the 256 vertices of the 8-dim HyperCube



For $N = 2^{16} = 65,536 = 4^8$ the copies of $CI(1,25)$ fill in the 8-dim HyperCube as described by William Gilbert's web page: "... The n-bit reflected binary Gray code will describe a path on the edges of an n-dimensional cube that can be used as the initial stage of a Hilbert curve that will fill an n-dimensional cube. ...".

The vertices of the Hilbert curve are at the centers of the 2^8 sub-8-HyperCubes whose edge lengths are $1/2$ of the edge lengths of the original 8-dim HyperCube

As N grows, the copies of $CI(1,25)$ continue to fill the 8-dim HyperCube of $E8$ SpaceTime

using higher Hilbert curve stages from the 8-bit reflected binary Gray code subdividing the initial 8-dim HyperCube into more and more sub-HyperCubes.

If edges of sub-HyperCubes, equal to the distance between adjacent copies of $CI(1,25)$, remain constantly at the Planck Length, then the

full 8-dim HyperCube of our Universe expands as N grows to 2^{16} and beyond

similarly to the way shown by this 3-HyperCube example for $N = 2^3, 4^3, 8^3$

from William Gilbert's web page:



The Union of all $CI(1,25)$ tensor products is the Union of all subdivided 8-HyperCubes

and

their Completion is a huge superposition of 8-HyperCube Continuous Volumes which Completion belongs to the Third Grothendieck Universe

and
**is an AQFT that is
 a Real Clifford Algebra generalization
 of the Complex Clifford Algebra Fock Space
 Hyperfinite II₁ von Neumann factor Algebra**

26D String Theory Structure is

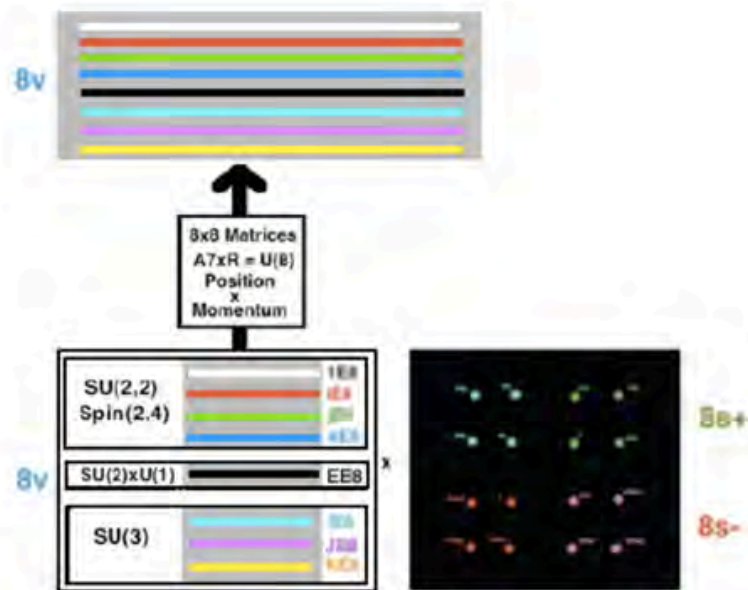

Green, Schwartz, and Witten, in "Superstring Theory" vol. 1, describe 26D String Theory saying "... The first excited level ... consists of ...
 the ground state ... **tachyon** ...
 and ... a scalar ... **'dilaton'** ...
 and ... **SO(24)** ... **little group of a ...[26-dim]... massless particle** ...
 and ... a ... **massless ... spin two state** ...".

Tachyons localized at orbifolds of fermions produce virtual clouds of particles / antiparticles that dress fermions by filling their Schwinger Source regions.

Dilatons are Goldstone bosons of spontaneously broken scale invariance that (analogous to Higgs) go from mediating a long-range scalar gravity-type force to the nonlocality of the Bohm-Sarfatti Quantum Potential.

The SO(24) little group is related to the Monster automorphism group that is the symmetry of each cell of Planck-scale local lattice structure.

**The massless spin 2 state = Bohmion = Carrier of the Bohm Force
of the Bohm Quantum Potential.**

**Similarity of the spin 2 Bohmion to the spin 2 Graviton accounts for
the Bohmion's ability to support Penrose Consciousness
with Superposition Separation Energy Difference $G m^2 / a$**

where, for a Human Brain, m = mass of electron and a = 1 nanometer in Tubulin Dimer

**"... Bohm's Quantum Potential can be viewed as
an internal energy of a quantum system ..."**

according to Dennis, de Gosson, and Hiley (arXiv 1412.5133)

and

**Bohm Quantum Potential inherits Sarfatti Back-Reaction
from its spin-2 structure similar to General Relativity**

Peter R. Holland says in "The Quantum Theory of Motion" (Cambridge 1993):

"... the total force ... from the quantum potential ... does not ... fall off with distance ...
because ... the quantum potential ... depends on the form of ...[the quantum state]...
rather than ... its ... magnitude ...".

**Penrose-Hameroff-type Quantum Consciousness is due
to Resonant Quantum Potential Connections among Quantum State Forms.**

The Quantum State Form of a Conscious Brain is determined by the configuration of a
subset of its 10^{18} to 10^{19} Tubulin Dimers described by a large Real Clifford Algebra.
Paola Zizzi in gr-qc/0007006 describes the Octonionic Inflation Era of Our Universe
as a Quantum Consciousness Superposition of States ending with Self-Decoherence
after 64 doublings of Octonionic Inflation, at which time Our Universe is
"... a superposed state of quantum ... [qubits].

the self-reduction of the superposed quantum state is ... reached at the end of
inflation ...[at]... the decoherence time ... [$T_{\text{decoh}} = 10^9 T_{\text{planck}} = 10^{(-34)}$ sec] ...
and corresponds to a superposed state of ... [$10^{19} = 2^{64}$ qubits]. ...".

64 doublings to 2^{64} qubits corresponds to the Clifford algebra

$$Cl(64) = Cl(8 \times 8) = Cl(8) \times Cl(8) \times Cl(8) \times Cl(8) \times Cl(8) \times Cl(8) \times Cl(8) \times Cl(8)$$

By the periodicity-8 theorem of Real Clifford algebras, $Cl(64)$ is the smallest Real
Clifford algebra for which we can reflexively identify each component $Cl(8)$
with a basis vector in the $Cl(8)$ vector space.

This reflexive identification causes our universe to decohere at $N = 2^{64} = 10^{19}$.
Octonionic Quantum Processes are Not Unitary and so can produce Fermions.

(see Stephen Adler's book "Quaternionic Quantum Mechanics ..." at pages 50-52 and 561).

At the end of 64 Unfoldings, Non-Unitary Octonionic Inflation ended having
produced about $(1/2) 16^{64} = (1/2) (2^4)^{64} = 2^{255} = 6 \times 10^{76}$ Fermions.

At the End of Inflation Our Universe had Temperature / Energy 10^{27} K = 10^{14} GeV
so each of the 10^{77} Fermions had energy of 10^{14} GeV and collisions among them
would for each of the 10^{77} Fermions produce jets containing about 10^{12} particles of
energy 100 GeV or so so that the total number created by Inflation was about 10^{89} .

The End of Inflation time was at about $10^{(-34)}$ sec = $2^{64} T_{\text{planck}}$

and
the size of our Universe was then about $10^{(-24)}$ cm
which is about the size of a Fermion Schwinger Source Kerr-Newman Cloud.
The 2^{64} qubits created by Inflation is roughly 10^{19} which is roughly
the number of Quantum Consciousness Tubulins in the Human Brain.
Therefore

**the Human Brain Quantum Consciousness has evolved in Our Universe
to be roughly equivalent
to the Maximum Consciousness of Our Inflationary Era Universe.**

Further,
each cell of E8 Lagrangian Spacetime corresponds to 65,536-dim $Cl(16)$
which contains 248-dim $E_8 = 120$ -dim D8 bivectors +128-dim D8 half-spinors
Human Brain Microtubules 40 microns long have 65,536 Tubulin Dimers

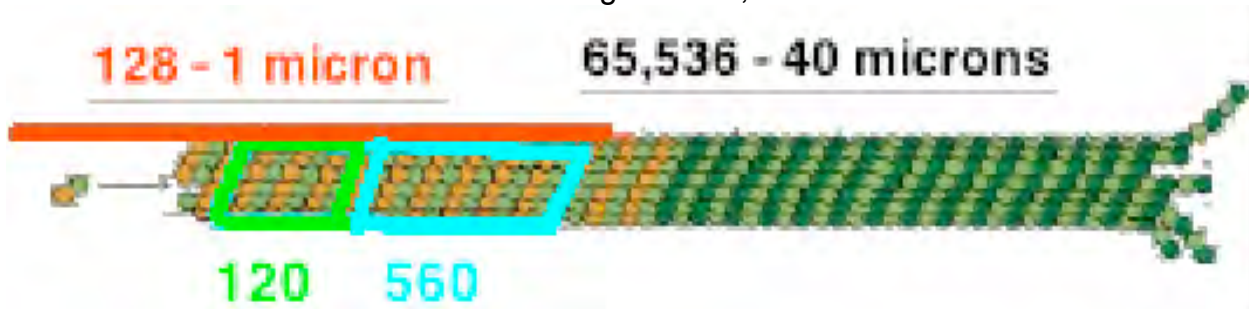

(image adapted from 12biophys.blogspot.com Lecture 11)

and so
can have Bohm Quantum Resonance with $Cl(16)$ Spacetime cells
so that at any and all Times
the State of Consciousness of a Human is in exact resonant correspondence with
a subset of the cells of E8 Classical Lagrangian Spacetime
Therefore

**E8 Lagrangian Spacetime (as a Nambu-Jona-Lasinio Condensate)
is effectively the Spirit World**

in which the Human States of Consciousness = Souls exist.

After the death of the Human Physical Body the Spirit World interactions with its Soul
are no longer constrained by Physical World interactions with its Body so that
the Spirit World can harmonize the individual Soul with the collective Universal Soul.

**A Single Cell of E8 26-dimensional Bosonic String Theory,
in which Strings are physically interpreted as World-Lines,
can be described by taking the quotient of its 24-dimensional O_+ , O_- , O_v
subspace modulo the 24-dimensional Leech lattice.
Its automorphism group is the largest finite sporadic group, the Monster Group,
whose order is
8080, 17424, 79451, 28758, 86459, 90496, 17107, 57005, 75436, 80000, 00000 =
= $2^{46} \cdot 3^{20} \cdot 5^9 \cdot 7^6 \cdot 11^2 \cdot 13^3 \cdot 17 \cdot 19 \cdot 23 \cdot 29 \cdot 31 \cdot 41 \cdot 47 \cdot 59 \cdot 71$
or about 8×10^{53} .**

“... Bohm’s Quantum Potential can be viewed as an internal energy of a quantum system ...” according to Dennis, de Gosson, and Hiley (arXiv 1412.5133) and Peter R. Holland says in "The Quantum Theory of Motion" (Cambridge 1993): "... the total force ... from the quantum potential ... does not ... fall off with distance ... because ... the quantum potential ... depends on the form of ...[the quantum state]... rather than ... its ... magnitude ...".

Penrose-Hameroff-type Quantum Consciousness is due to Resonant Quantum Potential Connections among Quantum State Forms.

The Quantum State Form of a Conscious Brain is determined by the configuration of a subset of its 10^{18} to 10^{19} Tubulin Dimers with math description in terms of a large Real Clifford Algebra:

Resonance is discussed by Carver Mead in “Collective Electrodynamics“ (MIT 2000): "... we can build ... a resonator from ... electric dipole ... configuration[s] ...



[such as Tubulin Dimers]

Because there are charges at the two ends of the dipole, we can have a contribution to the electric coupling from the scalar potential ... as well [as] from the magnetic coupling ... from the vector potential ... electric dipole coupling is stronger than magnetic dipole coupling ... the coupling of ... two ... configurations ... is the same, whether retarded or advanced potentials are used. Any ... configuration ... couples to any other on its light cone, whether past or future. ... The total phase accumulation in a ... configuration ... is the sum of that due to its own current, and that due to currents in other ... configurations ... far away ...

The energy in a single resonator alternates between the kinetic energy of the electrons (inductance), and the potential energy of the electrons (capacitance). With the two resonators coupled, the energy shifts back and forth between the two resonators in such a way that the total energy is constant ... The conservation of energy holds despite an arbitrary separation between the resonators ... Instead of scaling linearly with the number of charges that take part in the motion, the momentum of a collective system scales as the square of the number of charges! ... The inertia of a collective system, however, is a manifestation of the interaction, and cannot be assigned to the elements separately. ... Thus, it is clear that collective quantum systems do not have a classical correspondence limit. ...”.

For the 10^{18} Tubulin Dimers of the human brain,
the resonant frequencies are the same and exchanges of energy among them act to keep them **locked in a Quantum Protectorate collective coherent state.**

Philip W. Anderson in cond-mat/0007287 and cond-mat/007185 said:

"... Laughlin and Pines have introduced the term "Quantum protectorate" as a general descriptor of the fact that certain states of quantum many-body systems exhibit properties which are unaffected by imperfections, impurities and thermal fluctuations. They instance ... flux quantization in superconductors, equivalent to the Josephson frequency relation which again has mensuration accuracy and is independent of

imperfections and scattering. ...

... the source of quantum protection is a collective state of the quantum field involved such that the individual particles are sufficiently tightly coupled that elementary excitations no longer involve a few particles but are collective excitations of the whole system, and therefore, macroscopic behavior is mostly determined by overall conservation laws ... a "quantum protectorate" ...[is]... a state in which the manybody correlations are so strong that the dynamics can no longer be described in terms of individual particles, and therefore perturbations which scatter individual particles are not effective ...”.

Mershin, Sanabria, Miller, Nawarathna, Skoulakis, Mavromatos, Kolomenskii, Scheussler, Ludena, and Nanopoulos in physics/0505080 “Towards Experimental Tests of Quantum Effects in Cytoskeletal Proteins” said:



Classically, the various dimers can only be in the ...[those]... conformations. Each dimer is influenced by the neighboring dimers resulting in the possibility of a transition. This is the basis for classical information processing, which constitutes the picture of a (classical) cellular automaton.

If we assume ... that each dimer can find itself in a QM superposition of ...[those]... states, a quantum nature results. Tubulin can then be viewed as a typical two-state quantum mechanical system, where the dimers couple to conformational changes with $10^{(-9)} - 10^{(-11)}$ sec transitions, corresponding to an angular frequency $\sim 10^{10} - 10^{12}$ Hz. In this approximation, the upper bound of this frequency range is assumed to represent (in order of magnitude) the characteristic frequency of the dimers, viewed as a two-state quantum-mechanical system ...[

The Energy Gap of our Universe as superconductor condensate spacetime is from $3 \times 10^{(-18)}$ Hz (radius of universe) to 3×10^{43} Hz (Planck length). Its RMS amplitude is 10^{13} Hz = 10 THz = energy of neutrino masses = critical temperature T_c of BSCCO superconducting crystal Josephson Junctions]... large-scale quantum coherence ...[has been observed]... at temperatures within a factor of three of biological temperatures. MRI magnets contain hundreds of miles of superconducting wire and routinely carry a persistent current. There is no distance limit - the macroscopic wave function of the superfluid condensate of electron pairs, or Cooper pairs, in a sufficiently long cable could maintain its quantum phase coherence for many thousands of miles ... there is no limit to the total mass of the electrons participating in the superfluid state. The condensate is “protected” from thermal fluctuations by the BCS energy gap at the Fermi surface ... The term “quantum protectorate” ... describe[s] this and related many-body systems ...”.

The Human Brain has about 10^{11} Neuron cells, each about 1,000 nm in size.
 The cytoskeleton of cells, including neurons of the brain, is made up of Microtubules

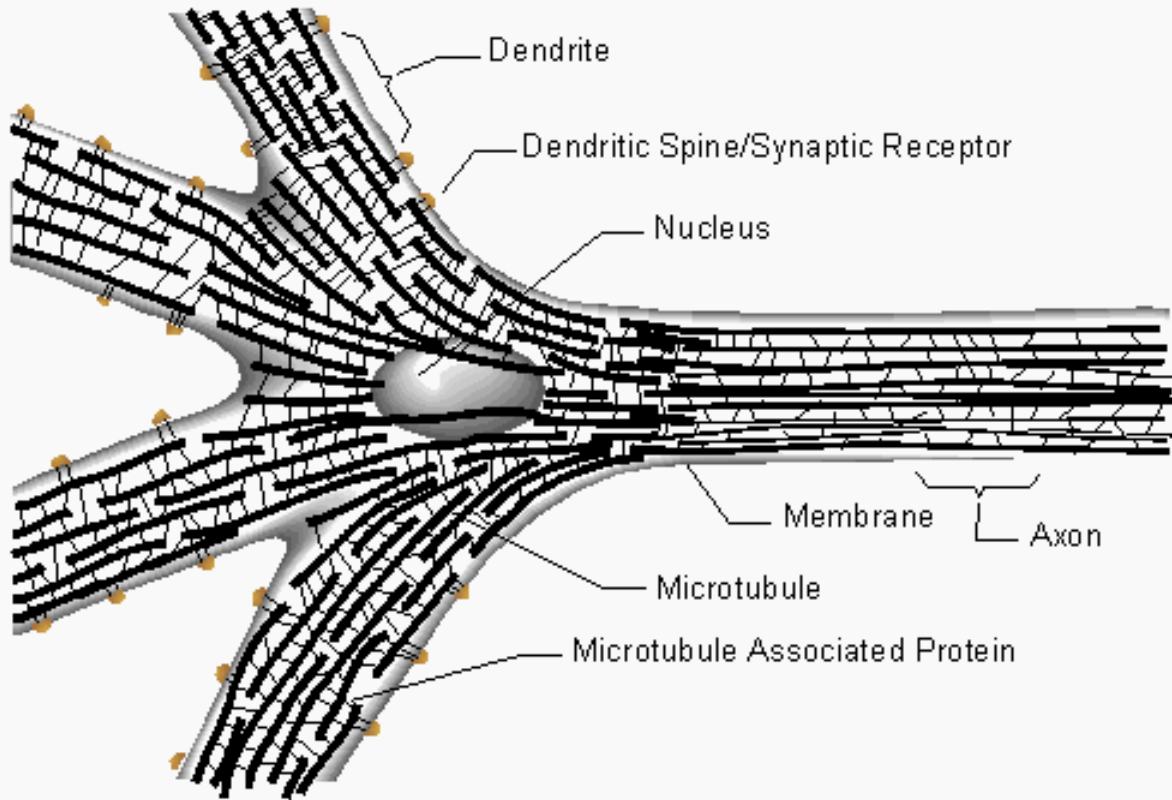

(image from "Orchestrated Objective Reduction of Quantum Coherence in Brain Microtubules: The "Orch OR" Model for Consciousness" by Penrose and Hameroff)

Each Neuron contains about 10^9 Tubulin Dimers, organized into Microtubules some of which are organized by a Centrosome. Centrosomes contain a pair of Centrioles.

A Centriole is about 200 nm wide and 400 nm long. Its wall is made up of 9 groups of 3 Microtubules, reflecting the symmetry of 27-dim $J(3,0)$

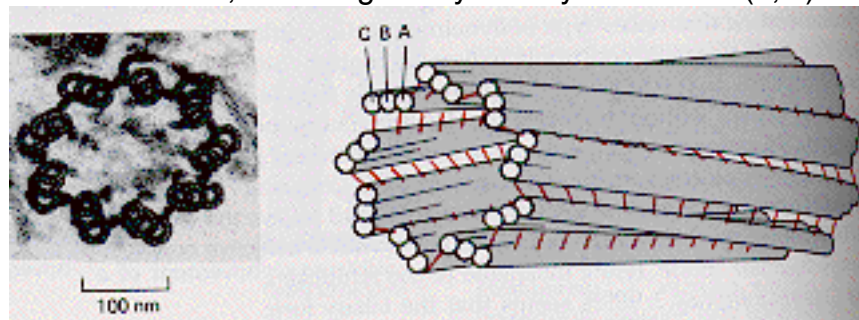

Each Microtubule is a hollow cylindrical tube with about 25 nm outside diameter and 14 nm inside diameter, made up of 13 columns of Tubulin Dimers

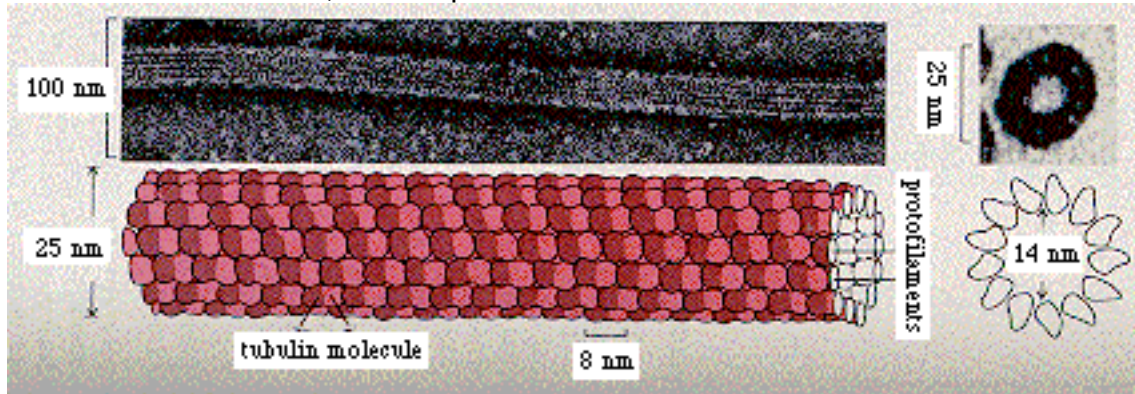

(illustrations and information about cells, microtubules, and centrioles are from Molecular Biology of the Cell, 2nd ed, by Alberts, Bray, Lewis, Raff, Roberts, and Watson (Garland 1989))

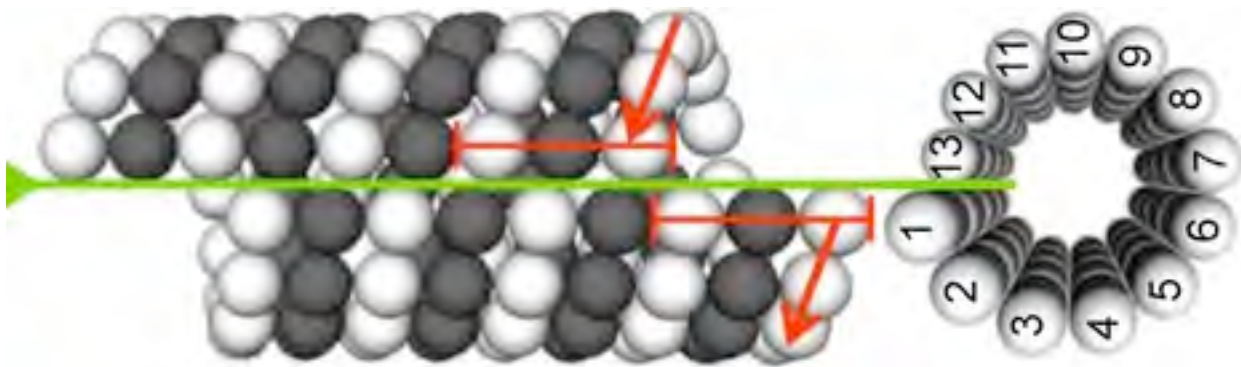

(image from Wikipedia on Microtubule)

Each Tubulin Dimer is about 8 nm x 4 nm x 4 nm, consists of two parts, alpha-tubulin and beta-tubulin (each made up of about 450 Amino Acids, each containing roughly 20 Atoms)
 A Microtubule 40 microns = 40,000 nm long contains $13 \times 40,000 / 8 = 65,000$ Dimers



(images adapted from nonlocal.com/hbar/microtubules.html by Rhett Savage)

The black dots indicate the position of the Conformation Electrons.

There are two energetically distinct configurations for the Tubulin Dimers:

Conformation Electrons Similarly Aligned (left image) - State 0

Conformation Electrons Maximally Separated (right image) - State 1

The two structures - State 0 ground state and State 1 higher energy state - make Tubulin Dimers the basis for a Microtubule binary math / code system.

**Microtubule binary math / code system corresponds
to Clifford Algebras $Cl(8)$ and $Cl(8) \times Cl(8) = Cl(16)$
containing 16-dim V_{16} (magenta) and
120 (inside purple outline) + 128-dim (yellow green red) = 248-dim E_8 and
560 (inside black outline) 10 copies of 56-dim $Fr_3(O)$:**

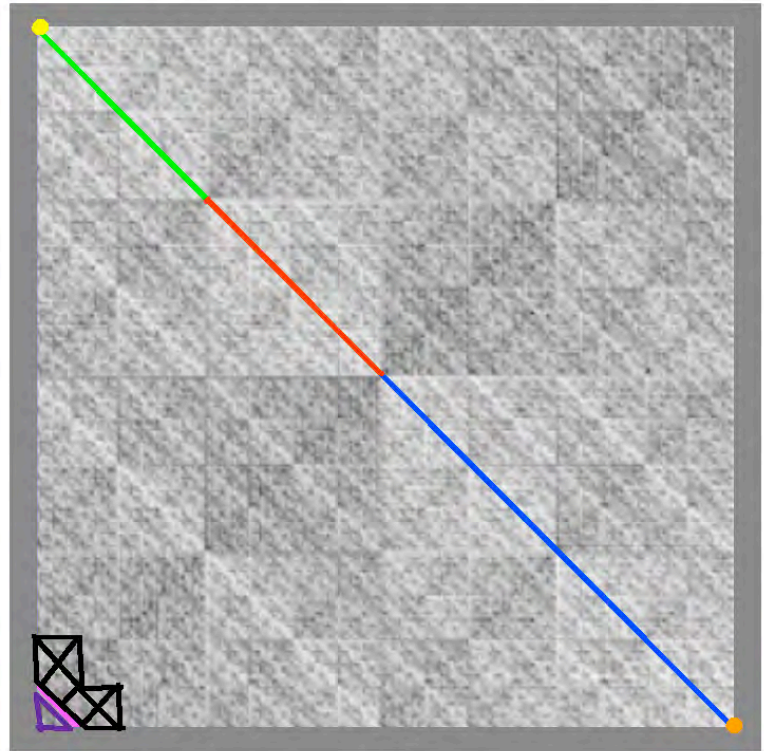
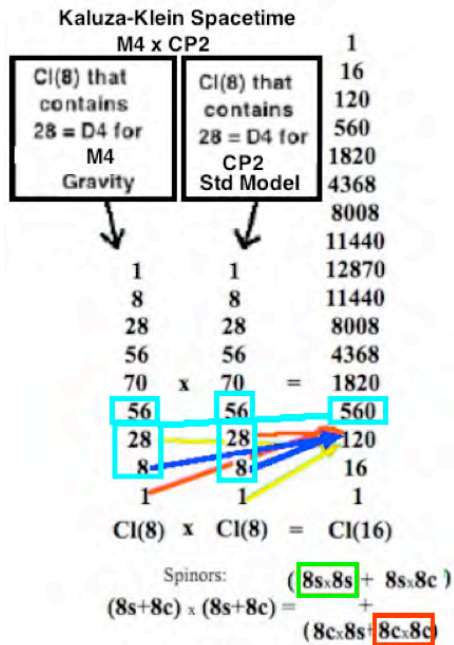

That leaves 1 (orange) + and 127 (blue) = 128-dim Mirror Fermion half-spinors and $65,536 - 256 - 560 - 120 - 16 = 64,584$ elements of $Cl(16)$ available to carry information in the processes of Quantum Consciousness.

According to 12biophys.blogspot.com Lecture 11 Microtubule structure is dynamic: "... One end of the microtubule is composed of stable (GTP) monomers while the rest of the tubule is made up of unstable (GDP) monomers. The GTP end comprises a cap of stable monomers. Random fluctuations either increase or decrease the size of the cap.

This results in 2 different dynamic states for the microtubule.

Growing: cap is present Shrinking: cap is gone ...

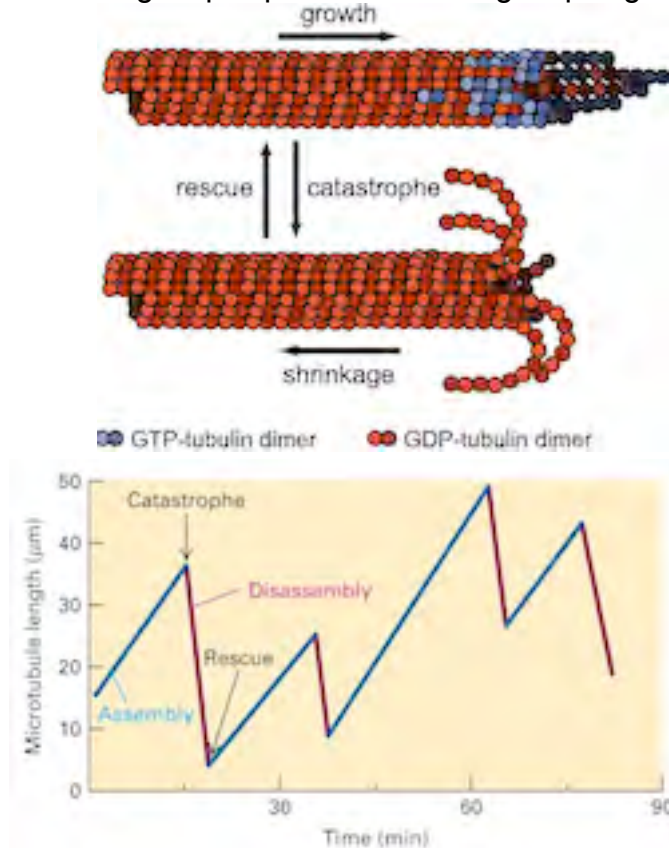

...”.

Microtubules spend most of their lives between 10 microns and 40 microns, sizes that can represent E8 as half of the Even Part (half) of CI(16) (10 microns) or as the Even Part (half) of CI(16) (20 microns) or as full CI(16) (40 microns).

In a given Microtubule

the 128 CI(8) Half-Spinor part ————— is represented by a line of 128 Dimers in its stable GTP region and

the 120 CI(16) BiVector part □ by a 12 x 10 block of Dimers in its stable GTP region
The 560 CI(16) TriVector part is represented similarly.

(image adapted from 12biophys.blogspot.com Lecture 11)

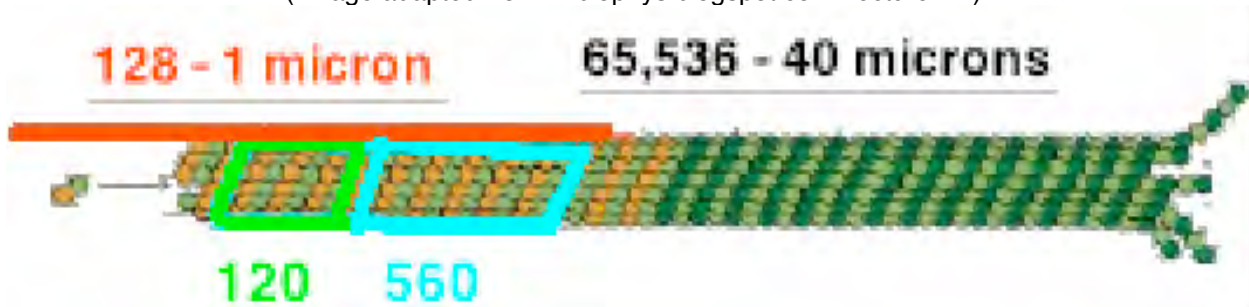

How do the Microtubules communicate with each other ?

Consider the Superposition of States State 0 and State 1 involving one Tubulin Dimer with Conformation Electron mass m and State1 / State 0 position separation a .

The Superposition Separation Energy Difference is the internal energy

$$E_{\text{ssediff}} = G m^2 / a$$

that can be seen as **either the energy of 26D String Theory spin two gravitons** or the **Bohm Quantum Potential internal energy**, equivalently.

Communication between two Microtubules is by the Bohm Quantum Potential between their respective corresponding Dimers with the correspondence being based on connection between respective E8 and Fr3(O) subsets

How is information encoded in the Microtubules ?

Each Microtubule contains E8 and Fr3(O), allowing Microtubules to be correlated with each other. The parts of the Microtubule beyond E8 and Fr3(O) are in Cl(16) for 40 micron Microtubules, or the Even Subalgebra of Cl(16) for 20 micron Microtubules, or half of the Even Subalgebra of Cl(16) for 10 micron Microtubules so since by 8-Periodicity of Real Clifford Algebras $Cl(16) = Cl(8) \times Cl(8)$ and since Cl(8) information is described by the Quantum Reed-Muller code $[[256, 0, 24]]$ **the information content** of Cl(16) and its Subalgebras **is described by the Tensor Product Quantum Reed-Muller code $[[256, 0, 24]]$ x $[[256, 0, 24]]$**

What about information in the Many Microtubules of Human Consciousness ?

The information in one Microtubule is based on Cl(16) which is contained in the Cl(1,25) of 26D String Theory E8 Physics

How does this give rise to Penrose-Hameroff Quantum Consciousness ?

Consider the Superposition of States State 0 and State 1 involving one Tubulin Dimer with Conformation Electron mass m and State1 / State 0 position separation a . The Superposition Separation Energy Difference is the internal energy

$$E_{\text{ssediff}} = G m^2 / a$$

that can be seen as the energy of 26D String Theory spin two gravitons which physically represent the Bohm Quantum Potential internal energy.

For a given Tubulin Dimer $a = 1$ nanometer = 10^{-7} cm so that

$$T = h / E_{\text{electron}} = (\text{Compton} / \text{Schwarzschild}) (a / c) = 10^{26} \text{ sec} = 10^{19} \text{ years}$$

Now consider the case of N Tubulin Dimers in Coherent Superposition connected by the Bohm Quantum Potential Force that does not fall off with distance. Jack Sarfatti defines coherence length L by $L^3 = N a^3$ so that the Superposition Energy E_N of N superposed Conformation Electrons is

$$E_N = G M^2 / L = N^{(5/3)} E_{ssediff}$$

The decoherence time for the system of N Tubulin Electrons is

$$T_N = h / E_N = h / N^{(5/3)} E_{ssediff} = N^{(-5/3)} 10^{26} \text{ sec}$$

so we have the following rough approximate Decoherence Times T_N

Number of Involved Tubulin Dimers	Time T_N
$10^{(11+9)} = 10^{20}$	$10^{(-33 + 26)} = 10^{(-7)} \text{ sec}$ 10^{11} neurons x 10^9 TD / neuron 10 ²⁰ Tubulin Dimers in Human Brain
10^{16}	$10^{(-27 + 26)} = 10^{(-1)} \text{ sec} - 10 \text{ Hz}$ Human Alpha EEG is 8 to 13 Hz Fundamental Schumann Resonance is 7.8 Hz Time of Traverse by a String World-Line Quantum Bohmion of a Quantum Consciousness Hamiltonian Circuit of 10^{16} TD separated from nearest neighbors by 10 nm is $10^{16} \times 10 \text{ nm} / c = (10^{16} \times 10^{(-6)}) \text{ cm} / c = 10^{10} \text{ cm} / c = 0.3 \text{ sec}$

Each cell of E8 Classical Lagrangian Spacetime corresponds to 65,536-dim Cl(16) which contains 248-dim E8 = 120-dim D8 bivectors +128-dim D8 half-spinors

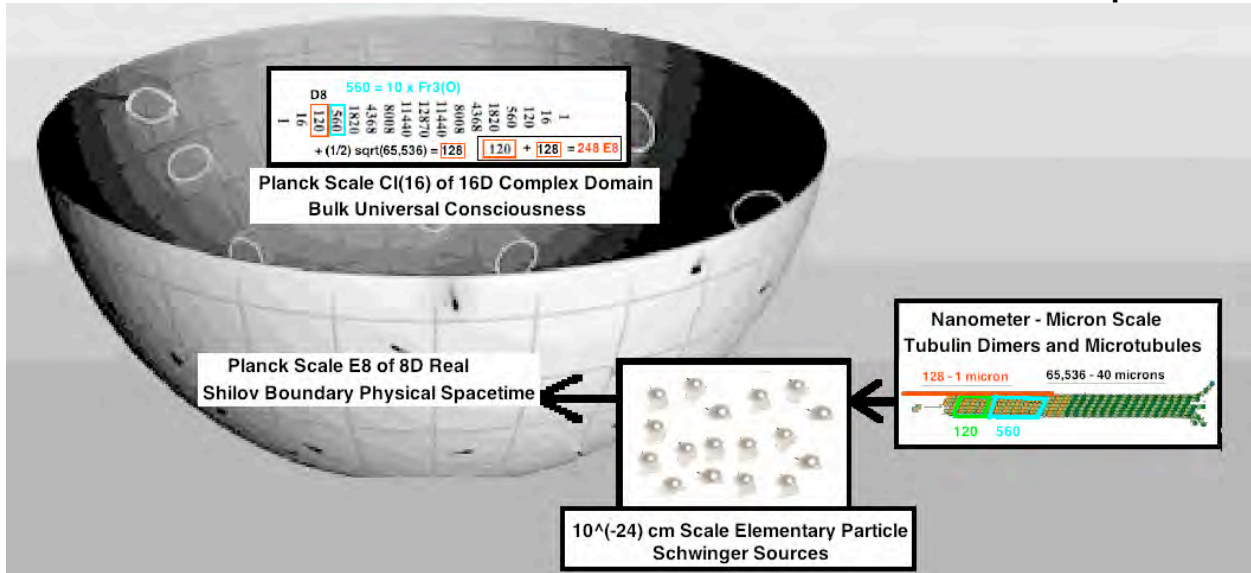

In E8 Physics (viXra 1602.0319)

Spacetime is the 8-dimensional Shilov Boundary $RP1 \times S7$

of the Type IV8 Bounded Complex Domain Bulk Space

of the Symmetric Space $Spin(10) / Spin(8) \times U(1)$

which **Bulk Space** has 16 Real dimensions

and is the Vector Space of the Real Clifford Algebra $Cl(16)$.

By 8-Periodicity,

$Cl(16) = \text{tensor product } Cl(8) \times Cl(8) = \text{Real } 256 \times 256 \text{ Matrix Algebra } M(R,256)$

and so has $256 \times 256 = 65,536$ elements.

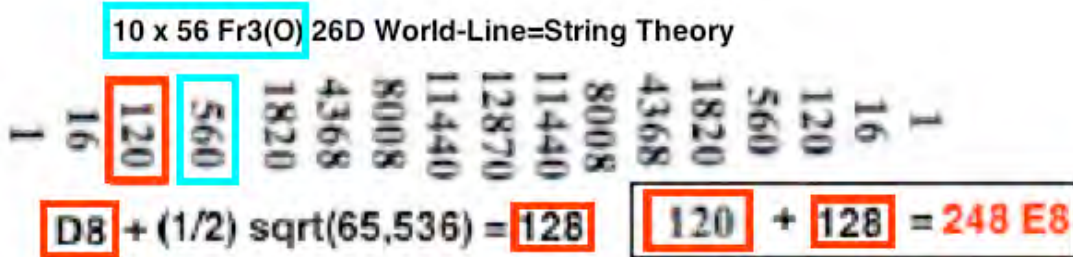

$Cl(8)$ has 8 Vectors, 28 BiVectors, and 16 Spinors with $8+28+16 = 52 = F4$ Lie Algebra.

$Cl(16)$ has 120 BiVectors and 128 Half-Spinors for $120+128 = 248 = E8$ Lie Algebra giving a Lagrangian for the Standard Model and for Gravity - Dark Energy.

$Cl(16)$ has 560 TriVectors for 10 copies of $Fr3(O)$ and $Cl(1,25)$ AQFT

so $65,536 - 248 - 560 = 64,728$ elements of $Cl(16)$ are for Consciousness Information.

The Complex Bulk Space $Cl(16)$

contains the Maximal Contraction of $E8$ which is $H92 + A7$

a generalized Heisenberg Algebra of Quantum Creation-Annihilation Operators with graded structure

$$28 + 64 + ((SL(8,R)+1) + 64 + 2)$$

**The Third Grothendieck Universe AQFT contains
 within each $Cl(1,25)$
 a realistic $E8$ Lagrangian within $Cl(16)$**

and contains

**10 copies of 56-dim $Fr_3(O)$
 are 560 TriVectors of $Cl(16)$
 to describe a World-Lines = Strings String Theory
 with Bohm Quantum Potential
 arising from Nambu-Goto Action**



Similarity of the Bohmion carrier of the Bohm Quantum Potential to the spin 2 Graviton accounts for the Bohmion's ability to support Penrose Consciousness with Superposition Separation Energy Difference $G m^2 / a$ where, for a Human Brain,

m = mass of electron and a = 1 nanometer in Tubulin Dimer

“... Bohm's Quantum Potential can be viewed as an internal energy of a quantum system ...”

according to Dennis, de Gosson, and Hiley (arXiv 1412.5133)
 and

Bohm Quantum Potential inherits Sarfatti Back-Reaction from its similarity to General Relativity

Peter R. Holland says in "The Quantum Theory of Motion": "... the total force ... from the quantum potential ... does not ... fall off with distance ... because ... the quantum potential ... depends on the form of ... [the quantum state]... rather than ... its ... magnitude ...".

Penrose-Hameroff-type Quantum Consciousness is due to Resonant Quantum Potential Connections among Quantum State Forms.

The Quantum State Form of a Conscious Brain is determined by the configuration of a subset of its 10^{18} to 10^{19} Tubulin Dimers described by a large Real Clifford Algebra.

Paola Zizzi in gr-qc/0007006 describes the Octonionic Inflation Era of Our Universe as a Quantum Consciousness Superposition of States ending with Self-Decoherence after 64 doublings of Octonionic Inflation, at which time Our Universe is "... a superposed state of quantum ... [qubits]. the self-reduction of the superposed quantum state is ... reached at the end of inflation ... [at]... the decoherence time ... [$T_{\text{decoh}} = 10^9 T_{\text{planck}} = 10^{(-34)}$ sec] ... and corresponds to a superposed state of ... [$10^{19} = 2^{64}$ qubits]. ...".

64 doublings to 2^{64} qubits corresponds to the Clifford algebra $Cl(64) = Cl(8 \times 8) = Cl(8) \times Cl(8) \times Cl(8) \times Cl(8) \times Cl(8) \times Cl(8) \times Cl(8) \times Cl(8)$. By the periodicity-8 theorem of Real Clifford algebras, $Cl(64)$ is the smallest Real Clifford algebra for which we can reflexively identify each component $Cl(8)$ with a basis vector in the $Cl(8)$ vector space. This reflexive identification causes our universe to decohere at $N = 2^{64} = 10^{19}$.

The End of Inflation time was at about $10^{(-34)}$ sec = $2^{64} T_{\text{planck}}$ and the size of our Universe was then about $10^{(-24)}$ cm which is about the size of a Schwinger Source Kerr-Newman Cloud.

What about information in the Microtubules of Human Consciousness ?

The information in one Microtubule is based on Cl(16)
which is contained in the Cl(1,25) of 26D String Theory E8 Physics

How does this give rise to Penrose-Hameroff Quantum Consciousness ?

Consider the Superposition of States State 0 and State 1 involving one
Tubulin Dimer with Conformation Electron mass m and State1 / State 0
position separation a .

The Superposition Separation Energy Difference is the internal energy

$$E_{\text{ssediff}} = G m^2 / a$$

that can be seen as the energy of 26D String Theory Bohmions
which physically represent the Bohm Quantum Potential internal energy.

For a given Tubulin Dimer $a = 1$ nanometer = 10^{-7} cm so that
 $T = h / E_{\text{electron}} = (\text{Compton} / \text{Schwarzschild}) (a / c) = 10^{26}$ sec =
 10^{19} years

Now consider the case of N Tubulin Dimers with total mass Nm in Coherent
Superposition connected by the Bohm Quantum Potential Force that does
not fall off with distance

$$E_{\text{ssediff}} = G (Nm)^2 / a$$

Jack Sarfatti defines coherence length L by $L^3 = N a^3$ so that
the Superposition Energy E_N of N superposed Conformation Electrons is

$$\begin{aligned} E_N &= G (Nm)^2 / L = G (Nm)^2 / (a N^{1/3}) = N^{5/3} Gm^2 / a = \\ &= N^{5/3} E_{\text{ssediff}} \end{aligned}$$

The decoherence time for the system of N Tubulin Electrons is

$$T_N = h / E_N = h / N^{5/3} E_{\text{ssediff}} = N^{-5/3} 10^{26} \text{ sec}$$

so we have the following rough approximate Decoherence Times T_N

Number of Involved Tubulin Dimers	Time T_N	
$10^{(11+9)} = 10^{20}$	$10^{(-33 + 26)} = 10^{(-7)}$ sec	10^{11} neurons x 10^9 TD / neuron 10^{20} Tubulin Dimers in Human Brain

10^{16} $10^{(-27 + 26)} = 10^{(-1)}$ sec - 10 Hz
 Human Alpha EEG is 8 to 13 Hz
 Fundamental Schumann Resonance is 7.8 Hz

Time of Traverse by a String World-Line Quantum Bohmion of a Quantum
 Consciousness Hamiltonian Circuit of 10^{16} TD separated from nearest neighbors
 by 10 nm is $10^{16} \times 10 \text{ nm} / c = (10^{16} \times 10^{(-6)}) \text{ cm} / c = 10^{10} \text{ cm} / c = 0.3 \text{ sec}$

$Cl(16)$ has 65,536 elements.

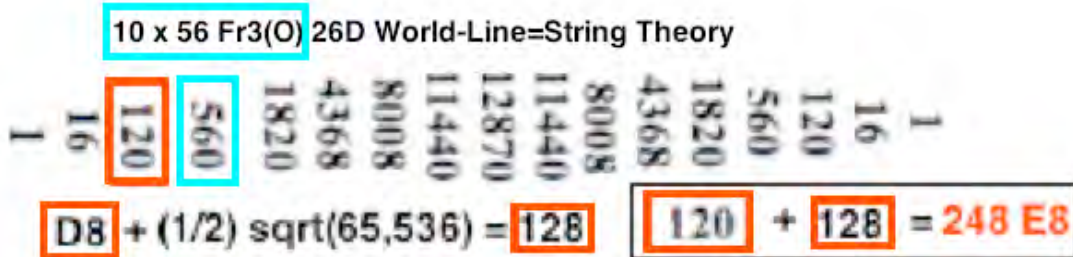

Human Brain Microtubules 40 microns long have 65,536 Tubulin Dimers



so can have Bohm Quantum Resonance with $Cl(16)$ Spacetime cells

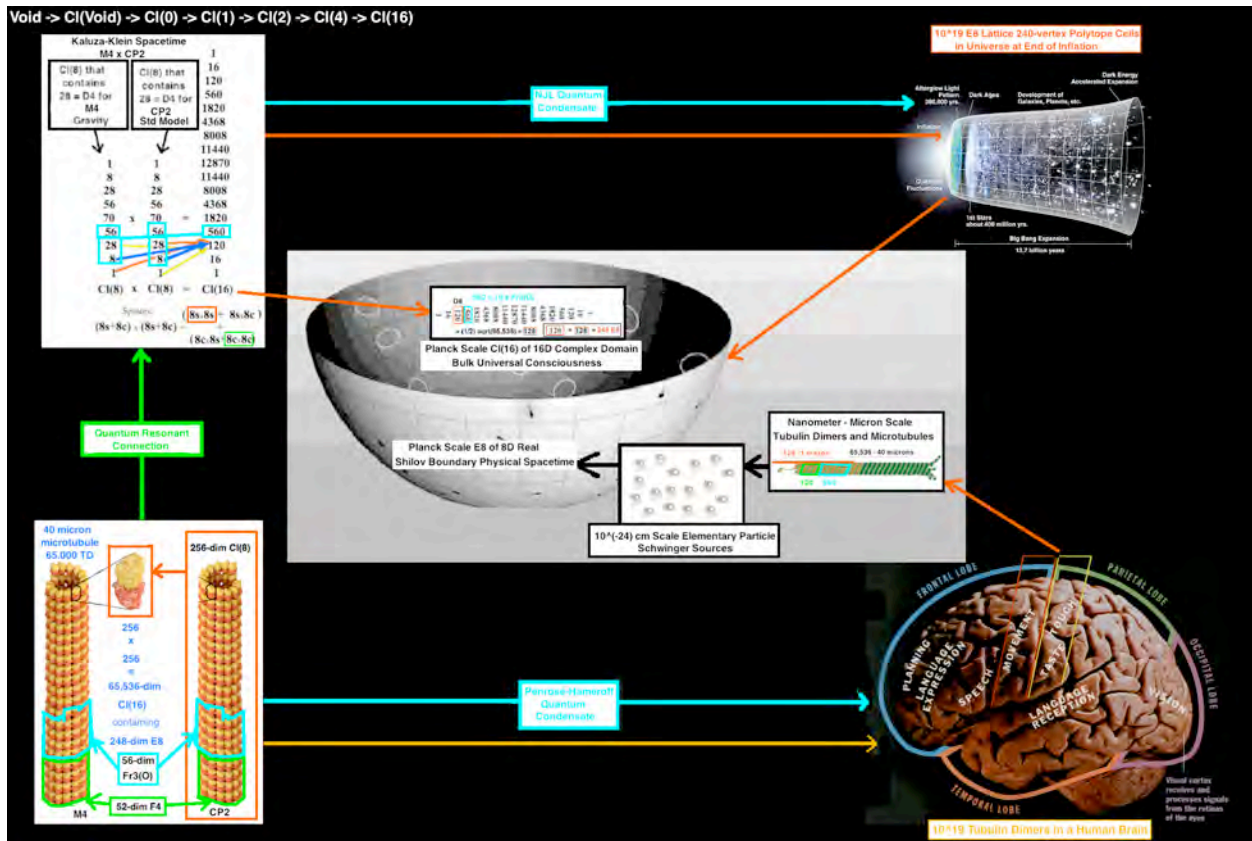

so that at any and all Times the State of Consciousness of a Human is in exact resonant correspondence with a subset of the cells of E8 Classical Lagrangian Spacetime Therefore

E8 Classical Lagrangian Spacetime Nis effectively the Spirit World in which the Human States of Consciousness = Souls exist.

After the death of the Human Physical Body the Spirit World interactions with its Soul are no longer constrained by Physical World interactions with its Body so that the Spirit World can harmonize the individual Soul with the collective Universal Soul.

William Kingdon Clifford, who invented Real Clifford Algebras, called them “mind-stuff”, saying: “...

When matter takes the complex form of a living human brain, the corresponding mind-stuff takes the form of a human consciousness ...”.

The ROOF
is on FIRE

Science, Art, and Music

Let the
HOLY GHOST BURN

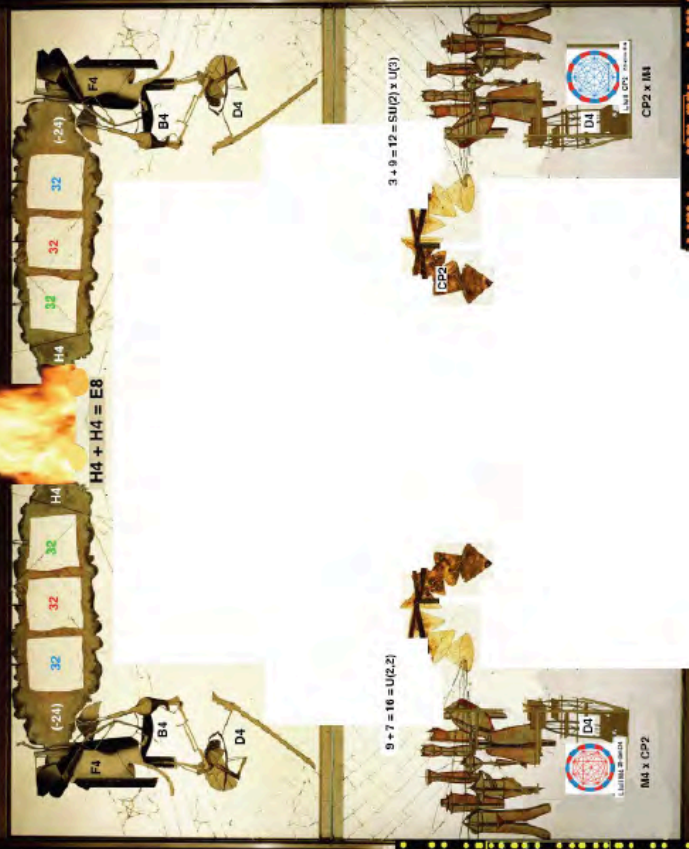

Science, Art, and Music

Frank Dodd (Tony) Smith, Jr. - 2019

Abstract

In my view: Science = Art = Music:

**Science is explained by a Theory of Everything (TOE) using Real Clifford Algebra
CI(16)**

**The Pinnacle of Human Art is Marcel Duchamp's Large Glass which (when
combined with its Mirror image) corresponds in detail with CI(16) Physics TOE**

**The Pinnacle of Human Music is Beethoven's Grosse Fugue which
corresponds in detail with CI(16) TOE**

CI(16) emerged from a Quantum Fluctuation in a Void in our Parent Universe
by **David Finkelstein's Clifford Iteration Process:**

CI(Void) = Clifford Algebra of Void = 0

CI(0) = 2^0 dimensions = 1

CI(1) = $2^1 = 2$

CI(2) = $2^2 = 4$

CI(4) = $2^4 = 16$

CI(16) = $2^{16} = 65,536 = \text{tensor product CI}(8) \times \text{CI}(8) = 256 \times 256$

CI(16) has 16 Vectors = Lie Ball = Spin(10) / Spin(8) x U(1)

CI(16) has 120 BiVectors = D8 subalgebra of E8

CI(16) has 128 half-Spinors (1 0-Vector + 126 8-Vectors + 1 16-Vector)

$120+128 = 248 = E8$

CI(16) has 560 TriVectors = 10 copies of Fr3(O)

56-dim Fr3(O) has 2 copies of 27-dim J3(O)

The other 65,536-16-120-128-560 = 64,712 elements of CI(16) are available
to carry information in processes such as Quantum Consciousness.

**This paper is an Overview. For details see viXra 1810.0365 and 1904.0193
and my other viXra papers and my pages on the web.**

Table of Contents

Large Glass + Mirror represents CI(16) Physics
with CI(16) emergence from Void by Clifford Iteration ... page 3

IFA and Ramon Llull X-wheel ... page 4

Beethoven Grosse Fugue ... page 5

Table of Contents (cont'd)

LGL+M Structure Sequence

D4 x D4 in Octonionic Spacetime ... page 8

Quaternionic M4 x CP2 Kaluza-Klein Spacetime

D4 for Gravity+Dark Energy with $9+7 = 16$ -dim $U(2,2)$

D4 for Standard Model with $3+8 = 12$ -dim $SU(3) \times SU(2) \times U(1)$

with $SU(2) \times U(1)$ coming from $CP2 = SU(3) / SU(2) \times U(1)$... page 9

D4 -> B4 -> F4 -> H4 ... page 10

H4 + H4 = 240 E8 Root Vectors - E8 = 248 **Cl(16) BiVectors + half-Spinors** ... page 11

Aschheim 2-dim image of E8 Root Vectors ... page 12

16 **Cl(16) Vectors** = Lie Ball $Spin(10) / Spin(8) \times U(1)$... page 14

16 **Cl(16) Vectors** and 248 **Cl(16) BiVectors + half-Spinors** ... page 18

560 **Cl(16) TriVectors** = 10 copies of 56-dim $Fr_3(O)$... page 19

26D Strings=World-Lines - Bohm Quantum Potential

Conscious Smiling Spirit Being ... page 20

Overview of LG+M and Cl(16) ... page 29

Appendices

E8 Lagrangian Density and Cl(16) Vector Base Manifold ... page 30

Octonionic to Quaternionic Transition ... page 35

Schwinger Sources and Calculations of Forces, Particle Masses, etc page 40

Results of Calculations ... page 47

Cl(1,25) Algebraic Quantum Field Theory with Cl(16) symmetry ... page 49

Bohm Quantum Potential and Quantum Consciousness ... page 51

Large Glass + Mirror represents Cl(16) Physics

Marcel Duchamp's Large Glass, when combined with its Mirror Image - LG+M -

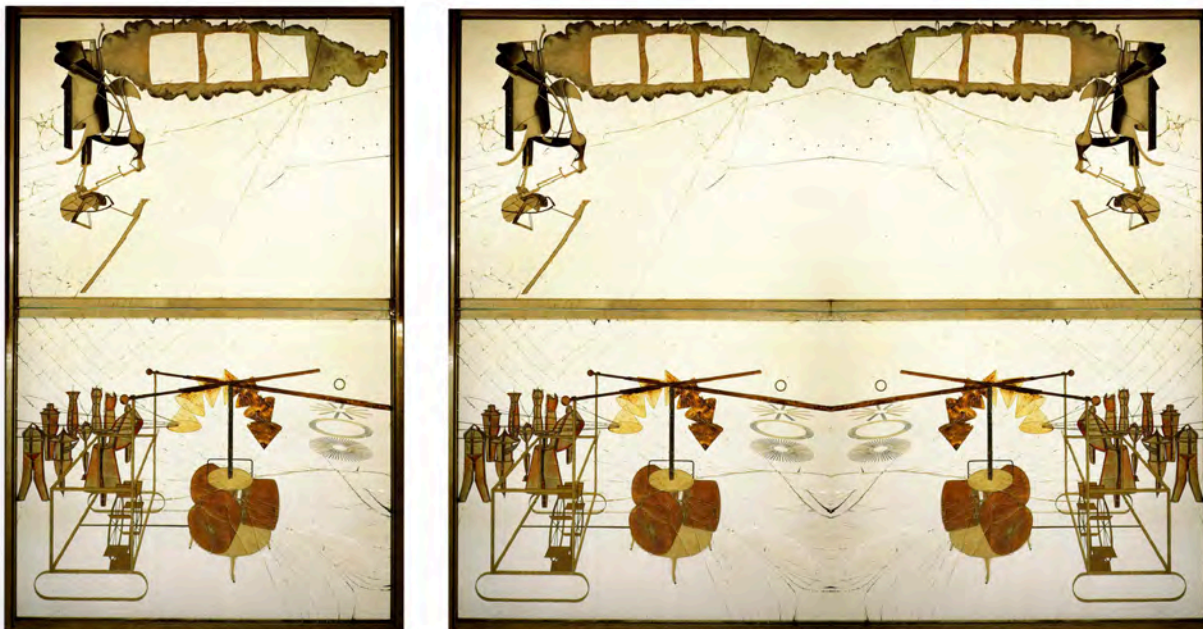

seems to contain the basic elements of a Theory of Everything (TOE)
based on Real Clifford Algebra Cl(16) (viXra 1809.01670 and 1810.0365).
Cl(16) emerged from a Quantum Fluctuation in a Void in our Parent Universe
by David Finkelstein's Clifford Iteration Process

Cl(Void) = Clifford Algebra of Void = 0

Cl(0) = 2⁰ dimensions = 1

Cl(1) = 2¹ = 2

Cl(2) = 2² = 4

Cl(4) = 2⁴ = 16

Cl(16) = 2¹⁶ = 65,536

which stops at Cl(16) because, by 8-Periodicity of Real Clifford Algebras,
Cl(16) factors into tensor product Cl(8) x Cl(8)

LG+M represents the two 256-dim Cl(8) by two 8-paddle Wheels

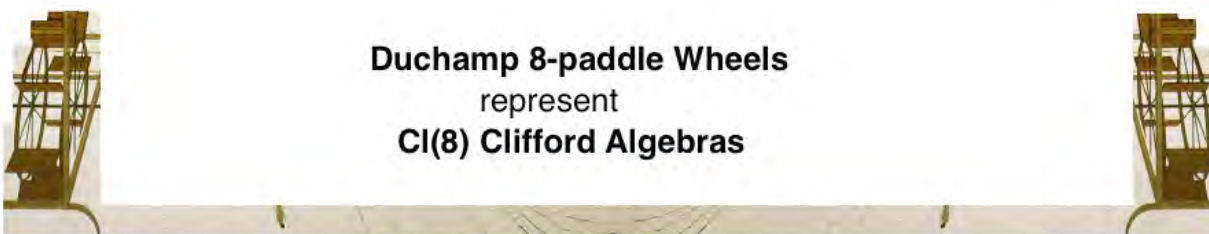

Duchamp 8-paddle Wheels

represent

Cl(8) Clifford Algebras

Each Cl(8) contains 28-dim D4 Lie Algebra as its BiVectors.

600 years before Duchamp, Ramon Llull represented D8 BiVector Lie Algebra of $Cl(16)$ by his X-wheel with 16 vertices and 120 lines. Lull had studied African divination systems and his choice of 16 vertices corresponded to 16 Orishas (8+8 $Cl(8)$ Spinors) and 256 Odu (16x16 Matrices of $Cl(8)$) of ancient African IFA (viXra 0907.0040).

X-wheel's 120 lines are two sets of 28 lines for two D4 and

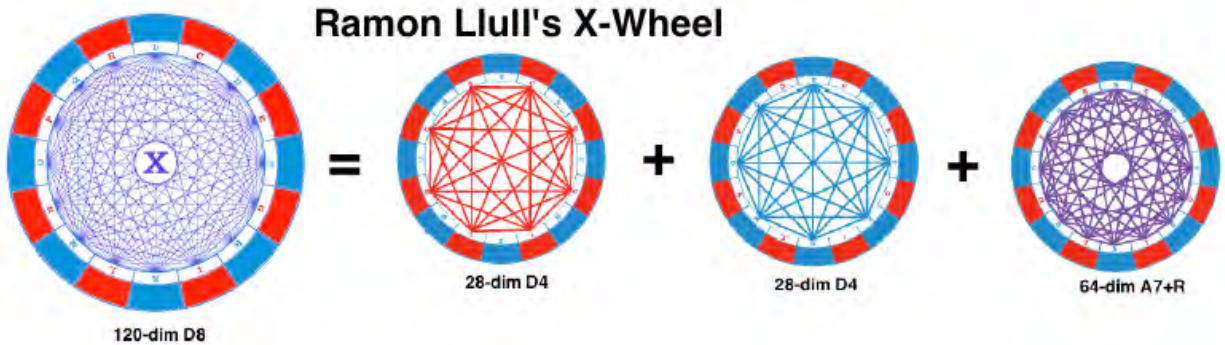

64 lines for A7+R that represent Creation / Annihilation Operators for 8-dim Spacetime whose 8-dim Octonionic Vector Space has Quaternionic substructure that is manifested at the End of Inflation as $M4 \times CP2$ Kaluza-Klein where $M4$ is 4-dim Physical Spacetime and $CP2 = SU(3) / SU(2) \times U(1)$

The LG+M 8 paddle Wheel on the left has 28-dim D4 BiVectors with Conformal $U(2,2)$ subalgebra containing $D3 = Spin(2,4)$ giving Gravity + Dark Energy and acting on $M4$ of $M4 \times CP2$.

The LG+M 8 paddle Wheel on the right has 28-dim D4 BiVectors with $A3 = SU(4)$ subalgebra containing $SU(3)$ giving the Standard Model and acting on $CP2$ of $M4 \times CP2$. $SU(2) \times U(1)$ of the Standard Model come from $CP2 = SU(3) / SU(2) \times U(1)$.

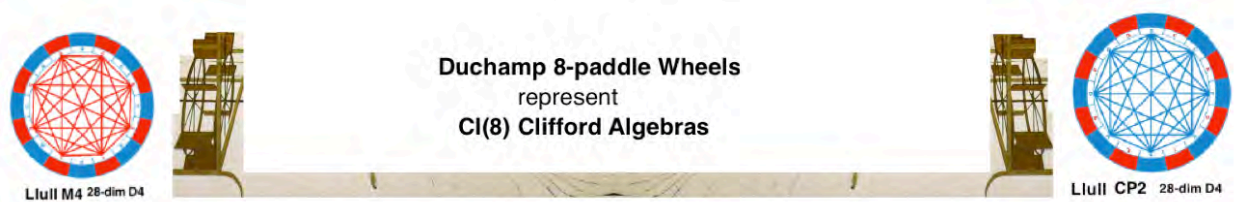

Anthony Bonner in his book Doctor Illuminatus about Llull said "... Even ...[Llull's]... disciple, le Myesier, complained ... about "... its sixteen figures, which confounded the mind." ... Llull ... tr[ie]d to persuade the Parisian schoolmen ...[but]... In 1390 ... the Faculty of Theology publish[ed] an edict prohibiting the teaching of Llullist doctrines ... [therefore]... As a result of the "weakness of human intellect" [of Parisian schoolmen] the number of figures [wa]s reduced and the algebraic notation vanishe[d] ...".

100 years before Duchamp, Ludwig van Beethoven wrote the Grosse Fugue whose [Opening and Overture](#) represent the basic structure of Cl(16) Physics.

Beethoven's Grosse Fugue (Opus 133 and 134) to me (viXra 1901.0013) is the highest point in Human Music. Stephen Malinowski said "... many think ... Beethoven's late quartets are ... among civilization's crowning achievements ... and the Grosse Fuga arguably the most complex and challenging movement ...".

"... Since ... the 1920s ... the fugue has grown greatly in the eyes of musicians and performers. **"The Great Fugue... now seems to me the most perfect miracle in music,"** said Igor Stravinsky "... It is also the most absolutely contemporary piece of music I know, and contemporary forever... Hardly birthmarked by its age, the Great Fugue is, in rhythm alone, more subtle than any music of my own century... I love it beyond everything." Pianist Glenn Gould said, "for me, **the 'Grosse Fuge' is not only the greatest work Beethoven ever wrote but just about the most astonishing piece in musical literature.**" ...". (from Wikipedia)

My view is that **Duchamp's Large Glass + its Mirror image is to Art what Beethoven's Grosse Fugue is to Music**

and

that both of them are representations of Cl(16) Physics (viXra 1804.0121)

The Structure of Beethoven's Grosse Fugue (Opus 133 and 134)

(viXra 1901.0013) corresponds to Cl(16) - E8 Physics (viXra 1810.0365).

Since Beethoven wrote the Grosse Fugue in 1825, two years before his death in 1827, and the E8 Lie Algebra and the Cl(16) Real Clifford Algebra were not known until the work of Lie, Killing, and Clifford in the 1870s-1880s, it was not possible for Beethoven to have used the math knowledge of his day in writing the Grosse Fugue. A possible explanation could be that our conscious brains have structure similar to the structure of Cl(16) - E8 so that when Beethoven was composing, looking deep inside his conscious brain to "hear" music mentally that he could not hear normally because of his deafness, he was "seeing" Cl(16) - E8. Human quantum consciousness is based on microtubules containing maximally about 65,536 Tubulin Dimers. E8 lives in the 65,536-dimensional Real Clifford Algebra Cl(16). Cl(16) is the basic structure of our Universe so Beethoven could have been "seeing" in his mind that the E8 inside Cl(16) looks like part of the structure of microtubules of his consciousness and then writing that structure into the Grosse Fugue.

The Grosse Fugue correspondences with Cl(16) - E8 are shown here using visualizations by Stephen Malinowski.

Beethoven wrote String Quartet Opus 135 in 1826, the year after writing the Grosse Fugue and the year before his death. Its last movement is headed “Der schwer gefasste Entschluss” (“The Difficult Decision”). In it Beethoven wrote in the manuscript “Muss es sein?” (Must it be?) to which he responds “Es muss sein!” (It must be?). (Wikipedia)

Der schwer gefasste Entschluss.



(Elias String Quartet - The Beethoven Project)

My view is that Beethoven sees that the Grosse Fugue has the deep theoretical / historical correlations that I describe in this paper and that he is asking himself to make the Difficult Decision of whether or not those correspondences made it inevitable that he write the Grosse Fugue as he did write it and continue to support it despite the fierce dislike of it expressed by his audience and his publisher. His answer “Es muss sein!” is a declaration that the Grosse Fugue is as important and accurate as to theory and history as I think it is.

The Grosse Fugue [Opening and Overture](#) is

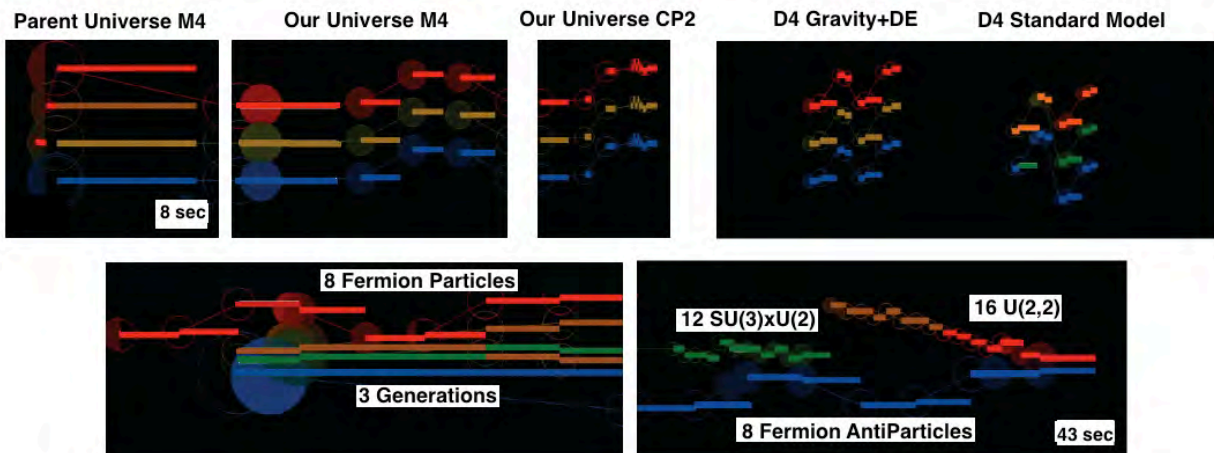

The two D4 of the D8 in E8 in Cl(16) are

D4 Gravity+Dark Energy

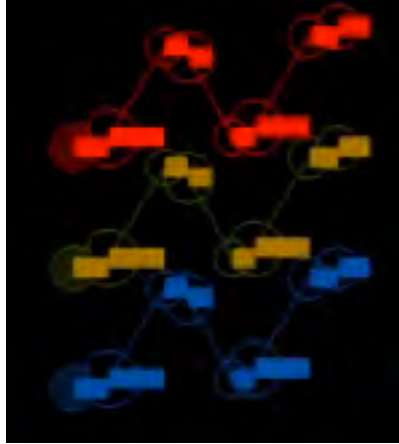

D4 Standard Model

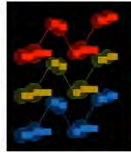
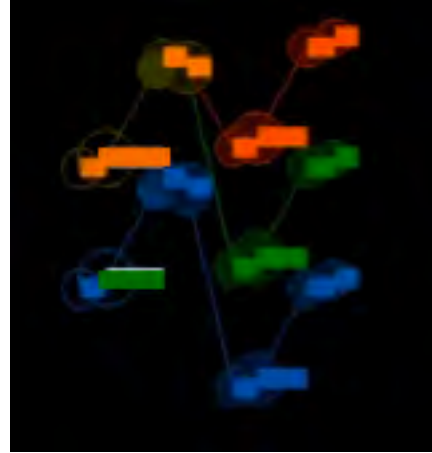

Duchamp 8-paddle Wheels
represent
Cl(8) Clifford Algebras

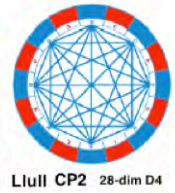
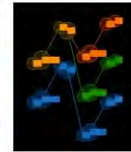

"... The Grosse Fugue ... was universally condemned by contemporary critics ... the audience had demanded encors of two middle movements ... Beethoven ... growled, "And why didn't they encore the Fugue? That alone should have been repeated! Cattle! Asses!" ...

the notoriously stubborn **Beethoven agreed ... readily to replace the fugue ..."**

just as **Llull had reduced the number of vertices of his X-wheel due to his perception of the "weakness of human intellect" ..."**.

LGL+M = CI(16) Structure Sequence

Start with the two CI(8) of Periodicity tensor product $CI(8) \times CI(8) = CI(16)$
Each CI(8) contains one of the two D4 subalgebras of the CI(16) BiVector Lie algebra D8



or equivalently
the two 8-vertex subwheels of Lull's 16-vertex X-wheel



or equivalently
these two passages from Beethoven's Grosse Fugue



Octonion Spacetime breaks into Quaternionic Kaluza-Klein $M4 \times CP2 = SU(3) / U(2)$
 at End of Inflation
 with D4 of M4 for Gravity + Dark Energy and D4 of CP2 for Standard Model



The Left D4 of Gravity + Dark Energy contains $9+7=16$ -dim $U(2,2)$
 The Right D4 of Standard Model contains $3+9=12$ -dim $SU(3) \times SU(2) \times U(1)$
 with the the $16-12 = 4$ remaining representng $CP2$
 and $SU(2) \times U(1)$ coming from $CP2 = SU(3) / SU(2) \times U(1)$

To each D4 add B4 Vectors and F4 Spinors



D4 - Spin(8)
Cl(8) BiVector skeleton



B4 - add OP1
Cl(8) Vector muscle



F4 - add OP2
Cl(8) Spinor skin

Each D4 grows into B4 ($B4 / D4 = OP1$)

Each B4 grows into F4 ($F4 / B4 = OP2$)

**Each F4 grows into H4 (F4 root vectors = 24-cell + dual 24-cell
with dual 24-cell 24 vertices replaced by 96 Golden Ratio points
consistently placed on 96 edges of dual 24-cell)**

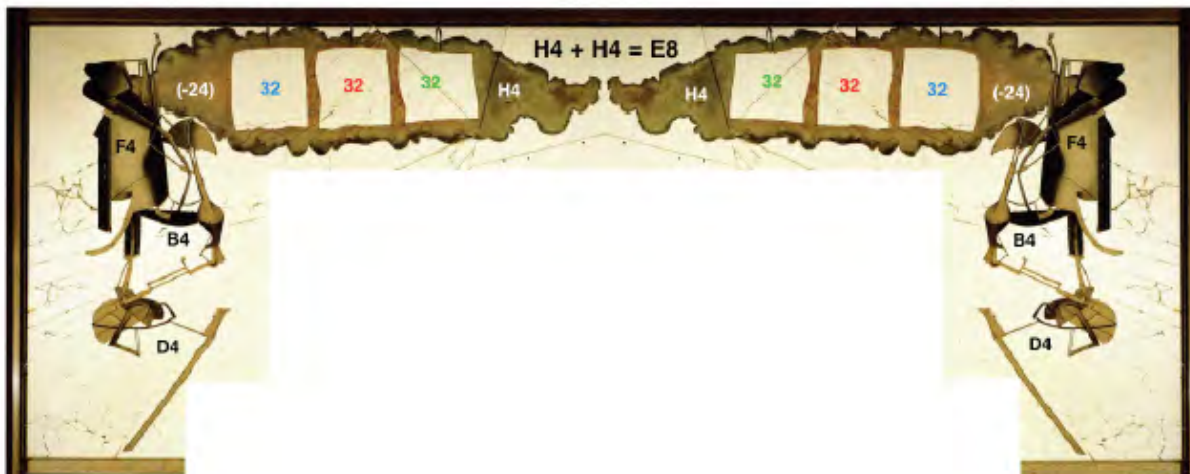

There are two ways to place the Golden Ratio Points,
one way for each of the two H4 emerging from the two D4.

For the two H4 the 96 Golden Ratio points represent:

64 of A7+R Unimodular Group of 8-dim Spacetime (32 for M4 and 32 for CP2)

64 = 8 components of 8 Fermion Particles (32 for M4 and 32 for CP2)

64 = 8 components of 8 Fermion AntiParticles (32 for M4 and 32 for CP2)

Finally, 120 + 120 root vectors of the two H4 = 240 root vectors of E8.

Cl(16) BiVectors + half-Spinors = E8



120 H4 + 120 H4 = 240 Root Vectors of E8

240 E8 Root Vectors that live in the 8-dim E8 Root Vector Space
 have been represented by Ray Aschheim in 2-dim:

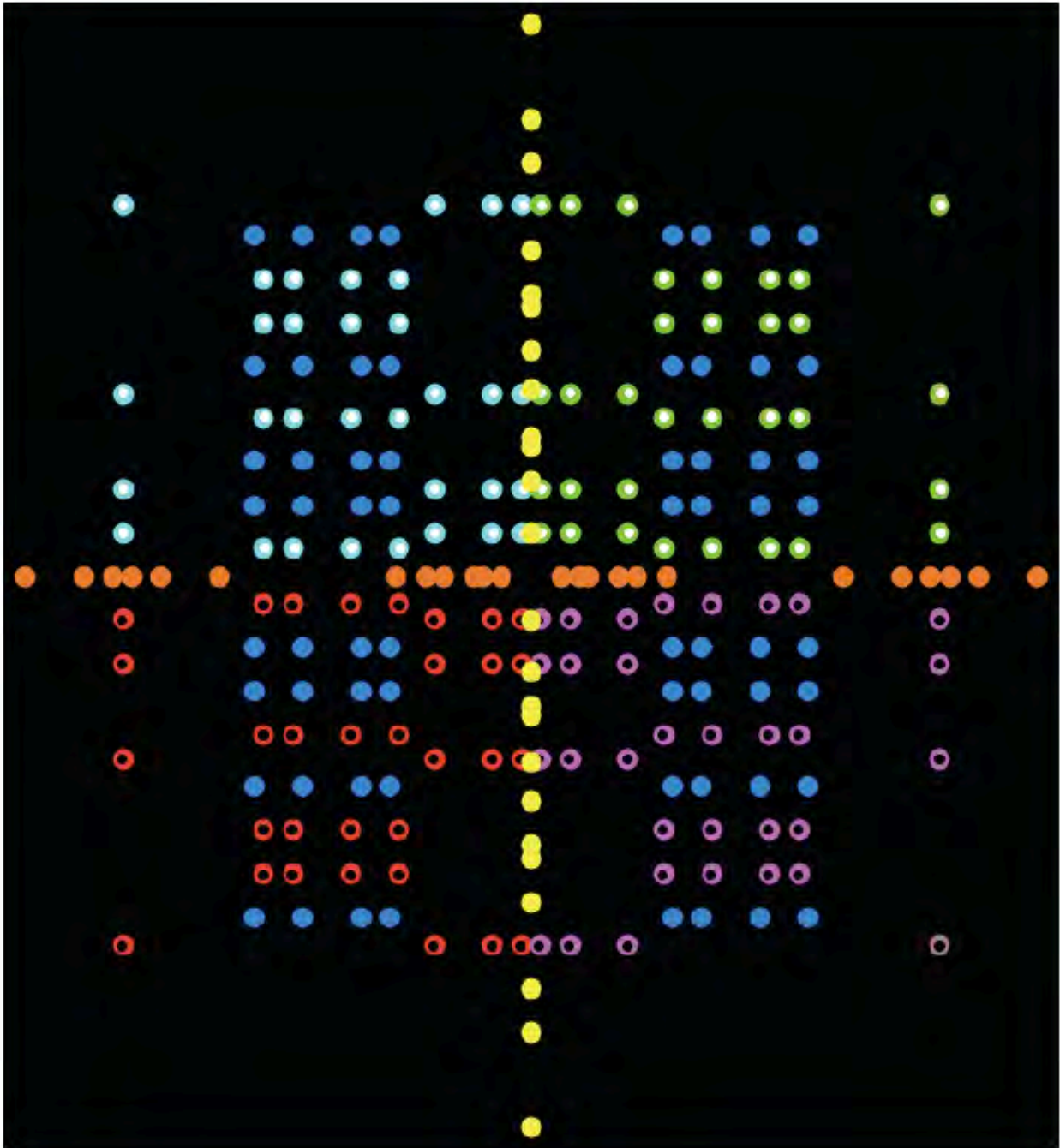

248-dim E8 = 120-dim Spin(16) D8 + 128-dim half-spinor of Spin(16) D8
 240 E8 Root Vectors = 112 D8 Root Vectors + 128 D8 half-spinors
 112 D8 Root Vectors = 24 D4 (orange) + 24 D4 (yellow) + 64 (blue)
 128 D8 half-spinors = 128 elements of E8 / D8
 Green and Cyan dots with white centers (32+32 = 64 dots) and
 Red and Magenta dots with black centers (32+32 = 64 dots)
 correspond to the 128 elements of E8 / D8.

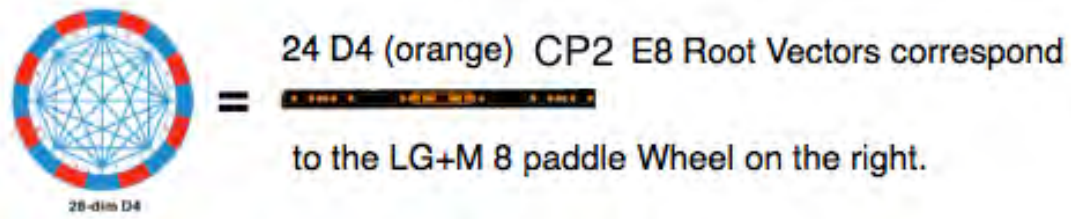
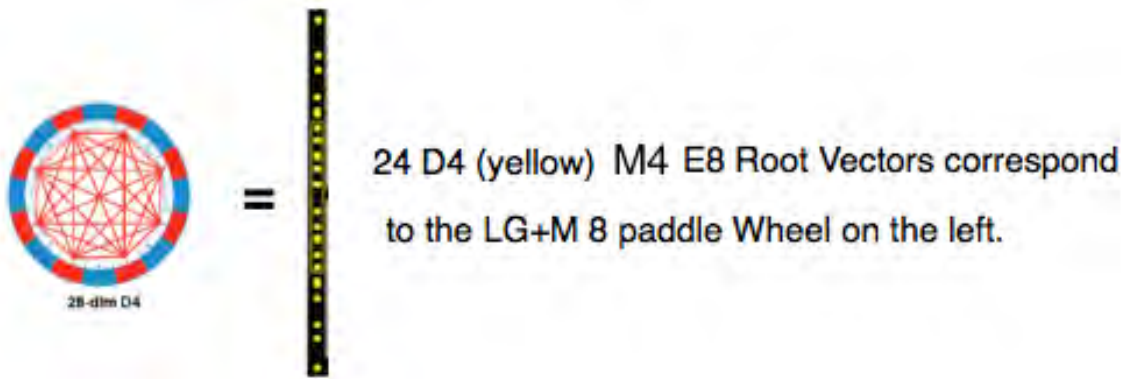

The other $64 + 64 + 64 = 192$ E8 Root Vectors correspond to the 6 Windows as:

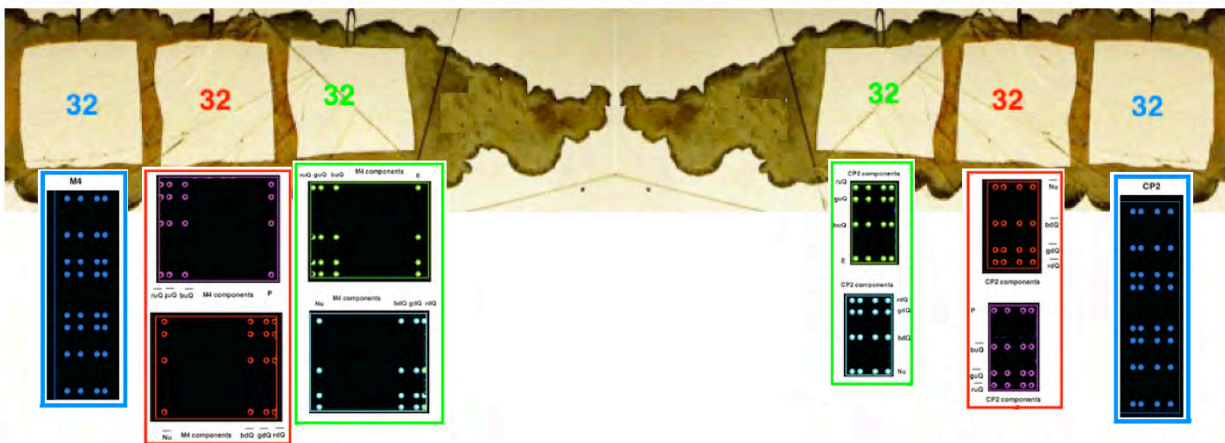

$$\text{Cl}(16) \text{ Vectors} = \text{Lie Ball Spin}(10) / \text{Spin}(8) \times \text{U}(1)$$

Cl(16) has 16 Vectors represented by Duchamp as small black dots

(Duchamp placed two other small black dots in the H4 regions



perhaps to indicate duality of the two D4-B4-F4-H4 structures and complexification of F4 and J3(O) to E6 and Fr3(O))

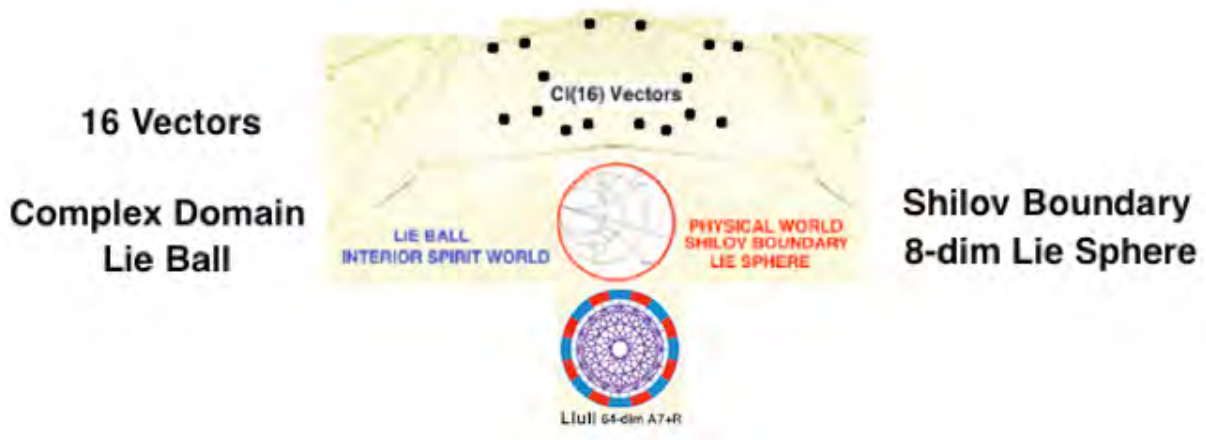

Cl(16) Vectors = Lie Ball Spin(10) / Spin(8)xU(1) Symmetric Space
 with Bounded Complex Domain of Hua Type IV(8)
 whose Lie Sphere Shilov Boundary
 is 8-dim Spacetime with Unimodular Symmetry A7+R
 that is Base Manifold for a Lagrangian based on E8 structure

The diagram shows a circular lattice structure labeled '64-dim A7+R' on the left. This is followed by an equals sign, then two vertical rectangular structures representing '32 M4 Components'. These are followed by a plus sign and another equals sign, leading to the text '32 CP2 Components of 8 Spacetime Superposition E8 Lattices'. The text 'of 8 Spacetime Superposition E8 Lattices' is repeated above and below the plus sign.

The 64 Blue Root Vectors of the space $D_8 / D_4 \times D_4$ represent 8D Spacetime and the $A_7 = SL(8,R)$ of Unimodular Gravity that is in the Maximal Contraction Heisenberg Algebra of E_8 with structure $28 + 64 + (A_7+R) + 64 + 28$ of Quantum Creation / Annihilation Operators of Particles and Spacetime

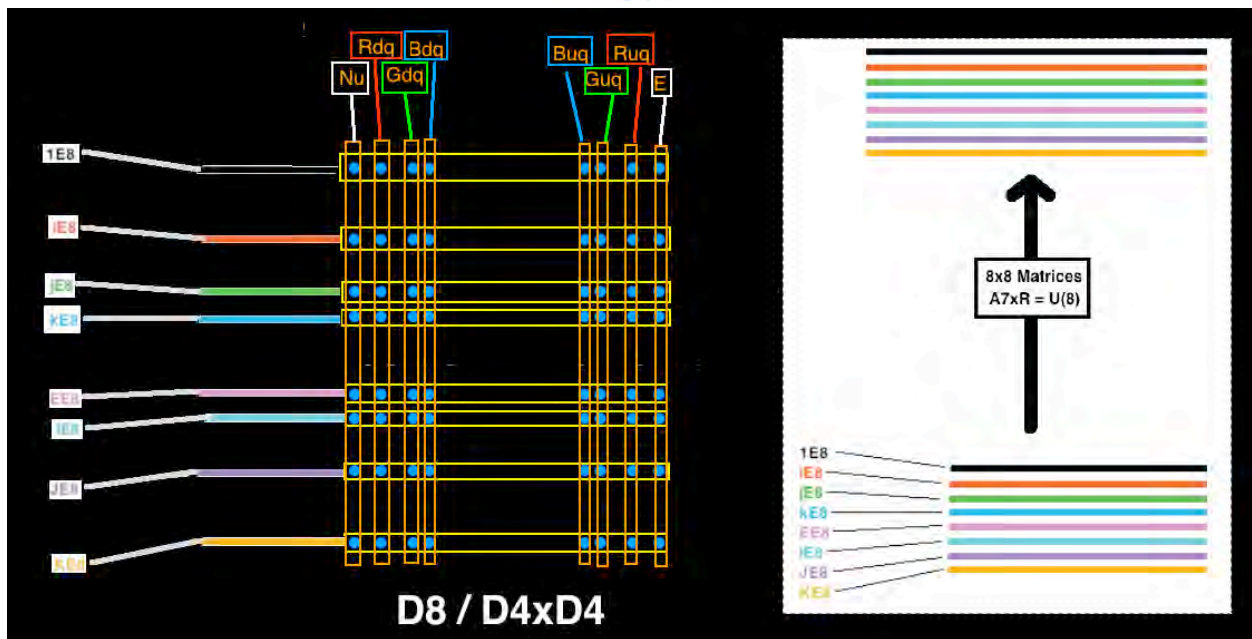

Cl(16) Vectors and BiVectors + half-Spinors



560 Cl(16) TriVectors = 10 copies of 56-dim Fr3(O)

Only one copy of Fr3(O) is explicitly shown by Duchamp because the 10 copies are one for each of $26-16 = 10$ dimensions of 26D String=World-Line Theory with all 10 being in a State of Superposition

8 of the 10 dimensions are represented by 8 algebraically independent E8 Lattices (7 Integral Domains) so that each of the 8 types of Fermions has its own E8 Lattice

26D String=World-Line Theory comes from Fr3(O) =
 = 56-dim Freudenthal Algebra Fr3(O) = Complexification of 27-dim J3(O)
 with 26-dim traceless part J3(O)

The Large Glass + Mirror connects World-Line Strings with the volumes of M4 and CP2 parts of Spacetime and
 56 of the 560 TriVectors of Cl(16) = Fr3(O) = $1+8+8+8+1+1+1 + 1+8+8+8+1+1+1$

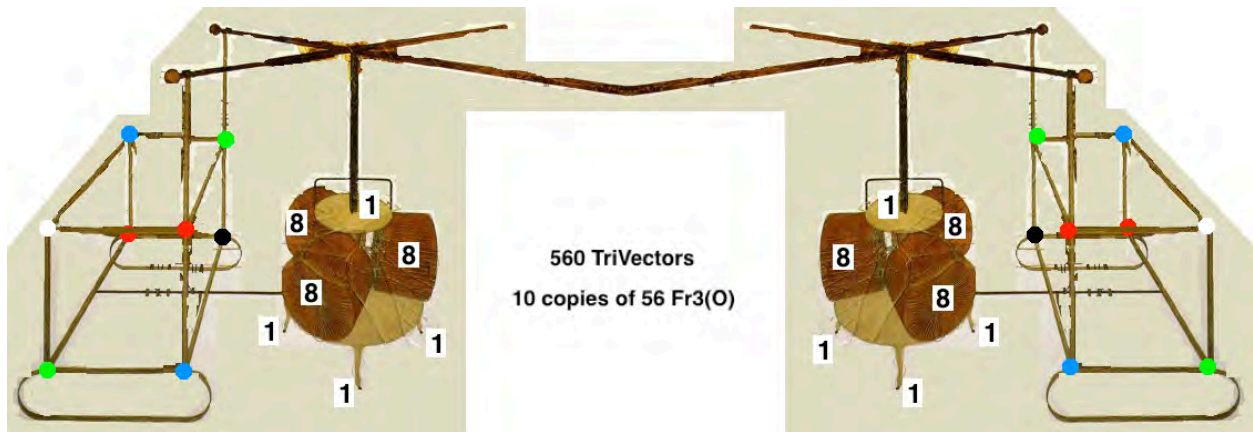

Strings = World-Lines in M4 and CP2 interact by entire fine-grained histories in Andrew Gray's quant-ph/9712037v2 Quantum Theory with interference factors among different possible histories at each time. Each Gray History is a World-Line String.



The Gray Fine-Grained History Quantum Theory is equivalent to the Nambu-Goto action of 26D String Theory.

Nambu-Goto symmetric 24x24 traceless spin-2 particle is Quantum Bohmion carrier of Bohm Quantum Potential

Nambu-Goto antisymmetric SO(24) little group is related to the Monster automorphism group that is the symmetry of each cell of Planck-scale local lattice structure.

Tachyons localized at orbifolds of fermions produce virtual clouds of particles / antiparticles that dress fermions as Schwinger Sources.

www.outline-of-knowledge.info/OKD/5/Physics/Matter/Atom/Orbital/Spin/spin%20of%20particle.html said "... Spin-2 particles are tensors, with two symmetry axes ...".

Richard Feynman in his Lectures on Gravitation said "... The polarization of a graviton is a tensor quantity. ... we draw arrows indicating the direction to be associated with surfaces normal to the axes. In the plane perpendicular to the direction of propagation we have the two stresses ... These are the only two possible quadrupole stresses; the stresses representable by all arrows pointing towards the origin (or away from the origin) are something like a fluid pressure, which has zero spin.

The "stresses" (actually rotations) representable by all arrows pointing in a clockwise (or counter-clockwise) direction correspond to spin 1. ...

The stresses represented by ...

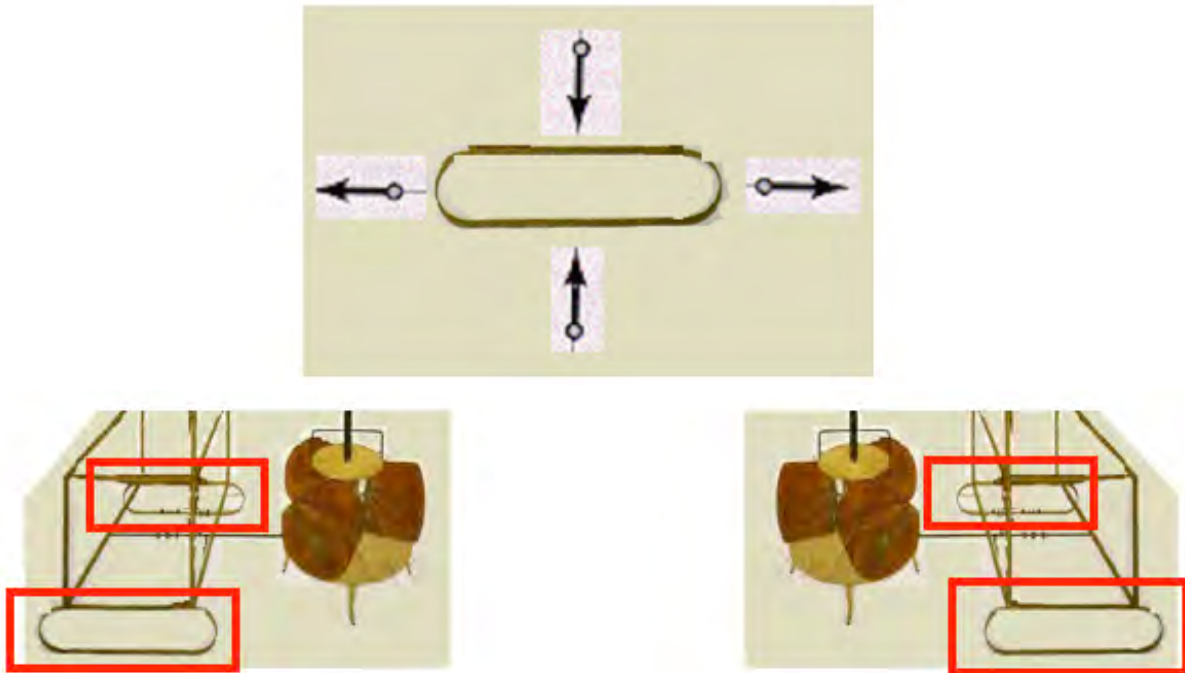

... have ... spin ... two ... a complete 360 degree rotation corresponds to two complete cycles of phase ...".

The 4 such "runners" of the TriVector part of the Large Glass + Mirror (in red boxes) correspond to a Spin-2 Bohm Quantum Potential Bohmion

One of the two M4 "runners" carries 2 of the 4 M4 components of the Bohmion. The other M4 "runner" carries the other 2 of the 4 M4 components of the Bohmion.

One of the two CP2 "runners" carries 2 of the 4 CP2 components of the Bohmion. The other CP2 "runner" carries the other 2 of the 4 CP2 components of the Bohmion.

CI(16) Vectors and BiVectors + half-Spinors and TriVectors

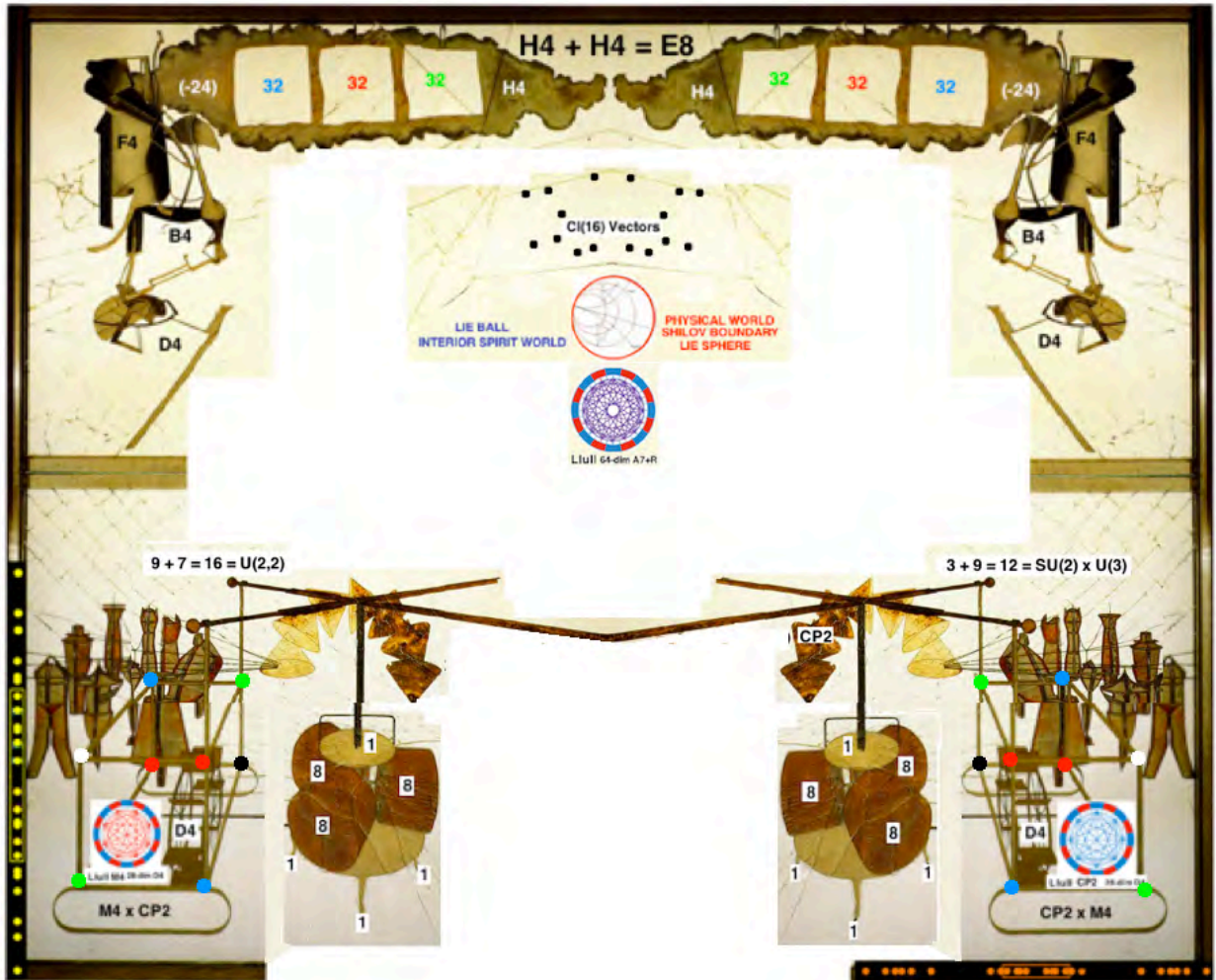

Conscious Smiling Spirit Being

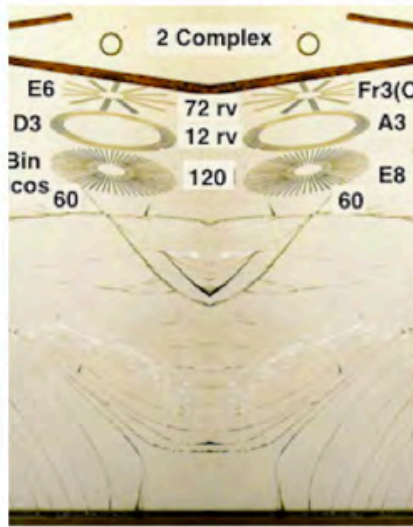

To me the Lower Central part of the Large Glass + Mirror looks like a Smiling Spirit Being with 4 pairs of circular eyes. The eyes (and eyebrow type Strings=World-Lines) are the work of Marcel Duchamp but the rest of the Smiling Spirit Being image is formed by cracks in the Glass from it being accidentally dropped by movers in Brooklyn in 1927. Therefore you might say that the Smiling Spirit Being is a product of the Spirit World, with Spirits influencing accidents.

What did Duchamp think of the Spirit World ?

John F. Moffitt in "Alchemist of the Avant-Garde the case of Marcel Duchamp" said:
 "... ... the real issue is the correct identification of "Duchamp's historical, contemporary sources or influences." ... two widely read "master-key" and "scientific" classics of fin de siècle Occultism ...[were by]... Helena Blavatsky ... and Papus ...
 between 1915 and 1923 ... the esoteric activities mutually pursued by Duchamp, Arensberg, and Dreier is what is now known as "New York Dada." ...
 One of Dreier's favorite Theosophical authors was Rudolf Steiner (1861–1925)...

[Rudolf Steiner studied the **Spirit World and how it relates to the Physical World** (Geisteswissenschaft) in building his Goetheneanum. see viXra 1810.0365]
 Steiner proclaimed ... **an Art will arise ... filled with spirit ... transcend[ing] nature.**
 Once Nature has been transcended, then, says Steiner

**"... large numbers of people will feel spiritual life to be a vital necessity,
 when spiritual life and practical life
 are finally brought into direct connection with each other. ..."**



If the 4 pairs of eyes represent 4 thoughts in the Mind of the Smiling Spirit Being, they would be

Cl(16) Vectors:
 1+1 = 2-dim Complex Numbers
 for Lie Ball Bounded Complex Domain
 of Symmetric Space $Spin(10) / Spin(8) \times U(1)$



Cl(16) TriVectors:
 $36+36 = 72$ Root Vectors of E6 automorphism group of 56-dim Fr3(O)
 that is Complexification of 27-dim J3(O)
 whose traceless part is 26-dim J3(O)o



Cl(16) BiVectors:
 $6+6 = 12$ Root Vectors of D3 = A3
 D3 contains Conformal Spin(2,4) for Gravity + Dark Energy acting on M4
 A3 = SU(4) contains SU3 acting on CP2 = SU(3) / SU(2)xU(1)



Cl(16) BiVectors and half-Spinors:
 $60+60 = 120$ Binary Icosahedral Group
 in McKay Correspondence with E8



Jennie Louise Cain in her 2016 U. Michigan Ph.D. thesis says:
 "... Rudolf Steiner (1861-1925) ... was the founder of Anthroposophy, a philosophy and spiritual movement whose aim ... is to develop supersensible capacities that enable access to what Steiner described as a spiritual dimension underlying all of life ... Steiner argues that the loss of original clairvoyant capacities ... of ... the ancient ... culture ... was necessary for the development of intellectualism ... "Geisteswissenschaft" ... is the re-awakening of a spiritual awareness ... Steiner ... regards ...the ancient Egyptians ... as oriented toward connection and interaction with the outer world, and ... the greater astronomical cosmos ...
 ...
 the age of the Egyptian pyramids [was] the time of development of the "Empfindungsseele" ... the ability to experience the outer world internally ...
The pyramid itself is ... a large, sensing organ (an "Empfindungsorgan") that picks up the relationship of the earth culture as a whole to the cosmos ...".

Physics of the Cosmos is based on 65,536-dim Cl(16) Clifford Algebra

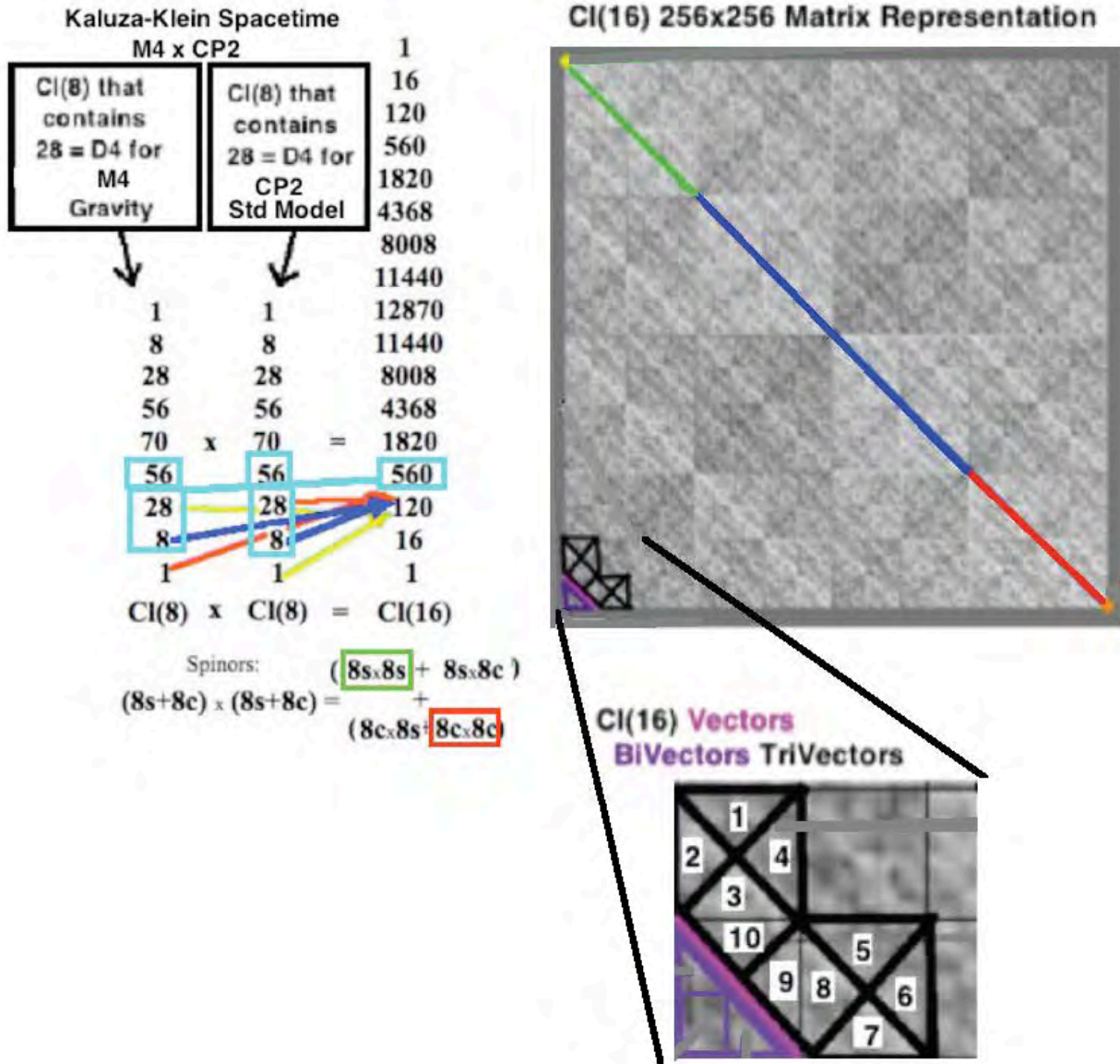

Earth culture is based on Human Quantum Consciousness of Microtubules = 40 micron size aggregates of 65,536 Tubulin Dimers.

Assembly of 65,536 tubulins into a 40-micron microtubule can be seen to be analogous to the Real Clifford Algebra $Cl(16) = 256 \times 256$ tensor product $Cl(8) \times Cl(8)$ where one 256-dim $Cl(8)$ represents Conformal Gravity+Dark Energy with F_{4gde} related to the Minkowski M_4 of Kaluza-Klein $M_4 \times CP_2$ and the other $Cl(8)$ represents Standard Model $U(1) SU(2) SU(3)$ with F_{4sm} related to the $CP_2 = SU(3) / SU(2) \times U(1)$ of Kaluza-Klein $M_4 \times CP_2$.

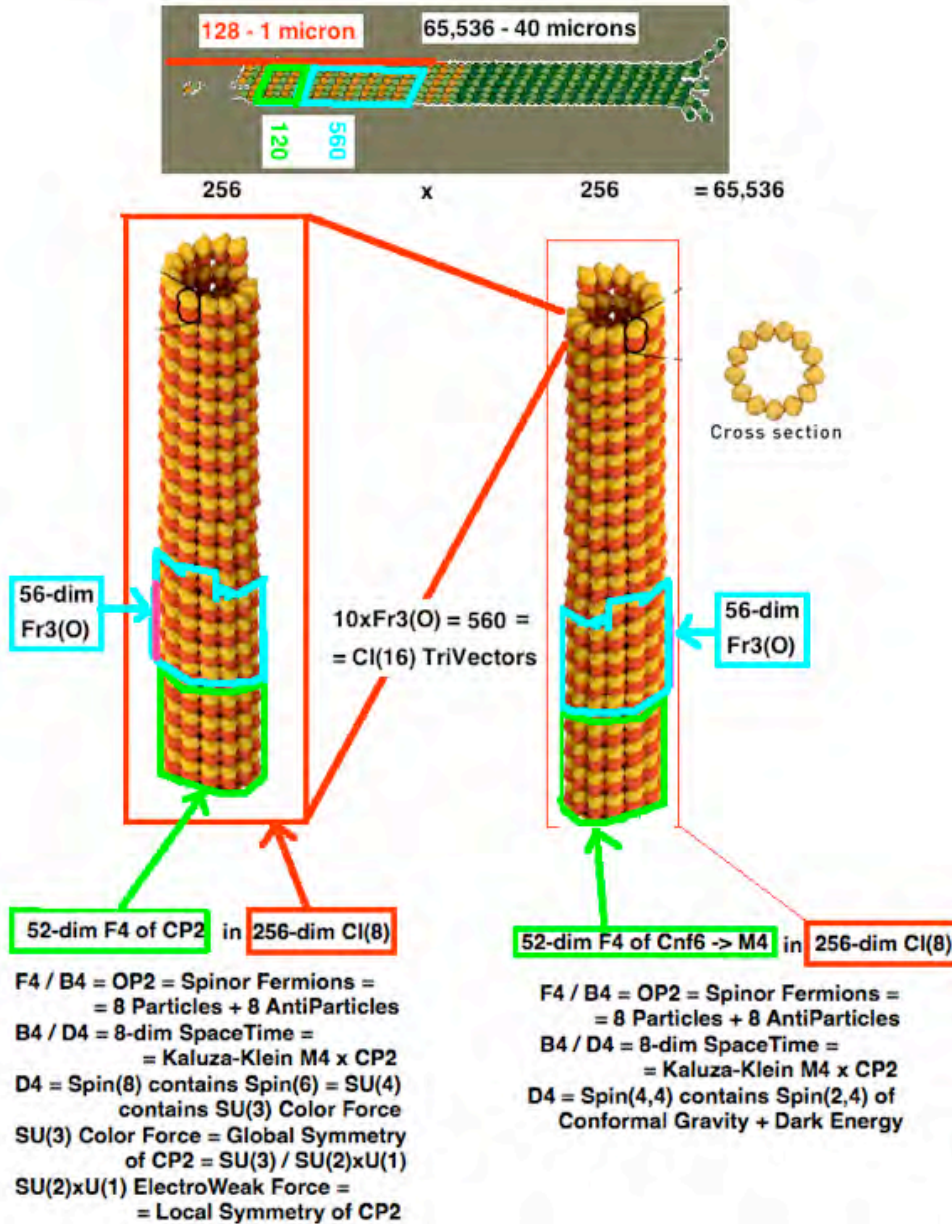

The Earth Culture sees its relationship to the Cosmos as being reflected in the structures of the Giza Pyramids and Sphinx.

After the victories of Alexander the Great, his friend, historian, and general Ptolemy Iruled Egypt and its cultural center Alexandria and commissioned Manetho to document history which history included:

36,525 years ago - North Star Vega - Humans migrated up the Nile River to Giza where they built two large Pyramids - each representing CI(8) whose 8 Vectors + 28 BiVectors + 16 Spinors = F4 Lie Algebra one for F4gde = Conformal Gravity + Dark Energy

one for F4sm = Standard Model
 and
 the Sphinx - representing $Cl(16) = Cl(8) \times Cl(8)$
 whose 120 BiVectors + 128 half-Spinors = E8 = Lagrangian
 and
 whose 560 TriVectors = 10 copies of $Fr3(O) = 26D$ World-Line-String Theory

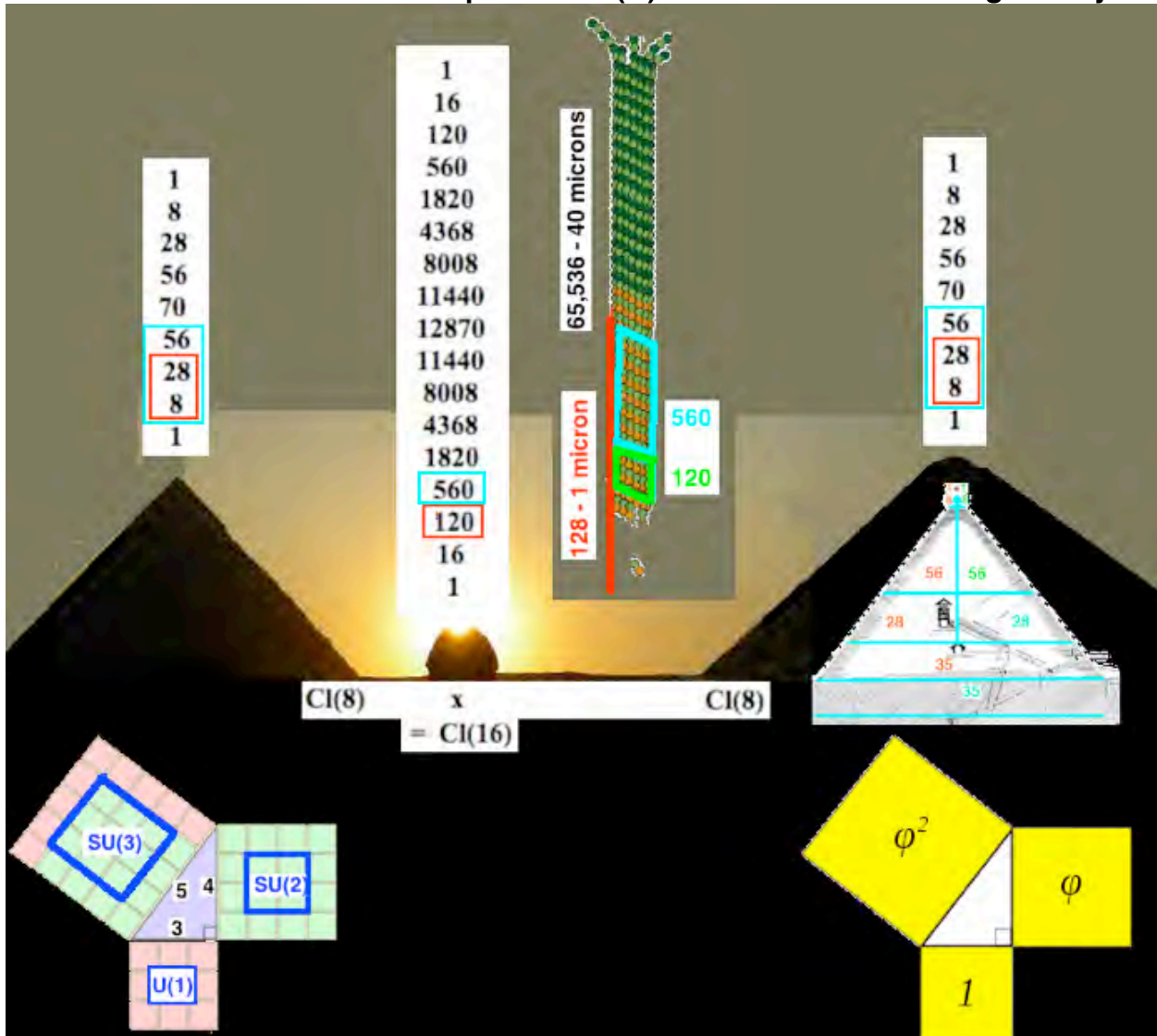

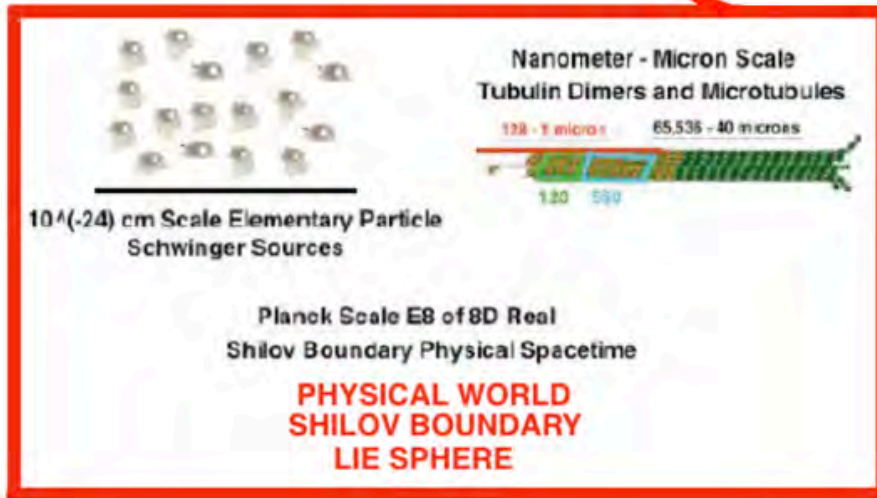
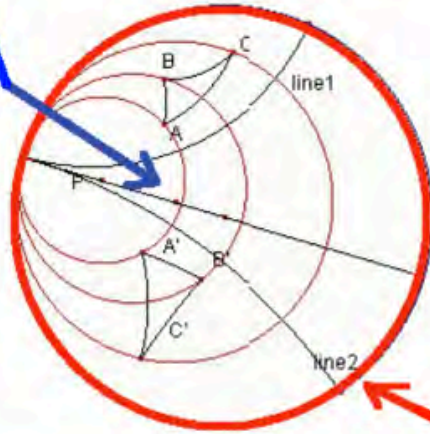

Rudolf Steiner, in Cosmic Memory, said "... The Fourfold Man ... consists of ... the physical body, the ether ... body, the astral body and the " I " ...".

Physical Body is constructed of 40-micron Microtubules = 65,536 Tubulins
 Ether Body is Information coded in the 64,712 Information Tubulins of the Microtubule
 Astral Body is 26D World-Line Theory Lattice Cell with 65,536-dim $Cl(16)$ Symmetry
 " I " is Information encoded in the 64,712 Information elements per Lattice Cell

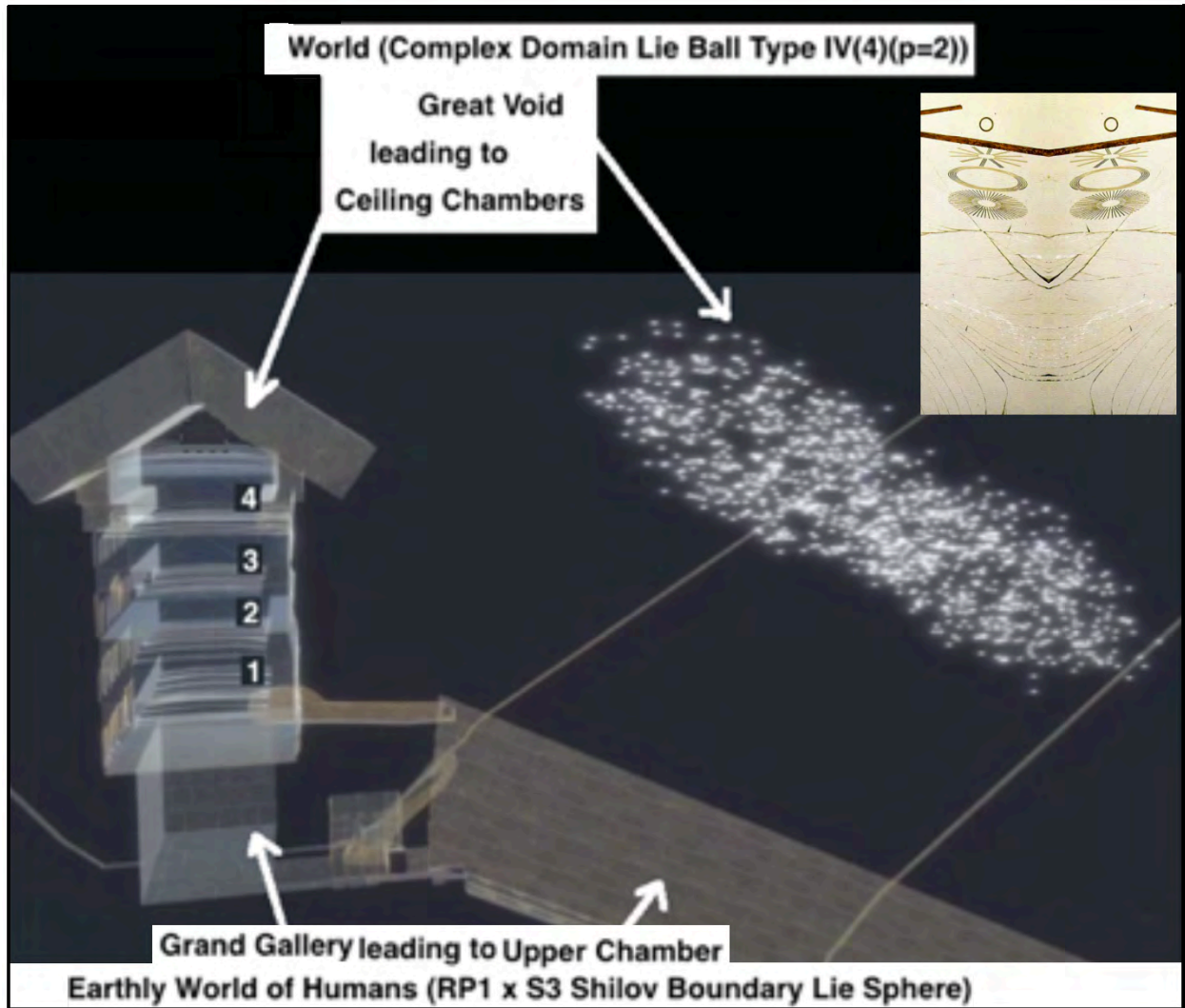

The Builders of the Great Pyramid represented the Real Shilov Boundary Physical world by the Grand Gallery and Upper Chamber that are easily accessible by Humans with Microtubule Quantum Consciousness and they represented the Imaginary Complex World of C(16) Spacetime Cells mirroring the Human Microtubule World as Ceiling Chamber spaces and the Great Void that are more accessible to Souls of the Spirit World than to Physical Humans.



The Spirit Being  is made up of glass-break lines from Brooklyn movers accidentally dropping the Large Glass, and so a Spiritual Being of Spiritual Art, and so also belongs to the Spiritual Realm of Music.

CI(16) Vectors and BiVectors + half-Spinors and TriVectors and Conscious Smiling Spirit Being

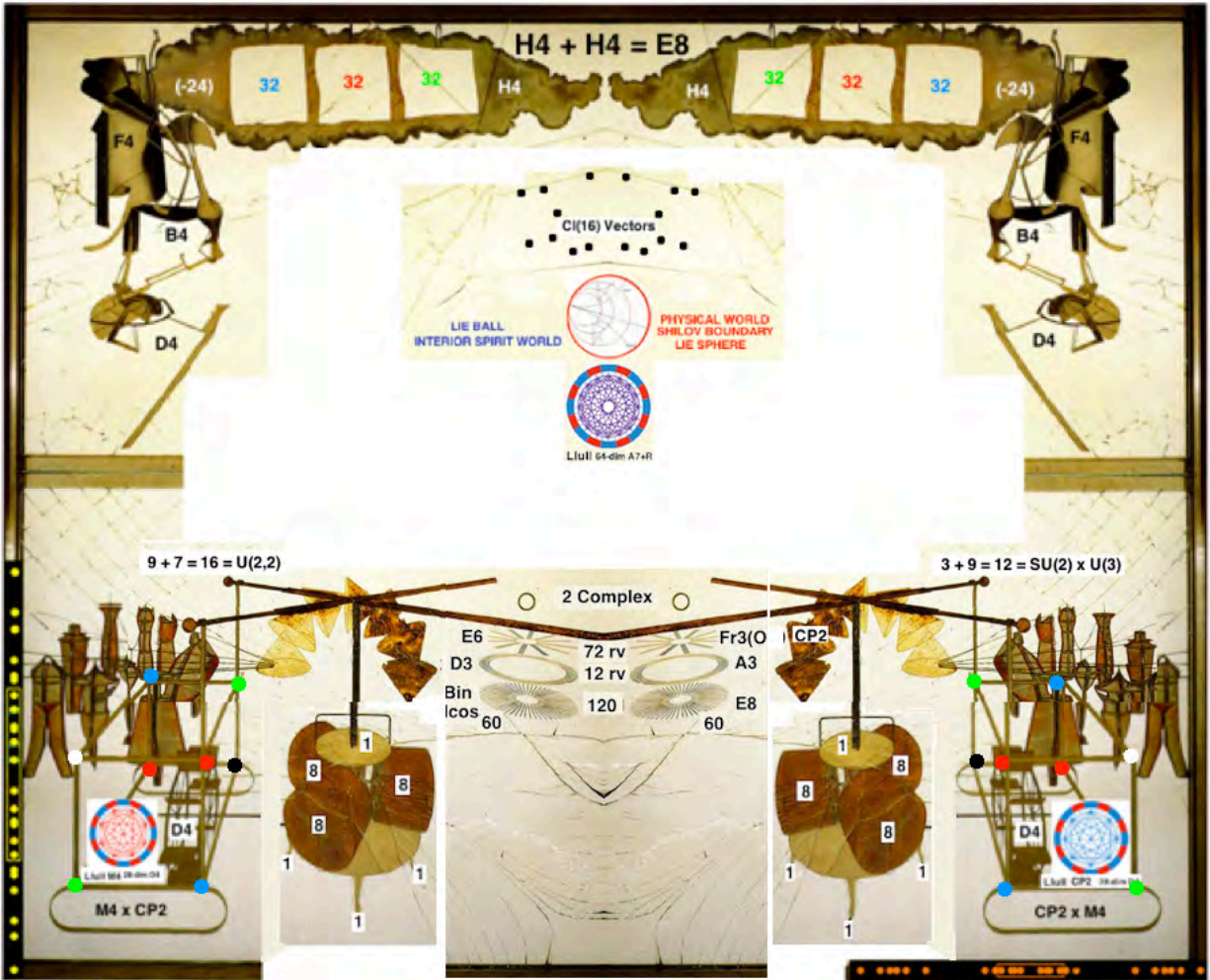

CI(16) Lagrangian

Here is the CI(16) Lagrangian written in terms of E8 Root Vectors and CI(16) structure:



The **Base Manifold** is the 8-dim **Shilov Boundary** of the 16-dim **CI(16) Vectors**

The **Vector space** is the **Lie Ball Spin(10) / Spin(8) x U(1)**
and the **Shilov Boundary** is the **Lie Sphere RP1 x S7** with Octonionic structure

The **Lagrangian Density** terms are based on the structure of E8 =
= **CI(16) BiVectors + half-Spinors**

E8 / D8 = 128-dim half-spinors of CI(16) = Fermion Particles and AntiParticles

D8 / D4xD4 = A7+R creation / annihilation operators for 8-dim Spacetime

D4 = 28 Spin(8) generators acting as 8-dim gauge bosons

D4 = 28 Spin(8) generators acting as 8-dim gauge bosons

The following page is a larger image of the Lagrangian

which page is followed by more details about the Base Manifold and the Density.

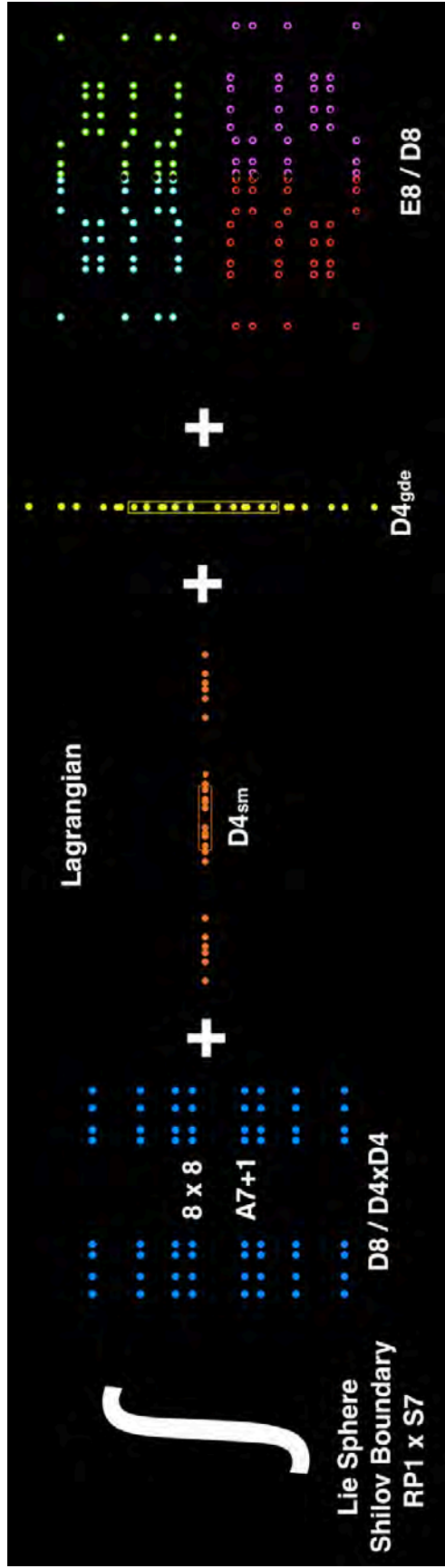

Base Manifold

The **Base Manifold** is the 8-dim Shilov Boundary of the 16-dim Vector space of $Cl(16)$.

The **Vector space is the Lie Ball $Spin(10) / Spin(8) \times U(1)$**
 and the **Shilov Boundary is the Lie Sphere $RP^1 \times S^7$** with Octonionic structure
 1-dim Real Part $Re(O)$ + 7-dim Imaginary Part $Im(O)$ so

Since $Im(O)$ contains a 3-dim associative submanifold
 plus an orthogonal 4-dim coassociative submanifold
 the 8-dim base manifold is made up of two 4-dim parts:

Associative = $Re(O)$ + Associative Submanifold of $Im(O)$
 Coassociative = Coassociative Submanifold of $Im(O)$

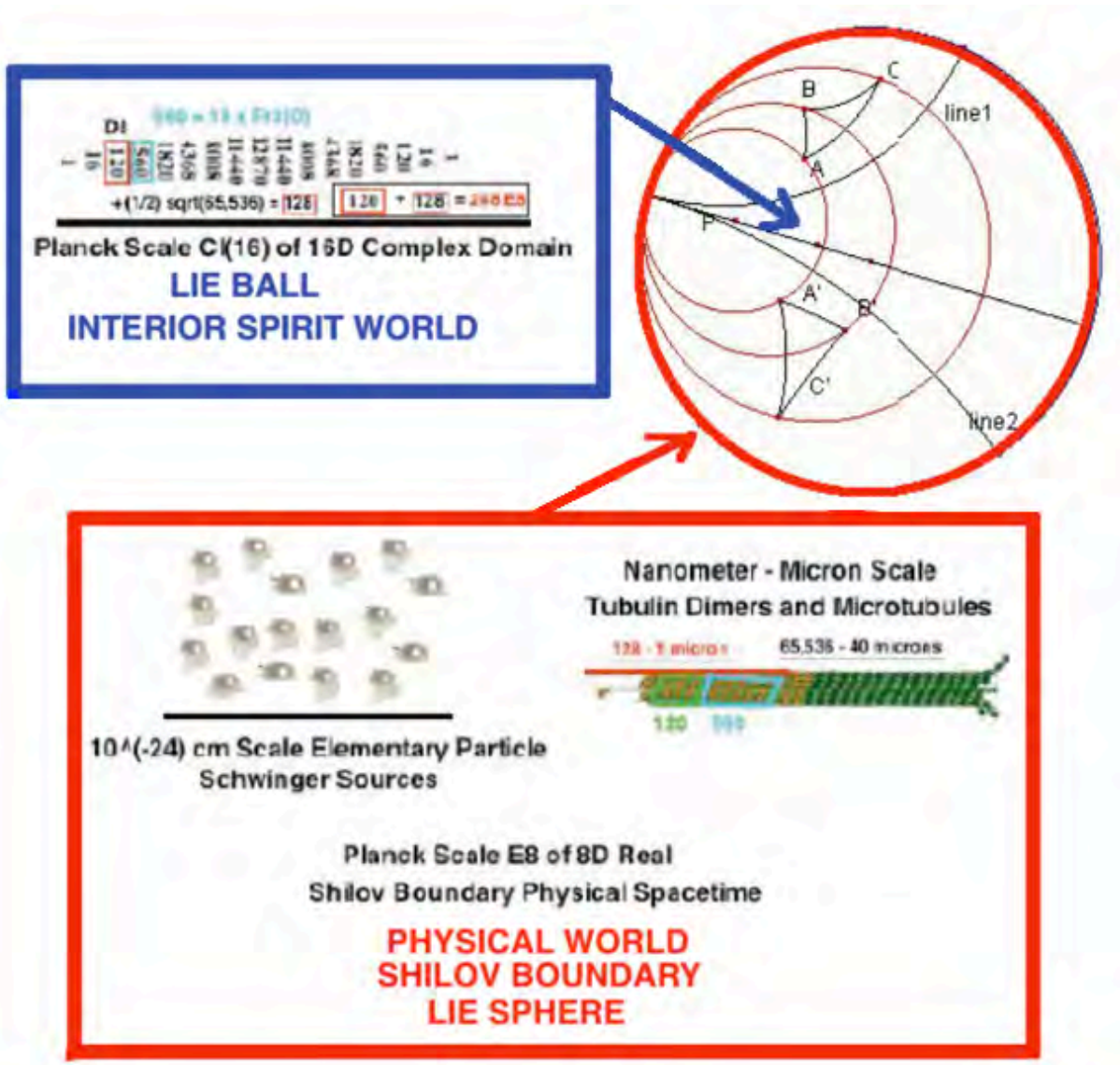

Lagrangian Density



The 10 dimensions of the Vector Space of Spin(10) account for 10 of the 26 dimensions of 26D String=World-Line Theory. 8 of those 10 dimensions, the Shilov Boundary, are Octonionic 8-dim Spacetime that becomes Quaternionic $M4 \times CP2$ Kaluza-Klein at low (relative to Planck) energies.

The $26-10 = 16$ dimensions correspond to orbifold representations of 8 First-Generation Fermion Types: 8 Particles + 8 Antiparticles each with 8 components.

They give the **Lagrangian Density terms labelled E8 / D8**

Weinberg showed in Dirac lecture: each fermion has weight $7/2$ in the 8-dim Lagrangian

The **Lagrangian Density terms labelled D4gde** are the 24 Root Vectors of one of the two 28-dim D4 acting as 8-dim gauge bosons.

Weinberg showed in Dirac lecture: each gauge boson has weight 1 in the Lagrangian

The **Lagrangian Density terms labelled D4sm** are the 24 Root Vectors of the other of the two 28-dim D4 acting as 8-dim gauge bosons.

Weinberg showed in Dirac lecture each gauge boson has weight 1 in the Lagrangian

Since **$(8+8)$ fermions $\times 7/2 = 56 = 28$ gauge bosons $\times 1 + 28$ gauge bosons $\times 1$** there is a subtle fermion-gauge boson supersymmetry leading to ultraviolet finiteness.

The **Lagrangian Density terms labelled D8 / D4xD4** are $8 \times 8 = 64$ dimensions = $= 8$ Fermion Types \times (8 Octonion Basis Elements = 8 E8 Lattices)
 There are 8 algebraically independent E8 Lattices, 7 of which are Integral Domains corresponding to the 7 Imaginary Octonions and to the 7 massive Fermion Types and 1 of which corresponds to the Real Octonion Axis and to Neutrino-Type Fermions which are tree-level-massless.
 The physical 8-dim Octonionic Spacetime is a Superposition of those 8 E8 Lattices in which each Fermion Type propagates in its own E8 Lattice.

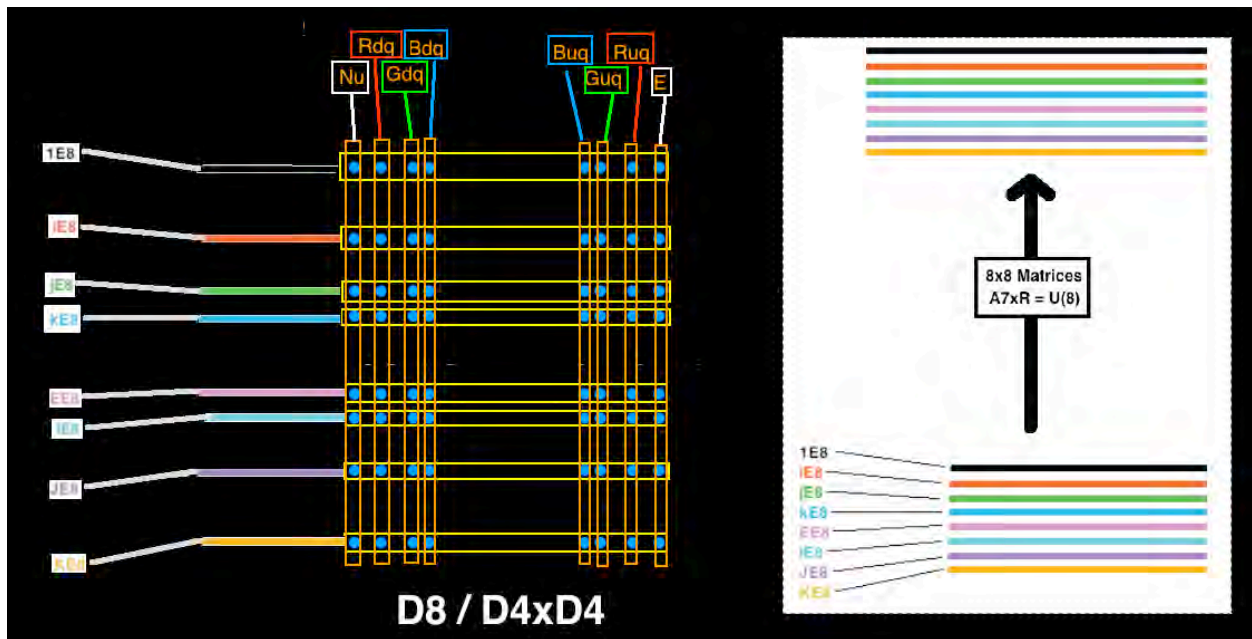

The $8 \times 8 = 64$ -element D8 / D4xD4 structure is $A7+R = SL(R,8) + 1$
 which is the grade-0 part of the Heisenberg Algebra = Maximal Contraction of E8
 with graded structure $28 + 64 + (A7+1) + 64 + 28$
 The $28 + 64 + 64 + 28$ part is already in the Lagrangian
 as creation / annihilation operators for gauge bosons and fermions.
 The $A7+1$ part is creation / annihilation operators for spacetime and
 equivalently $A7 = SL(R,8)$ describes a Unimodular Gravity-like structure of Spacetime

Octonionic to Quaternionic Transition at End of Inflation

To make contact with conventional physics see what happens at the End of Inflation when Octonionic Structure is broken to Quaternionic.

First the Base Manifold goes from Octonionic Lie Sphere Shilov Boundary $RP1 \times S7$

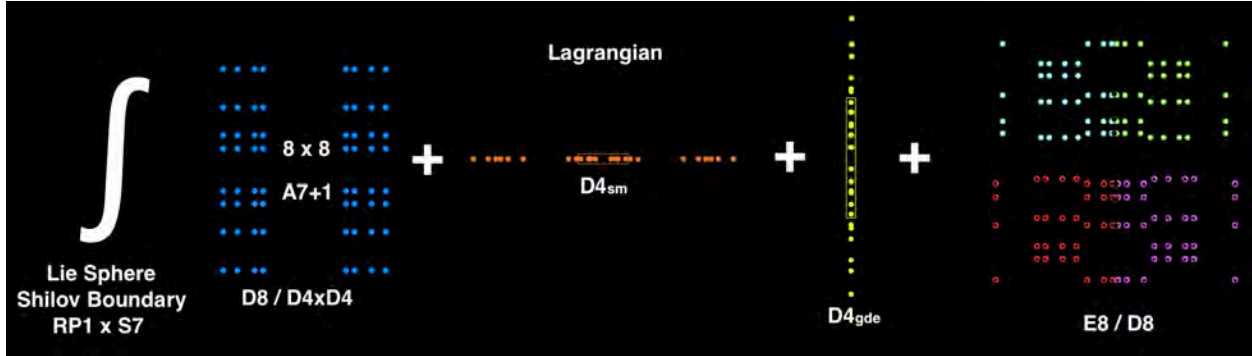

to Quaternionic $M4 \times CP2$ with $M4 =$ Lie Sphere Shilov Boundary $RP1 \times S3$
and $CP2 = SU(3) / SU(2) \times U(1)$



which causes the 8 algebraically independent Octonionic $E8$ Lattices = $D+8$ Lattices to collapse into one Quaternionic $D+4$ Hyperdiamond Lattice = $Z4$ Lattice the even vertices of which are a $D4$ Lattice = Integral Quaternions

(Note that in the $D+4$ Lattice each power-of-2 layer of norm 2^n has 24 vertices whereas the $E8$ Lattices has not that periodicity.)

so that the $D8 / D4 \times D4$ term in the 8-dim Lagrangian goes away

Then the Octonionic base manifold splits into its Associative and Coassociative parts as Kaluza-Klein $M4 \times CP2$ which geometrically produces the Higgs and the Second and Third Generations of fermions as shown on the following page:

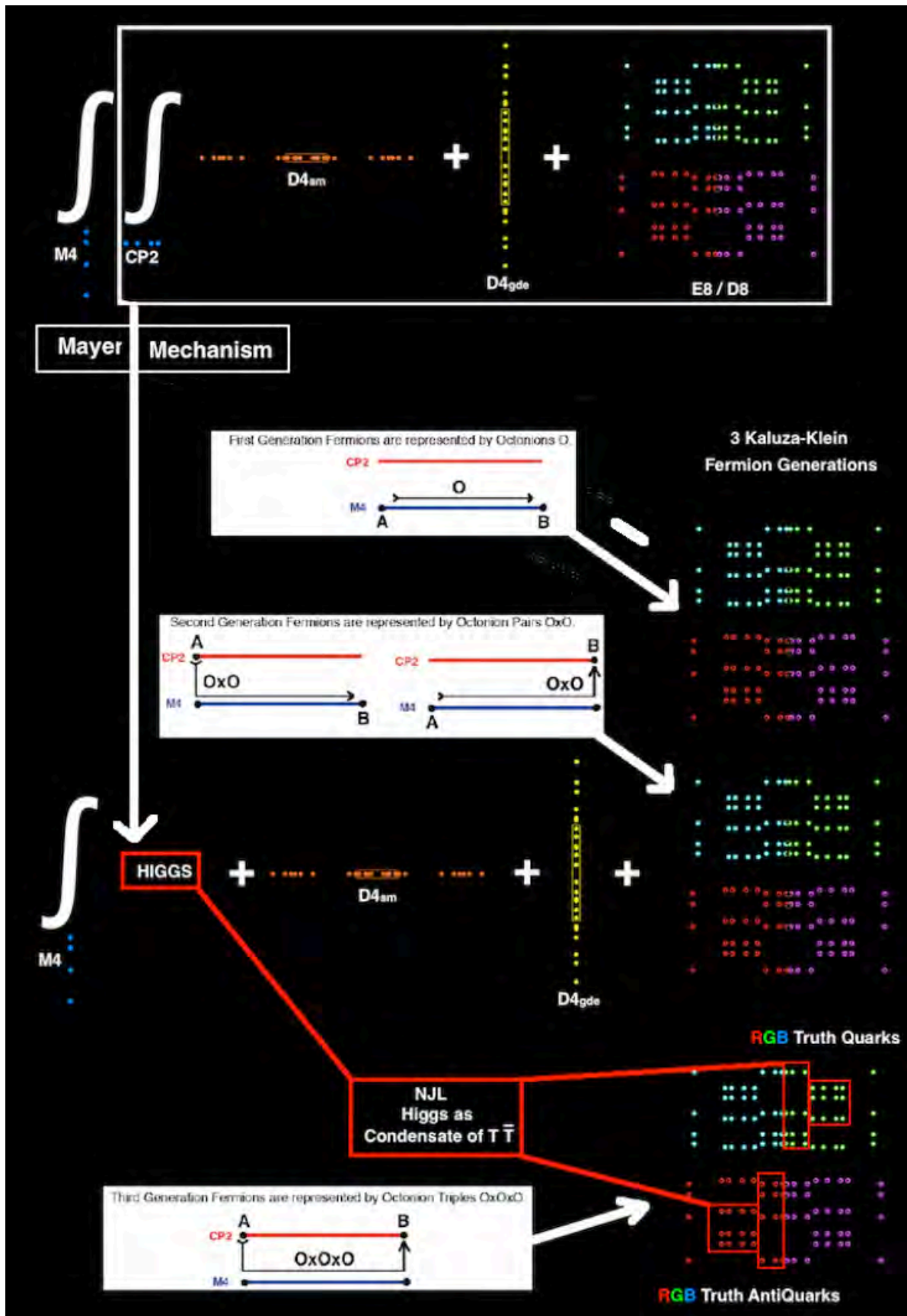

Two D4 of D8 / D4xD4 M4 for Gravity+Dark Energy and CP2 for Standard Model

By 8-Periodicity for Real Clifford Algebras $Cl(16) = \text{tensor product } Cl(8) \times Cl(8)$.
Each of the two $Cl(8)$ contains one of the two D4 of D8 / D4xD4 in E8.

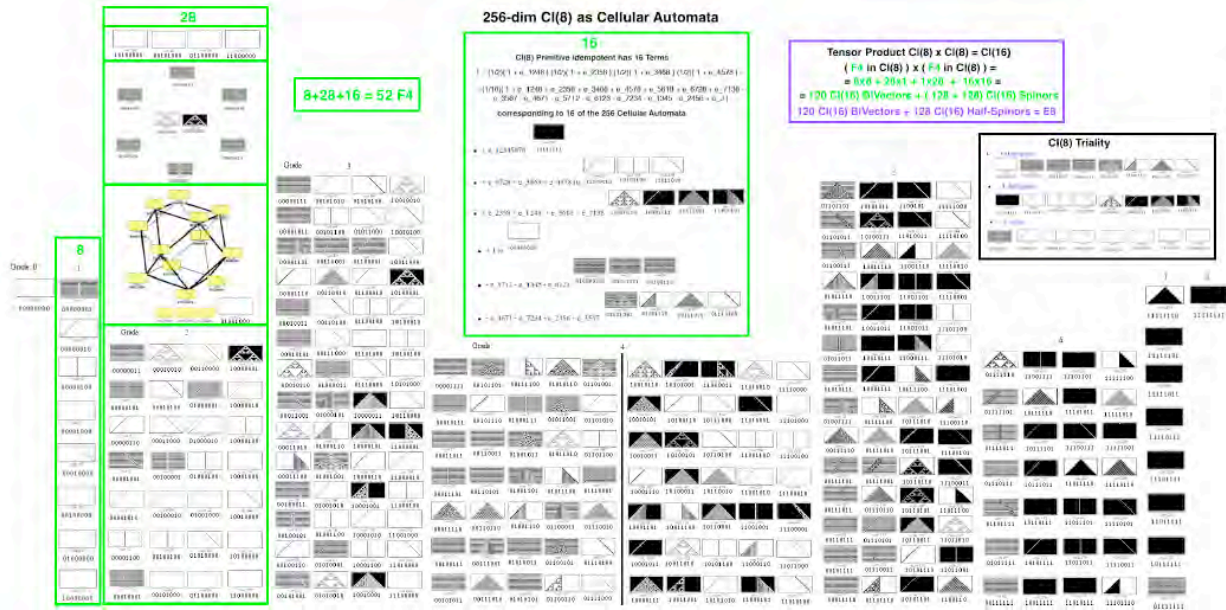

The 256 Elementary Cellular Automata correspond to the 256-dim $Cl(8)$ Clifford Algebra with graded structure 1 8 28 56 (35+35=70) 56 28 8 1
The 28 BiVectors have clear physical interpretation as Ghosts plus Gauge Bosons of Gravity+Dark Energy (16) and of the Standard Model (12)

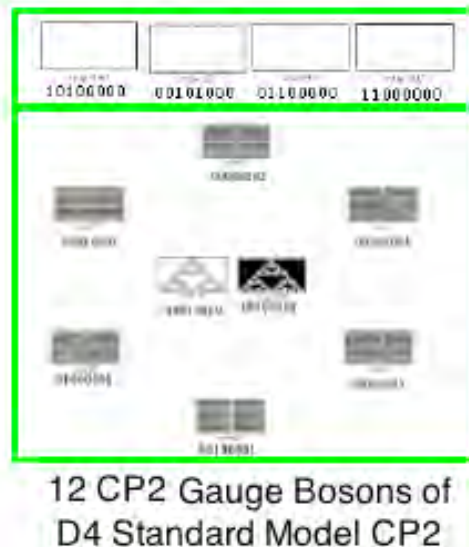

D4 of M4 and Gravity+Dark Energy

Then one of the two D4 Spin(8) is forced to act primarily on the M4 with 16 of its 28 generators being gauge bosons of Gravity+Dark Energy and the other 12 playing reduced role of Standard Model ghosts

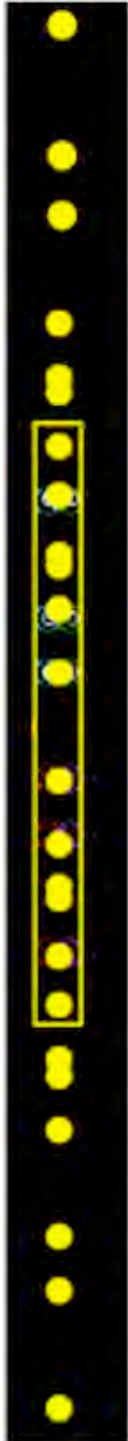

The 24 Yellow Root Vectors of the D4 of E8 Gravity + Standard Model Ghosts are on the Vertical Y-axis.

The 4 Cartan Subalgebra elements of D4 of E8 Gravity + Standard Model Ghosts correspond to half of the 8 Cartan Subalgebra elements of E8.

In the Initial and Inflation Octonionic Phases of Our Universe

the 24+4 = 28 generators of D4 of E8 Gravity + Standard Model Ghosts act as a Spin(8) Gauge Group rotating all 8 dimensions of Octonionic Spacetime into each other.

In the Post-Inflation Quaternionic Phase of Our Universe

8-dim Octonionic Spacetime splits into (4+4)-dim M4 x CP2 Kaluza-Klein Spacetime
12 generators in the Yellow Box represent the 12 Root Vectors of the Conformal Gauge Group SU(2,2) = Spin(2,4) of Conformal Gravity + Dark Energy

The 4 Cartan Subalgebra elements of SU(2,2)xU(1) = U(2,2) correspond to the 4 Cartan Subalgebra elements of D4 of E8 Gravity + Standard Model Ghosts and to the other half of the 8 Cartan Subalgebra elements of E8.

The other 24-12 = 12 Yellow Root Vectors represent Ghosts of 12D Standard Model whose Gauge Groups are SU(3) SU(2) U(1)

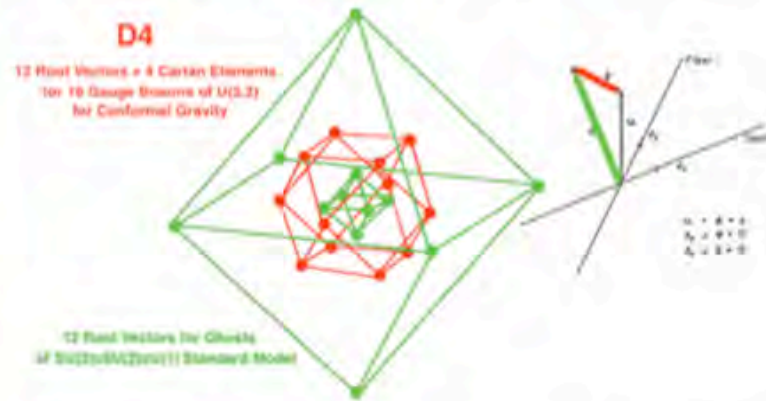

Gravity and Dark Energy come from D4 Conformal Subgroup SU(2,2) = Spin(2,4)

SU(2,2) = Spin(2,4) has 15 generators:

1 Dilation representing Higgs Ordinary Matter

4 Translations representing Primordial Black Hole Dark Matter

10 = 4 Special Conformal + 6 Lorentz representing Dark Energy
(see Irving Ezra Segal, "Mathematical Cosmology and Extragalactic Astronomy" (Academic 1976))

The basic ratio Dark Energy : Dark Matter : Ordinary Matter = 10:4:1 = 0.67 : 0.27 : 0.06
When the dynamics of our expanding universe are taken into account, the ratio is calculated to be **0.75 : 0.21 : 0.04**

D4 of CP2 and Standard Model

The other D4 Spin(8) is forced to act primarily on the CP2 with 12 of its 28 generators being gauge bosons of Standard Model and the other 16 playing reduced role of Gravity+Dark Energy ghosts. Since CP2 = SU(3) / SU(2)xU(1) the Color SU(3) acts as a conventional gauge group but the ElectroWeak SU(2)xU(1) of CP2 acts as torsion which accounts for its chirality. The 24 Orange Root Vectors of the D4 of E8 Standard Model + Gravity Ghosts are on the Horizontal X-axis.

The 4 Cartan Subalgebra elements of D4 of E8 Standard Model + Gravity Ghosts correspond to half of the 8 Cartan Subalgebra elements of E8.

In the Initial and Inflation Octonionic Phases of Our Universe

the 24+4 = 28 generators of D4 of E8 Standard Model + Gravity Ghosts act as a Spin(8) Gauge Group rotating all 8 Fermion types into each other.



In the Post-Inflation Quaternionic Phase of Our Universe

8-dim Octonionic Spacetime splits into (4+4)-dim M4 x CP2 Kaluza-Klein Spacetime. 8 generators in the Orange Box represent the 8 Root Vectors of the Standard Model Gauge Groups SU(3) SU(2) U(1). Their 4 Cartan Subalgebra elements correspond to the 4 Cartan Subalgebra elements of D4 of E8 Standard Model + Gravity Ghosts and to half of the 8 Cartan Subalgebra elements of E8. The other 24-8 = 16 Orange Root Vectors represent Ghosts of 16D U(2,2) which contains the Conformal Group Spin(2,4) that produces Gravity + Dark Energy by the MacDowell-Mansouri mechanism. Standard Model Gauge groups come from CP2 = SU(3) / SU(2) x U(1) (as described by Batakis in Class. Quantum Grav. 3 (1986) L99-L105)

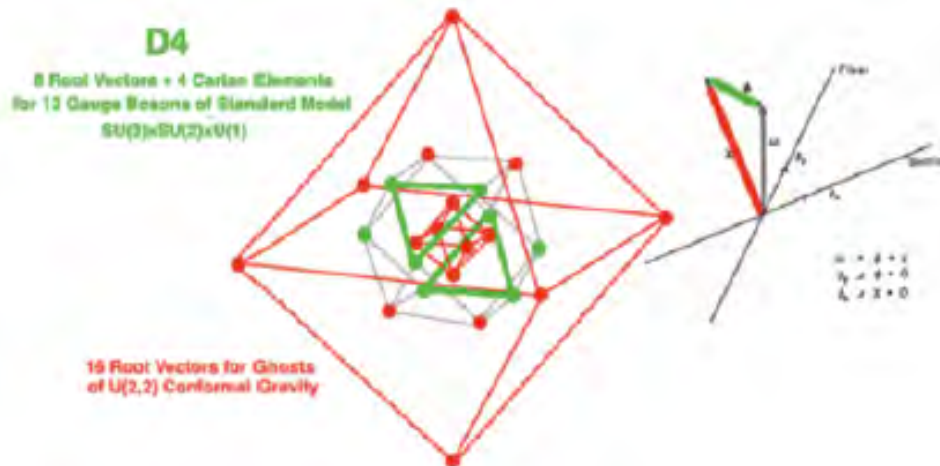

The 24-8 = 16 D4 of CP2 Root Vectors represent Ghosts of U(2,2) Conformal Gravity. Jean Thierry-Mieg in J. Math. Phys. 21 (1980) 2834-2838 said: "... The ghost and the gauge field: The single lines represent a local coordinate system of a principal fiber bundle of base space-time. The double lines are 1 forms. The connection of the principle bundle w is assumed to be vertical. Its contravariant components Φ^i and X are recognized ... as the Yang-Mills gauge field and the Faddeev-Popov ghost form ..."

Schwinger Sources and Calculations of Force Strengths, Particle Masses, etc

When a fermion particle/antiparticle appears in E8 spacetime it does not remain a single Planck-scale entity because **Tachyons create a cloud of particles/antiparticles**. The cloud is one Planck-scale Fundamental Fermion Valence Particle plus an effectively neutral cloud of particle/antiparticle pairs forming a Kerr-Newman black hole. That cloud constitutes the **Schwinger Source**. Its structure comes from the **24-dim Leech lattice part of the Monster Group which is**

$2^{(1+24)}$ times the double cover of Co1, for a total order of about 10^{26} .

Since a Leech lattice is based on copies of an E8 lattice and since there are 7 distinct E8 integral domain lattices there are 7 (or 8 if you include a non-integral domain E8 lattice) distinct Leech lattices. The physical Leech lattice is a superposition of them, effectively adding a factor of 8 to the order.

The volume of the Kerr-Newman Cloud is on the order of 10^{27} x Planck scale, so the Kerr-Newman Cloud **Source should contain about 10^{27} particle/antiparticle pairs and its size should be about $10^{(27/3)} \times 1.6 \times 10^{(-33)}$ cm = roughly $10^{(-24)}$ cm.**

Fock "Fundamental of Quantum Mechanics" (1931) showed that it requires Linear Operators "... represented by a definite integral [of a]... kernel ... function ...".

Hua "Harmonic Analysis of Functions of Several Complex Variables in the Classical Domains" (1958) showed Kernel Functions for Complex Classical Domains.

Schwinger (1951 - see Schweber, PNAS 102, 7783-7788) "... introduced a description in terms of Green's functions, what Feynman had called propagators ... The Green's functions are vacuum expectation values of time-ordered Heisenberg operators, and the field theory can be defined non-perturbatively in terms of these functions ...[which]... gave deep structural insights into QFTs; in particular ... the structure of the Green's functions when their variables are analytically continued to complex values ...".

Wolf (J. Math. Mech 14 (1965) 1033-1047) showed that the Classical Domains (complete simply connected Riemannian symmetric spaces) representing 4-dim Spacetime with Quaternionic Structure are:

$S^1 \times S^1 \times S^1 \times S^1 = 4$ copies of **U(1)**

$S^2 \times S^2 = 2$ copies of **SU(2)**

$CP^2 =$ **SU(3)** / $SU(2) \times U(1)$

$S^4 = Spin(5)$ / $Spin(4) =$ Euclidean version of **Spin(2,3)** / $Spin(1,3)$

Armand Wyler (1971 - C. R. Acad. Sc. Paris, t. 271, 186-188) showed how to use **Green's Functions = Kernel Functions** of Classical Domain structures characterizing **Sources = Leptons, Quarks, and Gauge Bosons, to calculate Particle Masses and Force Strengths**

Cl(16) Physics constructs the **Lagrangian** integral such that the **mass m emerges as the integral over the Schwinger Source spacetime region** of its Kerr-Newman cloud of virtual particle/antiparticle pairs plus the Valence Fermion so that the volume of the Schwinger Source fermion defines its mass, which, being dressed with the particle/antiparticle pair cloud, gives **quark mass as constituent mass**.

Armand Wyler used Harmonic Geometry to calculate:

Fermion masses as a product of four factors:

$$V(Q\text{fermion}) \times N(\text{Graviton}) \times N(\text{octonion}) \times \text{Sym}$$

$V(Q\text{fermion})$ is the volume of the part of the half-spinor fermion particle manifold $S^7 \times RP^1$ related to the fermion particle by photon, weak boson, or gluon interactions.

$N(\text{Graviton})$ is the number of types of Spin(0,5) graviton related to the fermion.

$N(\text{octonion})$ is an octonion number factor relating up-type quark masses to down-type quark masses in each generation.

Sym is an internal symmetry factor, relating 2nd and 3rd generation massive leptons to first generation fermions. It is not used in first-generation calculations.

Force Strengths are made up of two parts:

- the relevant spacetime manifold of gauge group global action
- the U(1) photon sees 4-dim spacetime as $T^4 = S^1 \times S^1 \times S^1 \times S^1$
- the SU(2) weak boson sees 4-dim spacetime as $S^2 \times S^2$
- the SU(3) weak boson sees 4-dim spacetime as CP2
- the Spin(5) of gravity sees 4-dim spacetime as S^4

and

the volume of the Shilov boundary corresponding to the symmetric space with local symmetry of the gauge boson. The nontrivial Shilov boundaries are:

- for SU(2) Shilov = $RP^1 \times S^2$
- for SU(3) Shilov = S^5
- for Spin(5) Shilov = $RP^1 \times S^4$

Schwinger Sources as described above are continuous manifold structures of Bounded Complex Domains and their Shilov Boundaries but the E8-Cl(16) model at the Planck Scale has spacetime condensing out of Clifford structures forming a Lorentz Leech lattice underlying 26-dim String Theory of World-Lines with $8 + 8 + 8 = 24$ -dim of fermion particles and antiparticles and of spacetime.

The automorphism group of a single 26-dim String Theory cell modulo the Leech lattice is the Monster Group of order about 8×10^{53} .

The problem of the determination of the quark masses is not trivial. We can define as a “current” quark mass the mass entering in the Lagrangian (or Hamiltonian) representation of a hadron; this comes out to be of the order of some MeV/c^2 for u, d quarks, and $\sim 0.2 \text{GeV}/c^2$ for s quarks. However, the strong field surrounds the quarks in such a way that they acquire a “constituent” (effective) mass including the equivalent of the color field; this comes out to be of the order of some $300 \text{MeV}/c^2$ for u, d quarks, and $\sim 0.5 \text{GeV}/c^2$ for s quarks. Current quark masses are almost the same as constituent quark mass for heavy quarks. Alessandro De Angelis · Mário Pimenta

Introduction to Particle and Astroparticle Physics Second Edition

Wyler Force Strength and Mass Calculation
 Details are in viXra 1810.0365

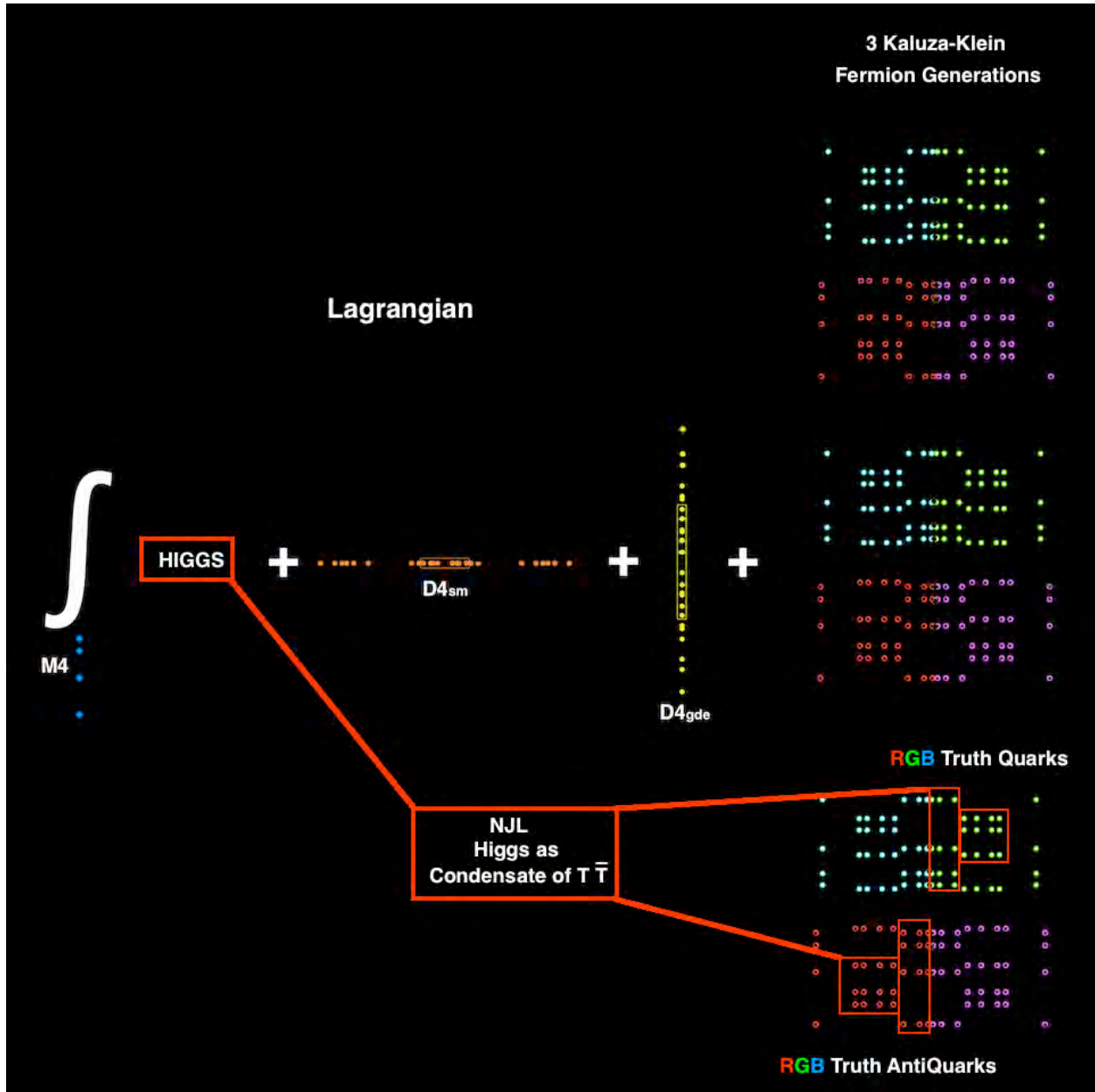

The E8 model constructs the Lagrangian integral such that the mass m emerges as the integral over the Schwinger Source spacetime region of its Kerr-Newman cloud of virtual particle/antiparticle pairs plus the valence fermion so that the volume of the Schwinger Source fermion defines its mass, which, being dressed with the particle/antiparticle pair cloud, gives quark mass as constituent mass.

Fermion Schwinger Sources correspond to the Lie Sphere Symmetric space
 $Spin(10) / Spin(8) \times U(1)$

with Bounded Complex Domain D_8 of type IV8 and Shilov Boundary $Q_8 = RP^1 \times S^7$ which has local symmetry of the $Spin(8)$ gauge group from which the first generation spinor fermions are formed as **+half-spinor** and **-half-spinor** spaces

For the Gauge Gravity and Standard Model Gauge Bosons the process of breaking Octonionic 8-dim SpaceTime down to Quaternionic (4+4)-dim M4 x CP2 Kaluza-Klein creates differences in the way gauge bosons "see" 4-dim Physical SpaceTime. There are 4 equivalence classes of 4-dimensional Riemannian Symmetric Spaces with Quaternionic structure consistent with 4-dim Physical SpaceTime:

S_4 = 4-sphere = Spin(5) / Spin(4) where Spin(5) = Schwinger-Euclidean version of the Anti-DeSitter subgroup of the Conformal Group that gives [MacDowell-Mansouri Gravity](#)

CP_2 = complex projective 2-space = SU(3) / U(2) with [the SU\(3\) of the Color Force](#)

$S_2 \times S_2$ = SU(2)/U(1) x SU(2)/U(1) with two copies of [the SU\(2\) of the Weak Force](#)

$S_1 \times S_1 \times S_1 \times S_1$ = U(1) x U(1) x U(1) x U(1) = 4 copies of [the U\(1\) of the EM Photon](#) (1 copy for each of the 4 covariant components of the Photon)

The Gravity Gauge Bosons (Schwinger-Euclidean versions) live in a Spin(5) subalgebra of the Spin(6) Conformal subalgebra of D4 = Spin(8). They "see" M4 Physical spacetime as the 4-sphere S4 so that their part of the Physical Lagrangian is

\int Gravity Gauge Boson Term

S4 .

an integral over SpaceTime S4.

The Schwinger Sources for GRb bosons are the Complex Bounded Domains and Shilov Boundaries for Spin(5) MacDowell-Mansouri Gravity bosons.

However, due to Stabilization of Condensate SpaceTime

by virtual Planck Mass Gravitational Black Holes,

for Gravity, the effective force strength that we see in our experiments

is not just composed of the S4 volume and the Spin(5) Schwinger Source volume, but is suppressed by the square of the Planck Mass.

The unsuppressed Gravity force strength is the Geometric Part of the force strength.

The Standard Model SU(3) Color Force bosons live in a SU(3) subalgebra of the SU(4) subalgebra of D4 = Spin(8). They "see" M4 Physical spacetime as the complex projective plane CP2 so that their part of the Physical Lagrangian is

$$\int_{\text{CP}^2} \text{SU(3) Color Force Gauge Boson Term}$$

an integral over SpaceTime CP2.

The Schwinger Sources for SU(3) bosons are the Complex Bounded Domains and Shilov Boundaries for SU(3) Color Force bosons. The Color Force Strength is given by the SpaceTime CP2 volume and the SU(3) Schwinger Source volume.

Note that since the Schwinger Source volume is dressed with the particle/antiparticle pair cloud, the calculated force strength is for the characteristic energy level of the Color Force (about 245 MeV).

The Standard Model SU(2) Weak Force bosons live in a SU(2) subalgebra of the U(2) local group of CP2 = SU(3) / U(2) They "see" M4 Physical spacetime as two 2-spheres S2 x S2 so that their part of the Physical Lagrangian is

$$\int_{\text{S}^2 \times \text{S}^2} \text{SU(2) Weak Force Gauge Boson Term}$$

an integral over SpaceTime S2xS2.

The Schwinger Sources for SU(2) bosons are the Complex Bounded Domains and Shilov Boundaries for SU(2) Weak Force bosons. However, due to the action of the Higgs mechanism, for the Weak Force, the effective force strength that we see in our experiments is not just composed of the S2xS2 volume and the SU(2) Schwinger Source volume, but is suppressed by the square of the Weak Boson masses.

The unsuppressed Weak Force strength is the Geometric Part of the force strength.

The Standard Model U(1) Electromagnetic Force bosons (photons) live in a U(1) subalgebra of the U(2) local group of CP2 = SU(3) / U(2) They "see" M4 Physical spacetime as four 1-sphere circles S1xS1xS1xS1 = T4 (T4 = 4-torus) so that their part of the Physical Lagrangian is

$$\int_{\text{T}^4} \text{(U(1) Electromagnetism Gauge Boson Term)}$$

an integral over SpaceTime T4.

The Schwinger Sources for U(1) photons are the Complex Bounded Domains and Shilov Boundaries for U(1) photons. The Electromagnetic Force Strength is given by the SpaceTime T4 volume and the U(1) Schwinger Source volume.

Fermion Mass Calculations

In Cl(16) Physics, the first generation spinor fermions are seen as +half-spinor and -half-spinor spaces of $Cl(1,7) = Cl(8)$.

Due to Triality, Spin(8) can act on those 8-dimensional half-spinor spaces similarly to the way it acts on 8-dimensional vector spacetime.

Take the spinor fermion volume to be the Shilov boundary corresponding to the same symmetric space on which Spin(8) acts as a local gauge group that is used to construct 8-dimensional vector spacetime:

the symmetric space $Spin(10) / Spin(8) \times U(1)$
corresponding to a bounded domain of type IV8
whose Shilov boundary is $RP^1 \times S^7$

Since all first generation fermions see the spacetime over which the integral is taken in the same way (unlike what happens for the force strength calculation), the only geometric volume factor relevant for calculating first generation fermion mass ratios is in the spinor fermion volume term.

Cl(16) Physics Fermions correspond to Schwinger Sources, so the quark mass in Cl(16) Physics is a constituent mass.

Fermion masses are calculated as a product of four factors:

$$V(Q\text{fermion}) \times N(\text{Graviton}) \times N(\text{octonion}) \times \text{Sym}$$

$V(Q\text{fermion})$ is the volume of the part of the half-spinor fermion particle manifold $S^7 \times RP^1$ related to the fermion particle by photon, weak boson, or gluon interactions.

$N(\text{Graviton})$ is the number of types of Spin(0,5) graviton related to the fermion. The 10 gravitons correspond to the 10 infinitesimal generators of $Spin(0,5) = Sp(2)$. 2 of them are in the Cartan subalgebra.

6 of them carry color charge, and therefore correspond to quarks.

The remaining 2 carry no color charge, but may carry electric charge and so may be considered as corresponding to electrons.

One graviton takes the electron into itself, and the other can only take the first generation electron into the massless electron neutrino. Therefore only one graviton should correspond to the mass of the first-generation electron. The graviton number ratio of the down quark to the first-generation electron is therefore $6/1 = 6$.

$N(\text{octonion})$ is an octonion number factor relating up-type quark masses to down-type quark masses in each generation.

Sym is an internal symmetry factor, relating 2nd and 3rd generation massive leptons to first generation fermions. It is not used in first-generation calculations.

The first generation down quark constituent mass : electron mass ratio is:

The electron, E, can only be taken into the tree-level-massless neutrino, 1, by photon, weak boson, and gluon interactions.

The electron and neutrino, or their antiparticles, cannot be combined to produce any of the massive up or down quarks.

The neutrino, being massless at tree level, does not add anything to the mass formula for the electron.

Since the electron cannot be related to any other massive Dirac fermion, its volume $V(Q_{\text{electron}})$ is taken to be 1.

Next consider a red down quark i.

By gluon interactions, i can be taken into j and k, the blue and green down quarks.

By also using weak boson interactions,

it can also be taken into l, J, and K, the red, blue, and green up quarks.

Given the up and down quarks, pions can be formed from quark-antiquark pairs, and the pions can decay to produce electrons and neutrinos.

Therefore the red down quark (similarly, any down quark)

is related to all parts of $S^7 \times RP^1$,

the compact manifold corresponding to $\{ 1, i, j, k, E, l, J, K \}$

and therefore

a down quark should have

a spinor manifold volume factor $V(Q_{\text{down quark}})$ of the volume of $S^7 \times RP^1$.

The ratio of the down quark spinor manifold volume factor

to the electron spinor manifold volume factor is

$$V(Q_{\text{down quark}}) / V(Q_{\text{electron}}) = V(S^7 \times RP^1) / 1 = \pi^5 / 3.$$

Since the first generation graviton factor is 6,

$$m_d / m_e = 6 V(S^7 \times RP^1) = 2 \pi^5 = 612.03937$$

As the up quarks correspond to l, J, and K, which are the octonion transforms under E of i, j, and k of the down quarks, the up quarks and down quarks have the same constituent mass

$$m_u = m_d.$$

Antiparticles have the same mass as the corresponding particles.

Since the model only gives ratios of masses,

the mass scale is fixed so that the electron mass $m_e = 0.5110 \text{ MeV}$.

Then, the constituent mass of the down quark is $m_d = 312.75 \text{ MeV}$,

and the constituent mass for the up quark is $m_u = 312.75 \text{ MeV}$.

Further Calculations and Details are in viXra 1810.0365

Results of E8 Physics Calculations:

Here is a summary of E8 Physics model calculation results. Since ratios are calculated, values for one particle mass and one force strength are assumed. Quark masses are constituent masses. Most of the calculations are tree-level, so more detailed calculations might be even closer to observations.

Fermions as Schwinger Sources have geometry of Complex Bounded Domains with Kerr-Newman Black Hole structure size about $10^{(-24)}$ cm.

(for calculation details see viXra 1804.0121)

Dark Energy : Dark Matter : Ordinary Matter = 0.75 : 0.21 : 0.04

Particle/Force	Tree-Level	Higher-Order
e-neutrino	0	0 for nu_1
mu-neutrino	0	$9 \times 10^{(-3)}$ eV for nu_2
tau-neutrino	0	$5.4 \times 10^{(-2)}$ eV for nu_3
electron	0.5110 MeV	
down quark	312.8 MeV	charged pion = 139 MeV
up quark	312.8 MeV	proton = 938.25 MeV
		neutron - proton = 1.1 MeV
muon	104.8 MeV	106.2 MeV
strange quark	625 MeV	
charm quark	2090 MeV	
tauon	1.88 GeV	
beauty quark	5.63 GeV	
truth quark (low state)	130 GeV	(middle state) 174 GeV (high state) 218 GeV
W+	80.326 GeV	
W-	80.326 GeV	
W0	98.379 GeV	Z0 = 91.862 GeV
Mplanck	1.217×10^{19} GeV	
Higgs VEV (assumed)	252.5 GeV	
Higgs (low state)	126 GeV	(middle state) 182 GeV (high state) 239 GeV
Gravity Gg (assumed)	1	
(Gg)(Mproton ² / Mplanck ²)		$5 \times 10^{(-39)}$
EM fine structure	1/137.03608	
Weak Gw	0.2535	
Gw(Mproton ² / (Mw+ ² + Mw- ² + Mz0 ²))		$1.05 \times 10^{(-5)}$
Color Force at 0.245 GeV	0.6286	0.106 at 91 GeV

Kobayashi-Maskawa parameters for W+ and W- processes are:

	d	s	b
u	0.975	0.222	0.00249 -0.00388i
c	-0.222 -0.000161i	0.974 -0.0000365i	0.0423
t	0.00698 -0.00378i	-0.0418 -0.00086i	0.999

The phase angle d13 is taken to be 1 radian.

which includes calculations from

a Nambu-Jona-Lasinio System of Higgs and Truth Quarks that has Higgs as Truth Quark-AntiQuark Condensate and 3 mass states:

Higgs at 125 GeV and Truth Quark at 130 GeV
 Higgs at 200 GeV and Truth Quark at 174 GeV
 Higgs at 250 GeV and Truth Quark at 220 GeV

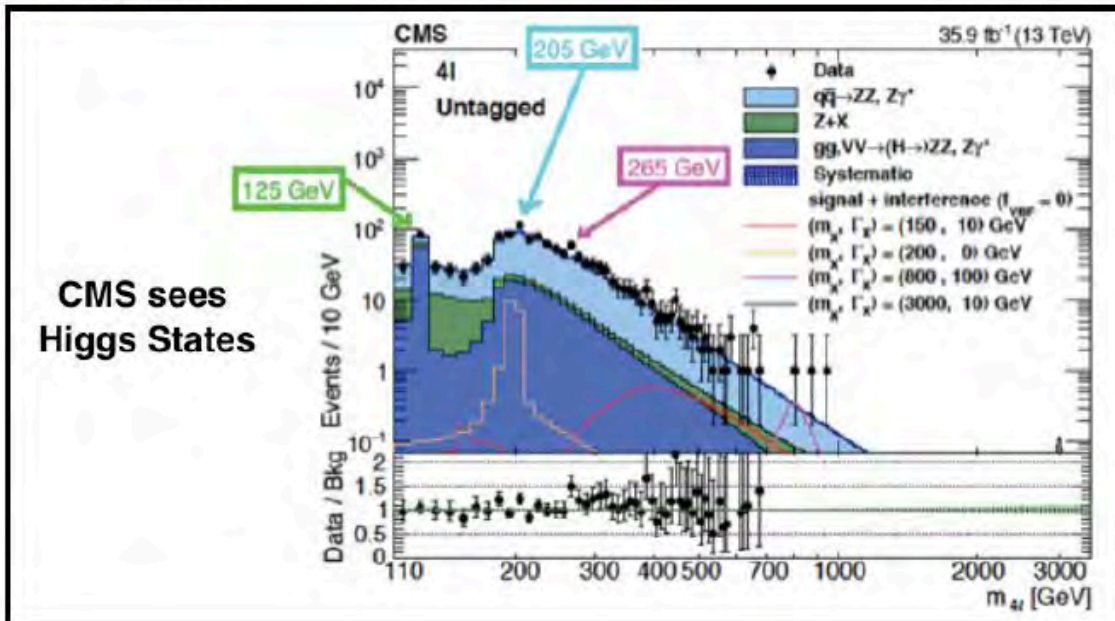
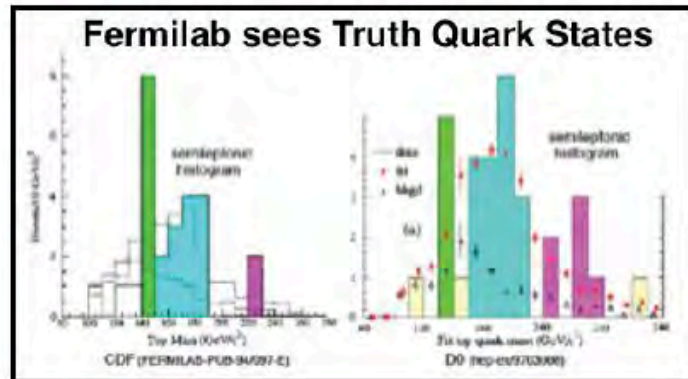
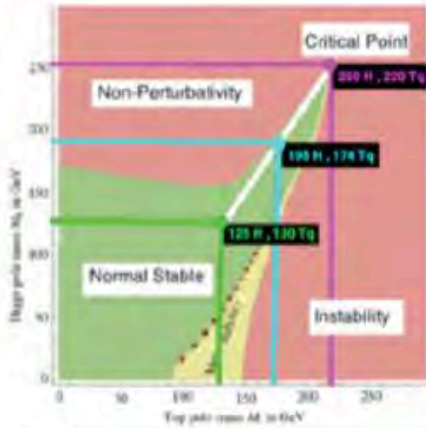

Algebraic Quantum Field Theory

26D String Theory has a Real Clifford Algebra $Cl(1,25)$ constructed from

$Cl(16) = Cl(8) \times Cl(8) \rightarrow Cl(8) \times Cl(8) \times Cl(8) = Cl(24)$
to get to the Leech Lattice 24-dim Vector Space

Conformal Structure of 2×2 matrices with entries in $Cl(24)$
(Porteous, Clifford Algebras and the Classical Groups and
Lounesto and Porteous, Lectures on Clifford (Geometric) Algebras and Applications)
gives $M(2, Cl(24)) = Cl(1,25)$ with Lorentz Leech Lattice Vector Space.

Since all the matrix entries are tensor product of 3 copies of $Cl(0,8)$
8-Periodicity allows formation of the tensor products of copies of $Cl(1,25)$

$$Cl(1,25) \times \dots (N \text{ times tensor product}) \dots \times Cl(1,25)$$

For $N = 2^8 = 256$ the copies of $Cl(1,25)$ are on the 256 vertices
of the 8-dim HyperCube



For $N = 2^{16} = 65,536$ the copies of $Cl(1,25)$ fill in the 8-dim HyperCube
William Gilbert's web page says: "... The n-bit reflected binary Gray code
will describe a path on the edges of an n-dimensional cube that can be
used as the initial stage of a Hilbert curve that will fill an n-dim... cube. ...".

As N grows, the copies of $Cl(1,25)$ continue to fill the 8-dim HyperCube of
 E_8 SpaceTime using higher Hilbert curve stages from the 8-bit reflected
binary Gray code subdividing the initial 8-dim HyperCube into more and
more sub-HyperCubes.

If edges of sub-HyperCubes, equal to the distance between adjacent copies of $Cl(1,25)$, remain constantly at the Planck Length, then the full 8-dim HyperCube of our Universe expands as N grows to 2^{16} and beyond similarly to the way shown by this 3-HyperCube example for $N = 2^3, 4^3, 8^3$ from William Gilbert's web page:

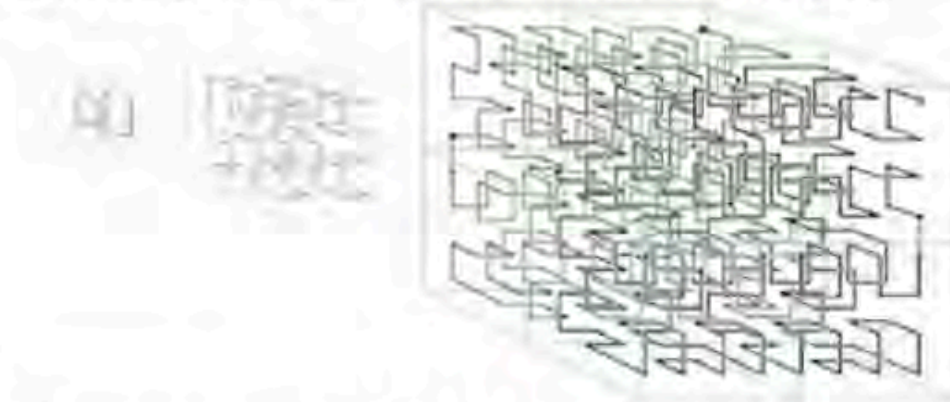

**Completion of Union of All Tensor Products of $Cl(1,25)$ =
= hyperfinite AQFT = Algebraic Quantum Field Theory =
= the Third Grothendieck Universe**

The AQFT contains a copy of E_8 within $Cl(16)$ within each copy of $Cl(1,25)$
**The E_8 is a Recipe for a Realistic Physics Lagrangian
so the AQFT has a natural realistic Lagrangian structure.**

The Vector Space of $Cl(1,25)$ is the Spacetime of a 26D String Theory
in which Strings are World-Lines of Particles
and
**the Massless Symmetric Spin 2 State is the Carrier
of the Bohm Quantum Potential with Sarfatti Back-Reaction**

The $Cl(1,25)$ AQFT being the completion of the union of all tensor products of $Cl(1,25)$
it is the **Real Clifford Algebra (8-Periodicity) analog**
of the completion of the union of all tensor products of the Complex Clifford Algebra
(2-Periodicity) $Cl(2;C)$ of 2×2 Complex Matrices = $M_2(C)$ of Spinor Fock Space that
is the **Hyperfinite II_1 von Neumann factor algebra.**

Bohm Quantum Potential and Quantum Consciousness

Strings = World Lines and World Lines are past and future histories of particles, so spin-2 Bohmions carry Bohm Quantum Potential with Back-Reaction of Sarfatti's extension of the Sutherland Lagrangian for the Bohm Potential

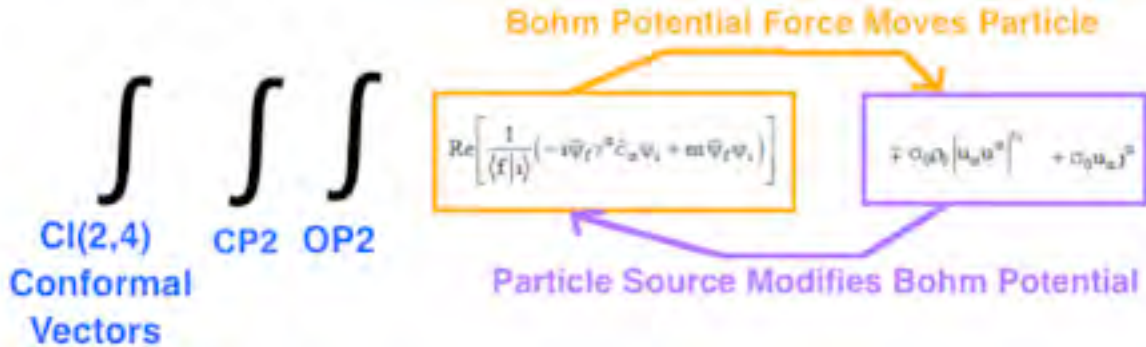

where a, b and M4 form CI(2,4) vectors and M4 x CP2 = Kaluza-Klein Spacetime and CI(8) half-Spinors S+ and S- form OP2 so that
 26D = 16D orbifolded fermions + 10D and 10D = 6D Conformal Space + 4D CP2

Similarity of the spin 2 Bohmion to the spin 2 Graviton accounts for the Bohmion's ability to support Penrose Consciousness with Superposition Separation Energy Difference $G m^2 / a$ where,
 for a Human Brain, m = mass of electron and a = 1 nanometer in Tubulin Dimer

“... Bohm's Quantum Potential can be viewed as an internal energy of a quantum system ...”

according to Dennis, de Gosson, and Hiley (arXiv 1412.5133)

and

Bohm Quantum Potential inherits Sarfatti Back-Reaction from its spin-2 structure similar to General Relativity

Peter R. Holland says in "The Quantum Theory of Motion" (Cambridge 1993):

"... the total force ... from the quantum potential ... does not ... fall off with distance ... because ... the quantum potential ... depends on the form of ...[the quantum state]... rather than ... its ... magnitude ...".

Further,

each cell of E8 Lagrangian Spacetime corresponds to 65,536-dim Cl(16)
which contains 248-dim E8 = 120-dim D8 bivectors +128-dim D8 half-spinors
and

Human Brain Microtubules 40 microns long have 65,536 Tubulin Dimers



(image adapted from 12biophys.blogspot.com Lecture 11)

So

Brain Microtubules can have Bohm Quantum Resonance with Cl(16) Spacetime cells
and at any and all Times

the State of Consciousness of a Human is in exact resonant correspondence with
a subset of the cells of E8 Classical Lagrangian Spacetime

Therefore

E8 Lagrangian Spacetime (as a Nambu-Jona-Lasinio Condensate)
is effectively the Spirit World

in which the Human States of Consciousness = Souls exist.

After the death of the Human Physical Body the Spirit World interactions with its Soul
are no longer constrained by Physical World interactions with its Body

so

**the Spirit World can harmonize the individual Soul
with the collective Universal Soul.**

Grosse Fugue and E8-Cl(16) Physics

Frank Dodd (Tony) Smith, Jr. - 2019

Abstract

The Structure of Beethoven's Grosse Fugue (Opus 133 and 134) corresponds to Cl(16) - E8 Physics (viXra 1810.0365) and the evolution of our Universe and Human civilization. Since Beethoven wrote the Grosse Fugue in 1825, two years before his death in 1827, and the E8 Lie Algebra and the Cl(16) Real Clifford Algebra were not known until the work of Lie, Killing, and Clifford in the 1870s-1880s, it was not possible for Beethoven to have used the math knowledge of his day in writing the Grosse Fugue. A possible explanation could be that (Appendix on Quantum Consciousness - page 24) our conscious brains have structure similar to the structure of Cl(16) - E8 so that when Beethoven was composing, looking deep inside his conscious brain to "hear" music mentally that he could not hear normally because of his deafness, he was "seeing" Cl(16) - E8. Human quantum consciousness is based on microtubules containing maximally about 65,536 Tubulin Dimers. E8 lives in the 65,536-dimensional Real Clifford Algebra Cl(16). Cl(16) is the basic structure of our Universe so Beethoven could have been "seeing" in his mind that the E8 inside Cl(16) looks like part of the structure of microtubules of his consciousness and then writing that structure into the Grosse Fugue.

The Grosse Fugue correspondences with Cl(16) - E8 are shown in this paper using visualizations by Stephen Malinowski.

The Timetable of evolution of Human civilization is based on viXra 1810.0365 and this chart derived from it:

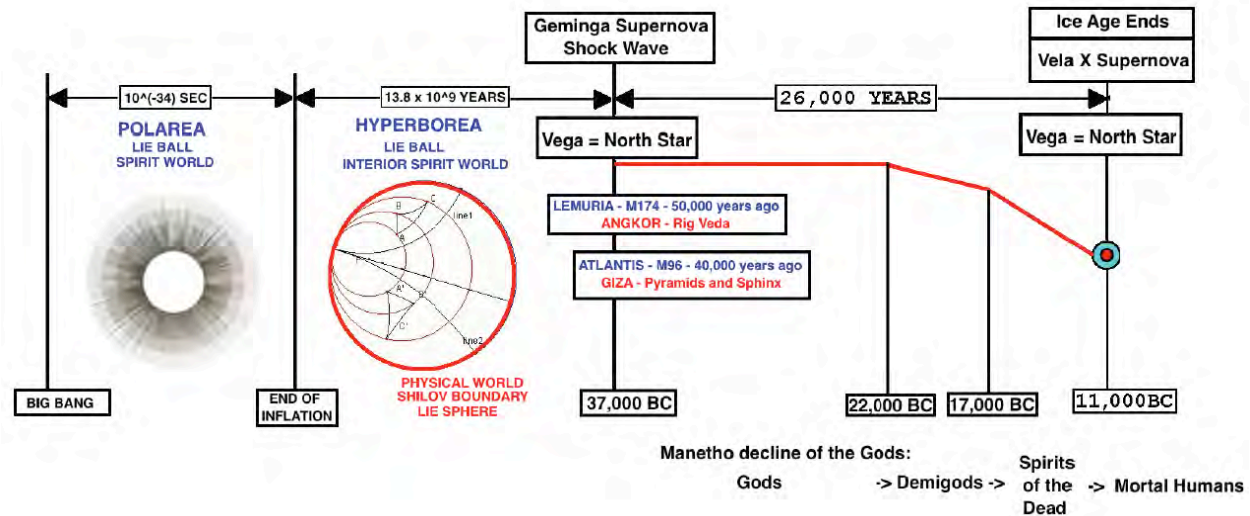

The Timetable of evolution of our Universe is based on this chart derived from a Fermilab chart:

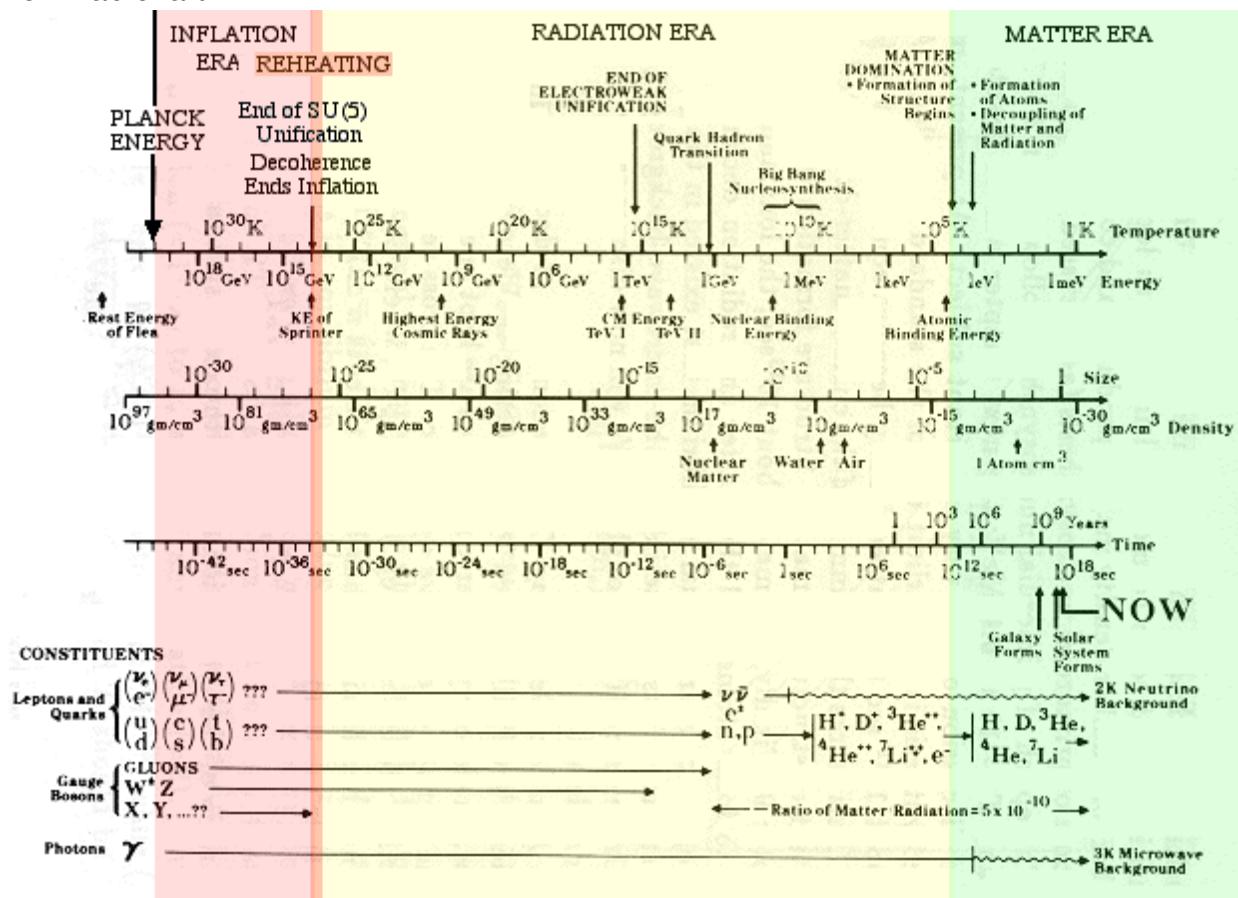

The correspondences seem to me to be too extensive to be mere coincidence, although it is possible that I am just seeing what I want to see in the Grosse Fugue. Even so, the structural correspondences are useful to me (the music reinforces the math / physics and vice versa).

A similar line of reasoning might explain correspondences between Cl(16) - E8 Physics and the Archetype images of Jung's Red Book (Appendix on Red Book Physics - page 38).

Beethoven wrote String Quartet Opus 135 in 1826, the year after writing the Grosse Fugue and the year before his death.

Its last movement is headed "Der schwer gefasste Entschluss" ("The Difficult Decision"). In it Beethoven wrote in the manuscript "Muss es sein?" (Must it be?) to which he responds "Es muss sein!" (It must be?). (Wikipedia)

Der schwer gefasste Entschluss.

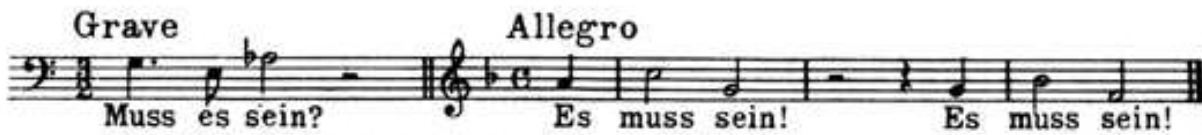

(Elias String Quartet - The Beethoven Project)

My view is that Beethoven sees that the Grosse Fugue has the deep theoretical / historical correlations that I describe in this paper and that he is asking himself to make the Difficult Decision of whether or not those correspondences made it inevitable that he write the Grosse Fugue as he did write it and continue to support it despite the fierce dislike of it expressed by his audience and his publisher. His answer "Es muss sein!" is a declaration that the Grosse Fugue is as important and accurate as to theory and history as I think it is.

Overture to Beethoven's Grosse Fugue (Opus 133) is an Outline of the E8 Lie Algebra

The Overture to Beethoven's Grosse Fugue (Opus 133) is an Outline of E8 Lie Algebra. Visualizations of Beethoven's Grosse Fugue (Opus 133) by Stephen Malinowski show details of the correspondences between the Grosse Fugue and E8.

Since Beethoven wrote the Grosse Fugue in 1825, two years before his death in 1827, and since the E8 Lie Algebra and the Cl(16) Real Clifford Algebra in which it lives were not known to the mathematics community until Marius Sophus Lie and Wilhelm Killing invented Lie Algebras in the 1870s and 1880s and William Kingdon Clifford invented Clifford Algebras in 1878 it was not possible for Beethoven to have used the mathematics knowledge of his day in writing the Grosse Fugue but the correspondences between the Grosse Fugue Overture and the E8 Lie Algebra are far too extensive to be mere coincidence.

A possible explanation could be that our conscious brains have structure similar to the structure of E8 so that when Beethoven was composing, looking deep inside his conscious brain to "hear" music mentally that he could not hear normally because of his deafness, he was "seeing" basic structures similar to E8.

Human quantum consciousness is based on microtubules containing maximally about 65,536 Tubulin Dimers.

E8 lives in the 65,536-dimensional Real Clifford Algebra Cl(16).

Cl(16) is the basic structure of Our Universe (viXra 1810.0365).

so Beethoven could have been "seeing" in his mind that the E8 inside Cl(16) looks like part of the structure of microtubules of his consciousness and then writing that structure into the Grosse Fugue.

A similar line of reasoning might explain correspondences between Cl(16) Physics and the Archetype images of Jung's Red Book.

Visualizations of Beethoven's Grosse Fugue (Opus 133) (about 16 minutes long) have been done by Stephen Malinowski

<http://www.musanim.com/GrosseFuge/GrosseFugeViewersGuide.pdf>

Its Primary Subject has 8 notes

that can be seen as basis elements of 8-dimensional Euclidean Space

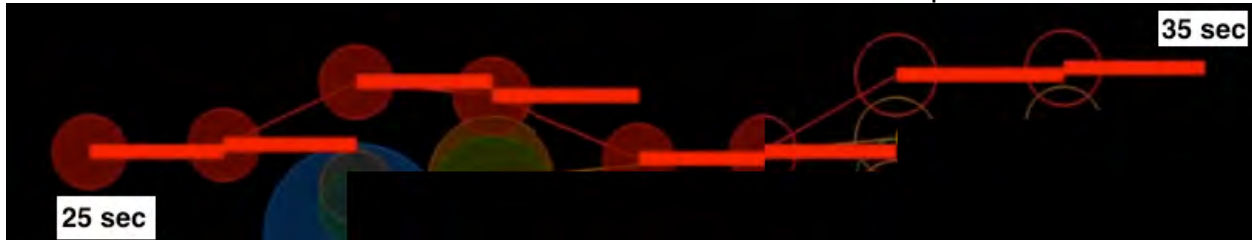

According to Wikipedia, it is played in every possible variation: fortissimo and pianissimo, different rhythms, upside down and backwards.

The E8 Lie Algebra is constructed from the largest possible consistent group of reflections in 8-dim Euclidean space, analogous to the variations of the Grosse Fugue Primary Subject.

The Overture to the Grosse Fugue (24 bars, about 40 seconds)"... presents ... the material that will make up the entire piece ..." (quote from Wikipedia)

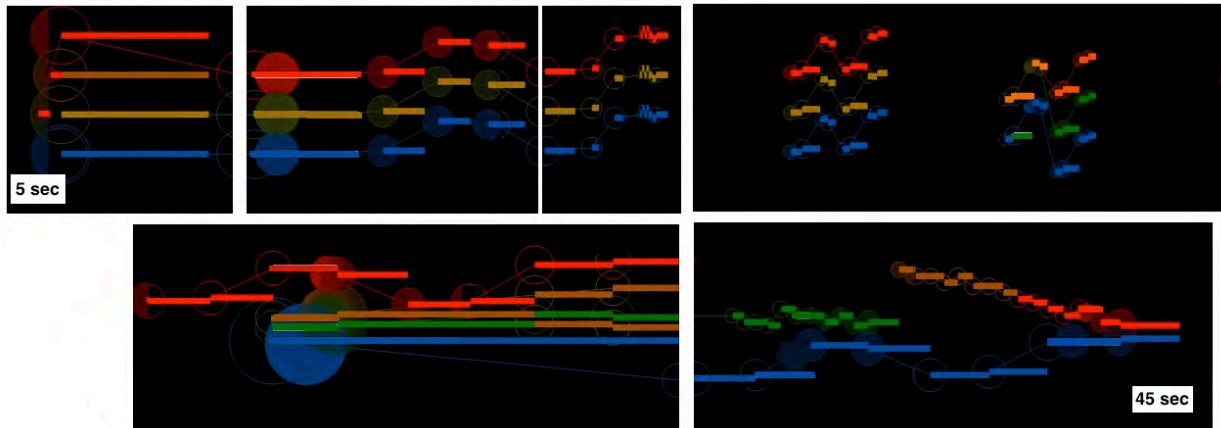

Here is how those segments of the Overture correspond to E8 Lie Algebra structures:

The initial segment introduces the instruments of the String Quartet:

first violin; second violin; viola; cello

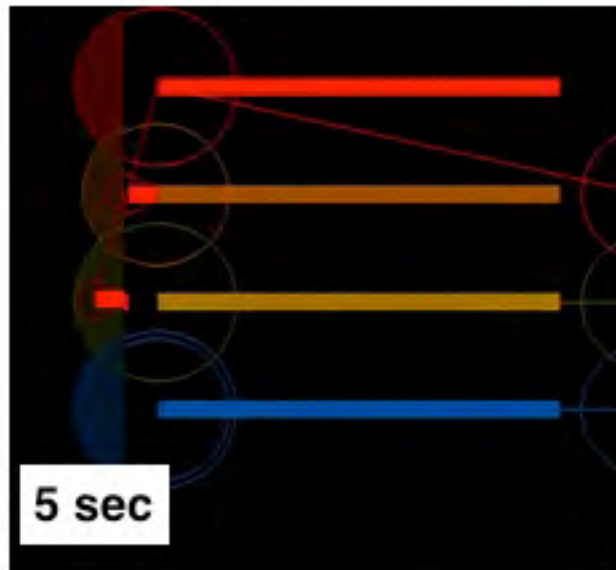

Statement of the 8 elements of the Main Fugal Subject

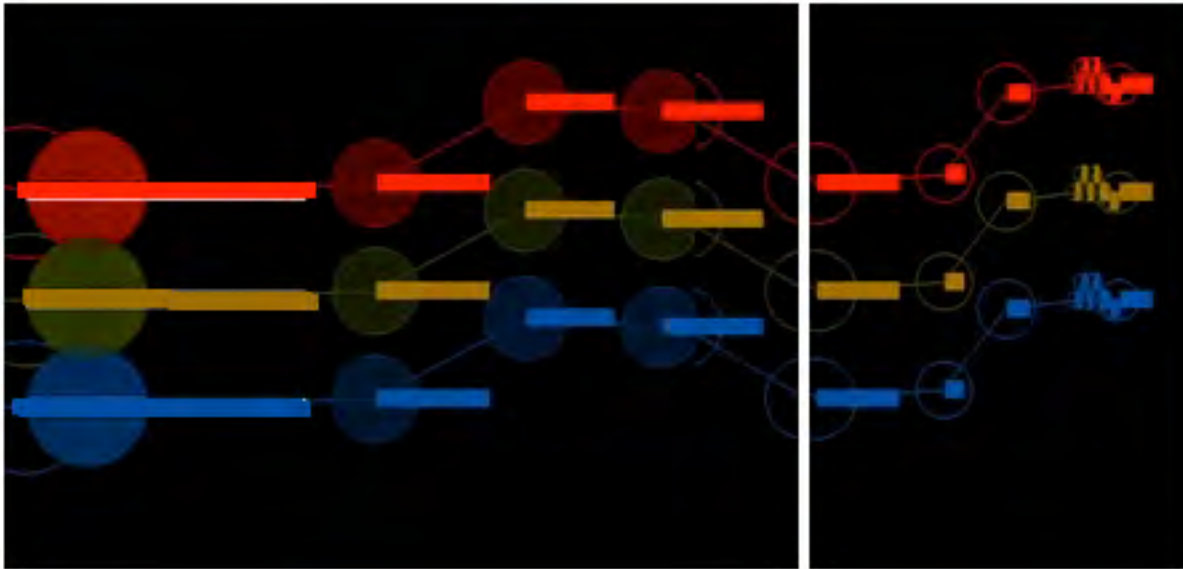

corresponds to the 8 dimensions of an Octonionic Vector Space.

E8 has a D8 subalgebra that acts as rotations / reflections in a 16-dimensional Space that is an 8-complex-dimensional Complex Domain known as a Lie Ball.

The Shilov Boundary of the Lie Ball is an 8-real-dimensional Lie Sphere $RP^1 \times S^7$ with symmetry $Spin(10) / Spin(8) \times U(1)$ corresponding to 8-dim Octonionic Spacetime and to the 8 elements of the First Fugue.

At low energies (relative to the Planck Energy) the Octonionic Symmetry of Spacetime breaks to Quaternionic Symmetry of (4+4)-dim Kaluza-Klein $M_4 \times CP^2$

E8 Lattice 8-dim Spacetime

$E8 \times E8 \times E8 = 24\text{-dim Leech Lattice of } 26\text{D String=World-Line Theory}$

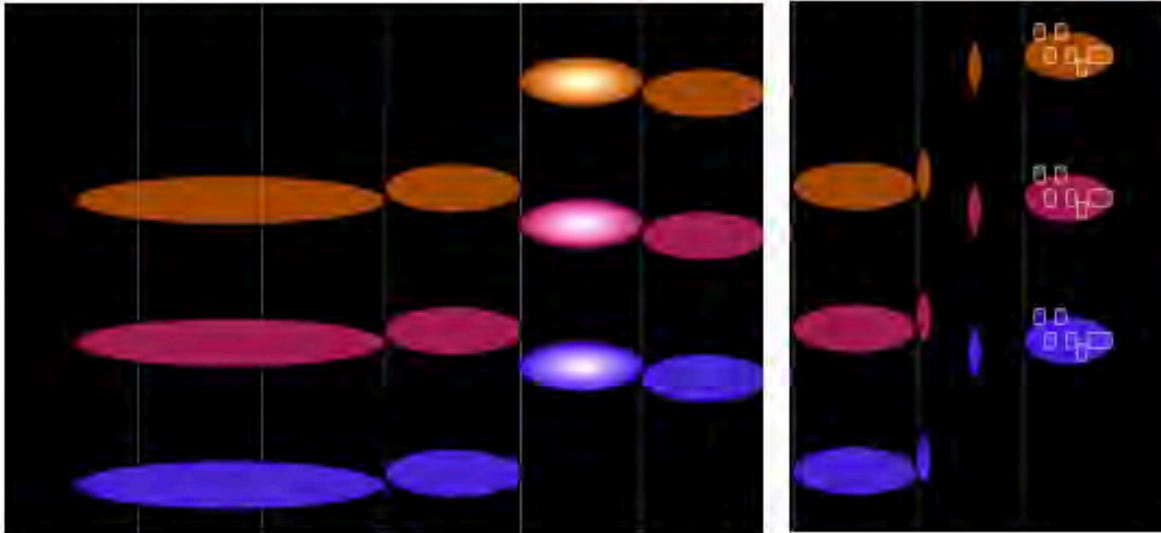

M4

$CP2 = SU(3)/U(2)$

M4 x CP2 Kaluza-Klein Quaternionic Spacetime

The M4 Physical Spacetime with Lie Sphere structure $RP1 \times S3$ corresponds to 1 long note (time) and 3 medium notes (space).

The CP2 Internal Symmetry Space of $CP2 = SU(3) / SU(2) \times U(1)$ corresponds to 1 medium note, 2 short notes, and one complicated medium note.

The whole thing is repeated in 3 instruments (second violin, first violin, cello) to correspond to the 24-dim Leech Lattice and to the 3 Octonions of the 56-dimensional $Fr3(O)$ Freudenthal Algebra (10 copies of which are $Cl(16)$ TriVectors) $Fr3(O)$ is the complexification of the 27-dimensional Jordan Algebra $J3(O)$ whose traceless part $J3(O)_o$ is the basic structure of 26D String=World-Line Theory

Repetition of Main Fugal Subject twice, in diminution

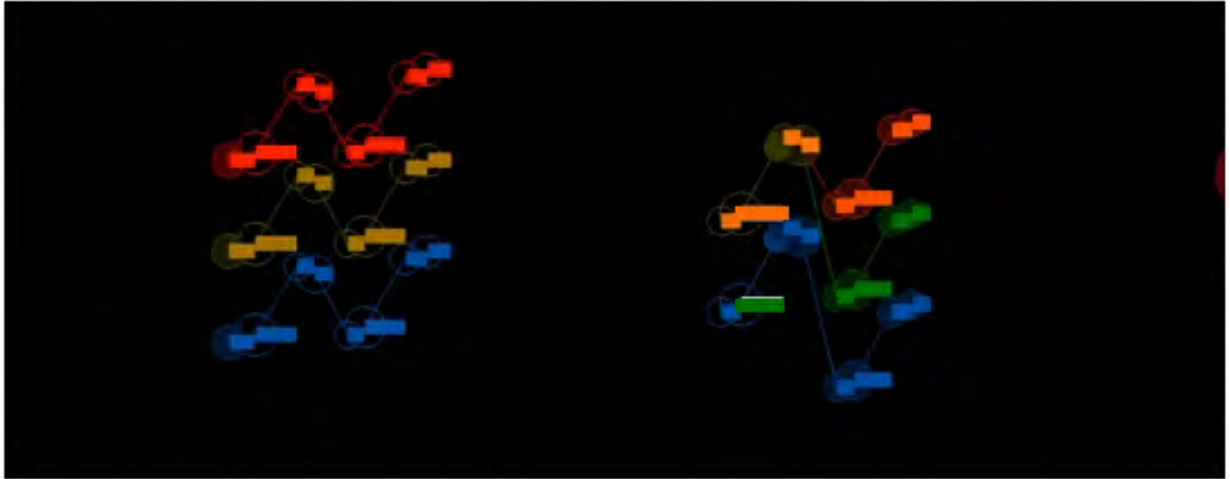

corresponds to the two D4 subalgebras in the D8 subalgebra of E8.



Here

<http://www.valdostamuseum.com/hamsmith/BeethovenGFovtD4D4.mov>

is an animation by Stephen Malinowski of the Gravity D4 and Standard Model D4 parts of the Grosse Fugue Overture

As to what effects the Grosse Fugue Overture music and animation have on my feelings compared to effects of the D4 subalgebras of E8 Physics,

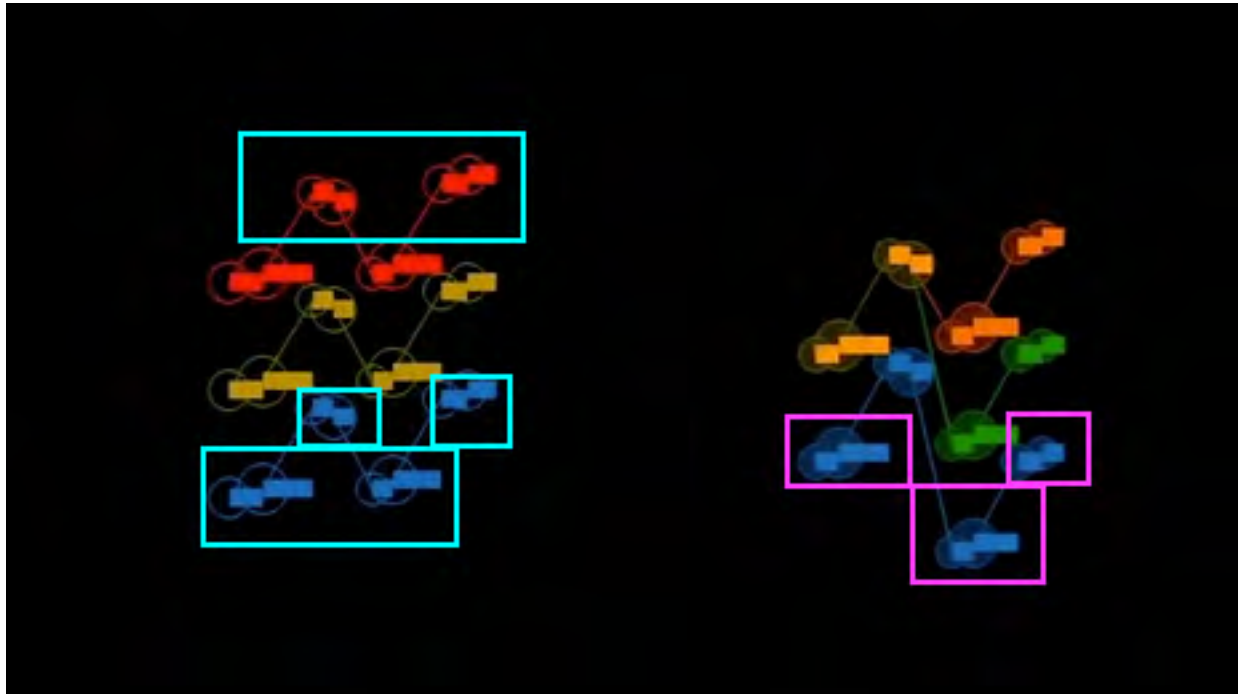

When I hear the Grosse Fugue Overture two-part sample of music and see the animation of it I get feelings that are specific to that experience.

It is reproducible: the same hearing / seeing gives the same feeling

I also work on the physics of the $Cl(16)$ Clifford Algebra which contains E_8 Lie Algebra which contains two D_4 subalgebras - one D_4 for Gravity+Dark Energy and another D_4 for Standard Model with Color Force. When I think of the Gravity D_4 and the Color Force D_4 I get exactly the same feeling as from the two-part sample of the Grosse Fuge Overture.

The feeling for the first of the two parts (the 12 notes in the cyan boxes - 8 blue of Gravity and 4 red of Dark Energy) is the same as the feeling for Gravity D_4

The feeling for the second of the two parts (the 6 notes (blue) in the magenta boxes) is the same as the feeling for Color Force D_4

I hypothesize that the same patterns of Tubulin excitations in my brain Microtubules are activated by the Grosse Fuge experiences and by the Gravity - Color Force D_4 subalgebras of E_8 in $Cl(16)$.

The Main Fugal Subject again (first violin)

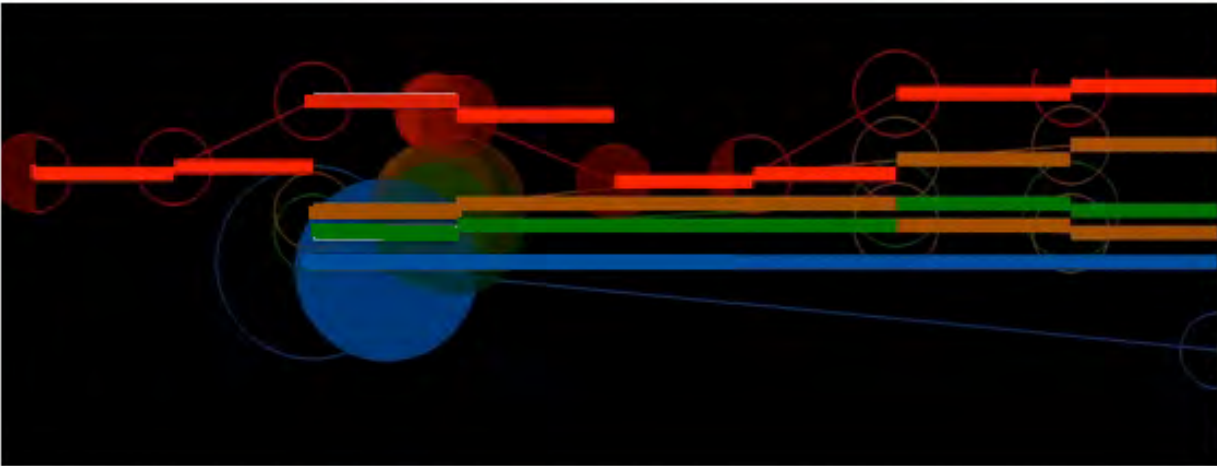

corresponding to 8 Fermion Particles of the First Generation.

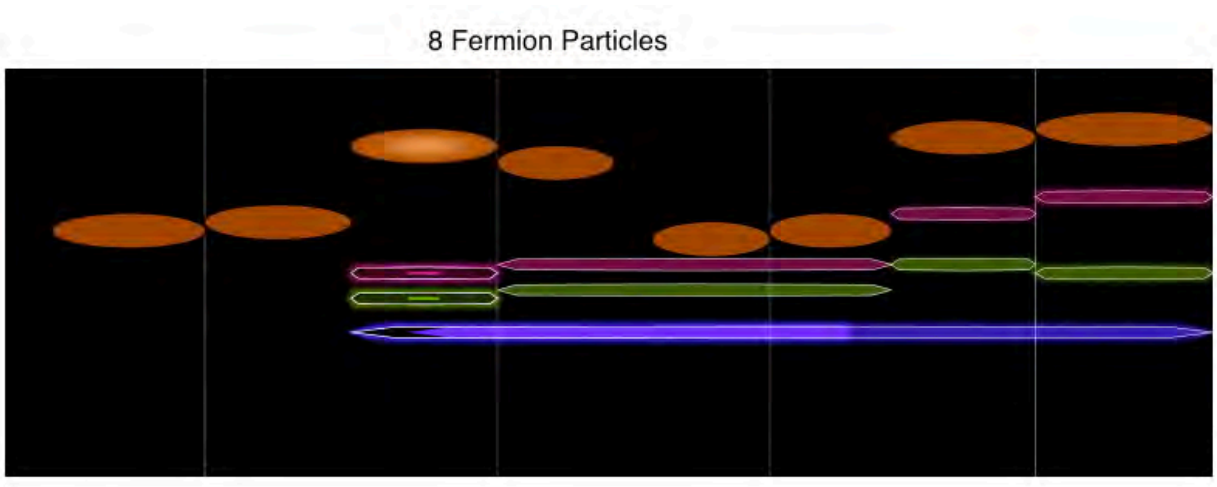

Its three recapitulations (second violin, viola, cello) correspond to the 3 Generations of Fermions.

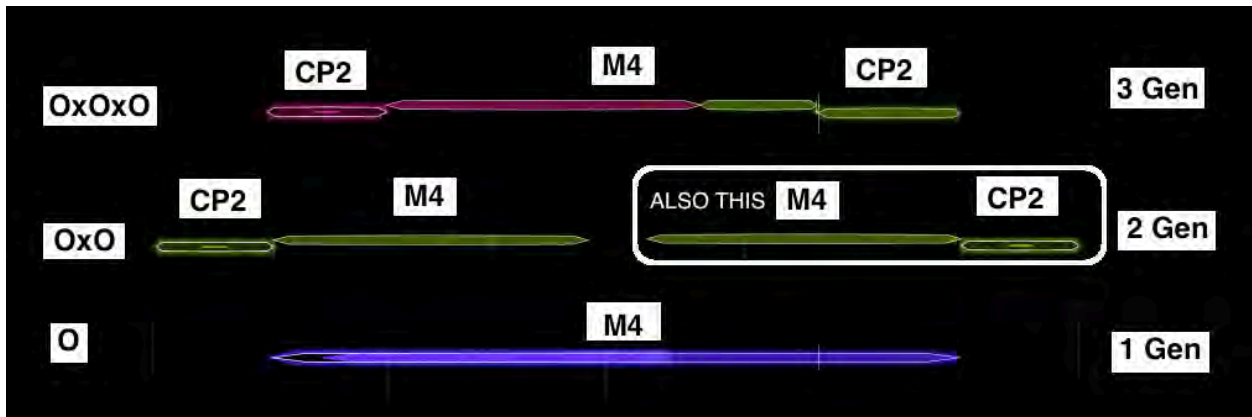

Statement of the Other Fugal Subject with 12 + 16 elements corresponding to the 12-element Standard Model $SU(3) \times SU(2) \times U(1)$ and to the 16-element Conformal Gravity+Dark Energy $U(2,2)$ of the two 28-dimensional D4 subalgebras of the D8 subalgebra of E_8



Statement of the First Subject in the cello
corresponding to 8 Fermion AntiParticles of the First Generation

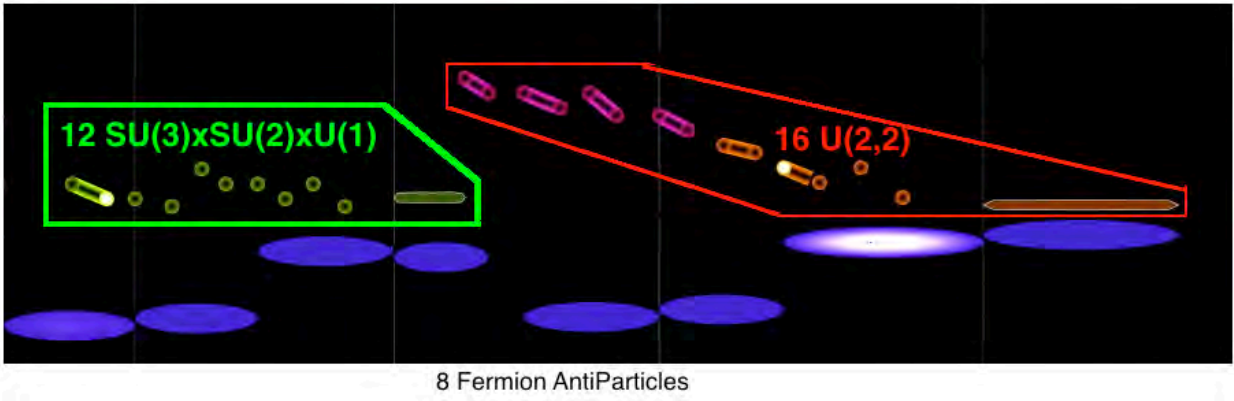

On the following page is a summary diagram of the Grosse Fuge Overture and E8:

5 sec

45 sec

EB Lattice 8-dim Spacetime
E8xE8/E8 + 24-dim Leech Lattice of 26D String-World-Line Theory

Gravity D4
12 Standard Model Quarks

Standard Model D4
12 or 16 Gravity Gravitons
3 Gravity Gravitons (one zero)

8 Fermion Particles

3 Generations of Fermions

M4
M4 x CP2 Kaluza-Klein Quaternionic Spacetime

CP2 = SU(3)U(2)

7 SU(2) x U(1) Vector

8 Standard Model Higgs Vectors

12 SU(3)xSU(2)xU(1)

16 U(2,2)

8 Fermion AntiParticles

Beethoven's Grosse Fuge Opus 133 Overture is an Outline of E8 Lie Algebra

Grosse Fugue - Structural Correspondence with $Cl(16)$ - E8 and History

0:04 4 Generators from M4 of Parent Universe - Clifford Iteration of M4 = $Cl(16)$

16-dim $Cl(16)$ Vectors = Lie Sphere Bounded Domain with 8-dim Spacetime Lie Sphere Shilov Boundary

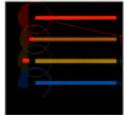

0:08 Overture - Quantum Fluctuation Vacuum Organizes Itself as $Cl(16)$ containing E8

248-dim E8 = 120-dim $Cl(16)$ BiVectors + 128-dim $Cl(8)$ half-Spinors



E8 Lattice 8-dim Spacetime
E8xE8xE8 = 24-dim Leech Lattice of 26D String-World-Line Theory

M4 x CP2 Kaluza-Klein Quaternionic Spacetime

M4 CP2 = SU(3) x U(1)

Gravity D4

12 Standard Model Ghosts

12 SU(2) Root Vectors

Standard Model D4

12 of 16 Gravity Ghosts

3 Gravity Ghosts one site

8 Standard Model Fermion Vectors

8 Fermion Particles

3 Generations of Fermions

12 SU(3) x SU(2) x U(1)

16 U(2,2)

8 Fermion AntiParticles

Beethoven's Grosse Fugue Opus 133 Overture is an Outline of E8 Lie Algebra

0:44 560-dim $Cl(16)$ TriVectors = 10 copies of 56-dim $Fr_3(O)$
 $Fr_3(O)$ = complexification of 27-dim $J_3(O)$ with traceless part = $J_3(O)_o$ of
 26D String=World-Line Theory
 26D Clifford Algebra $Cl(1,25) = Cl(0,26) = M(2, Cl(0,24)) = 2 \times 2$ Matrices of
 $Cl(0,24)$
 $Cl(0,24) = Cl(0,16) \times Cl(0,8)$ by Real Clifford 8-Periodicity

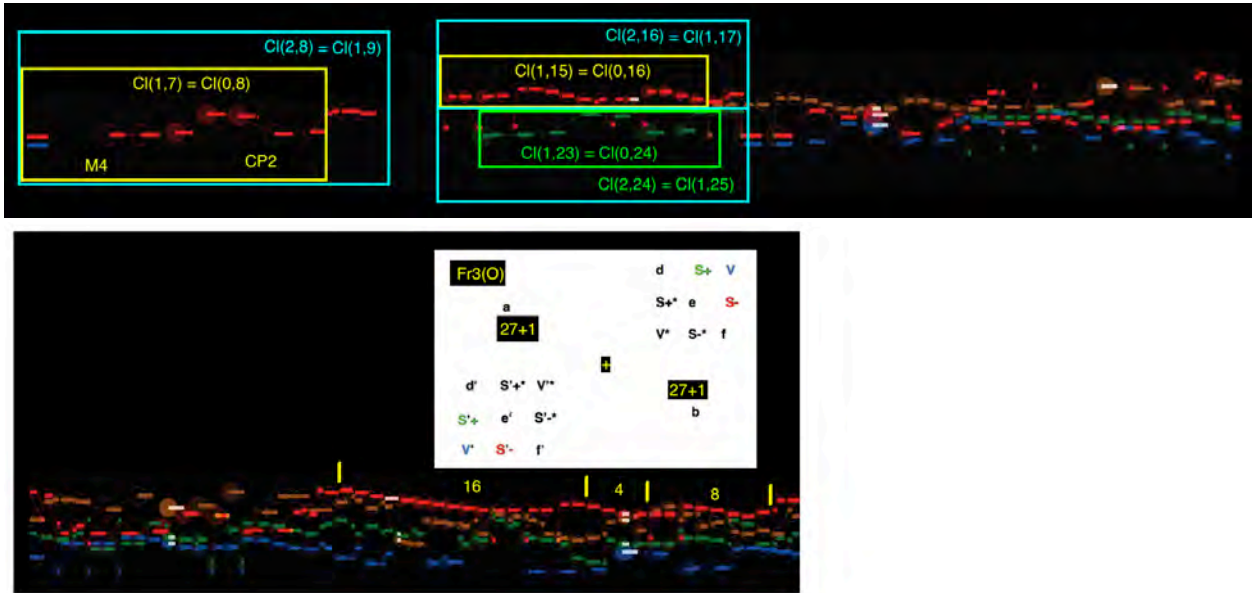

[1:39](#) Non-Unitary Octonionic Inflation and Creation of $2^{256} = 10^{77}$ Particles

Everything is in Coherent Superposition

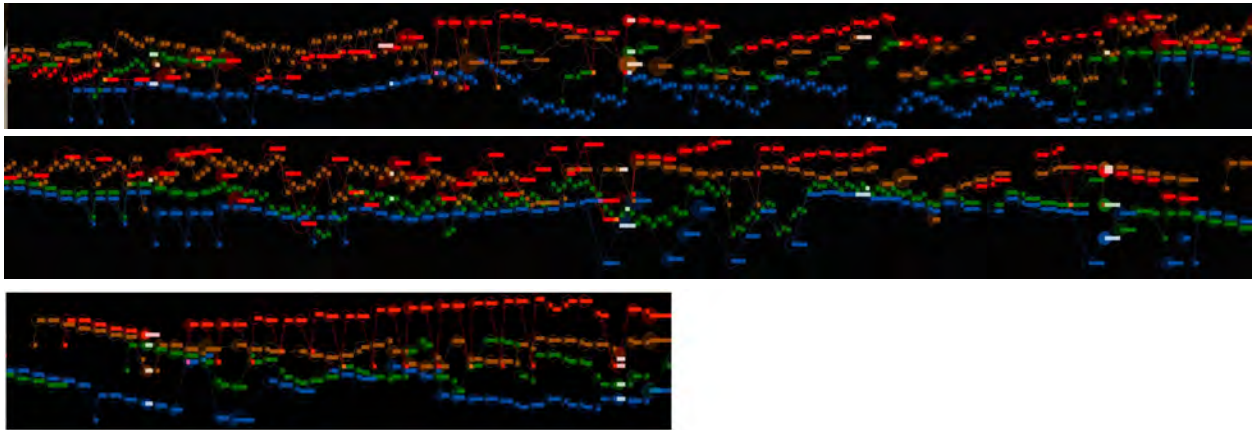

If the Initial QF Cell is dominated by +Particles then, since there is no mixing by E8 64(++ + --) half-Spinors, the Fermion Particle content after the first Unfolding is



so it is clear that the Octonionic Inflation Unfolding Process creates Fermion Particles with no Antiparticles,

3:14 End of Inflation 10^{-34} sec 10^{14} GeV
 Quantum Decoherence selects Initial Low Entropy Universe

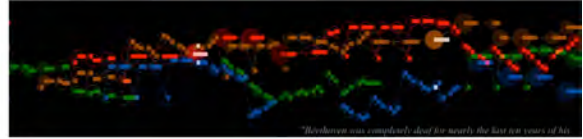

No Reheating was needed
 because the Inflationary Universe was filled by Particles created by Non-Unitary Octonionic Processes.

4:43 Quaternionic Radiation Expansion Begins 10^{-33} sec 10^{13} GeV

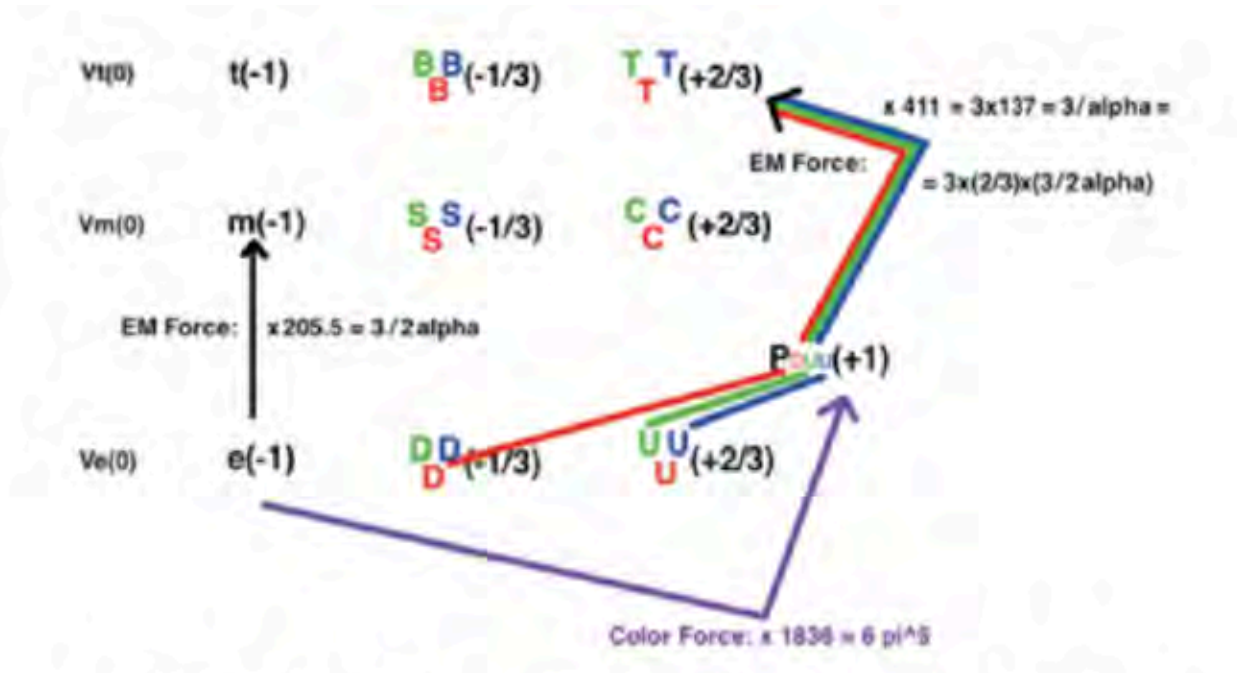
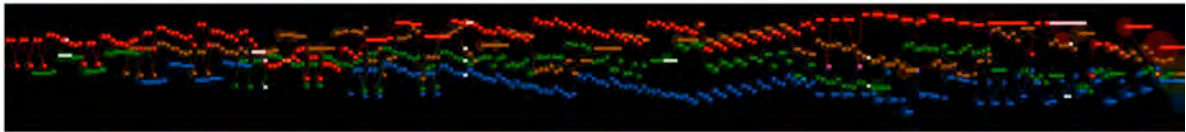

**Mendel Sachs Calculation results equivalent to Cl(16) Calculation Results
 and for Truth Quark Ground State to NonCommutative Geometry Results**

5:00 Electroweak Symmetry Breaking 10^{-12} sec 250 GeV

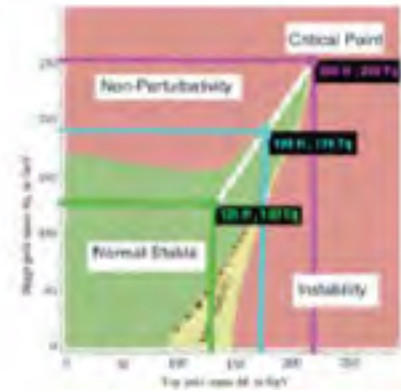
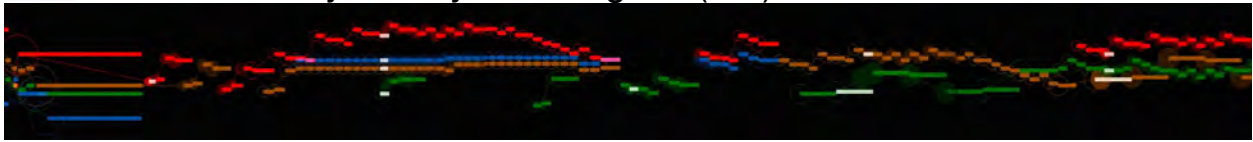

5:34 Quark-Hadron Transition 10^{-6} sec 1 GeV

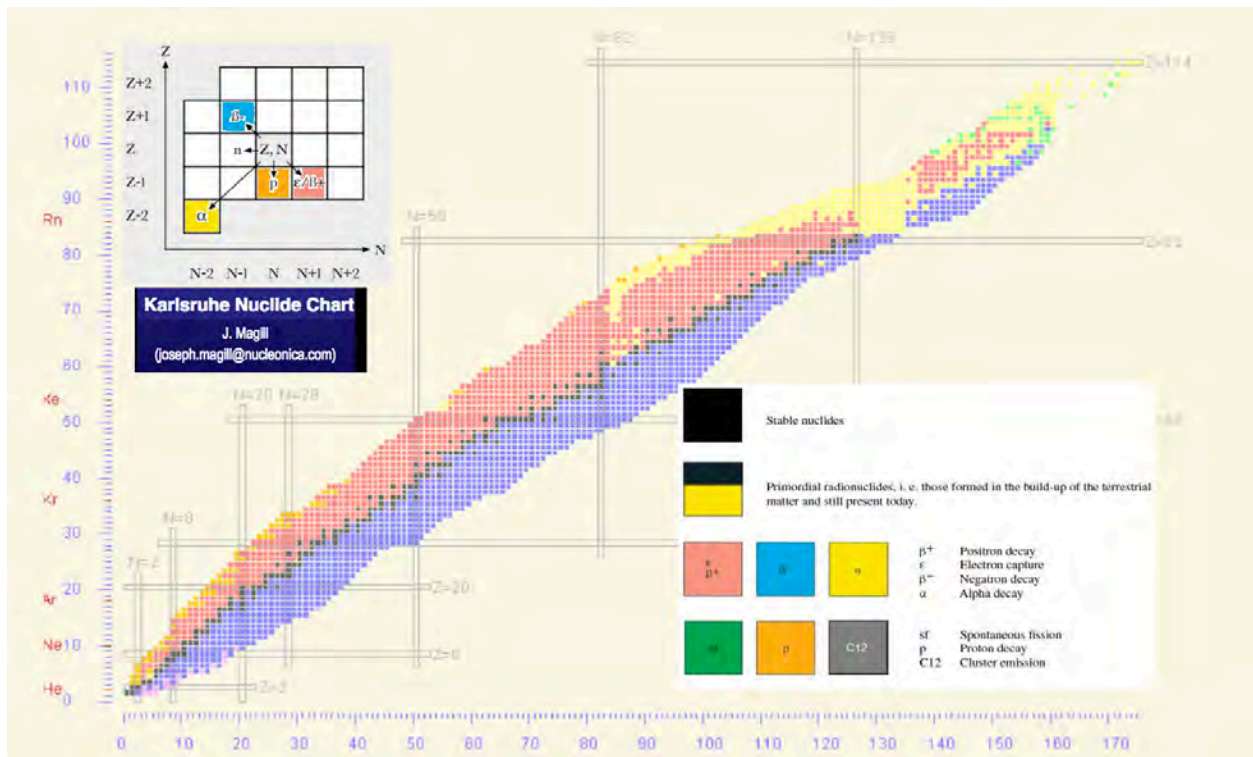
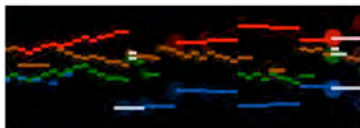
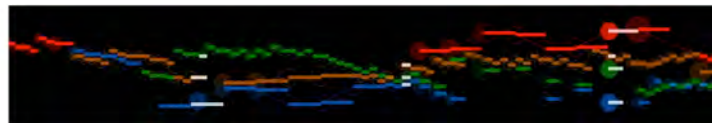

[6:15](#) Nucleosynthesis 1 sec 10 MeV Neutrino fog ends

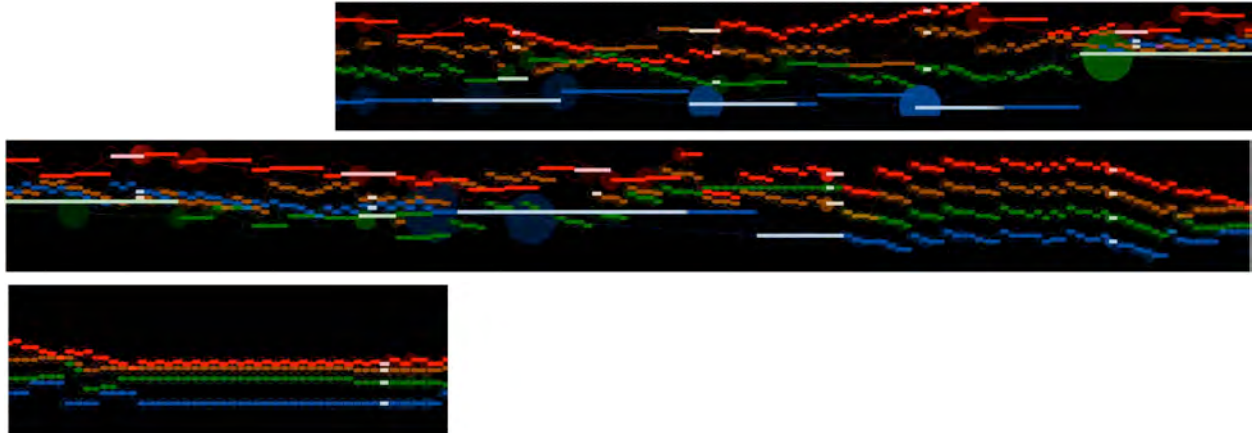

[7:22](#) Quaternionic Matter Expansion Begins 10^{11} sec 1 KeV

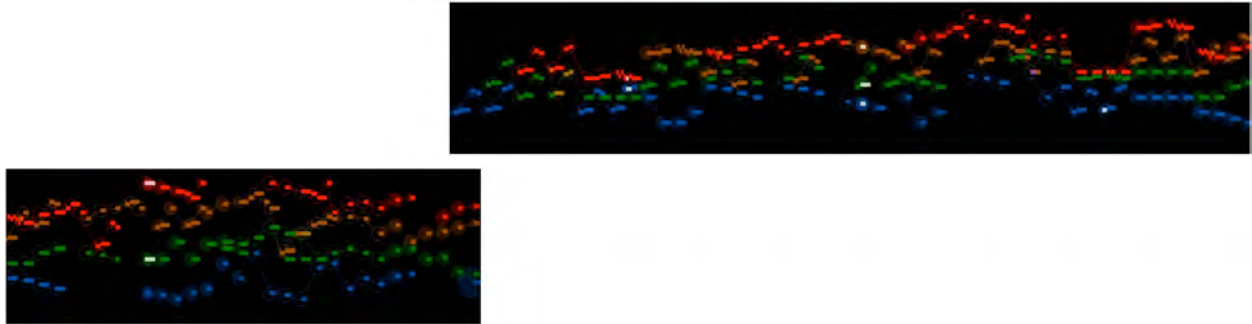

[7:57](#) Recombination Atoms Form at age 10^{13} sec 100,000 years 1 eV
Photon fog ends, Cosmic Microwave Background radiation at 3000 K
then (2.75 K now)
Dark Age begins

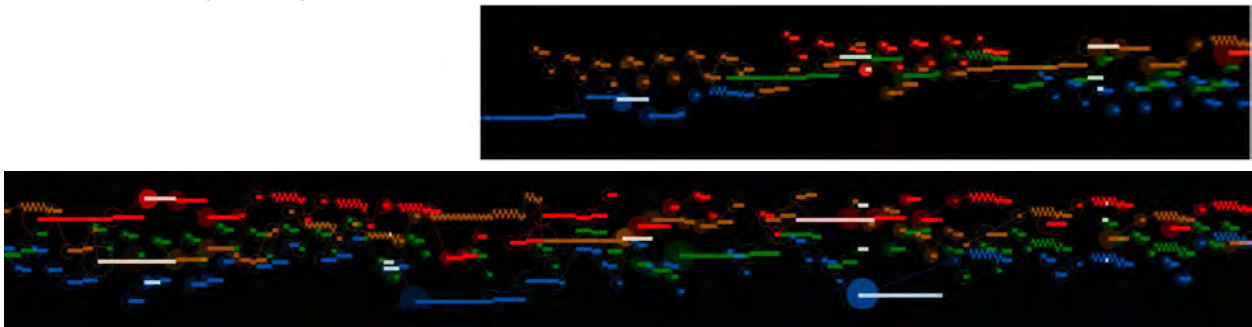

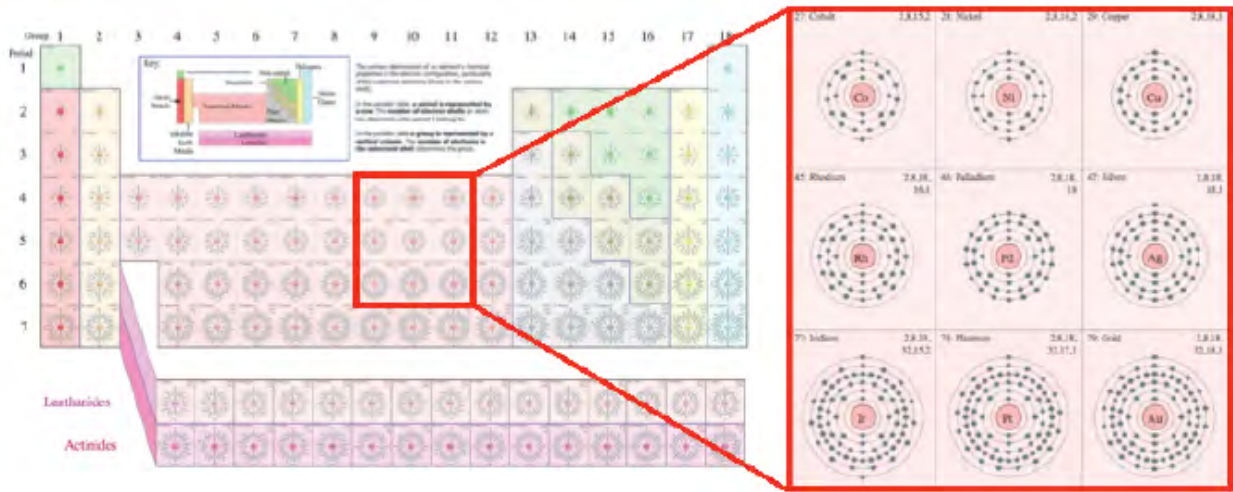
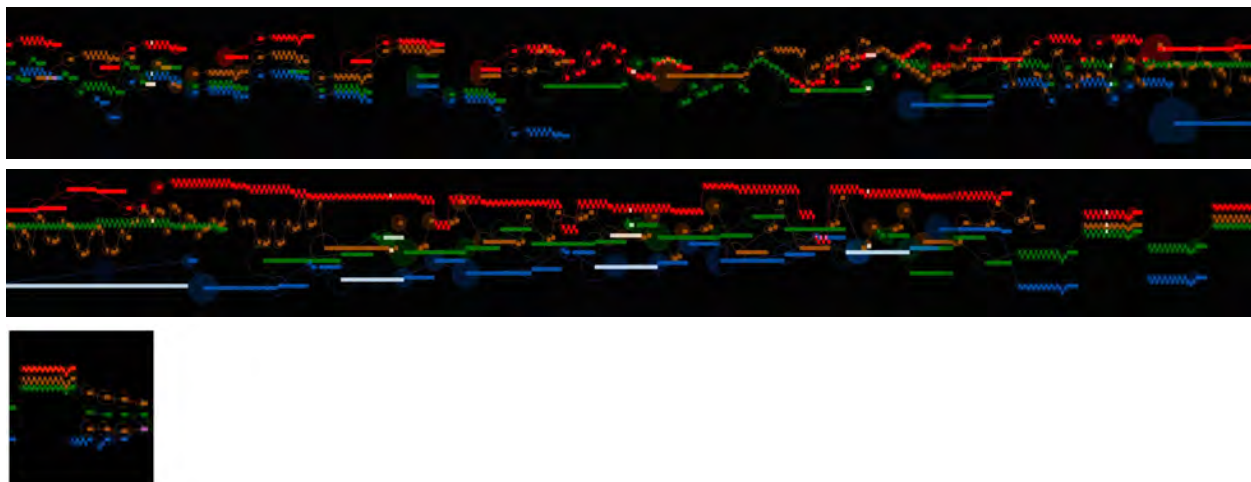

[10:00](#) First Stars burn H and He for heavy elements and photons to end Dark Age
by Reionization at age 400×10^6 years

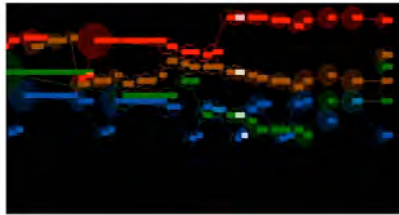
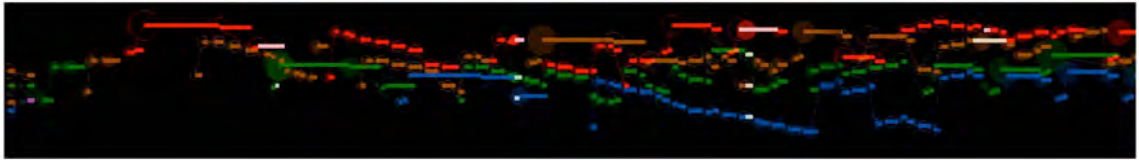

[10:37](#) Globular Clusters, then Galaxies, form 10^9 years

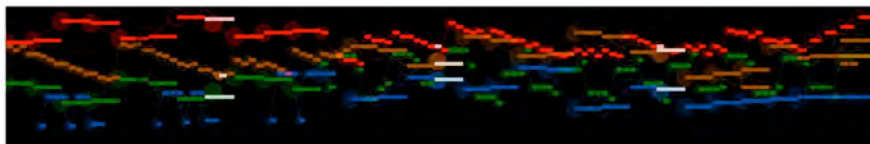
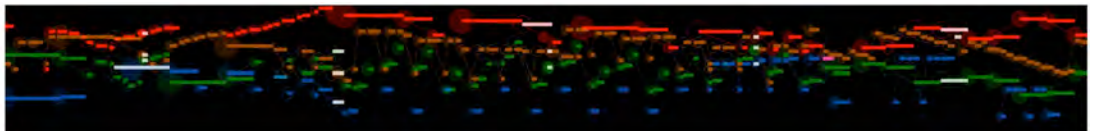
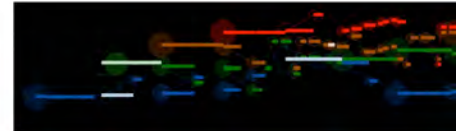

[11:48](#) Dark Energy Accelerated Expansion begins at about 6×10^9 years
= 7.5×10^9 years ago

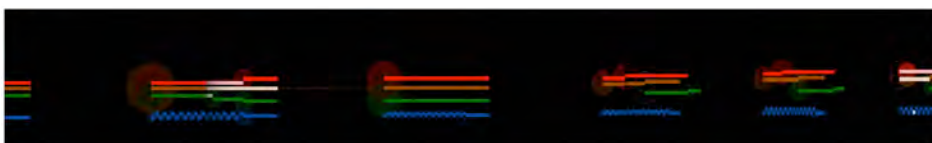

12:22 Solar System 4.5 x 10⁹ years ago

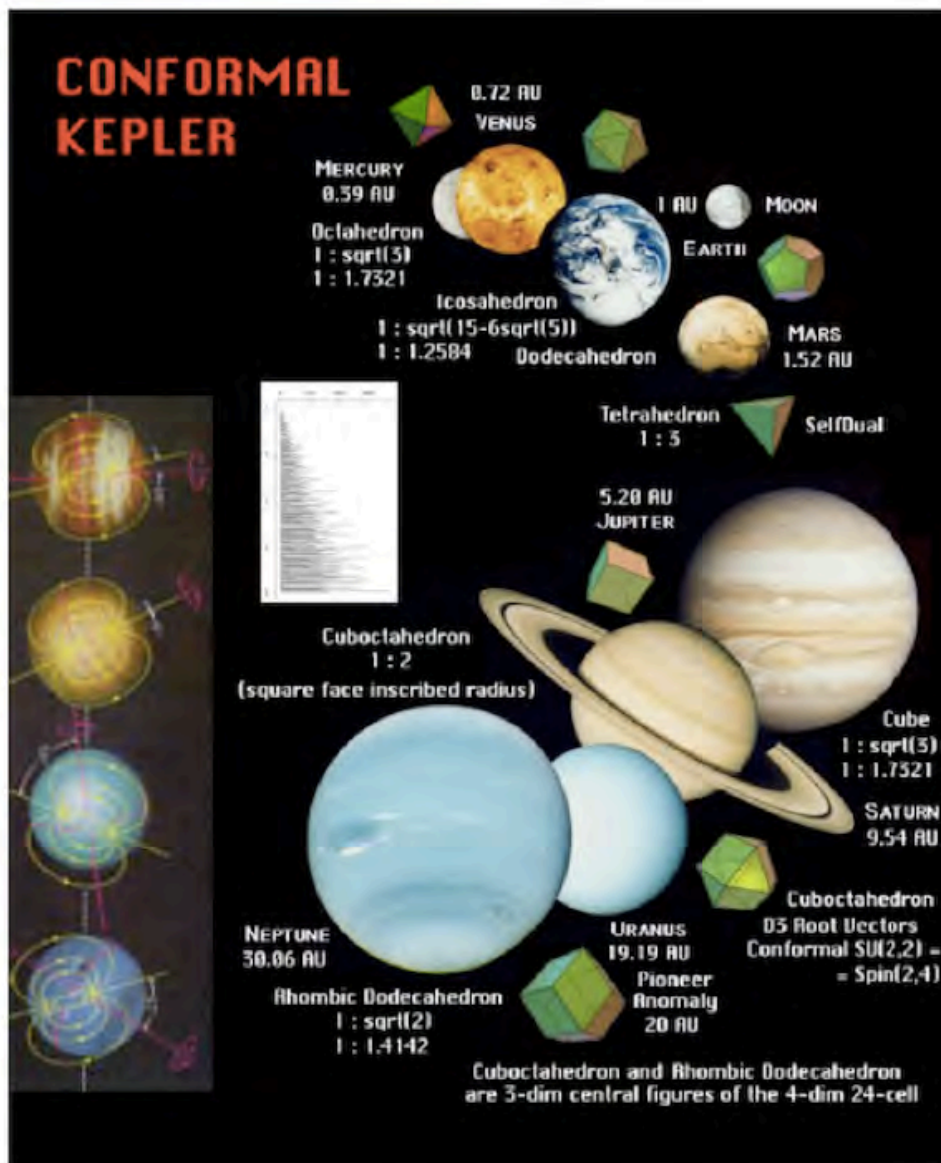
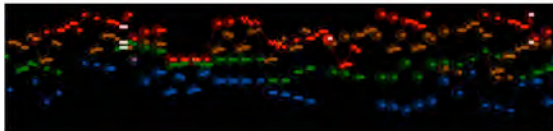

[12:48](#) Earth 4.5×10^9 years ago

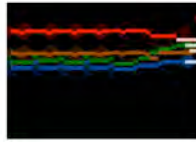

Moon by Collision 4.4×10^9 years ago



[13:02](#) Bacteria Life 4×10^9 years ago

The big event around 2×10^9 years ago was the start of biological production of atmospheric Oxygen.



[13:12](#) Cambrian explosion of Life 500×10^6 years ago

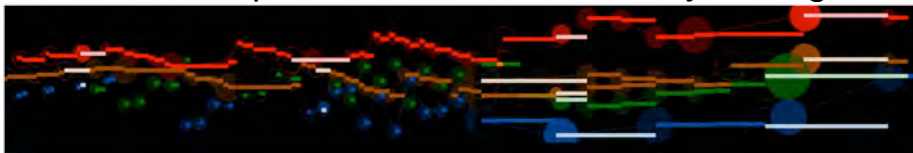

[13:42](#) Dolphin Life 20×10^6 years ago

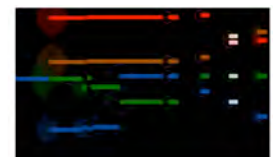

[13:49](#) Humans Evolve in Africa 100,000 years ago

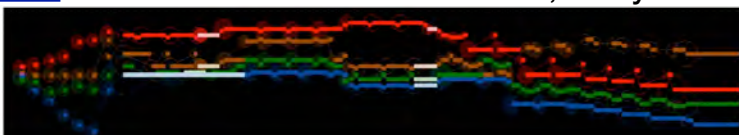

[14:57](#) African IFA - Lemurian Angkor Rig Veda - Atlantean Giza Britain America 40,000 years ago

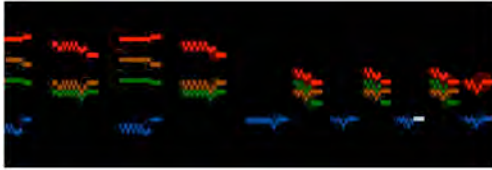

[15:09](#) Humans Disconnect from Hyperboreans

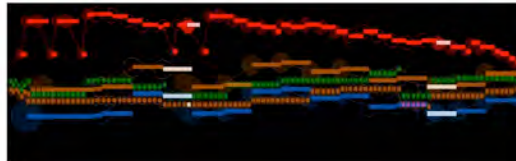

after Flood 12,000 years ago Humans use Technological Consciousness

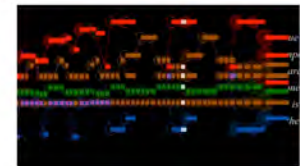

The Grosse Fugue History ends in 2012, as do the Mayan Calendar and the Timewave of Terence McKenna derived from the I Ching.

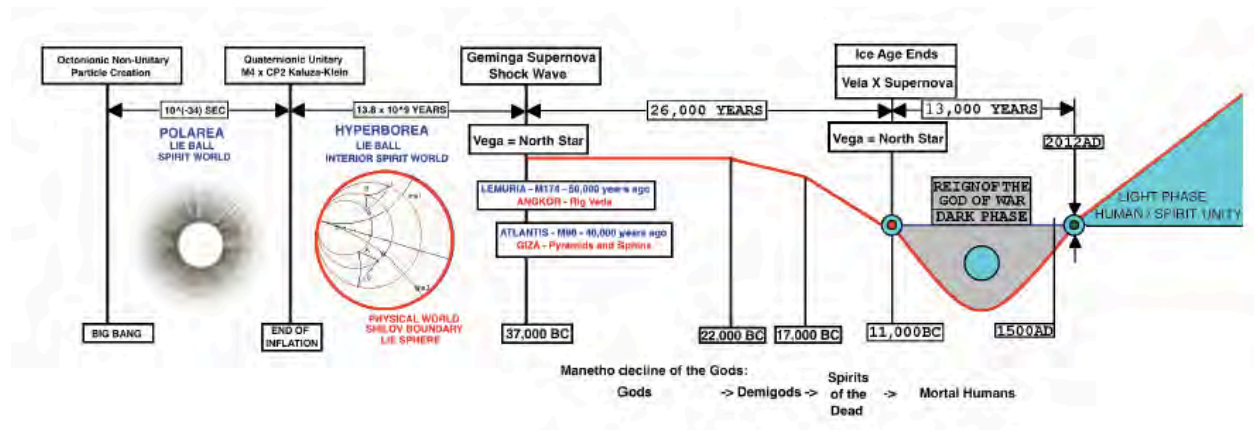

RED BOOK PHYSICS

How Jung's Red Book Archetypes connect with E8 - Cl(16) Physics (viXra 1602.0319)

Frank Dodd (Tony) Smith, Jr. - March 2018

The four pages after this cover summarize this paper.

E8 HEISENBERG CREATION-ANNIHILATION - $28+64+(63+1)+64=28$

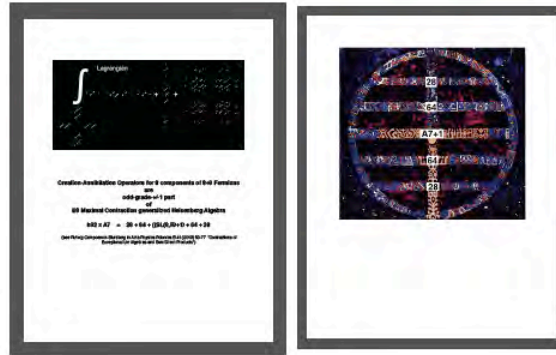

AFTER INFLATION - QUATERNIONIC UNITARY EXPANSION now - DE : DM : OM = 0.75 : 0.21 : 0.04

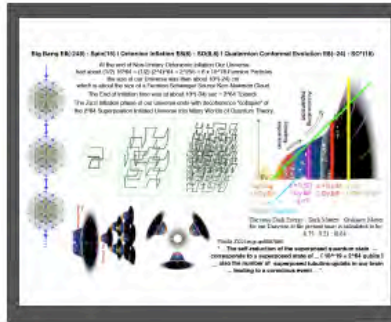

E8 = H4 STANDARD MODEL CP2 + H4 GRAVITY+DARK ENERGY M4 STRINGS = WORLD LINES 26D STRING THEORY - SPIN-2 BOHMIONS QUANTUM BLOCKCHAINS OF SCHWINGER SOURCES



HIGGS = NAMBU-JONA-LASINIO TRUTH QUARK COMPOSITE FERMILAB TRUTH QUARK MASSES 130 GeV - 174 GeV - 220 GeV CMS HIGGS MASSES 125 GeV - 195 GeV - 260 GeV

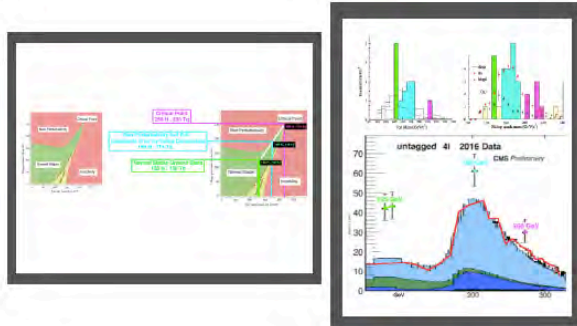

M4xCP2 KALUZA-KLEIN - MAYER HIGGS - 3 FERMION GENERATIONS

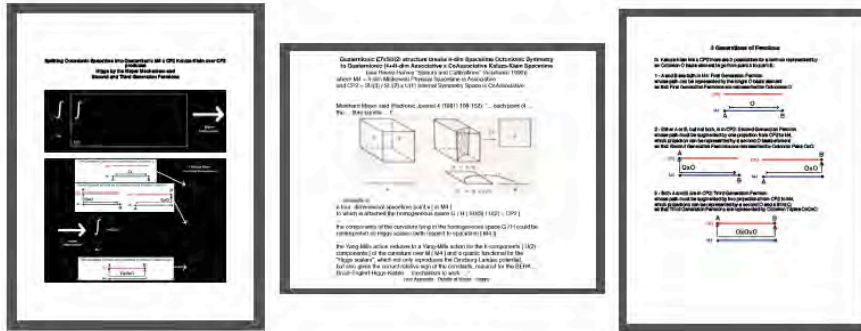

FERMION OCTONIONIC BRAIDS - FERMION MASSES

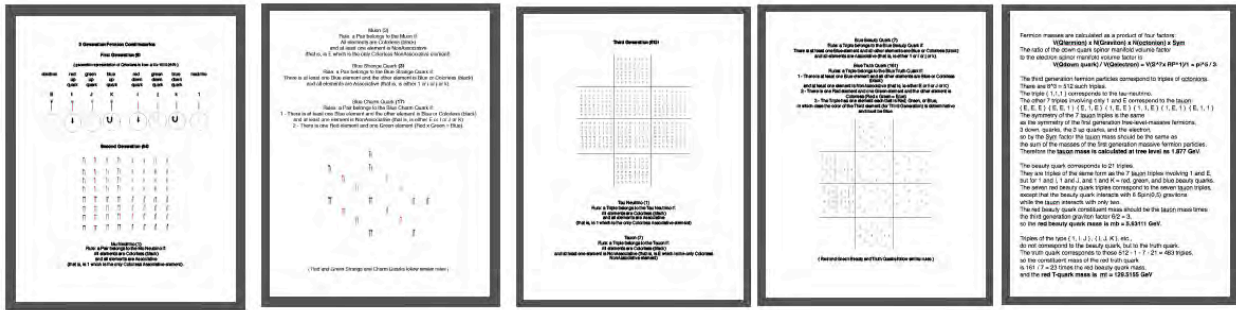

D4 STANDARD MODEL and GRAVITY+DE GHOSTS D4 GRAVITY+DE and STANDARD MODEL GHOSTS

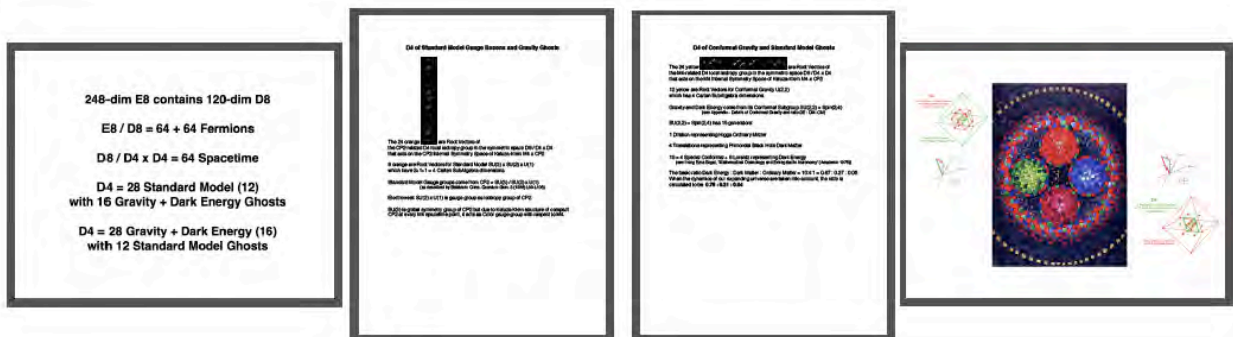

FORCE STRENGTHS - 4D LAGRANGIAN - CALCULATION RESULTS

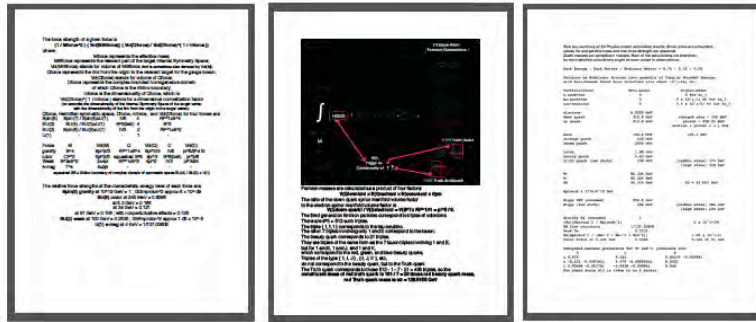

E8 - H4 - F4 - D4 - D3=A3 - H3 - H2=PENROSE STAR

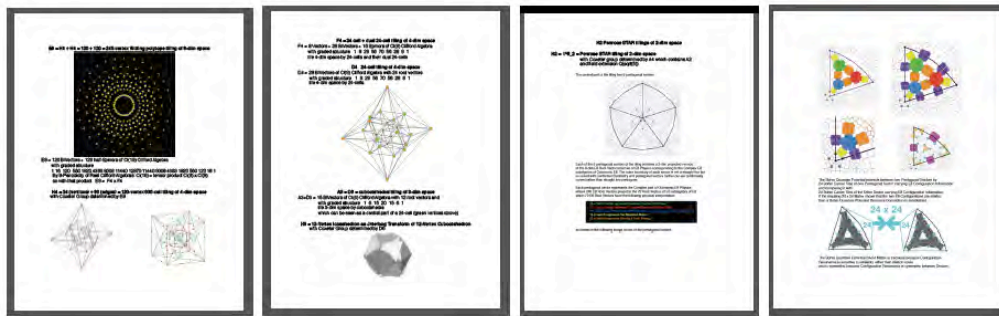

CELLULAR AUTOMATA - CL(8) - CL(16) - MICROTUBULE - PYRAMIDS

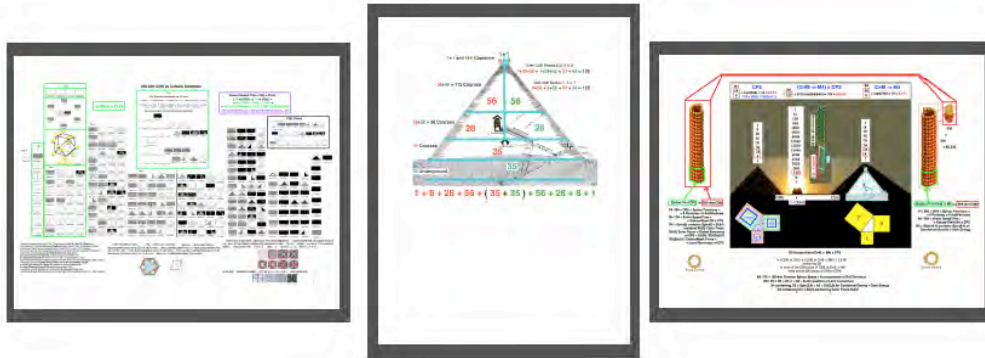

SHILOV BOUNDARY HUMAN MIND COMPLEX DOMAIN UNIVERSAL CONSCIOUSNESS

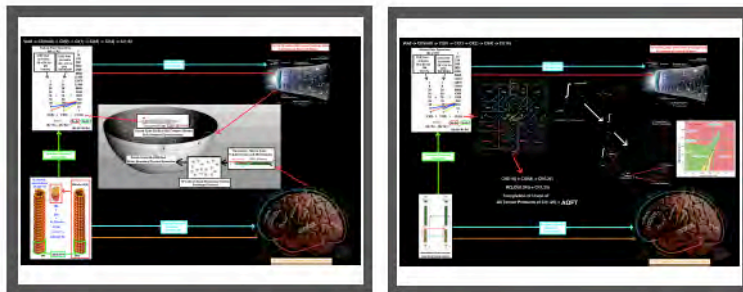

Evolution of Our Universe from VOID to Manetho's Rule of Gods

At Big Bang Initial Empty Set VOID grows by Finkelstein Clifford Iteration to $Cl(16) = Cl(8) \otimes Cl(8)$ which then during Inflation grows to large $Cl(16N)$ which factors by 8-Periodicity to N-fold tensor product of $Cl(16)$ with each local $Cl(16)$ containing E_8 describing local physics Lagrangian.

VOID	= $Cl(VOID) = 0$ -dim Integers
1 ∅	= $Cl(0) = 1$ -dim Real Numbers
1 1 ∅ (∅)	= $Cl(1) = 2$ -dim Complex Numbers
1 2 1 ∅ (∅) (∅ (∅)) (∅)	= $Cl(2) = 4$ -dim Quaternions
1 4 6 4 1 ∅ (∅) (∅ (∅)) ((∅) ((∅)) (∅ (∅))) (∅ (∅) ((∅)) (∅ (∅))) (∅) (∅ ((∅)) (∅ ((∅)) (∅ (∅)))) (((∅))) (∅ (∅ (∅))) (∅ (∅) (∅ (∅))) ((∅ (∅))) ((∅) ((∅))) (∅ (∅) ((∅))) (∅ (∅ (∅))) ((∅)) (∅ (∅))	= $Cl(4) = 16$ -dim

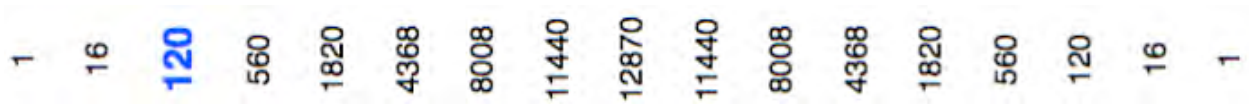

$$= Cl(16) = 2^{16} = 65,536\text{-dim} = ((64+64) + (64+64)) \times ((64+64) + (64+64))$$

$$120 + 64 + 64 = E_8$$

$$E_8 \text{ root vectors} = 112 + 64 + 64$$

E_8 represents Gauge Bosons, Ghosts, and First-Generation Fermions.

E8 has 3 Real Forms:

The compact form ... E8(-248) ... has symmetric space **E8/SO(16)** for Finkelstein Clifford Iteration from VOID to Cl(16)

Creation of first cell of 26D Lorentz Leech Lattice Spacetime with Cl(1,25) Monster Symmetry and Cl(16) local structure.

The split form, EVIII (or E8(8)) ... has symmetric space **E8/SO(8,8)** for Octonionic Inflation

Non-Unitary Octonionic Quantum Processes create many copies of the First Cl(16) cell and many Fermion Particles. Completion of the Union of All Tensor Products eof Cl(1,25) create generalized Hyperfinite II1 von Neumann factor AQFT.

EIX (or E8(-24)) ... has symmetric space **E8 / Sk(8,H) = E8 / SO*(16)** for Quaternionic Expansion

M4 x CP2 Kaluza-Klein produces Fermion Generations 2 and 3 and 3-state Higgs-Truth Quark Nambu-Jona-Lasinio system. CP2 = SU(3) / U(2)xU(1) gives Standard Model Gauge Groups. Conformal Spin(2,4) = SU(2,2) gives Gravity + Dark Energy.

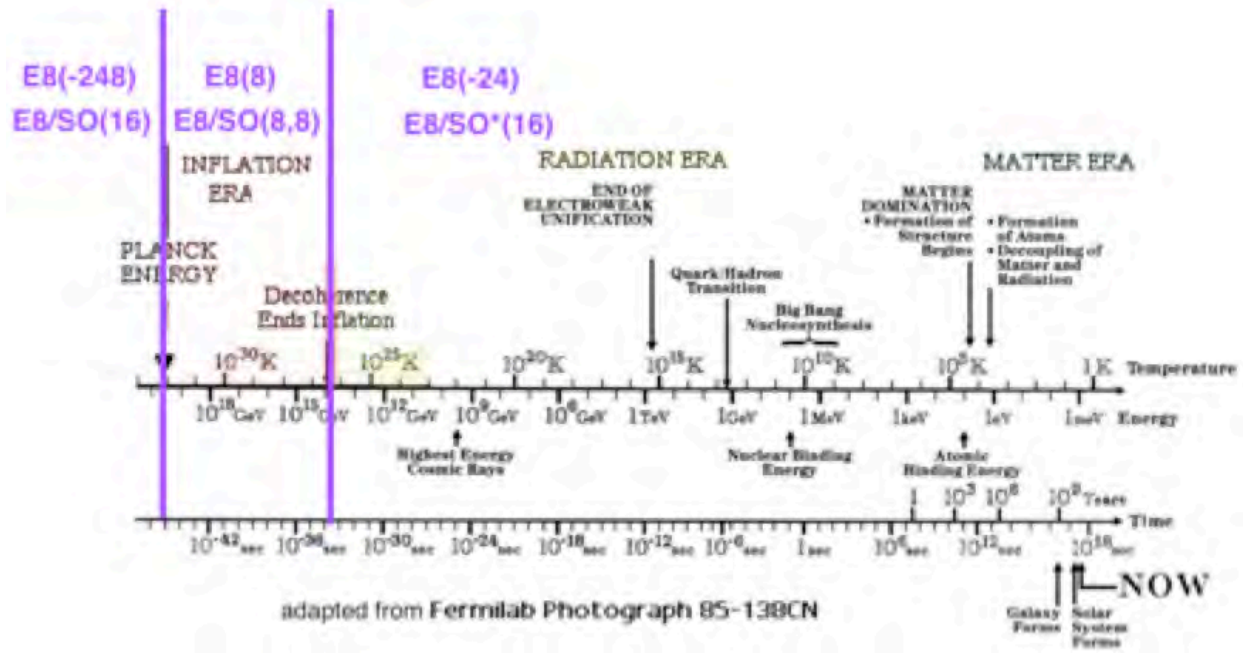

Rudolf Steiner describes History of this period in terms of his study of the Spirit World and how it relates to the Physical World (Geisteswissenschaft). In line with Paola Zizzi gr-qc/0007006 he sees Our Universe as Conscious, living in the Interior Spirit World of Complex Bounded Domain Lie Ball while the Physical World is the Shilov Boundary Lie Sphere that is related to the Interior Spirit World by the Poisson Kernel (see work of L. K. Hua). Steiner says "... this history ... is called the "Akasha Chronicle" ... root races of our earth.

The first is called the **Polarean** ...
 the second, the **Hyperborean** race ...
 the third human root race ... inhabited the **Lemurian** Continent ...
 originating the two sexes ... lay south of contemporary Asia ... could communicate ...[by]... "thought reading" ... the Lemurians ...[were the]...
 ancestors of the Atlanteans ... once ... the floor of the Atlantic Ocean ...".

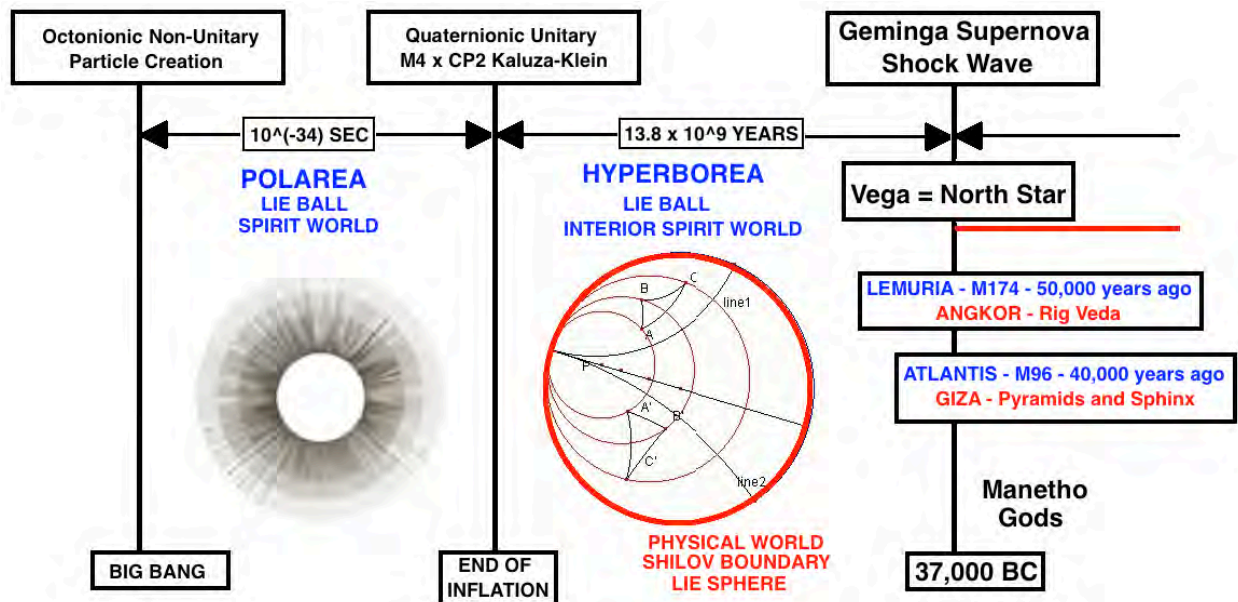

(diagram adapted from work of Henry Monteith.)

Africans, including those who were preparing to leave as Lemurians or Atlanteans, were the first Earth beings (with the possible exception of Dolphins) to connect with the Spirit beings of the Lie Ball Spirit World through the Poisson Kernel connection with the Lie Sphere Physical World that is described by the 16-dim Vector part of the Cl(16) Clifford Algebra.

The 16-dim Lie Ball $Spin(10) Spin(8) \times U(1)$ with Bounded Complex Domain of Hua Type IV(8) has Lie Sphere Shilov Boundary 8-dim Spacetime that is the Base Manifold for the $Cl(16)$ Lagrangian

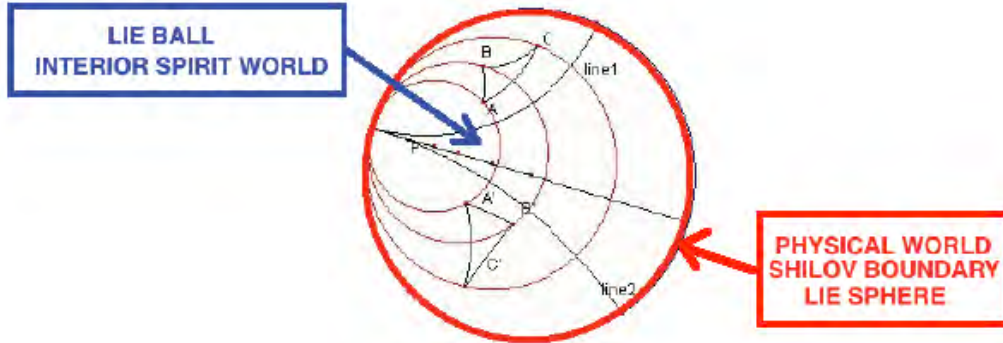

The 8-dim Spacetime has a Kaluza-Klein $M4 \times CP2$ structure with $CP2 = SU(3) / SU(2) \times U(1)$ Internal Symmetry Space and $M4 =$ Minkowski Physical Spacetime that is seen by Gauge Groups as

$S4$ by Gravity
 $CP2$ by Color Force
 $S2 \times S2$ by Weak Force
 $T4 = S1 \times S1 \times S1 \times S1$ by Electromagnetism

Loo-Keng Hua in his book Harmonic Analysis of Functions of Several Complex Variables in the Classical Domains describes the structure of Bounded Complex Domains and their Shilov Boundaries such as:

Weak Force
 $SU(2)$ for $Spin(5) / SU(2) \times U(1)$ - Type IV Domain with Shilov Boundary = $RP^1 \times S^2$

Color Force
 $SU(3)$ for $SU(4) / SU(3) \times U(1)$ - Type I Domain B^6 (ball) with Shilov Boundary S^5

Gravity
 $Spin(5)$ for $Spin(7) / Spin(5) \times U(1)$ - Type IV Domain with Shilov Boundary $RP^1 \times S^4$

Hua calculated their Poisson Kernels and Bergman Kernels that act as Green's Function Propagators for Schwinger Sources.

Note - Hua uses the term "Characteristic Manifold" for "Shilov Boundary".

The National Geographic Genographic Project studied the migration of Humans out of Africa using Y-DNA data. The first group to leave Africa was **Lemurian M174** about 50,000 years ago along the cyan line in the map below:

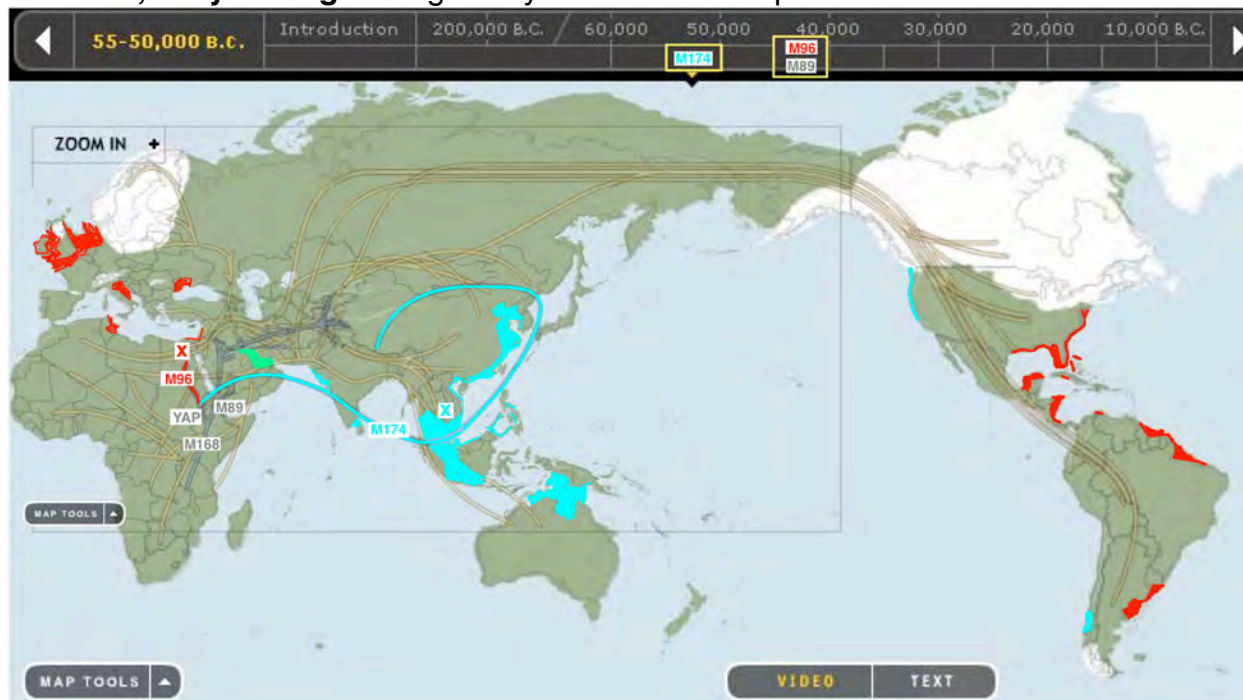

At that time all the area colored cyan was dry land and home of many Lemurians. The x colored cyan is the location of the Angkor Temple Complex that I think was built by the Lemurians shortly after they arrived. I think they also then developed Sanskrit and wrote the Rig Veda to preserve the high culture they had developed back in Africa. Lemurians crossed the Pacific Ocean to the West Coast of the Americas.

Rig Veda

Akshar	Budhi	Manas	Akash	Vayu	Agni	Jal	Pitru	Akshar	Budhi	Manas	Akash	Vayu	Agni	Jal	Pitru	Akshar	Budhi	Manas	Akash	Vayu	Agni	Jal	Pitru
सु	नि	मी	ले	पु	रो	हि	तं	य	ज्ञ	स्यं	दे	व	मू	त्वि	जम्	हो	तां	रं	र	नु	धा	तं	मम्
AS	NI	MI	LE	PU	RO	HI	TAM	YA	JYA	SYA	DE	VA	MU	TVI	JAM	HU	TA	RAM	RA	NU	DHA	TA	MAM
सु	भिः	पु	रै	भिः	अ	भिः	पु	री	ह	सो	नु	तं	दे	द	त	स	डे	रं	ए	ह	वं	च	मि
श	मि	नां	इ	भि	धं	इव	तु	यो	धं	मे	प	दि	वे	दि	वे	सु	श	रै	वी	र	वं	त	मम्
स	मे	यं	यु	ह	मं	श्व	रं	त्रि	ध	तं	प	दि	पु	रं	सिं	स	इ	दे	वे	पुं	ग	स्व	ति
सु	भिः	हो	नां	क	भि	कं	तु	स	स्व	वि	त	अं	व	स्त	मः	डे	यो	दे	वे	पि	रा	गं	मम्
प	दु	हं	दा	सु	भं	तु	वं	स	तं	प	हं	क	दि	प्य	सिं	त	वेत्	तत्	स	त्वं	मं	हि	रः
उ	धं	त्वा	मे	दि	वे	दि	पु	या	धं	व	स्त	वि	या	वु	मम्	न	मो	म	रं	नु	ए	मं	भि
रा	जं	न्त	म	श्व	रा	शो	गो	या	मु	त	स्व	दी	दि	वि	म्	व	धं	मा	तुं	सु	वे	द	पं
स	नं	पि	ते	वं	सु	न	वे	अ	तं	सु	धा	यु	नो	वं	व	भ	वं	सु	धा	नः	स्त	स्त	धं

24 First Richa Syllables + 24 First Richa Gaps = D4sm + D4gde (purple box)

8x8 = 64 Last-8 Syllables of Last 8 lines = D8 / D4sm x D4gde (blue box)

8x8 = 64 (red box) plus 8x8 = 64 (green box) give 128 = E8 /D8 = Fermions
Middle-8 Syllables of Last 8 lines plus First-8 Syllables of Last 8 Lines

Somewhat later, **about 40,000 years ago, another group, the Atlantean M96**, migrated up the Nile River to Giza, marked by the x colored red, where I think the Atlanteans built the Great and Second Pyramids and the Sphinx shortly after they arrived in Giza, encoding African wisdom in those structures. At that time all the area colored red was dry land and home of many Atlanteans. Atlanteans crossed the Atlantic Ocean to the East Coast of the Americas.

Yet another group, M89, Humans neither Lemurian nor Atlantean, migrated by crossing the Red Sea. Their descendants are now 90-95 percent of all non-Africans. About 12,000 years ago the red part of Atlantis and the cyan part of Lemuria were submerged by floods from melted glaciers leading to conflicts over the lesser resources.

As M174 Lemurians and M96 Atlanteans merged with M89 Humans their Spiritual capabilities decreased and conflicts resembled wars between M174 Lemurians to the East and M96 Atlanteans to the West of a Middle Ground near the Garden of Eden.



Some of the Atlantean-Lemurian conflicts were

- Egyptian-Babylonian battles of Megiddo and Carchemish around 2600 years ago
- Greco-Persian Wars around 2500 years ago
- Alexander the Great around 2300 years ago

After the victories of Alexander the Great, his friend, historian, and general Ptolemy I ruled Egypt and its cultural center Alexandria and commissioned Manetho to document history. Manetho's history of Humans included:

36,525 years ago - Rule of Gods = M174 Lemurians and M96 Atlanteans -
 - North Star Vega - Geminga Supernova Shock Wave hits Earth

22,625 years ago - Rule of Demigods

Lemurian and Atlantean Spiritual Capabilities begin to decline

17,413 years ago - Rule of Spirits of the Dead =

= Lemurians and Atlanteans have lost much of their Spritual Capabilities
 and try to rule by remembering lost abilities

11,600 years ago - Rule of Mortal Humans = M89 Humans -

- floods - Technology dominates Spirit -
- North Star Vega - Vela X Supernova - Taurid / Encke comet fragmented

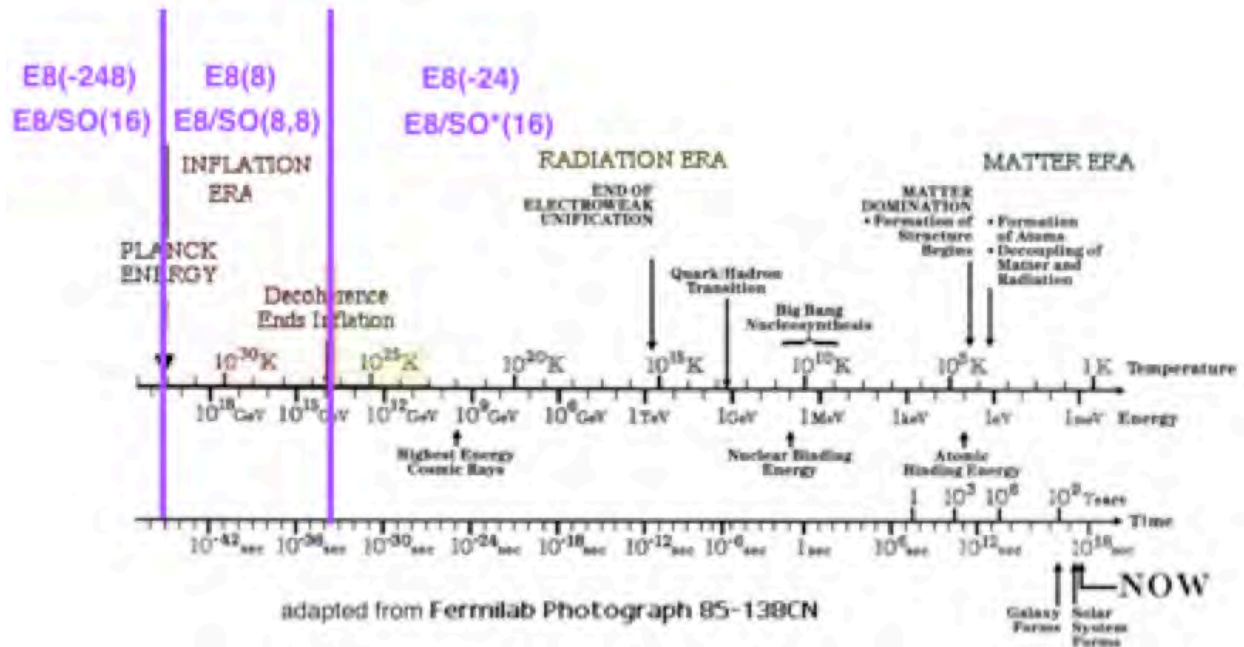

At, and prior to, the end of the Octonionic Inflation Era 10^{-44} sec Planck Time to 10^{-34} sec Our Universe was a Conscious Superposition of 10^{19} States.

NOW in this Quaternionic Conformal Expansion Era Human Brain Microtubules are Conscious with 10^{19} Tubulins.

The 2^{64} qubits created by Inflation is roughly 10^{19} which is roughly the number of Quantum Consciousness Tubulins in the Human Brain.

Therefore

the Human Brain Quantum Consciousness has evolved in Our Universe to be equivalent to the Maximum Consciousness of Our Inflationary Era Universe.

Each cell of E8 Lagrangian Spacetime corresponds to 65,536-dim $Cl(16)$.

Human Brain Microtubules 40 microns long have 65,536 Tubulin Dimers.

So, at any and all Times the State of Consciousness of a Human

is in exact Resonant Correspondence with

a subset of the Cells of E8 Lagrangian Spacetime

and

E8 Lagrangian Spacetime (as a Nambu-Jona-Lasinio Condensate)

is effectively the Spirit World

in which the Human States of Consciousness = Souls exist.

Spirit Souls continue to exist in Our Universe after death of Physical Body

Evolution of Our Universe from Manetho's Decline of Gods to Now

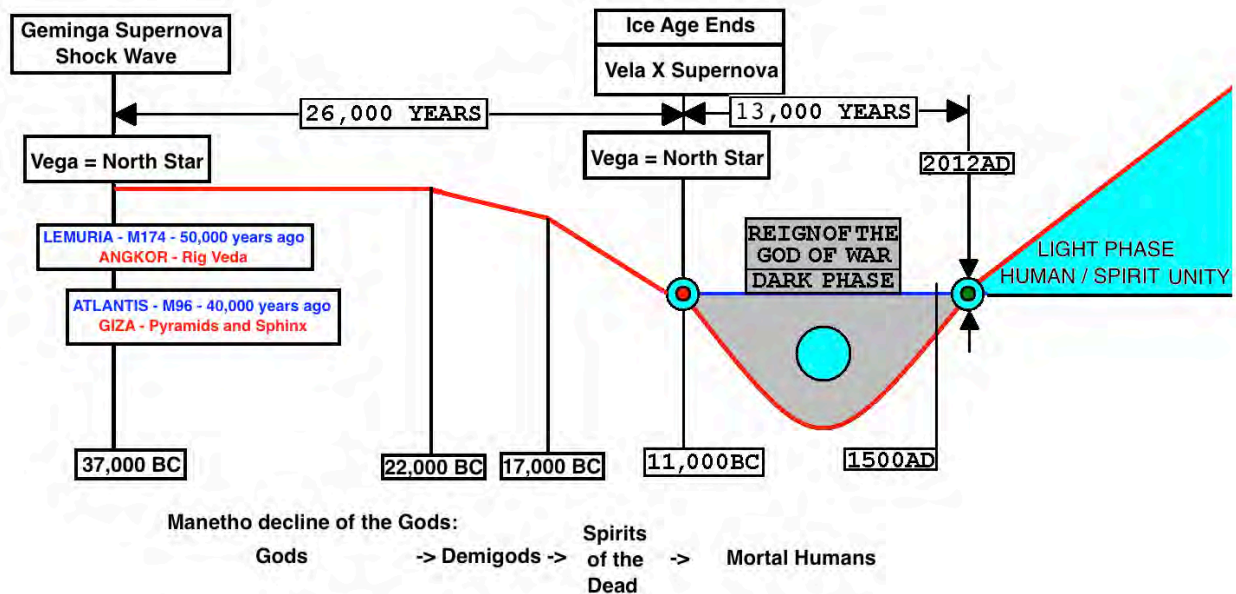

(diagram adapted from work of Henry Monteith.)

Human History moves along two tracks. Now, with Physical Humans having Consciousness based Microtubules in Resonance with Spirit Space Cl(16) Cells, the two tracks of Human History are moving in concert together but in earlier times before the Physical Ancestors of Humans had fully developed Microtubule Quantum Consciousness there was no Resonant Connection with Spirit Space Cl(16) Cells and the evolutionary History of the Spirits of Humanity was quite independent of and different from the evolutionary History of the Physical Ancestors of Humanity.

This was known to Rudolf Steiner in his 1909 book Cosmic Memory about the History of the Spirits of Humanity: "... this history ... is called the **"Akasha Chronicle"** ... root races of our earth.

The first is called the **Polarean** ... the second, the **Hyperborean** race ... the third human root race ... inhabited the **Lemurian** Continent ... originating the two sexes ... lay south of contemporary Asia ... could communicate ... [by]... "thought reading" ... the Lemurians ... [were the]... ancestors of the Atlanteans ... once ... the floor of the Atlantic Ocean ...".

Africans, including those who were preparing to leave as Lemurians or Atlanteans, were the first Earth beings (with the possible exception of Dolphins) to connect with the Spirit beings of the Lie Ball Spirit World through the Poisson Kernel connection with the Lie Sphere Physical World that is described by the 16-dim Vector part of the Cl(16) Clifford Algebra.

The National Geographic Genographic Project studied the migration of Humans out of Africa using Y-DNA data. The first group to leave Africa was **Lemurian M174** about 50,000 years ago along the cyan line in the map below:

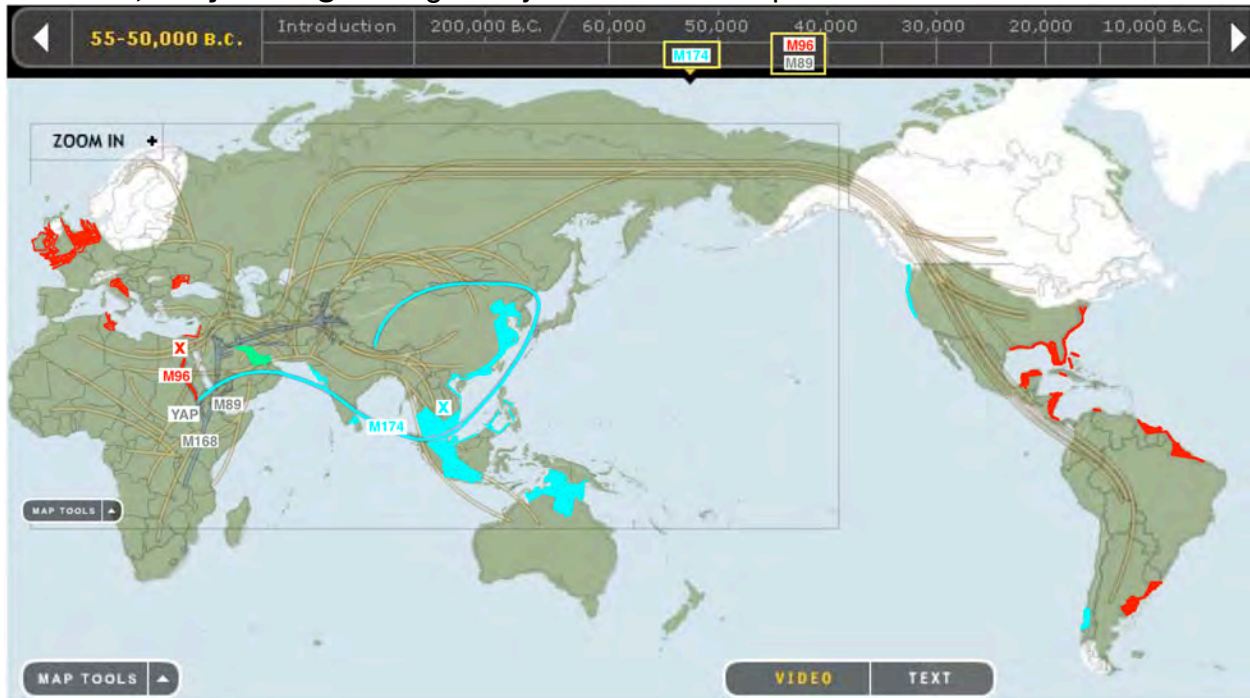

At that time all the area colored cyan was dry land and home of many Lemurians. The x colored cyan is the location of the Angkor Temple Complex that I think was built by the Lemurians shortly after they arrived. I think they also then developed Sanskrit and wrote the Rig Veda to preserve the high culture they had developed back in Africa. Lemurians crossed the Pacific Ocean to the West Coast of the Americas.

Rig Veda

Akshar	Budhi	Manas	Akash	Vayu	Agni	Jal	Prithvi	Akshar	Budhi	Manas	Akash	Vayu	Agni	Jal	Prithvi	Akshar	Budhi	Manas	Akash	Vayu	Agni	Jal	Prithvi
सु	नि	मी	ले	पु	रो	हि	तं	य	ज्ञ	स्यं	दे	व	मु	त्वि	जम्	हो	तां	रे	र	लु	धा	तं	मम्
AK	NI	MI	LE	PU	RO	HI	TAM	YA	JNA	SYA	DE	VA	MRI	TVI	JAM	HU	TA	RAM	RA	TNA	DHA	TA	MAM
सु	भिः	पु	वै	भिः	भ	भि	भि	री	ड	सो	नु	तं	ने	रु	व	स	डे	वां	ए	इ	वं	च	ति
स	भि	नां	ड	भि	भं	भ	भ	लो	वं	दे	प	दि	वे	दि	के	सु	श	वै	सो	र	वं	त	मम्
स	मे	यं	पु	ज्ञ	मं	भू	रं	त्रि	भ	के	प	दि	पु	र	सिं	स	ह	दे	वे	पुं	ग	स्य	ति
पु	भिः	हो	वां	क	भि	के	तु	स	त्पश्	त्रि	व	वं	व	स्त	पः	दे	वो	दे	वे	वि	दा	नं	मव
प	द	ज्ञ	दा	रु	के	तु	वं	स	ते	प	ह	क	रि	व्य	त्रि	स	वेत्	तव	स	त्व	मं	त्रि	रः
उ	ए	त्वा	शे	वे	वे	पु	वे	स	ते	प	ह	क	रि	व्य	त्रि	न	सो	भ	रं	नु	ए	मं	भि
रा	वं	त्वा	म	व्य	दा	खीं	गो	पा	मु	व	स्य	दी	दि	वि	पु	व	धै	मा	तुं	सु	वे	द	सं
स	नैः	पि	ते	वं	यु	न	वे	स	ते	सु	पा	पु	नो	वं	व	भ	वं	सु	भा	नः	स्तु	स्त	यं

24 First Richa Syllables + 24 First Richa Gaps = D4sm + D4gde (purple box)
 8x8 = 64 Last-8 Syllables of Last 8 lines = D8 / D4sm x D4gde (blue box)
 8x8 = 64 (red box) plus 8x8 = 64 (green box) give 128 = E8 / D8 = Fermions
 Middle-8 Syllables of Last 8 lines plus First-8 Syllables of Last 8 Lines

Somewhat later, **about 40,000 years ago, another group, the Atlantean M96**, migrated up the Nile River to Giza, marked by the x colored red, where I think the Atlanteans built the Great and Second Pyramids and the Sphinx shortly after they arrived in Giza, encoding African wisdom in those structures. At that time all the area colored red was dry land and home of many Atlanteans. Atlanteans crossed the Atlantic Ocean to the East Coast of the Americas.

Yet another group, M89, Humans neither Lemurian nor Atlantean, migrated by crossing the Red Sea. Their descendants are now 90-95 percent of all non-Africans. About 12,000 years ago the red part of Atlantis and the cyan part of Lemuria were submerged by floods from melted glaciers leading to conflicts over the lesser resources.

As M174 Lemurians and M96 Atlanteans merged with M89 Humans their Spiritual capabilities decreased and conflicts resembled wars between M174 Lemurians to the East and M96 Atlanteans to the West of a Middle Ground near the Garden of Eden.



Some of the Atlantean-Lemurian conflicts were

- Egyptian-Babylonian battles of Megiddo and Carchemish around 2600 years ago
- Greco-Persian Wars around 2500 years ago
- Alexander the Great around 2300 years ago

After the victories of Alexander the Great, his friend, historian, and general Ptolemy I ruled Egypt and its cultural center Alexandria and commissioned Manetho to document history. Manetho's history of Humans included:

36,525 years ago - Rule of Gods = M174 Lemurians and M96 Atlanteans -
 - North Star Vega - Geminga Supernova Shock Wave hits Earth

22,625 years ago - Rule of Demigods

Lemurian and Atlantean Spiritual Capabilities begin to decline

17,413 years ago - Rule of Spirits of the Dead =

= Lemurians and Atlanteans have lost much of their Spritual Capabilities
 and try to rule by remembering lost abilities

11,600 years ago - Rule of Mortal Humans = M89 Humans -

- floods - Technology dominates Spirit -
- North Star Vega - Vela X Supernova - Taurid / Encke comet fragmented

During Manetho's Rule of Gods the Lemurians built the Angkor Temples and wrote the Rig Veda:



Angkor Thom: 8 yellow Outer Towers + 16 green Middle Towers =
 = 24-dim $OxOxO$ of $Fr_3(O)$ 26-D String=World-Line Theory
 1 orange Inner Tower = Bohm Quantum Potential from $Cl(16)$ TriVectors
 4 red + 12 Gray Inner Towers = Fundamental Lepton + Quark
 Particles / AntiParticles from $Cl(16)$ half-spinors

Angkor Wat: 4 yellow Inner Towers = 4-dim Minkowski Physical Spacetime
 of Kaluza-Klein $M_4 \times CP^2$ from $Cl(16)$ BiVectors
 4 orange Middle Towers = 4-dim $CP^2 = SU(3) / SU(2) \times U(1)$ Internal Space
 of Kaluza-Klein $M_4 \times CP^2$ from $Cl(16)$ BiVectors

Phnom Bakheng: 64 cyan Towers = $D_8 / D_4 \times D_4 =$ by $Cl(16)$ Triality =
 = ++half-Spinor Fermion Particles (8 components) =
 = -half-Spinor Fermion AntiParticles (8 components)
 = $64 + 64 = 128 = E_8 / D_8$

According to **The Constitution of the Universe by Maharishi Mahesh Yogi**, printed in The Wall Street Journal (6 January 1992) a copy of which was sent to me in pamphlet form by John Small in August 2003:

"... the ancient Vedic wisdom ... identifies a single, universal source of all orderliness in nature ... the Constitution of the Universe ... is embodied in the very structure of the sounds of the Rik Ved, the most fundamental aspect of the Vedic literature ...

According to Maharishi's Apaurusheya Bhashya, the structure of the Ved provides its own commentary ... The knowledge of the total Ved ... is contained in the first sukt of the Rik Ved ... The precise sequence of sounds is highly significant; it is in the sequential progression of sound and silence that the true meaning and content of the Ved reside ...

The complete knowledge of the Ved contained in the first sukt (stanza) is also found in the first richa (verse) - the first twenty-four syllables of the first sukt (stanza 1).

This complete knowledge is again contained in the first pad, or first eight syllables of the first richa, and is also found in the first syllable of the Ved, 'AK', which contains the total dynamics of consciousness knowing itself.

According to Maharishi's Apaurusheya Bhashya of the Ved, 'AK' describes the collapse of the fullness of consciousness (A) within itself to its own point value (K).

This collapse, which represents the eternal dynamics of consciousness knowing itself, occurs in eight successive stages.

In the next stage of unfoldment of the Ved, these eight stages of collapse are separately elaborated in the eight syllables of the first pad, which emerges from, and provides a further commentary on, the first syllable of Rik Ved, 'AK'.

These eight syllables correspond to the eight 'Prakritis' (Ahamkar, etc.) or eight fundamental qualities of intelligence ...

The first line, or 'richa', of the first sukt, comprising 24 syllables, provides a further commentary on the first pad (phrase of eight syllables);

The first pad expresses the eight Prakritis ... with respect to the knower ... observer ... or 'Rishi' quality of pure consciousness.

The second pad expresses the eight Prakritis with respect to the process of knowing ... process of observation ... of 'Devata' (dynamism) quality of pure consciousness.

The third pad expresses the eight Prakritis with respect to the known ... observed ... or 'Chhandas' quality of pure consciousness. ...

The subsequent eight lines complete the remainder of the first sukt - the next stage of sequential unfoldment of knowledge in the Ved. These eight lines consist of 24 padas (phrases), comprising $8 \times 24 = 192$ syllables. ... these 24 padas of eight syllables elaborate the unmanifest, eight-fold structure of the 24 gaps between the syllables of the first richa (verse). ... Ultimately, in the subsequent stages of unfoldment, these 192 syllables of the first sukt (stanza) get elaborated in the 192 suktas that comprise the first mandal (circular cyclical eternal structure) of the Rik Ved, which in turn gives rise to the rest of the Ved and the entire Vedic literature. ...".

According to Wikipedia:

“... Indra is praised as the highest god in 250 hymns of the Rigveda ... the earliest reference to a net belonging to Indra is in the Atharva Veda ... "Indra's net" is the net of the Vedic deva Indra, whose net hangs over his palace on Mount Meru, the axis mundi of Buddhist and Hindu cosmology. In this metaphor, Indra's net has a multifaceted jewel at each vertex, and each jewel is reflected in all of the other jewels. ...

Aspects of Indra as a deity are cognate to other ... thunder gods

...

Chango is the most feared god in Santería ... Şàngó is viewed as the most powerful ... orisha ... He casts a "thunderstone" to earth, which creates **thunder** and lightning ... Chango ... had three wives ... Princess Oshun, Princess Oba, and Princess Oya ... Oshun is the deity of the river ... She is connected to destiny and **divination** ... The abèbè is the ritual object most associated with Oşun. The abèbè is a fan in circular form ... with a **mirror** in the center ...”.

**Chango and Indra both use Thunder,
and Chango's wife Oshun does Divination with a Mirror so
Chango and Oshun are two of the African IFA Orishas
who are precursors of Vedic Indra and Indra's Net.**

**Japan, the next stop beyond Sunda of Human M174 migration Out of Africa,
has 128-element (Dixon Spinor part of IFA) Futomani Divination and similar
culture:**



**the sacred Yata no Kagami, or Eight-Handed Mirror -
- analogous to Indra Net Reflections
the Sword Kusanagi no Tsurugi - analogous to ThunderBolts
the curved Yasakani no Magatama Jewel - analogous to Indra Jewels**

Graham Hancock, in Heaven's Mirror, said "... Our current world age is Pisces because on the spring equinox ... Pisces rises just ahead of the sun ... because of precession ... (1 degree in 72 years) ... the sun spends around 2160 years [2160 = second layer vertices of all E8 Lie Algebra Lattices] in each constellation - a complete revolution taking 26,000 years! The great Hindu temple-complex ... spread over 200 square miles confirms that they correspond to the stars in the constellation of Draco, as they appeared in 10,500 BC! ...

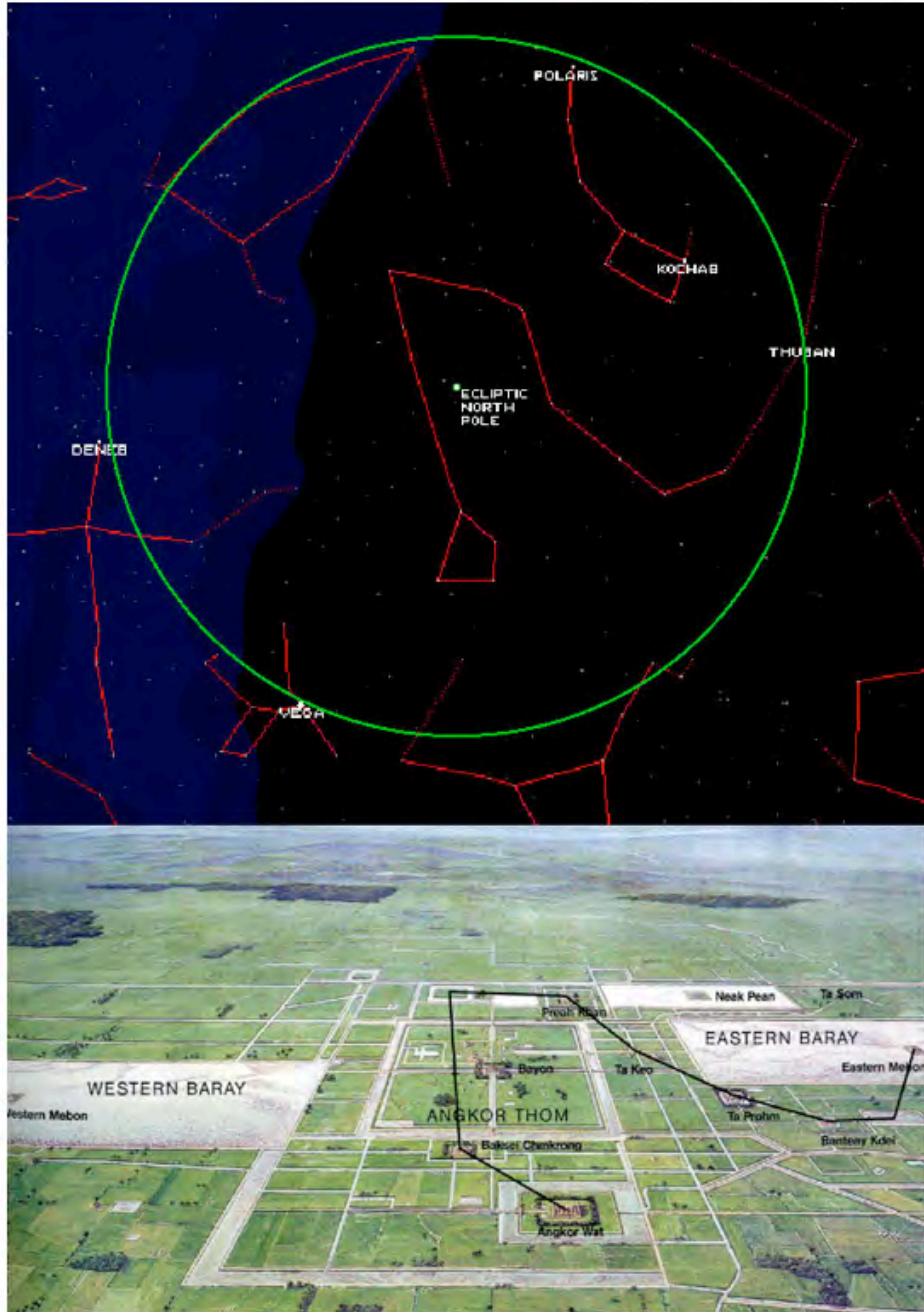

The same star configuration of 10,500 BC = 12,500 years ago would have appeared in the previous precession period about 38,500 years ago, with Vega as North Star and Angkor Thom as the Ecliptic North Pole, about the time humans first arrived.

Also about 40,000 years ago, another group, the Atlantean M96, migrated up the Nile River to Giza, marked by the x colored red, where I think the Atlanteans built the Great and Second Pyramids and the Sphinx shortly after they arrived in Giza, encoding African wisdom in those structures. At that time all the area colored red was dry land and home of many Atlanteans. Atlanteans crossed the Atlantic Ocean to the East Coast of the Americas.

**Pyramids-Sphinx and Angkor Temples. were built when Vega was North Star.
Were they built 12,000 years ago or 38,000 years ago ?**

Gobekli Tepe Temple of Hunter-Gatherers favors earlier construction.

Wikipedia: "... Göbekli Tepe ... is an archaeological site in ... Southeastern Anatolia ... The tell has a height of 15 m (49 ft) and is about 300 m (980 ft) in diameter.

It is approximately 760 m (2,490 ft) above sea level.

The tell includes two phases dating back to the 10th–8th millennium BCE.

At the first phase ... circular compounds or temene first appear. They range from 10 to 30 metres in diameter ... Scholars cannot interpret the pictograms ...

The ... structures ... not only predate pottery, metallurgy, and the invention of writing or the wheel, but were built before the so-called Neolithic Revolution, i.e., the beginning of agriculture and animal husbandry around 9000 BCE. But the construction of Göbekli Tepe implies organization of an advanced order not hitherto associated with Paleolithic, PPNA, or PPNB societies ...

If indeed the site was built by hunter-gatherers ... then it would mean that the ability to erect monumental complexes was within ... [their]... capacities ... which would overturn previous assumptions ...".

When Atlantean Humans reached Giza they built two large Pyramids each representing $Cl(8)$ whose 8 Vectors + 28 BiVectors + 16 Spinors = F_4 Lie Algebra one for F_4gde = Conformal Gravity + Dark Energy and one for F_4sm = Standard Model and Sphinx representing $Cl(16)$ for 120 BiVectors + 128 half-Spinors = E_8 = Lagrangian and whose 560 TriVectors = 10 copies of $Fr_3(O)$ = 26D World-Line-String Theory

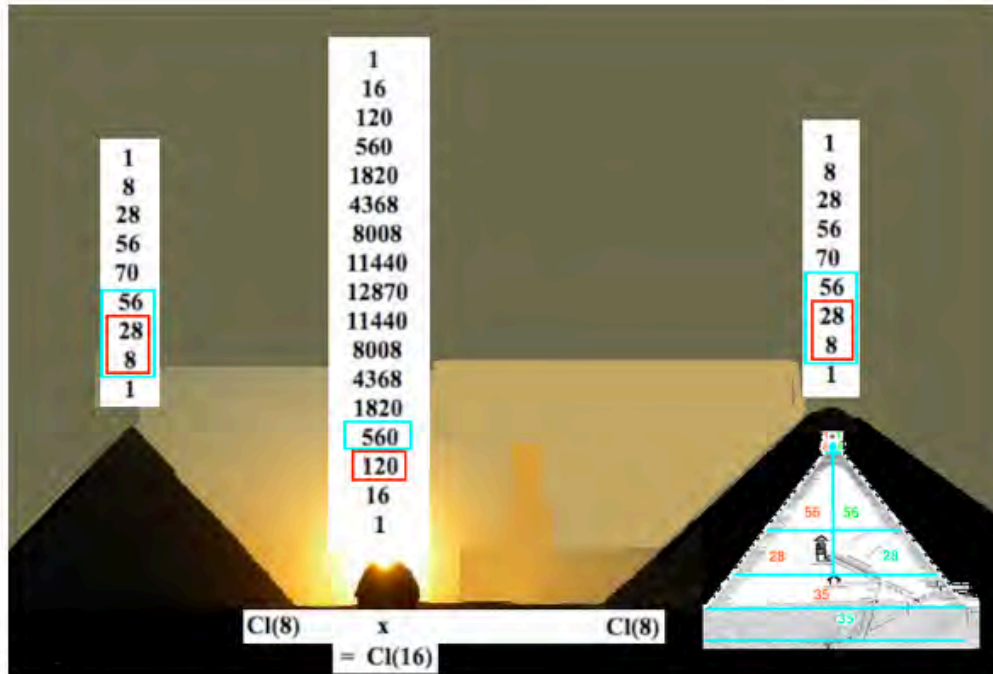

Each Pyramid represented a copy of $Cl(8)$ with graded structure

$$256 = 1 + 8 + 28 + 56 + 70 + 56 + 28 + 8 + 1 = (8L+8R) \times (8L+8R)$$

so that each contained a copy of 56-dim $Fr_3(O)$ and of 52-dim $F_4 = 8 + 28 + (8L+8R)$

By 8-Periodicity of Real Clifford Algebras the tensor product $\mathbf{Cl}(8) \otimes \mathbf{Cl}(8) = \mathbf{Cl}(16)$

$\mathbf{Cl}(16)$ contains 10 copies of $\text{Fr}_3(\mathbf{O}) = 1 \times 56 + 8 \times 28 + 28 \times 8 + 56 \times 1 = 560$ elements
related to 26D World-Line=String Theory

$\mathbf{Cl}(16)$ contains $(1 \times 28 + 8 \times 8 + 28 \times 1 = 120) + (8L \times 8L + 8R \times 8R = 128) = 248$ -dim \mathbf{E}_8

248-dim \mathbf{E}_8 structure came from the \mathbf{F}_{4gde} and \mathbf{F}_{4sm} of the two Pyramids:

tensor product $\mathbf{Cl}(16) = \mathbf{Cl}(8) \times \mathbf{Cl}(8)$

induces the product

$\mathbf{E}_8 = \mathbf{F}_{4gde} \times \mathbf{F}_{4sm}$

120-dim $\mathbf{Cl}(16)$ BiVectors = $1 \times 28 + 8 \times 8 + 28 \times 1$ of $\mathbf{Cl}(8) \times \mathbf{Cl}(8)$

128-dim $\mathbf{Cl}(16)$ Half-Spinors = $8L \times 8L + 8R \times 8R$ of $\mathbf{Cl}(8) \times \mathbf{Cl}(8)$

where $8L$ denotes left-handed Half-Spinors of $\mathbf{Cl}(8)$

and $8R$ denotes right-handed Half-Spinors of $\mathbf{Cl}(8)$

and

$8L \times 8L + 8R \times 8R$ are the Half-Spinors of $\mathbf{Cl}(16)$ with consistent handed-ness structure.

256-dim $\mathbf{Cl}(8) \otimes 256$ -dim $\mathbf{Cl}(8) = 65,536$ -dim $\mathbf{Cl}(16)$ Clifford Algebra structure is also present in Microtubules = 40 micron size aggregates of 65,536 tubulin dimers that are the basis of Penrose-Hameroff Bohm Potential Quantum Consciousness.

Ron Eglash (in his book "African Fractals" (Rutgers 1999) and on his web site) says: "... **a historical path for base-2 calculation ... begins with African divination, runs through the geomancy of European alchemists, and is finally transformed into binary calculation,** where it is now applied in every digital circuit ...".

Raymond Aschheim (email May 2015) said, about **Cellular Automata (CA)**:

"... An elementary CA is defined by the next value (either 0 or 1) for a cell, depending on its ... value, and the ... value of it[s] left and of it[s] right neighbor cell (it is one dimensional, and involve only the first neighbors, and the cell itself) ... So the next value depends [on] 3 bits ... eight possible combination of three bits, and for each ... combination... the next value is either zero or one. So the[re] are **256 ... CAs ...**".

256 Cellular Automata correspondence with 256-dim $\mathbf{Cl}(8)$ means that by 8-Periodicity **any Real Clifford Algebra can be described by Cellular Automata so $\mathbf{Cl}(16)$ physics can also be seen in terms of Cellular Automata.**

For example consider the 28 CI(8) BiVector grade-2 Cellular Automata:

These 1 + 12 + 3 = 16 grade-2 Cellular Automata correspond to propagator phase, Conformal Lie Algebra Root Vectors, and Conformal Lie Algebra Cartan Subalgebra

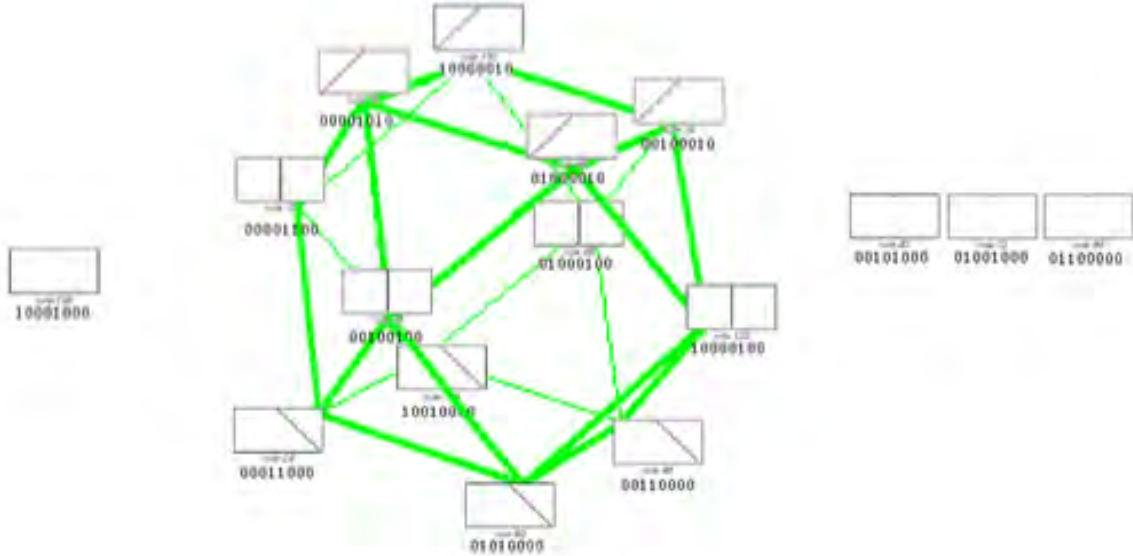

The Conformal Group $Spin(2,4) = SU(2,2)$ gives Gravity+Dark Energy by the MacDowell-Mansouri mechanism.

$U(2,2) = U(1) \times SU(2,2)$ also contains the propagator phase

These 1 + 3 + 8 = 12 grade-2 Cellular Automata correspond to $U(1)$, $SU(2)$, $SU(3)$ of the Standard Model



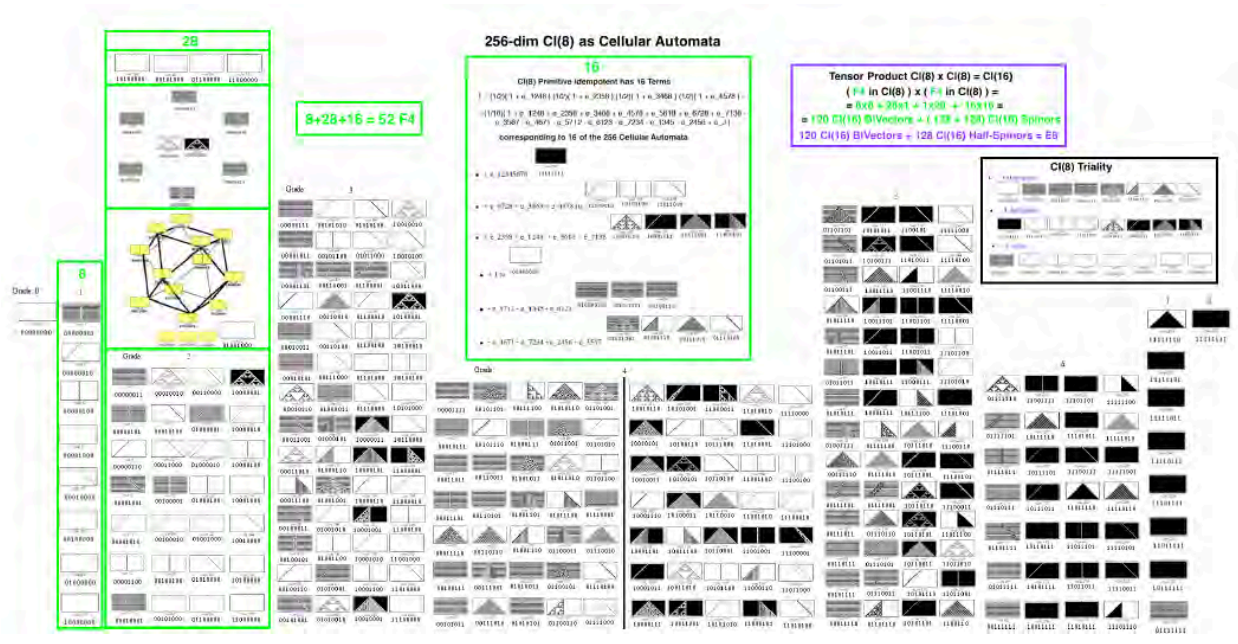

The 256 Elementary Cellular Automata correspond to the 256-dim Cl(8) Clifford Algebra with graded structure 1 8 28 56 (35+35=70) 56 28 8 1

The 8 Vectors have clear physical interpretation as 8-dim Spacetime.

The 28 BiVectors have clear physical interpretation as Gauge Bosons or Ghosts of Standard Model (12) and Gravity+ Dark Energy(16)

The 1 scalar, 1 pseudoscalar, and 7+7=14 of grade 4 have physical interpretation as 8 +half-spinors and 8 -half-spinors

The 8+28+8+8 = 52 with fixed physical interpretation form 52-dim F4.

The remaining 256 - 8 - 28 - 8 - 8 = 204 Cl(8) Cellular Automata are not bound to any physical interpretation but are available to carry information.

When Cl(16) is formed from the tensor product Cl(8) x Cl(8) the two F4 in Cl(8) go to 1x28 + 8x8 + 28x1 = 120 D8 BiVectors and (8+8) x (8+8) = 256 D8 Spinors all of which inherit clear physical interpretations leaving 65,536 - 120 - 256 = 65,160 Cl(16) elements available to carry information either in Lorentz Leech Lattice Spacetime Cells of Our Conscious Universe or in 40-micron Microtubules of Human Quantum Consciousness.

All of the 120 D8 BiVectors and 128 = half of the D8 Spinors form 248-dim E8 which has fixed physical interpretation inherited from the F4 in Cl(8) so 248-dim E8 and the other 128 half-Spinors are fixed structure markers in Cl(16) that do not carry information.

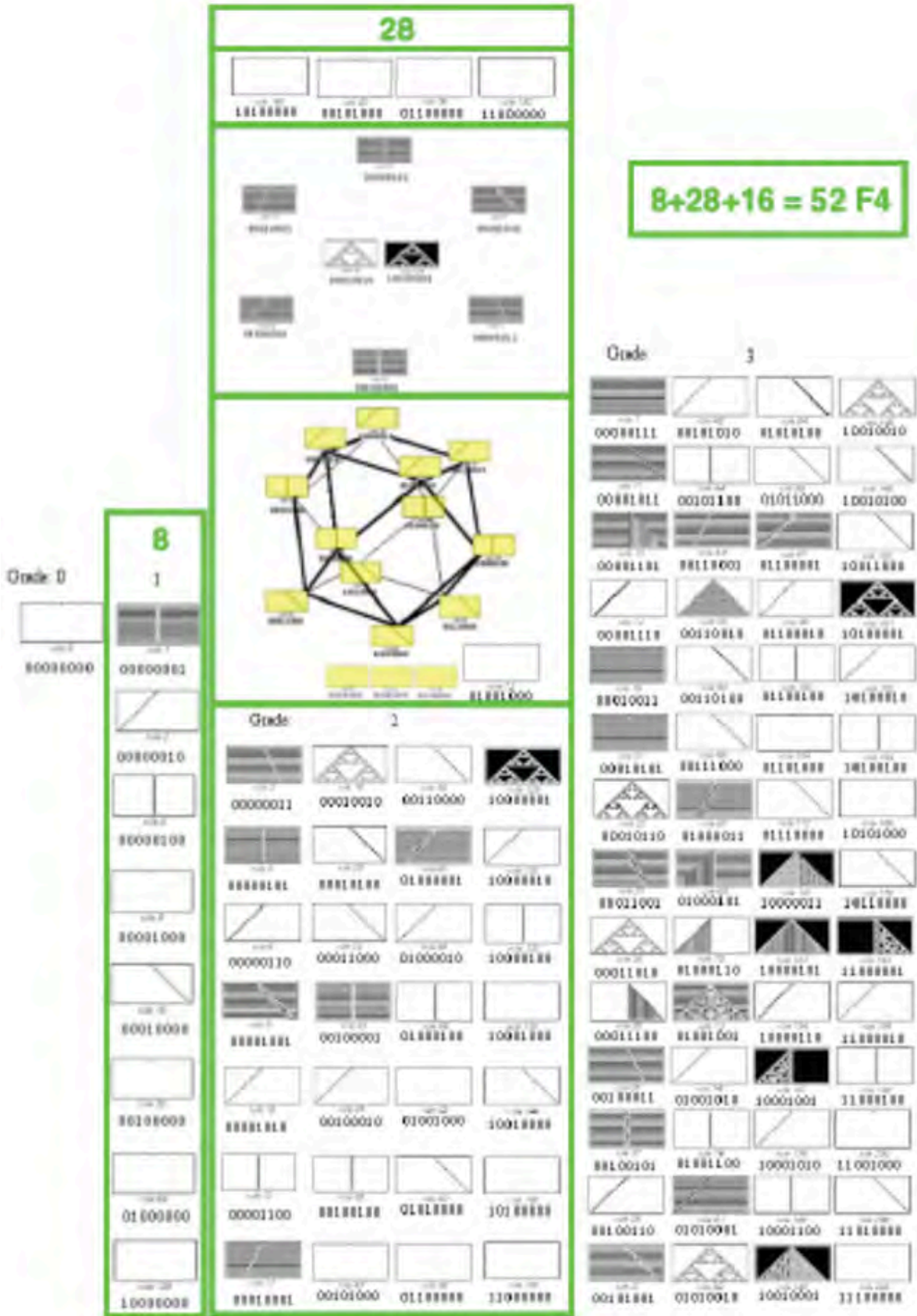

256-dim CI(8) as Cellular Automata

16

CI(8) Primitive Idempotent has 16 Terms

$$f = (1/16)(1 + e_{1248}) + (1/16)(1 + e_{2058}) + (1/16)(1 + e_{3488}) + (1/16)(1 + e_{4578}) = \\ = (1/16)(1 + e_{1248} + e_{2058} + e_{3488} + e_{4578} + e_{5018} + e_{5728} + e_{7138} + \\ + e_{3567} + e_{4671} + e_{5712} + e_{6123} + e_{7234} + e_{1345} + e_{2456} + e_{3567})$$

corresponding to 16 of the 256 Cellular Automata

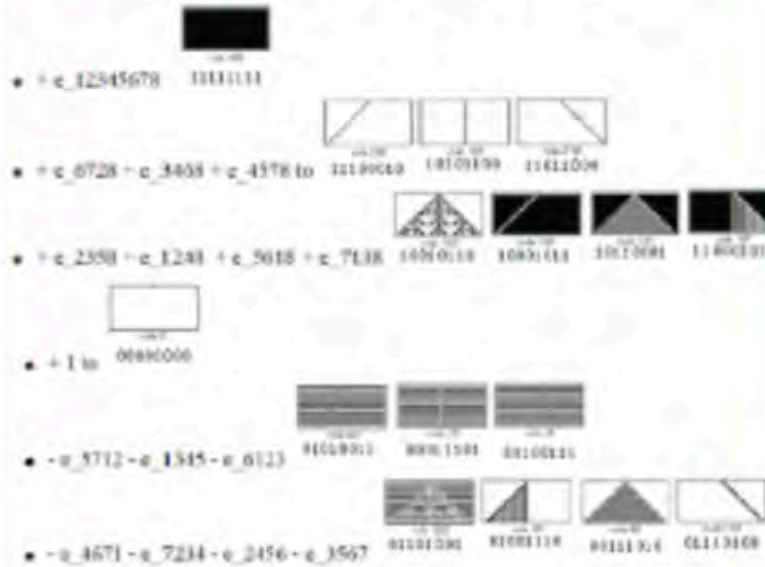

Orbit:

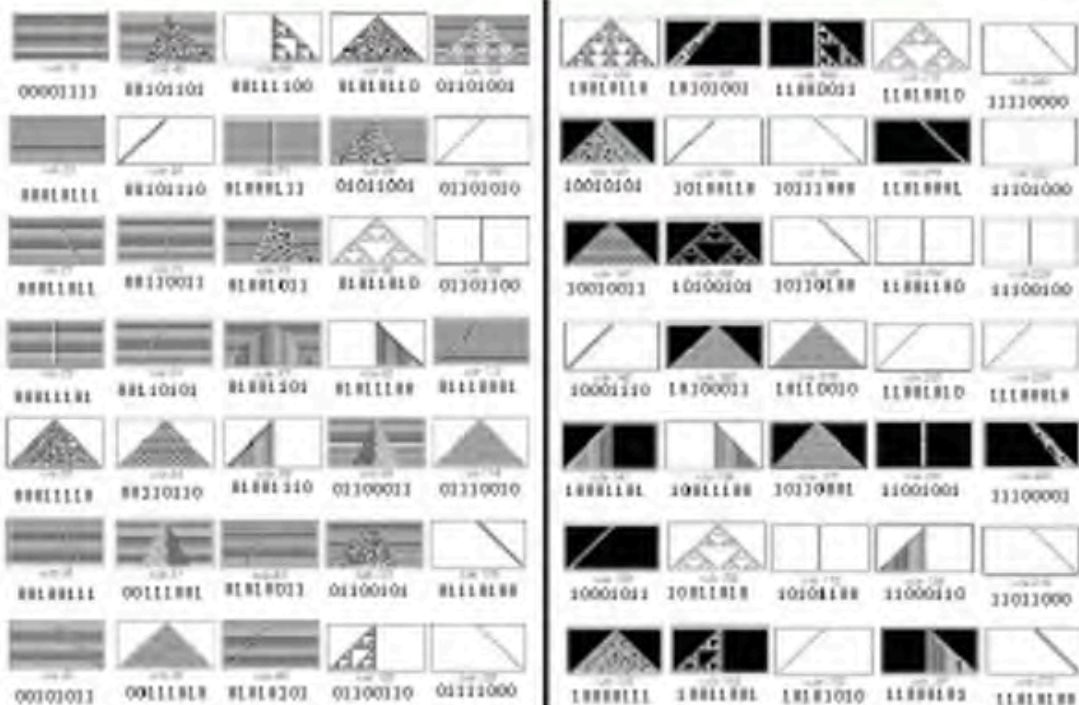

Tensor Product $Cl(8) \times Cl(8) = Cl(16)$
 $(F_4 \text{ in } Cl(8)) \times (F_4 \text{ in } Cl(8)) =$
 $= 8 \times 8 + 28 \times 1 + 1 \times 28 + 16 \times 16 =$
 $= 120 Cl(16) \text{ BiVectors} + (128 + 128) Cl(16) \text{ Spinors}$
 $120 Cl(16) \text{ BiVectors} + 128 Cl(16) \text{ Half-Spinors} = E_8$

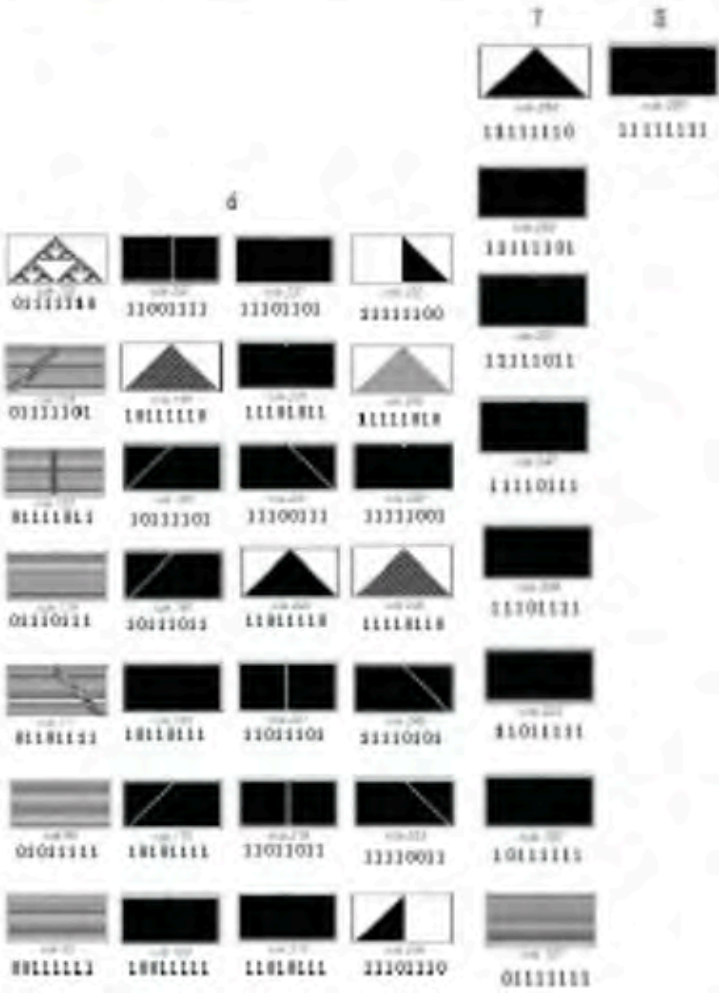
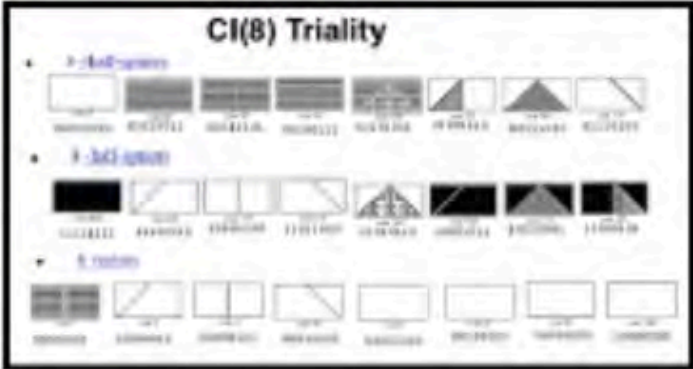

CI(8) CA with Std Model D4 Gauge Bosons

20 Bivectors of First D4

14 Std Model Gauge Bosons

16 U(2) Bivectors

16

CI(8) Primitive Components Has 16 Types

$(1, 1, 1, 1) \times (1, 1, 1, 1) \times (1, 1, 1, 1) \times (1, 1, 1, 1) \times (1, 1, 1, 1)$
 $(1, 1, 1, 1) \times (1, 1, 1, 1) \times (1, 1, 1, 1) \times (1, 1, 1, 1) \times (1, 1, 1, 1)$
 $(1, 1, 1, 1) \times (1, 1, 1, 1) \times (1, 1, 1, 1) \times (1, 1, 1, 1) \times (1, 1, 1, 1)$
 corresponding to 16 of the D4 Gauge Bosons

Tensor Product $CI(8) \times CI(8) = CI(16)$

$(F_4 \text{ in } CI(8)) \times (F_4 \text{ in } CI(8)) =$
 $= 8(8) \times 2(8) = 14(8) \times 1(8) = 15$
 $= 120 CI(16) \text{ Bivectors} = (120 = 120 CI(16) \text{ Spinors} = 88$
 $120 CI(16) \text{ Bivectors} = 128 CI(16) \text{ Half-Spinors} = 88$



Here are some details about the Giza Pyramids and Sphinx:

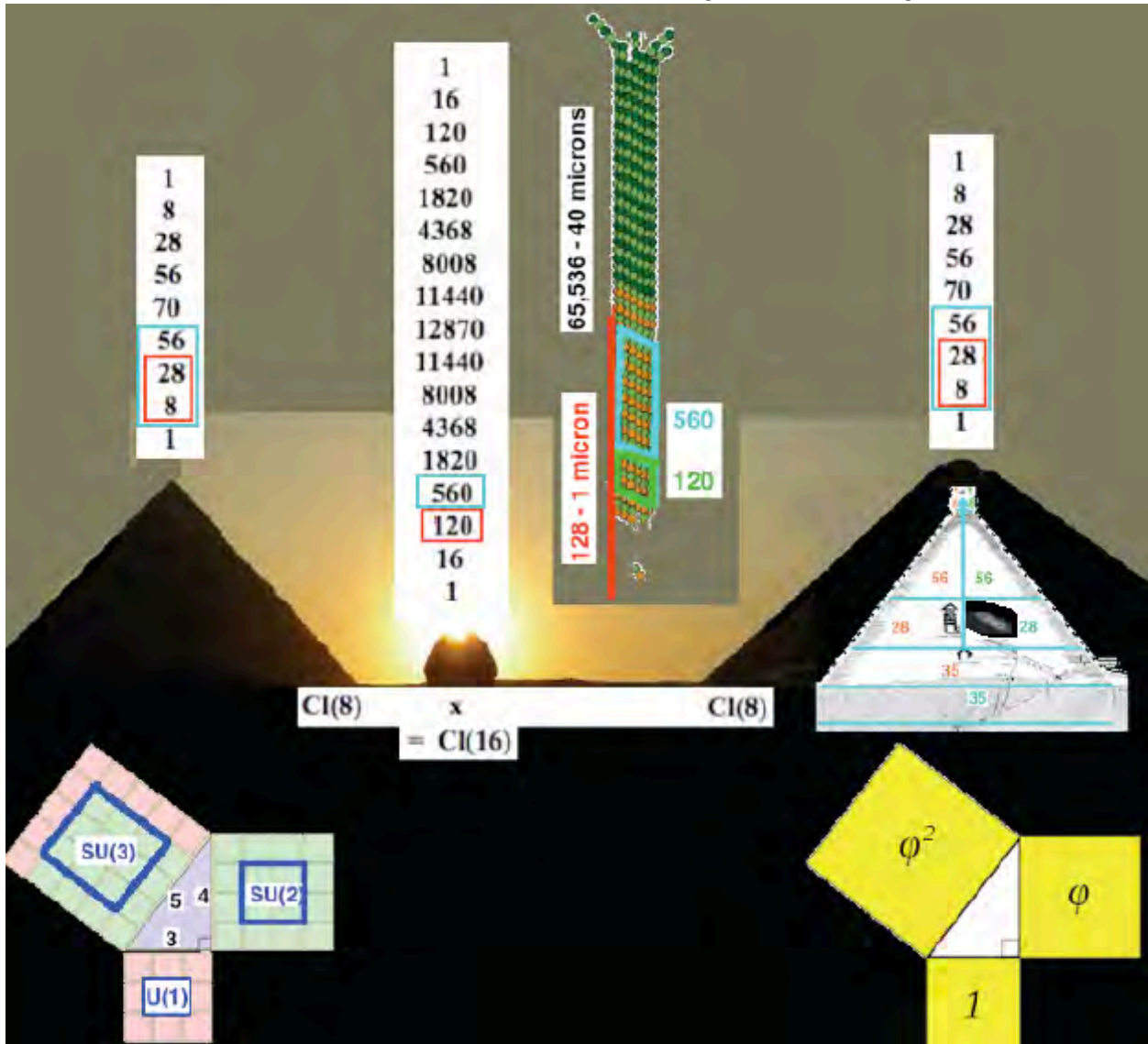

The **Great Pyramid** (right in image above) has

203 layers + 35 underground + 1+8+8+1 capstone = 256 = Cl(8)

It has a Grand Gallery for Physical World and a Grand Void for Spirit World

Its slope is Golden Ratio Triangle (H4 in E8 has Golden Ratio structure)

The Golden Ratio governs the Gravitational Spiral of Galaxies

The **Second Pyramid** (left in image above) has slope of 3-4-5 Triangle

corresponding to U(1) - SU(2) - SU(3) Standard Model Gauge Groups

The **Sphinx** represents $Cl(16) = Cl(8) \times Cl(8) = \text{Great} \times \text{Second Pyramids}$

and shows correspondence between 65,536-dim Cl(16) Physics cell

and 65,536 Tubulins of maximal Microtubule Quantum Consciousness cell

Ron Eglash (in his book "African Fractals" and on his web site) also says:
 ... **Following the introduction of geomancy to Europe by Hugo of Santalla in twelfth-century Spain ... European geomancers ... Ramon Lull ... and others ...** persistently replaced the deterministic aspects of the system with chance. **By mounting the 16 figures on a wheel and spinning it, they maintained their society's exclusion of any connections between determinism and unpredictability ...**".

Anthony Bonner in his book The Art and Logic of Ramon Llull (Brill 2007) (unless otherwise stated illustrations herein are adapted from that book) said:
 "... **Llull wanted to make the Art "general to everyone"** ...
 "a religiously neutral universal science" ... for Llull the Art is not enclosed in its own shell, but ... can even be adapted to "many other principles of science" ...".
 Ramon Llull's Y and Z Figures



are analogous to the binary structure of IFA
 Ramon Llull's Wheels A and X

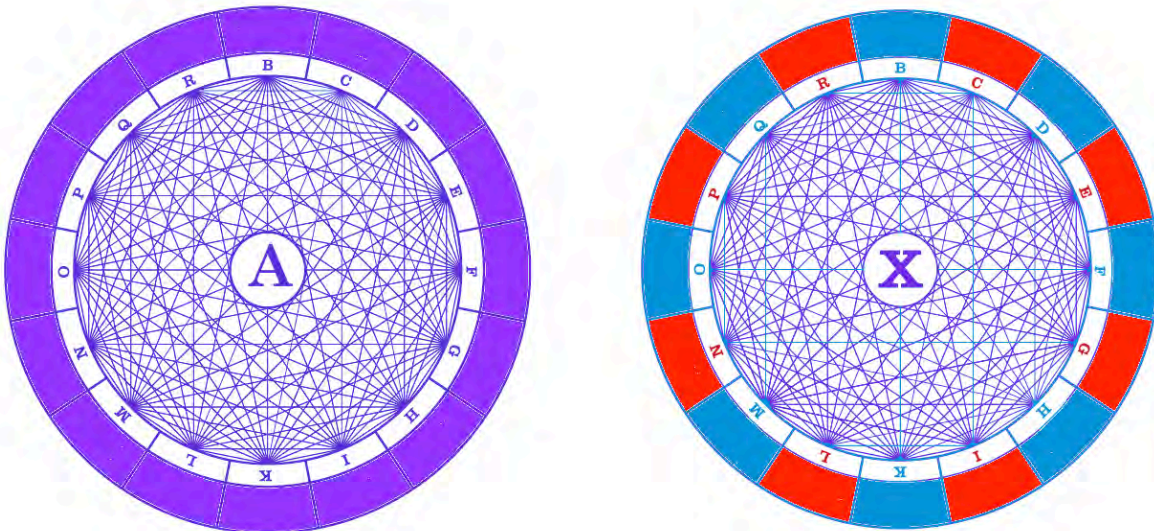

have 16 vertices and 120 lines connecting pairs of vertices, corresponding to the 16 vectors of the Real Clifford Algebra $Cl(16)$ and the 120 bivectors of $Cl(16)$ that generate the 120-dim D_8 Lie Algebra in the 248-dim E_8 Lie Algebra with $E_8 / D_8 = 64 + 64$ Fermion Particles + AntiParticles representing $64 + 64$ of E_8 Maximal Contraction $28 + 64 + (A_7+R) + 64 + 28$

By 8-Periodicity of Real Clifford Algebras $Cl(16) = \text{tensor product } Cl(8) \times Cl(8)$
 so the 16 vectors of $Cl(16) = 1 \times 8 + 8 \times 1$ where $8 = 8$ vectors of $Cl(8)$
 and 8 of the 16 Wheel A vertices are the 8 blue vertices of Wheel X
 and the other 8 Wheel A vertices are the 8 red vertices of Wheel X.

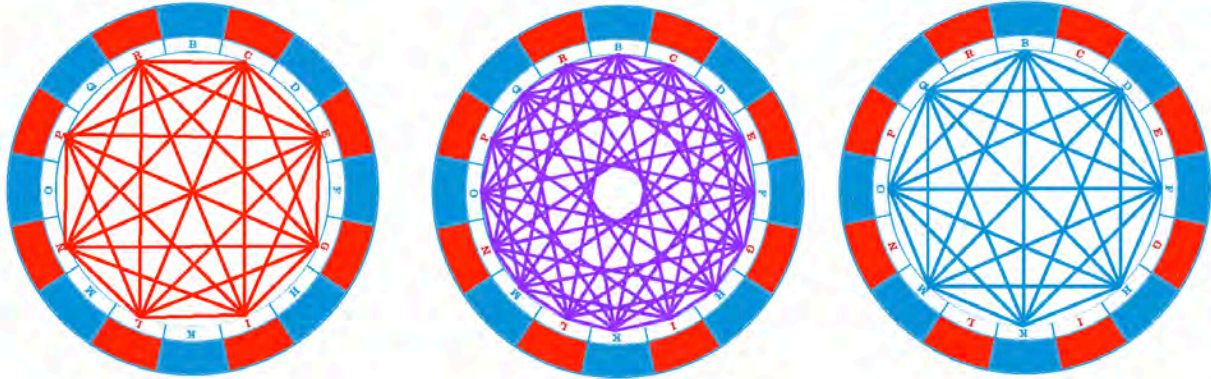

$28 = 1 \times 28$ of the 120 D8 bivectors connect red vertices with red vertices
 and represent the D4 Lie Algebra acting on the red 8-dim $Cl(8)$ vector space
 and 12 Standard Model Gauge Bosons plus 16 Gravity+Dark Energy Ghosts
 representing 28 of E8 Maximal Contraction $28 + 64 + (A7+R) + 64 + 28$

$64 = 8 \times 8$ of the 120 D8 bivectors connect red vertices with blue vertices
 and represent A7+R of E8 Maximal Contraction $28 + 64 + A7+R + 64 + 28$

$28 = 28 \times 1$ of the 120 D8 bivectors connect blue vertices with blue vertices
 and represent the D4 Lie Algebra acting on the blue 8-dim $Cl(8)$ vector space
 and 16 Gravity+Dark Energy Gauge Bosons plus 12 Standard Model Ghosts
 representing 28 of E8 Maximal Contraction $28 + 64 + (A7+R) + 64 + 28$

Around 1300 Scholasticism was being developed
 at the University of Paris, then the world's leading University,
 and Cambridge and Oxford Universities which were getting organized based on Paris.

Doctor Illuminatus = Ramon Llull (1232-1315) produced a system of Logic
 and a mathematical Art based on what is now known as the Clifford Algebra $Cl(16)$ and
 the 120 dimensional Lie algebra $Spin(16)$. 700 years ago the details
 of that mathematics were not known, nor was it known that the math structure of the Art
 gives a realistic representation of $Cl(16)$ Physics of the Standard Model and Gravity
 +Dark Energy along with its Algebraic Quantum Field Theory. (see viXra 1804.0121)

Doctor Subtilis = John Duns Scotus (1266-1308) developed Llull's system of Logic
 into sophisticated Scholasticism, but did not have the math and physics knowledge
 to show that the mathematical Art of Doctor Illuminatus gives a realistic physics model.

A Second Scholasticism began in 1540 with Ignatius Loyola under Pope Paul III who founded the Jesuits, but, without the ability to experimentally measure the relative strengths of the forces of the Standard Model and Gravity and the relative masses of the elementary fermion particles and to compare those observations with the physics model of Llull's mathematical Art, by 1700 Scholasticism had been displaced by the Enlightenment of Descartes et al.

Now that we can do such experiments and make such observations we can use Cl(16) Physics as a foundation for a Third Scholasticism using Cl(16) geometry including 240 E8 Root Vectors.

Ron Eglash (in his book "African Fractals" and on his web site) also says:

"... European geomancers ... maintained their society's exclusion of any connections between determinism and unpredictability ...

The Africans, on the other hand, seem to have emphasized such connections ...[with]]... a "trickster" god, one who is both deterministic and unpredictable. ...

The fractal settlement patterns of Africa stand in sharp contrast to the Cartesian grids of Euro-American settlements. ... Euro-American cultures are ... "top-down" organization.

Precolonial African cultures included ... societies that are organized "bottom-up" rather than "top-down". ... African architecture tends to be fractal because that is a prominent design theme in African culture ... most of the indigenous African societies were neither utterly anarchic, nor frozen in static order; rather they utilized an adaptive flexibility ...

African traditions of decentralized decision making could ... be combined with new information technologies, creating new forms that combine democratic rule with collective information sharing ...".

Clifford in 1878 brought Real Clifford Algebras to the Europeans:

William Kingdon Clifford (1845 - 1879), according to Wikipedia - (1878, "On the Nature of Things-in-Themselves", Mind, Vol. 3, No. 9, pp. 57–67), said:

"... That element of which ... even the simplest feeling is a complex, I shall call **Mind-stuff**. A moving molecule of inorganic matter does not possess mind or consciousness ; but it possesses a small piece of mind-stuff. ... When molecules are ... combined together ... **the elements of mind-stuff** which go along with them ... combine ... to form the ...

beginnings of Sentience. When the molecules are so combined as to form the brain and nervous system ... the corresponding elements of mind-stuff are so combined as to form some kind of consciousness ... changes in the complex which take place at the same time get so linked together that the repetition of one implies the repetition of the other. When matter takes the complex form of a living **human brain, the corresponding mind-stuff**

takes the form of a human consciousness ...".

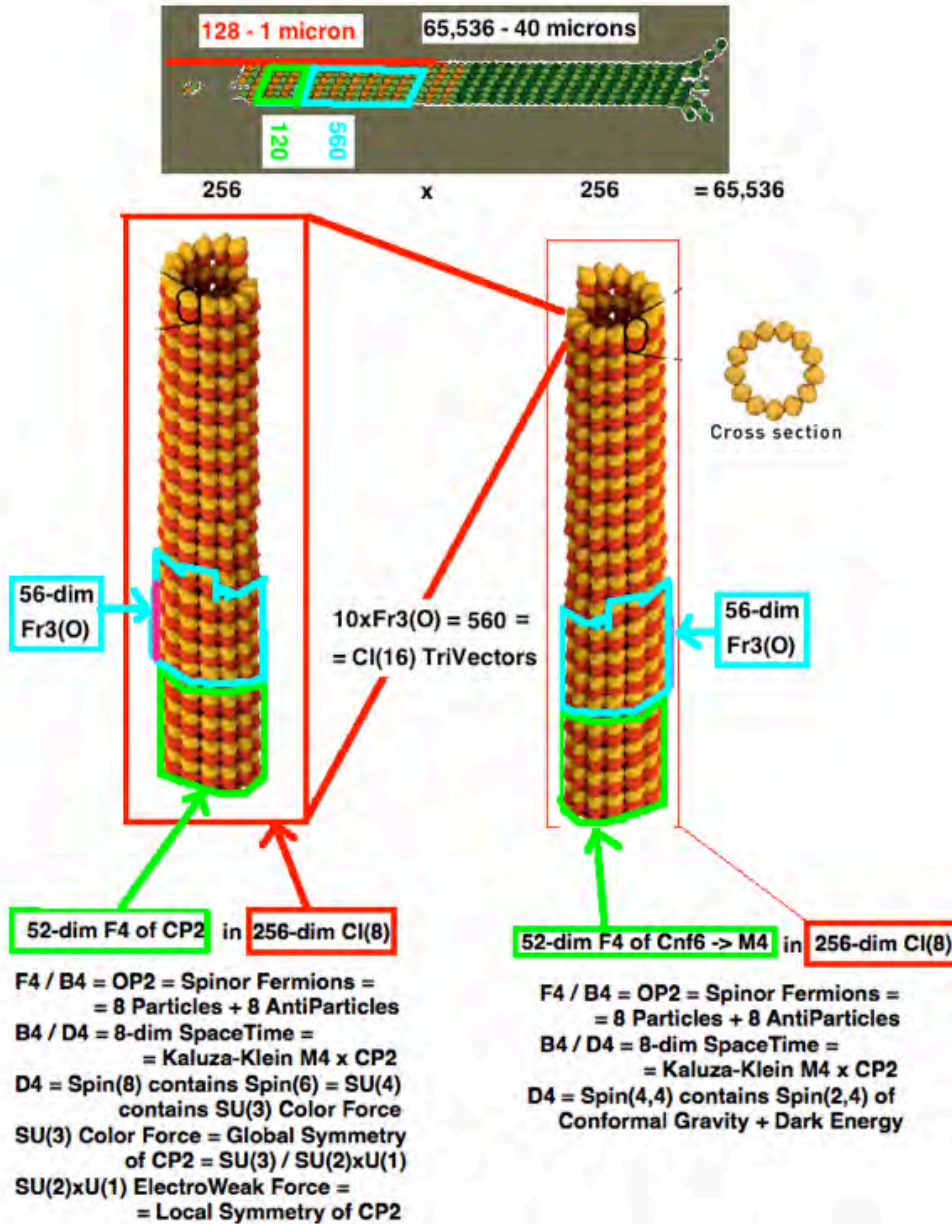

Assembly of 65,536 tubulins into a 40-micron microtubule can be seen to be analogous to the 256 x 256 tensor product $Cl(8) \times Cl(8)$ where one 256-dim $Cl(8)$ represents Conformal Gravity+Dark Energy with $F4_{gde}$ related to the Minkowski $M4$ of Kaluza-Klein $M4 \times CP2$ and the other $Cl(8)$ represents Standard Model $U(1) \ SU(2) \ SU(3)$ with $F4_{sm}$ related to the $CP2 = SU(3) / SU(2) \times U(1)$ of Kaluza-Klein $M4 \times CP2$

The E8 and 10 copies of Fr3(O) of Cl(16) only use 248 + 560 of the 65,536 elements so that 64,728 Cl(16) elements are available for Quantum Consciousness thought processes

The Great Pyramid slope is of a Golden Ratio Right Triangle representing Conformal Gravity+Dark Energy with Gauge Group $Spin(2,4) = SU(2,2)$
 It represents $M4$ of Kaluza-Klein $M4 \times CP2$ and is represented by $F4_{gde}$

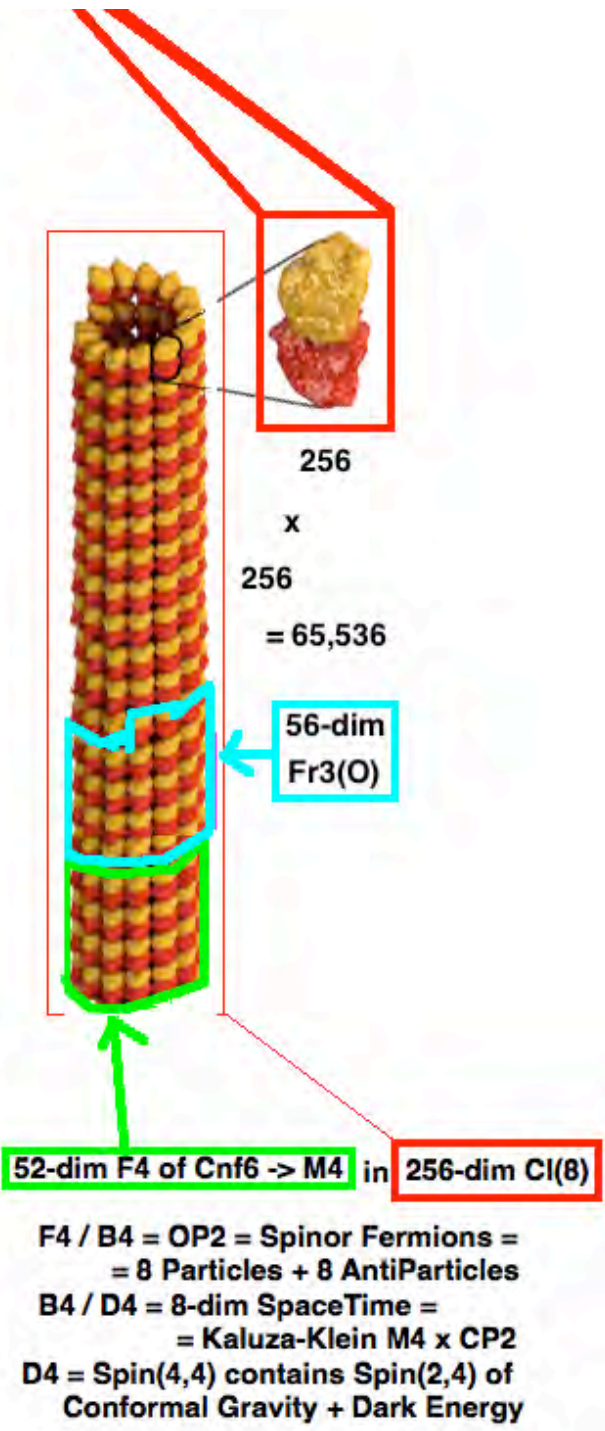
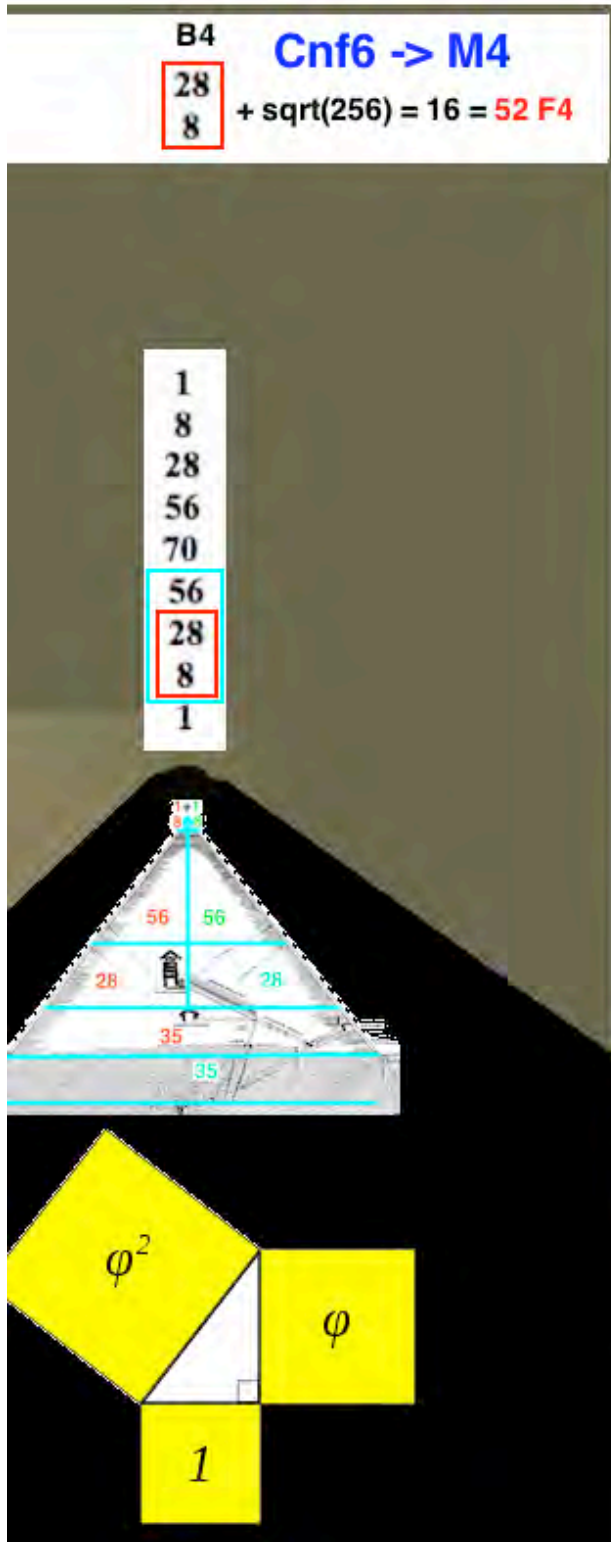

Clifford Algebras were not known to European mathematicians until Clifford in the 19th century and not known to European physicists until Dirac in the 20th century but

it seems to me that their structure was known to Africans in ancient times. The courses of the Great Pyramid of Giza correspond to the graded structure of 256-dim Cl(8):

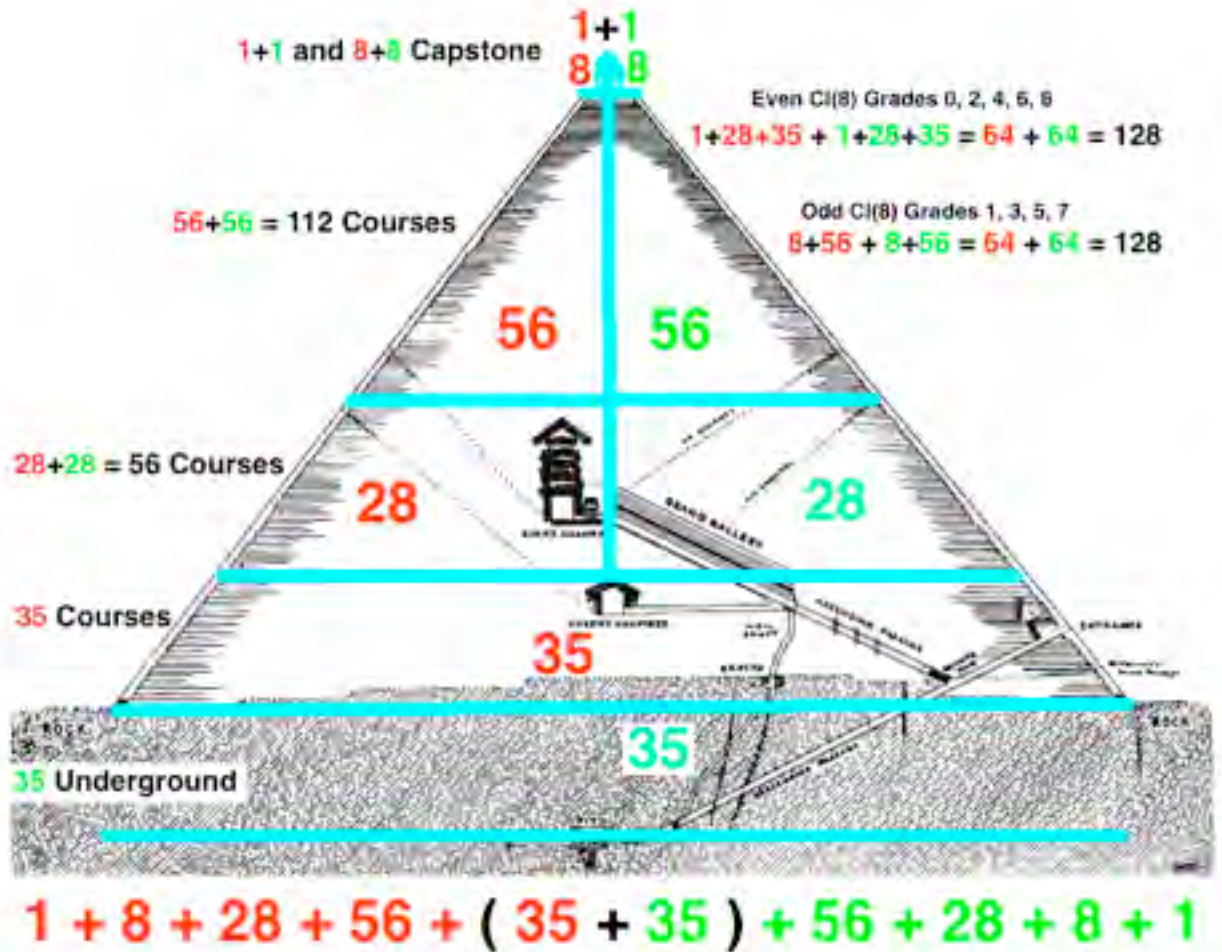

(image adapted from David Davidson image - for larger size see tony5m17h.net/GreatPyrCl8.png)

William Kingdon Clifford (1845 - 1879) described that Geometry in terms of his invention: Real Clifford Algebras, which he called “mind-stuff”, saying: “... That element of which ... even the simplest feeling is a complex, I shall call **Mind-stuff**.

A moving molecule of inorganic matter does not possess mind or consciousness ; but it possesses a small piece of mind-stuff. ... When molecules are ... combined together ... **the elements of mind-stuff which go along with them ... combine ... to form the ... beginnings of Sentience.** When the molecules are so combined as to form the brain and nervous system ... the corresponding elements of mind-stuff are so combined as to form some kind of consciousness ... changes in the complex which take place at the same time get so linked together that the repetition of one implies the repetition of the other. **When matter takes the complex form of a living human brain, the corresponding mind-stuff takes the form of a human consciousness ...”.**

(Wikipedia - (1878, "On the Nature of Things-in-Themselves", Mind, Vol. 3, No. 9, pp. 57–67))

Tensor Product $Cl(0,8) \times Cl(p,q) = M(\mathbb{R},16) \times Cl(p,q) = Cl(p,q+8)$

Real Clifford Algebras $Cl(p,q)$

8	$M_{16}(\mathbb{R})$	$M_{16}(\mathbb{C})$	$M_{16}(\mathbb{H})$	$M_{16}(\mathbb{H}) \oplus M_{16}(\mathbb{H})$	$M_{32}(\mathbb{H})$	$M_{64}(\mathbb{C})$	$M_{128}(\mathbb{R})$	$M_{128}(\mathbb{R}) \oplus M_{128}(\mathbb{R})$	$M_{256}(\mathbb{R})$								
7	$M_8(\mathbb{C})$	$M_8(\mathbb{H})$	$M_8(\mathbb{H}) \oplus M_8(\mathbb{H})$	$M_{16}(\mathbb{H})$	$M_{32}(\mathbb{C})$	$M_{64}(\mathbb{R})$	$M_{64}(\mathbb{R}) \oplus M_{64}(\mathbb{R})$	$M_{128}(\mathbb{R})$	$M_{128}(\mathbb{C})$	$M_{128}(\mathbb{H})$							
6	$M_4(\mathbb{H})$	$M_4(\mathbb{H}) \oplus M_4(\mathbb{H})$	$M_8(\mathbb{H})$	$M_{16}(\mathbb{C})$	$M_{32}(\mathbb{R})$	$M_{32}(\mathbb{R}) \oplus M_{32}(\mathbb{R})$	$M_{64}(\mathbb{R})$	$M_{64}(\mathbb{C})$	$M_{64}(\mathbb{H})$	$M_{64}(\mathbb{H}) \oplus M_{64}(\mathbb{H})$	$M_{128}(\mathbb{H})$						
5	$M_2(\mathbb{H}) \oplus M_2(\mathbb{H})$	$M_4(\mathbb{H})$	$M_8(\mathbb{C})$	$M_{16}(\mathbb{R})$	$M_{16}(\mathbb{R}) \oplus M_{16}(\mathbb{R})$	$M_{32}(\mathbb{R})$	$M_{32}(\mathbb{C})$	$M_{32}(\mathbb{H})$	$M_{32}(\mathbb{H}) \oplus M_{32}(\mathbb{H})$	$M_{64}(\mathbb{H})$	$M_{128}(\mathbb{C})$	$M_{256}(\mathbb{R})$					
4	$M_2(\mathbb{H})$	$M_4(\mathbb{C})$	$M_8(\mathbb{R})$	$M_8(\mathbb{R}) \oplus M_8(\mathbb{R})$	$M_{16}(\mathbb{R})$	$M_{16}(\mathbb{C})$	$M_{16}(\mathbb{H})$	$M_{16}(\mathbb{H}) \oplus M_{16}(\mathbb{H})$	$M_{32}(\mathbb{H})$	$M_{64}(\mathbb{C})$	$M_{128}(\mathbb{R})$	$M_{256}(\mathbb{R}) \oplus M_{256}(\mathbb{R})$	$M_{512}(\mathbb{R})$				
3	$M_2(\mathbb{C})$	$M_4(\mathbb{R})$	$M_8(\mathbb{R}) \oplus M_8(\mathbb{R})$	$M_8(\mathbb{C})$	$M_8(\mathbb{H})$	$M_8(\mathbb{H}) \oplus M_8(\mathbb{H})$	$M_{16}(\mathbb{H})$	$M_{32}(\mathbb{C})$	$M_{64}(\mathbb{R})$	$M_{64}(\mathbb{R}) \oplus M_{64}(\mathbb{R})$	$M_{128}(\mathbb{R})$	$M_{128}(\mathbb{C})$	$M_{128}(\mathbb{H})$				
2	$M_2(\mathbb{R})$	$M_4(\mathbb{R}) \oplus M_4(\mathbb{R})$	$M_4(\mathbb{C})$	$M_4(\mathbb{H})$	$M_4(\mathbb{H}) \oplus M_4(\mathbb{H})$	$M_8(\mathbb{H})$	$M_{16}(\mathbb{C})$	$M_{32}(\mathbb{R})$	$M_{32}(\mathbb{R}) \oplus M_{32}(\mathbb{R})$	$M_{64}(\mathbb{R})$	$M_{64}(\mathbb{C})$	$M_{64}(\mathbb{H})$	$M_{64}(\mathbb{H}) \oplus M_{64}(\mathbb{H})$	$M_{128}(\mathbb{H})$			
1	$\mathbb{R} \oplus \mathbb{R}$	$M_2(\mathbb{R})$	$M_2(\mathbb{C})$	$M_2(\mathbb{H})$	$M_2(\mathbb{H}) \oplus M_2(\mathbb{H})$	$M_4(\mathbb{H})$	$M_8(\mathbb{C})$	$M_{16}(\mathbb{R})$	$M_{16}(\mathbb{R}) \oplus M_{16}(\mathbb{R})$	$M_{32}(\mathbb{R})$	$M_{32}(\mathbb{C})$	$M_{32}(\mathbb{H})$	$M_{32}(\mathbb{H}) \oplus M_{32}(\mathbb{H})$	$M_{64}(\mathbb{H})$	$M_{128}(\mathbb{C})$	$M_{256}(\mathbb{R})$	
0	\mathbb{R}	\mathbb{C}	\mathbb{H}	$\mathbb{H} \oplus \mathbb{H}$	$M_2(\mathbb{H})$	$M_4(\mathbb{C})$	$M_8(\mathbb{R})$	$M_{16}(\mathbb{R}) \oplus M_{16}(\mathbb{R})$	$M_{32}(\mathbb{R})$	$M_{16}(\mathbb{C})$	$M_{16}(\mathbb{H})$	$M_{32}(\mathbb{H})$	$M_{64}(\mathbb{C})$	$M_{128}(\mathbb{R})$	$M_{256}(\mathbb{R}) \oplus M_{256}(\mathbb{R})$	$M_{512}(\mathbb{R})$	
	0	1	2	3	4	5	6	7	8	9	10	11	12	13	14	15	16

q -->

H = Quaternion

C = Complex

R = Real

Above the Grand Gallery is a Great Void leading to Ceiling Chambers above the Upper Chamber - (image from ScanPyramids web site)





The Builders of the Great Pyramid represented the Real Shilov Boundary Physical world by the Grand Gallery and Upper Chamber that are easily accessible by Humans with Microtubule Quantum Consciousness and they represented the Imaginary Complex World of $Cl(16)$ Spacetime Cells mirroring the Human Microtubule World as Ceiling Chamber spaces and the Great Void that are more accessible to Souls of the Spirit World than to Physical Humans.

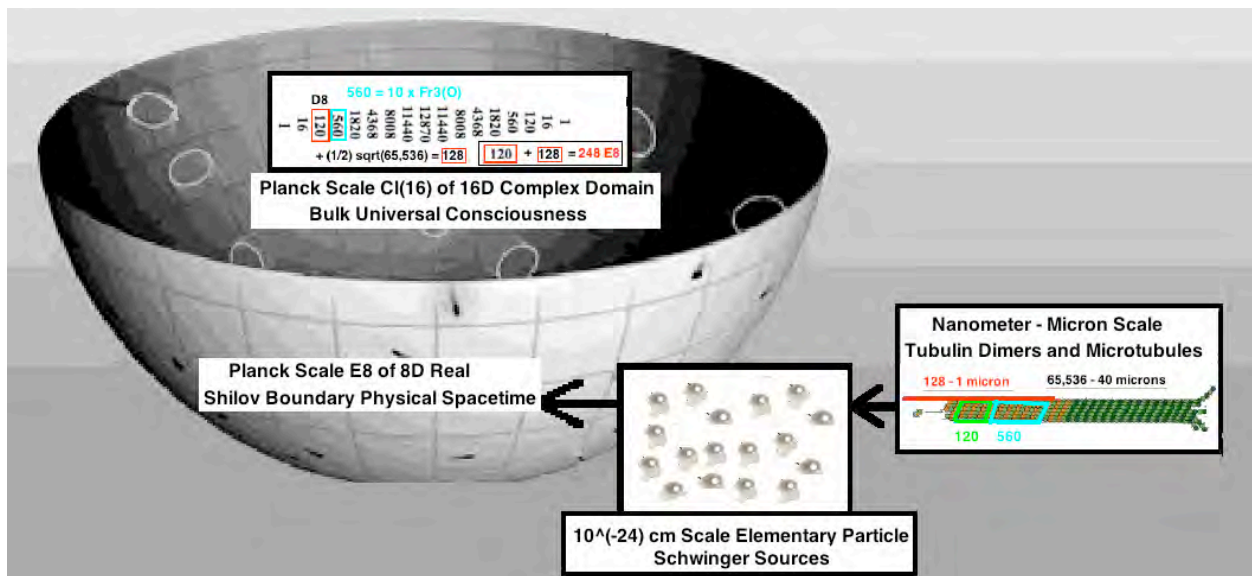

The Second Pyramid slope is of a 3-4-5 Right Triangle representing the Standard Model with Gauge Groups U(1) SU(2) SU(3) It represents CP2 of Kaluza-Klein M4 x CP2 and is represented by F4sm

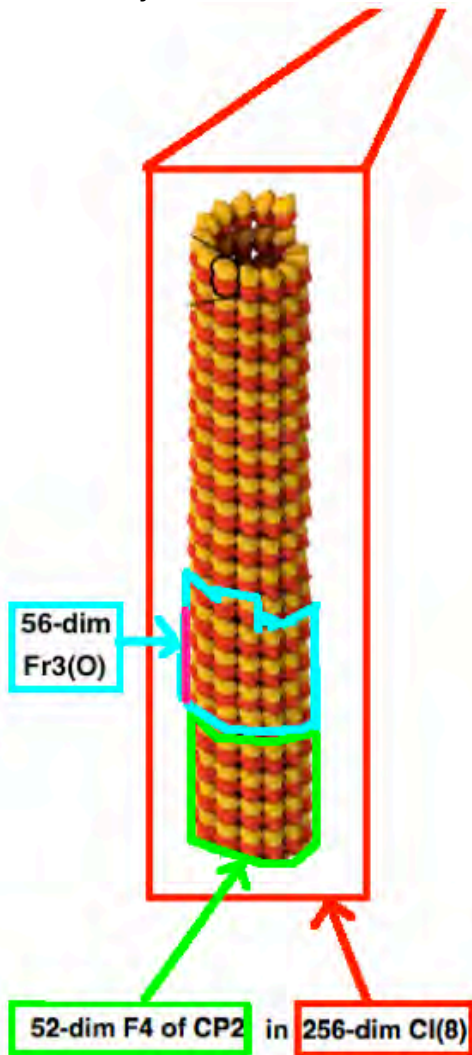

52-dim F4 of CP2 in 256-dim Cl(8)

F4 / B4 = OP2 = Spinor Fermions =
 = 8 Particles + 8 AntiParticles

B4 / D4 = 8-dim SpaceTime =
 = Kaluza-Klein M4 x CP2

D4 = Spin(8) contains Spin(6) = SU(4)
 contains SU(3) Color Force

SU(3) Color Force = Global Symmetry
 of CP2 = SU(3) / SU(2)xU(1)

SU(2)xU(1) ElectroWeak Force =
 = Local Symmetry of CP2

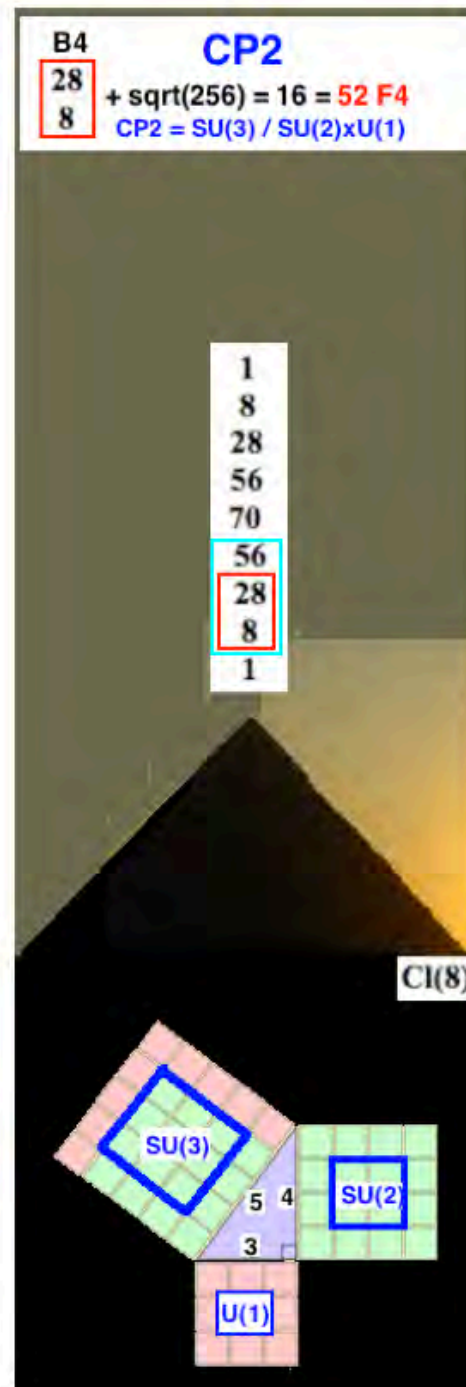

The Sphinx represents 65,536-dim Cl(16) containing 248-dim E8
as the tensor product combination of
the 256-dim Cl(8) containing 52-dim F4sm related to CP2 of M4 x CP2
and the 256-dim Cl(8) containing 52-dim F4gde related to M4 of M4 x CP2

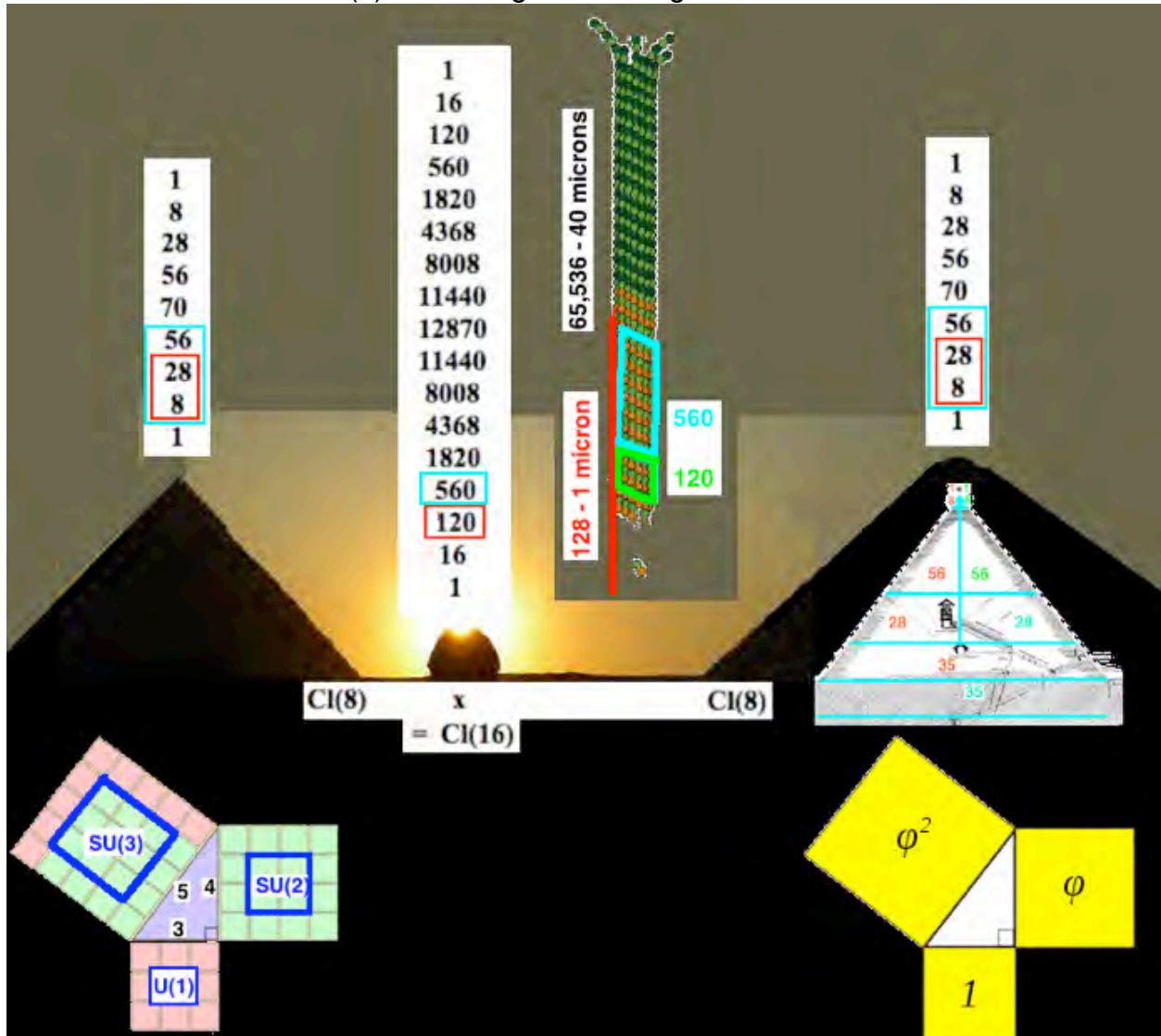

The image on the following page summarizes how the Sphinx represents
the Cl(16) combination of the two large Cl(8) Pyramids
and also
the 65,536-element 40 micron Microtubules of Bohm Quantum Consciousness

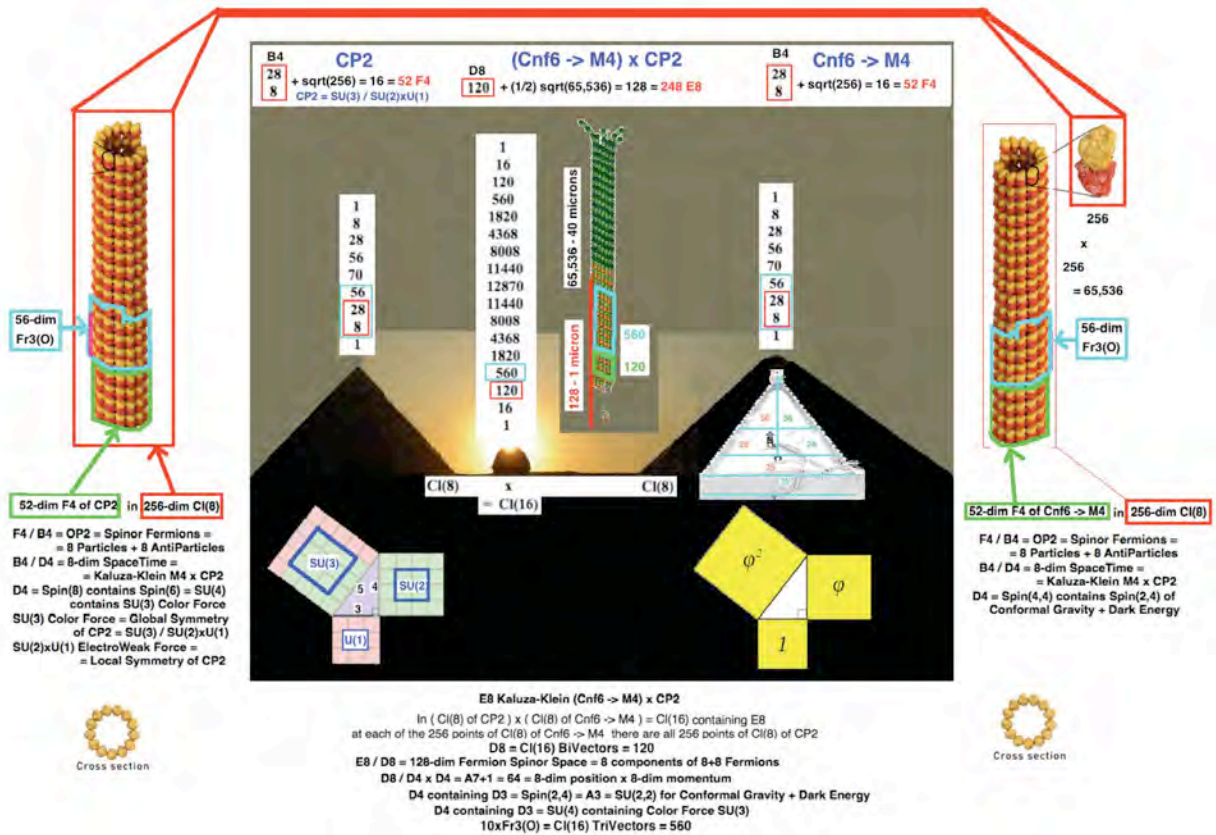

two large Pyramids - each representing Cl(8)
 whose 8 Vectors + 28 BiVectors + 16 Spinors = F4 Lie Algebra

one for F4gde = Conformal Gravity + Dark Energy

one for F4sm = Standard Model

and

the Sphinx - representing Cl(16)

whose 120 BiVectors + 128 half-Spinors = E8 = Lagrangian

whose 560 TriVectors = 10 copies of Fr3(O) = 26D World-Line-String Theory

Here is a diagram (adapted from diagram of Henry Montieth) that indicates my view of Manetho's history of Humans and how it is likely to extend into the future :

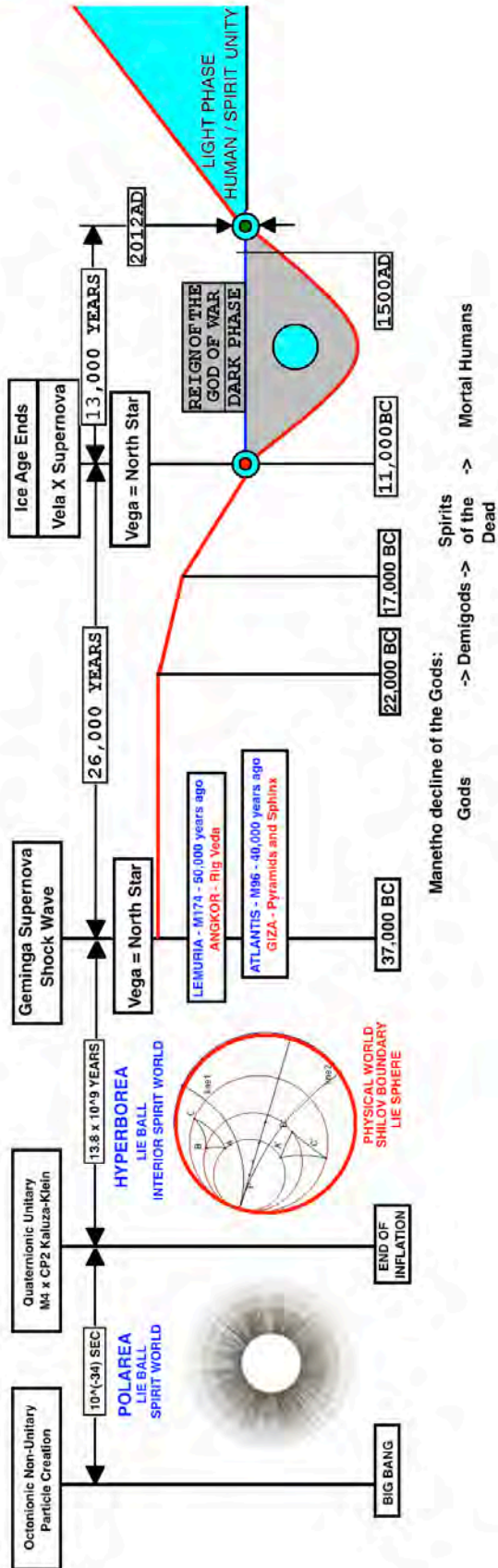

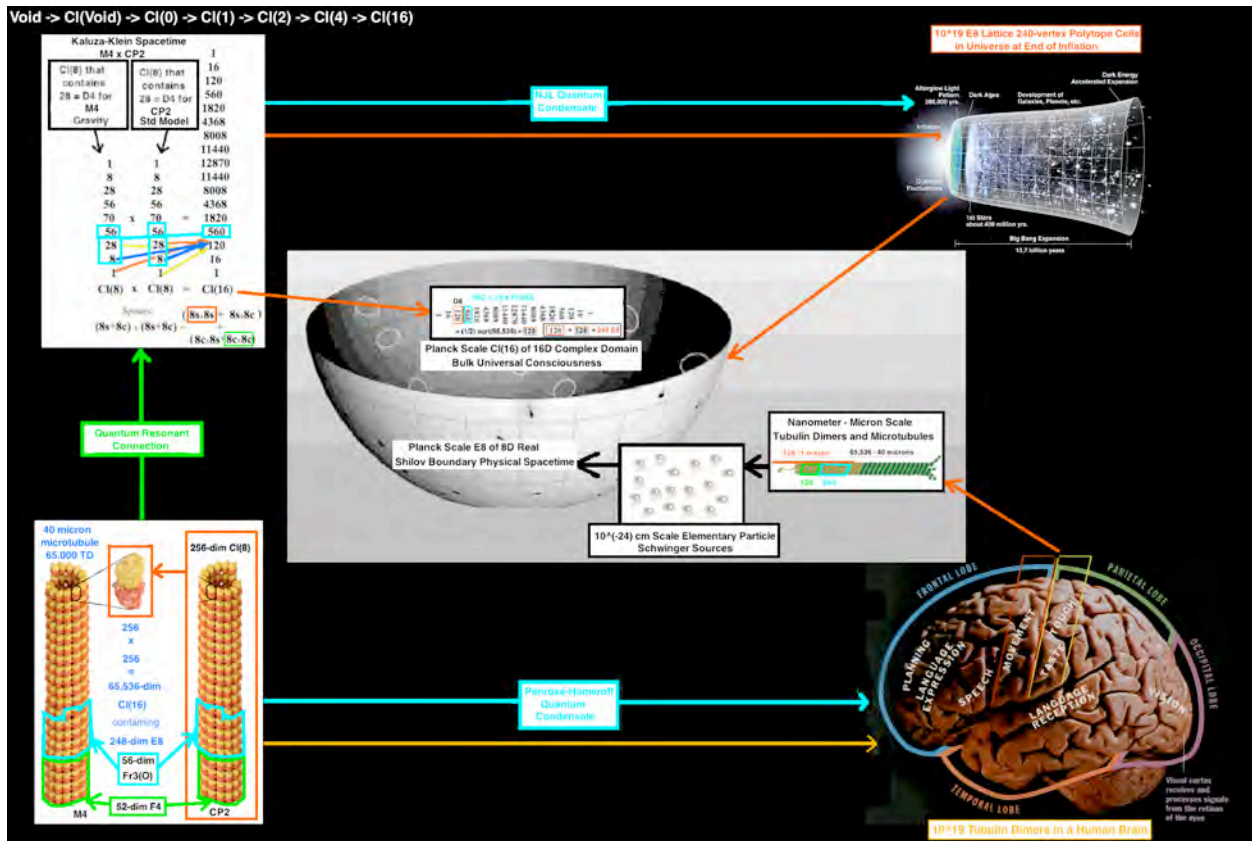

The Lemurian / Atlantean Rule of Gods / Demigods with high Spiritual capabilities confirms what Terence McKenna said in the May 1993 OMNI magazine:

“... From 75,000 to about 15,000 years ago, there was a kind of human paradise on Earth. ... Community, loyalty, altruism, self-sacrifice -- all these values that we take to be the basis of humanness -- arose at the time in a situation in which the ego was absent ... Human beings created an altruistic communal society; then ...[for the past]... 10,000 years ... we've pursued an agenda of beasts and demons ... we've had nothing ... except ... all tooth-and-claw dominance ... For the last 500 years, Western culture has suppressed the idea of disembodied intelligences -- of the presence and reality of spirit. ... You can be a New York psychotherapist or a Yoruba shaman, but these are just provisional realities you're committed to out of conventional ... customs. ... The world is not a single, one-dimensional, forward-moving, causal, connected thing, but some kind of interdimensional nexus. ... Entities there are completely formed. There's no ambiguity about the fact that these entities are there ... On one level I call them self-transforming machine elves; half machine, half elf ... They are teaching something. There is a higher dimensional language that condenses as a visible syntax. For us, syntax is the structure of meaning; meaning is something heard or felt ...

There, the boundless meanings of language cause it to overflow ...
They offer you an object so beautiful, so intricately wrought, so something else that cannot be said in English, that just gazing on this thing, you realize such an object is impossible. ... The object generates other objects ... Ordinarily language creates a system of conventional meanings based on pathways determinate by experience. ... [this is] a place where the stress is on a transcending language ...
Something in an unseen dimension is acting as an attractor for our forward movement in understanding ...
It's a point in the future that affects us in the present. ...
Our model that everything is pushed by the past into the future, by the necessity of causality, is wrong.
There are actual attractors ahead of us in time ...
Once you fall under an attractor's influence, your trajectory is diverted ...
If history goes off endlessly into the future [on its present path], it will be about scarcity, preservation of privilege, forced control of populations, the ever-more-sophisticated use of ideology to enchain and delude people.

We are at the breakpoint.

It's like when a woman comes to term.

At a certain point, if the child is not severed from the mother and launched into its own separate existence, toxemia will set in and create a huge medical crisis

...

When a species prepares to depart for the stars, the planet will be shaken to its core. All evolution has pushed for this moment, and there is no going back.

What lies ahead is a dimension of such freedom and transcendence, that once in place, the idea of returning to the womb will be preposterous.

We will live in the imagination.

We will quickly become unrecognizable to our former selves ...

We ... will ... expand infinitely into pleasure, caring, attention, and connectedness. ...".

Some of my Ancestors

Frank Dodd (Tony) Smith, Jr. - 2017
Paternal Y-DNA

Maternal Mitochondrial M-DNA and



show that my Mother's side Maternal ancestors U5 migrated out of Africa about 150,000 years ago to Finland and that my Father's side Paternal ancestors E3b1= E-V13 migrated out of Africa about 50,000 years ago to Roman Legions and on to Britain. As to Individual Ancestors, my Mother's side goes back to Angus McIntosh born 1715 in Inverness and **John Whistler, born in Africa, husband of Ann McIntosh, daughter of Angus.** John and Ann are my **5-Great Grandparents** (7th Generation back). (22nd Generation has $2^{22} = 4,194,304$ Grandparents. Earth population 1300 was about 400,000,000) My Father's family has a Brewster branch (Y-DNA M-253) to my **20-Great Grandfather (22nd Generation back) John Brewster I of Suffolk born 1279** and a Taylor branch (Y-DNA R1b) to my **35-Great Grandfather Frankish Aristocrat, born 697** and his son, my **34-Great Grandfather Gerold Von Vinzgau, born circa 725**, Graf im Kraichgau und Anglachgau, whose daughter Hildegard married King Charlemagne in 771.

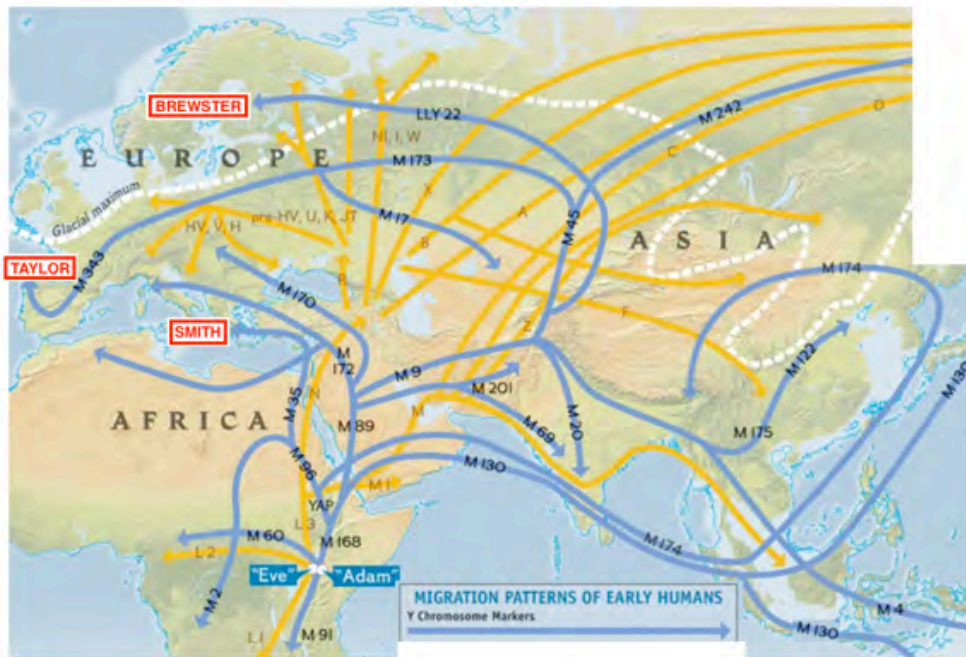

Material herein is taken from various sources, including but not limited to
Wikipedia, ancestry.com, geni.com, fabpedigree.com, werelate.org,
Burkes Landed Gentry, Alumni Cantabrigienses, U. Cambridge from Earliest Times to 1535

Paris and Cambridge around 1300

Around 1300 Scholasticism and Empiricism were being developed at the University of Paris, then the world's leading University, and Cambridge and Oxford Universities which were getting organized based on Paris. Developers of Scholasticism and Empiricism included:

Doctor Mirabilis = Roger Bacon (1219-1292) who advocated Aristotelian Empiricism,
Doctor Angelicus = Thomas Aquinas (1225-1274) also an advocate of Aristotle.
Doctor Illuminatus = Ramon Llull (1232-1315) who produced a system of Logic and a mathematical Art based on what is now known as the Clifford Algebra $Cl(16)$ and the 120 dimensional Lie algebra $Spin(16)$. 700 years ago the details of that mathematics were not known, nor was it known that the math structure of the Art gives a realistic representation of E8 Physics of the Standard Model and Gravity along with its Algebraic Quantum Field Theory. (see viXra 1602.0319)
Doctor Subtilis = John Duns Scotus (1266-1308) who developed Llull's system of Logic into sophisticated Scholasticism, but did not have the math and physics knowledge to show that the mathematical Art of Doctor Illuminatus gives a realistic physics model.

A Second Scholasticism began in 1540 when Ignatius Loyola under Pope Paul III founded the Jesuits, who joined with the Franciscans (Bacon, Llull and Scotus) and the Dominicans (Aquinas) in developing Scholasticism but, without the ability to experimentally measure the relative strengths of the forces of the Standard Model and Gravity and the relative masses of the elementary fermion particles and to compare those observations with the physics model of Llull's mathematical Art, by 1700 Scholasticism had been displaced by the Enlightenment of Descartes et al.

Although I can trace my Brewster Line ancestry back to 1279 birth of John Brewster I, the earliest connection that I have found of them with Cambridge Scholasticism is Robert Brewster of Scrooby (1440-1505) Cambridge MA 1468-9. Most of my Brewster Line family connections with Cambridge were 1588 to 1624, the Golden Age of Second Scholasticism.

However, my Taylor ancestry goes back further, including
20-Great Grandfather Aymer d'Angouleme, comte d'Angouleme, born 1160
19-Great Grandfather Count D'Agouleme William Taillefer born 1200
brother of Isabelle of Angouleme, Queen Consort of England
as wife of King John of England from 1200 to his death in 1216 shortly
after the Magna Carta had been initially signed with rebel barons.

In 1209 three Oxford clerks were arrested in connection with the death of a townswoman and King John ordered their death. After their hanging, many Oxford clerks fled Oxford and some of them founded Cambridge.

After King John's death in 1216 Isabelle returned to Angouleme and married Hugh X of Lusignan. Their son William de Valence (1225-1296) was the first Earl of Pembroke (3rd creation). His son Aymer de Valence, 2nd Earl of Pembroke (1275-1324) married Marie de St. Pol. Apocryphal legend: Marie was maiden, wife, and widow all on her wedding day when her husband was killed in front of her in a friendly jousting match. Fact: Marie founded Pembroke College Cambridge with license from Edward III on Christmas Eve 1347.

1647 Brewster-Taylor New Haven Phantom Ship

- 1480 - Robert Bacon born; John Taylor, Jr., triplet #1, my 13-Great Grandfather, born
- 1573 - Francis Bacon, Grandson of Robert Bacon, adm Fel-Cmnr Trinity Cambridge
Francis Brewster I born
- 1617 - Francis Brewster II adm Fel Cmnr Pembroke Cambridge



- 1619 - Comet - African Slaves to Jamestown
- 1624 - Francis Brewster II MA Cambridge
- 1632 - Francis Brewster I dies
- 1642 - Nathaniel Brewster, 4-Great Grandfather of Abraham Lincoln, AB Harvard

1647 - Nathaniel Bacon, 3-Great Grandson of Robert Bacon, born
New Haven Phantom Ship

Francis Brewster II my 9-Great Grandfather

John Taylor V (not of the triplets family) 4-Great Grandfather of William Tecumseh Sherman
also 4th cousin of my 10-Great Grandfather Thomas Taylor, Jr. (of the triplets family)
who was father of my 9-Great Grandfather John Taylor I the immigrant born 1607

- 1649 - Cromwell signs Charles I death warrant
- 1650 - John Taylor I (of the triplets family) and son James Taylor immigrants to Virginia
- 1651 - John Taylor I dies
- 1653 - Cromwell is Lord Protector
- 1658 - Oliver Cromwell dies
- 1660 - Charles II, restored Stuart, chartered slave shipment directly from Africa
- 1661 - Nathaniel Bacon adm Fel Cmnr St. Catherines Cambridge
- 1665 - Nathaniel Brewster first minister of the Presbyterian Church at Setauket
- 1667 - Nathaniel Bacon MB Cambridge
- 1674 - Nathaniel Bacon immigrant to Virginia
- 1675 - Comet
- 1676 - Bacon's Rebellion burns Jamestown, Bacon dies, Charles II puts it down
- 1690 - Nathaniel Brewster dies

From scrapbookyourfamilytree.com isaacs-story "... **"Vision of the Phantom Ship,"** ... by Jesse Talbot in 1850, recalls ... **a New Haven vessel lost at sea in [1647]** ...
... merchants at New Haven ... built or had built a ship in Rhode Island (about 150 tons)
to be used in trade with England and other countries ... sailors and ship builders called
this ship 'crank sided and walty' (or in terms we understand today, very unstable) ...
In the winter of 1645/46 the "Great Shippe" was chartered by "The Company of
Merchants of New Haven" with Captain George Lambert in command. ...Because ...

loading ... was delayed, it was not ready to sail until ... about the middle of January 164[7], **seventy persons boarded the ship**, among them were ...



George Lamberton ...

[and my 9-Great Grandfather **Francis Brewster II**, ancestor of Abraham Lincoln and **John Taylor V** (not of the triplets family) 4-Great Grandfather of William Tecumseh Sherman and 3-Great Grandson of my 15-Great Grandfather William Taylor, II, born 1429, who was common ancestor of James Madison, Jr., Zachary Taylor and William Tecumseh Sherman] ...

The vessel was iced in so solidly at its pier, that in order to get to Sea every able man and boy had to help hand-chop a three mile channel out of Long Island Sound. Then the ship had to be towed stern-first through the ice out to the waters of the North Atlantic. This was a chillingly bad omen, and the crew members almost mutinied because of it. ... The ship's master, George Lamberton, an experienced mariner, predicted many times that the "walty" ship would "prove their grave." ...

The ship was never heard from again ...

Six months later ... On a humid June afternoon, heavy thunderstorms descended upon New Haven harbor. Excitement overtook the town as person after person saw their `Great Shippe´ emerging from the cloudbanks and sailing into the harbor. However, it

was sailing against the winds and above the waves - in the fogged clouds and not touching the waters below. As it approached the shore, and as dusk fell, the main topmast broke off, fell and entangled other sails on the deck. Pieces of the ship seemed to break off. Many watching from the harbor saw a human figure on the bow, sword raised and pointing to the sea, just before the ship, ragged, broken and haunted, rolled over on her side and disappeared into the mists ...
No debris-wood, casks, sails - from the ship was ever found.
The water calmed and the mists lifted. The ship had vanished. ...”.

From colonialwarsct.org “... Henry Wadsworth Longfellow's The Phantom Ship

In Mather's Magnalia Christi, Of the old colonial time,
May be found in prose the legend That is here set down in rhyme.
A ship sailed from New Haven, And the keen and frosty airs,
That filled her sails at parting, were heavy with good men's prayer.
"O Lord if it be thy pleasure" - Thus prayed the old divine -
"To bury our friends in the ocean, Take them, for they are thine!"
But Master Lamberton muttered, And under his breath said he,
"This ship is so crank and walty, I fear our grave she will be!"
And the ships that came from England, When the winter months were gone,
Brought no tidings of this vessel Nor of Master Lamberton.
This put the people to praying that the Lord would let them hear
What in his greater wisdom He had done with friends so dear.
And at last their prayers were answered: It was in the month of June,
An hour before the sunset Of a windy afternoon,
When, steadily steering landward, A ship was seen below,
And they knew it was Lamberton, Master, Who sailed long ago.
On she came, with a cloud of canvas, Right against the wind that blew
Until the eye could distinguish The faces of the crew.
Then fell her straining topmasts, Hanging tangled in the shrouds,
And her sails were loosened and lifted, And blown away like the clouds.
And the masts, with all their rigging, Fell slowly, one by one,
And the hulk dilated and vanished, As sea-mist in the sun!
And the people who saw this marvel Each said unto his friend,
That this was the mould of their vessel, And thus her tragic end.
And the pastor of the village Gave thanks to God in prayer,
That, to quiet their troubled spirits, He had sent this Ship of Air.

...”

The Brewster Line and Taylor Branch of ancestry intersected in 1780 and give Common Ancestry with Madison, Taylor, Lincoln and Sherman

Brewster Ancestry Line:

20-Great Grandfather Sir John Brewster I born 1279 died 1299
19-Great Grandfather Sir John Brewster II born 1299 died 1325
18-Great Grandfather Sir John Brewster III born 1325 died 1379
17-Great Grandfather Galfridus Brewster I born 1350 died 1410
he was also 17-Great Grandfather to HRH Charles and to Lady Diana
16-Great Grandfather John Brewster born 1380 died 1441
15-Great Grandfather Humphrey Brewster born 1410 died 1443
14-Great Grandfather **Robert Brewster of Scrooby** born 1440 (Cambridge MA 1468-9) died 1505
At Cambridge in the Scholastic Era he could have learned about Ramon Llull (1232-1315)
13-Great Grandfather William Brewster of Rushmere born 1470 died 1521
12-Great Grandfather Robert Brewster born 1494 died 1540
his brother William Brewster of Hatfield b 1510 (B.Can.L. Cambridge 1532-3).
11-Great Grandfather Humphrey Clearke Brewster born 1526 died 1593
his son Humphrey Jr matric pens St Johns Cambridge 1588 died 1613 age 44
10-Great Grandfather **Francis Brewster I** born 1573 died 1632
his Second Cousin William "Elder" Brewster was Pilgrim leader of Mayflower Compact
his son John born 1600 adm pens Emmanuel Cambridge 1610
his son Robert born 1599 matric Fel Cmnr Pembroke Cambridge 1617
9-Great Grandfather **Francis Brewster II** born 1598 (adm Fel Cmnr Pembroke 1617 Cambridge MA 1624)
he died 1647 on the New Haven Phantom Ship with John Taylor
8-Great Grandfather **Nathaniel Brewster** born 1618 (Harvard AB 1642) died 1690
he was 4-Great Grandfather of President Abraham Lincoln
7-Great Grandfather Daniel Brewster born 1662 died 1748
6-Great Grandfather John Brewster born 1705 died 1778
5-Great Grandfather John Brewster born 1728 died 1816 in SC
4-Great Grandfather James Brewster b 1756 d 1804 in SC married Mildred Downs 1780 in NC
3-Great Grandmother Sarah Brewster b 1783 d 1857 in GA married James Dickerson
2-Great Grandmother Mary Brewster Dickerson b 1819 d 1895 in GA
she married Benjamin Franklin Smith b 1815 d 1893 in GA
Great Grandfather James Madison Smith b 1841 d 1884 in GA
Grandfather James Madison Smith b 1877 d 1932 in GA
Father Frank Dodd Smith b 1906 d 1986 in GA
Frank Dodd (Tony) Smith, Jr., born 1941

My closest Common Ancestor with Abraham Lincoln is Nathaniel Brewster (Harvard AB 1642)

Abraham Lincoln 4-Great Grandfather Nathaniel Brewster born 1618 (Harvard AB 1642)
Abraham Lincoln 3-Great Grandmother Sarah Brewster born 1656 married Jonathan Smith (son of Bull)
Abraham Lincoln 2-Great Grandmother Abigail Smith born 1678 married Isaiah Harrison
Abraham Lincoln Great Grandmother Abigail Harrison born 1710 married Alexander (Jr.) Herring
Abraham Lincoln Grandmother Bethsheba Herring born 1742 married Abraham (Capt.) Lincoln
Abraham Lincoln Father Thomas Lincoln born 1778
Abraham Lincoln born 1809

Taylor Ancestry Branch:

- 35-Great Grandfather Frankish Aristocrat, born 697
- 34-Great Grandfather Gerold Von Vinzgau, Graf im Kraichgau und Anglachgau, born circa 725
his daughter Hildegard married King Charlemagne in 771
- 33-Great Grandfather Udalrich I, Graf in Breisgau, born circa 770
- 32-Great Grandfather Udalrich II, Graf im Breisgau, born 783
- 31-Great Grandfather Wulfhard Taillefer d'Angouleme, born circa 783
- 30-Great Grandfather Wulgrin Tallefer d' Angouleme, born circa 828
- 29-Great Grandfather Alduin, born circa 866
- 28-Great Grandfather William I "Taillefer" d'Angouleme, born circa 895
- 27-Great Grandfather Arnaud "Manzer" d'Angouleme, born circa 927
- 26-Great Grandfather William Taillefer d'Angouleme, born circa 978
- 25-Great Grandfather Geoffrey d'Angouleme, born 1014
- 24-Great Grandfather Foulques d'Angouleme, born 1015
- 23-Great Grandfather Guillaume V 'Taillifer' d'Angouleme, born 1067-1103
- 22-Great Grandfather Vulgrin II d' Angouleme, born 1070-1130
- 21-Great Grandfather Guillaume 'Taillefer' d'Angouleme, born circa 1115
- 20-Great Grandfather Aymer d'Angouleme, comte d'Angouleme, born 1160
- 19-Great Grandfather Count D'Agouleme William Taillefer born 1200
brother of Isabelle of Angouleme, Queen Consort of England
- 18-Great Grandfather Baron Hanger Taylifer born 1256
- 17-Great Grandfather Sir John Taylor (Taylifer), Kt, born circa 1324
- 16-Great Grandfather William Taylor, I, born before 1377
- 15-Great Grandfather John Taylor, II, born 1403
- 14-Great Grandfather William Taylor, II, born 1429, Master of the Rolls of the Court of Chancery,
father of triplets
- 13-Great Grandfather John Taylor, Jr., triplet #1, born 1480
Doctor of Civil Law and Doctor of Canon Law at Cambridge in 1520
- 12-Great Grandfather Rowland Taylor, Archdeacon of Exeter, born 1510, burned at stake 1555
Doctor of Laws degree from Cambridge in 1534
- 11-Great Grandfather Thomas Taylor, Sr., born 1548
- 10-Great Grandfather Thomas James Taylor, Jr., born 1574
his 3-Great Granddaughter Elizabeth Bassett married Benjamin Harrison V who signed the
Declaration of Independence. Their son **William Henry Harrison** and their Great Grandson
Benjamin Harrison were Presidents
- 9-Great Grandfather John Taylor I, the Immigrant born 1607
- 8-Great Grandfather Col. James Taylor born 1633
- 7-Great Grandfather James Taylor II born 1675 had daughter Frances and son Zachary:
James Madison Jr Grandmother Frances Taylor born 1700 married Ambrose Madison
James Madison Jr Father Col. James Madison born 1723
James Madison Jr born 1751
Zachary Taylor Grandfather Zachary Taylor I born 1707
Zachary Taylor Father Richard Taylor born 1744
Zachary Taylor born 1784
- 6-Great Grandmother Martha Taylor born 1702 married Thomas Chew
- 5-Great Grandmother Frances Chew born 1730 married Henry Downs, Jr.
4-Great Grandmother Mildred Downs born 1760 married James Brewster 1780 in NC
- 3-Great Grandmother Sarah Brewster born 1783 married James Dickerson
- 2-Great Grandmother Mary Brewster Dickerson born 1819 married Benjamin Franklin Smith born 1815
Great Grandfather James Madison Smith born 1841
Grandfather James Madison Smith born 1877
Father Frank Dodd Smith born 1906
Frank Dodd (Tony) Smith, Jr., born 1941

According to Wikipedia: "... In 848 Angoulême was sacked by the Viking chief Hastein. ...



... In 896 or 930 the city suffered another attack from invading Vikings but this time the Vikings faced an effective resistance. Guillaume I, third Count of Angoulême, at the head of his troops made them surrender in a decisive battle. During this engagement, he split open to the waist Stonius, the Norman chief, with a massive blow together with his helmet and breastplate. It was this feat that earned him the name Taillefer ... Latin: *Incisor ferri*, meaning "hewer of iron" ... which was borne by all his descendants until Isabella of Angoulême who was also known as Isabelle Taillefer, the wife of King John of England. The title was withdrawn from the descendants on more than one occasion by Richard Coeur-de-Lion then the title passed to King John of England at the time of his marriage to Isabella of Angoulême, daughter of Count Aymer of Angoulême ...".

My 19-Great Grandfather William Taillefer (1200-1274), younger brother of Isabella of Angouleme, was Count D'Angouleme. A successor Count of Angouleme (Count from 1496 to 1515) was King Francis I of France who was patron of Giovanni da Verrazano who first came to what is now **New York City** and who named it **New Angouleme** in 1524.

Later (1609 or so) the Dutch fur traders came there and in 1614 named the area New Netherland and New Angouleme became **New Amsterdam**. In 1664 it was traded to the English and renamed **New York**.

**My closest Common Ancestor with William Tecumseh Sherman is William Taylor II
whose 3-Great Grandson John Taylor V
died on the New Haven Phantom Ship with Francis Brewster II**

William Tecumseh Sherman 9-Great Grandfather William Taylor, II, born circa 1429
Master of the Rolls of the Court of Chancery

William Tecumseh Sherman 8-Great Grandfather John I. Taylor I, born 1451

William Tecumseh Sherman 7-Great Grandfather John Taylor of Shadoxhurst, born circa 1480
not of the triplets family

William Tecumseh Sherman 6-Great Grandfather John Taylor born 1522

William Tecumseh Sherman 5-Great Grandfather John Taylor IV born 1563

William Tecumseh Sherman 4-Great Grandfather John Taylor V born 1603 died Phantom Ship

William Tecumseh Sherman 3-Great Grandfather Thomas Taylor born 1642

William Tecumseh Sherman 2-Great Grandfather Nathan Taylor born 1681

William Tecumseh Sherman GreatGrandmother Mindwell Taylor born 1727 married Daniel Sherman

William Tecumseh Sherman Grandfather Taylor Sherman born 1759

William Tecumseh Sherman Father Charles R. Sherman born 1788

William Tecumseh Sherman born 1820.

Francis Brewster I

12-Generation 10-Great Grandfather of Frank Dodd (Tony) Smith Jr
Born 1566 in Suffolk England. Died 1644 in Somerset England.



Suffolk



Scrooby



Somerset

Suffolk and Somerset were Parliamentarian in the English Civil War.

The earliest Brewster to attend University was the 2-Great-Grandfather of Francis I
Robert Brewster, of Scrooby, b. 1440 d. 1505, MA Cambridge 1468-9.

Francis I did not attend University
but was able to send his three sons to Cambridge where his brother had matriculated
and to send two of his grandsons to Cambridge and to Harvard.

How did Francis I make enough money to send children and grandchildren
to Cambridge and Harvard ?

His father Humphrey Clearke Brewster (1526-1593) (according to Burke's Landed Gentry)
"... purchased the manor and living of Wrentham, and in 1556, built the hall there, at
which his descendants continued to reside until 1794 ... The income of the proprietors of
Wrentham was derived from lands in more than twenty parishes in Suffolk and Norfolk.
In the former county the Brewsters possessed leading influence,
and in the great rebellion became partisans of the parliament ...
Humphrey [Clearke] Brewster ... had ... sons ... [William b. ca 1566] and

Francis [I] his heir ... b. in 1566 ... d. in 1644 ...[and]

Humphrey [Jr]... [who matriculated as Pensioner St. John's Cambridge in 1588;
admitted Middle Temple 1596 from New Inn, b. 1569 died 1613 at age 44] ...

and

four dau[ghter]s ... Elizabeth ... Susan ... Mary ... and Jane ...

The elder son and heir **Francis Brewster [I]**, Esq. of Wrentham Hall ...
 an active parliamentarian during the rebellion as a magistrate and deputy-lieutenant ...
 had ...[sons **Francis II 1598-1647**, **Robert 1599-1663**, and **John b. 1600**
 and daughters Gillian Brewster and Mary Garth]

[Fellow-commoner; the first of the three ranks in which students were matriculated
 Pensioner; the second of the three ranks in which students were matriculated
 Sizar. The third of these ranks. In old times sizars performed many menial services.]

John ... b. in [1600]... d. in 1677 ...[subscribed Oxford 1613 **admitted Pensioner Emmanuel Cambridge 1620** adm at Gray's Inn 1623]... was a member of the parliament committee formed for the preservation of the peace of the county of Essex ...

Robert ... b. in [1599]... d. in 1663 ... [**matriculated as Fellow Commoner Pembroke Cambridge in 1617**; MP for Dunwich and for Suffolk]... had two sons ...

Francis ... b. in 1623 ...[**matriculated as Fellow Commoner St. Catherine's Cambridge in 1642** adm at Gray's Inn 1646]... d. 1671 ...

Robert ... b. in 1625 ... d. in 1681 ...

Francis [II], of Wrentham, b. in [1598] ...[**was admitted (age 17) as Fellow Commoner Pembroke Cambridge in 1617**; **matriculated in 1618**; **received BA in 1620**;



received MA in 1624. He was a Barber/Surgeon and a Puritan. ...

By the sixteenth century ... the Castle of Bristol ... had fallen into disuse, but the City authorities had no control over royal property and the precincts became a refuge for lawbreakers ... On 23 Aug 1626 ...[**Francis II**]... received a lease of the ... castle ... from King Charles I, for a period of 80 years ...

In 1630 the city bought the castle ...

In 1638 ...[**Francis II**]... was one of the original settlers of New Haven ...

the Civil War broke out [in 1642 The overall outcome of the war was threefold: the trial and execution of Charles I (1649); the exile of his son, Charles II (1651); ... the replacement of English monarchy with ... the Commonwealth of England (1649-53) ... then the Protectorate under ... Oliver Cromwell (1653-58) and his son (1658-59)]...

Around 1647 he died at sea aboard the Lombard Phantom Ship]... having had issue ...[daughters **Mary French b. 1633** and **Hannah Thompson** and ? **Herbert** sons **Nathaniel 1618-1690**, **John b. 1632** and **Robert b. 1638** and **Francis 1627-1694**, **Joseph b. 1628** and **Benjamin b. 1644**]

Mary, daughter of Francis II, testified at a 1654 New Haven witch trial

Witchcraft officially became a crime in Connecticut in 1642 ...

New Haven enacted its witchcraft law in 1655 ...

almost all of alleged witches were hanged ... no witch was ever burned at the

stake in Connecticut (www.damnedct.com/connecticut-witchcraft-trials and

!The Witchcraft Delusion in Colonial Connecticut (1647-1697) by John M. Taylor]

Nathaniel ... b. in [1618 d. 1690]...

[enrolled in Harvard in 1639 and was in Harvard's first graduating class,



receiving the AB degree in 1642, ... Nathaniel then moved to England and became a cleric in the Church of England. In 1644 Nathaniel married Abigail Reynes with whom he had 3 children. In 1653 Oliver Cromwell was made Lord Protector of England, Scotland, and Ireland. After Abigail's death in 1654 Nathaniel attended Trinity College in Dublin receiving the B.D. degree in 1656. While in Dublin Nathaniel married Sarah Ludlow with whom he had 7 children. The English Restoration Uniformity Act of 1662 drove Puritan ministers from the Church of England to Presbyterian and Congregational Churches. In 1663 Nathaniel moved to Boston. In 1665, the year of Isaac Newton's B.A. degree from Trinity College, Cambridge (which then closed for the 1665-1666 Great Plague), Nathaniel moved to Suffolk County, Long Island, becoming the first minister of the Presbyterian Church at Setauket (Brookhaven Twp.)]...

This family had many ramifications;

one offshot ... was established in the United States by William [Elder] Brewster ...

the ruling elder and spritual guide of the Pilgrim Fathers who, in 1620, went out to America to avoid the religious persecutions to which they were exposed, and were the

founders of New England ...[He was born 1565 in Scrooby Nottinghamshire;

matriculated as Pensioner Peterhouse College Cambridge 1580;

Y-DNA Haplogroup I-M253; died 1644 Plymouth, **second cousin of Francis I**

[His father]... William Brewster of Scrooby b. 1534 ... died in 1590 ...

was appointed Receiver and Bailiff of the Archbishop's estates at Scrooby in

1575 for the duration of his lifetime. ...[and]... was succeeded by his son ...

From 1606-7 [Elder] Brewster held Separatist meetings in the manor house.

Around 1636-7 most of the manor house and its outbuildings were demolished following a demolition order granted by Charles I (www.scrooby.net/page/scroobyManorHouse)]

...[Brewster] Mottto - Verite soyet ma garde [Truth be my shield]...”.

John Whistler

1700-1750

In Scotland, my 6-Great Grandfather Angus McIntosh of Inverness supported exiled Stuarts and participated in the Jacobite Rebellion to overthrow the House of Hanover. He and his daughter, my **5-Great Grandmother Ann McIntosh** were captured and she was shipped to Orange County VA as an Indentured Servant.

In Africa, my **5-Great Grandfather John Whistler** (or his ancestors) was captured and shipped to Orange County VA as a Slave.

1750-1800s

In Virginia, my **5-Great Grandparents John Whistler and Ann McIntosh** were effectively husband and wife as slave / servant of Arjalon Price in Orange County VA. In 1756 they had my **4-Great Grandmother Molly a/k/a Mary a/k/a Frankey McIntosh** who became property valued at 20 pounds.

For that pregnancy Ann was banned from the church and whipped fifty lashes.

In 1787 Molly gave birth to my **3-Great Grandmother Mary McIntosh** **who at age 16 in 1803 obtained a certificate** from David Jamison, a justice of the peace from Culpeper County, and produced it in the District of Columbia Court in Alexandria on 17 November 1803 **declaring that she was born free.**

She then moved to Richmond County NC and married John McKennon.

In 1810 they had my **2-Great Grandmother Margaret McKennon** who married Malcolm McKinnon. They moved to Echols County Georgia, and in 1843 had my **Great Grandmother Mary Frances McKinnon** who married William Jeremiah Absolom Ham and gave birth in 1875 to my **Grandfather George Clinton Ham**, father of my **Mother Willie Julia (Billie) Ham.**

The history of Britain's wars such as the Jacobite Rebellion and its use of Indentured Servitude to send war losers and poor people to America as servant labor substantially equivalent to slave labor is well known but

the history of the African Slave Trade is less well known:

Tim Hashaw in "The Birth of Black America" said:

"... Long before the birth of Jesus there had flourished in East Africa the magnificent city-state of Aksum. Ideally situated to control the long flow of trade passing from Asia and East Africa through the Red Sea to the Mediterranean, Aksum ... became [a] great cosmopolitan center... in the ancient world. By Roman times, the wealth and influence of Aksum was envied throughout the Mediterranean, and its people, the Ethiopians, were widely famed for piety, justice, hospitality, and a long, unbroken tradition of literature. In the fourth century A.D. ... Ethiopia under King Ezana ... established the world's first Christian state. ... The Christian rulers of Ethiopia had been tolerant of all religions, including Judaism and Buddhism. Because Christian Ethiopians had offered refuge to persecuted Muslims, the Prophet Muhammad, according to Islamic tradition, had instructed Muslim armies to leave Ethiopia in peace ...

on August 28, 1482 ... the Portuguese explorer Diogo Cao became the first European to reach the mouth of the great Congo (Zaire) River, six degrees south of the equator. Here he found unexpected evidence of an impressive advanced civilization; Africans unknown to the Mediterranean world yet refining gold, silver, copper, and iron and clothed in fine garments ...

This was ... [a] kingdom...[that] gave their kings the title of ngola (iron blacksmith), from which comes the name of the country, "Angola"

...

in the 1520s ... Somali Muslim warlord ... Ahmed Gran, son of an Ethiopian Christian priest and a Somali prostitute, invaded Ethiopia ... captured and burned Aksum ...

...

in 1616 ... at Jamestown ... the Virginia Company shifted its focus ... to social and economic ventures intended to create a permanent colony of consumers, producers, and manufacturers with whom company investors hoped to trade

...

at the latter end of 1618, King James's chronicler William Camden had reported the sudden appearance in the sky of a comet ... on December 7, 1618, as the corsairs White Lion and the Treasurer were preparing to leave for the West Indies, Camden reported **the comet visible at the latitude of Jamestown ... in 1619 ... the first Africans ... [were brought]... to English-speaking America from Angola**

... The Spanish slave frigate San Juan Bautista left Africa with 350 slaves and crossed the Atlantic to be captured in the Gulf of Mexico in the summer of 1619 by two English pirate ships - the White Lion ... and the Treasurer ... the first Africans in English North America were ... delivered to Jamestown ... in 1619 ...

two dozen ... by the White Lion and ... half dozen [by]... the Treasurer

...

In less than two decades after arriving, many of this skilled and intelligent first generation of Jamestown Africans were free and had established their own farms and communities in Tidewater Virginia ... From 1619 to 1676, one generation has a brief opportunity to bestow freedom upon its descendants

...

Nearly sixty years [after 1619], Virginians saw another comet in the latitude of Jamestown ...

England in 1660 invited Charles II, grandson son of James I, to return to the throne and restore the Stuart dynasty. ... Charles II, among other things, that year gave the Royal African Company a charter to ship slaves directly from Africa. No longer would American plantations rely on freelance pirates raiding Spanish and Portuguese frigates for slaves. In 1660, slavery became a British industry, ... Britain sold Africans to the faraway colonies to do jobs that English peasants did not want to do. Between 1648 and 1681, the number of whites in Virginia increased by 5.2 percent, while the number of blacks in Virginia in the same time period increased by 10 percent, due in large part to imported Africans ... Thus began **Bacon's Rebellion** [of 1676]...

Nathaniel Bacon, a planter and the first American populist. Bacon raised an army by promising freedom to every enslaved African and indentured Englishman who would run away and join him. ...

Six months later, Bacon's campaign ceased being a war against natives and became a war of the colonial underclass against Jamestown's ruling royalist elite. Free black and white farmers, plus runaway Angolan fugitives, marched to Jamestown to protest government abuses and cast Berkeley and his favorites out of power. Governor Berkeley fled and, at the high point of the attack, Bacon's army, by then largely African, seized the colonial capital and burned it to the ground.

In the ashes of Jamestown, Governor Berkeley appealed to the Stuart king of England, who gave him a fleet to put down the ... rebels. Bacon died of natural causes at this time and the rebellion, though as powerful as ever, had no capable leader. ...

The royalist elite returned and rebuilt Jamestown. They of course did not ignore the great number of Africans in the rebellion and took steps to prevent a future reoccurrence.

...

After 1660, as the number of imported Africans dramatically increased, issues involving the status of Africans passed from the local courts to the colonial legislature, particularly as a result of Bacon's Rebellion ... in 1691, the Virginia legislature ... outlawed mixed marriages and required that mixed children born out of wedlock to European women be bound as servants for thirty years ... European women and their offspring could not be enslaved ... in 1723, the Virginia Assembly took the last step and banned outright the freeing of slaves, unless they had performed some notable public service, such as reporting a planned slave rebellion ...”.

According to britannica.com “... Nathaniel Bacon, (born January 2, 1647, Suffolk ... died October 1676, Virginia ... leader of Bacon’s Rebellion (1676), the first popular revolt in England’s North American colonies.

A kinsman of the famous Sir Francis Bacon ...[their closest common ancestor was Robert Bacon b 1480 d 1548 Grandfather of Francis Bacon b 1561 d 1626 an English philosopher, statesman, scientist, jurist, orator, and author known as the father of empiricism Adm Fell-Com Trinity 1573 Matric 1573 Adm at Gray’s Inn 1576 MA 1594 and 3-Great Grandfather of Nathaniel Bacon b 1647 d 1676]...

Nathaniel Bacon graduated from the University of Cambridge ...[Adm Fell-Com at St Catherine’s 1661 adm at Gray’s Inn 1664 MB 1667]...”.

Maternal Line at Garden of Eden

Overview: my Mother's side Maternal ancestors U5 migrated out of Africa about 150,000 years ago to Finland



(years ago = BP = Before Present)

150,000 BP - Mitochondrial Eve - Haplogroup L1

75,000 BP - Haplogroups L2 and L3 - went out of Africa across the Red Sea

50,000 BP - Haplogroup N branched off of L3 to Incubation Period in Garden of Eden



Cousins of my Maternal DNA Line:

Part of Haplogroup N were ancestors of Noah who went with the Persian Gulf Flood to the Yemini Coast to Ethiopia, home of Abraham and Moses who went up the Nile to Giza Paternal Line at Nile River



According to Y-DNA, Enoch = Boskop descendants moved up the Nile to Giza and across the Indian Ocean to Sunda, Japan, and Tibet. The corresponding M-DNA migration to Sunda was by Haplogroup M branching off of L3

Paternal Line Cousins at Angkor Wat

Overview: my Father's side Paternal ancestors E3b1= E-V13 migrated out of Africa about 50,000 years ago to Britain with Roman Legions

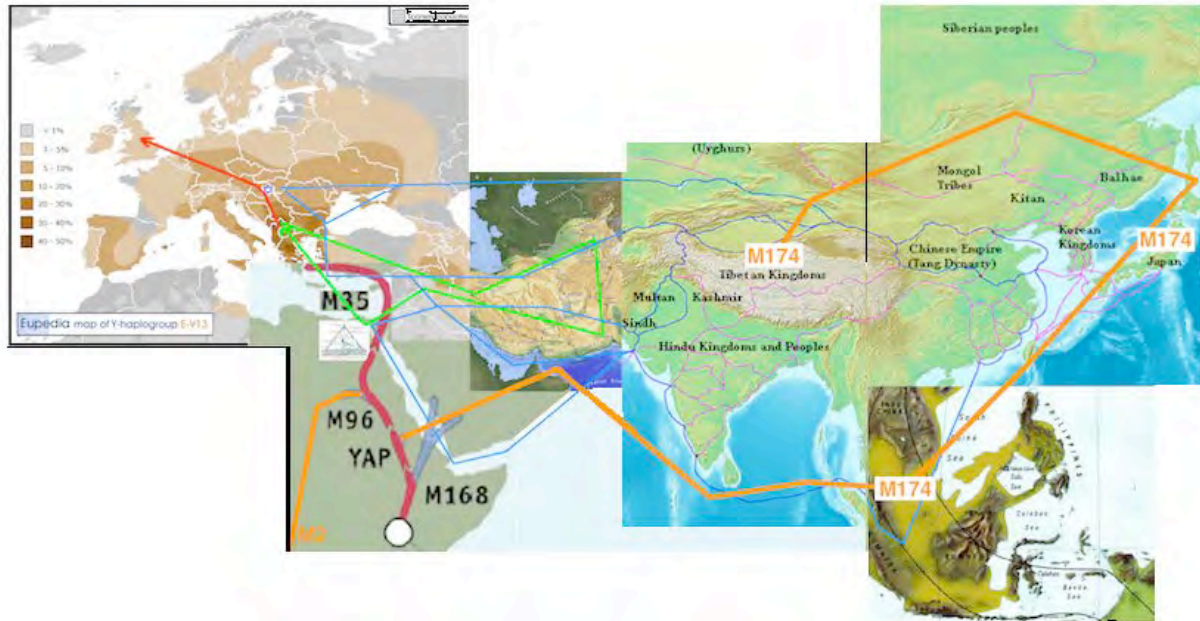

50,000 BP - Africa Haplogroup M168



50,000 - 40,000 BP - Africa Haplogroup YAP

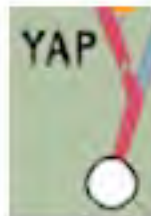

Cousins of my Paternal Y-DNA Line:

50,000 BP - M174 leaves YAP from Africa to Sunda, Japan, Tibet



Tibet - I Ching 64 = E8 triality

Japan - Shinto Futomani 128 = E8-CI(16) half-spinor

Sunda - Origin of India-China Asia population (HUGO, Science 326 (2009) 1541- 1545)

Rg Veda - 240 E8RV Hindu - Sanskrit - Mt Meru 256 = CI(8) = CI(16) spinor

Angkor Wat (yellow) - Angkor Thom (red) - Phnom Bakheng (purple)



(tourismcambodia.com map)

Angkor Wat has 4 Inner Pillars and 4 Middle Pillars - IFA Tetragrams and M4xCP2

Angkor Thom has 8 Outer Pillars and 16 Middle Pillars - Fr3(O) $\dot{U}d\grave{a} * \bullet MY [| : \grave{a} \dot{S} \grave{a} \wedge \bullet$

and 1+12+4 Inner Pillars - Bohm Quantum Potential and Quarks and Leptons

Both have Outer 8-point squares - 8 IFA Opele Chain Elements - $2^8 = 256$ IFA Odu

Both Centers have 8 layers - $2^8 = 256$ IFA Odu = dim CI(1,7) = CI(8)

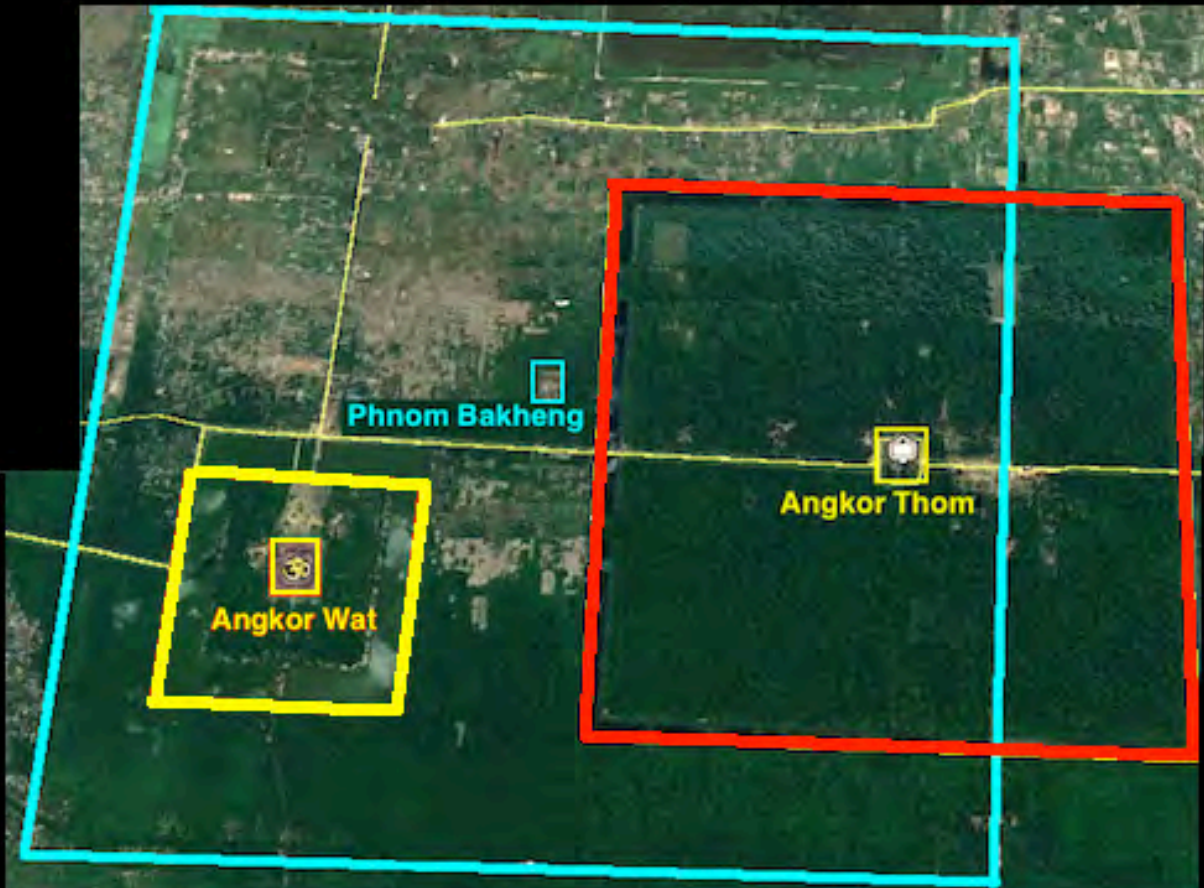

According to Wikipedia: "...Phnom Bakheng is a symbolic representation of Mount Meru ... a status emphasized by the temple's location atop a steep hill 65 m above the surrounding plain. The temple is built in a pyramid form of seven levels ... At the top level [are] five sandstone sanctuaries - [as in] Angkor Wat seen from Phnom Bakheng ...

... Originally, ... small towers were arrayed around the temple at ground level and on various of its tiers; most of them have collapsed ...".



(google earth images)

Phnom Bakheng has 3-mile square moat with area $3^2 = 9$



Angkor Thom

has 2-mile square moat $2^2 = 4$



Angkor Wat

has rectangular moat with 1-mile base

Paternal Line at Nile River to Great Pyramid

40,000 BP - M96 leaves YAP and goes up Nile

Cousins of my Paternal Y-DNA Line:

M2 branch going back south to Boskop



36,000 BP - M96 continues up Nile to build the Great Pyramid

and during its construction to invent the efficient Hebrew Alphabet
and the time of Late Wisconsin Glaciation

and the time that the shock wave of the Geminga Supernova hit the Earth
and beginning of Manetho's Rule of Gods on Earth (36,000 to 22,000 BP)



The Builders of the Great Pyramid who had migrated throughout the length of the Nile along which substantially contiguous settlements enabled them to maintain enough contact to maintain the details of the oral traditions of IFA so that when they built the earliest of the pyramids, the Great Pyramid, they did not deface it with any writing but instead encoded the IFA Clifford Algebra in the structure of the Pyramid itself: The Great Pyramid is built of 203 layers (courses) plus a now-missing capstone represented by $1+1 + 8+8 = 18$ for a total of 221 courses above ground level. The Subterranean Pit is as deep below ground level as Queen's Chamber is above it so the Subterranean Pit depth equivalent to 35 courses is dual to the Queen's Chamber height of 35 courses just as the 70 mid-grade grade 4 elements of the CI(8) Clifford

Algebra are (35+35) 35 elements plus 35 elements, dual to each other. When the Subterranean 35 courses are included, the total number Courses of the Great Pyramid is 221 + 35 = 256 = number of IFA Odu and dimension of IFA Clifford Algebra Cl(8)

$$Cl(8) = 1 + 8 + 28 + 56 + (35 + 35) + 56 + 28 + 8 + 1$$

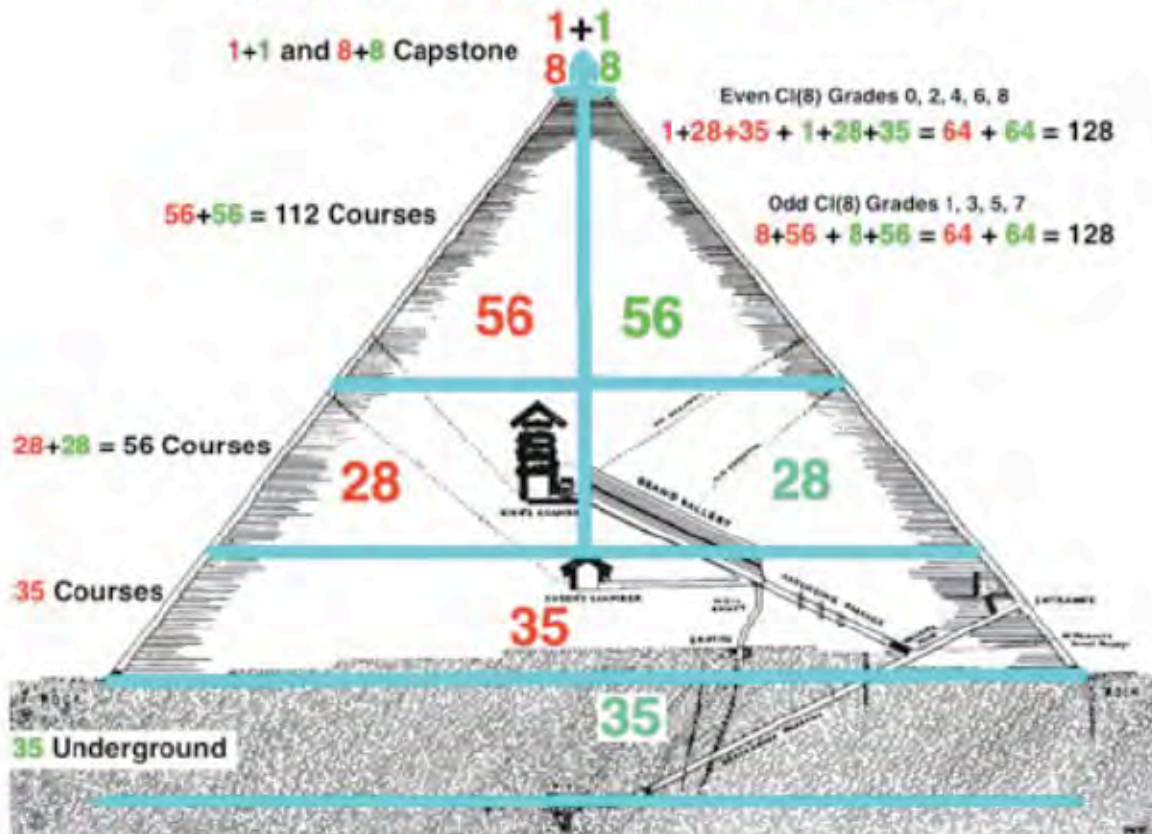

$$1 + 8 + 28 + 56 + (35 + 35) + 56 + 28 + 8 + 1$$

(image adapted from David Davidson image -
 for a larger version of this image go to tony5m17h.net/GreatPyrCl8.png
 or valdostamuseum.com/hamsmith/GreatPyrCl8.png)
 (for more details about the Great Pyramid Geometry correspondences see viXra 1305.0060)

(chart from The Great Pyramid, by Peter Lemesurier, Element Books (1987))

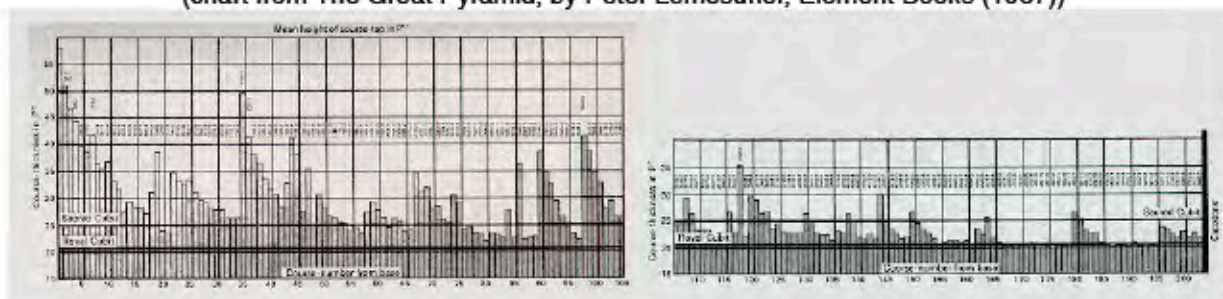

Mt. Meru corresponds to the Binomial Pyramid Triangle

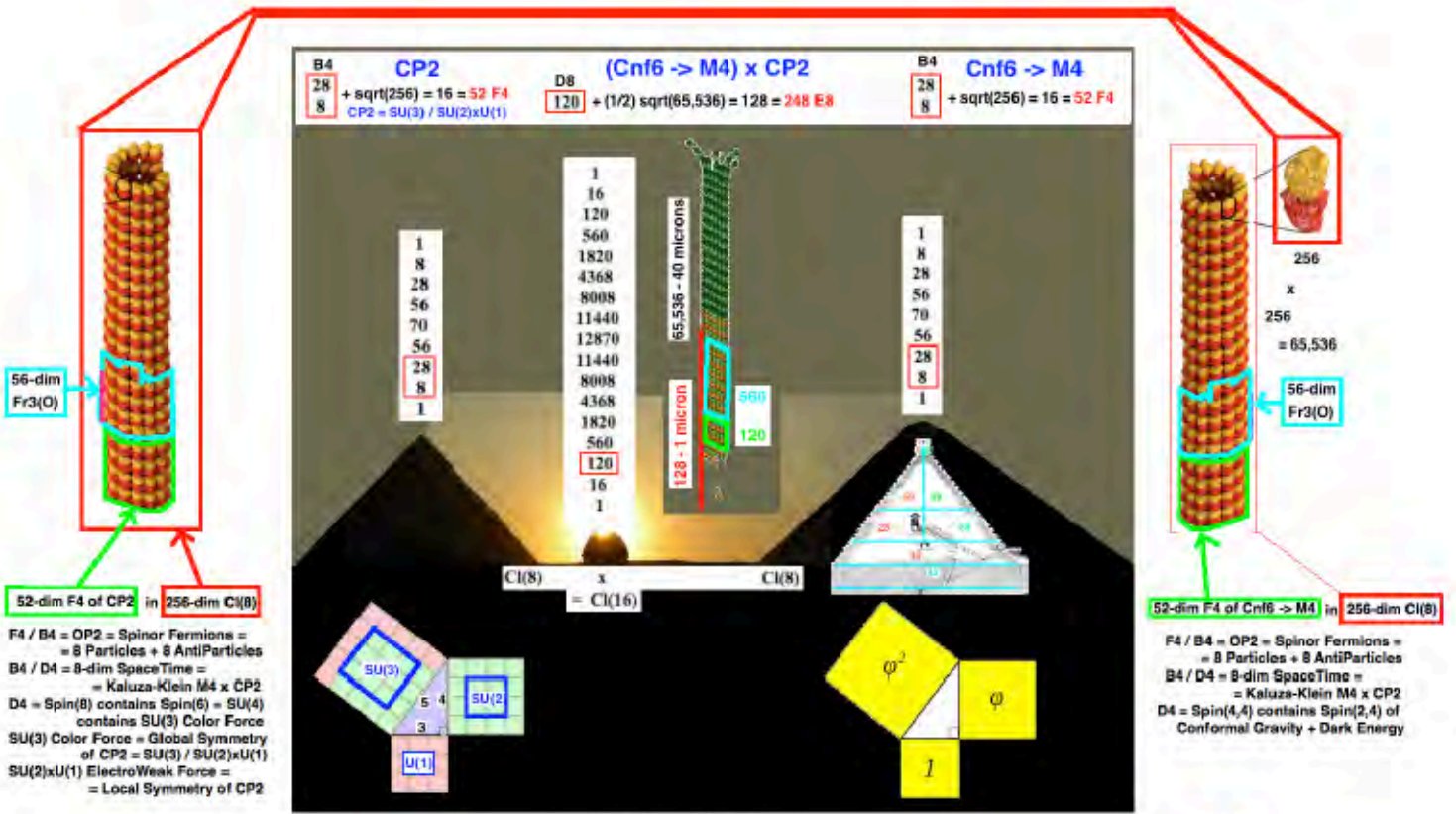

E8 Kaluza-Klein (Cnf6 -> M4) x CP2
 In (Cl(8) of CP2) x (Cl(8) of Cnf6 -> M4) = Cl(16) containing E8
 at each of the 256 points of Cl(8) of Cnf6 -> M4 there are all 256 points of Cl(8) of CP2
D8 = Cl(16) BiVectors = 120
E8 / D8 = 128-dim Fermion Spinor Space = 8 components of 8+8 Fermions
D8 / D4 x D4 = A7+1 = 64 = 8-dim position x 8-dim momentum
D4 containing D3 = Spin(2,4) = A3 = SU(2,2) for Conformal Gravity + Dark Energy
D4 containing D3 = SU(4) containing Color Force SU(3)
10xFr3(O) = Cl(16) TriVectors = 560

Paternal Line and Cousins with Alexander the Great

22,000 BP - M35 leaves M96 and Africa to cross Mediterranean
from the Nile Delta into the Middle East and Kosovo / Macedonia
Manetho's Rule by Demigods and Spirits of the Dead (22,000 to 11,000 BP)
ended after Ice Age when sea levels rose requiring agri-tech for survival
Manetho's Rule of Mortal Humans began 11,000 BP
which was about 25-26,000 years after the Geringa shock wave
11,000 BP also had a supernova (Vela X) and the Sphinx was built.



8,000 BP - During Manetho's Rule of Mortal Humans (11,000 BP through now)
330 BC - Cousins of my Paternal Y-DNA Line - Alexander the Great army goes East to
India and South to Great Pyramid / Alexandria and then returns to Kosovo / Macedonia.

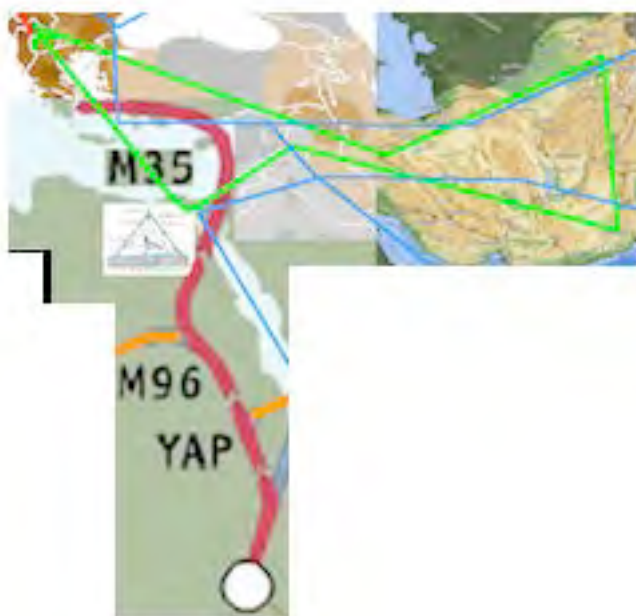

Paternal Line Roman Legions, Radhanite Cousins, and End of Line

100 BC - Gaius Marius formed Roman Legions using Kosovars / Macedonians.
130 AD - Roman Legions controlled Danube / Rhine / Britain (up to Hadrian's Wall).

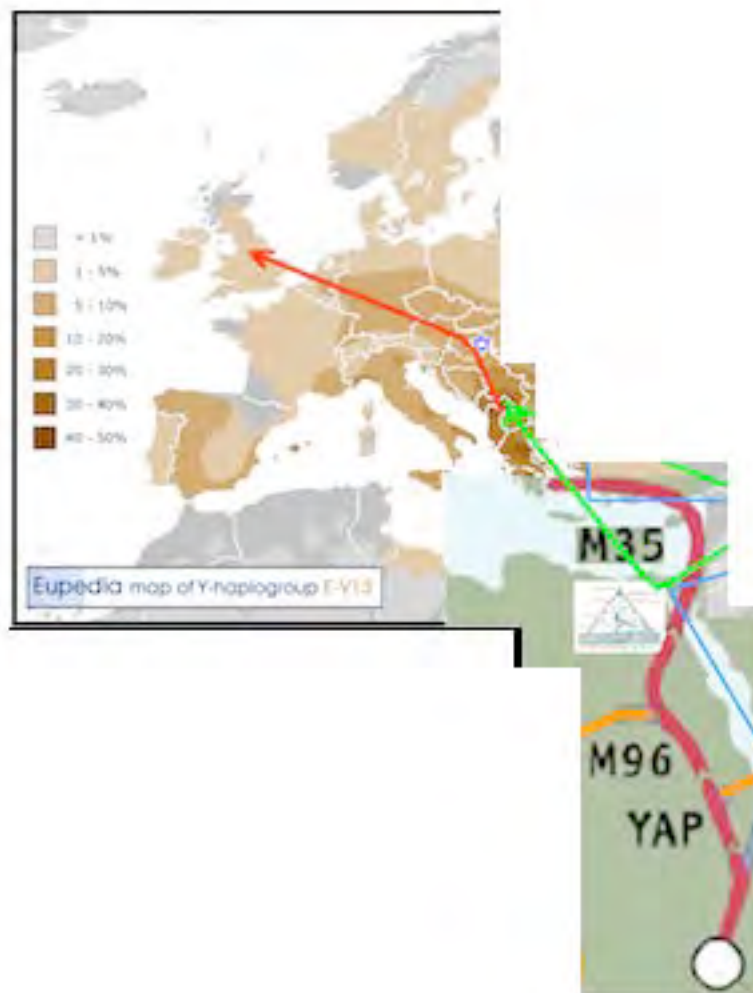

Cousins of my Paternal Y-DNA Line E-V13 that had evolved from M35:
 300 AD - Hungarian Ashkenazim founded
 500 AD - Ashkenazim in Hungary set up Radhanite Europe / Tang China trade



1000 AD - Tang Dynasty ended and Venice, Genoa, etc. succeeded Radhanites
 1000-2000 AD - my European and African Ancestors came to America

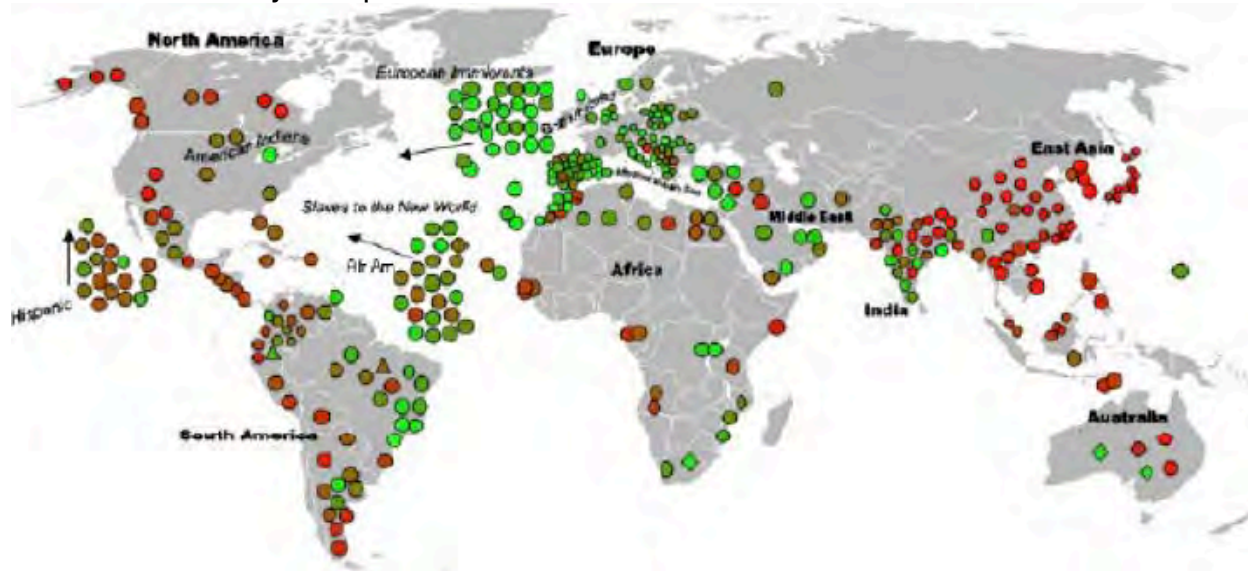

(my Michigan Native American Ancestors were already in America)

2017 AD - I Frank Dodd (Tony) Smith, Jr., am 76 years old, having been conceived on Shavuot, 6-7 Sivan, 5700 (12-13 June 1940) (year of Metal and Dragon) in the Braban Hotel in Cartersville, Georgia, USA,

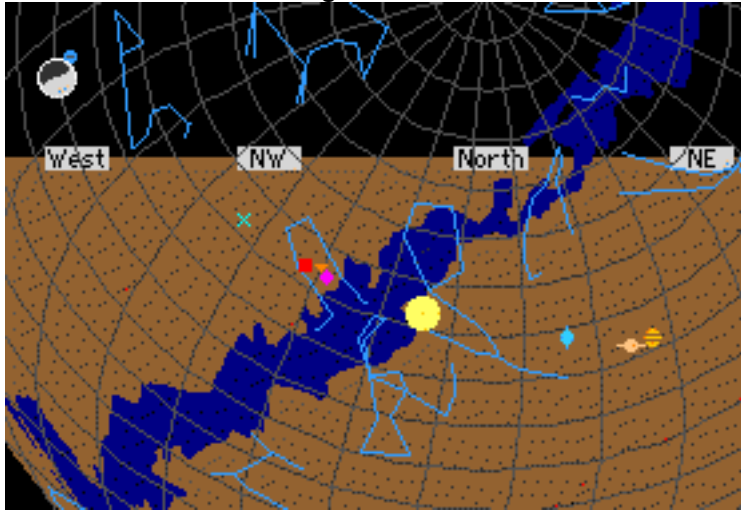

and born on Purim, 14 Adar, 5701 (13 March 1941) (year of Metal and Snake) in Cartersville, Georgia, USA, at about 1 AM Eastern Standard Time

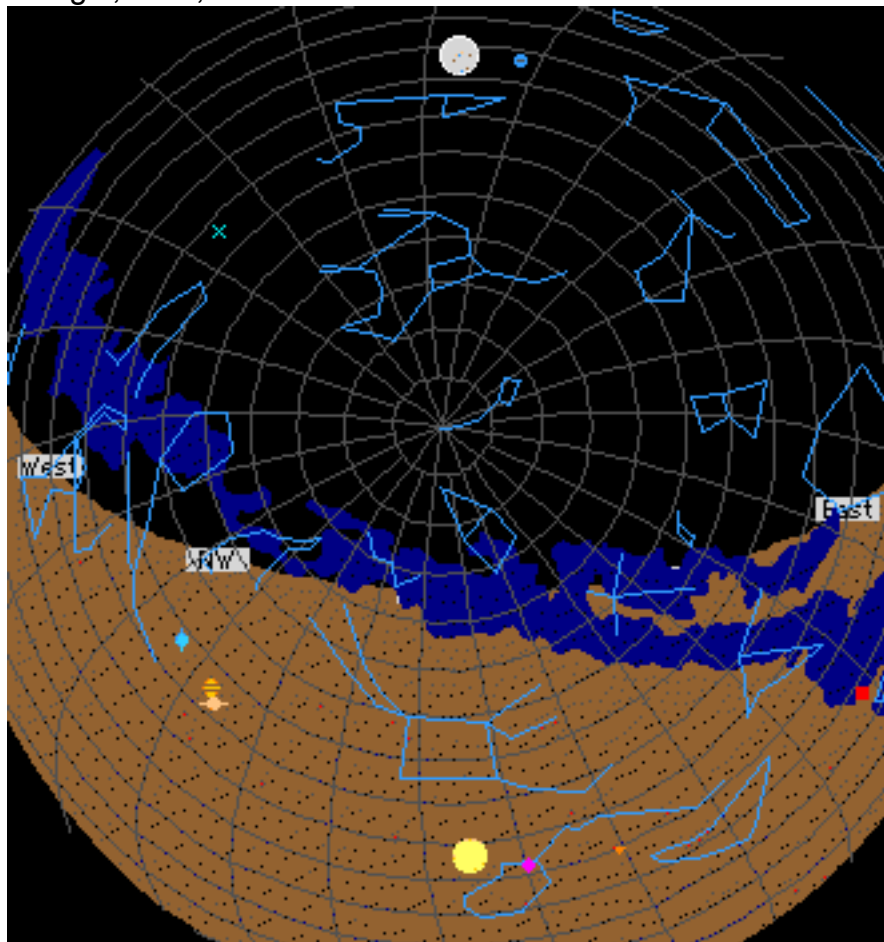

Since I have no issue,
 my Paternal Y-DNA Line (and all my other Lines) ends with me
 Frank Dodd (Tony) Smith, Jr. - AB Princeton 1963



Silver + Palladium

Ag = currency

Pd = Cold Fusion of $D+D+D+D \rightarrow He + He + 48 \text{ MeV}$

Tiger Eye = Quartz SiO_2 intergrown with

Goethite $Fe_2O_3 \cdot H_2O$ = needle iron ore with Ferric Fe^{3+} Iron(III)
 hydrated with nH_2O = Limonite

Iron = Steel Industry

Limonite = H_2O neutron absorption + Iron charged-particle absorption = Mike Shield



Operation Ivy
 H-bomb Mike 82 tons 1 November 1952



ADVANCED CALCULUS

by H. K. NICKERSON, D. C. SPENCER AND N. E. STEENROD
 the honors course in Advanced Calculus ... Princeton University

TABLE OF CONTENTS

- I. THE ALGEBRA OF VECTOR SPACES
- II. LINEAR TRANSFORMATIONS OF VECTOR SPACES - leads to Lie Groups and Symmetric Spaces
- III. THE SCALAR PRODUCT
- IV. VECTOR PRODUCTS IN R^3 - leads to Vector Products in R^7
- V. ENDOMORPHISMS
- VI. VECTOR-VALUED FUNCTIONS OF A SCALAR
- VII. SCALAR-VALUED FUNCTIONS OF A VECTOR
- VIII. VECTOR-VALUED FUNCTIONS OF A VECTOR
- IX. TENSOR PRODUCTS AND THE STANDARD ALGEBRAS - leads to Clifford Algebras and Spinors
- X. TOPOLOGY AND ANALYSIS
- XI. DIFFERENTIAL CALCULUS OF FORMS
- XII. INTEGRAL CALCULUS OF FORMS
- XIII. COMPLEX STRUCTURE - leads to Potential Theory, Green's Functions, Bergman Kernels, Bounded Domains, and Schwinger Sources

This text has the basic background for my E8 Cl(16) Physics - viXra 1602.0319

Cold Fusion - Deuterium in 147-atom Pd nanoclusters embedded in Zeolite Cages

Frank Dodd (Tony) Smith, Jr. - 2016 - viXra 1603.0098

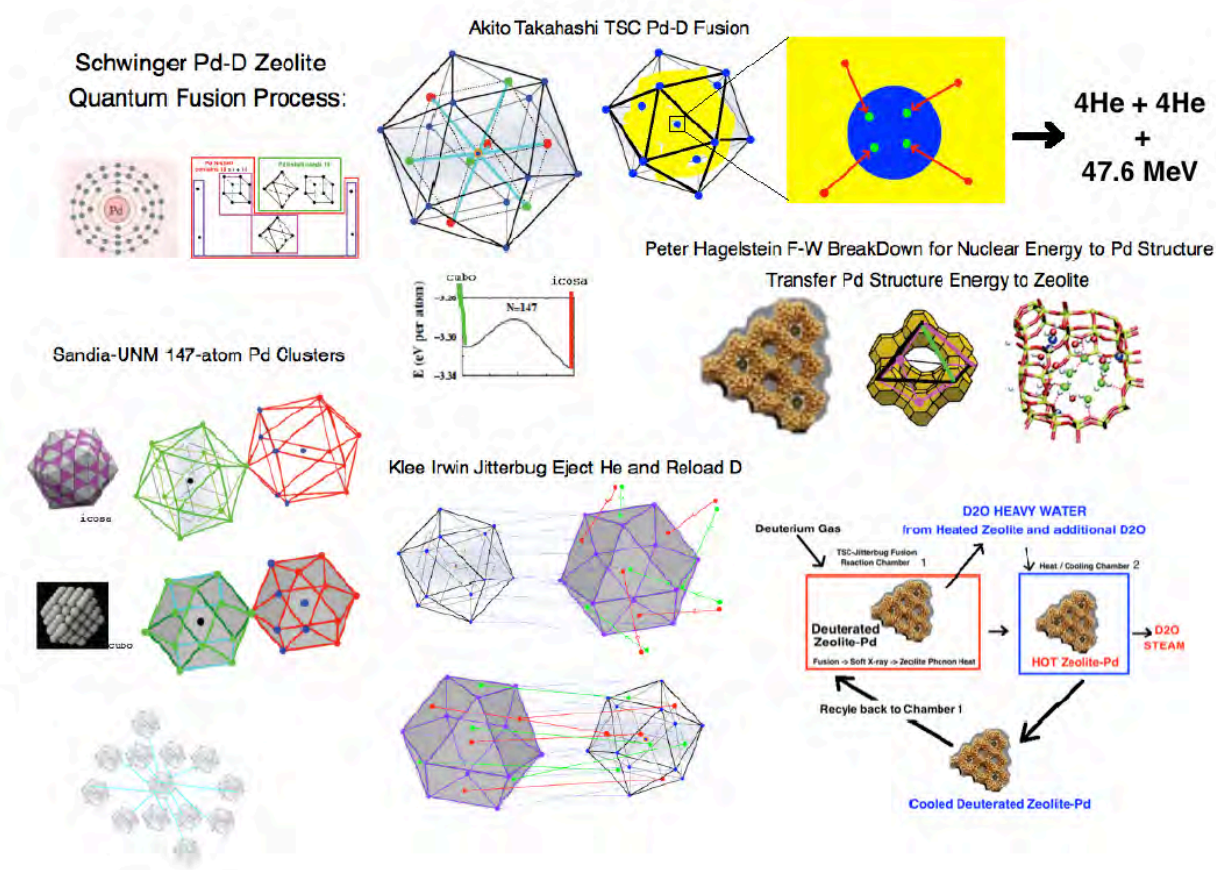

Abstract:

147-atom Palladium clusters embedded in Zeolite cavities enable Cold Fusion when exposed to Deuterium gas by Klein Paradox Tunnelling of $D+D+D+D$ producing $He + He + 47.6$ MeV. Cold Fusion Energy goes to Optical Mode Phonons in the Pd clusters and then to the Zeolite where it is stored as Heat that is released by D_2O Heavy Water to produce useful energy. Ejection of $He + He$ and reloading of $D+D+D+D$ is done by Jitterbug transformation between Icosahedral Ground State and Cuboctahedral Metastable State of 147-atom Pd clusters. Synthesis of 147-atom Pd clusters has been done by Burton, Boyle, and Datye at Sandia / U. New Mexico, USA. Zeolite synthesis has been discussed by Sharma, Jeong, Han and Cho at Chungnam Nat. Un., Korea. Based on prior experimental results of Arata and Zhang (replicated by McKubre at SRI) and of Parchamazad the expected energy production is on the order of kilowatts per milligram of Palladium.

Table of Contents:

How does Pd-D Cold Fusion Work ? ...	page 3
Why is Palladium uniquely useful for Deuterium Cold Fusion ? ...	page 4
What is the structure of the icosahedral 147-atom Pd cluster ? ...	page 7
In TSC Icosahedra of a Pd cluster 4 D form a Schwinger Coherent State ...	page 10
Schwinger State D nuclei go to the central Pd atom and by Klein Paradox Tunnelling 4 D nuclei undergo TSC Cold Fusion producing He + He + 47.6 MeV ...	page 11
47.6 MeV TSC Cold Fusion energy goes to Pd cluster Optical Phonons ...	page 12
Reloading D with Pd cluster Jitterbug from Icosahedron to Cuboctahedron ...	page 15
How much energy does TSC Cold Fusion produce ? ...	page 20
Zeolite Structure ...	page 21
Transfer of Energy from Pd Cluster Structure to Zeolite Structure ...	page 26
Extraction of Cold Fusion Energy from Zeolite Structure ...	page 27
Synthesis of 147-atom Pd clusters and Embedding into Zeolite ...	page 32
Global Energy and TSC-Jitterbug-Zeolite Fusion machines ...	page 34
Appendix A: Details of Structure of 147-atom Pd clusters ...	page 37
Appendix B: Graphene and Klein Paradox Quantum Tunnelling ...	page 44

How does Pd-D Cold Fusion Work ?

Julian Schwinger in 1990 lecture at Universite de Bourgogne said:

“... in the very low energy cold fusion, one deals essentially with a single state, described by a single wave function, all parts of which are coherent ...”.

Akito Takahashi proposed a process Tetrahedral Symmetric Condensation (TSC) that for 4 Deuterons (D) in an icosahedral cluster of Palladium (Pd) atoms produces a Schwinger coherent quantum state

that effectively distributes the electron population among deuterons so that the Coulomb barrier is eliminated and the four Deuterium (D) nuclei can simultaneously interact and fuse, forming two 4He nuclei plus 47.6 MeV energy.

Peter Hagelstein used phonon models for Relativistic Coupling Between Lattice Vibrations and Nuclear Excitation, enabled by break-down of Foldy-Wouthuysen transformation due to 8-15 THz Lattice Vibration Modes, to show direct transfer of the 47.6 MeV energy of Cold Fusion to the Pd lattice as excited optical phonon modes.

The only Cold Fusion experiments producing heat consistently and reproducibly are the detections of heat using Pd Clusters and Deuterium gas

by Arata and Zhang (replicated by McKubre at SRI) and by Iraj Parchamazad.

Arata and Zhang (and SRI) used Palladium black with initial cluster sizes distributed around 5 nm so that a substantial number of Pd clusters had diameter 1.5 nm.

However, clumping increased the cluster size to around 40 nm at which size Takahashi et al said, based on their similar work, the “heat-power level drop[ped]... drastically”.

(see Current Science 108 (25 Feb 2015) LENR Special Section Preface)

Iraj Parchamazad and Melvin Miles avoided the clumping problem by growing the Pd clusters within Zeolite cavities. Using Sodium Zeolite Y whose cavity size is around 1.2 nm (but capable of expansion by about a factor of 2), they produced Pd clusters of 1.5 nm size size which were dispersed within the Zeolite cavities thus preventing clumping. Upon exposure of his Pd clusters in Zeolite to Deuterium gas, he produced heat in 10 out of 10 experiments with

Cold Fusion Energy on the scale of kiloWatts per milligram of Palladium.

(see coldfusionnow.org/iraj-parchamazad-lenr-with-zeolites/)

1.5 nm diameter Pd clusters have 147 atoms and can be in two states: an Cuboctahedral Metastable State and an Icosahedral Ground State

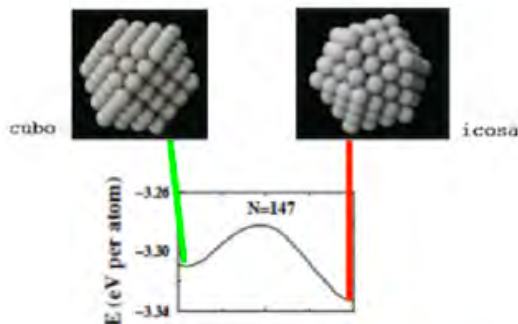

that can transform into each other by a Fuller Jitterbug Transformation.

Why is Palladium uniquely useful for Deuterium Cold Fusion ?

Pd has uniquely closed electron shell structure.

Wikipedia says (I added red material specifically about Pd): “...

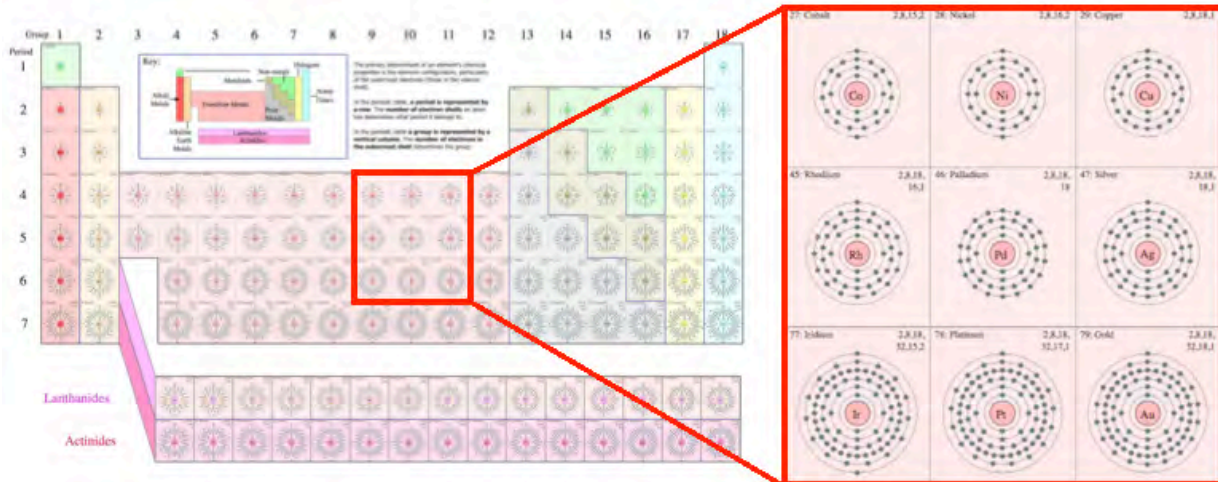

... Each s subshell holds at most 2 electrons
 Each p subshell holds at most 6 electrons
 Each d subshell holds at most 10 electrons
 Each f subshell holds at most 14 electrons
 Each g subshell holds at most 18 electrons ...

Shell name	Subshell name	Subshell max electrons	Shell max electrons
K	1s	2	2
	2s	2	
L	2p	6	2 + 6 = 8
	3s	2	
M	3p	6	2 + 6 + 10 = 18
	3d	10	
N	4s	2	2 + 6 + 10 + 14 = 32
	4p	6	
	4d	10	
	4f	14	

Palladium

$$2$$

$$2+6 = 8$$

$$2+6+10 = 18$$

$$2+6+10 = 18$$



... palladium (atomic number 46) has no electrons in the fifth shell, unlike other atoms ...[in its periodic table neighborhood]...”

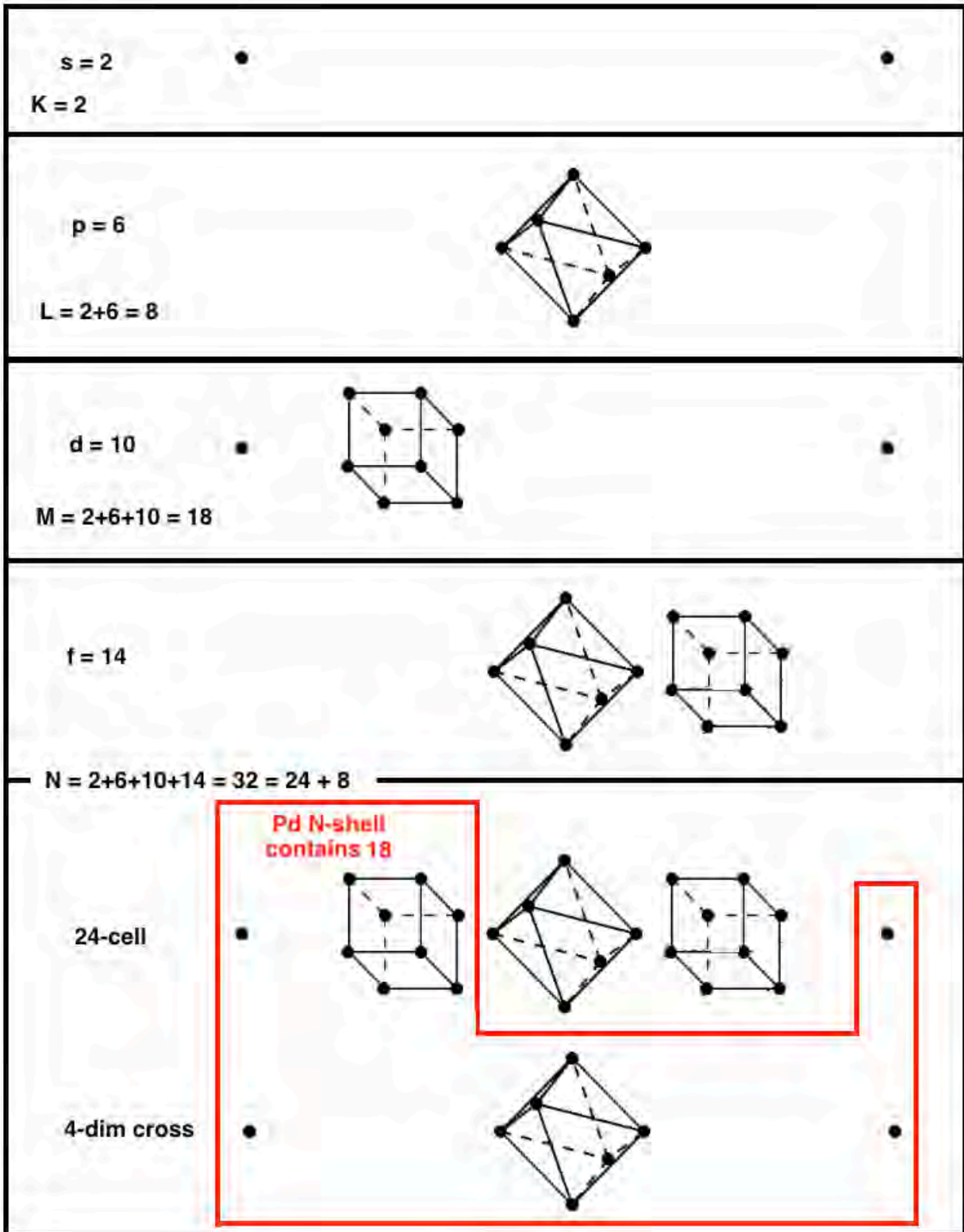

(24-cell image from John Baez review of "On Quaternions and Octonions" by Conway and Smith)

Geometrically:

2 of the First Shell correspond to the Root Vectors of $B_1 = \text{Spin}(3)$

8 of the Second Shell correspond to the Root Vectors of $B_2 = \text{Spin}(5)$

18 of the Third Shell correspond to the Root Vectors of $B_3 = \text{Spin}(7)$

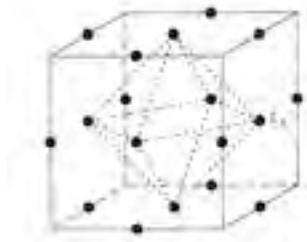

(image from Representation Theory by Fulton and Harris)

The B_3 Root Vectors live in 3-dim space, which is where Element Electron Shells live.

32 of the Fourth Shell correspond to the Root Vectors of $B_4 = \text{Spin}(9)$

Palladium is the only element whose outer shell has more electrons than the 8 electrons of noble gases beyond Helium.

The 18 electrons in the outer shell of Palladium replicate the full state of the Third Shell (M shell).

What is the structure of the icosahedral 147-atom Pd cluster ?

The icosahedral 147-atom ground state has 12 exterior icosahedra and a central icosahedron with 12 interior vertices which are the innermost vertices of 12 exterior TSC Fusion site icosahedra:

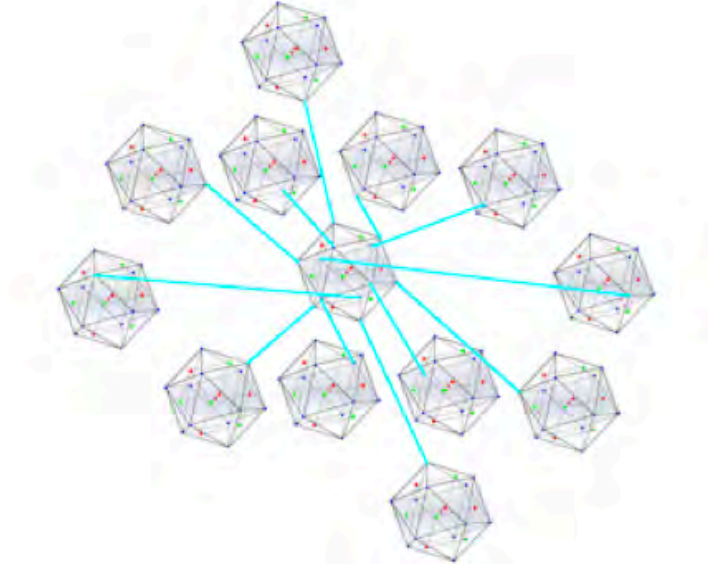

The 12 exterior icosahedra each have outer faces on the outer boundary of the 147-atom cluster.

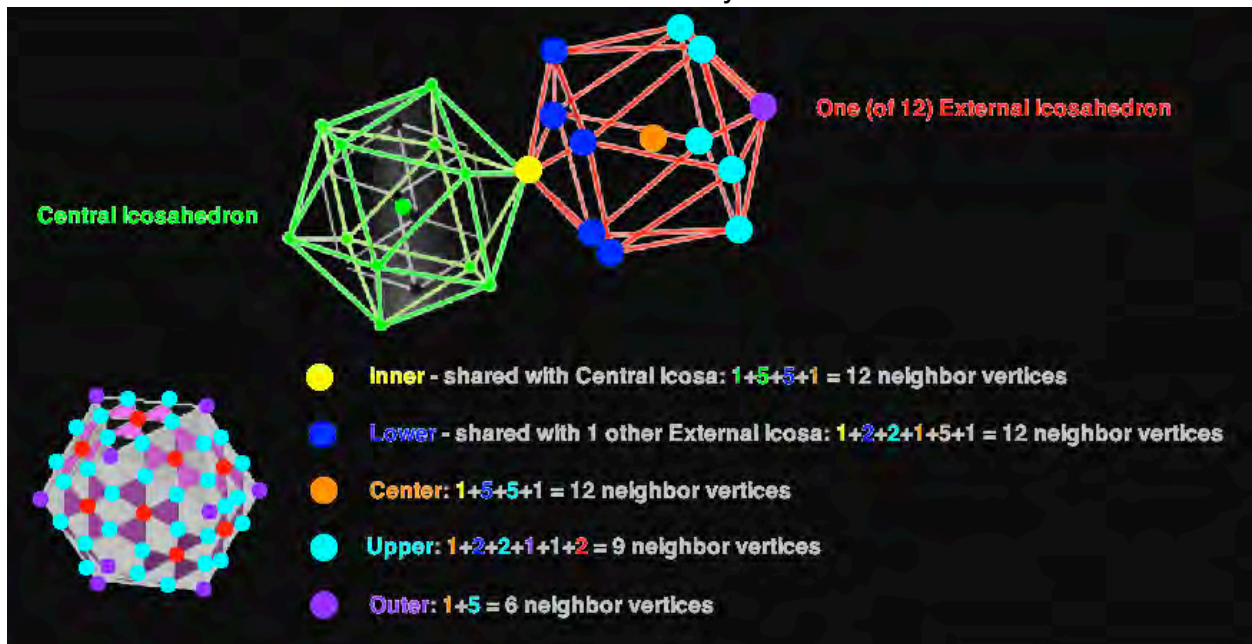

$$147 = 1+12+30+12+72+20:$$

1 atom is at the cluster center

12 atoms surround the cluster center

$5 \times 12 / 2 = 30$ atoms are in the next layer out

12 atoms are at centers of exterior icosahedra

$12 \times 6 = 72$ atoms are on outer surface of exterior icosahedra

20 atoms are on outer surface between exterior icosahedra

The 20 Exterior-Face-Center Pd atoms each have $3+6 = 9$ neighbors.

Each of the 12 exterior icosahedra of the 147-atom cluster has 13 Pd atoms:

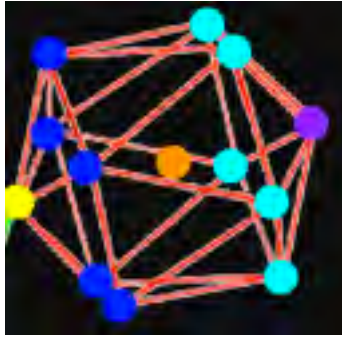

How do the Palladium atoms in a cluster interact with each other ?

The interaction is primarily through the outer shell of electrons (N-shell for Palladium).

A full N-shell has $s + p + d + f = 2 + 6 + 10 + 14 = 32$ electrons.

Palladium N-shell has $2 + 6 + 10 = 18$ electrons and “holes” to receive 14 electrons:

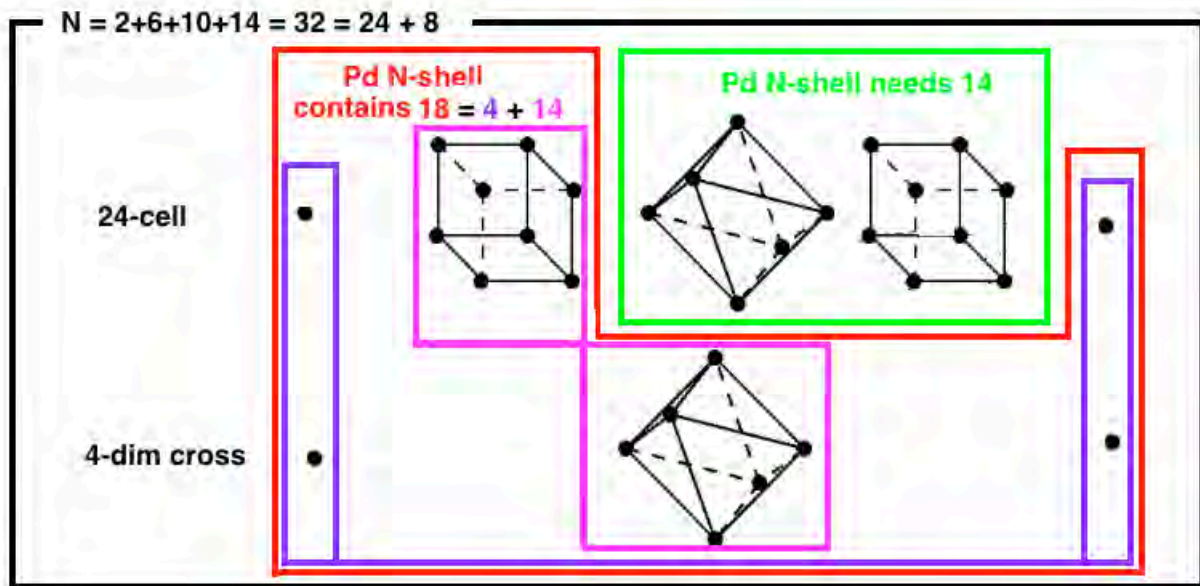

Each Palladium atom has $18-14 = 4$ N-shell electrons that can interact with 4 electrons of 4 Deuterium atoms absorbed into a Pd cluster, helping them to participate in a Schwinger coherent quantum state for TSC Fusion.

Further, each Palladium atom has 14 N-shell electrons 12 to fill needs of other Pd atoms and 2 for a Dirac Fermion Band for Klein Paradox Tunnelling.

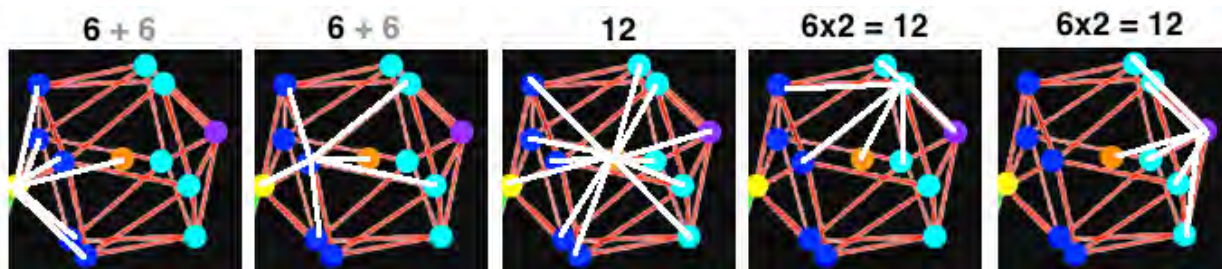

6x2 = 12: For the **1** exterior vertex Pd with 6 neighbors, all 6 of which are in the icosahedron, 12 electrons go 2 to each icosahedron neighbor and $14-12 = 2$ electrons go to a Dirac Fermion Band for Klein Paradox Tunnelling. It receives 12 electrons, 2 from each of its **1**+5 = 6 icosahedron neighbors leaving 2 holes related to Dirac Fermion Band for Klein Paradox Tunnelling.

6x2 = 12: For each of the **5** exterior surface Pd with 9 neighbors, **2**+**1**+**2**+**1** = 6 of which are in the icosahedron, 12 electrons go 2 to each icosahedron neighbor and $14-12 = 2$ electrons go to a Dirac Fermion Band for Klein Paradox Tunnelling. It receives 12 electrons, 2 from each of its **2**+**1**+**2**+**1** = 6 icosahedron neighbors leaving 2 holes related to Dirac Fermion Band for Klein Paradox Tunnelling.

12: For the **1** central Pd with 12 neighbors, all 12 of which are in the icosahedron, 12 electrons go 1 to each icosahedron neighbor and $14-12 = 2$ electrons go to a Dirac Fermion Band for Klein Paradox Tunnelling. It receives 12 electrons, one from each of its **1**+**5**+**5**+**1** = 12 icosahedron neighbors leaving 2 holes related to Dirac Fermion Band for Klein Paradox Tunnelling.

6 + 6: For each of the **5** interior Pd shared with 1 other icosahedron and with 12 neighbors, **1**+**2**+**1**+**2** = 6 of which are in the icosahedron, 6 electrons go 1 to each icosahedron neighbor and $14-6 = 8$ electrons go 2 to a Dirac Fermion Band for Klein Paradox Tunnelling and 6 to the other icosahedron. It receives $6+6 = 12$ electrons, 1 from each of its **1**+5 = 6 icosahedron neighbors and 6 from the other icosahedron, leaving 2 holes related to Dirac Fermion Band for Klein Paradox Tunnelling.

6 + 6: For the **1** interior Pd shared with the central icosahedron and with 12 neighbors, **5**+**1** = 6 of which are in the icosahedron, 6 electrons go 1 to each icosahedron neighbor and $14-6 = 8$ electrons go 2 to a Dirac Fermion Band for Klein Paradox Tunnelling and 6 to the central icosahedron. It receives $6+6 = 12$ electrons, 1 from each of its **5**+**1** = 6 icosahedron neighbors and 6 from the central icosahedron, leaving 2 holes related to Dirac Fermion Band for Klein Paradox Tunnelling.

All 13 Pd atoms in the icosahedron have $18-14 = 4$ electrons for TSC condensation guidance.

In TSC Icosahedra of a Pd cluster 4 D (D+D+D+D) form a Schwinger Coherent Quantum State

From a classical approximation point of view there are $12+1 = 13$ Pd nuclei (blue) within which there is a 2-tetrahedral configuration of 4 D nuclei (red) and 4 D electrons (green)

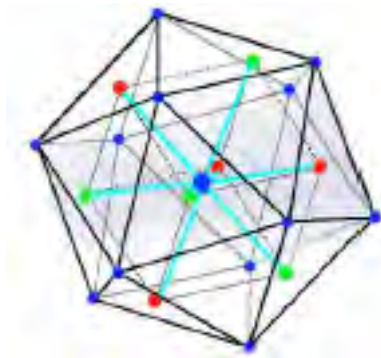

In the Schwinger coherent quantum state (yellow) the 4 D nuclei and 4 D electrons are smeared out all over the interior of the icosahedral TSC cell

and

the 4 D electrons screen out the positive charge of the 4 D nuclei making the Schwinger coherent quantum cloud effectively neutral with no Coulomb repulsion or attraction.

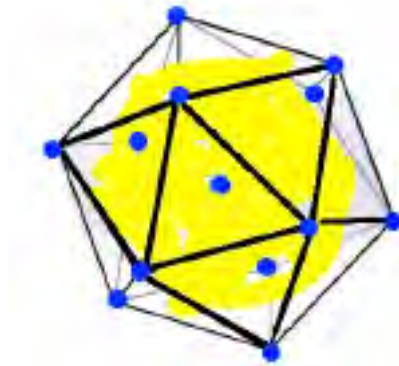

**The process of forming the Schwinger State which collapses to the central Pd atom
where Deuterium nuclei undergo Cold Fusion is called by Akito Takahashi
Tetrahedral Symmetric Condensation (TSC).**

**The D Schwinger State nuclei go to the central Pd atom
and by Klein Paradox Tunnelling 4 D nuclei undergo TSC Cold Fusion
producing 4He + 4He + 47.6 MeV**

Now look at the central Pd atom in the TSC cell.

Its outer electron shell of 18 electrons has 4 free electrons

(14 of them being bound to the outer 12 Pd atoms plus 2 forming a Dirac Fermion Band)

which 4 free electrons pull the 4 D nuclei out of the Schwinger quantum cloud
into the Central Pd Atom

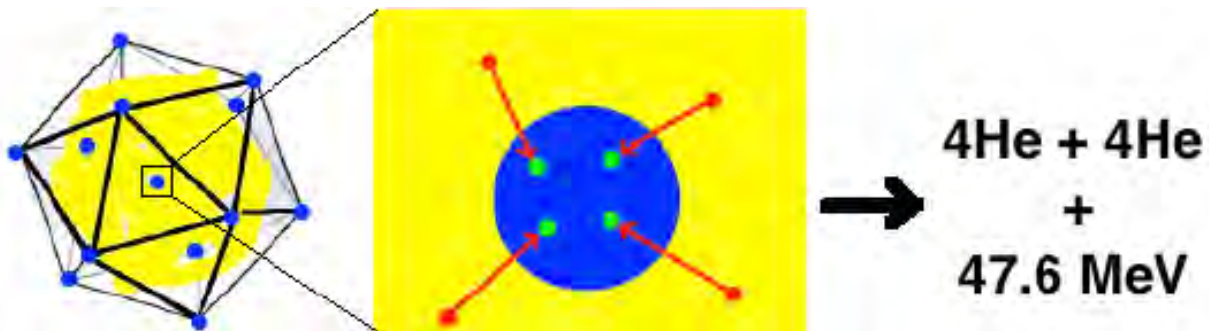

When the 4 D nuclei get into the small volume of the Central Pd Atom
they “see” each other as repulsive like electrical charges
resulting in a very high Coulomb barrier between them

but

that is when the Dirac Fermion Band takes effect
and gets them to rapidly penetrate the barrier by Klein Paradox Tunnelling

(see Appendix for deescription of Klein Paradox Tunnelling)

and

then all 4 Deuterium nuclei undergo TSC Fusion to produce energy + 2 Helium nuclei
which then pick up the left-over 4 Deuterium electrons to form 2 Helium atoms.

Takahashi said, about his TSC process $4D \rightarrow 8Be^* \rightarrow 4He + 4He + 47.6 \text{ MeV}$:

“... Immediately at ... $8Be^*$ formation ...

4d-cluster shrinks to much smaller size (about 2.4 fm radius) of $8Be^*$ nucleus,
and four electrons should go outside due to the Pauli's repulsion for fermions.

Shortly in about few fs or less (note; Lifetime of $8Be$ at ground state is 0.67 fs),

$8Be^*$ will break up into two $4He$ particles”

plus energy release of 47.6 MeV.

47.6 MeV TSC Cold Fusion energy goes to Pd cluster Optical Phonons

Hagelstein and Chaudhary in ICCF 18 (Missouri 2013) Poster:

Relativistic Coupling Between Lattice Vibrations and Nuclear Excitation said:

“... for relativistic dynamics ... the fundamental theory includes a very strong coupling between the center of mass momentum operator, and internal nuclear transitions.

This coupling is connected to changes in the internal structure of a composite when it moves (as a result of the Lorentz transform), compared to the rest frame wavefunction.

Under normal conditions a generalized Foldy-Wouthuysen transformation eliminates this strong coupling, which results in a model in the rotated frame with no residual first-order interaction. As a result, one would expect generally not expect any significant coupling to survive.

The conditions under which any residual coupling would be expected are the same conditions where the generalized Foldy-Wouthuysen rotation "breaks down" ...

in that it becomes very difficult to deal with the loss operator in the rotated picture.

Under conditions where the Foldy-Wouthuysen transformation "breaks down" in this sense due to the presence of a strong Brillouin-Wigner loss operator,

there exists no useful general nonrelativistic limit. In this case,

the strong coupling between the center of mass momentum and internal nuclear states remains, and can be used for coherent dynamical processes. ...”.

Wikipedia says: “... **Optical phonons** are out-of-phase movements of the atoms in the lattice, one atom moving to the left, and its neighbour to the right. This occurs if the lattice basis consists of two or more atoms. They are called *optical* because in ionic crystals, like sodium chloride, they are excited by infrared radiation. The electric field of the light will move every positive sodium ion in the direction of the field, and every negative chloride ion in the other direction, sending the crystal vibrating. Optical phonons have a non-zero frequency at the Brillouin zone center and show no dispersion near that long wavelength limit. This is because they correspond to a mode of vibration where positive and negative ions at adjacent lattice sites swing against each other, creating a time-varying electrical dipole moment. Optical phonons that interact in this way with light are called *infrared active*. Optical phonons that are *Raman active* can also interact indirectly with light, through Raman scattering. Optical phonons are often abbreviated as LO and TO phonons, for the longitudinal and transverse modes respectively; the splitting between LO and TO frequencies is often described accurately by the Lyddane-Sachs-Teller relation.

When measuring optical phonon energy by experiment, optical phonon frequencies are sometimes given in spectroscopic wavenumber notation, where the symbol ω represents ordinary frequency (not angular frequency), and is expressed in units of cm^{-1} . The value is obtained by dividing the frequency by the speed of light in vacuum. In other words, the frequency in cm^{-1} units corresponds to the inverse of the wavelength of a photon in vacuum, that has the same frequency as the measured phonon. The cm^{-1} is a unit of energy used frequently in the dispersion relations of both acoustic and optical phonons ...”.

Hagelstein and Chaudhary in Current Science 108 (25 Feb 2015): Low Energy Nuclear Reactions : Phonon Models for Anomalies in Condensed Matter Nuclear Science said: “... a... new physics model which addresses the fractionation of a large quantum; and a new fundamental Hamiltonian which describes the coupling between vibrations and internal nuclear degrees of freedom ...

the nuclear energy quantum is fractionated into much smaller quanta, which can go into vibrational modes.

For this to work in the model, the vibrational modes first need to be highly excited

...

deuterons are responsible in fractionating the nuclear quanta in operation with excited optical phonon modes, and the deuterons can accomplish this cleanly. However, THz acoustic mode excitation would also be expected to produce fractionation with participation of the host Pd nuclei, which do not fractionate cleanly (leading to disintegration of the Pd nuclei) ...

there is a strong coupling between the vibrational degree of freedom and internal nuclear degrees of freedom implicit in a relativistic model, but this coupling is normally eliminated by a generalized Foldy–Wouthuysen transformation ...

The fundamental relativistic Hamiltonian under discussion is

$$\hat{H} = \sum_j (Mc^2 + \mathbf{a} \cdot c\hat{\mathbf{P}})_j + \sum_k \frac{|\hat{\mathbf{p}}_k|^2}{2m} + \sum_{j < j'} \frac{Z_j Z_{j'} e^2}{4\pi\epsilon_0 |\mathbf{R}_j - \mathbf{R}_{j'}|} + \sum_{k < k'} \frac{e^2}{4\pi\epsilon_0 |r_k - r_{k'}|} - \sum_{j,k} \frac{Z_j e^2}{4\pi\epsilon_0 |\mathbf{R}_j - \mathbf{r}_k|} \quad (5)$$

If we use a Born–Oppenheimer approximation, then the lattice nuclear problem that remains is

$$\hat{H} = \sum_j (Mc^2 + \mathbf{a} \cdot c\hat{\mathbf{P}})_j + \sum_{j < k} V(\mathbf{R}_j - \mathbf{R}_k) - \frac{i\hbar \hat{\mathbf{M}}(E)}{\hbar}, \quad (6)$$

where we have augmented the normal Born–Oppenheimer model with a loss term due to coupling with the electrons.

... we have in this a starting place to analyse coherent energy exchange between nuclei and vibrations under conditions of fractionation ...

phonon - nuclear coupling matrix element... in the case of the D2 / 4He transition ... is consistent in magnitude with what is needed to account for the rate at which excess heat is observed in experiments

...

Fractionation is easier when fewer oscillator quanta are involved, so we would expect the highest frequency vibrational modes to be involved (THz frequency vibrations).

There is only a weak coupling between vibrations and the D2 / 4He transition ...

the D2 / 4He transition occurs with a single phonon exchange with the large nuclear energy quantum transferred to other more strongly coupled transitions and subdivided (many nuclear excitations for a single D2 / 4He de-excitation),

and subsequently fractionated to optical phonons ...excess heat is basically ‘silent’ (in that there is nothing energetic emitted in the primary reaction) ...

The rate of fractionation without subdivision then has to match the energy release rate.

For example, if the system produces excess heat at the 1 W level,

then there are 2.6×10^{11} reactions/sec and it must take 3.8×10^{-12} sec for each of

the large 24 MeV quanta to be fractionated. If the optical phonon mode has an energy of 36 MeV, then the average time associated for the net transfer of a single phonon in connection with fractionation must be 5.7×10^{-21} sec. These numbers are consistent with the models we have studied over the years

...

If the nuclear system is treated relativistically, there is a very strong coupling present between the vibrational and internal nuclear degrees of freedom ...

there exists a unitary transformation that eliminates this very strong first-order coupling. Under conditions where this unitary transformation is useful, the vibrational and nuclear degrees of freedom are nearly independent ...

when the ... destructive interference ...[of]... the unitary transformation which eliminates the strong first-order coupling ... is spoiled ... there will be a[n]... enhanced rate for coherent energy exchange under conditions of fractionation ...

a highly excited vibrational mode ... remove[s]... the destructive interference ...”.

Letts in Current Science 108 (25 Feb 2015): Low Energy Nuclear Reactions : Dual Laser Stimulation says: “... PdD lattice vibrations might occur around 8 and 15 THz ...”.

8 - 15 THz Pd-D Fusion Frequency is interestingly coincident with:

Critical Temperature of BSCCO superconducting crystals

Beck - Mackey Dark Energy Josephson Junction Frequency

Energy of Neutrino Masses

Reloading D with Pd cluster Jitterbug from Icosahedron to Cuboctahedron

Icosahedra and Cuboctahedra both have 12 vertices so that it is possible to transform them into each other. Buckminster Fuller called that transformation the Jitterbug

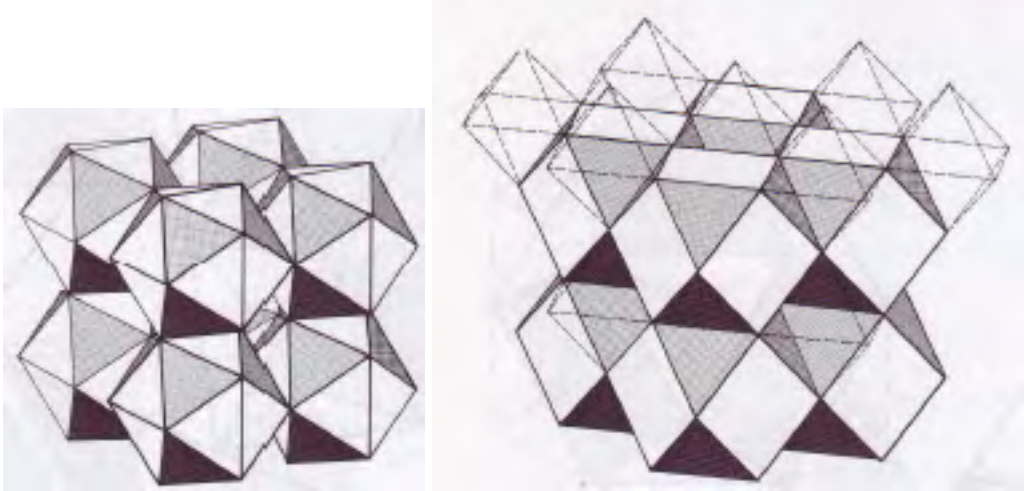

(images from Synergetics by Buckminster Fuller (Macmillan 1975, 1982))

To make Cuboctahedra (unit edge length) from Icosahedra (unit edge length) choose 6 pairs of Icosahedra triangle faces (white in the above images) and lengthen the common edge of each pair by a factor of $\sqrt{2}$. That expansion flattens each of the triangle pairs to produce 6 square faces of the Cuboctahedron. The other Icosahedral $20 - 2 \times 6 = 8$ (shaded) triangle faces are rotated and become the other $14 - 6 = 8$ triangle faces of the Cuboctahedron. thus decreasing the number of faces from $20 = 8 + (6 + 6)$ to $8 + 6 = 14$ while keeping the number of vertices constant at 12.

The triangle faces of the Icosahedron/Cuboctahedron are rotated by a Golden Ratio



(images adapted from Geometrical Frustration by Sadoc and Mosseri (Cambridge 2006))
angle defined by sliding Icosahedron vertices on the edges of a circumscribing Octahedron from points dividing edges into Golden Ratio segments to points dividing edges into two equal segments so that the Octahedron then circumscribes a Cuboctahedron. If the edge lengths of the Icosahedron/Cuboctahedron are kept the

same then the Octahedron surrounding the Cuboctahedron will be an expansion of the Octahedron surrounding the Icosahedron.

Just as in the choice of a Cuboctahedron square diagonal to be compressed, there are two ways in which the edge could be divided into Golden Ratio segments, corresponding to the two possible orientations of an Icosahedron. Choice of Golden Ratio segments for one edge forces (by requiring consistency) the choices for all other edges.

The time scale of such a Jitterbug Transformation of a Pd cluster may be on the order of a picosecond (compare Euro. Phys. J. D. 19 (2002) 333-337 by Pundt et al).

The volume expansion of the Jitterbug Transformation from Icosahedron (unit edge) to Cuboctahedron (unit edge) is:

$$\text{Icosahedron volume} = (5/12) (3 + \text{sqrt}(5)) = 2.18169499$$

$$\text{Cuboctahedron volume} = (5/3) \text{sqrt}(2) = 2.3570226$$

$$\text{Icosahedron/Cuboctahedron volume ratio} = 0.9256147947$$

$$\text{Cuboctahedron/Icosahedron volume ratio} = 1.0803630254$$

The cuboctahedral configuration resulting from Fusion Energy Jitterbug is not only larger than the Icosahedral configuration, it has 6 large square openings allowing easier entry into the Pd cluster of the Deuterium Nuclei (red dots) and Electrons (green dots) as well as easy exit of the Fused Deuterium $4\text{He} + 4\text{He}$ nuclei from the Pd cluster.

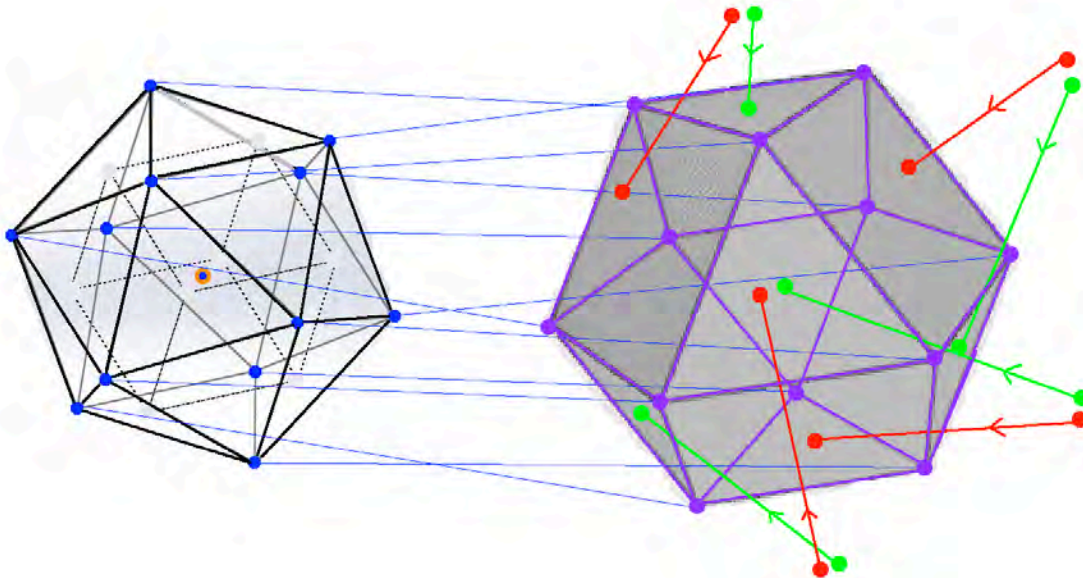

Also, the cuboctahedral configuration has 8 small triangle faces to which the 4 Nuclei and 4 Electrons of the Deuterium are attracted to form the Tetrahedral Symmetric Coherent Quantum State.

The size required for Jitterbug / TSC Fusion is a Palladium atomic cluster whose ground state is icosahedral and can easily Jitterbug Transform into a cuboctahedral state and whose size is large enough to contain several TSC Fusion Cluster sites, each of which is an icosahedron that can Jitterbug transform into a cuboctahedron.

The 13-atom Pd/Ni cluster (0.70 nm) is an icosahedron, for 1 TSC Fusion Cluster site.

The 2-shell 55-atom Pd/Ni cluster (1.13 nm) has two icosahedra that share a central vertex, for only TSC Fusion Cluster sites.

Clusters of between 56 and 147 atoms contain from 2 to 13 TSC Fusion Cluster sites by partially filling the 3rd shell of atoms.

The 3-shell 147-atom Pd/Ni cluster (1.56 nm) has 12 exterior TSC Fusion Cluster sites plus 1 central TSC Fusion Cluster sites, so it contains 13 TSC Fusion Cluster sites.

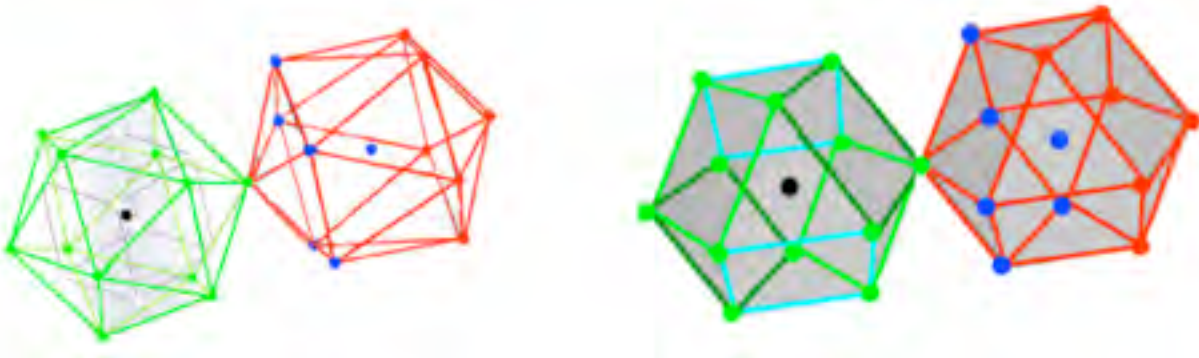

(see viXra 1502.0069)

Clusters of between 147 and 309 atoms contain at least 13 TSC Fusion Cluster sites. The 4-shell 309-atom Pd/Ni cluster is 2.00 nm in size, so it is disfavored with respect to the 3-shell 147-atom cluster for use with Sodium Zeolite Y whose pore size is 0.74 nm expandable to 1.5 nm.

Most of the TSC Fusion Energy is carried to the Pd Cluster Structure by the $4\text{He}+4\text{He}$ and the $4e$ electrons of the TSC coherent quantum state according to the Hagelstein Coupling between Nuclear Excitation and Atomic Structure.

The Pd Structure Energy of Excited Optical Phonon Modes is carried by the Zeolite Cage Electrostatic Field (on the order of 3 V/nm) to be stored in the Zeolite as heat which Heat can be accessed by Zeolite-Water reaction.

Each of the 13 TSC fusion icosahedra is capable of TSC fusion

Some of the TSC Fusion Energy goes to a Jitterbug transformation

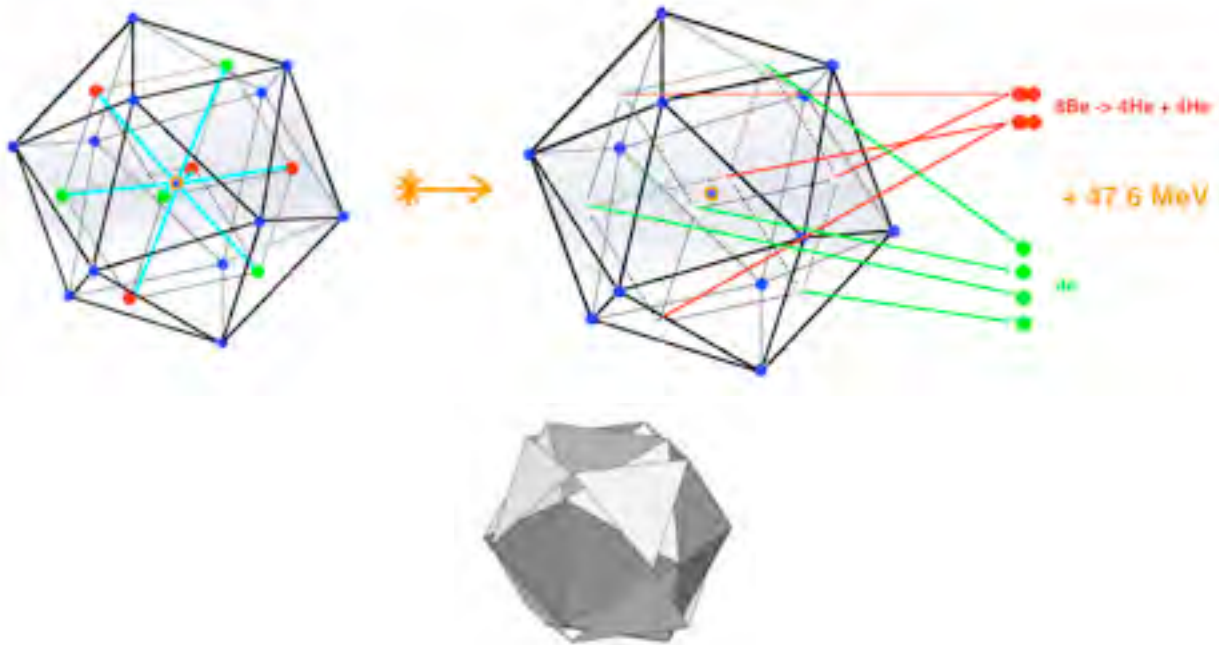

of the icosahedral Palladium, depleted of Deuterium fusion fuel,
to a cuboctahedral configuration

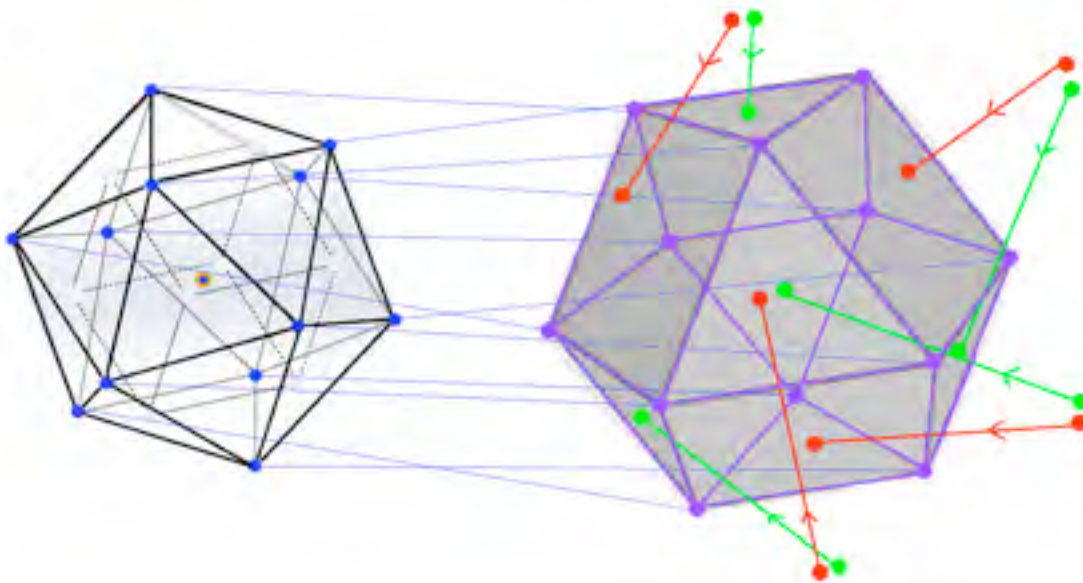

which has 6 large square openings through which
the 4He TSC Fusion Product Ash can leave the Pd cluster
and ambient Deuterium Fuel can enter to reload the Palladium cluster.
Replacement is easier for the 12 outer TSC configurations than for
the 1 central TSC configuration which is not directly exposed to ambient D gas

After entering the Palladium cluster the 4 Deuterium nuclei (red dots) and 4 electrons (green dots) form a Tetrahedral Symmetric Coherent Quantum State centered on the 8 triangular faces of the cuboctahedral configuration. Then, since the icosahedral configuration is the Palladium cluster ground state, another Jitterbug transformation

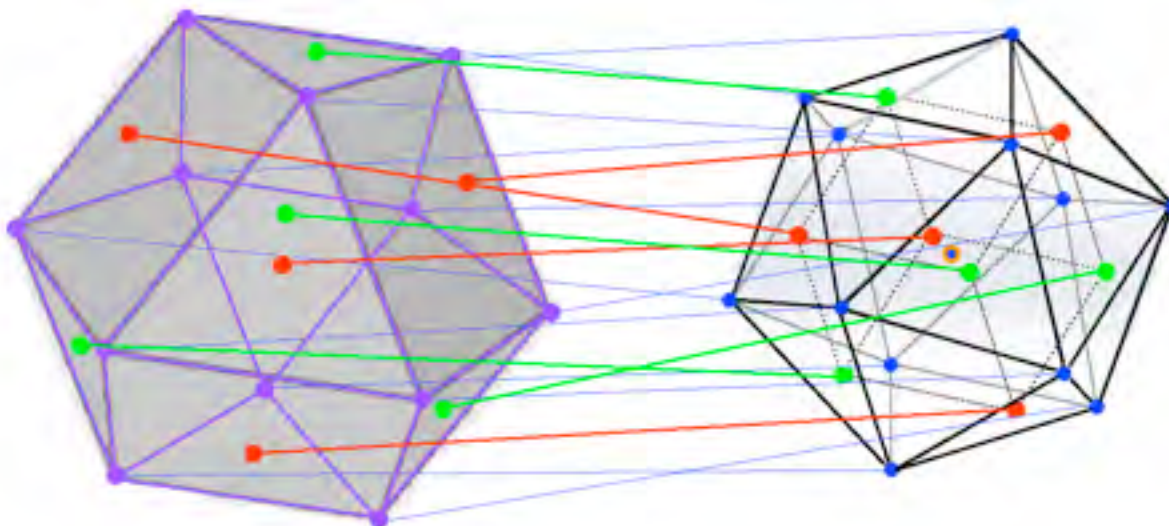

takes the Palladium cluster to an icosahedral configuration with the replenished Deuterium nuclei and electrons ready for another round of TSC fusion

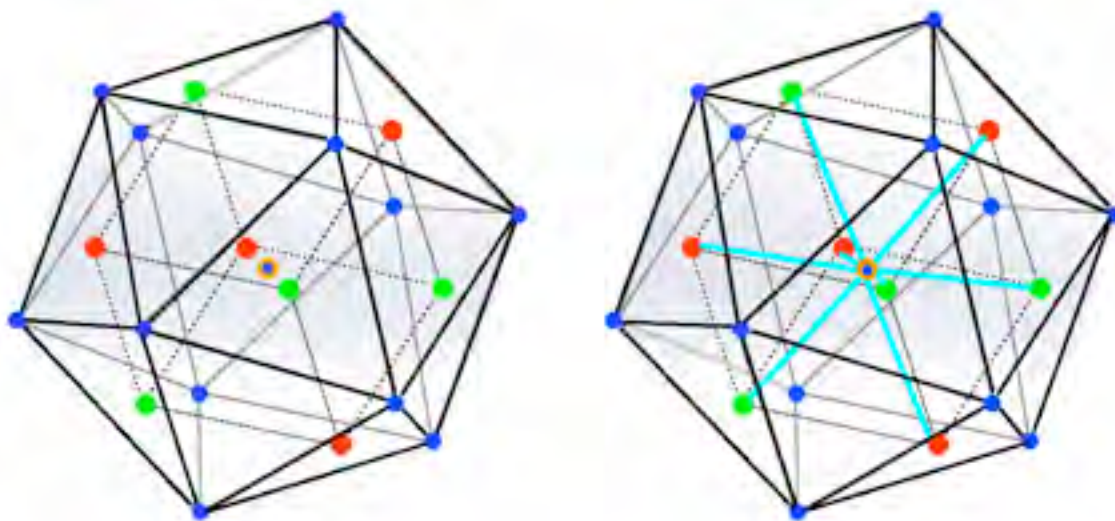

How much energy does TSC Cold Fusion produce ?

According to Hagelstein's model for fusion energy going to excited optical phonons in the Pd cluster, instead of the "... four electrons ... go[ing] outside ...", the four electrons should remain part of Schwinger's "coherent ... single state" until after fusion when the four electrons and the two 4He nuclei would produce two 4He atoms, with most of the 47.6 MeV going to excited optical phonons in the Pd cluster.

If the Pd Clusters were embedded in Zeolite Cages, heat from the Pd Cluster would be transferred to the Zeolite, from which it could be extracted by the Zeolite-Water process.

A 3-shell 147-atom icosahedral Palladium atomic nanocluster contains 13 TSC Fusion Site Icosahedra and each TSC Fusion event produces 47.6 MeV
 $47.6 \text{ MeV} \times 13 \text{ TSC Sites} / 147\text{-atom Pd Cluster} \times 4.45 \times 10^{(-17)} \text{ Watt-Hours} / \text{MeV} = 2.754 \times 10^{(-14)} \text{ Watt-Hours} / 147\text{-atom Pd Cluster}$ for each Jitterbug Cycle

Mass of 147-atom Pd Cluster $147 \times 106 \times 1.66 \times 10^{(-21)} = 2.587 \times 10^{(-17)}$ milligrams
so
a milligram of 147-atom Pd Clusters gives about 1 KiloWatt-Hour each Cycle.

If 36 seconds = 1/100 hour is taken as the Cycle time then

a TSC-Jitterbug Fusion device with 1 milligram of Palladium in the form of 147-atom Pd clusters with full D-Loading should produce 100 KiloWatt-Hours in an hour.

Zeolite Structure

The Zeolite Y Cavity has geometric symmetry related to an isometric trapezohedron = tetragonal trisoctahedron with the 4 holes corresponding to deleting 4 octahedral-type 3-face groups



In the center image, the 10 red dots correspond to the 10 sodalite cages. In the right image, magenta is used for hidden lines and for the 2 hidden sodalite cages and the green octahedron edge corresponds to the green edge in these Jitterbug process images

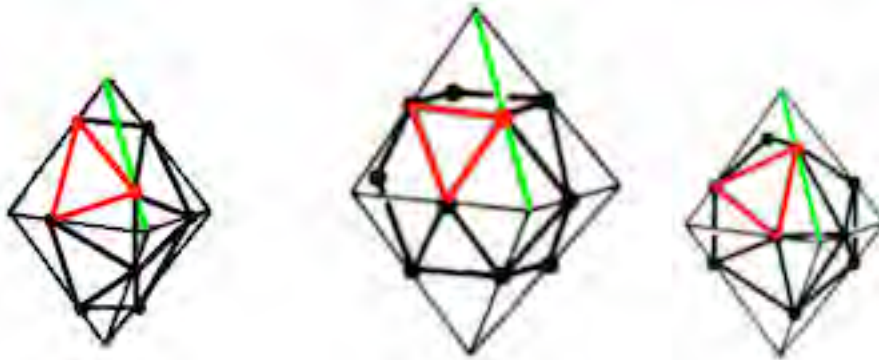

(images adapted from Geometrical Frustration by Sadoc and Mosseri (Cambridge 2006))

The green edge midpoint cuboctahedral vertex is at the widest point of the cavity mouth as expected for the larger cuboctahedron volume and the green edge Golden Ratio point icosahedral vertices are at narrower points of the cavity mouth as expected for the smaller icosahedral volume.

Each sodalite cage is a 24-vertex truncated octahedron as in this image from Wikipedia

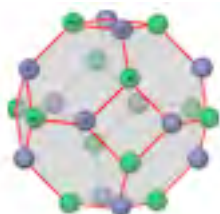

A more detailed view of a sodalite cage from <http://som.web.cmu.edu/structures/S099-sodalite.html> has red dots for Oxygen and pink spheres for OH and yellow spheres for Sodium and blue tetrahedra for Silicon and green tetrahedra for Aluminum

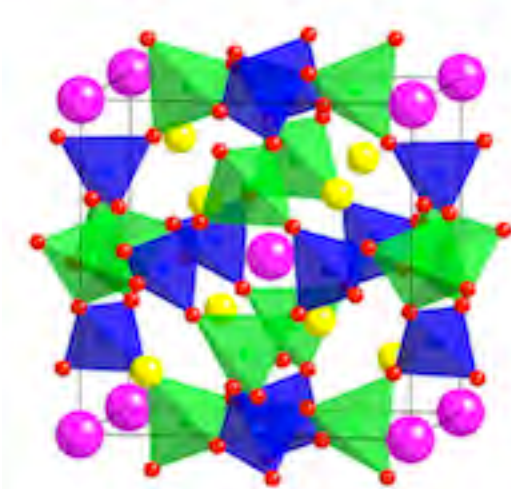

It shows that of the 24 vertices of the sodalite cage, 12 are Aluminum and 12 are Silicon so each Zeolite Cavity has $10 \times 12 = 120$ Aluminum atoms.

Zeolite Cavities have Electrostatic Fields on the order of 3 V / nm .

R. A. van Santen and D. L. Vogel, in Lattice Dynamics of Zeolites (Advances in Solid-State Chemistry, Vol. 1 (1989) 151-224), said: "... The vibrational spectrum of a zeolite may be visualized as the sum of three contributions,

the first of which which is given by the zeolite framework, the network formed by SiO_4 and AlO_4 tetrahedra sharing corners.

The second contribution originates from the ...[material]... located in the cages and channels formed by the framework ... The [material] vibrate[s] against the framework ...

The third contribution is given by the presence of hydroxyl groups and water molecules. Hydroxyl groups are either located in lattice vacancies, or present as isolated groups bound to the external zeolite surfaces, or internally bridging two tetrahedra. ... Due to the very high oscillator strength of the hydroxyl group, water and hydroxyl groups give rise to strong absorption bands between 3200 cm^{-1} and 3750 cm^{-1} (symmetric and antisymmetric stretching modes). ...".

Angela Di Lella, Nicolas Desbiens, Anne Boutin, Isabelle Demachy, Philippe Ungerer, Jean-Pierre Bellat, and Alain H. Fuchs, Phys. Chem. Chem. Phys. 8 (2006) 5396-5406) studied water in Zeolites, saying: "... We report ... Monte Carlo simulations of water



adsorption in [Zeolite] NaY ... faujasite ... The existence of cyclic water hexamers ... located in the 12-ring windows ... recently disclosed by neutron diffraction ...

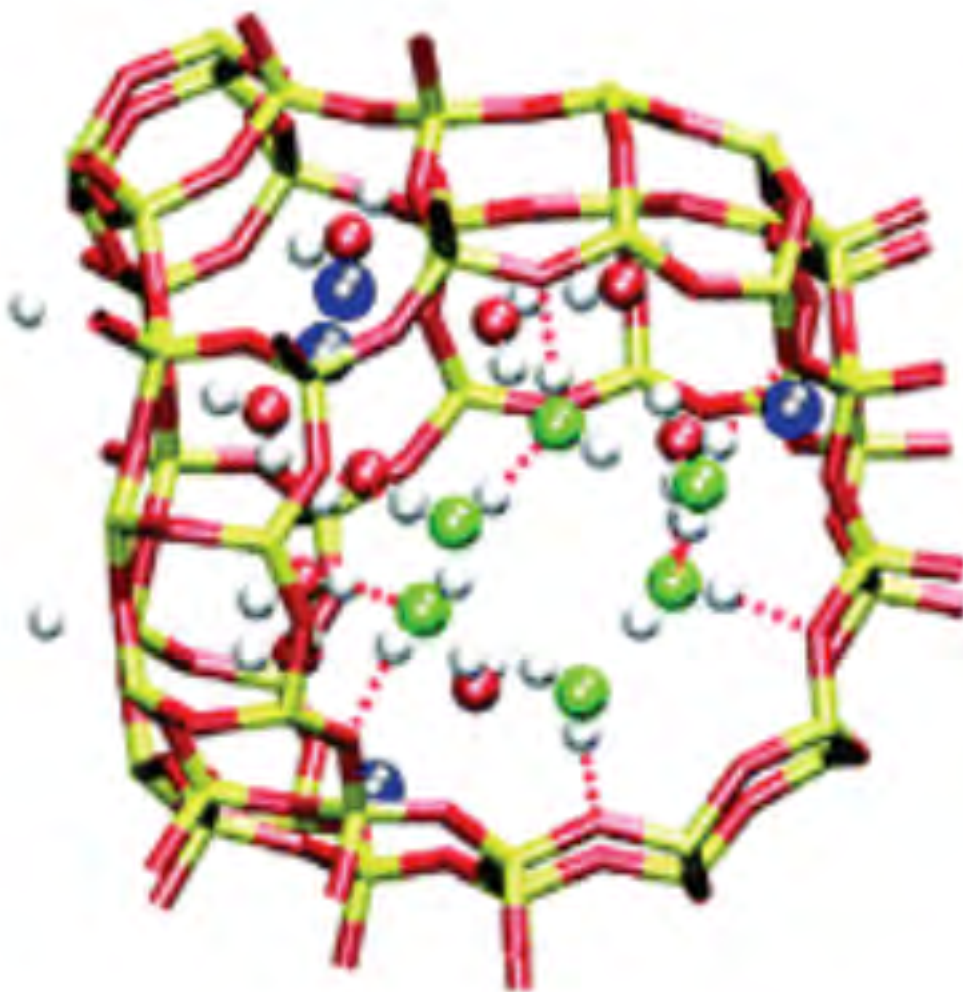

... experiments ... were ... observed in the case of NaY ...".

Dmitry Kopelevich and Chia-Yi Chen, in Phonon interactions in zeolites mediated by anharmonicity and adsorbed molecules (Molecular Simulation 2008), said: "... thermal conductivity of nanoporous materials can be significantly affected by adsorption of guest molecules. These molecules serve as moving defects and provide additional scattering centers for heat-carrying phonons. ...

we perform molecular dynamics simulations of a model system, namely sodalite zeolite with small molecules ... encapsulated in its cages. We measure effects of sorbates ... such as correlations between different phonon modes and the phonon frequency and lifetime. ... The phonon lifetime often increases upon encapsulation of a sorbate into the zeolite which suggests that the sorbate-phonon interactions are qualitatively different from phonon scattering by point defects fixed in the lattice. ...”.

Iraj Parchamazad used Sodium Zeolite Y also known as faujasite.

The Wikipedia page for faujasite says:

“... The faujasite framework consists of sodalite cages which are connected through hexagonal prisms.

The pores are arranged perpendicular to each other.

The pore, which is formed by a 12-membered ring, has a relatively large diameter of 7.4 Å [0.74 nm]

The inner cavity has a diameter of 12 Å [1.2 nm] and is surrounded by 10 sodalite cages. ...”.

Ruby Carat and Melvin Miles interviewed Iraj Parchamazad of University of La Verne in 2012. In that video interview Iraj Parchamazad said that the Zeolite cavity size can oscillate and vary, enlarging up to about 2.4 nm.

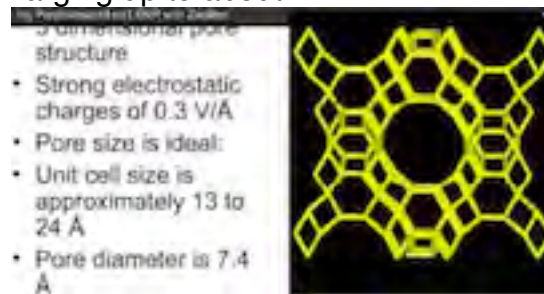

A corresponding enlargement of pore size is to about 1.5 nm which would permit a 3-shell 147-atom Palladium cluster to enter the Zeolite Cavity.

Iraj Parchamazad did not use Sandia’s 1.5 nm Palladium clusters in his Zeolite but

used an organometallic solution containing Palladium atoms.

After putting that into the Zeolite he heated the Zeolite

to burn off Carbon, Hydrogen, and Oxide

leaving a Zeolite and some Palladium.

Then he exposed the Zeolite/Palladium to Deuterium,

and got excess heat 10 out of 10 times, indicating fusion.

I would like to see experiments
with Zeolite directly using Sandia 1.5 nm Palladium NanoClusters.

If there is difficulty with getting the Sandia Clusters
to fit into the Sodium Zeolite Y
then
I would like to see experiments
with Zeolite ITQ-37

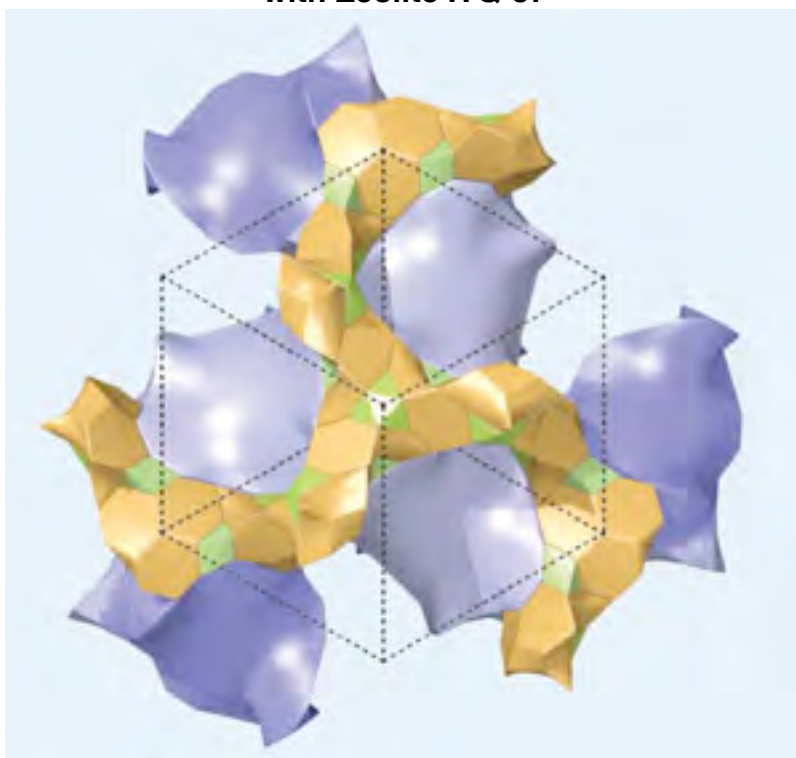

which has pore size about 2 nanometers.
(Royal Society of Chemistry, 29 April 2009 and Sun et al, Nature 2009)

Transfer of Energy from Pd Cluster Structure to Zeolite Structure

After TSC Fusion, by Hagelstein's process, the energy is stored in the Pd cluster as excited Optical Phonon modes.

The Pd Structure Energy of Excited Optical Phonon Modes is carried to the Zeolite in which the Pd cluster is caged to be stored as Zeolite heat.

Each Zeolite Y Cavity is surrounded by 10 sodalite cages which are arranged in a 3-dimensional Diamond network as shown in this image from

<http://www.vurup.sk/sites/vurup.sk/archivedsite/www.vurup.sk/english/products/molek/slovsit1/english.html>

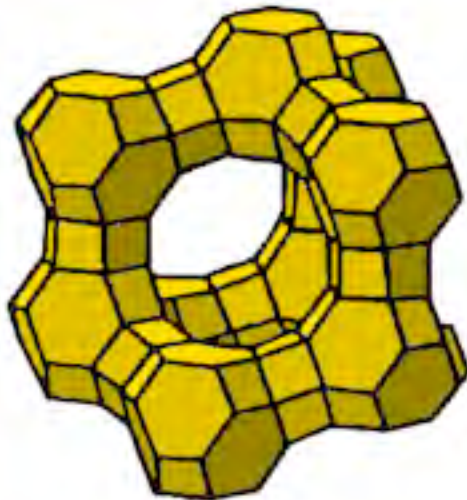

The Pd Structure Energy of Excited Optical Phonon Modes is carried by the Zeolite Cage Electrostatic Field (on the order of 3 V/nm) to be stored in the Zeolite as heat which Heat can be accessed by Zeolite-Water reaction.

Extraction of Cold Fusion Energy from Zeolite Structure

According to a 7 June 2012 techthefuture.com web article by Tessel Renzenbrink: "... Zeolite is a mineral that can store up to four times more heat than water ... zeolite retains a hundred percent of the heat for an unlimited amount of time ... When water comes into contact with zeolite it is bound to its surface by means of a chemical reaction which generates heat. Reversely, when heat is applied the water is removed from the surface, generating large amounts of steam. The transference of heat to the material does not cause its temperature to rise. Instead, the energy is stored as a potential to adsorb water. The ...[German Fraunhofer Institute]... scientists used these particular properties to turn zeolite into a thermal storage system. They created a storage device and filled it with zeolite pellets. To charge the pellets, they exposed them to heat. To retrieve the energy they simply added water. ...".

Here is my design for a TSC-Jitterbug Zeolite Pd-D fusion heat engine:



(Zeolite-Pd images adapted from Calvo and Carre in Nanotechnology 17 (2006) 1292-1299 and from <http://gwenbeads.blogspot.com/2014/04/infinite-skew-polyhedron-faujasite-4446.html>)

D2O Heavy Water is used to take heat from the Zeolite to make steam so that Hydrogen from H2O does not poison the TSC-Jitterbug process by replacing Deuterium in the Palladium nanoclusters, a possible problem pointed out by Melvin Miles. D2O heavy water from Fisher Scientific costs about \$1,000 per liter for 99.8 atom % D.

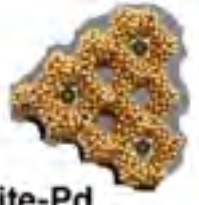

Preparation of Zeolite-Pd

Sodium Zeolite Y has unit cell size about 2.5 nanometers which corresponds to the edge-length per cavity of its overall octahedral structure.

According to <http://www.google.com/patents/US20040047803>

“... Synthesis and stabilization of nanoscale zeolite particles ...

Zeolite Y is of great interest ... Zeolite crystals prepared under conventional synthesis conditions frequently have a mean particle size of between 1 and 5 μm it would ... be useful if the zeolite particles were sufficiently small to form a colloidal suspension ... Mono- or di-saccharides can be used to keep the crystal size of faujasite (zeolite X and Y) small

... Sucrose, dextrose or other saccharides are added to a conventional aluminium silicate reaction mixture obtained by mixing aqueous alkali metal silicate and alkali metal aluminate solutions at low temperatures, followed by ageing and hydrothermal synthesis. Crystal sizes of between about 30 and 40 nm are claimed ...”.

According to Journal of the Taiwan Institute of Chemical Engineers 50 (2015) 259–265 by PankajSharma, Su-JungJeong, Moon-HeeHan, and Churl-HeeCho

“... nanosized NaY zeolite crystals from clear solution using ... (TMAS) ... tetramethylammoniumsilicate ... yields particle of size around 50 nm but in aggregated form ...”.

According to a Journal of Catalysis article by Patrick D. Burton, Timothy J. Boyle, and Abhaya K. Datye, "Facile, surfactant-free synthesis of Pd nanoparticles for heterogeneous catalysts"

“... room temperature reduction of Pd(OAc)₂ in MeOH is slow enough to produce a suspension of ... metal-phase ... Pd NPs. ...

A Pd-NP/C catalyst was prepared by mixing the carbon support into the suspension of Pd NPs and evaporating the solvent. Aggregate formation was a concern, as there were no capping agents to prevent particle growth. Therefore, the nanoparticles were collected quickly before substantial aggregation could occur. ... this technique is general and can be extended to other powder supports. ...”.

An “other powder support” that would be useful for TSC-Jitterbug fusion energy would be 30-40 nanometer Zeolite Y Crystals in colloidal suspension.

As the Pd nanoclusters “... grow for 20 ... min ...” up to size 1.56 nm for the 147 atom size that is optimal for TSC-Jitterbug fusion,

they are small enough to fit into the Exterior Cavities of the Zeolite Y Crystals

(which are have average pore opening 0.74 nm and cavity size 1.2 nm

but which sizes can oscillate to be up to about twice those sizes)
 Due to the open structure of the Zeolite Y Crystals, growth up to the 147 atom size can continue inside the Exterior Cavities of the Zeolite Y Crystals.
 As soon as the Pd nanoclusters have grown to the 147 atom size the solvent can be evaporated and the powder of 30-40 nm Zeolite Y Crystals loaded with Palladium can be collected and placed in the TSC-Jitterbug Fusion Reaction Chamber for exposure to Deuterium gas and heating the Zeolite Y Crystals by fusion energy.

The Zeolite Y Crystal has octahedral structure

(images from
news.chess.cornell.edu/articles/2011/OctahedralNanoparticles.html
mathworld.wolfram.com/SquarePyramidalNumber.html
 Journal of the Taiwan Institute of Chemical Engineers 50 (2015) 259–265)

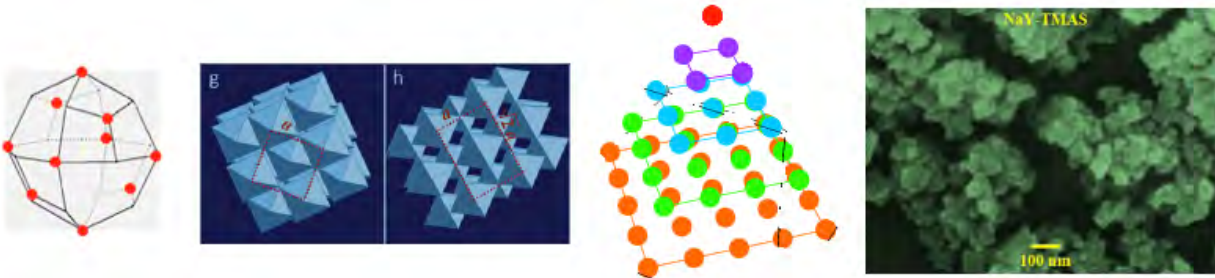

and each unit cell with 1 Cavity is 2.5 nanometers in diameter
 so an octahedral Zeolite Y Crystal with diameter 35 nanometers
 would have an edge length $35 / \sqrt{2} = 25 \text{ nm} = 10 \text{ cells}$
 and the octahedron would have 19 square layers:

layer 1 = 1 external + 0 internal = 1 for total of 1 of which 1 is external
 layer 2 = 4 external + 0 internal = 4 for total of 5 of which 5 are external
 layer 3 = 8 external + 1 internal = 9 for total of 14 of which 13 are external
 layer 4 = 12 external + 4 internal = 16 for total of 30 of which 25 are external
 layer 5 = 16 external + 9 internal = 25 for total of 55 of which 41 are external
 layer 6 = 20 external + 16 internal = 36 for total of 91 of which 61 are external
 layer 7 = 24 external + 25 internal = 49 for total of 140 of which 85 are external
 layer 8 = 28 external + 36 internal = 64 for total of 204 of which 113 are external
 layer 9 = 32 external + 49 internal = 81 for total of 285 of which 145 are external
 layer 10 = 36 external + 64 internal = 100

layers 11 through 19 are mirrors of 1 through 9, for a total of 285 with 145 external
 so an octahedral Zeolite Y Crystal with diameter 35 nm would have
 $285 + 100 + 285 = 670$ cavities with $145 + 64 + 145 = 354$ (52.8 %) external and
 therefore relatively easily accessible to the Pd nanoclusters in the colloidal suspension.

Zeolite Y unit cell atomic mass is (from nptel.ac.in Introduction to Catalysis Lecture 36 Zeolites)
 $(56 \times 23 \text{ Na} + 56 \times 59 \text{ AlO}_2 + 136 \times 60 \text{ SiO}_2 + 264 \times 18 \text{ H}_2\text{O}) = 17,504$
 for actual mass = $17504 \times 1.66 \times 10^{(-21)} = 2.906 \times 10^{(-17)}$ milligrams
 The atomic mass of a 147-atom Pd nanocluster is $147 \times 106 = 15,582$
 for actual mass = $15,582 \times 1.66 \times 10^{(-21)} = 2.587 \times 10^{(-17)}$ milligrams
 For 35 nm Zeolite Y Crystals only about 1/2 of their Cavities are External so it may be
optimal to use Zeolite Y Crystal mass = 2 x Palladium mass in the colloid.

Zeolite Heat and Capacitor Electricity

According to a 26 January 2011 PhysOrg.com article by Lisa Zyga:

“... The unique 3D array of nanopores in zeolite-templated carbon ...

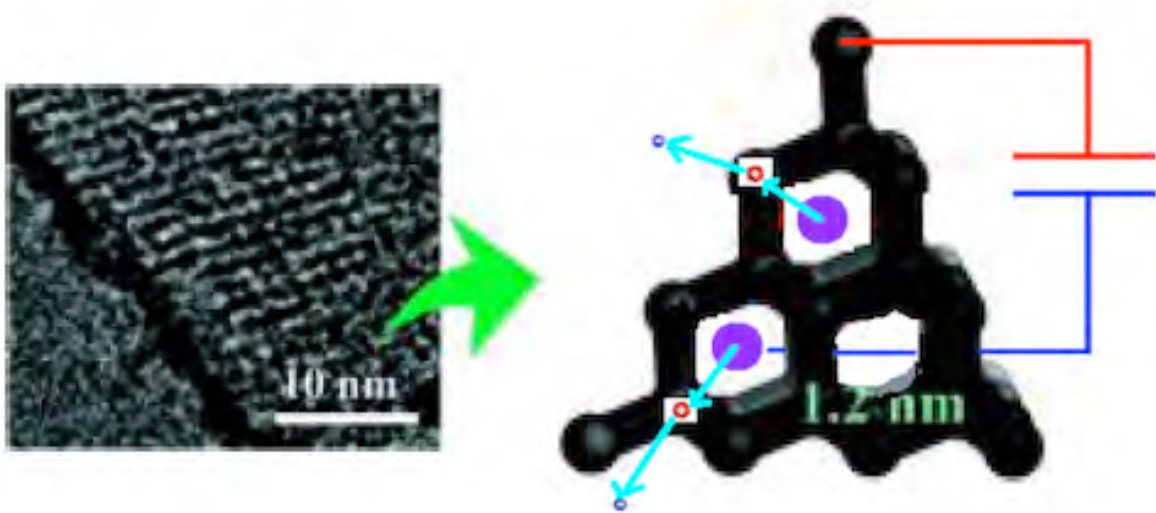

(image modified to show
 Zeolite-Templated Carbon framework as Black, Palladium NanoClusters as Purple,
 Ambient Fluid with Deuterium for TSC-Jitterbug Reloading as White,
 Excited Optical Phonons from TSC-Jitterbug Fusion as Cyan arrows
 ionize parts of the ZTC, ejecting electrons (Blue) into the Ambient Fluid
 and leaving positive ions (Red) in the Zeolite-Templated Carbon
 thus building up a Capacitance Voltage
 between the Zeolite-Templated Carbon and the Ambient Fluid)

... enables it to be used as an electrode for high-performance supercapacitors that have a high capacitance and quick charge time ... The zeolite-templated carbon consists of nanopores that are 1.2 nm in diameter ... and that have a very ordered structure ...”.

Synthesis of Zeolite-Templated Carbon

is described in the 2013 Caltech Ph.D. Thesis of Nicholas Stadie:

“... Zeolite-templated carbon (ZTC) materials were prepared ... by ... established methods ...

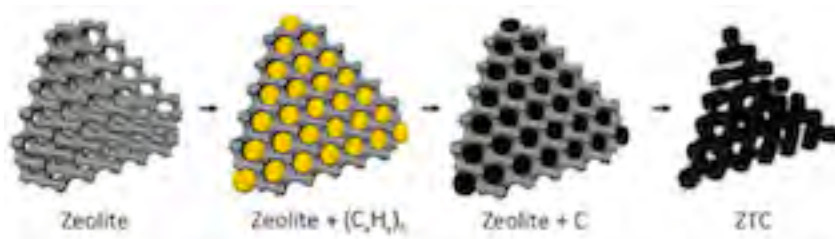

Figure 4.1. A schematic of template-carbonization in a porous zeolite framework, to produce zeolite-templated carbon (ZTC).

...”

The ZTC capacitor process converts TSC-Jitterbug fusion energy directly to electricity. Since it does not require the Zeolite-heat-water-steam chemical structure only the Zeolite Y Crystal geometric configuration is needed so all the Zeolite Y can be converted to ZTC carbon configurations attached to a single base carbon substrate that acts as a Capacitor Electrode.
(It would be difficult to use separated Zeolite Y Crystals as an electrode.)

However,
the ZTC has fewer Exterior Cavities than the colloidal free-floating Zeolite Y Crystals because
each ZTC structure is attached to the carbon substrate by a base face,
thus eliminating the Exterior Cavities on that base face
so that
for 35 nm ZTC structures only about 1/3 of their Cavities are External
(as opposed to about 1/2 for free-floating 35 nm Zeolite Y)
so it may be optimal
for the number of ZTC Cavities to be 3 x the number of Pd 147-atom nanoclusters.

Synthesis of 147-atom Pd clusters and Embedding into Zeolite

147-atom Pd clusters have diameter about 1.5 nanometers.

1.5 nm Pd Clusters have been produced

at Sandia National Laboratories

and University of New Mexico Center for Micro-Engineered Materials

according to a Journal of Catalysis article

"Facile, surfactant-free synthesis of Pd nanoparticles for heterogeneous catalysts"
at

<http://www.flintbox.com/public/filedownload/2871/2011-038%20Science%20Direct%20Article>

by Patrick D. Burton, Timothy J. Boyle, and Abhaya K. Datye showing

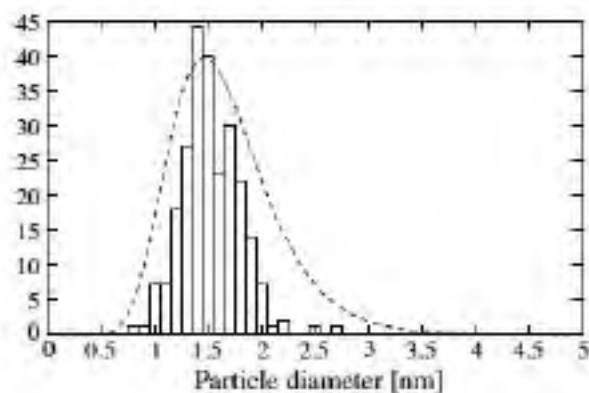

“ ... ”

Tim Boyle said in email October 2014:

“... We easily remade the Pd NP just need to get TEM to see what size they are.

If they come out good, we can go ahead and make some for you.

Couple of things.

This is very easy and ya'll may want to do it yourselves
(esp after the next couple of comments).

Simply dissolve Pd-acetate in MeOH and stir for 5 min,
let grow for 20 more and should have your size.

The problem is these will continue to grow and plate out onto the sides of the container,
unless you use a substrate.

Would you want these on a substrate, then that'll need to be supplied.

If we make it, we'd have to send it as a solution ...

could you handle this and could you use it?

It won't be a powder, which I think is what you want.

We can dry it down to a powder but not sure what size that will be
or how they'd cluster and how they'd redisperse or in what solvent.

we can try to deposit the materials on a number of surfaces and just let it dry.

Again, not sure how the clustering of these particles will occur.

A gram will take about 2.5 g of Pd(Oac)₂ which we have but will need replaced. ...”

Sandia Pd Cluster Recipe

- 1 - 15 ml of methanol (MeOH) in a scintillation vial
- 2 - Add 5 mg palladium acetate (Pd(OAc)₂) whose color is red-orange
- 3 - Reduce the Pd(OAc)₂ by MeOH to Pd atoms by stirring for 5 minutes with unobstructed exposure to room lighting.
- 4 - Add 10 mg of substrate in colloidal suspension
- 5 - Place on elevated stir plate and allow to react undisturbed for 20 minutes.

During 20 minutes the Pd atoms form clusters that grow to size 1.5 nm (147 atoms)

Initially the Pd atom clusters are very small (only a few atoms) and will migrate onto the substrate and continue to grow to size 1.5 nm (147 atoms) at 20 minutes

Color of colloidal suspension changes from pale yellow to dark green over the 20 min

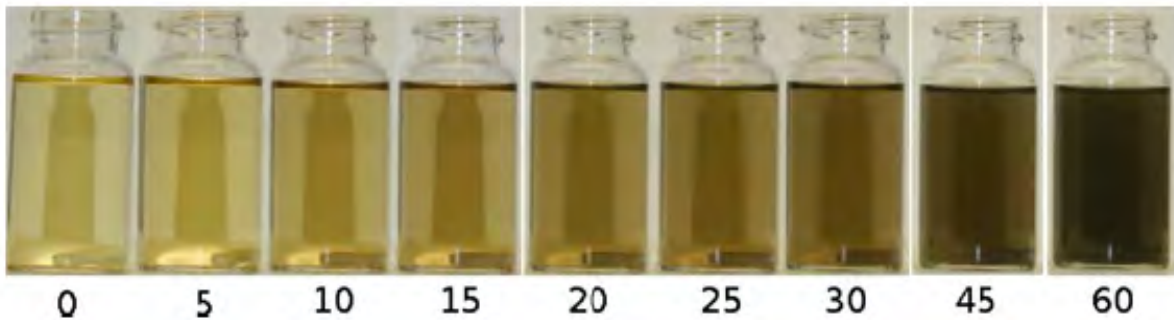

- 6 - At 20 minutes Pd-loaded substrate (and any remnant Pd still in colloidal suspension) are removed and the Pd-loaded substrate dried

7 - Pd-loaded substrate is placed in reaction chamber where it is exposed to Deuterium gas from tank and calorimeter measurements are taken to measure any heat that might be produced by TSC-Jitterbug fusion

(analagous to heat produced by Arata and Zhang (replicated by McKubre at SRI) with no external power input - only palladium powder + deuterium gas)

The substrate used initially by Sandia was SBA-15 mesoporous silica. In future experiments the substrate may be 30-40 nm Zeolite Crystals, such as Sodium Zeolite Y or ITQ-37.

At 30-40 nm size each will have about 12 to 16 large Cavities per edge About half of the Cavities will be on the Exterior Surface of the Tetrahedral Crystal where they will be easily accessible by Pd atom clusters in the colloidal suspension

Global Energy and TSC-Jitterbug-Zeolite Fusion machines

Can TSC-Jitterbug-Zeolite Fusion produce Abundant Cheap Energy so that Expensive Competition for geologically concentrated Cheap Oil



will become unnecessary ?

Using total Earth Energy Reserves in Terawatt-years, according to M. Taube, in his book Evolution of Matter and Energy on a Cosmic and Planetary Scale (Springer-Verlag 1985), the number of years that 10^{10} people could consume energy at the present USA per capita rate, a consumption rate of about 1,000 Terawatt-years/year, is:

	Reserves (Terawatt-years)	Duration (years)
Oil	850	1
Gas	550	1
Methane	1,500	2
Coal	7,000	7
Uranium	1.9×10^9 (1/1000 of Earth supply)	2,000,000
Thorium	7.9×10^9 (1/1000 of Earth supply)	8,000,000
Deuterium	1.9×10^9 (1/1000 of ocean supply)	2,000,000
Lithium	1.9×10^9 (source of tritium)	2,000,000

As to solar energy, the total solar energy received by Earth is about 109,000 Terawatt-years/year so that 10^{10} people could consume energy at the present USA per capita rate by using about 1% (one percent) of the solar energy received by Earth. This could be done, for example, by building a lot of orbiting solar energy collection dishes and beaming the energy to Earth.

The total geothermal heat flux is about 66 Terawatt-years/year, and the total tidal energy is about 3 Terawatt-years/year, so that those sources would be inadequate to support 10^{10} people consuming energy at the present USA per capita rate.

For Everybody on Earth to be Happy, the Abundant Cheap Energy must provide a high Standard of Living (current USA standard) for a lot of people (10 billion), and:

last for a long time (more than decades) - rules out Oil, Gas, Methane, and Coal;

have no serious radioactive waste - rules out Uranium, Thorium, and Tritium (Lithium);

have realistically scalable capital cost - rules out Solar which would require Satellite collectors with area 1% of $\pi \times 6,000^2 = 1,000,000 \text{ km}^2 = (1,000 \text{ km})^2$ or cloud-free collectors on Earth surface with the same area. Less than 100% efficiency would require correspondingly larger area of collectors.

That leaves one possible source of Abundant Cheap Energy for 10 billion people:

	Reserves (Terawatt-years)	Duration years)
Deuterium	1.9 x 10⁹ (1/1000 of ocean supply)	2,000,000

Since a gram of properly structured Palladium gives TSC-Jitterbug Pd-D Cold Fusion Energy on the scale of Megawatts:

1 milligram of Palladium gives a 1 kiloWatt Machine, useful for “electric motors, tools, machines and heaters” (Wikipedia) Such small energy machines could use the ZTC Electric Capacitor technology.

1 gram of Palladium gives a 1 MegaWatt = 1340 HorsePower Machine, useful for “large electric motors; large warships such as aircraft carriers, cruisers, and submarines; large server farms or data centers; and some scientific research equipment such as supercolliders, and the output pulses of very large lasers. A large residential or commercial building may use several megawatts in electric power and heat. ... railway... electric locomotives ... typically have a peak power output of 5 or 6 MW, although ... Eurostar ... uses more than 12 MW, while heavy diesel-electric locomotives typically produce/use 3 to 5 MW ...” (Wikipedia) C-130 aircraft have 4 engines each with 4300 HorsePower (globalsecurity.org) so would need a $4 \times 4300 / 1340 = 13$ grams of Pd Such mid-sized energy machines could use, depending on portability and site requirements, either Zeolite Steam or ZTC Electric Capacitor technology.

1 kg of Palladium gives a 1 GigaWatt Machine,
useful for “large power plants ... HVDC converters have been built with power ratings up
to 2 GW” (Wikipedia)

Such machines could use either Zeolite Steam or ZTC Electric Capacitor technology,
using HVDC converters up to 2 GW to convert the ZTC Electric Capacitor DC into AC.

1,000 kg = 1 ton of Palladium gives 1 TeraWatt.

The total power used by Humans in 2006 was 16 TW.

The average lightning strike peaks at 1 TW, but lasts only 30 microseconds.

Powerful 20th century lasers produce TW, but only for nanoseconds. (Wikipedia)

1,000 tons of Palladium gives 1 PetaWatt.

The Lawrence Livermore Nova laser has power of 1.25 PW in a 5×10^{-13} sec pulse.

The total power of sunlight hitting the Earth is about 174 PW. (Wikipedia)

222 tons of Palladium were mined world-wide (based on 2006 and 2007 data, Wikipedia):

Russia produced 98 tons
South Africa produced 89 tons
Canada produced 13 tons
USA produced 11 tons
the rest of the world produced 11 tons

Appendix A: Details of Structure of 147-atom Pd clusters

There are two basic structures that are Jitterbug Transforms of each other:

Icosahedral and Cuboctahedral

n = number of shells

N = number of Pd atom vertices

d = diameter of icosahedral configuration in nm

C = number of cells in icosahedral phase

CT = number of tetrahedral cells in icosahedral phase

CO = number of octahedral cells in icosahedral phase

n	N	d	C = CT + CO
0	1	0.27	0 = 0 + 0
1	13	0.70	20 = 20 + 0
2	55	1.13	100 = 80 + 20
3	147	1.56	280 = 200 + 80

icosahedral



cuboctahedral



icosahedral



cuboctahedral



icosa



cubo



icosa



cubo

(Images from: Polyhedral Clusters by Lord et al; Frank and Kasper in Acta Cryst. 11 (1958) 184-190; Mackay in Acta Cryst. 15 (1962) 1916-1918; vimeo.com/27662398 by Yan Liang (L2XY2) August 2011. Data for n, N, and d from Shtaya-Suleiman dissertation Gottingen 2003.)

147-atom Icosahedral Geometry

The 147-atom cluster is a central Palladium atom surrounded by 3 layers of Pd atoms:

Layer 1 = central 1 (black) + 12 icosahedral (green) = 13 vertices
and 20 tetrahedral cells

It is a single icosahedron configuration that allows TSC fusion
of 4 Deuterium nuclei (red dots) screened by their 4 electrons (green dots)
condensing along symmetrical paths (cyan lines) to fusion at the center

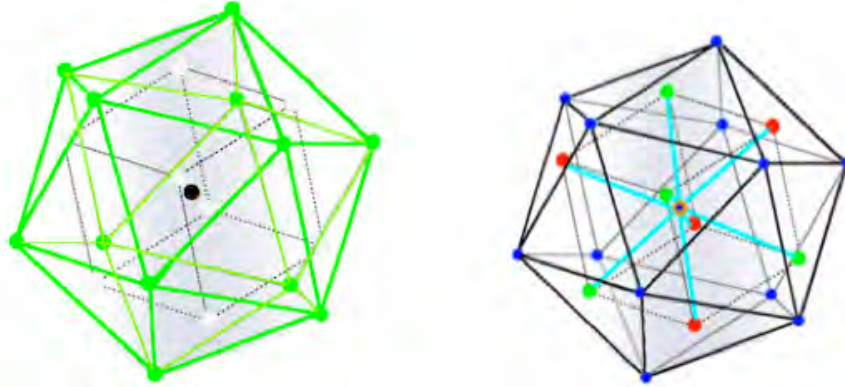

Layer 2 adds 42 vertices (blue) for total of 55
and 60 tetrahedral + 20 cuboctahedral cells for total 80 tetra + 20 cubo = 100

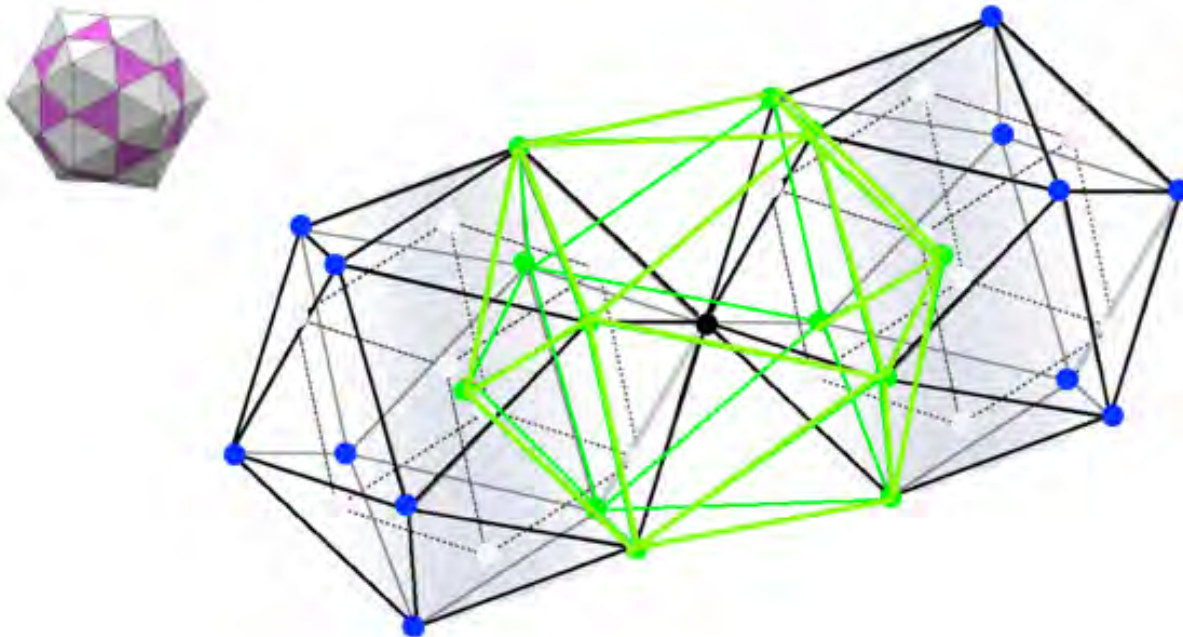

It is a configuration of 2 TSC fusion icosahedra sharing the central vertex
with the remaining $55 - (26-1) = 30$ vertices in 3 10-vertex bands

Layer 3 adds 92 vertices (red) for total of 147
 and 120 tetrahedral + 60 cuboctahedral cells for total 200 tetra + 80 cubo = 280

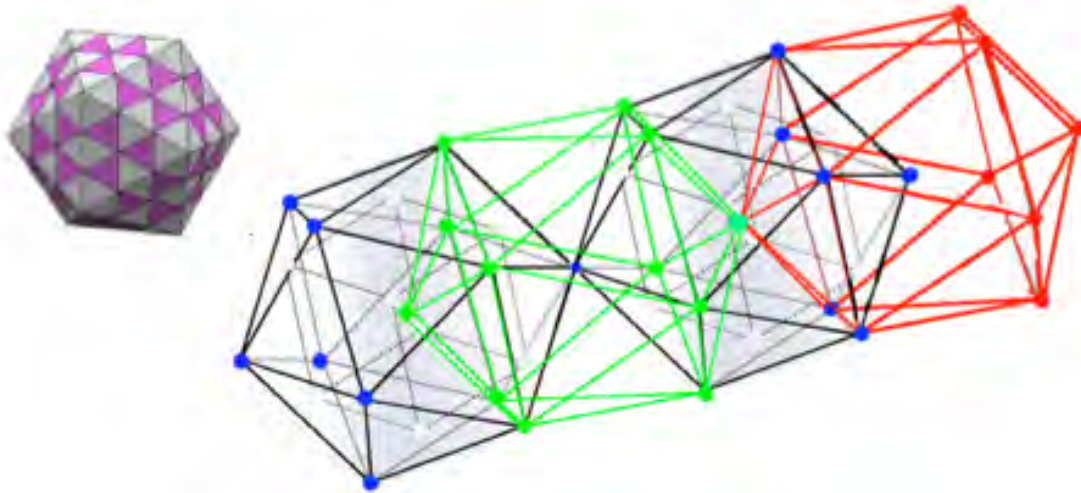

It is a configuration of 12 TSC fusion icosahedra

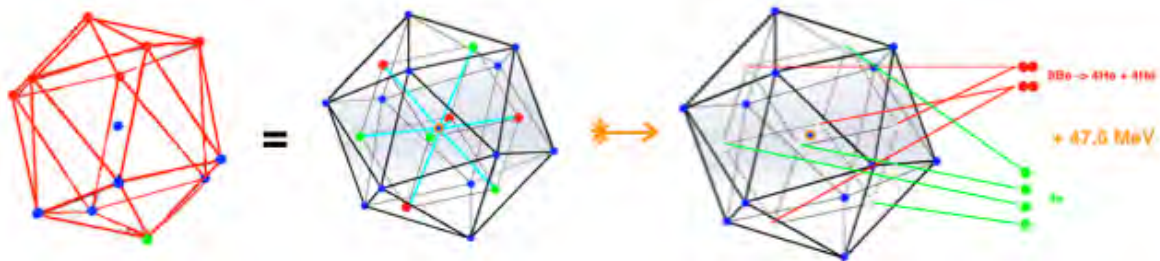

each of which shares a vertex with one of the 12 vertices of the Layer 1 icosahedron.

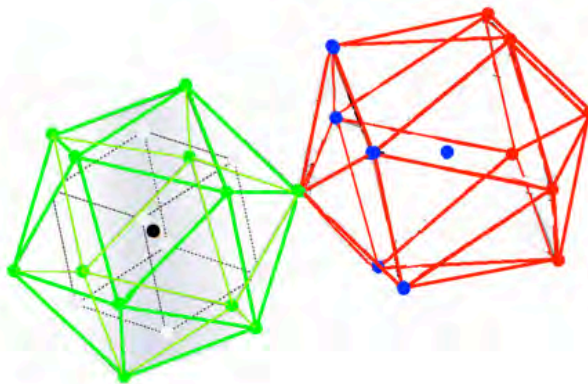

so that the entire 3-layer 147-atom configuration has 13 TSC fusion icosahedra:
 12 outer icosahedra and 1 central icosahedron.
 The 13 TSC configurations have $13 \times 13 = 169$ vertices but
 24 vertices are shared between an outer and the central TSC
 and $5 \times 12 = 60$ vertices are shared between two outer TSC
 so $169 - 24/2 - 60/2 = 127$ of the 147 vertices are in the 13 TSC
 The remaining $147 - 127 = 20$ vertices outside the 13 TSC are
 at the centers of the triangle faces of the entire 147-atom icosahedron.

147-atom Cuboctahedral Geometry



The 147-atom 3-layer icosahedron goes to a 3-layer cuboctahedral structure by Jitterbug transformation of all 147 atoms.

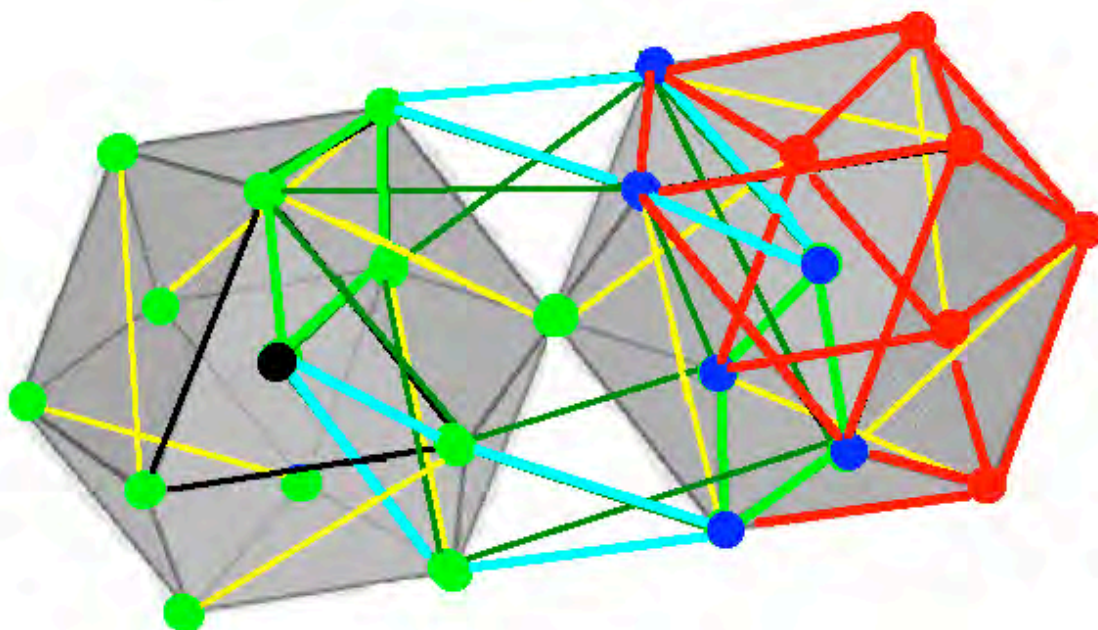

Like the icosahedron case, in the cubo case there is a central (black) vertex surrounded by 12 (green) cubo-configured vertices and a second layer (blue) forming an intermediate (distorted) cuboctahedron and a third layer (red) forming an outer (more regular) cuboctahedron.

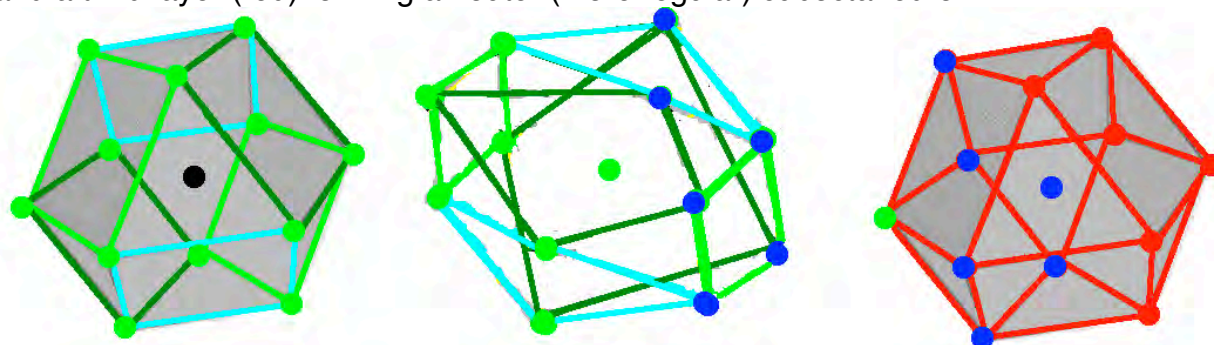

In the cubo case, there are also 12 outer TSC Jitterbug cuboctahedra plus a single central TSC Jitterbug cuboctahedron, so Jitterbug transformation of the entire 147-atom Pd cluster works consistently with individual Jitterbug transformations of the 13 TSC icosahedra and TSC Jitterbug cuboctahedra.

How do the Icosahedral Clusters grow to 147 atoms ?

Eric A. Lord, Alan L. Mackay, and S. Ranganathan say in

"New Geometries for New Materials" (Cambridge 2006):

"... The Mackay icosahedron is obtained by packing tetrahedra and octahedra around an icosahedron [12 vertices +1 center = 13 vertices]...

if an octahedron is placed on every face of an icosahedron, the angular gap between neighboring octahedra can be closed by a very small deformation, to bring them into face contact [12 + 20 x (6-3)/2 = 42 vertices]...



... The concave regions of the resulting polyhedron can be filled by five-rings of tetrahedra [42 + 12 + 1 center = 55 vertices]...



... The [55]-atom Mackay cluster ...[triangles: dark = octahedra; light = tetrahedra]...

The process can be continued ...[with octahedra on each of the 12x5 = 60 outer cell faces of 5-rings thus adding 60 x (2/2 + 1/3) = 80 vertices and creating

2 TSC Fusion structures sharing a central vertex.

This also creates concave places for 30 pairs of tetrahedra adding no vertices plus 12 tetra-5-rings adding 12 vertices for a total of 54+80+12 + 1 center = 147.



147-atom cluster

has 12+1 = 13 TSC Fusion sites]..."

Lord et al use 12, 54, and 146 atoms for Mackay clusters
while Liang uses 13, 55, and 147 atoms.

The difference is whether or not the center vertex is counted, that is,
not so much a real physical difference but a difference in math convention.

How many D atoms can live in a 147-atom Pd cluster ?

F. Calvo and A. Carre say in Nanotechnology 17 (2006) 1292–1299

"Structural transitions and stabilization of palladium nanoparticles upon hydrogenation":
"... Cuboctahedra ...[and]... icosahedra ... contain exactly the same number of atoms. ...
In the case of ... the 147-atom Pd cluster ... the favoured structure in the pure metal is the three-layer icosahedron.

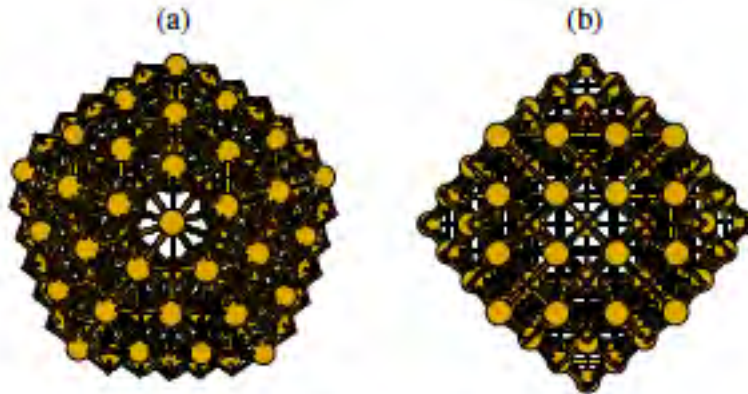

Figure 1. Palladium clusters fully loaded with hydrogen.

(a) $\text{Pd}_{147}\text{H}_{200}$, I_h symmetry; (b) $\text{Pd}_{147}\text{H}_{164}$, O_h symmetry.

...".

Since the minimum full load for Icosa or Cubocta Pd/Ni 147-atom clusters is 164 D/H atoms, no more than 3 cycles of full TSC fusion (each consuming 56 D/H nuclei) can occur without replenishment of D/H from the surroundings of the clusters (such as immersion of the clusters in D/H gas).

How long does it take Deuterium to load into Palladium ?

Wang, Hara, and Watanabe in Materials Transactions, Vol. 48, No. 3 (2007) pp. 560 to 565 say:

"... Pure Pd, Pd-4 at%Pt and Pd-8 at%Pt ... powders smaller than 200 mesh ($<74 \text{ nm}$) were prepared ... hydrogen absorption ...[by Pd-4 at%Pt]... was extremely fast and attained to equilibrium within tens of seconds. Hydrogen absorption by Pd and Pd-8 at%Pt was also very fast ...".

Tens of seconds is much longer than the times for TSC Fusion and for Jitterbug so it determines the time duration of one TSC-Jitterbug Fusion Cycle and

for the purpose of rough calculations it seems reasonable to take

36 seconds = 1/100 hour = time duration of one TSC-Jitterbug Fusion Cycle.

This time is much shorter than the usual loading time for old-type Cold Fusion experiments using Palladium rods, discs, much-larger-than 1.5 nm powder, etc because there are only 3 layers of Pd atoms in 1.5 nm 147-atom Pd clusters.

What about more than 147 atoms ?

As more layers are added, the deformations of tetrahedra and octahedra accumulate and eventually destabilize the structures necessary for Jitterbug and TSC Fusion. The next Mackay cluster beyond 147 atoms has $147+162 = 309$ atoms.

Barretau, Desjonqueres, and Spanjaard in Eur. Phys. J. D. 11 (2000) 395-402 say:
 "... the icosahedron is the preferred structure at small sizes, and the critical size at which the relative stability becomes favorable to cuboctahedrons is $N = 561$ for PdN clusters ...[for which]...
 For $N = 13$ the cuboctahedron is ... unstable.

For $N = 55, 147,$ and 309 atoms the cuboctahedron is metastable and slightly distorted. Its transformation to a perfect icosahedral structure needs an activation energy of 12 meV for $N = 55,$ 28 meV for $N = 147$ and 45 meV for $N = 309.$ The activation energies involved in the inverse transformation are 61 meV for $N = 55,$ 51 meV for $N = 147$ and 48 meV for $N = 309.$
 ...[compare 47.6 MeV for each TSC Fusion event]...

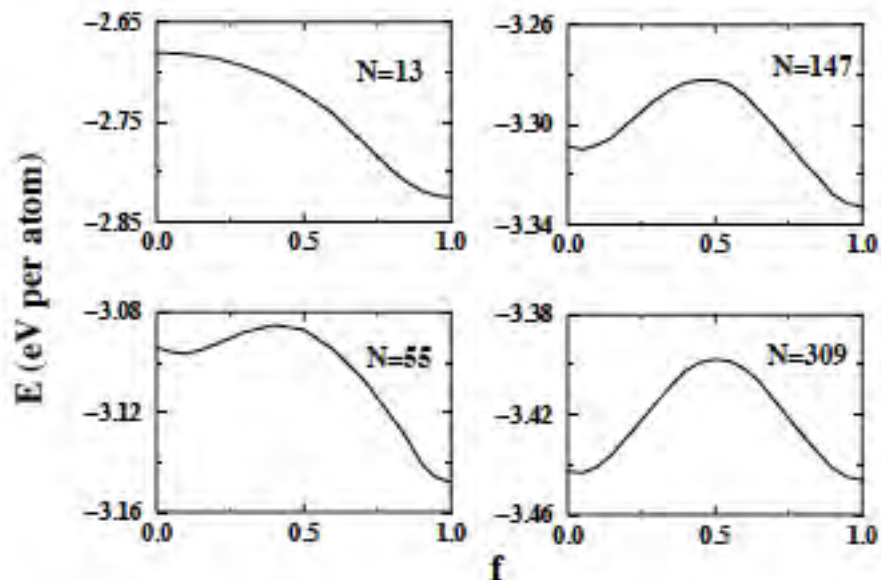

... The evolution of the potential energy profile of homogeneously relaxed ... PdN clusters during the Mackay [Jitterbug] transformation for increasing values of N. f is a fraction of the displacements ... f = 0 and 1 correspond to the ... cuboctahedron and icosahedron, respectively ...".

$N = 309$ is disfavored for TSC-Jitterbug Fusion with respect to $N = 147$ for two reasons:
 energy levels are too close for rapid Jitterbug cubocta to icosah transition

$N = 309$ Pd Cluster is too large (2 nm) to fit
 through 1.5 nm expanded Sodium Zeolite Y pore

so

147 atoms is optimal for Pd cluster Cold Fusion

Appendix B: Graphene and Klein Paradox Quantum Tunnelling

Consider the outer shell (L-shell) of Carbon:

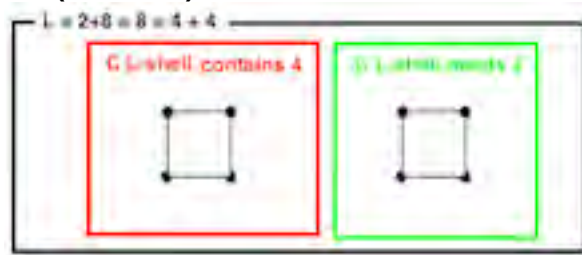

The useful chemistry of Carbon (graphite, diamond, buckyballs, graphene, organics) is due to the fact that

each Carbon atom has the 4 L-shell electrons that every other Carbon atom needs.

If each Carbon atom is connected to 4 other Carbon atoms

then the result is a 3-dim Diamond Packing with Tetrahedron Vertex Figure.

However, Diamond is only a metastable state. Graphene is a stable state.

P. B. Allen and B. K. Nolicic, in University of Delaware PHYS 824: Introduction to Nanophysics - Electronic band structure of graphene, said: "... Band structure of graphene ... originates from orbital hosting the fourth valence electron. The bands which correspond to the dispersion of bonding and antibonding molecular orbital (constructed from orbitals on two carbon atoms) are called pi and pi* bands ...

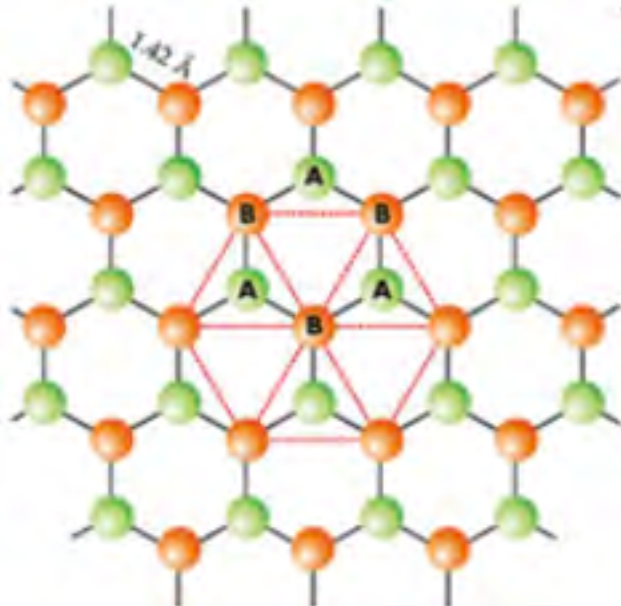

The honeycomb lattice of graphene ... is not a Bravais lattice. Instead, it can be viewed as bipartite lattice composed of two interpenetrating triangular sublattices ...

the single-particle electron states are ... two classes, called sigma and pi.

The even sigma states are derived from carbon s and px , py orbitals (i.e., their hybridized sp² orbitals ...),

while **the odd pi states are derived from carbon pz orbitals** ... electron and hole states in graphene should be interconnected, exhibiting properties analogous to the

charge-conjugation symmetry in quantum electrodynamics ... because graphene low-energy quasiparticles have to be described by two-component wave functions ... which are needed to define the relative contributions of the A and B sublattices in the quasiparticles make-up. The two-component description for graphene is very similar to the [Dirac Equation] spinor wave functions in QED...”.

I. Katsnelson, K. S. Novoselov & A. K. Geim, in Chiral tunnelling and the Klein paradox in graphene (arXiv cond-mat/0604323), said: The ... Klein paradox - unimpeded penetration of relativistic particles through high and wide potential barriers - ... can be tested ... using electrostatic barriers in single- and bi-layer graphene. Due to the chiral nature of their quasiparticles, quantum tunnelling ... becomes ... qualitatively different from ... normal, non-relativistic electrons. ...

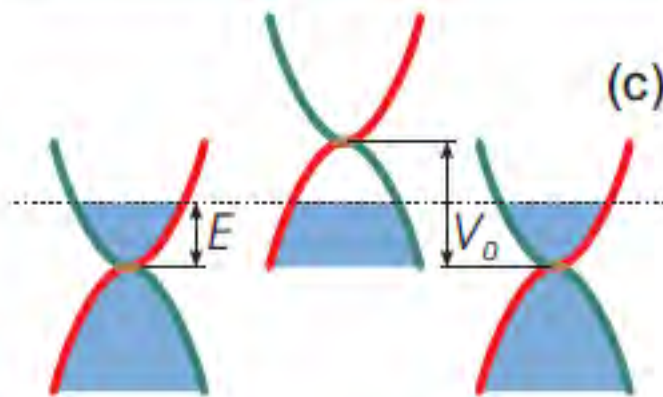
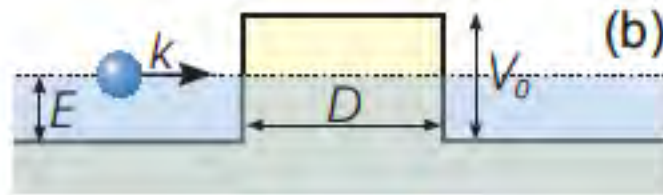

... Tunnelling through a potential barrier in graphene: ... (b) ... diagrams ... show the positions of the Fermi energy E across such a barrier. The Fermi level (dotted lines) lies in the conduction band outside the barrier and the valence band inside it. The blue filled areas indicate occupied states. The pseudospin ... is parallel (antiparallel) to the direction of motion of electrons (holes), which also ... keeps a fixed direction along the red and green branches of the electronic spectrum. (c) - Low-energy spectrum for quasiparticles in **bilayer graphene**. The spectrum is isotropic and, despite its parabolicity, also originates from the intersection of energy bands formed by equivalent sublattices, which ensures charge conjugation, similar to ... single-layer graphene. ... charge carriers in bilayer graphene ... are massive quasiparticles with a finite density of states at zero energy, similar to conventional nonrelativistic electrons. On the other hand, these quasiparticles are also chiral and described by spinor wavefunctions, similar to relativistic particles or quasiparticles in single-layer graphene ... the origin of the unusual energy spectrum can be traced to the crystal lattice of bilayer graphene with four equivalent sublattices. ... **the relevant QED-like effects appear to be more pronounced in bilayer graphene ...**”.

If each Palladium atom were to be connected to 14 other Palladium atoms then the result would be a 3-dim FCC Lattice with Rhombic Dodecahedron Vertex Figure



However, it may be that the Rhombic Dodecahedron FCC Lattice is only metastable and

more stable state may be based on its dual, the Cuboctahedron

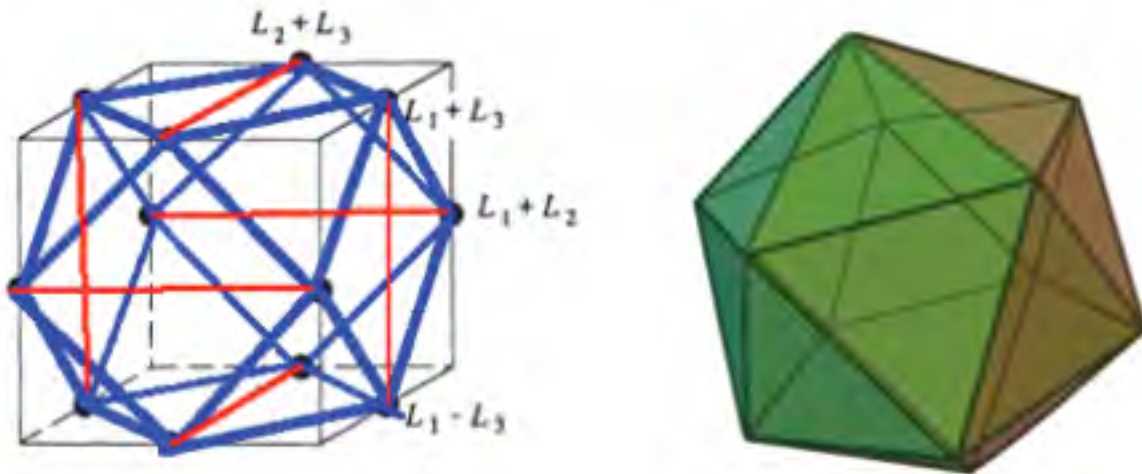

which can transform by Jitterbug Transformation into an Icosahedron.

Just as Graphene directly uses 3 of the 4 Carbon electrons
the Cuboctahedron / Icosahedron directly uses 12 of the 14 Palladium electrons.

Just as the 4th Carbon valence electron in Bilayer Graphene produces a Dirac Fermion band with Klein Paradox Tunneling through Potential Barriers
the $14 - 12 = 2$ Palladium valence electrons produce a **Dirac Fermion band** which, using Klein Paradox Tunneling through Potential Barriers, enable TSC Fusion of Deuterium in Palladium Cluster structures.