

# Quantum Gravity and Electro Magnetic forces by dual repulsive vacuum oscillation spectra in FFF-theory.

Leo Vuyk,  
Architect,  
Rotterdam, the Netherlands.  
[LeoVuyk@Gmail.com](mailto:LeoVuyk@Gmail.com)

## **Abstract,**

Quantum FFF ( Function Follows Form) theory states, that the vacuum is seeded with fast oscillating massless Higgs particles, oscillating along a complex chiral tetrahedral vacuum lattice, which has the ability to transfer Photon and Graviton information in bunches of oscillations, through the vacuum lattice with the local (mass related) speed of light.

As a consequence there are no attraction forces on propeller shaped Fermions.

Only the sum of the different kinds of vacuum impulses by zero point Casimir effects in combination with the local vacuum oscillation spectrum coming from all directions on Fermions are responsible for all energetic phenomena in the universe.

As a consequence New physics will be needed and the introduction of Quantum based monopole radiation fields like the electric and magnetic fields.

The gravity around Black Holes is assumed to be based on the zero point oscillation spectrum only without the opposing repulsive gravitons. Black holes don't emit gravitons because according to Q-FFF theory, they are massless and harbour a nucleus of massless Higgs like Quantum knots only able to absorb the incoming oscillating vacuum particles.

All Star-Planet systems are supposed to be stabilised by at least two polar local black holes. These black holes polarize the vacuum around the sun with butterfly shaped vector bubbles around test masses like planets and even fermions.

As a consequence, in the middle of these solar Anchor black holes (SABHs) the gravity around the sun has a relative instantaneous relation with the gravity centre of the sun.

## **Introduction.**

According to Le Sage gravity the vacuum is seeded with fast travelling corpuscles, impinging on mass carrying particles present inside massive bodies. The deflection of these vacuum particles after the impulse on the first body, should lead to a decline in vacuum pressure on a second object, tending to drive two bodies together.

However, we suggest, that the vacuum is seeded with fast oscillating energetic but massless Higgs alike particles, oscillating along a complex chiral tetrahedral vacuum lattice, which has the ability to transfer Photon and Graviton information in bunches of oscillations, through the vacuum lattice with the local speed of light.

As a consequence there are no attraction forces on the propeller shaped spinning Fermions. Only the sum of the different kinds of vacuum impulses from all directions on Fermions coined: “**Double Vector Hedgehogs**”, are responsible for all energetic phenomena in the universe.

We may call the local double vector Hedgehog also: a dual repulsive vacuum oscillation spectrum with a constant a-symmetrical zero point Casimir effect, able to insert attraction and repulsion forces on Fermions.

The Lorentz forces need however also a Magnetic curving force.

Thus we could give such a gravity model the name: “**Double Le Sage gravity**”.

Fermions are assumed to be fast spinning 3 Dimensional propeller shaped strings, able to deform impinging Higgs particles into 5 different shaped 3-Dimensional Photon/Gluon particles and Gravitons. (Figure 1,2 and Ref. 3,4).

**In contrast with the contemporary “standard model”**, we count two Gluon/Photons (coded: LOL+ROR) for the electric quantum force, two Gluon/Photons (LOU+ROU) for the magnetic quantum force and one Gluon/Photon (UOU) as general particle for the x-ray, gamma ray and different light frequencies.

The 5 different shaped Gluon particles (Ref.3,4) are in contrast with Gravitons, supposed to be able to merge with Fermions into more complex compound Fermion particles (Quarks, including Muons and Tau Fermions). However if no Fermions are hit, then after a very short (Planck) distance the Gluon information is picked up and transferred as 5 different coded Photon information or as a Graviton encoded information, by the Higgs system simultaneous along different Lattice routes in the form of a bunch of entangled Higgs oscillations. (figure: 3) This is our proposal for the explanation of the so called particle-wave duality.

The bunch of Higgs oscillations can impinge somewhere on a new Fermion and then the Photonic bunched wave function will COLLAPSE and change back into one Gluon particle, able to merge with the Fermion and originate measurable atomic change.

All Star-Planet systems are supposed to be stabilised by at least two polar local black holes. These black holes polarize the vacuum around the sun with butterfly shaped vector bubbles (figure 22)

**As a consequence, in the middle of these Solar Anchor Black Holes (SABHs) the gravity around the sun has a relative instantaneous relation with the gravity centre of the sun and is supposed to have an instant effect.**

**As a result, the speed of gravity ONLY around the sun exceeds the speed of light.**

**The 3 dimensional structure of the repulsive butterfly shaped oscillating Higgs field vacuum vector bubbles is supposed to be the origin.**

Explanation of the codes:  
 U= Up rotation (180 degrees)  
 O= Unchanged circle.  
 L= Left rotation (90 degrees)  
 R= Right rotation (90 degrees)

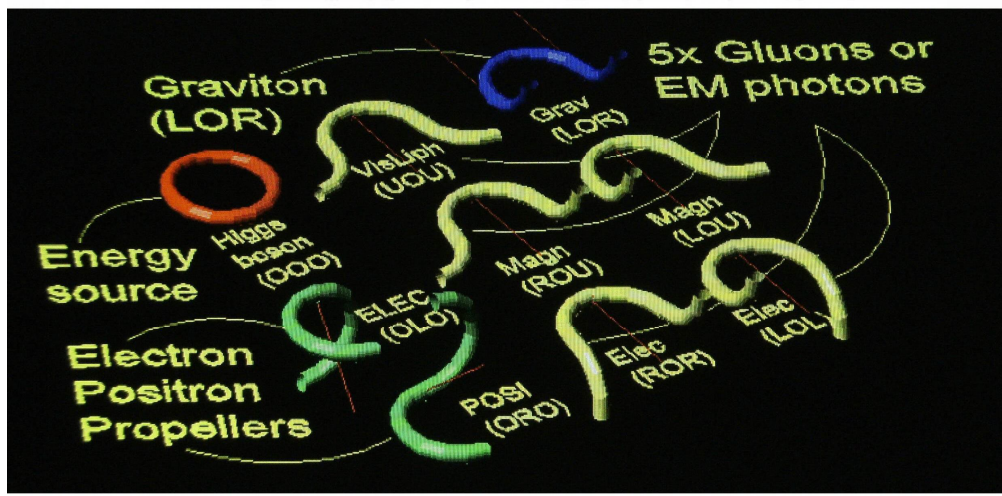
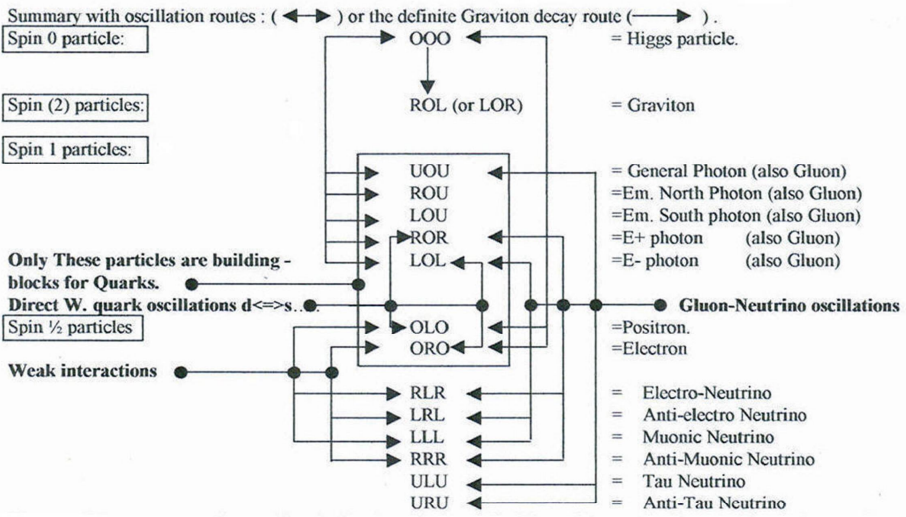
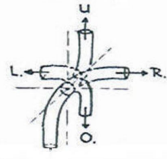
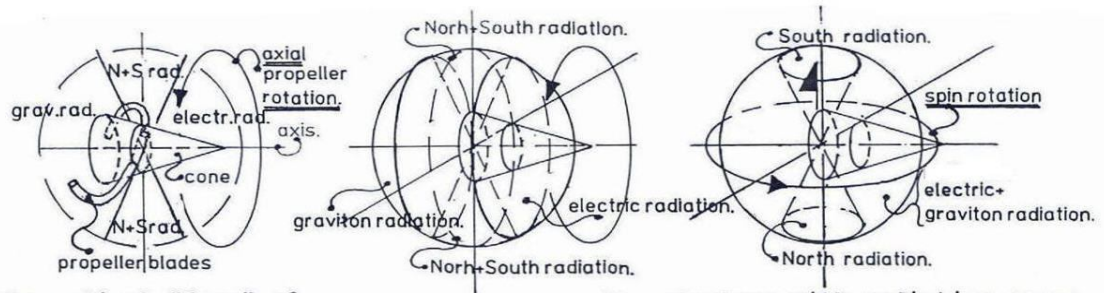

Figure 1, 3-Dimensional String Based Alternative Particle Model. (Ref. 3)



Theoretical "form" of the electron, with radiation cones due to axial rotation.

The electron with radiation cones due to circular or "spin" rotation and axial rotation.

Figure 2, Double axial spin of Fermions with monopole Gluon- Graviton radiation cones. (Ref.3) After a short distance the 5 string shaped Gluons (2 Electric, 2 Magnetic and one



general) can merge with Fermions into compound Quarks, or become a photonic wave, just like the Graviton.

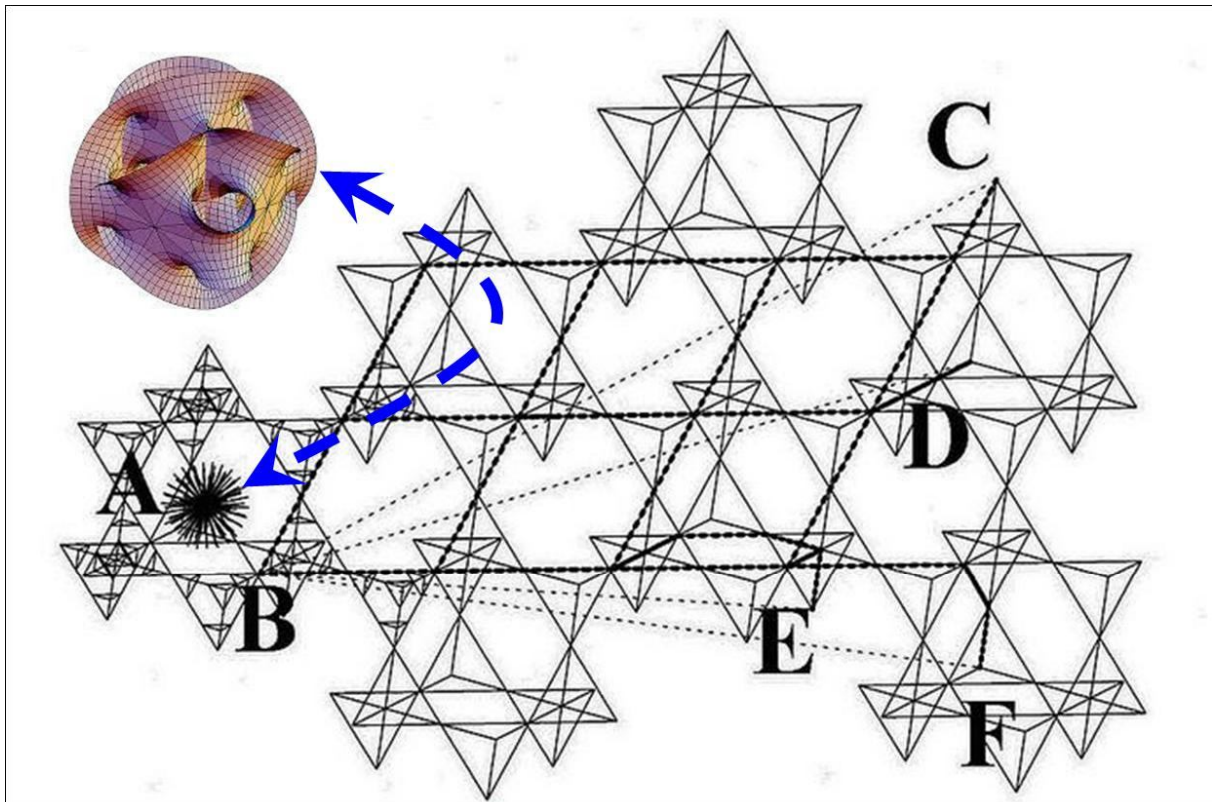

**Photon trajectories through the tetrahedral oscillating Higgs vacuum lattice. (Acc. to Quantum FFF Theory)**

A: a real shaped Photon is created by Higgs collision with a dual axis spinning (Calabi Yau) Fermion propeller.

B: that Photon transfers CODED form information (monopole photon info) and direction information into one Higgs particle which transfers this information by mutual Higgs collisionary oscillations through the vacuum in one specific direction.

C,D,E, or F.

I: Only magnetic photonic information ( 2x : North and South) are subject to curvature by an undisturbed symmetric oscillating vacuum

II: Local Anti-Symmetric Oscillating vacuum Frames are influenced by massive objects like the earth and responsible for semi relativistic effects.

III The vacuum lattice has helix- or chiral quality being the origin of our material universe.

**Figure 3**, Photon (bunch shaped) trajectories, through the Higgs vacuum lattice. (Ref. 4)

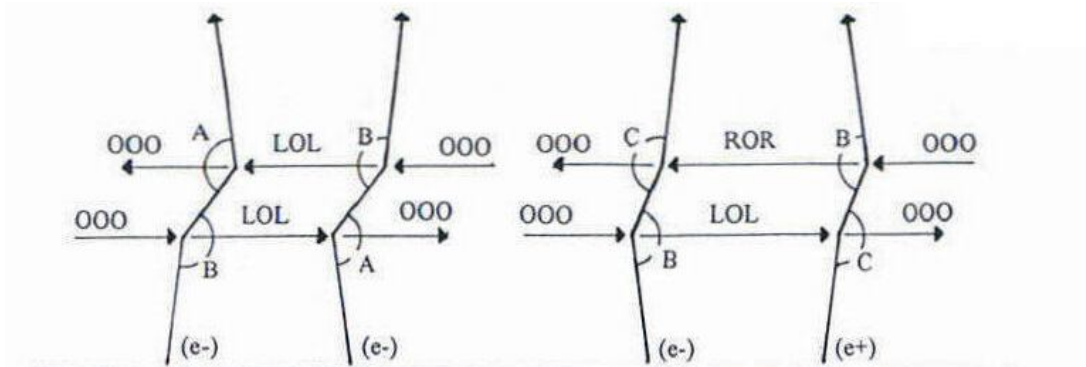

**Figure 4,** The principle of electric field force transfer by two monopole electric Photons (LOL and ROR) pushing Fermions with different impulses between two equal charged Fermions and different charged Fermions. The impulse of the Higgs particles is supposed to play an important role in combination with the monopole Photons to deflect the Fermions out of their trajectory.

A comparable system is supposed to be active for Gravitons. (Figure 7)

Feynman diagram for Electron Positron attraction, compared with Quantum FFF Theory repulsion solution.

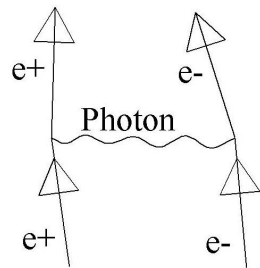

Higgs Impulse diagram for ELECTRIC monopole radiation, according to Quantum FFF theory.

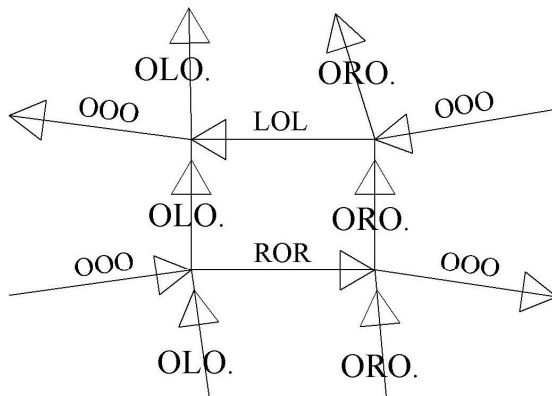

Fermionic impulse differences between Higgs (OOO) and TWO Electric monopole Gluon/Photons (LOL and ROR) on Fermions (OLO and ORO).

OOO changes form after collision with OLO resp ORO into ROR resp LOL and after second collision back again into OOO.

**Figure 5,** Comparison between electric Feynman diagram and Q-FFF Theory

Higgs Impulse diagram for MAGNETIC monopole radiation, according to Quantum FFF theory.

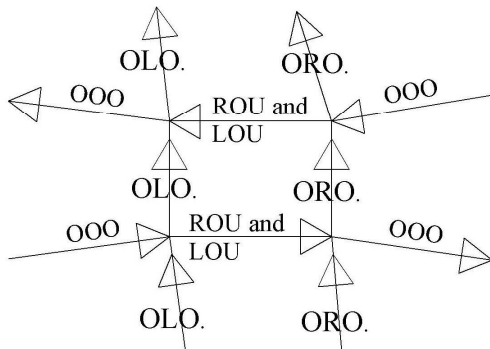

Fermionic impulse differences between Higgs (OOO) and TWO Magnetic monopole photons (LOU and ROU) on Fermions (OLO and ORO).  
 OOO changes form after collision with OLO resp ORO into ROU and LOU and after second collision back again into OOO.

Figure 6,

Higgs impulse diagram for Double LeSage Gravity, according to Quantum FFF theory.

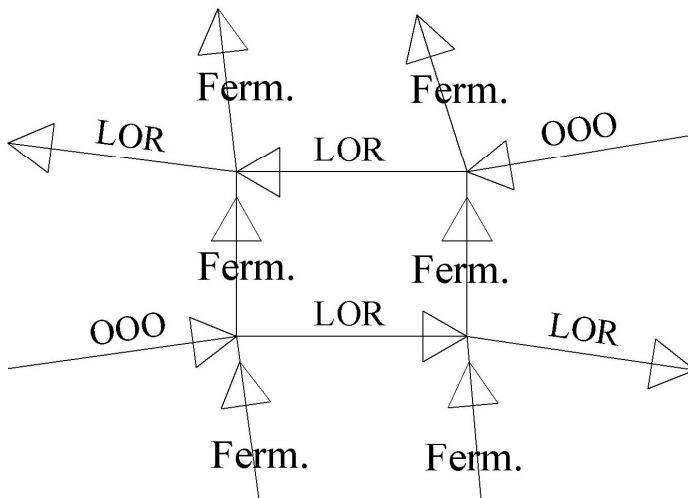

Fermionic impulse differences with Higgs (OOO) and pushing Gravitons (LOR).  
 OOO changes form after collision into LOR.  
 Gravitons don't change shape after collision.

Figure 7, The principle of the Double Le Sage gravity force transfer between two Fermions. The impulse of the Higgs particles is supposed to be larger than the Graviton Impulse.



Quantum Gravity as pressure distribution of the oscillating dual Higgs/Graviton vector field.

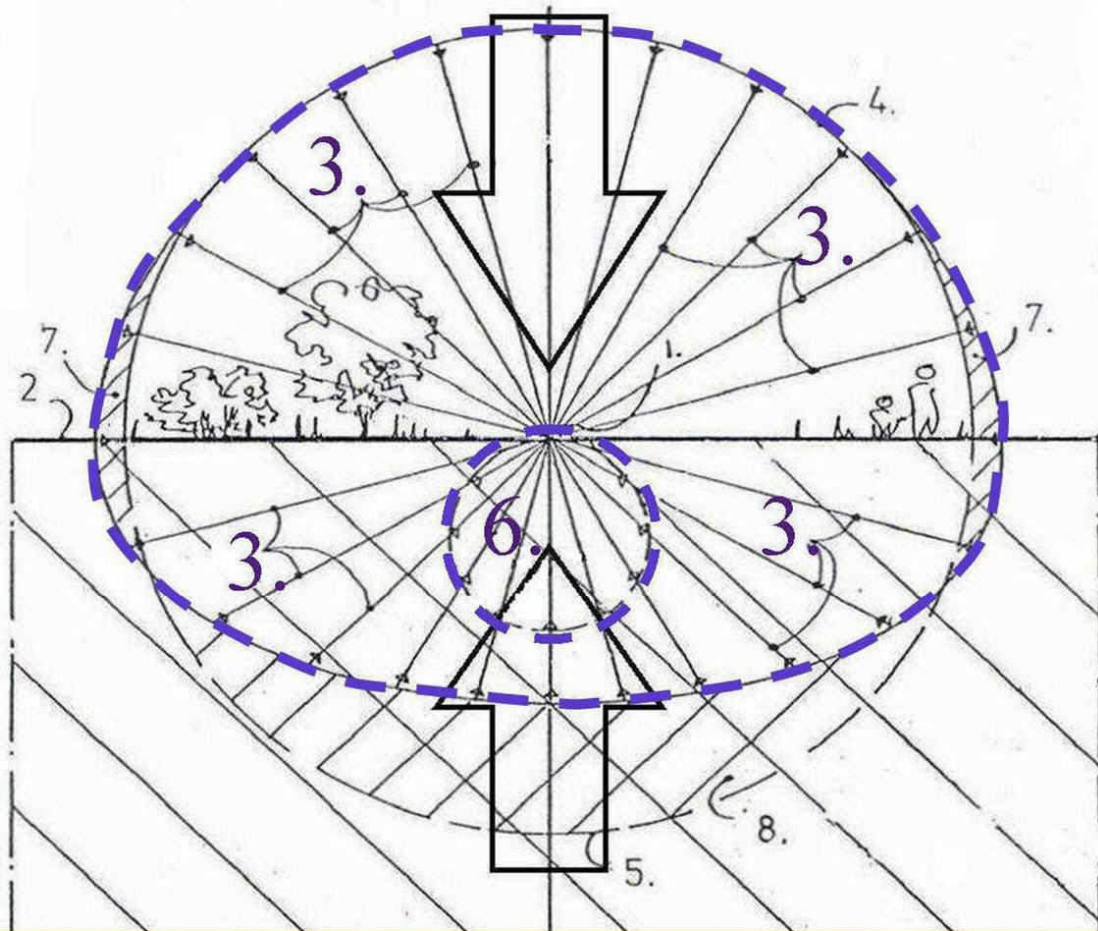

Cross section through the dual Higgs/ Graviton 3D vector field pressure distribution (or globular Hedgehog) on a point mass (1) located on earth's surface (2), according to Quantum FFF theory.  $3+4=$  Higgs vector field.  $6=$  Graviton vector field originated by the Higgs-graviton field transformation of the earth itself.  $7+8=$  differences with a perfect globular vector distribution. Field variables  $3+6$  are rendered as inversed arrows. (see also black hole pressure distribution without gravitons)

**Figure 8,** Cross section of the “**Double Vector Hedgehog**” of pushing forces around Fermions. The difference between Higgs vacuum pressure (3) and less effective Graviton pressure (6) on Fermions are the basic elements of Double Le Sage gravity.

Higgs/Graviton pressure vector hedgehogs acting on a mass carrying Quantum particle. The irregular distribution of mass inside the earth is supposed to influence the 3D pressure vector hedgehog according to the new Double LeSage gravity paradigm, see image below.

Author Leo Vuyk.

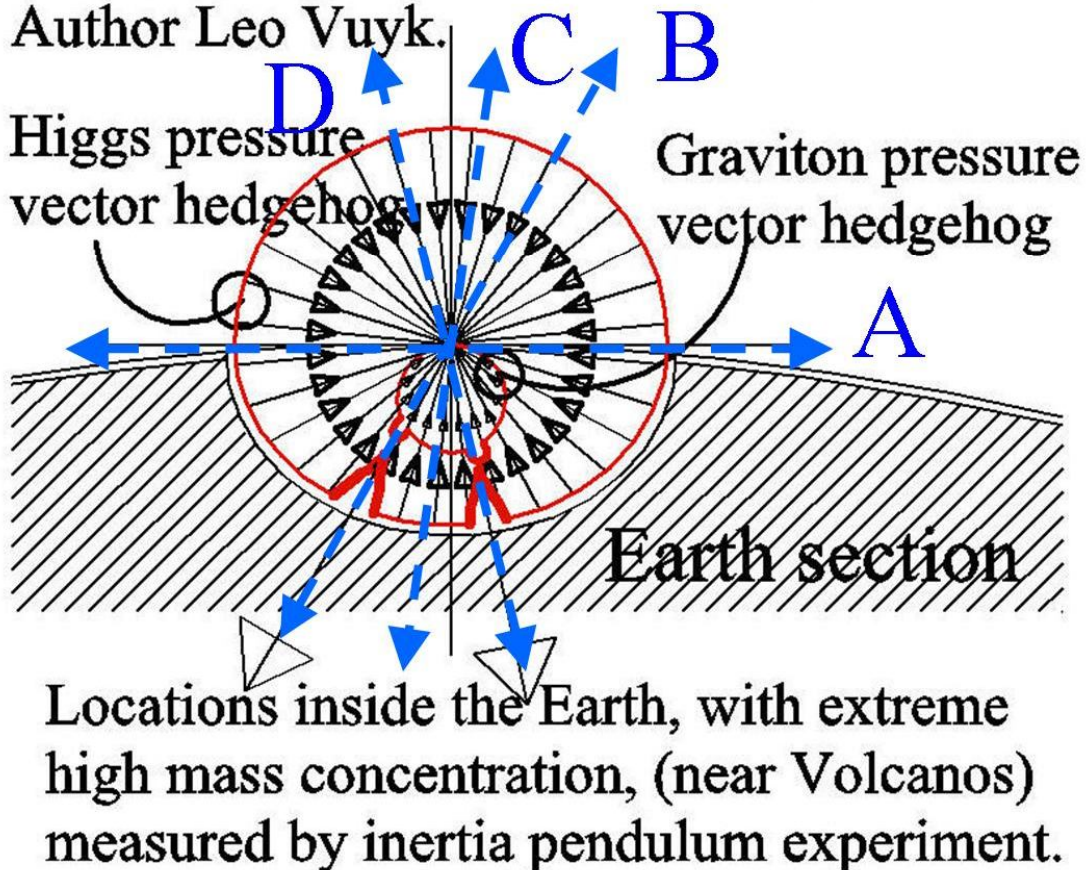
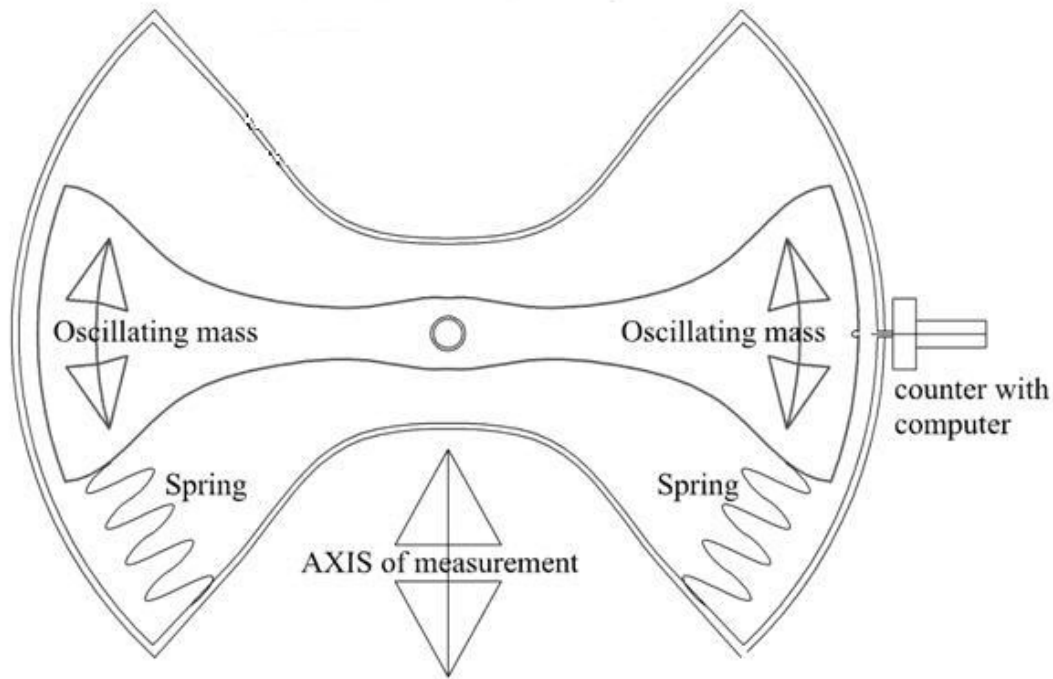

**Figure 9,**

The “Double Vector Hedgehog” related to mass concentrations in the earth.

Oscillation directions: A,B,C and D will give larger damping differences as expected by Newtonian gravity rules, if we use a new Inertia oscillator device, presented in figure (10).





**Figure 10,** Cross section through the inertia oscillator for the search of mass concentrations inside the near earth and as a test for double Le Sage gravity.

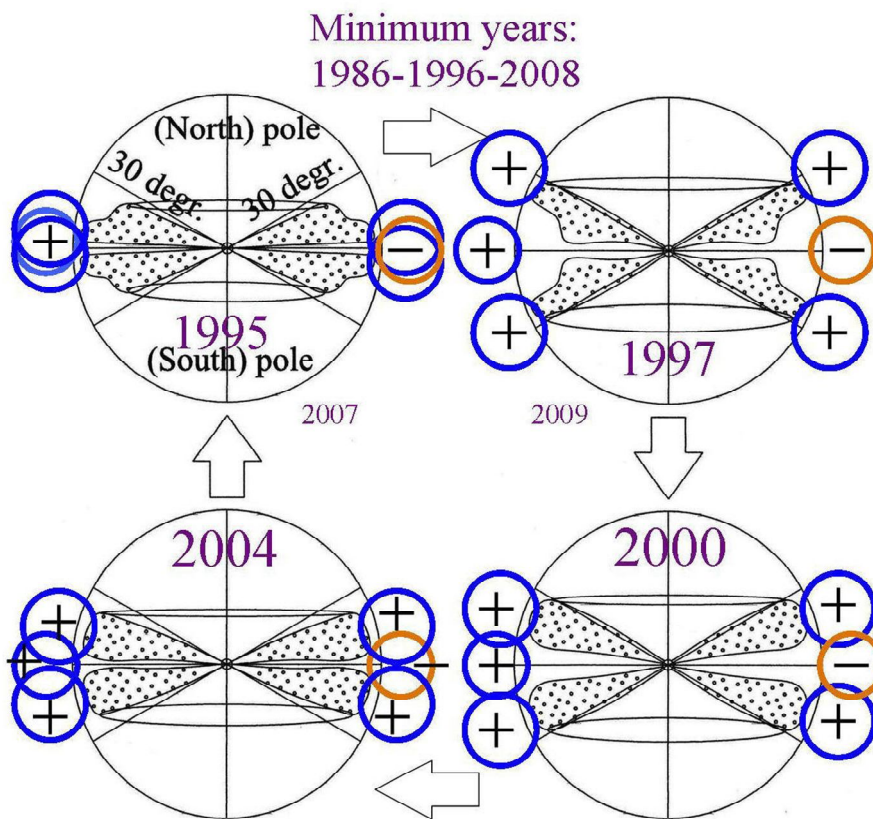

**Figure 11,** Cross section through the sun with the sunspot (micro black hole) distribution in two mirror symmetrical double cones, changing shape with the 11 year sunspot cycle. The gravity influence of the double cones together with the solar rotation (blue and yellow ring area) is supposed to be the origin of Solar eclipse gravity variation of the measurements.

Well documented solar eclipse gravity variation measurements are made by different scientists in the past years. After years of measurement, it seems to be impossible to find a scientific base for the different results.

However if we assume that Sunspots are micro black holes, (Ref. 2) able to drag and influence the Higgs vacuum pressure distribution around the sun, then we may have a clue.

We assume that the sunspot distribution has a double cone shape inside the sun, as depicted in figure 11.

**ALTERNATIVE MAGNETIC FIELD INTERPRETATION.**

If magnetic field lines have a quantum mechanical origin, based on alternative magnetic monopole photons (with a North or South characteristic and a slight "photonic trajectory CURL") then the picture below could represent the origin of a "Magnetic vector potential (A)" around an electric current e.g. in a wire.

This magnetic CURL is supposed to have the same origin as assumed for the DIFFRACTION process (of light): "Settlement" of photonic information routing inside the local microscopic Higgs vacuum lattice.

It is assumed that the photonic CURL in the photonic vector field will change due to wire bending.

The Curl will be able to decrease down to zero curl, at the outside turn of a bended wire, (e.g. see position: a) If this is the case, the magnetic field (called the B field) will vanish completely around a long small solenoid. Inside a wire bending however, the Curl will consequently increase.

Conclusion, the proposed two force carriers (photons: North and South) are able to explain the peculiar qualities of the so called Magnetic Vector Potential field (A). (Author L.Vuyk)

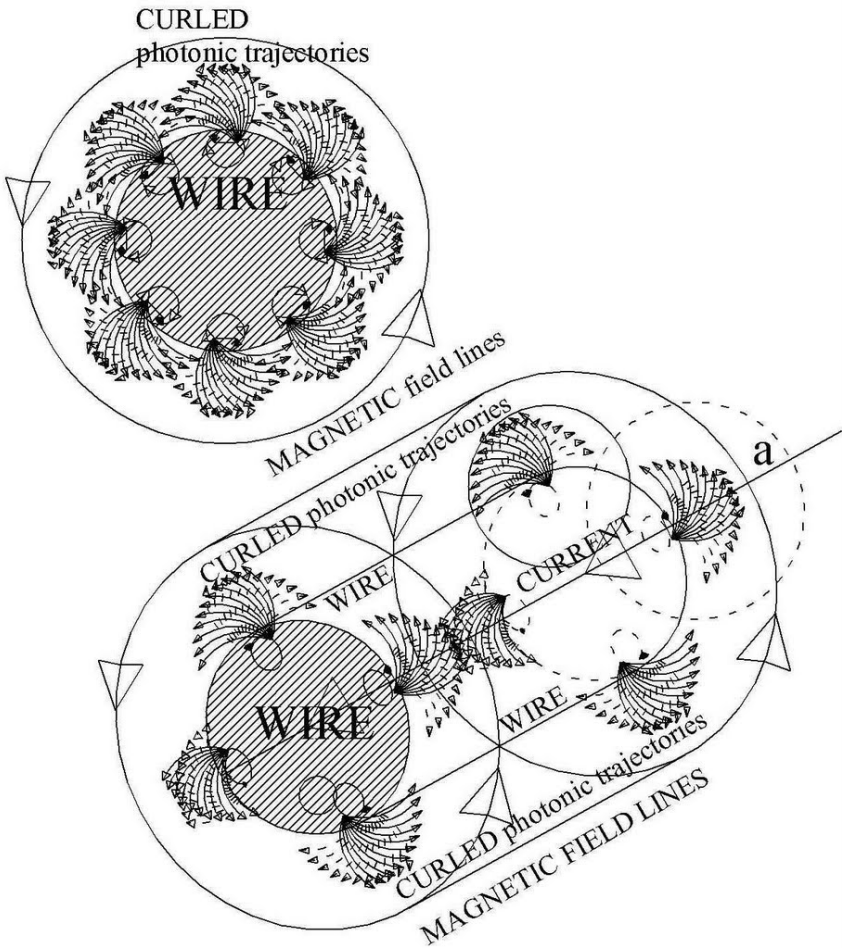

Figure 12, Alternative magnetic field by “curled Photonic monopole information around an electric wire under current.

ALTERNATIVE magnetic field interpretation based on two different magnetic photons ( N and S) with boundary layer elevation indication.

If magnetic field lines have a quantum mechanical origin, based on alternative magnetic monopole photons (with a North or South characteristic and a slight "CURL") then the picture below represents the differences with the traditional view.

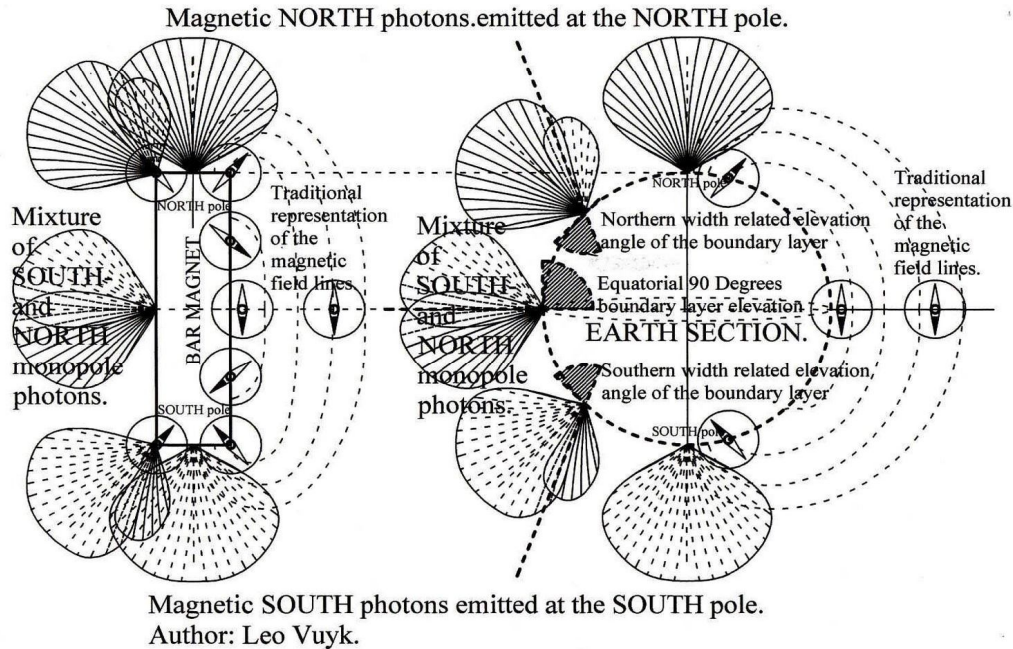

Figure 13,

Alternative magnetic field interpretation , based on two different magnetic Photon/Gluons ( North and South) with different boundary Layer elevation indications.

The 5 Gluons ( Fig.1) are supposed to be the same as Photons however with different appearances.

Gluons are supposed to be real 3-Dimensional strings, able to “click-on” to Fermions and form Quarks.

Photons are supposed to come only in wave form, as monopole information bunches travelling with the local speed of light along the mass-less oscillating Higgs vacuum lattice.

The are transformed Gluons

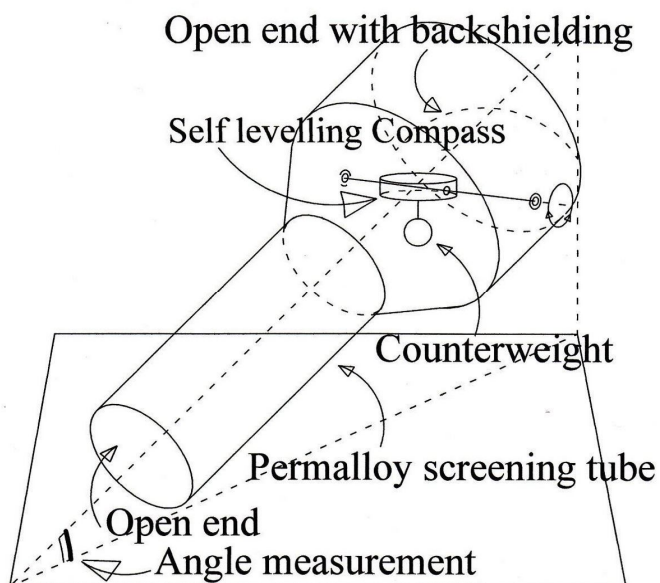

Figure 14,

3-Dimensional representation of the magnetic monopole telescope, able to show differences in the monopole Photon trajectories (with North or South characteristic) around the earth.

The screening tube with back shielding, is made of permalloy or mu-metal. The compass is a simple hobby compass balancing on copper bolts. Angle measurement is done, only if the compass needle points into a heading



perpendicular to the axial symmetry axis of the tube. See the result on figure 15.

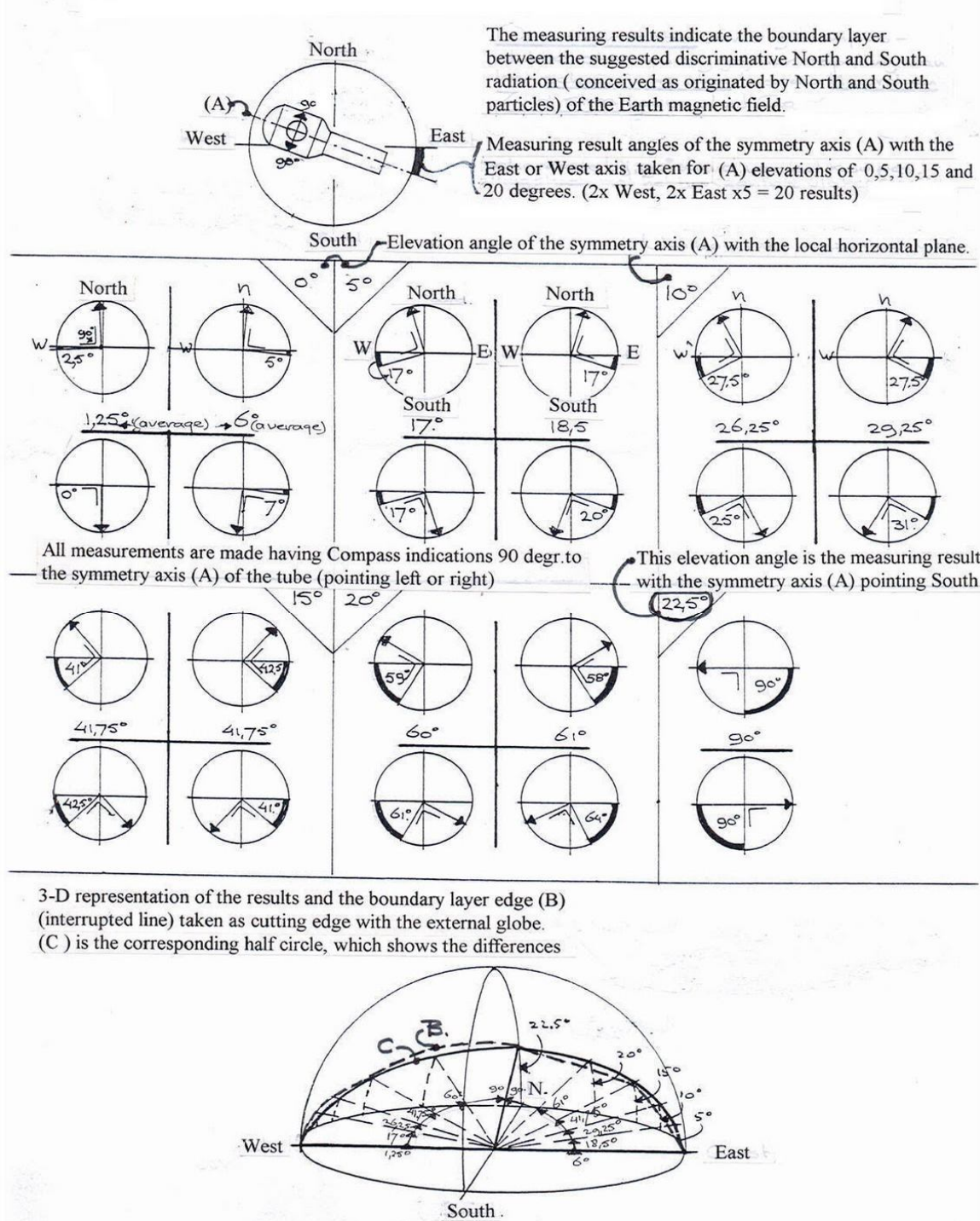
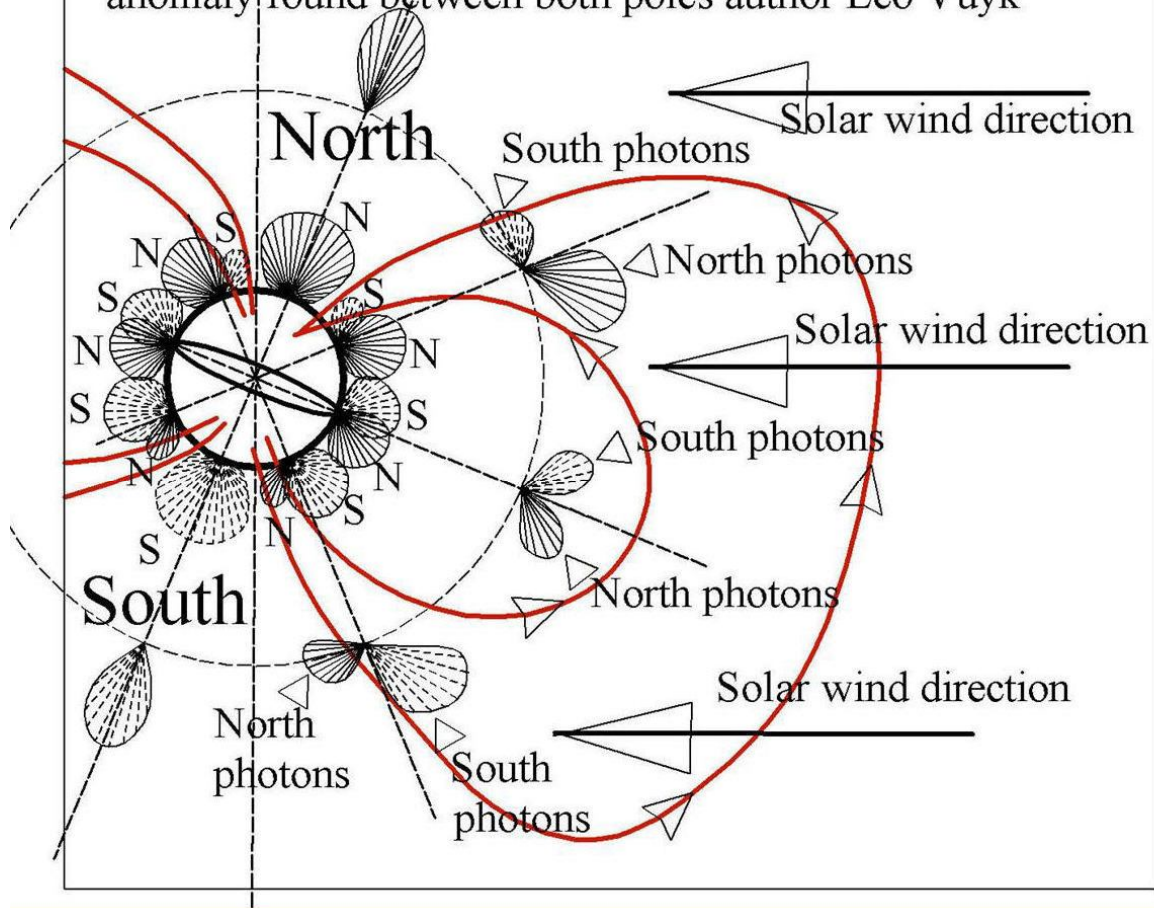

**Figure 15,**  
3-Dimensional representation of the “boundary layer” B, between the North and South monopole radiation of the earth, is the result of multiple measurements by the magnetic telescope at location, Latitude: 52,18 degr. North and Longitude degr. 5,2 East.(see: figure 14).

It is assumed that every location on earth has its individual **boundary layer Curve B.**

It is also assumed that **animals like Pigeons and sea Turtles are able to identify these specific curves (B) for different locations by the small amount of permalloy alike metals already found in their bodies, to explain the extraordinary qualities of animal orientation.**

North and South magnetic monopole photon arrays in vector bubble form around the earth surface and in space. The origin of the anti-Symmetrical Aurora anomaly found between both poles author Leo Vuyk



Section through the earth with magnetic monopole photon arrays in vector form. The Magnetic curl effect in space is influencing the vector bubble directions and shapes. Date 12-01-2012.

**Figure 16, North and South monopole photon vector arrays around the earth.**  
 The North photon angle of attack and concentration on the Solar wind charged particles is assumed to be the origin of the recently found anti-symmetry of aurora effects in the summer.

Polar Auroras do occur at the same time in northern and southern polar regions at locations connected by geomagnetic field lines, a connection that might be expected to link patterns, positions and timing of the two aurora.

However this is found to be not the case!!

**See: Asymmetric auroral intensities in the Earth's Northern and Southern hemispheres**

K. M. Laundal & N. Østgaard. doi:10.1038/nature08154.



## Magnetic field variations by the “Curl” of Magnetic Monopole (N and South) Radiation around a wire and the earth.

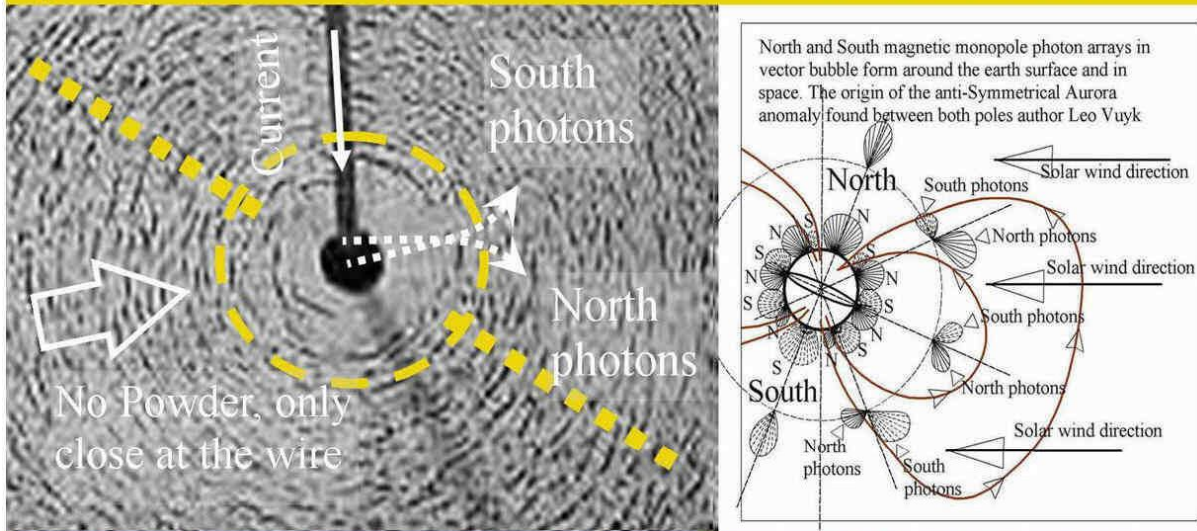

According to Quantum FFF theory, all magnetic fields can be presented as DUAL Magnetic Monopole Photon Vector Arrays. These monopole arrays undergo curvature. As a result, the magnetic field intensity around the Earth and a wire is NOT dropping off with the square of the distance from the source!! The field become stronger polarized away from the source (See images). Close to the current transporting wire the magnetic field strength is zero due to the parallel trajectories of North and South Photons before curvation and polarisation of iron powder ( Author: Leo Vuyk)

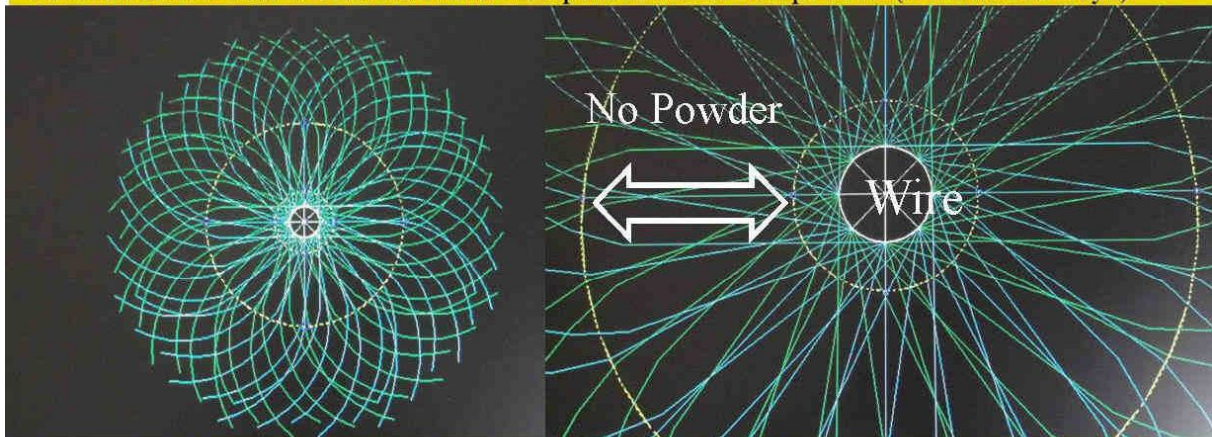

TWO (North and South) Monopole Photon trajectories around a current in a wire shown in cross section. Between the two yellow circles both (N+S) trajectories are pointing about parallel. The result: No iron Powder orientation between the concentric circles, as is observed in the lab (see upper photo). This is a firm support for the monopole photon vector array element of Quantum FFF Theory.

**Figure 17, Magnetic Field intensity is only at polar regions dropping with the inverse cube of the distance from the source.**

However the so called CURL of the magnetic vector arrays around the earth, permanent magnets and around current bearing wires, is the origin of a strange anomalous less pronounced drop of the field strength related to the source.



Synchrotron radiation by Polarized Fermion spin combined with high speed motion through the resistive oscillating Higgs vacuum (according to Quantum FFF theory)

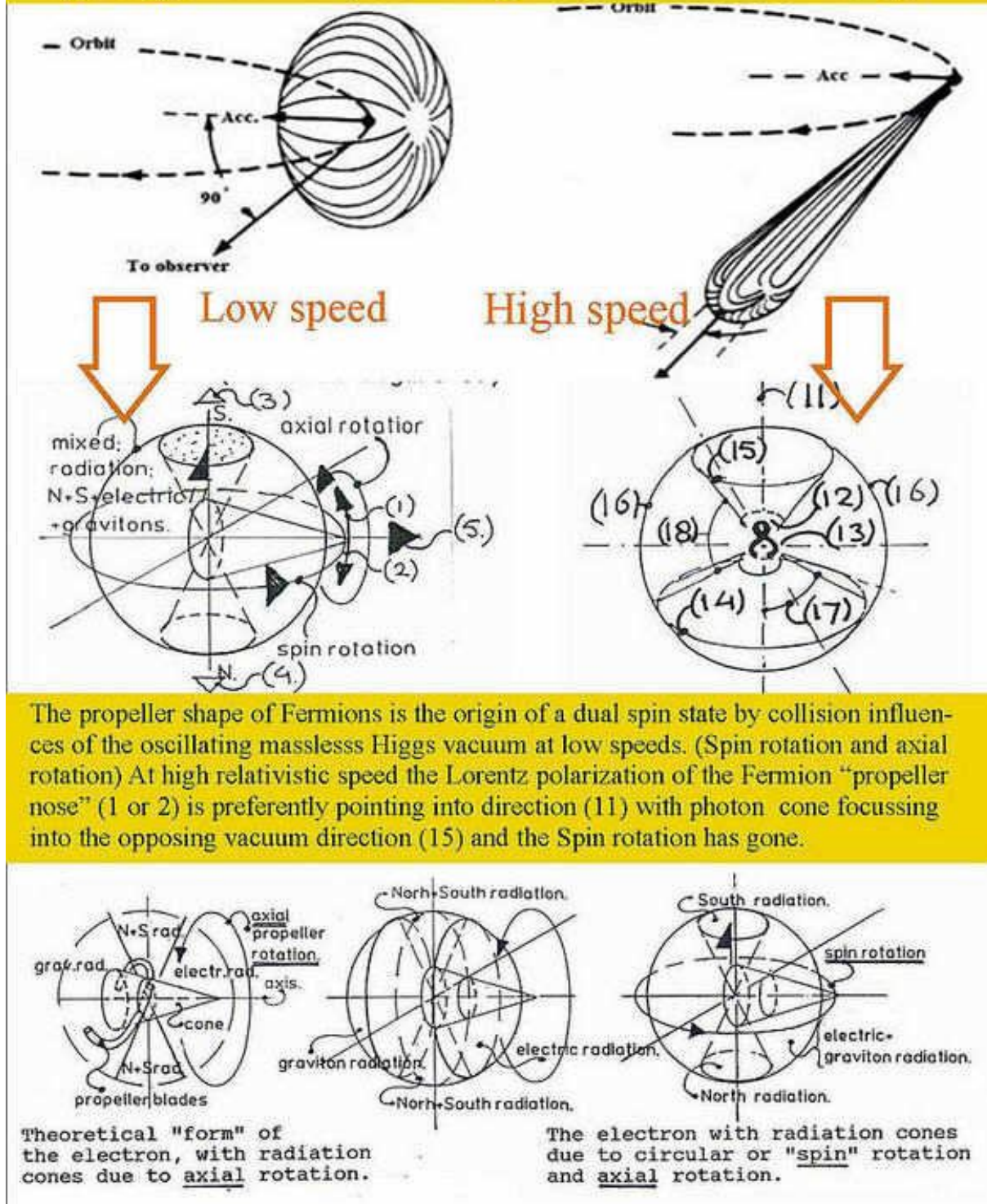
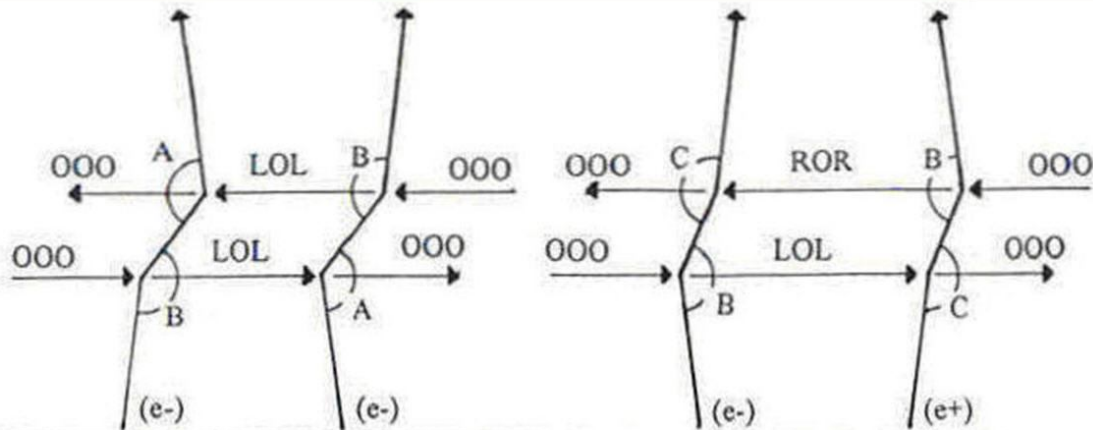

Figure 18, Examples of how the double spinning Fermions are reacting on the oscillating massless dark matter Higgs vacuum in the case of relative speed and gravity.





Alternative Feynman diagrams with additional ZPE vacuum Higgs impulses, combined with electric and magnetic monopole photon impulses, according to Quantum FFF Theory



Higgs (OOO), Neg. Photon (LOL) Pos. Photon (ROR) all change form after collision with Fermions

Higgs impulse diagram for Double LeSage Gravity, according to Quantum FFF theory.

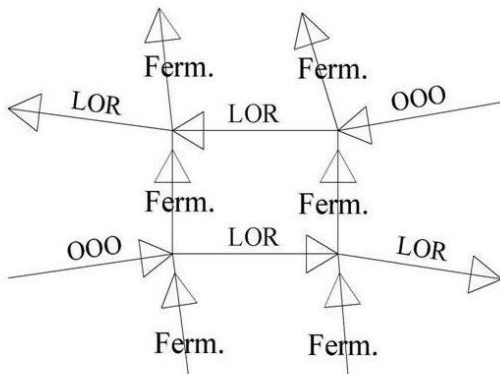

Fermionic impulse differences with Higgs (OOO) and pushing Gravitons (LOR).  
OOO changes form after collision into LOR.  
Gravitons don't change shape after collision.

Higgs Impulse diagram for MAGNETIC monopole radiation, according to Quantum FFF theory.

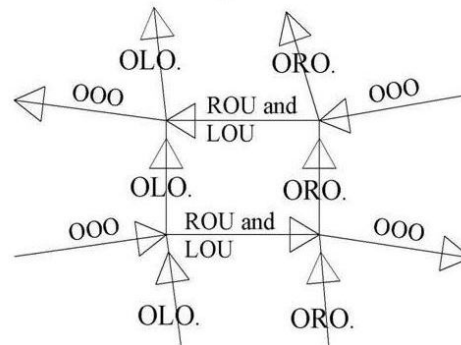

Fermionic impulse differences between Higgs (OOO) and TWO Magnetic monopole photons (LOU and ROU) on Fermions (OLO and ORO).  
OOO changes form after collision with OLO resp ORO into ROU and LOU and after second collision back again into OOO.

Quantum Gravity (left) and Magnetic forces (right). Vacuum Higgs Chirality and particle geometry and spin plays an important role

Figure: 21,



A hotspot for powerful cosmic rays found under the Big Dipper, by the University of Utah. The mysterious source of cosmic rays is also reason to look at the southern hemisphere to observe the opposing second Stellar Anchor Black Hole (SABH) (Cosmic ray production by NEW black hole paradigm according to Quantum-FFF Theory).

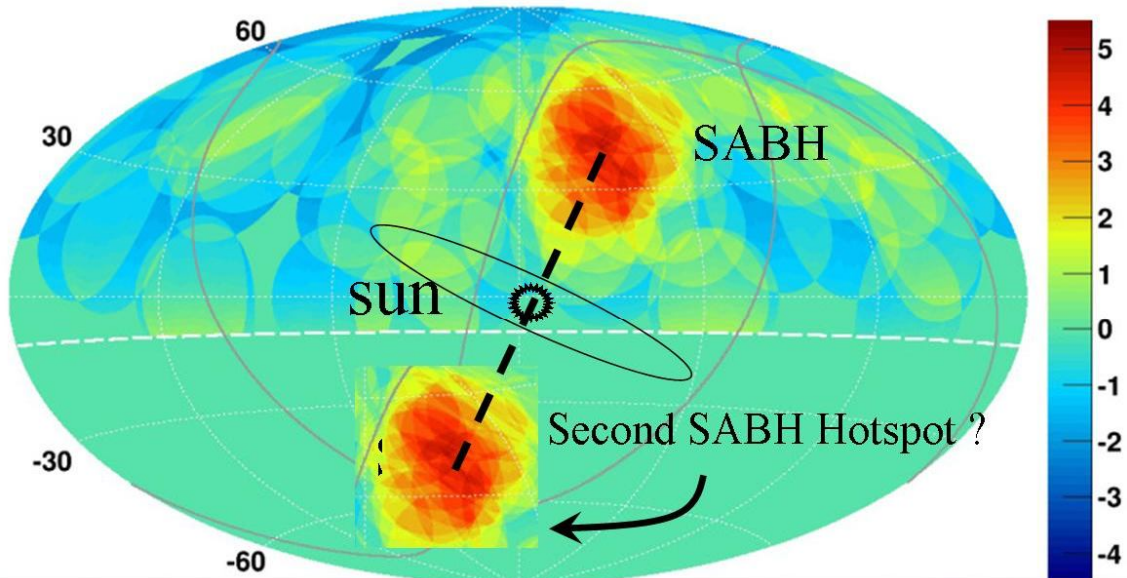

According to Quantum FFF Theory, “New Black Holes produce Proton– Electron plasma. By the strong Casimir vacuum push gravity on the BH, the “Lighter” electrons will stay outside the “heavier” proton horizon (blue). As a consequence BHs have a strong electric potential, which is liberated by asymmetric processes in dual BH systems like Herbig Haro objects showing strong electro magnetic effects in open cluster star formation and Birkeland Alfvén circuits around the earth and even in the so called BICEP 2 results.

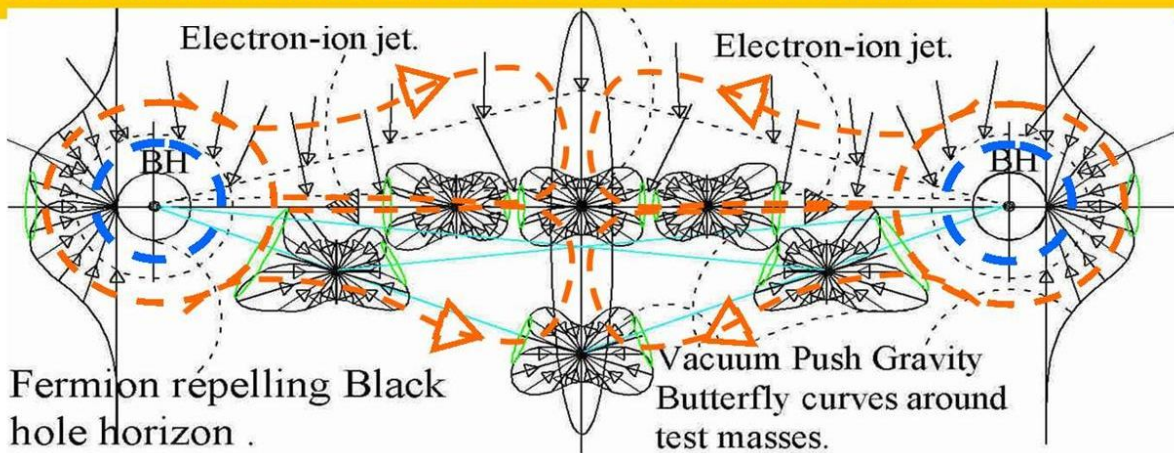

**Scheme of the electric SABH principle around the sun.**

Figure: 22, The speed of gravity ONLY around the sun exceeds the speed of light and is supposed to have an instant effect.

The 3 dimensional structure of the repulsive butterfly shaped oscillating Higgs field vacuum vector bubbles is supposed to be the origin.

## References:

[1] [viXra:1103.0015](#) submitted on 5 Mar 2011

**Wavefunction Collapse and Human Choice-Making Inside an Entangled Mirror Symmetrical Multiverse.**

Authors: Leo Vuyk.

Category: [High Energy Particle Physics](#)

[2] [viXra:1103.0011](#) submitted on 3 Mar 2011

**An Alternative Black Hole, Provided with Entropy Decrease and Plasma Creation.**

Authors: Leo Vuyk

Category: [High Energy Particle Physics](#)

[3] [viXra:1103.0002](#) submitted on 1 Mar 2011

**3-Dimensional String Based Alternative Particle Model.**

Authors: Leo Vuyk.

Category: [High Energy Particle Physics](#)

[4] [viXra:1102.0052](#) 27 Feb 2011

**Construction Principles for Chiral "atoms of Spacetime Geometry".**

Authors: Leo Vuyk

Category: [Quantum Physics](#)

[5] [viXra:1102.0054](#) 27 Feb 2011

**Atomic Nuclear Geometry Based on Magic Number Logic.**

Authors: Leo Vuyk.

Category: [Nuclear and Atomic Physics](#)

[6] [viXra:1102.0056](#) 28 Feb 2011

**Experiments to Determine the Mass Related Lightspeed Extinction Volume Around the Earth and Around Spinning Objects in the Lab.**

Authors: Leo Vuyk.

Category: [Relativity and Cosmology](#)

[7] **The New God Particle and Free Will.**

By Leo Vuyk, LuLu publishers, 2008.

ISBN number 978-1-4092-1031-3