

## Can geometry produce work?

GR textbooks begin with a “massive body” ([Wikipedia](#)) that *somehow*, and for some unknown reason, would create particular [influence](#) in *non-flat* 4D spacetime (watch the clip [below](#)), and then “the [Christoffel symbols](#) play the role of the gravitational force field and the metric tensor plays the role of the gravitational potential”, etc.

Can non-tensorial [Christoffel symbols](#) produce **work**? What kind of “[influence](#)” is that? It doesn’t look like [electromagnetism](#). All we know for sure is that gravity can alter the [rate of time](#), as demonstrated in [GPS navigation](#) and [time dilation](#). But the *rate* of time ([W.G. Unruh](#)) cannot produce **work** either. If it could, it will be *physical* entity.

Let’s read the [experts in GR](#). Quote from John Baez and Emory Bunn, [The Meaning of Einstein’s Equation](#), January 4, 2006, Sec. [Spatial Curvature](#):

“On a positively curved surface such as a sphere, initially parallel lines converge towards one another. The same thing happens in the three-dimensional space of the Einstein static universe (cf. [Einstein 1918](#) and [Hubble](#) - D.C.). In fact, the geometry of space in this model is that of a 3-sphere. This picture illustrates what happens:

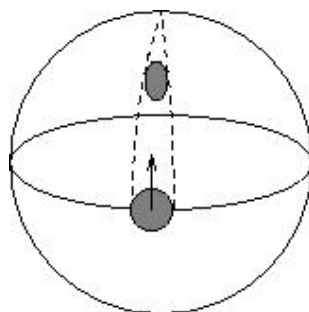

“One dimension is suppressed in this picture, so the two-dimensional spherical surface shown represents the three-dimensional universe. The small shaded circle on the surface represents our tiny sphere of test particles (say, an [apple](#) - D.C.), which starts at the equator and moves north. The sides of the sphere approach each other along the dashed geodesics, so the sphere *shrinks* (emphasis mine - D.C.) in the transverse direction, although its diameter in the direction of motion does not change.”

This last sentence may sound comprehensible only to my [dog](#). I can certainly see that “the sphere shrinks” in the drawing above, but the ‘shrinking’ *itself* cannot produce **work**. Apples are *physical* objects, not some fictitious “[vacuum](#)” devoid of matter. Let me offer an explanation of the question posed in the title.

Consider two kitchen scales, A and B, on a table at rest, and two apples on them, with different weight, say, an apple with 200g on scale A, and another apple with 400g on scale B. How would you relate their “[trajectories](#)” in 4D spacetime to the non-tensorial [Christoffel symbols](#), so that the former will produce different **weight**?

Obviously, an apple with weight 400g will resist [acceleration](#) *harder* than 200g apple. Obviously, *something* is doing work by pressing the scales A and B on the table.

### What is it?

If you can answer this question in [the framework of GR](#), you may discover the coupling of geometry to matter sought by [Felix Klein](#), [David Hilbert](#), and [Hermann Weyl](#), among many others. Also, you might (eventually) *vindicate* the claim by [Kip Thorne](#) and his [LIGO collaborators](#) about their “discovery” of so-called GW150914 (p. 13 in [Zenon](#)). You might also qualify for Nobel Prize for your astounding discovery of [renormalizable](#) perturbative quantum gravity based on “gravitons” with mass  $m_g \leq 7.7 \times 10^{-23} \text{ eV}/c^2$ : see the ground-breaking experiment proposed by Kip Thorne at p. 24 in [BCCP](#). Good luck.

If you cannot answer the question, read [Über Die Gravitationsfeldrelativitätstheorie](#). In a nutshell, gravity can produce [enormous work](#) (for example, [Earth tides](#)), but we need first to explain why we observe only one “charge” with [positive](#) energy density. This is totally unexplained puzzle, and theoretical physicists talk only about ‘positive mass conjecture’ (references are available upon request). The idea suggested in [GTR](#) is very simple: recall QM operators (*ibid.*, p. 7). They are *not* geometric points. They take some stuff, denoted **P**, at the input and convert it into *another* stuff Q at the output. The latter becomes *physical* stuff (Q), which is ‘geometric point’ that can be located at the apex of the [light cone](#). But **P** (from [Plato](#)) is *not* on the [light cone](#). We observe only Q-stuff, with [positive](#) energy density only. So, QM operators act  $P \rightarrow Q$ .

For comparison, consider another operator from particular pattern (Gesetzmäßigkeit): if I gently stroke [Linda’s head](#) (L), she will wave her tail (Q):  $L \rightarrow Q$ . In this case, I can track the entire sequence of events in  $L \rightarrow Q$  with light. Not so in QM: **P** is *physically unobservable* (pp. 6-7 in [BCCP](#)), as we know since 1935, thanks to [Erwin Schrödinger](#).

The *origin* of gravity is also  $P \rightarrow Q$ , because again we observe only Q-stuff, once at a time, as recorded with a physical clock: read [A4](#) on p. 4 in [GTR](#). Namely, the [Platonic](#) origin of quantum gravity (**P**) does *not* live on the [light cone](#). We can see with light only its waving *tail* (Q). People claim that the [trajectory](#) of the *physicalized* tail implies some non-flat 4D spacetime (watch the clip [below](#)). But we cannot see our Linda (**P**). She has *already* disappeared at the very instant of observation, just like [Macavity](#). See Escher’s ‘[drawing hands](#)’ and my note on the spacetime interval [here](#).

To sum up, the *origin* of gravity (**P**), called also ‘[John](#)’, does *not* act on any physical stuff. What actually acts on the physical world is the *physicalized* ‘[John’s jacket](#)’ (Q). And since in  $P \rightarrow Q$  the former is *physically absent*, the latter (Q) becomes *self-acting*, like your [brain](#). Hence the *origin* of classical gravity (**P**) is *not* physical field, [but Q is](#). Yet Q only *facilitates* the Platonic origin of gravity (**P**), like a [hand](#) in [4D glove](#) (Q).

Moreover, [GTR](#) offers the path to quantum gravity from the outset: read my endnote [here](#) and pp. 2-4 in [Gravitational Energy](#), and notice the Heraclitean *flow* of events (recall the puzzle [above](#)) depicted with the vector **W** in the drawing at p. 8 [therein](#).

Needless to say, Einstein was fully aware of the problems in his General Relativity (see p. 13 in [Gravitational Energy](#)):

The right side is a formal condensation of all things whose comprehension in the sense of a field-theory is still problematic. Not for a moment, of course, did I doubt that this formulation was merely a makeshift in order to give the general principle of relativity a preliminary closed expression. For it was essentially not anything more than a theory of the gravitational field, which was somewhat artificially isolated from a total field (Gesamtfeld) of as yet unknown structure.

My theory is also [incomplete](#), firstly because “the total field (Gesamtfeld) of as yet unknown structure”, suggested by Plato many centuries ago (p. 9 in [BCCP](#)), lacks mathematical presentation: we need new [Mathematics](#). Read [NB](#) at p. 6 [below](#).

Feel free to download the latest version of this paper from [this http URL](#).

[D. Chakalov](#)

20 March 2020

Last update: 2 April 2020, 11:52 GMT

## Addendum 1

### General Relativity: Einstein vs. Newton

<https://www.youtube.com/watch?v=DdC0QN6f3G4>

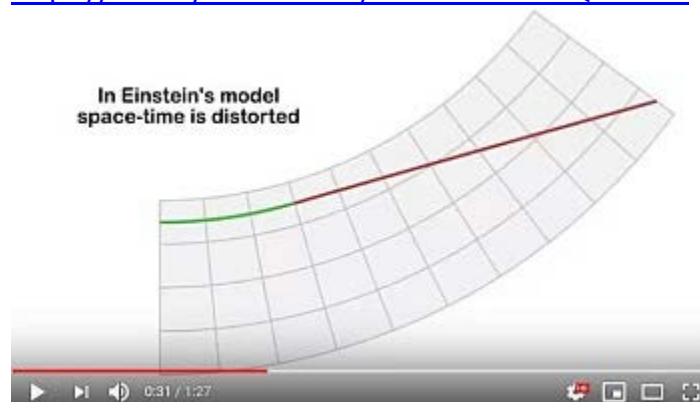

“In Einstein’s model space-time is distorted.” Fine. But there is no *explicit* time parameter  $\tau$  in GR: read [Carlo Rovelli](#), [Bill Unruh](#), and [Charles Torre](#). Why? Because the Heraclitean *flow* of Time, shown with the **radius** of the ‘inflating balloon’ ([Hubble](#)), is missing in [Einstein’s equations](#). The misleading drawing by John Baez and Emory Bunn [above](#) shows “Einstein static universe” from 1918 **without** the crucial *unphysical* inflating **radius**.

We read that “space acts on matter, telling it how to move. In turn, matter reacts back on space, telling it how to curve.” (J.A. Wheeler, p. 1 in [Gravitational Energy](#).)

Fine. But which goes **first**? Space acting on matter (telling it how to move) or matter acting on space (telling it how to “curve”)? See again Escher’s ‘[drawing hands](#)’ and my note on the spacetime interval  $\Delta s^2$  (R.M. Wald, Ch. 11, p. 286) [here](#). Simple, isn’t it?

In [GTR](#), the statement by J.A. Wheeler [above](#) is amended as follows:

Spacetime acts on matter, telling it how to move-and-rotate. At [the same instant](#), matter acts back on spacetime, telling it how to *alter* the *rate* of Time in the invariant spacetime interval  $\Delta s^2$ .

Namely, the local *deflation* of  $\Delta s^2$  creates attractive gravity, like going from Bob (B) to Alice (A), and the local *inflation* of  $\Delta s^2$  creates [repulsive gravity](#), like going from Bob (B) to Carol (C): p. 12 in [GTR](#) and p. 2 [above](#). See the 'general rule' ( $1 + 0 = 1$ ) in p. 2 in [Gravitational Energy](#) and the 'atom of geometry' at p. 7 [therein](#), shown below.



The Platonic hand (P) in 4D glove (Q).  
Examples from QM in [The Physics of Life](#).

The arrow of Time *cannot* be modeled with *temporal orientability* of spacetime: see the enormous smashing errors by Robert Geroch and Gary T. Horowitz in 1979 [here](#). The *orientability* of 3D space by "a choice of spatial parity" ("left-handed and right-handed triads", *ibid.*) is also *false*. The fact that in 3D space we can invert 2D *left* rubber glove into its mirror image of 2D *right* rubber glove ([parity inversion](#)) does *not* represent the fundamental *asymmetry* in spacetime topology: [time reversal symmetry](#) ( $t \Leftrightarrow -t$ ) and left glove  $\Leftrightarrow$  right glove symmetry ([parity inversion](#)) do *not* model the fundamental *asymmetry* along the 3D "axis" of [Small and Large](#). That is, if you have a large 3D ball in front of you, you cannot "invert" it *inside-out*, so that you will wind up *inside* the ball. Do you know how mathematicians would catch a lion in Sahara? Check out p. 19 in [Hyperimaginary Numbers](#) and Mark Armstrong at p. 26 in [BCCP](#). The non-trivial topology of spacetime is a big can of worms, which has been quietly swept under the carpet by the established mathematicians and theoretical physicists.

Further information on [the flow of Time](#) is available to qualified individuals: read the last paragraph of p. 15 in [Über Die Gravitationsfeldrelativitätstheorie](#).

Feel free to download the latest version of this paper from [this http URL](#).

[D. Chakalov](#)

24 March 2020

Last update: 7 April 2020, 12:55 GMT

## Addendum 2

This is what we know about [gravity](#): read [William G. Unruh](#) and compare the local *rates* of time read by the two (highlighted) clocks in the animation ([time.gif](#)) below.

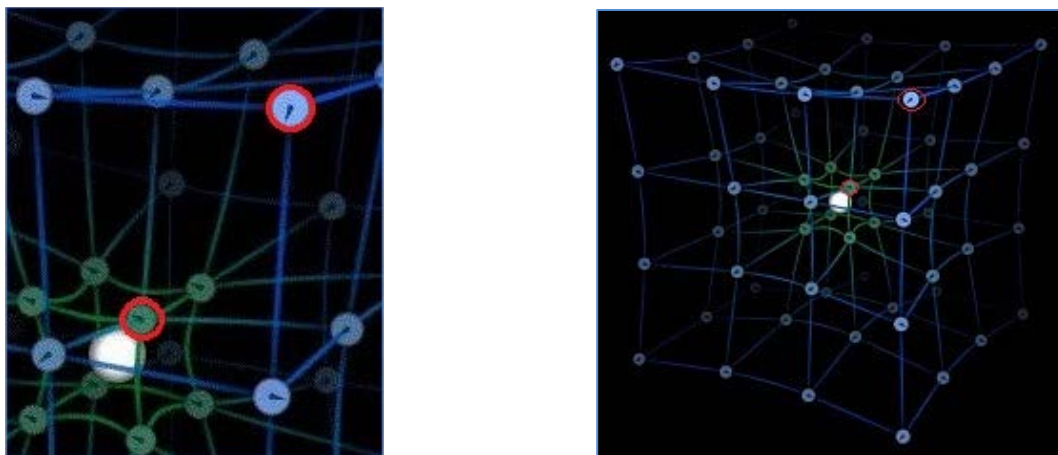

Read the principle of GTR at p. 4 [above](#). There is no *explicit* time parameter in GR: read [Carlo Rovelli](#) and [Charles Torre](#), as well as Adam Helfer, Mihaela Iftime, and my comments at p. 4 in [The Atemporal Platonic World](#). The latter is always **nullified** in the *squared* spacetime interval  $\Delta s^2$  (R.M. Wald, Ch. 11, p. 286): click [here](#). If it were possible to “discover” a *local* expression for gravitational field energy density (*ibid.*), the gravitational field will be local tensorial observable ([L. Szabados](#) and [MTW p. 467](#)) and gravity will become a *classical force field*. Therefore, GR cannot be a *bonafide* classical theory. But it cannot be quantum theory either. We need [quantum gravity](#). We need [Mathematics](#).

More in [Über Die Gravitationsfeldrelativitätstheorie](#) and [Gravitational Energy](#). There are *two* classical limits in quantum gravity, depending on the “direction” taken from the [macroscopic world](#) (denoted **B**) along the 3D “axis”, toward the [Small or the Large](#) (p. 12 in [GTR](#)): (i) from Alice (**A**) to Bob (**B**), and (ii) from Carol (**C**) to Bob (**B**). At the first classical limit (i), the nonlocal effects from the quantum world are FAPP zero; for example, in the effect discovered by [Charles Wilson](#). At the second classical limit (ii), the nonlocal effects from [large-scale gravity](#) are also FAPP zero. That is, the *physicalized* effects facilitated (Sic!) by the “glove” (**Q**), as explained with **P**  $\rightarrow$  **Q** at p. 2 [above](#), do not lead to any “anomalous” **Q**; for example, in [Earth tides](#). There is no violation of energy conservation by “[dark energy](#)” or by “[mystery matter](#)” at (ii): the phenomenon of **self-action**, exhibited also in the [human brain](#), is FAPP zero, too. With very few exceptions, people can use at (ii) only Newtonian gravity (e.g., [NASA](#)), and everything is sweet, because nobody dares to talk about [gravitational rotation](#).

Those interested in quantum gravity would eventually acknowledge that it would be “ferociously difficult” to understand the *emerging* of spacetime from ‘something else’ ([C.J. Isham and J. Butterfield](#)), although Plato suggested it many centuries ago (p. 2).



The latest feedback to my *pre-geometric Platonic theory of spacetime*, initiated in [July 1997](#), came eight years ago from Prof. Dr. [Maurice de Gosson](#) at the University of Vienna: "Buzz off, idiot!" (Mon, 21 May 2012 18:47:46 +0200). That's it. [Nothing else](#).

Regarding the topology of spacetime discussed at p. 4 [above](#): the 4+0 D spacetime, made exclusively by *physicalized* 4D 'jackets' Q (p. 2 [above](#)), has [simply connected](#) topology of *perfect* continuum, as it consists of one [asymptotically flat](#) ( $\Omega_0=1$ ) 'piece' that does not have any "holes" denoted [P above](#). The intrinsic *dynamics* of spacetime topology is highly [non-trivial](#), as it also requires [hyperimaginary numbers](#). This is how we live in 4+0 D spacetime ( $|\mathbf{w}|^2 = 0$ ): read carefully pp. 3-4 in [Gravitational Energy](#).

NB: In my model of causality (dubbed *biocausality*, [January 1990](#); p. 16-17 in [Zenon](#)), the *atemporal Platonic* world, denoted [P above](#), is *exactly re-nullified*: read [here](#). Thus, we can observe *only* matter (Q) acting on *itself* (Q): the universal [self-action](#).

The new re-interpretation of the so-called negative mass ([H. Bondi 1957](#)) is *the* only possible path toward the explanation of universal [self-action](#). Nature does not put "positive and negative mass [side-by-side](#)", as Robert Nemiroff claimed at [YouTube](#).

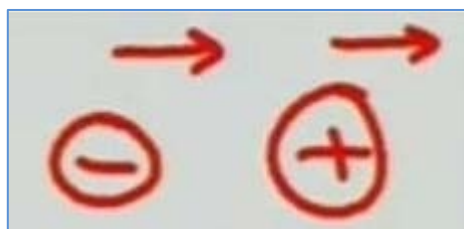

Read Robert L. Forward at p. 13 in [Hyperimaginary Numbers](#) and the explanation in p. 3 [therein](#). It is not like [Baron Münchhausen](#). Newton's 3rd law is not valid here. The end result is *uncancelled* forces and *self-acceleration* by universal [self-action](#) of the *physicalized* world Q: see [P → Q](#) at p. 2 [above](#).

To understand how the universal [self-action](#) is implemented by your brain, try the experiment at p. 5 in [Gravitational Energy](#). Also, watch Flavian Glont arranging  $10^{30}$  permutations of the Rubik Cube [blindfolded](#): at the end of the video clip posted [here](#), he finished with arranging the cube and then "looked" at it for nearly 2s. But he was still blindfolded, so what was he "looking" at? Watch Kyudo Master Ishikawa-san [here](#). This is Spacetime Engineering 101: read p. 6 in [Gravitational Energy](#) and p. 16 in [GTR](#).

We need advanced, large-scale effects of spacetime engineering. The best example is Anomalous Aerial Vehicle (p. 16 in [BCCP](#)), but first we need to know *much more* about gravity and gravitational rotation ([Richard Feynman](#)). Suppose, just for the sake of the argument, that one day some guy decides to fly over [River Thames](#) in London. Surely many tourists there will be fascinated (tourists love [free entertainment](#)), but what is the chance for the established mathematicians and theoretical physicists to become interested in [spacetime topology](#), the [origin of gravity](#), [general topology](#), [set theory](#), and [number theory](#) viz. [hyperimaginary numbers](#) (pp. 22-23 in [BCCP](#))? [When pigs fly](#).

Again, further information on [the flow of Time](#) is available to qualified individuals: read the last paragraph in p. 15 in [Über Die Gravitationsfeldrelativitätstheorie](#). Read also the story about the 'large yellow button' at p. 15 in [Hyperimaginary Numbers](#).

Read my questions to Sir Hermann Bondi [here](#) and download the latest version of this paper from [this http URL](#).

D. Chakalov

27 March 2020

Last update: 4 April 2020, 23:55 GMT

### Addendum 3

I asked a friend of mine (p. 5 in [Über Die Gravitationsfeldrelativitätstheorie](#)) to read this online paper and to tell me if he could understand my [interpretation of gravity](#). He replied today with text message "Sorry, cant read it". Obviously, it is my fault. Let me try harder. Quote from [The Adventure of Silver Blaze](#), by Arthur Conan Doyle:

Gregory: Is there any other point to which you would wish to draw my attention?

Holmes: To the curious incident of the dog in the night-time.

Gregory: The dog did *nothing* in the night-time.

Holmes: That was the curious incident.

The 'curious incident' here is the *origin* of gravity, denoted **P** at p. 2 [above](#). It can *never* show up in the physical world, just like Eliot's "mystery cat" called [Macavity](#).

We see (with light) only the *end result* **Q** from  $P \rightarrow Q$ . The latter only *facilitates* the *origin* of gravity (**P**) to act like a **hand** (**P**) in [4D glove](#) (**Q**): see Escher's drawing hands in p. 4 [above](#). Surely I can see (with light) my dog [Linda](#) (**L**) waving her tail (**Q**),  $L \rightarrow Q$  (read p. 2), so how come we *cannot* trace with light  $P \rightarrow Q$ ? Because the *origin* of gravity, pictured with the **Platonic** (**P**) [above](#), is *atemporal*: read closely p. 31 in [Platonic Theory of Spacetime](#) and notice the two *atemporal* "waves", dubbed offer wave and confirmation wave, at p. 7 in [Gravitational Energy](#). With a physical clock, the duration of the *atemporal* "waves" is **zero**: **P** itself *never* "barks". Only the *end result* **Q** from  $P \rightarrow Q$ . Notice that **Q** is universal, from apples (p. 1) to [galaxies](#).

Thus, any time you look at me, the *atemporal* "waves" have *already* (Sic!) produced the [4D glove](#) **Q** in  $P \rightarrow Q$ . This is the meaning of 'at the same instant' in GTR [above](#).

But what is 'atemporal'? Follow the experiment mentioned at p. 6 [above](#). Capiche?

Note to [GR experts](#): read Hermann Bondi and my two questions [here](#). Let me know what you [could not understand](#), it will be entirely my fault. See the references [here](#).

Note to mathematicians: if you are interested in [spacetime topology](#), the [origin of gravity](#), [general topology](#), [set theory](#), and [number theory](#) (pp. 22-27 in [BCCP](#)), feel free to contact me by email. The task is to develop the [phase space](#) of the **Platonic** world (read **A4** on p. 4 in [GTR](#)) and reveal the so-called [hyperimaginary numbers](#) and [two forms of gravity](#) (see below) in [asymptotically flat](#) ( $|w|^2 = 0$ ) **4+0 D** spacetime.



The *atemporal* sphere  $\Leftrightarrow$  torus transitions (pp. 20-22 in [BCCP](#)).

Look at the circle in the sphere  $\Leftrightarrow$  torus drawing [here](#), and picture the point at the top as 12:00 from your analog watch. Then *inflate* the circle until the length of its **radius** (p. 21 in [BCCP](#)) reaches actual/completed infinity, shown with the horizontal line in the drawing above. At this 'point zero', the **radius** will be *exactly* zero as well: it will be fused with all points from the former circle. You keep inflating, but now you are inflating a [torus](#), and you'll pass through the same 'point zero' back to the circle. NB: You will also *rotate* the 3D sphere  $\Leftrightarrow$  torus, in infinite-dimensional [Hilbert space](#).

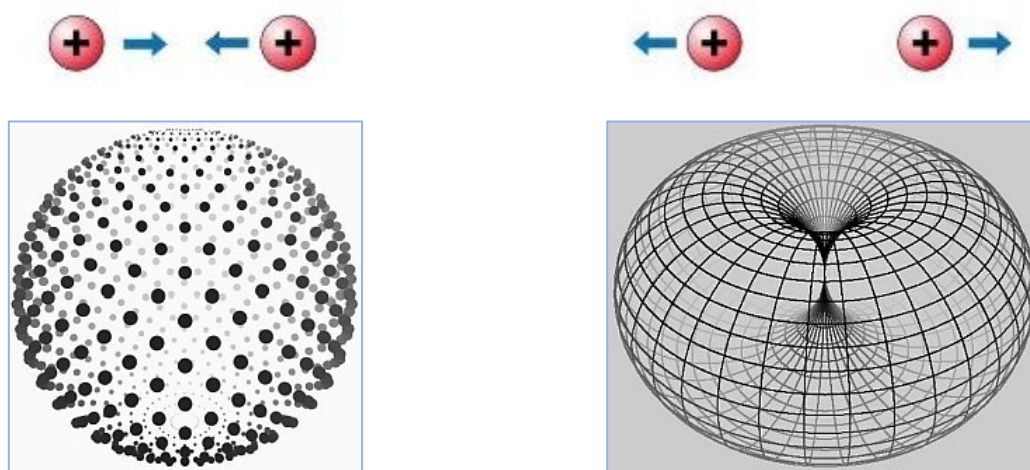

Read p. 11 in [Spacetime Engineering](#) and pp. 11-12 in [GTR](#).

As stated [above](#), the task is to develop the *phase space* of the **Platonic** world, in which one could "see" all points in the physical world *simultaneously* and from all directions in 4+0 D spacetime, including the *inner* structure of solid objects and things obscured from three-dimensional viewpoint; for example, all six sides of an opaque box ([Wikipedia](#)) and, at the same instant, *everything* that is inside the box, from "inside out". Hence you will be able "see" the *atemporal Platonic* image (also called **matrix**) of the opaque box and work with '**It**' (pp. 5-7 in [Gravitational Energy](#)).

As always, I am ready to explain the task (p. 22 in [BCCP](#)) in details. The full-blown quantum gravity (cf. p. 5 and my endnote [here](#)) can describe only the **self-acting** Brain of the Universe, similar to the **human brain**: the ultimate 4D '**glove**'. The ultimate Platonic '**hand**' (denoted **P** in p. 4 [above](#)) can manifest itself only by pure mathematics, as quantum gravity enters physical theology ([John 1:1](#); [Luke 17:21](#)). If it were possible to *reduce* physical theology to physics and mathematics, people could propose a theorem of the existence of God *without UNdecidable statements*. Then God ([1 John 4:8](#)) could be either proved or disproved. Thank God, this is impossible.



Let me stress, however, that the idea of God is inherently incomprehensible with human cognition based on [binary logic](#) and the current formulation of [set theory](#). The same restriction applies to the incomprehensible idea of 'the Universe as ONE' viz. 'universal set' discovered in 1899 by [Ernst Zermelo](#). This was the reason to formulate the so-called Maximal Set Theory (MST), in which I introduced the Axiom of Existence (details upon request). Check out the doctrine of *trilism* at p. 25 in [BCCP](#) and pp. 5-6 in [Über die Substanz von Raum und Zeit](#). In one sentence: Nature is smarter, as **It** (not "He") contains *absolutely* everything fused into ONE incomprehensible entity. The bipolar structure of both physical world (*Res extensa*) and noetic world (*Res cogitans*) is inevitable, as demonstrated by both the theory of relativity and the human cognition: we can formulate an ordinary set, denoted **A**, iff we can relate **A** to **non-A**. Otherwise the notion of 'set' will be incomprehensible to us. But again, Nature is smarter. The latter cannot be proved nor disproved, which brings us to the Axiom of Existence.

In Platonic theory of spacetime, the "intuitively clear" statement that the distance from a point *to itself* is "zero" ([Wikipedia](#)) is amended with the new notion of 'zero' in  $4+0$  D spacetime: the Universe as ONE at **sub-photon** level "inside" **null intervals** ( $x = \pm ct$ ). Read about physical theology on p. 12 in [GTR](#) and on p. 2 ('**It**') in [Plato](#).

How do we *split* the geometric point that "has no part" ([Euclid](#))? See again (p. 4) the general rule ( $1 + 0 = 1$ ) at p. 2 in [Gravitational Energy](#) and the new *atom of geometry* (p. 7 [therein](#)) reproduced below:  $P \rightarrow Q$  replaces the 'quantum of time' ([chronon](#)).



We need Mathematics: read p. 8 [above](#).

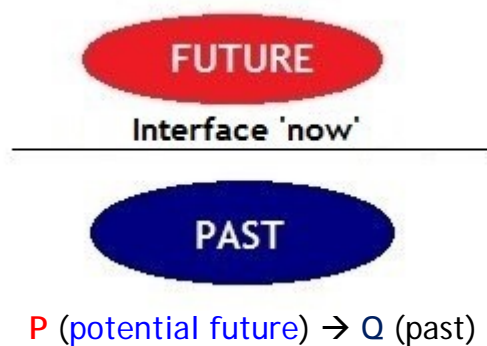

See the old [Dragon metaphor](#) on p. 3 in [Penrose-Norris Diagram](#).

Note to [theologians](#): God is by no means "downgraded" in [physical theology](#). Instead, we postulate that Nature has two *dual* and ontologically different explications, which are *equally legitimate* "copies" of Nature, similar to [wave-particle duality](#). See again the doctrine of *trilism* at p. 25 in [BCCP](#). It doesn't matter if people commemorate Jesus' Birthday, or choose the *complementary* "copy" called 'the Universe as ONE'. They both are correct. It is up to your free-will decision, which is a gift from God as Love (1 [John](#) 4:8). Only you will decide which "copy" suits you best. I choose both. In my opinion, both [theism](#) that [anti-theism](#) are *horrible* brainwashing religions. Period.

Let me go back to (i) the [interpretation of gravity](#) (p. 7), which depends on (ii) the new notion of 'zero' applicable to the Platonic Universe as ONE at [sub-photon](#) level (p. 9) called '[It](#)' (p. 2 in [Plato](#)). The origin of [inertia](#) ([John Wheeler](#)) and gravitational rotation ([Richard Feynman](#)) is still unknown, so the proposed interpretation of gravity (i) cannot be tested – it will look like sheer “entertainment” (p. 6). The second issue (ii) cannot be verified either, as we still do not know the topology of spacetime in the first place: read p. 4 [above](#). At this moment, I can only offer the explanation of '[It](#)' (ii) with the “boundaries” of spacetime at “asymptotic flatness” (forget [R. Penrose](#)).

NB: If the reader can offer *any* other theory of fixing spacetime “boundaries”, then my theory will be **wrong**, and I will immediately delete this paper and my website. Bottom line is that these “boundaries” **must not** belong to the physical 4+0 D world. The Platonic Universe as ONE, called '[It](#)', **wraps** the entire *physicalized* world, being **both** “inside” the spacetime point with **zero** dimensions (p. 9) **and** infinitely far away, “outside” the entire *physicalized* world at **null and spacelike infinity** denoted **W** :

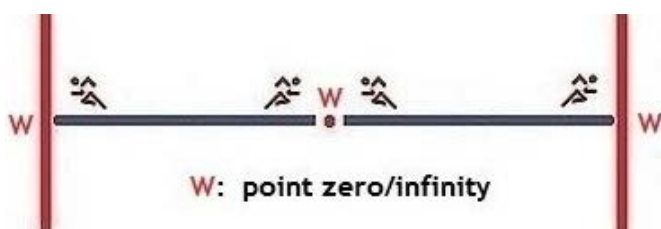

The Universe is like an unbroken ring with no circumference, for the circumference **W** is nowhere and the center **W** ('[It](#)') is **everywhere**.

Look at the dark “pizza” of spacetime below, discussed at p. 5 in [Zenon](#).



The dark “pizza” shows the idea of ‘[inflating universe](#)’ pictured as the *surface* of the [inflating balloon](#), after [Arthur Eddington](#). We cannot see the **nullified atemporal radius** of the inflating balloon and its **center** at ‘time zero’ ([John 1:1](#)). Physically, we live in “inflating” 4+0 D universe. You may try to suggest *physical* “boundaries” of spacetime, but they **must** (Sic!) be accessible from *within* spacetime and will inevitably belong to the 4D physical world; for example, some [GW mirrors](#) placed *exactly* at the dark boundary of the “pizza”. Can’t have you cake and eat it. You need new spacetime “boundaries” fixed by '[It](#)'.

Needless to say, the *atemporal* Platonic '[It](#)' could be accessible with the [human brain](#).

Feel free to download the latest version of this paper from [this http URL](#).

[D. Chakalov](#)

6 April 2020

Last update: Easter 2020, 20:56 GMT

## Addendum 4

This is the balloon analogy by [Arthur Eddington](#) from 1933: every 4D point/event on balloon's surface (p. 9) belongs also to the nilpotent (Sic!) radius denoted  $W$  (p. 10).

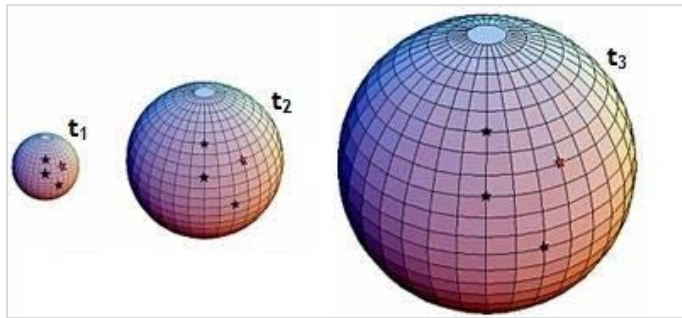

Consider the time-like sequence (world line) from the Beginning:  $T_0, \dots, t_1, t_2, t_3, \dots$ . Notice the drawing at p. 6 in GTR:



The Beginning at  $T_0$  will disappear.

Back on 8 May 1998, [Ned Wright](#) explained: "the balloon analogy is a 2-dimensional model, and the center of the balloon and the space around are not (Sic! - D.C.) part of the 2-dimensional universe. In our 3-dimensional universe, these points could only be reached by traveling in a 4th spatial dimension (not the time dimension of 4-D spacetime), but there is no evidence that this dimension exists."

Sounds fine, but why "4th spatial dimension"? In my opinion, we face *pre-geometric infinite-dimensional Euclidean space*  $\mathbb{R}^\infty$ . Let me try to explain.

Fig. A below shows one of the six sides of an opaque box: read p. 8 above. To "see" all six sides instantaneously, you will need a new [god Janus](#) capable of seeing objects *simultaneously* along the three spatial axes,  $x/-x$ ,  $y/-y$ ,  $z/-z$ , and also along  $t/-t$ . We can look at one of the six sides, once at a time; for example, along axis  $z$  (not shown in Fig. A) orthogonal to  $x/y$  plane. Fig. B is borrowed from Mark A. Armstrong (*Basic Topology*, Springer, 1997, Fig. 5.7, p. 104): read p. 19 in [Hyperimaginary Numbers](#). Can you count all *infinitely many* arrows in Fig. B, including those "inside out"?  $\mathbb{R}^\infty$ !

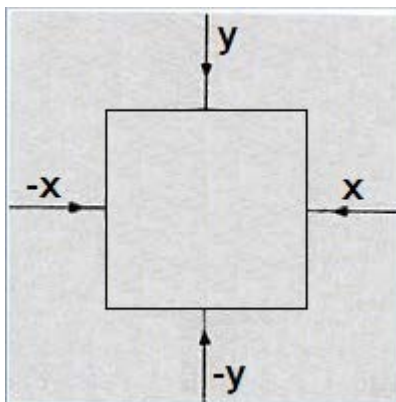

Fig. A

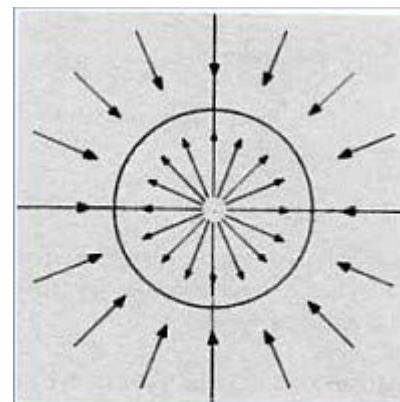

Fig. B

To understand Fig. B above, recall the old joke about how to catch a lion in Sahara: see the small red circle in Fig. C below.

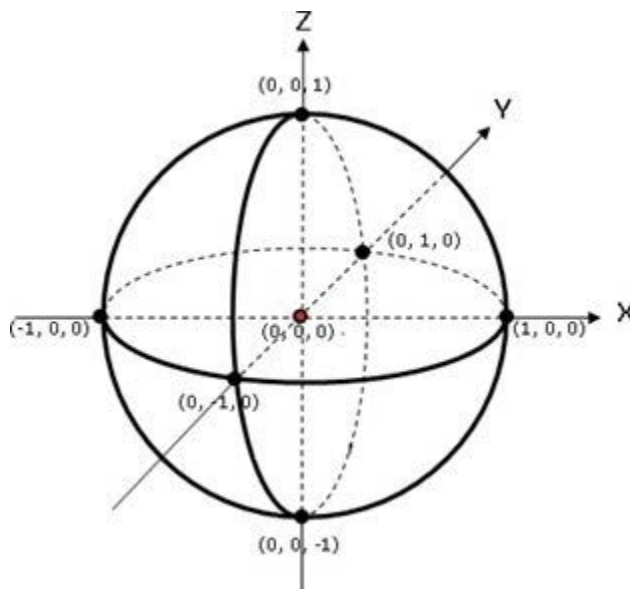

Fig. C

If you ask a mathematician, she would probably suggest that, given the existence of at least one lion there, she would drag a cage for lions in the middle of the desert, lock herself up, and then perform space inversion with respect to the cage surface (the circle in Fig. B above), such that all points outside it will be converted inside the cage, and *vice versa*. At the end of the day, she will find herself outside the cage, while the poor lion will be locked inside, and they both will undergo **parity inversion**.

Our task is far more **complicated** – read p. 8 above. The so-called point zero/infinity, depicted in the drawing at p. 10, is the **breaking point** in sphere  $\Leftrightarrow$  torus transitions (p. 8). I tried to explain it to my (adult) children, but they weren't interested at all. Only Linda showed genuine interest in the **phase space** of the **Platonic** world. Anyway.

Read again NB at p. 10 above. The *only* possible path toward understanding **gravity and inertia** (p. 1) is by separating the *origin* of gravity (P) from the *effects* of gravity (Q):  $P \rightarrow Q$  (p. 2). And P is 'It' (p. 10). This is the *only* possible path toward **quantum gravity** as well (p. 2). Not convinced? No problem, start from the *rate* of time (p. 5). My solution is spelled out on p. 4 above. What is yours?

The latest version of this paper can be downloaded from [this http URL](#).

D. Chakalov  
Great Friday 2020, 22:37 GMT



## For the Record

I am organizing two-day conference **GRAVITY 21** on 26-27 March 2021 in Munich (EU), to present my theory of gravity (reference below) and discuss it with [many experts](#) in [mathematical general relativity](#) and topology of spacetime (p. 4). If the reader would like to present her/his theory of gravity, please contact me by email, available at my [website](#), by [Christmas 2020](#). The conference will cover three topics:

1. [Continuum](#) of [geometric points](#). How do we define the notion 'zero' pertaining to an [object](#) that must *not* exist "between" geometric points in a [perfect continuum](#)? **It** cannot be an 'empty set', because **it cannot** be a 'set' in the first place. What is '**it**'? The *pre-geometric* continuum (P) is *infinitely divisible* by [physicalized 4D](#) events (Q). The latter has [positive mass](#) and metric (*Res extensa*): Q is located on the [light cone](#).
2. Structure of physical spacetime. Given the [invariant speed](#) of light and calibration of 4D spacetime in '[meters of light-travel time](#)', how do we define the non-relational *flow* of time? With the exception of photons, all physical bodies (Q), standing still in [their reference frames](#), will nevertheless "fly" in time, with different [rates of time](#).
3. Physics of gravity. In GR, people attribute gravity to [geometry](#), like the *shape* of a mountain, but how can the 'shape' itself [act back](#) on its "source" (mountain)? Can Bondi's 'news tensor', which determines the "energy flux" of gravitational radiation, produce [work](#) on the apple? Or "gravitational waves" (GWs) and "gravitons"? Can the topological properties of spacetime (forget "curvature") produce [inertia](#) & [rotation](#)?

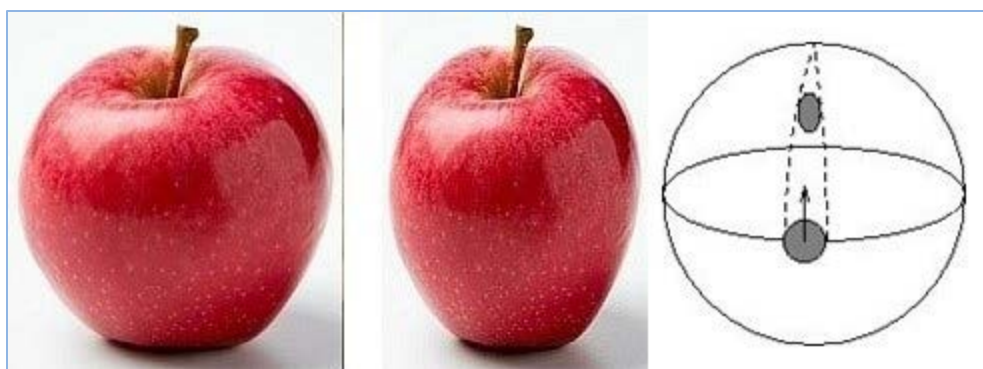

*Disce aut discede.*

[Easter 2020](#), 13:00 GMT

---

D. Chakalov, Can Geometry Produce Work? viXra:2003.0425, 2020-05-06.  
<https://vixra.org/abs/2003.0425>

[vG] 2020-05-06 19:15:13

**Unique-IP document downloads: 21 times**



The Continuum of Geometric Points, by [D. Chakalov](#). Presented on 26 March 2021 at GRAVITY 21, March 26-27, 2021, Munich, EU.

**Abstract.** I suggest perfect *pre-geometric* Platonic continuum ( $P$ ), which is *infinitely divisible* by *physicalized* points/events ( $Q$ ) in the action  $P \rightarrow Q$ . The former ( $P$ ) is not observable with light, as suggested by [Plato](#), whereas  $Q$  is located on the [light cone](#).

## 1. Introduction

In [number theory](#), we picture the idea of [real numbers](#) as “points on an infinitely long line called the number line” ([Wikipedia](#)):

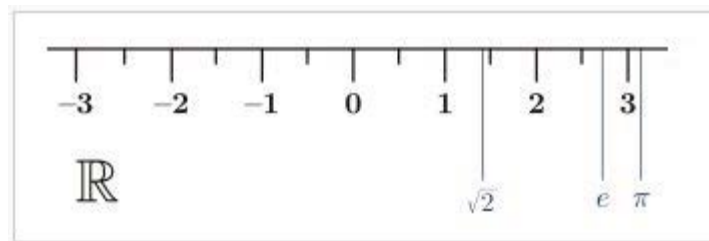

Fig. 1

Our cognition is [relational](#): we can *think* of an individual point ( $A$ ) iff we can relate it to something this point is not – **non-A**, pictured in **black** (Fig. 2). Fine, but what do we see in Fig. 3? **Absolutely all** ([absolute infinity](#)) *non-denumerable* white points from the finite segment of the number line (Fig. 2). This is the *perfect* continuum of the *pre-geometric* Platonic world called '**It**', also denoted  $P$  in the action  $P \rightarrow Q$ .

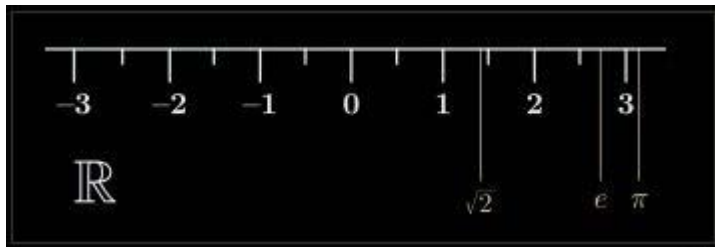

Fig. 2



Fig. 3

I will argue that (i) '**It**' (Fig. 3) is located “[between](#)” every *individual* (white) point in Fig. 2, and that (ii) '**It**' does *not* belong to the denumerably infinite set of individual (white) points in Fig. 2. Namely, the *uncountable* cardinality of the set '**It**' (Fig. 3) is greater than [Aleph-null](#), and hence '**It**' can provide the **unique cutoff** on the physical world in Fig. 2: the Platonic entity '**It**' is one “point” stretched to [absolute infinity](#). In the physical world endowed with [metric](#) (Fig. 2), '**It**' always “[disappears](#)”, being set to “[zero](#)”, like Eliot’s cat [Macavity](#) living “[inside](#)” [null intervals](#) ( $x = \pm ct$ ), presenting the dimensionless ‘geometric points’ in Fig. 2, which ‘have no parts’ ([Euclid](#)) anymore.

The individual (white) points in Fig. 2 work as blank templates or “colorless canvas” for the *physical* (Sic!) content undergoing ‘*change in time*’, resembling the individual snapshots from a *movie reel* – without the *dark strips* separating the snapshots, there will be no ‘change in time’ and all 4D snapshots from the *movie reel* will be fused into one QM “snapshot” of infinitely many *atemporal superposed states*. Notice that the “colorless canvas” of *bare* geometric points (Fig. 2) is like the invisible *colorless* nails shown in Fig. 4: we see *only* their *physical* “colors” that will ‘*change in time*’. Yet the invisible “colorless canvas” has its own topological structure demonstrated with the unique *calibration* of 4D spacetime (Fig. 5). To quote E.F. Taylor and J.A. Wheeler in *Spacetime Physics* (1965, p. 18): “We assume that every clock in the latticework, whatever its construction, has been calibrated in meters of *light-travel time*.”



Fig. 4

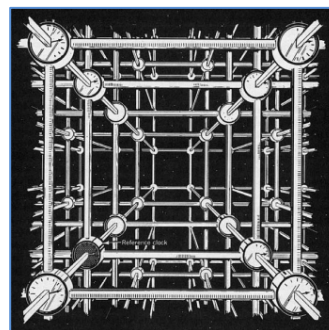

Fig. 5

NB: What phenomenon “calibrates” the *ideal* rods and clocks (MTW p. 397) pre-build in spacetime (Fig. 5)? As *Arthur Conan Doyle* remarked, when you have excluded the impossible, whatever remains, no matter how improbable, must be the truth. Here, the *pre-geometric* Platonic continuum ‘*It*’ (Fig. 3), offering the *only* possible solution to *Thomson’s lamp paradox*, as shown in the operational ( $\epsilon$ ,  $\delta$ ) “*definition*” of *limit*.

## 2. The Platonic hand (P) in 4D glove (Q)

Let us examine an *operator*  $P \rightarrow Q$ . Back in July 1997, I called the *pre-geometric* Platonic continuum (P) ‘*the undefinable matrix*’, and stressed that ‘*It*’ is *inherently incomprehensible*. In QM parlance, the Platonic continuum (P) is only “projecting” its *colorful* localizable 4D eigenstates Q – one Q at a time, placed only at the apex of the *light cone*. Hence the “projecting” *operator*  $P \rightarrow Q$ . The *physicalized* partition of the Universe is just a Q-set. We cannot ‘turn around’ and look at the Platonic world (P), as *Plato* suggested many centuries ago. Why not? Because of the “*speed*” of *light*.

The Platonic world (P) does not produce any resistance to bodies (Q) “passing through it” (*Wikipedia*), just like *the* quantum state (dubbed *John*) and the *quantum vacuum*. There is no “*space devoid of matter*”, for the same reason that there can be no ‘time devoid of matter’. Light does not “propagate” in some *luminiferous aether*, but in the Platonic continuum (P) depicted in Fig. 3. The “*absolute*” reference frame is “inside”

each and every 4D point/event, camouflaged as 'zero event'. The 'It' is omnipresent. Strictly speaking, 'It' has *indefinite cardinality* in  $[0, \infty]$  and cannot be Cantorian set.

To wrap up, let me go back to Fig. 2 and explain the "structure" of (white) *geometric* points, for example, in the closed interval  $[0, 1]$  shown in Fig. 6 below.

As told by Aristotle (*Physics VI:9, 239b10*), Zeno of Elea (490-430 BC) has formulated the famous *dichotomy paradox*: that which is in locomotion must arrive at the half-way stage *before* it arrives at the goal. In Fig. 6, we imagine B going back to A, so that B can and will stop *only* at the ultimate limit  $B \equiv A$  (Sic!), which denotes *one single* dimensionless point (Euclid), and locomotion will be impossible. Moreover, the ultimate limit  $B \equiv A$  is UNdecidable, as demonstrated with Thomson's lamp paradox.

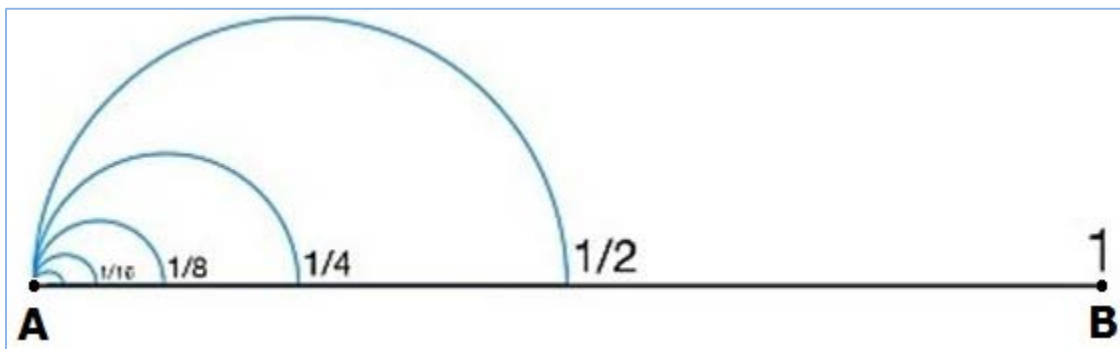

Fig. 6

$[0, \dots, 1/16, 1/8, 1/4, 1/2, 1]$

The only possible solution to Zeno's paradox is to endow *every single* point in  $[AB]$  with *pre-geometric* Platonic "structure" (Fig. 3) and dynamics: the operator  $P \rightarrow Q$ .

What can we make from this metaphysical exercise? Quantum gravity and cosmology, but only as conceptual theories. We need Mathematics.

Let me examine the paradoxes in the operational  $(\epsilon, \delta)$  "definition" of limit (Fig. 6), which produce insoluble problems in understanding the properties of spacetime *exactly* at the asymptotic "boundaries" (if any). In my opinion, the so-called local differential geometry (Bob Geroch) is Russian poetry, to say the least. There can be nothing 'local' in the operational definition of 'infinitesimal' – you only have a *recipe* that, if B runs indefinitely toward A (Fig. 6), at the end of the day B *can* obtain some number, say, C. But is CA "explicitly nonzero" or  $C \equiv A \equiv 0$  on the number line (Fig. 1)?

The solution is very simple: every real number, depicted with (white) *geometric* point in Fig. 2, is particular Q from the operator  $P \rightarrow Q$ . The *physicalized* world is Q-set with  $4+0$  D spacetime – P is *squared* and *exactly* nullified, just as *the* quantum state (dubbed John) mathematically *disappears* upon the wave function "collapse". Thus,

we see (with light) only a *temporal* sequence of *different-in-time* “jackets” from the Q-set,  $Q_1, Q_2, Q_3, \dots$ , along the *non-relational flow of time* – all physical bodies (Q), even if at rest in their reference frames, will nevertheless “fly” in *Heraclitean Time* (Fig. 10). The *only* possible solution to Zeno’s paradox of motion is to endow the geometric point A (Fig. 6) with *different-in-time* Q-states placed at the beginning and at the end of the *infinitesimal* (Sic!) time displacement  $Q_1 \rightarrow Q_2$  denoted  $\Delta t$ . Thus, at the ultimate limit  $B \equiv A$  (Fig. 6), B will *not* hit  $A_1$ , but its *next* temporal “copy”  $A_2$ , such that  $(A_2 - A_1) = \Delta t$ . Again, P from the operator  $P \rightarrow Q$  is *not* observable with light (Fig. 9): the *pre-geometric* Platonic continuum (Fig. 3) provides ‘colorless canvas’ (Fig. 4) for its *colorful* physicalized 4D “jackets” ( $Q_1, Q_2, Q_3, \dots$ ) located on the *light cone* and cast on the *atemporal* Platonic *perfect continuum* P.

We need the so-called hyperimaginary numbers to “insert” the Platonic *pre-geometric* continuum P “inside” the *infinitesimal*  $\Delta t$ .

### 3. Hyperimaginary numbers: $|w|^2 = 0$

The real numbers (Fig. 1) may look simple: watch the explanation of ‘instantaneous velocity’ by Michel van Biezen at [YouTube](#), particularly 2:50-3:08 from the timeline.

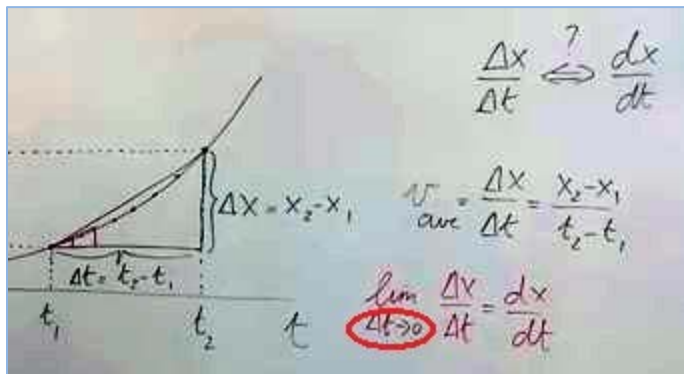
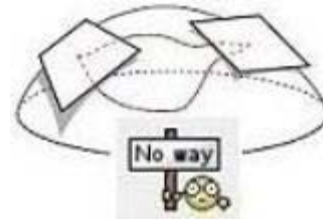

Fig. 7

There is no “spacetime curvature” in Fig. 7. The trajectory there is curved only as a mathematical tool enabling you to compute *derivatives*. Ditto to the mythical “spacetime curvature” in *GR textbooks*. Simple, isn’t it?



Is (i)  $\Delta t \equiv 0$  or (ii)  $\Delta t > 0$ ? Which is the correct answer, (i) or (ii)? Neither. As Murphy noticed, complex problems have simple, easy-to-understand wrong answers. Read the solution [above](#). In the case in Fig. 7, we cannot show the *pre-geometric* continuum P “inside” the *infinitesimal*  $\Delta t$ . To show ‘It’ (Fig. 3), we need the *Platonic* quantum world (P) “just in the middle between possibility and reality” (Werner Heisenberg).

Look at the electron “orbitals” in the hydrogen atom, at two different energy levels, from [Wikipedia](#) (Fig. 8). They are not *bonafide* trajectories, because ‘trajectories’ (Fig. 7) belong exclusively to the *physical* 4D world which “either *is* or is *not*” (Erwin Schrödinger). The *Platonic* world (P), on the other hand, is *ontologically* different entity (recall [Kochen-Specker Theorem](#)), as Erwin Schrödinger stressed in 1935. We may only talk about ‘quantum-mechanical *wave function*’, but we still do not know



how **P** “shows up” in the macroscopic world at the length scale of tables and chairs (Charles Wilson).

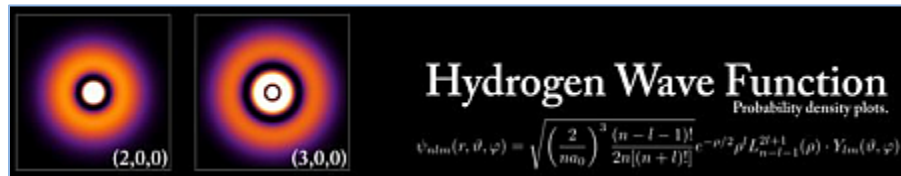

Fig. 8

How come nothing goes wrong with the *immensely* complicated electron “orbitals”? To fully understand the puzzle, let me show Slides 9 and 10 in [Quantum Spacetime](#).

Suppose a light bulb emits photons with rate app.  $1.8 \times 10^{20}$  photons per second. All photons are *identical*, and have particular wavelength related to the “distance” (if any) between the two “orbits” (if any) of electrons, denoted in the drawing with **h**.

How come nothing goes wrong in producing  $1.8 \times 10^{20}$  identical photons per second, *ever*? According to John Wheeler (1973), the identity of particles of the same type is “a central mystery of physics.”

Physically, the photon was **non-existent** before it was emitted: see Schrödinger 1935 (Slide 6) and Milonni 1993 Ch 2.6.

Slide 9/19

Slide 9

Only about 1% of proton’s mass can be traced to **quarks** (two up quarks and one down quark), whereas 99% of its mass belongs to Quantum Chromodynamics (QCD) binding energy. Imagine zillions of quarks (u,d,s), antiquarks (u,d,s with a bar on top), and gluons (g) zipping around near the speed of light, banging into each other, and appearing and disappearing from QCD vacuum (Strassler 2010): they are able to assemble proton’s *mass* of  $938 \text{ MeV}/c^2$  with error margin of just *one* part in  $10^{45}$  (Dolgov 2012), for at least  $10^{29}$  years.

How about spin-2 Higgs-like boson at 14 TeV?

What phenomenon could create  $10^{82}$  **identical** protons?

Slide 10



And how come nothing goes wrong with the *calibration* of 4D spacetime (Fig. 5)?

## Atemporal Quantum Reality: Quantum Cosmology

Without quantum cosmology based on the quantum-gravitational **matrix** of spacetime, we would need some Biblical "miracle" to raise a robust Lorentzian metric within  $10^{-30}$  seconds "after" the "big bang", starting *much earlier* at  $10^{-35}$  seconds "after" the "big bang", when the **classical** (not **quantum**) spacetime would be about 1 cm across and a causally connected region would have been only  $10^{-24}$  cm across (the horizon problem), in such way that one could **later** "inflate" the spacetime by a factor of  $10^{78}$  and then *safely* keep the Lorentzian metric for at least 13.798 billion years rooted on the Planck scale at which the spacetime "points" are *totally* fuzzy and the principle of **locality** has lost *any* meaning.

Slide 12/19

Slide 12 in [Quantum Spacetime](#)

To summarize, I will go back to the *atemporal Platonic* world (Fig. 9) and the non-relational *flow* of 4D events, as suggested by Heraclitus (Fig. 10): Nature evolves by both 'change *in* space' (coordinate time of Q) and 'change *of* space'. It's a **bundle**.

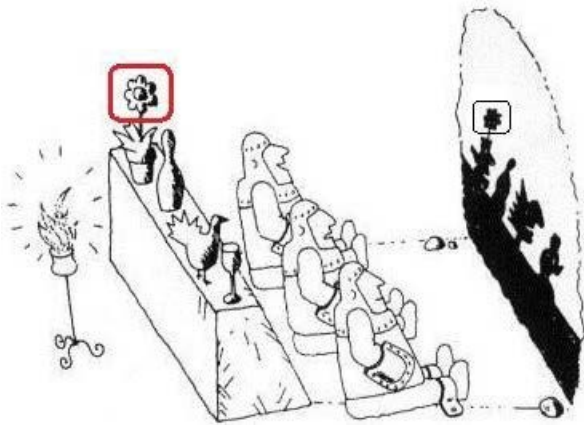

Fig. 9

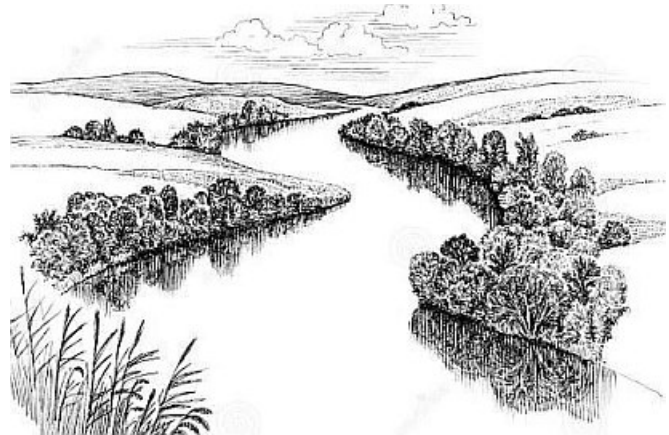

Fig. 10

Thanks to the "speed" of light, we **cannot** turn around and look at the *atemporal Platonic* world (Fig. 3).

The *flow* of Time: everything changes and nothing remains still – you cannot step twice into the same stream (Heraclitus).

Again, how is the “speed” of light (Fig. 9) [hiding](#) the *atemporal Platonic* world (P) (Fig. 3), in P (potential future) → Q (irreversible past)? Recall the L (Linda) → Q operator [above](#) and consider sequential 4D Q-states ‘here and now’,  $Q_1, Q_2, Q_3, \dots$ , along the [non-relational flow](#) of Time. For example (Slide 19 in [Quantum Spacetime](#)), you stay in front of a wall, and at  $Q_1$  you toss a ball at the wall, in such way that the ball will bounce back and hit you *later* at  $Q_2$ : you will be watching all consecutive states (Q) of the ball during the [entire interval](#)  $(Q_2 - Q_1) > 0$ . But if you replace the ball with a photon, the [null interval](#) “between” its emission at  $Q_1$  and absorption at  $Q_2$  will be *exactly* zero:  $Q_2 \equiv Q_1$  denotes *one single* 4D event ‘here and now’ of the ball. *There will be no time and no 3D space*: the infinitesimal  $\Delta t \equiv 0$ . The [solution](#) is [very simple](#): the photon emitted at  $Q_1$  will hit the [next](#) temporal “copy”  $Q_2$ , such that  $(Q_2 - Q_1) = \Delta t > 0$ . Even if all  $Q_1, Q_2, Q_3, \dots$ , are at rest in their reference frame, they will nevertheless “fly” in [spacetime](#). This is the difference between time and space. Needless to say, the non-relational *flow* of Time is [exactly nullified](#), leading to 4+0-dimensional spacetime. Physically, the *atemporal Platonic* world (P) is [zero](#): the displacement between  $Q_1$  and its [next](#) temporal “copy”  $Q_2$  – ‘change of space’ – is along the nilpotent [radius](#) of the [inflating balloon](#), matching the Heraclitean *flow* of Time (Fig. 10). The latter is *never* exposed to the physical world, or else Time will have to be *relational* phenomenon, with respect to the river banks ‘at absolute rest’. This is the common denominator of [Theory of Relativity](#) and [Quantum Theory](#).

NB: Everything said above will be [immediately refuted](#) iff the reader of these lines can show arguments in support of the alternative viewpoint expressed, for example, by [Bob Geroch](#): “There is no dynamics within spacetime itself: nothing ever moves therein; nothing happens; nothing changes.” Time as change is made *only* by [matter](#).

If that were true, we will face two alternatives regarding the size of the [infinitesimal  \$\Delta t\$](#)  : either (i)  $\Delta t \equiv 0$  or (ii)  $\Delta t > 0$  (Fig. 7). *Tertium non datur*. Option (i) leads to the insoluble Zeno’s paradox (Fig. 6) and to “the Ghosts of departed Quantities” ([George Berkeley](#)), whereas the alternative option (ii) requires some *finite* (not zero) interval  $\Delta t$ , like the size of a [pixel](#) from digital image, separated from the neighboring pixels by a [colorless area](#) that does not belong to the (dead frozen) digital image. If so, how many geometric points (Fig. 1) can fit in a pixel or [on the tip of a pin](#)?

#### 4. Conclusion and outlook

The famous *Conference on the Role of Gravitation in Physics* (January 18-23, 1957) can be traced to a nebulous report by Bruce DeWitt, dated [December 7, 1955](#). I hope [this report](#) is better. Obviously, I could not file my questions to Sir [Hermann Bondi](#) in January 1957, and will leave them to the participants of the forthcoming *GRAVITY 21* (March 26-27, 2021). If my [Gravitationsfeldrelativitätstheorie](#) triggers genuine interest at *GRAVITY 21*, I will [elaborate](#) on the [origin of gravity](#) and demonstrate the so-called ‘reversible elimination of inertial mass’ (REIM). Mind you, REIM is not “[levitation](#)”. It is all about modulating the [rate of time](#) under the re-interpretation of [negative mass](#).

[Munich](#), Christmas 2020

The Bridge, by [D. Chakalov](#). Presented on 27 March 2021 at [GRAVITY 21](#), March 26-27, 2021, Munich, EU.

**Abstract.** I suggest a hypothetical 'bridge', denoted  $P \rightleftharpoons P$ , between the *atemporal* Platonic state ( $P$ ) of the quantum-gravitational world (modeled as the "brain" of the universe) and the *atemporal* Platonic state ( $P$ ) of the human brain. Once created, the 'bridge' might produce specific *pattern* in the [human brain](#), which may have [qualia](#) accessible by [human volition](#), and could also be enhanced with [biofeedback training](#).

## 1. Introduction

The hypothetical *atemporal* Platonic state ( $P$ ) of the quantum-gravitational world was presented in my preceding report [1]. Before launching another hypothesis about its [practical applications](#), may I briefly explain my personal, and perhaps strongly biased, opinion on the possibility *in principle* to suggest in [General Relativity](#) (GR) *any* kind of coupling of the gravitational "field" to matter and fields placed in the right-hand side at [Einstein field equations](#) (EFE), interpreted as classical (Sic!) "source" of gravity.

This task is impossible *in principle*. **Absurd**. I will first offer a very simple analogy and then will elaborate with specific examples from GR, with minimum references.

Suppose you order a pizza, which is delivered at your doorstep, and then you bring it in your kitchen for your lunch. The pizza you have in your kitchen (the right-hand side at EFE) and the pizza cooked *previously* in the restaurant (the left-hand side at EFE) are *identical*. It is *exactly* the same stuff (matter & fields = pizza) due to the coupling of the pizza restaurant to your kitchen. Thus, gravity will be a *bonafide* physical field, and the conservation of mass-energy of the system 'pizza restaurant & your kitchen' will *not* be violated. It will be like withdrawing your cash from ATM: the total amount of money is always [conserved](#). Only there is a [problem](#): this is *not* the case chosen by Mother Nature. Which is why I suggest to [separate](#) the Platonic source of gravity ( $P$ ) from its *physicalized* 4D manifestations ( $Q$ ):  $P \rightarrow Q$  [1].

This is *the only* possible path toward understanding gravity, in my opinion. The key issue here is the origin of [Time](#). The current GR textbooks offer only a [dead end](#). Why? Because physicists endorse the "intuitively obvious" opinion that the theory of gravity must be [classical theory](#). But here's the catch: if gravity (at the left-hand side at EFE) acts on its "source" (the right-hand side at EFE), the latter will inevitably *change* its energy-momentum and angular momentum, but since only matter (not some "ghosts") can interact with matter, these *changes* will make gravity a *physical field*. There is no 'pool' of positive energy density, reserved exclusively to gravity, so that the latter could interact with its *classical* "source". Geometry itself cannot produced work [1]. People are trying very hard to avoid (not to solve) this problem by resorting to some "vacuum solutions" in which "no matter or non-gravitational fields are present", or use "linearized approximation" in which gravity may be veery "weak" (S. Weinberg).

On the other hand, the gravitational radiation *must* exist, so how can we square the circle? We need a brand new theory of quantum gravity [1] to *understand gravity* and (hopefully) explore it. We need the *common denominator* of *Theory of Relativity* and *Quantum Theory*.

## 2. Quantum-gravitational “brain” of the universe

To model the quantum-gravitational partition of the Universe as a ‘brain’, I will recall the *self-acting* faculty of the *human brain* and suggest that ‘the brain of the universe’ is governed by the same *self-acting phenomenon*. It is *not* like *Baron Münchhausen*. We need the *additional* ‘self-energy’ in QFT (Fig. 1), which Hermann Bondi called, in the context of GR, *intangible energy* [8]. The latter shows up in the physical world *only* as positive mass-energy, after the re-interpretation of “*negative mass*” [1].

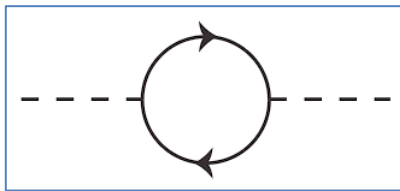

Fig.1

The quantum-gravitational ‘brain of the universe’ (Q) can *also* interact *with itself and by itself*, via the *atemporal* Platonic state (P) of the entire Universe as ONE, like a ‘hand’ (P) in 4D ‘glove’ (Q). The new operator  $P \rightarrow Q$  is located “inside” every single geometric point/4D event Q, along the *radius* (W) of the ‘*inflating balloon*’ in 4+0-dimensional spacetime.

How “large” is the virtual pool of not-yet-physicalized *intangible energy*, pertaining to the *atemporal* Platonic state (P) of the quantum-gravitational ‘brain’ (Q)?

**Indefinite.** It ranges from “positive energy density of about  $6 \times 10^{-10}$  joules per cubic meter” (J. Baez) to  $3 \times 10^{47}$  joules of energy in less than a minute in *gamma-ray bursts*. The upper bound (if any) on Q’s positive energy density is unknown. How much energy (P. Steinhardt) was needed to create the Universe at The Beginning (John 1:1)?

Perhaps we have *unlimited* source of clean energy to resolve the upcoming *climate crisis* [2]. And perhaps *much* more, if only we can create and sustain the so-called ‘bridge’, denoted  $P \rightleftharpoons P$ , between the *atemporal* Platonic state (P) of ‘the universe as a brain’ and the *atemporal* Platonic state (P) of the *human brain*: P is *omnipresent*.

We need *spacetime engineering* [3].

## 3. The Bridge

In my (not humble) opinion, the *semiclassical approximation* to quantum gravity [4] is worse than ‘*spherical cow*’. *Many people* still deeply believe that “classical spacetime should (Sic! – D.C.) emerge in an appropriate limit from quantum theory” (*ibid.*), despite the **bold** fact that the quantum theory *cannot* produce ‘classical spacetime’: the Platonic quantum world (P), dubbed ‘John’, does *not* live on the *light cone*. Only ‘John’s *jackets*’ live there, in *the irreversible* past (Q). Where is ‘the bridge’  $P \rightleftharpoons P$ ? Is there *additional* structure [5] of 4D spacetime (Fig. 1)? What is *physical theology*?



To understand how the *atemporal* Platonic quantum world ( $P$ ) and 'the bridge'  $P \rightleftharpoons P$  are embedded (Fig. 1) in the continuum of 4D events ( $Q$ ), see 'the general rule' [3]: the Platonic world ( $P$ ), dubbed 'John' in *Schrödinger's cat* and 'zero' in *Macavity cat*, does not belong to 4D spacetime [5]. In symbolic terms,  $1 + 0 = 1$ : the probabilities for observing John's *jackets* ( $Q$ -set) sum up *exactly* to 1, whereas the possibility to observe 'John' itself ( $P$ ) is *exactly zero*. Why? Because we can observe *with light* only events in the irreversible past ( $Q$ ) depicted in Fig. 2, from the operator  $P \rightarrow Q$  [1].

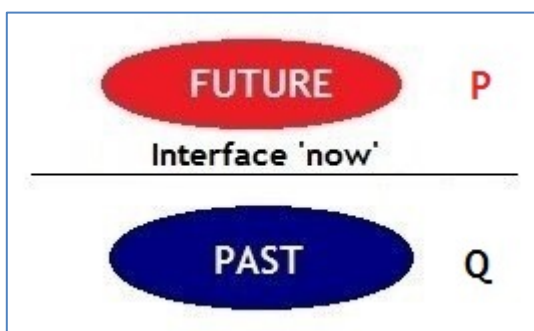

Fig. 2

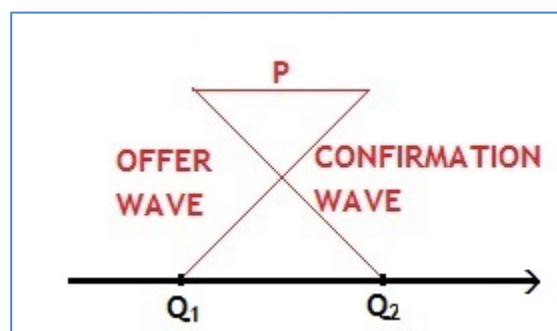

Fig. 3

The infinitesimal ( $Q_2 - Q_1$ ) shown in Fig. 3 is "surrounding any point" in 4D spacetime and we can compute derivatives at  $Q$ . Thanks to the Platonic world ( $P$ ) from the quantization operator  $P \rightarrow Q$ , the 4+0-D spacetime is *perfect* continuum, and we can "recover" the *non-relational* Heraclitean Time in the timelike interval ( $Q_1, Q_2$ ). Again, the duration of *the infinitesimal* ( $Q_2 - Q_1$ ) is neither zero nor finite (Thompson lamp). Time is *both* 'change in space' (coordinate time of  $Q$ ) and 'change of space' (Sic!).

Thus, we can develop *perfectly* continual quantum-gravitational 4+0-D spacetime, in which the inherently *non-local* Platonic gravity ( $P$ ) and *non-local* Platonic quantum world ( $P$ ) become *perfectly* localizable at the "footprint" of  $P$ , denoted  $Q$  above. Read the crux of Kochen-Specker Theorem without math, for Tom, Dick, and Harry [6]: the *atemporal* Platonic world ( $P$ ) is UNcolorizable. It is 'the bridge'  $P \rightleftharpoons P$ .

What if the bridge  $P \rightleftharpoons P$  can entangle the *atemporal* Platonic state ( $P$ ) of the human brain with the *atemporal* Platonic quantum-gravitational world ( $P$ ) as well? If true, we can expect to observe quasi-local gravitational radiation and macroscopic version of quantum tunneling. And *much* more [7], such as 'reversible elimination of inertial mass' (REIM). No, it is not "magic". REIM is about modulating the *rate of time* under the re-interpretation of *negative mass*. Once created, the REIM bridge  $P \rightleftharpoons P$  might produce specific *pattern* in the human brain, which may have distinctive *qualia* accessible by *human volition*, and could also be enhanced with *biofeedback training*.

NB: Everything suggested above will be false from the outset if the metaphysical ideas advocated by Bob Geroch [1] match the actual case of Nature. You will be the judge.

I will leave you with two video clips [7], from Steven Freyne and Wang Yifeng (Yif).





Steven Freyne at Vimeo



Wang Yifeng (Yif) at YouTube

You are expected to believe these clips show some fake "magic", because this is the mainstream [stereotype](#) in our [society](#). Besides, you are a [serious academic scholar](#), not interested in some weird fake "magic". Of course [you will ignore it](#). Good for you.

## References

1. D. Chakalov, The Continuum of Geometric Points. Presented on [26 March 2021](#) at [GRAVITY 21](#), March 26-27, 2021, Munich, EU.
2. *Idem*, Brain-Controlled Cold Plasma (27.11.2019), p. 28. Available at [this http URL](#).
3. *Idem*, Gravitational Energy (22.02.2020), pp. 2-7. Available at [this http URL](#).
4. C. Kiefer, The semiclassical approximation to quantum gravity (9.12.1993), [arXiv:gr-qc/9312015v1](#).
5. D. Giulini, The Rich Structure of Minkowski Space (29 Feb 2008), [arXiv:0802.4345v1 \[math-ph\]](#).
6. Ref. [2], pp. 13-14.
7. D. Chakalov, Über Die Gravitationsfeldrelativitätstheorie (20.03.2020), p. 16. Available at [this http URL](#).
8. Hermann Bondi, Conservation and Non-Conservation in General Relativity, *Proc. R. Soc. Lond. A* 427 (1990) 249-258, cf. [p. 249](#).

[Munich](#), Christmas 2020

The international conference **GRAVITY 21** ([26-27 March 2021](#), Munich) urgently needs financial support by '[the right people](#)'. Email me at [dchakalov@gmail.com](mailto:dchakalov@gmail.com) for details.

I invite all physicists, interested in the origin of gravity, to send their answers to the following questions (please follow the links):

Consider two kitchen scales, **A** and **B**, on a table [at rest](#), and two apples on them, with different weight, say, an apple with 200g on scale **A**, and an apple with 400g on scale **B**. How would you relate their "[trajectories](#)" in 4D spacetime to non-tensorial [Christoffel symbols](#), so that the former will produce different **weight**?

Obviously, the apple with weight 400g on scale **B** will (i) resist [acceleration harder](#) than the apple with weight 200g on scale **A**. Obviously, [something](#) is (ii) doing [work](#) by pressing simultaneously the scales **A** and **B** on the table.

Obviously, (i) = (ii). **What is it?** Please expand your answers to [Earth tides](#).

The foundational questions [above](#) do not included the unsolved issue of gravitational *rotation* ([Richard Feynman](#)), because it is swept under the carpet in [GR textbooks](#).

**NB:** Spacetime is geometry, but can geometry produce *work* on matter? **Yes it can**, by [energy non-conservation](#), but how the [intangible energy](#) [8] becomes '[tangible](#)' one?

The spacetime in GR is endowed with [elasticity](#), namely, it can [deflate](#) and [inflate](#). See three 4D spacetime intervals below, called Alice (**A**), Bob (**B**), and Carol (**C**), all of which are *calibrated* (Sic!) in meters of [light-travel time](#) ([E. Taylor and J.A. Wheeler](#)). **A**, **B**, and **C** have different **RS** size (p. 5 in [7]), but the "number" of geometric points in them is identical: [non-denumerable](#). In this respect, **A**, **B**, and **C** are 'the same'.

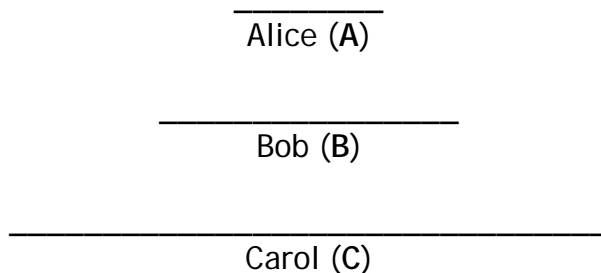

Relative to Bob (**B**), Alice (**A**) is deflated and Carol (**C**) is inflated. It is all [relational](#) (p. 12 in [7]). **All** effects of [gravity](#) are created *by* the [rate of time](#). Thus, we need first to understand the origin of **Time** at **GRAVITY 21** ([26-27 March 2021](#), Munich). How much '[energy from geometry](#)' (**λ**) is needed to propel up↑ the '[elevator](#)' [at rest](#)?

D. Chakalov  
[chakalov.net](http://chakalov.net)

10 May 2020, 20:08 GMT

## About the author



My full name is Dimitar G. Chakalov (pronounced *tcha-KA-lov*, with accent on the second syllable). EU citizen, ID Card 648921850. I am independent researcher, interested in foundations of [Mathematics](#), [quantum gravity](#) and [cosmology](#), and [physics of Life](#). Email [dchakalov@gmail.com](mailto:dchakalov@gmail.com); website shortcut [chakalov.net](http://chakalov.net).

Forty-eight years, ago, in June 1972, I suddenly experienced a beautiful feeling that now I “understand” the so-called [fictitious force in GR](#), after studying GR for nearly five months, since January 1972 (age 19). This ‘gut feeling’ gradually faded away and completely disappeared in December 1973. Never came back. I wish I could have shared my questions with Sir [Hermann Bondi](#) and his colleagues in January 1957, at the famous *Conference on the Role of Gravitation in Physics (January 18-23, 1957)*.

In my opinion, there are many jabberwockies in [GR textbooks](#), which I hope will be sorted out at the international conference **GRAVITY 21 (26-27 March 2021, Munich)**. We need the [common denominator](#) of [Theory of Relativity](#) and [Quantum Theory](#). But in the absence of mathematical formalism (the so-called [hyperimaginary numbers](#)) applicable to the [Platonic world](#), I can only suggest conceptual solutions to conceptual problems, such as “[dark energy](#)” or “[mystery matter](#)”: why is the universe larger than a [football](#)? In QM textbooks, quantum “particles” cannot possess *any* [classical states](#), neither before nor *after* (Sic!) their observation ([Erwin Schrödinger](#)): **why?** Regarding [GR textbooks](#): matter can produce geometry, like the *shape* of a mountain, but can the “shape” (the left-hand side at EFE) *act back* ([John Wheeler](#)) on its “source” (the right-hand side at EFE)? Namely, can *geometry* produce **work**? The list goes on and on.

I claim that my conceptual solutions are unique, in the sense that *any* other solution, with or without math, will *immediately* demolish my theory – Nature does not have “redundant” elements. **It** has unique design, which is both *the* only possible and *the* optimal one. We only have to follow the [facts](#) and assemble our [Weltbild](#) like a giant jigsaw puzzle in which every piece will *effortlessly* fit into its own unique place.

Can we learn [spacetime engineering](#)? Well, can you juggle three balls (p. 13 in [7])?

D. Chakalov  
 10 May 2020, 20:08 GMT

D. Chakalov, Dynamics of 4+0 D Spacetime: Atom of Geometry. Presented on 21 September 2020, in commemoration of Hermann Minkowski's *Raum und Zeit*, 21 September 1908. Watch it at YouTube at [this http URL](#).

I elaborate on the **nullified** 'additional structure' (R. Wald) of 4D spacetime. Here are [Slide 1](#), [Slide 2](#), [Slide 3](#), and [Slide 4](#) of my 20 min talk. Bottom line is the **infinitesimal 'atom of geometry'**, without which there will be **no time and no 3D space** ( $\Delta t \equiv 0$ ). On the one hand, the *atom of geometry* has internal structure, topology, and dynamics ([Slide 2](#) and [Slide 3](#)), but on the other – no *physical* stuff can be "inserted" inside it, and in this sense the *atom of geometry* 'has no part' (Euclid). The solution from [first principles](#) has been proposed by [Plato and Heraclitus](#), and also by [Aristotle](#). Finally, I reiterate my theory of two *modes* of spacetime, presented in my first talk dedicated to Hermann Minkowski's *Raum und Zeit*, on 21 September 2008: *local* (physical) mode pertaining to 'change *in* space' (coordinate time, [Slide 4](#)) and *global* (**Platonic**) mode pertaining to 'change of space' ([Slide 2](#)). The latter is always **nullified** in the *squared* invariant spacetime interval (R. Wald), leading to 4+0 D spacetime. Q.E.D.



This is **not** the *atom of geometry*.

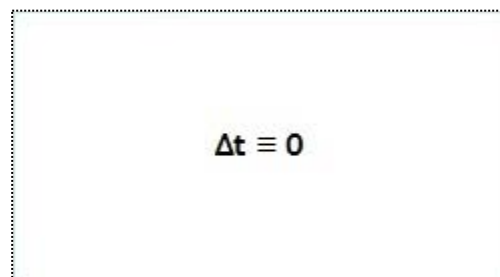

This is **not** the *atom of geometry* either.



We observe (with light) only *colored* (physical) world: matter & fields.



Can 'the grin of the cat' **act back** on the (colored) cat? There is no **explicit time parameter** in GR (C. Rovelli). We need to unravel the **origin of Time**: the *atom of geometry*.

The *local mode* of spacetime, as 'change *in* space', pertains only to (colored) matter & fields (cf. [thermodynamics](#)). It alone *cannot* explain **time asymmetry** and **causality**.

We need the two *modes* of spacetime, as suggested on 21 September 2008, in my first talk, titled *About points, if any*, dedicated to Hermann Minkowski's *Raum und Zeit*: *local* (physical) mode pertaining to 'change *in* space' (the coordinate time, [Slide 4](#)) and *global* (**Platonic**) mode pertaining to 'change of space' ([Slide 2](#)).

We need to find the [Unmoved Mover](#) and reconcile it with the [Theory of Relativity](#). We need a [breakthrough](#). Welcome aboard!

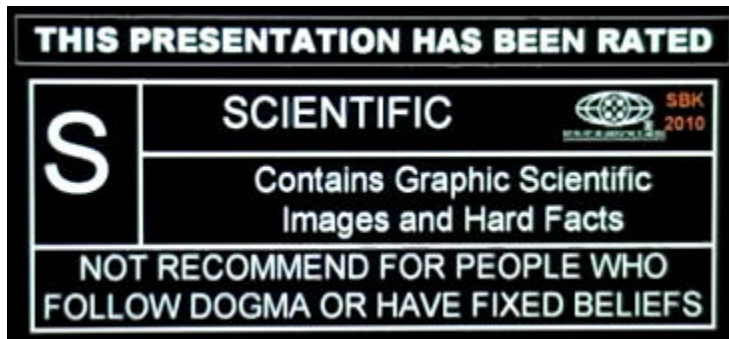

Watch the video »



## 1. Introduction

Facts first.

In the current Theory of Relativity, people like [Bob Geroch](#) reduce the origin of Time ([Slide 2](#)) *exclusively* to matter: Time is made *only* by [matter and fields](#). **Nothing** else. To understand the grave error in this "interpretation", let me illustrate it below.



Detonating cord burning in one direction.  
There is no "[mystery matter](#)" here.



The "[dark energy](#)" is assumed to be some unknown *physical* stuff, maybe [vacuum](#).



In the first place, there is no reference frame in which some “meta observer” could “watch” the entire universe *en bloc*, and time its evolution on some ‘absolute clock’ (M. Chodorowski) “outside” the *inflating spacetime*. Yet in 2011 *three people* were awarded Nobel Prize in physics “for the discovery of the accelerating expansion of the Universe”. Nobody asked them nor any of their distinguished academic colleagues a very simple and dead obvious question: how did they define ‘the entire universe’? With respect to *itself* maybe? We can define, for example, the *boundaries* of the burning cord *above* or those of a *pizza*, but it is *mathematically impossible* to define the (presumably asymptotic) *boundaries* of ‘the entire universe’, for the simple reason that they do not belong to ‘the entire universe’ *anymore*. Read below.

**DEFINITION 2.7.** *Let  $A$  be a subset of a topological space  $X$ . A point  $x$  in  $X$  is a limit point of  $A$  if every neighborhood of  $x$  intersects  $A$  in a point other than  $x$ .*

Notice that a limit point  $x$  of a set  $A$  may or may not lie in the set  $A$ . Notice also that in every topology, the point  $x$  is not a limit point of the set  $\{x\}$ .

**EXAMPLE 2.9.** Consider the set  $A = \{\frac{1}{n} \in \mathbb{R} \mid n \in \mathbb{Z}_+\}$  as a subset of  $\mathbb{R}$  with the standard topology. It is illustrated in Figure 2.3.

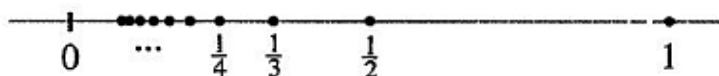

FIGURE 2.3: The set  $A = \{\frac{1}{n} \in \mathbb{R} \mid n \in \mathbb{Z}_+\}$ .

The point 0 is a limit point of  $A$ . Why? If  $U$  is an open set containing 0, then there is an interval  $(a, b)$  such that  $0 \in (a, b) \subset U$ . But  $(a, b) \cap A \neq \emptyset$

Section 2.2    Limit Points    79

for every such open interval. So  $U \cap A \neq \emptyset$ . Therefore every neighborhood of 0 intersects  $A$ , and since 0 is not in  $A$ , the intersection contains points other than 0. It follows that 0 is a limit point of  $A$ .

In fact, 0 is the only limit point of  $A$ . Given  $x \in \mathbb{R} - \{0\}$ , we can find an open interval containing  $x$  that either is disjoint from  $A$  (if  $x \notin A$ ) or intersects  $A$  only in  $x$  (if  $x \in A$ ). In either case, if  $x \neq 0$ , then  $x$  is not a limit point of  $A$ .

Notice the crucial idea of 'open interval' [above](#). It means the following. Consider a [set](#) of ten apples; they all are 'apples', but have slightly different colors and shape, which makes them *individual* viz. countable objects. If you arrange all apples in a row and assign *numbers* to them, then a [closed interval](#) will include all apples: [1, 10]. But the open interval [above](#) does not include its endpoints: (2, 9). Thus, if you decide to talk about the *global* properties of 'all apples', you *must* define their "boundaries". [Simple and clear](#). Only you can't: recall the [Thompson's lamp paradox](#) (Wikipedia).

The seemingly innocent expression that "a limit point  $x$  of a set  $A$  [may or may not](#) lie in the set  $A$ " is a deep [Russian](#) poetry, which I am unable to understand. Moreover, in [our case](#), you may not even *think* about individual viz. countable objects, because the geometric points are *not even* [countably infinite](#). To quote from [Wolfram](#):

Aleph-null bottles of beer on the wall, Aleph-null bottles of beer, take one down, and pass it around, Aleph-null bottles of beer on the wall.

In mathematical notation,  $\aleph_0 - 1 = \aleph_0$ : one 'point' makes no sense at all, and [makes no difference at all](#). Zilch. The poetic expression "*a point other than x*" [above](#) may sound "comprehensible" only to people like [R. Penrose](#).

I have asked (*very* politely) many prominent mathematicians to shed some light on their ideas, since my first talk on 21 September 2008, but the only suggestion came eight years ago, on 21 May 2012, from Prof. Dr. [Maurice de Gosson](#): "Buzz off, idiot!" (Mon, 21 May 2012 18:47:46 +0200). You can't talk with [Russians](#).

(TBC)

The latest version of this paper can be downloaded from [this http URL](#).