

*Final-State-Diagram of quadratic Iterator  
topologically equivalent with  
an Eddy's Decay-Cascade in turbulent Fluids.*



Udo E. Steinemann  
Findeisen-Str. 5/7  
71665 Vaihingen an der Enz  
Germany  
10/09/2018  
email: [udo.steinemann@t-online.de](mailto:udo.steinemann@t-online.de)

**1. Abstract.**

This article refers to the paper <http://vixra.org/abs/1801.0037>, "Turbulence as structured Route of Energy from Order into Chaos", published by Udo E. Steinemann (vixra.org, Category: Physics, Classical Physics, 1801[2]). Within **Conclusion** of the referenced text a statement was made: "This way a picture about an eddy's decay can be drawn as a well structured route of energy from order into chaos, similar to those of many other dynamical systems too". The current text will give additional explanations to this statement.

The current text will sketch the way entrance to chaos is shown for the quadratic iterator and how the major outcomes from this perception can be used in addition to the above mentioned article.

**2. Introduction.**

What are the signs of chaos? There are many dynamical systems that can produce chaos. But in the following focus is on quadratic transformation, which comes in different forms, one of them is for example:

2.1.  $x \rightarrow a \cdot x(1-x)$

It has turned out that the qualitative phenomena of the quadratic transformation are in fact the paradigm of chaos in dynamical systems. Moreover, for the quadratic transformation the properties of chaos can be observed and completely analyzed mathematically.

The next figure shows the computed time-series of  $x$ -values starting at some value  $x_0$  with the parameter set at  $a = 4$ , the parabola is the graph of the iteration function  $a \cdot x(1-x)$  and is the locus of points  $(x_j, x_{j+1})$ :

F.2.1.

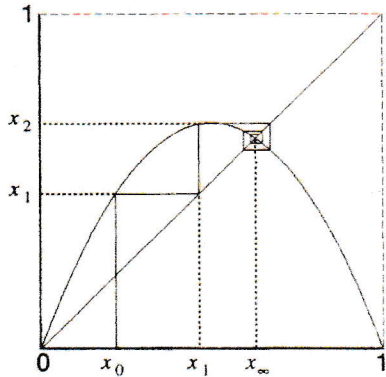

This is called the orbit of  $x_0$ . On horizontal axis the number of iterations is marked, on vertical axis the amplitudes for the iterations are given. The points are connected by segments. It is obvious that graph cannot escape the bounds 0 and 1.

In following figure not only one initial point  $x_0$  but an entire interval is iterated. It can be observed that all values in the interval are attracted by the same final state.

F.2.2.

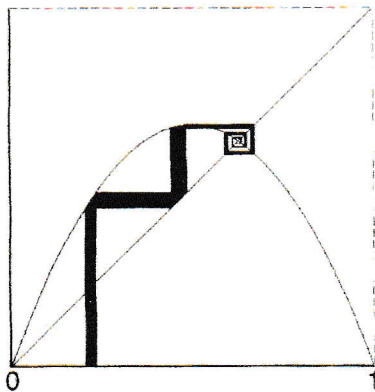

The phenomenon of sensitivity on the initial conditions magnifies even the smallest error, an effect that is demonstrated in the next figures:

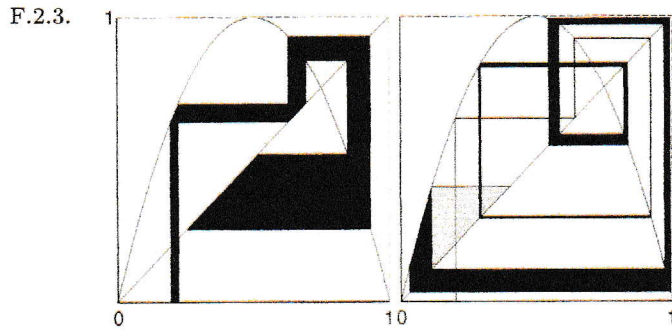

The initial small intervals have already grown considerably after just a few iterations. The property of this sensitivity is central for chaos. In the quadratic iterator  $x = 4 \cdot x(1-x)$  small errors will roughly double in each iteration. The concept of LJAPUNOV-exponents quantifies the average growth of infinitesimally small in the initial point of the iteration. Small error is amplified in the course of iteration, small interval of initial values finally become spread over whole unit interval this behaviour is called mixing. One can describe the mixing property of the iterations in the following way: For any two open intervals (which can arbitrarily small, but must have non-zero length, initial values from one interval can eventually be found in the other interval.

Chaos and order have long been viewed as antagonistic, one of the great surprises revealed through the studies of the quadratic iterator:

2.2.  $x_{j+1} = a \cdot x_j(1 - x_j), j = 0, 1, 2, \dots, a = [1, 4]$

is that both antagonistic states can be ruled by a single law and there is a well defined route which leads from order into chaos. Furthermore it was recognized that this route is universal. Route means that there are abrupt qualitative changes – called bifurcations – which mark the transition from order into chaos like a schedule and universal means that these bifurcations can be found in many natural systems both qualitatively and quantitatively.

One is interested to explore the long term behaviour of the quadratic iterator for all values of the parameter  $a$ . This means one would like to know what will happen to the iterate  $x_j$  when the dependence of the initial choice  $x_0$  is diluted to almost zero. The time-series randomly chosen parameter  $a$  and initial value  $x_0$  after a transient phase of a few iterations the orbit will settle down to a fixed point – called final state –. If one repeats this experiment for different initial values and parameter-values one will reach other final states. If one enters all these states into the final-state-diagram by drawing them versus the values of appropriate parameter-value  $a \in [1, 4]$ , one will come out with the following picture:

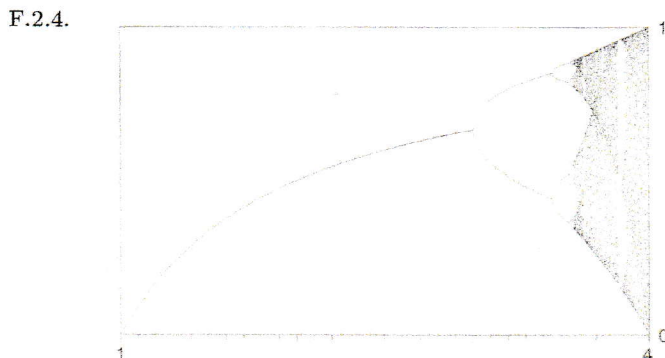

One will note that for  $a > 3$  the final state is not a mere point but a collection of  $2, 4, \dots, 2^k$  points and at parameter-value 4 one will find the chaos discussed previously and the points of the final states fill up the complete interval densely. Sometimes this image is also called FEIGENBAUM-diagram.

One essential structure seen in this FEIGENBAUM-diagram is that of a branching tree which portrays the qualitative changes of the iterator  $x \rightarrow a \cdot x(1-x)$ . Out of a major stem two branches are bifurcating, out of these branches another two branches bifurcate again and so on. This is the period-doubling regime of the scenario.

Where one sees just one branch the long term behaviour of the system tends towards a fixed final state, which, however, depends on the parameter  $a$ . This final state will be reached no matter where – at which initial state  $x_0$  – one starts. If one sees two branches this means that the long term behaviour of the system is now alternating between two different states, a lower and an upper one. This is called periodic behaviour. Since there are two states now, one says that the period is two now. With four branches it happens the period

of final state behaviour as increase from two to four, finally one get a period–doubling–cascades of  $1 \rightarrow 2 \rightarrow 4 \rightarrow \dots \rightarrow 2^k$ . Beyond this period–doubling cascade at the right of end of the figure one can see a structure with a lot of detailed and remarkable designs.

FEIGENBAUM–diagram has features that are both of a qualitative nature and quantitative one. The qualitative feature are best be analyzed by methodology of fractal geometry. The structure in F.2.4 has self–similarity properties.

The following figure shows a sequence of close–ups. The sequence starts with a reproduction of picture F.2.3 and magnifies the rectangular windows in the initial diagram, but showing it upside down. It's the first close–up image, which indeed looks like the whole diagram. A further magnification of the rectangle indicates and shows the result upside down obtaining the second close–up. The third close–up is the last one in the demonstration–series. Theoretically, one could go on infinitely often, as indicated by drawing the next succeeding close–up windows into the bottom image. In other words, the final–state–diagram is as self–similar structure.

F.2.5.

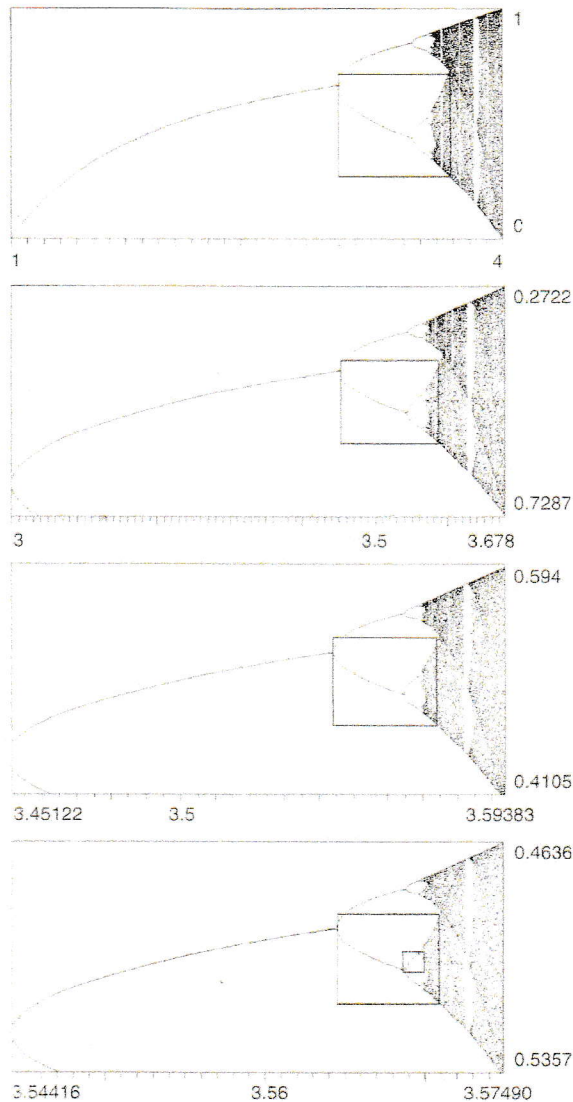

With respect to the quantitative features it has to noted that the branches in the period–doubling regime become shorter and shorter if one looks from left to right. Therefore it is imaginable that the lengths of the branches (in direction of the  $a$ –axis) relative to each other might decrease according to some geometric law. If this is true, it would constitute a threshold, i.e. a value of parameter  $a$  never fallen beyond. This would mark the end of period–doubling regime. There is such a threshold named FEIGENBAUM–point  $a = s_\infty = 3.5699456\dots$ , the value of  $a$  where the sequence of rectangles shown in figure F.2.5 converges. The FEIGENBAUM–point splits the final–state–diagram into two distinct parts, the period–doubling–tree on the left and an area governed by chaos on the right.

There is a rule that quantifies the way the period–doubling–tree approaches the FEIGENBAUM–point, This law can be isolated from the branching behaviour and was exactly the same for many different systems.

Actually, in a very precise sense the law can be captured in just one number measured as  $\delta = 4.6602\dots$  by M. J. FEIGENBAUM 1975 and he also found out that  $\delta$  is universal for many different systems.

The meaning of the universal constant  $\delta$  is: If one measures the lengths two succeeding branches in direction of the  $a$ -axis then their ratio turns out to be approximately  $\delta$ .

F.2.6.

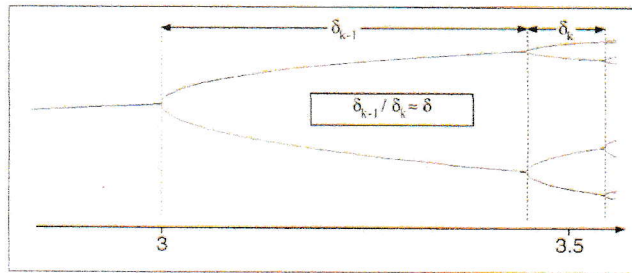

One possible and very useful interpretation of the universality of  $\delta$  is by using it for predictions, By measuring two successive bifurcations one becomes able to predict the bifurcations thereafter and also predict where the threshold would be. Thus although the quadratic iterator in some sense is much to simple to carry information about real systems. in a very striking and general sense it does carry the essential information how systems may develop chaotic behaviour.

In figure F.2.5 the self-similarity feature in final state diagram of the quadratic iterator is already visible in the first part of the diagram. the period-doubling-tree ranging from  $a = 1$  to the FEIGENBAUM-point  $a = s_\infty$ . However the self-similarity in either case is not strict: Although the branches of the tree look like small of the whole tree there are parts, like the stem of the tree, which clearly do not. Moreover, even the branches of the tree are not exact copies of the entire tree. Here one has to use the term self-similarity in a more intuitive sense without being precise.

For the period-doubling-tree everything is more complicated. First, one should note that the sequence of differences  $d_k$  between parameter-values of the bifurcation-points is not precisely geometric. In other words, if one makes close-ups as in figure F.2.5 the scaling-factor slightly changes from close-up to close-up and only approaching the factor  $\delta = 4.6602\dots$ . But this is only true the scaling in horizontal direction of parameter  $a$ . With respect to the vertical direction one has to scale with a factor of approximately 2.3.

F.2.7.

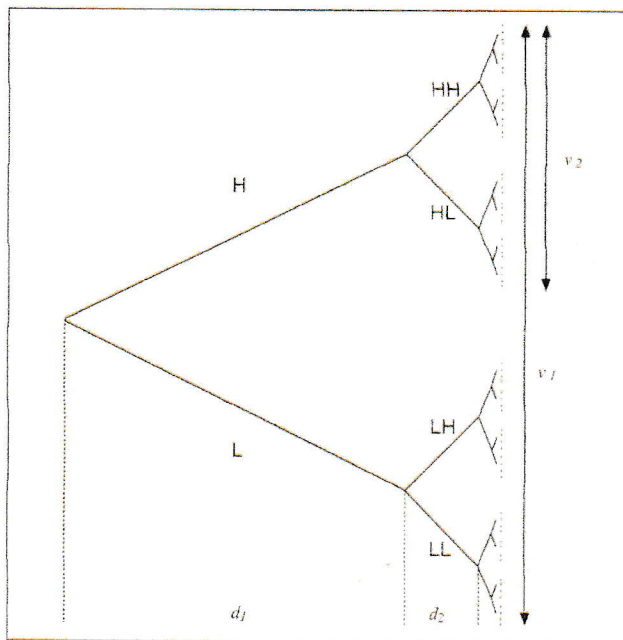

In figure F.2.7 these scaling factors are used to obtain a schematic representation of the period-doubling-tree which exhibits these limiting scaling properties in all stages. It should be noted that the leaves of this tree form a strictly self-similar CANTOR-set. By comparing the tree of figure F.2.7 with the original bifurcation-tree, the non-linear distortion becomes apparent. Here branches of the same stage are exactly the same, In the original period-doubling-tree, branches have different sizes. Nevertheless, one can identify corresponding branches. Also the leaves of the original tree form a CANTOR-set, this happens right at the FEIGENBAUM-point.

**3. Homeomorphism between final–state diagram of the quadratic iterator and decay–cascade of an eddy in a turbulent fluid.**

The final–state–diagram of the quadratic iterator (as described above) is considered as set  $X \in \mathbb{R}^2$ . On  $X$  is a topology  $\Gamma$  declared with following qualities:

3.1.  $\{A_i, A_k \subset X, k \in \langle 2^i, 2^{i+j}, j \in [1, \dots, (2^i - 1)], i, j \in \mathbb{N}^* \rangle\} \in \Gamma$ .

If  $A_p, A_q \in \Gamma$  then  $A_p \cap A_q \in \Gamma$  and if  $[A_n \in \Gamma, n \in \mathbb{N}^*]$  then  $\bigcup_n A_n \in \Gamma$ ; also  $\emptyset, X \in \Gamma$  must hold.  $A_n$  as elements of  $\Gamma$  are open sets, opposite to closed sets for which holds: if  $M \subset \Gamma$  is closed then  $\Gamma - M$  must be open.

The sets  $[A_n \in \Gamma, n \in \mathbb{N}^*]$  declared in 3.1 contain the branches of the final–state–diagram from quadratic iterator up to the FEIGENBAUM–point. A branch is considered to end at the bifurcation–point with the same identification as the proper set  $A$ . The left end of any topological element will be open.

F.3.1.

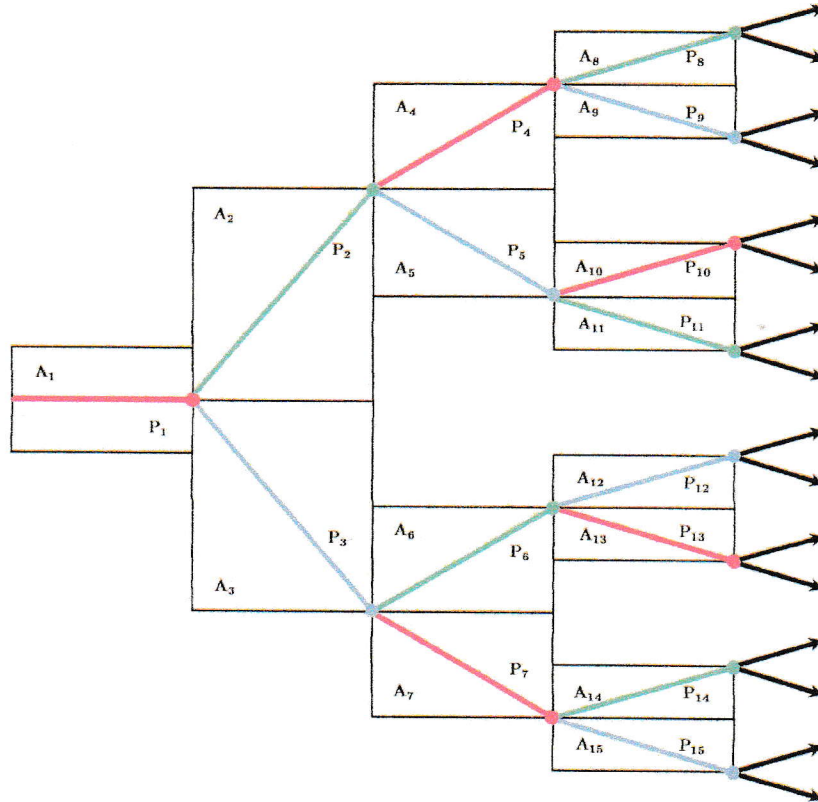

Analog to the quadratic iterator an eddy’s decay–cascade – the period–doubling–tree (described in <http://vixra.org/abs/1801.0037>) – shall be declared as set  $Y \in \mathbb{R}^2$  covered with a topology  $\Delta$ :

3.2.  $\{B_i, B_k \subset Y, k \in \langle 2^i, 2^{i+j}, j \in [1, \dots, (2^i - 1)], i, j \in \mathbb{N}^* \rangle\} \in \Delta$ .

Set  $Y$  finishes to the right with the split–generation corresponding to the FEIGENBAUM–point in final–state diagram from the quadratic iterator. Chaos starts beyond this limit because from here eddies are transformed by friction into heat. What had been declared with respect to  $A_n, X$  and  $\Gamma$  shall be valid for  $B_n, Y$  and  $\Delta$  as well.

For each  $A_n \in \Gamma$  and  $B_n \in \Delta$  exist steady functions  $f_n$  and  $f_n^{-1}$  with:

3.3.  $(f_n: A_n \rightarrow B_n) \wedge (f_n^{-1}: B_n \rightarrow A_n)$ .

The two functions  $f_n$  and  $f_n^{-1}$  are steady on  $A_n$  and  $B_n$  because for any randomly chosen points  $x_0 \in A_n$  and  $y_0 \in B_n$  following relations hold:

3.4.  $\langle \|x - x_0\| < \delta \Rightarrow \|f_n(x) - f_n(x_0)\| < \varepsilon \rangle \wedge \langle \|y - y_0\| < \eta \Rightarrow \|f_n^{-1}(y) - f_n^{-1}(y_0)\| < \xi \rangle$ .

Because  $f_n$  is a bijective function and both  $f_n$  and  $f_n^{-1}$  as well are steady, one can declare  $f_n$  as homeomorphism from  $A_n$  on  $B_n$ . From a topological point of view spaces like  $A_n$  and  $B_n$  may be considered as equivalent.

Because this is valid for any corresponding  $A_n \in \Gamma$  and  $B_n \in \Delta$  one may determine, the tree–structure of the quadratic iterator and the decay–cascade of an eddy in a turbulent fluid are equivalent, both of them show qualitatively the same route from order into chaos.

#### 4. Conclusion.

From the proceeding discussions it becomes obvious, that the text–statement in the paper [4]: "This way a picture about an eddy's decay can be drawn as a structured route of energy from order into chaos, similar to those of many other dynamical systems" now gets its authorization.

#### 5. References.

- [1] H. O. Peitgen, H. Jürgens, D. Saupe, Chaos and Fractals, New Frontiers of Science, Springer Verlag, 1992.
- [2] E. Ossa, Topologie, Vieweg Verlag, 1992.
- [3] B. von Querenburg, Mengentheoretische Topologie, Springer Verlag, 2001.
- [4] U. E. Steinemann, Turbulence as structured Route of Energy from Order into Chaos, 2018. [viXra.com/abs/1801.0037](https://arxiv.org/abs/1801.0037).