

E8 Physics

Frank Dodd (Tony) Smith, Jr. - 2018

Abstract - Introduction

This paper describes a research program based on the 240 E8 Root Vectors encoding the basic structure of a Unified Theory of Fundamental Physics by forming a local classical Lagrangian for the Standard Model plus Gravity and Dark Energy.

The Root Vectors know where they belong in the Lagrangian because of their place in the geometric structure of E8 and its related symmetric spaces such as:

$$E8 / D8 = 128\text{-dim } (OxO)P2$$

$$E8 / E7 \times SU(2) = 112\text{-dim set of } (QxO)P2 \text{ in } (OxO)P2$$

$$D8 / D4 \times D4 = 64\text{-dim } Gr(8,16)$$

Embedding E8 local classical Lagrangian into $Cl(0,16)$ Clifford Algebra and taking the completion of the union of all tensor products of all the $Cl(0,16)$ s produces a generalization of hyperfinite II1 von Neumann factor fermionic Fock space forming a global AQFT describing spacetime, the Standard Model, and Gravity with Dark Energy. The structure is related to unconventional 26D String Theory by

$$Cl(0,16) \rightarrow Cl(0,16) \times Cl(0,8) = Cl(0,24) \rightarrow M(2, Cl(0,24)) = Cl(1,25)$$

Completion of Union of All Tensor Products of $Cl(1,25) = 2 \times 2$ matrices of $Cl(0,24)$ is the String Theory formulation of the hyperfinite AQFT.

The $Cl(1,25)$ of 26D String Theory contains $Cl(0,16)$ which contains E8 whose root vectors describe a Lagrangian for the Standard Model and Gravity + Dark Energy.

The paper describes physical interpretations of the 240 Root Vectors and how they are used in calculating force strengths, particle masses, Kobayashi-Maskawa parameters, Dark Energy : Dark Matter : Ordinary Matter ratios, etc.

that can be compared with Experimental Observations which are given up to and including the 2017 run of the LHC in the Higgs $\rightarrow ZZ \rightarrow 4l$ channel which is relevant to the E8 Physics prediction of 3 Mass States of the Higgs and Truth Quark:

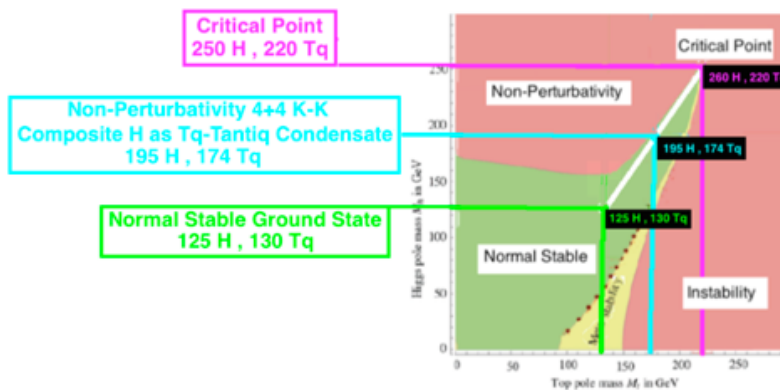

Table of Contents:

Abstract - Introduction ...	page 1
Table of Contents ...	page 2
Clifford Algebra $Cl(8) \times Cl(8) = Cl(16)$ and E8 ...	page 4
Evolution of Our Universe from initial VOID ...	page 5
240 E8 Root Vectors Physical Interpretation ...	page 10
Gauge Bosons and Ghosts ...	page 12
Spacetime, Unimodular Gravity, and Strong CP ...	page 16
Fermions ...	page 18
Evolution of our Universe and E8 Real Forms ...	page 20
From Void to AQFT via Clifford Algebra ...	page 20
E8 Real Forms ...	page 21
E8(-248) Big Bang ...	page 23
Compact Structures in Physics Models ...	page 24
E8(8) Inflation and 26D Strings = World-Lines ...	page 25
Lagrangian ...	page 26
Chirality and Spin-Statistics and F4 and E8 ...	page 26
Giza Pyramids: F4 in $Cl(8) \times F4$ in $Cl(8) = E8$ in $Cl(16)$...	page 32
Ultraviolet Finite ...	Page 36
Coleman-Mandula ...	page 42
Octonionic NonUnitary Inflation Particle Creation ...	page 48
Bohm Quantum Potential with Sarfatti Back-Reaction and AQFT as Third Grothendieck Universe ...	page 54
AQFT Quantum Code ...	page 58
World-Line = String and 26D String Theory ...	page 63
26D String Theory has 10D = 6D Conformal + 4D CP2 ...	page 65
Construction of 26D String Theory ...	page 66
AQFT of Bohm 26D String Theory ...	page 77
Monster Symmetry of 26D String ...	page 81
Fundamental Fermion as Schwinger Source ...	page 85
26D String Theory as Affinization of single Cell ...	page 87
ADE and Quantum Consciousness ...	page 93
Penrose-Hameroff Quantum Consciousness ...	page 98
Higgs and Spacetime Condensates ...	page 111
End of Octonionic Inflation - E8(-24) Quaternionic Present Era ...	page 115
Transition from $SO(16)$ and $SO(8,8)$ to $SO^*(16)$...	page 119
Higgs from Mayer Mechanism ...	page 127
3 Generations of Fermions ...	page 157
Schwinger Sources, Hua Geometry, and Wylers Calculations ...	page 158
Bulk-Boundary Physics ...	page 159
Schwinger Source: Monster Size and Mandelbrot Julia Structure ...	page 167
Monster Group ...	page 168
Mandelbrot Sets ...	page 172
Julia Sets ...	page 174
Schwinger Source Structure and Julia Sets ...	page 176

Julia Sets of Schwinger Sources and Green's Functions ...	page 182
Indra's Net ...	page 185
Bohm Quantum Potential ...	page 186
Lagrangian Structure ...	page 188
E8 from two copies of F4 ...	page 189
Schwinger Source Jewels of Indra's Net ...	page 190
Bohm Quantum Schwinger Source Blockchain ...	page 192
Schwinger Source Green's Function Geometry ...	page 194
Force Strength and Boson Mass Calculations ...	page 198
Fermion Mass Calculations ...	page 210
Kobayashi-Maskawa Parameters ...	page 226
Neutrino Masses Beyond Tree Level ...	page 236
Proton-Neutron Mass Difference ...	page 241
Pion as Sine-Gordon Breather ...	page 242
Planck Mass as Superposition Fermion Condensate ...	page 247
Conformal Gravity - DE:DM:OM ..	page 248
Pioneer Anomaly ...	page 258
Warp Drive ...	page 263
Kepler Polyhedra and Planets ...	page 267
Nambu-Jona-Lasinio Higgs-Tquark 3-state System ...	page 275
E8 Physics Calculation Results ...	page 280
Massless Realm Beyond EW Symmetry Breaking ...	page 281

Appendices:

Appendix - 256 Cellular Automata ...	page 285
Appendix - Braids, E8, and E6 Conformal Penrose Tiling ...	page 297
Giza Pyramids ...	page 306
E8 - H4 - H3 - H2 ...	page 307
E6 Conformal Penrose Tiling ...	page 315
Appendix - Tetrahedra and E8 Physics ...	page 330
Appendix - Mathematica CDF for 2D projection of E8 Root Vectors ...	page 344
Appendix - 4-dim M4 Spacetime Feynman Checkerboard ...	page 350
Appendix - Quaternion Hurwitz Shells - Primes and Powers of 2 ...	page 363
Appendix - Renormalization, NCG, and Tquark mass states ...	page 384
Appendix - Mendel Sachs and Particle Masses ...	page 394
Appendix - Joy Christian Correlations ...	page 396
Appendix - History of Truth Quark and Higgs Experiments ...	page 403
CDF sees 3 Truth Quark Mass States ...	page 405
D0 sees 3 Truth Quark Mass States ...	page 406
LHC Higgs and Fermilab Truth Quark Experiments ...	page 407
Consensus View v. E8 Physics View ...	page 408
LHCP Bologna 2018 and 3 Higgs Mass States ...	page 409
BALONEY in Bologna ...	page 414
Consensus or E8 Physics View: What difference does it make ? ...	page 415
NJL Higgs-Truth Quark System ...	page 416
Some Truth Quark Experiments ...	pages 421
Varnes thesis ...	pages 426-431
Why did Fermilab reject Multiple Truth Quark Mass States ? ...	page 435
Implications for the Future of Physics ...	page 440

Clifford Algebra $Cl(8) \times Cl(8) = Cl(16)$ and E_8

Where does the E_8 of E_8 Physics come from ?

Human Understanding is based on Geometry of the Space and Time in which we live.

William Kingdon Clifford (1845 - 1879) described that Geometry in terms of his invention: Real Clifford Algebras, which he called "mind-stuff", saying:

"... That element of which ... even the simplest feeling is a complex,
I shall call Mind-stuff.

A moving molecule of inorganic matter does not possess mind or consciousness ; but it possesses a small piece of mind-stuff. ...

When molecules are ... combined together ... the elements of mind-stuff which go along with them ... combine ... to form the ... beginnings of Sentience.

When the molecules are so combined as to form the brain and nervous system ... the corresponding elements of mind-stuff are so combined as to form some kind of consciousness ... changes in the complex which take place at the same time get so linked together that the repetition of one implies the repetition of the other.

When matter takes the complex form of a living human brain, the corresponding mind-stuff takes the form of a human consciousness ...".

(Wikipedia - (1878, "On the Nature of Things-in-Themselves", Mind, Vol. 3, No. 9, pp. 57–67))

For example:

our 3-dimensional Space with coordinates $x y z$

is described by the $Cl(3)$ Clifford Algebra whose total dimension is $1+3+3+1 = 8$

1 for one type of 0-dim point

3 for three types of lines / directions in space
 $x \ y \ z$

3 for three types $xy \ yz \ zx$ of planes in space:

1 for all of 3-space itself

Generally, $Cl(N)$ of N -dim space has dimension 2^N

so the process of forming Clifford Algebra

creates 2^N -dim spaces from N -dim spaces

David Finkelstein (1929 - 2016) applied Real Clifford Algebras to the Origin and Evolution of Our Universe by seeing Our Universe as emerging from its Parent Universe by a VOID Quantum Fluctuation which evolves by Iterating the Process of forming Clifford Algebras

(Finkelstein, Int. J. Theor. Phys. 2017 56 : 2-39)

so

THIS IS HOW OUR UNIVERSE GREW FROM NOTHING to the 65,536-dimensional Real Clifford Algebra Cl(16)

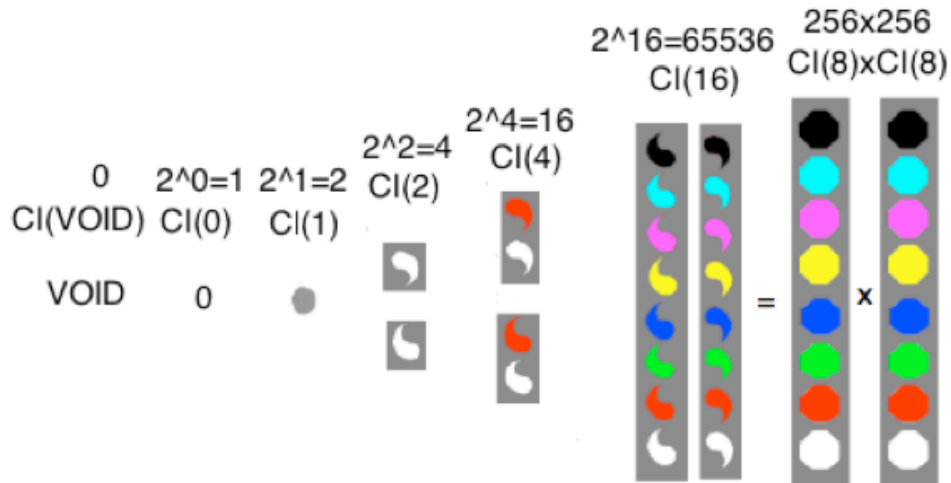

Cl(16) can be factored into the tensor product of two copies of Cl(8)

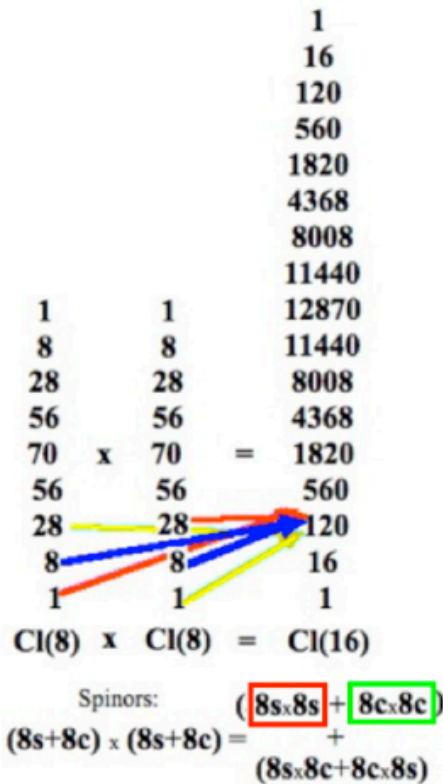

because tensor product on N copies of Cl(8) is Cl(Nx8) - a property called 8-Periodicity

Each of the two $Cl(8)$ have 8s Half-Spinors for left-helicity Fermion Particles and 8c Half-Spinors for right-helicity Fermion AntiParticles. $Cl(16)$ has by tensor product $Cl(8) \times Cl(8)$ 4 64-dim parts to its 256-dim Spinor structure:

$$8s \times 8s + 8s \times 8c + 8c \times 8s + 8c \times 8c$$

only 2 of which $8s \times 8s + 8c \times 8c$ form a 128-dim $Cl(16)$ Half-Spinor space with well-defined helicity, so only $8s \times 8s + 8c \times 8c$ form the 128-dim D8 Half-Spinors of E8.

$Cl(8)$ is $2^8 = 256$ - dimensional and is the Algebra of 16x16 Real Matrices $M(R,16)$.

```

x x x x x x x x x x x x x x x
x x x x x x x x x x x x x x x
x x x x x x x x x x x x x x x
x x x x x x x x x x x x x x x
x x x x x x x x x x x x x x x
x x x x x x x x x x x x x x x
x x x x x x x x x x x x x x x
x x x x x x x x x x x x x x x
x x x x x x x x x x x x x x x
x x x x x x x x x x x x x x x
x x x x x x x x x x x x x x x
x x x x x x x x x x x x x x x
x x x x x x x x x x x x x x x
x x x x x x x x x x x x x x x
x x x x x x x x x x x x x x x
x x x x x x x x x x x x x x x
x x x x x x x x x x x x x x x

```

The 16 blue column vectors are the Spinors of $Cl(8)$. They reduce to two sets of 8-dim Half-Spinors that are mirror images of each other:

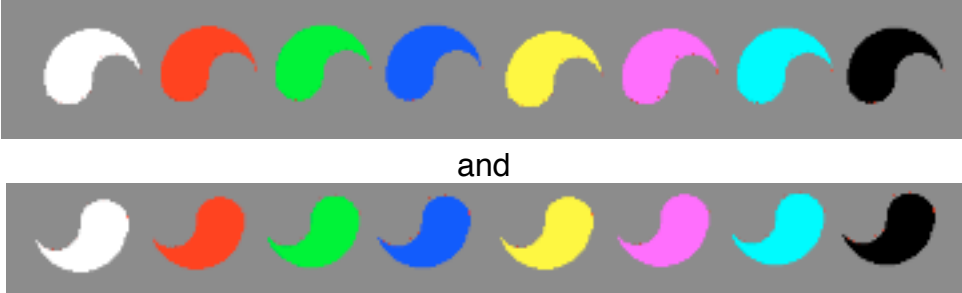

They describe the entanglements of connections to the 8-dim Vector Space of $Cl(8)$.

By the **Triality** property of $Cl(8)$ each of the $Cl(8)$ Half-Spinors is isomorphic to the 8 Vectors of $Cl(8)$



Now consider $Cl(16) = \text{tensor product } Cl(8) \times Cl(8)$:

$Cl(16) = 2^{16} = 65,536$ dimensions with graded structure

1 16 **120** 560 1820 4368 8008 11440 12870 11440 8008 4368 1820 560 120 16 1

The **120** grade-2 BiVectors form the D8 Lie Algebra that is related to rotations in 16-dim space

The Real Clifford Algebra $Cl(16) = 256 \times 256$ Real Matrix Algebra

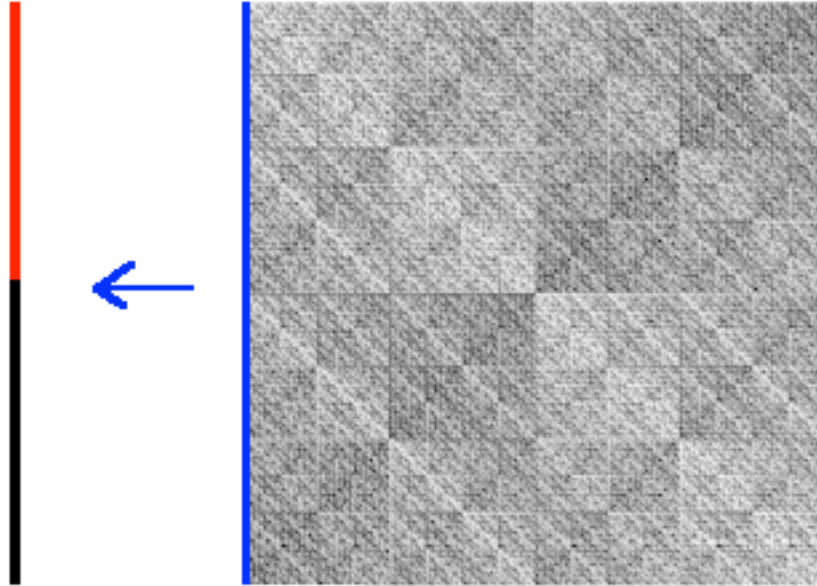

The **256** first-column-vectors are the Spinors of D8 that are related to entanglement of connections to 16-dim space
The **256** D8 Spinors break down into two half-Spinors
 $256 = 128 + 128$

The **128** and 128 half-spinors are mirror images of each other so **128** can describe all useful physics by itself.

120 D8 BiVectors + **128** D8 half-Spinors = **248**-dim E8
E8 / D8 = 64 + 64 Fermions = **128**-dim D8 half-Spinors of $Cl(16)$

D8 / D4 x D4 = 64 Spacetime

D4 = 28 Standard Model (12)
with 16 Gravity + Dark Energy Ghosts

D4 = 28 Gravity + Dark Energy (16)
with 12 Standard Model Ghosts

Here is how Our Universe grew beyond the Cl(16) stage:

The Creation Sequence continues from Clifford Iteration

$$0 \rightarrow Cl(0,0) \rightarrow Cl(0,1) \rightarrow Cl(0,2) \rightarrow Cl(0,4) \rightarrow Cl(0,16) = Cl(0,8) \times Cl(0,8)$$

(where (p,q) denotes the signature of the Real Vector Space of Cl(p,q))

to Cl(0,24) by Tensor Product

$$\rightarrow Cl(0,8) \times Cl(0,8) = Cl(0,16) \rightarrow Cl(0,16) \times Cl(0,8) = Cl(0,24)$$

Cl(0,24) contains the Vector Space of the 24-dim Leech Lattice Λ_{24} that is composed of 3 copies of E8 Lattices (2 being Integral Domains and 1 not Algebraically closed)

The Creation Sequence then continues by constructing the Conformal Structure of 2x2 matrices with entries in $Cl(0,24) = M(2, Cl(0,24))$
(Porteous, Clifford Algebras and the Classical Groups and Lounesto and Porteous, Lectures on Clifford (Geometric) Algebras and Applications)

$$\rightarrow M(2, Cl(0,24)) = Cl(1,25)$$

Since all the matrix entries are $Cl(0,24) =$ tensor product of 3 copies of $Cl(0,8)$
8-Periodicity allows formation of the tensor products of copies of $Cl(1,25)$

\rightarrow Completion of Union of All Tensor Products of $Cl(1,25) =$ hyperfinite AQFT

The hyperfinite AQFT has Real / Octonionic structure inherited from $Cl(0,8)$
and
it also has Quaternionic structure due to

$$Cl(1,25) = Cl(1,9) \times Cl(0,8) \times Cl(0,8) \text{ and } Cl(1,9) = Cl(1,5) \times Cl(0,4) = Cl(2,4) \times Cl(0,4)$$

where

the vector space of $Cl(2,4)$ is 6-dim Conformal Spacetime
which contains 4-dim Minkowski Spacetime M_4 of $Cl(1,3)$ by twistor $Spin(2,4) = SU(2,2)$
and

the vector space of $Cl(0,4)$ corresponds to $CP^2 = SU(3) / SU(2) \times U(1)$
so that

before breaking Octonionic symmetry non-unitarity of Octonion Quantum Processes allows particle creation during the Inflation Era

(Adler, Quaternionic Quantum Mechanics and Quantum Fields, pages 50-52, 561)

and

after breaking non-unitary Octonionic 8-dim Spacetime to unitary Quaternionic Spacetime, thus ending the Inflation Era, the Spacetime of the hyperfinite AQFT is (4+4)-dim $M_4 \times CP^2$ Kaluza-Klein (Real Form E8(-24))

**The E8 contained in Cl(0,16) contained in Cl(1,25) is not a conventional Gauge Group
but
is a Recipe for a Realistic Physics Lagrangian:**

Fermion Terms:

E8 / D8 = 128-dim = 8-dim Spacetime Components of 8 Fermion Particles
+
8-dim Spacetime Components of 8 Fermion AntiParticles

Spacetime Base Manifold Terms:

D8 / D4 x D4 = 64-dim = 8-dim Spacetime Position x 8-dim Spacetime Momentum
related to Unimodular Gravity of A7 = SL(R,8)

Gauge Boson and Ghost Terms:

The two 28-dim D4 correspond to the M4 and CP2 of M4 x CP2 Kaluza-Klein

D4_M4 = 16-dim U(2,2) containing SU(2,2) = Spin(2,4) Conformal Gravity
and 12 Standard Model Ghosts

D4_CP2 = 8-dim SU(3) Color Force plus 4 Translation Gravity Ghosts
and 12 Conformal Gravity Ghosts

Electroweak SU(2) x U(1) come from Little Group of CP2 = SU(3) / SU(2) x U(1)
(Batakis, Class. Quantum Grav.3 (1986) L99-L105)

**This E8 Structure can be seen in terms of its 240 Root Vectors
each of which has a realistic Physics Interpretation:**

240 E8 Root Vectors Physical Interpretation

248-dim Lie Group E8 has 240 Root Vectors arranged on a 7-sphere S^7 in 8-dim space.

Since it is hard to visualize points on S^7 in 8-dim space,
I prefer to represent the 240 E8 Root Vectors in 2-dim / 3-dim space
as in this 2D representation by Ray Aschheim (see Appendix - Mathematica CDF)

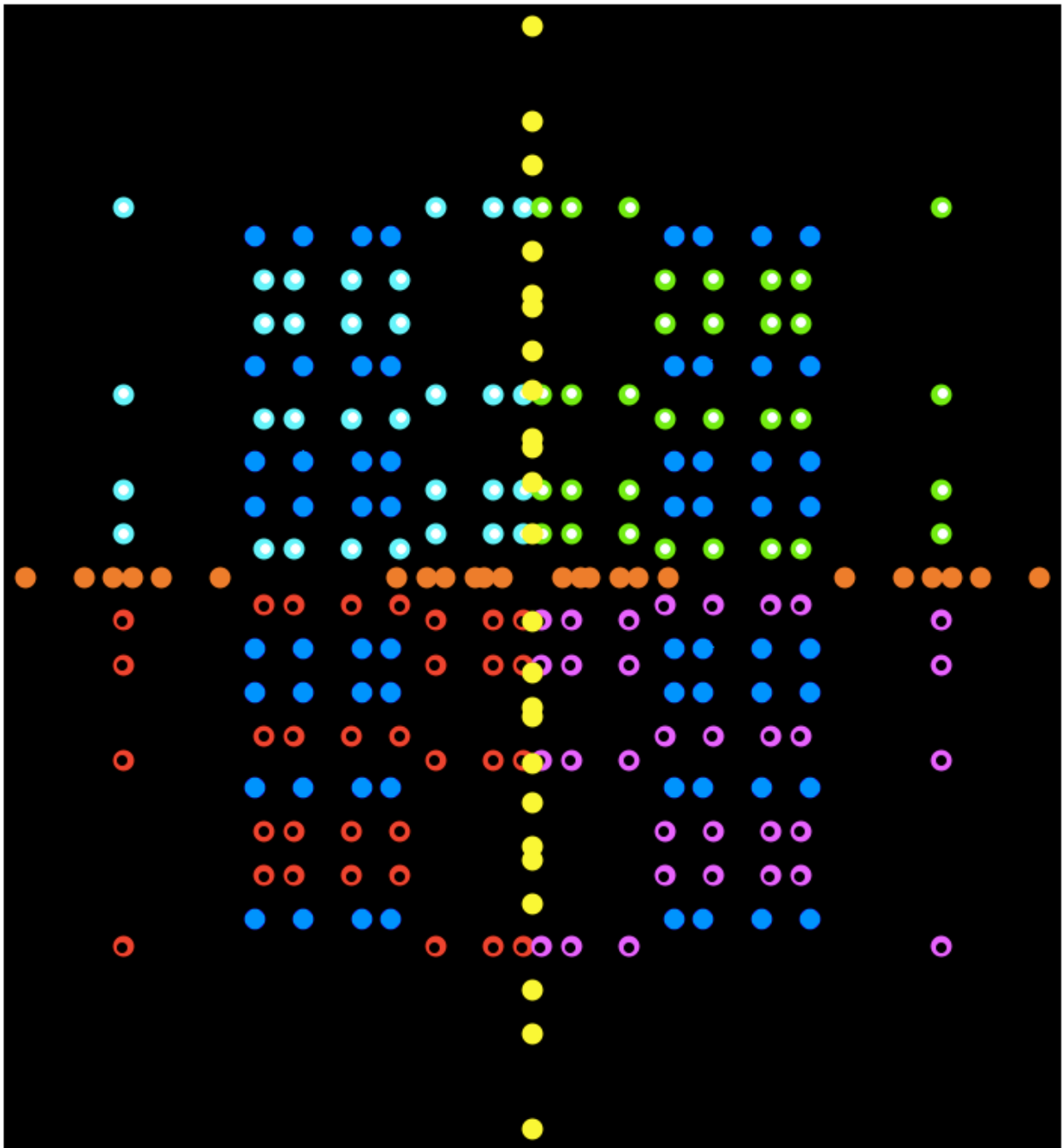

To understand the Geometry related to the 240 E8 Root Vectors, consider that
 248-dim E8 = 120-dim Spin(16) D8 + 128-dim half-spinor of Spin(16) D8
 240 E8 Root Vectors = 112 D8 Root Vectors + 128 D8 half-spinors
 there are two ways to see a maximal symmetric subspace of E8 and E8 Root Vectors:
 the symmetric space corresponding to the 128 D8 half-spinors

E8 / D8 = 128-dim Octonion-Octonionic Projective Plane (OxO)P2

the symmetric space corresponding to the 112 D8 Root Vectors

E8 / E7 x SU(2) = 112-dim set of (QxO)P2 in OxO)P2

Geometric Structure leads to physical interpretation of the E8 Root Vectors as:

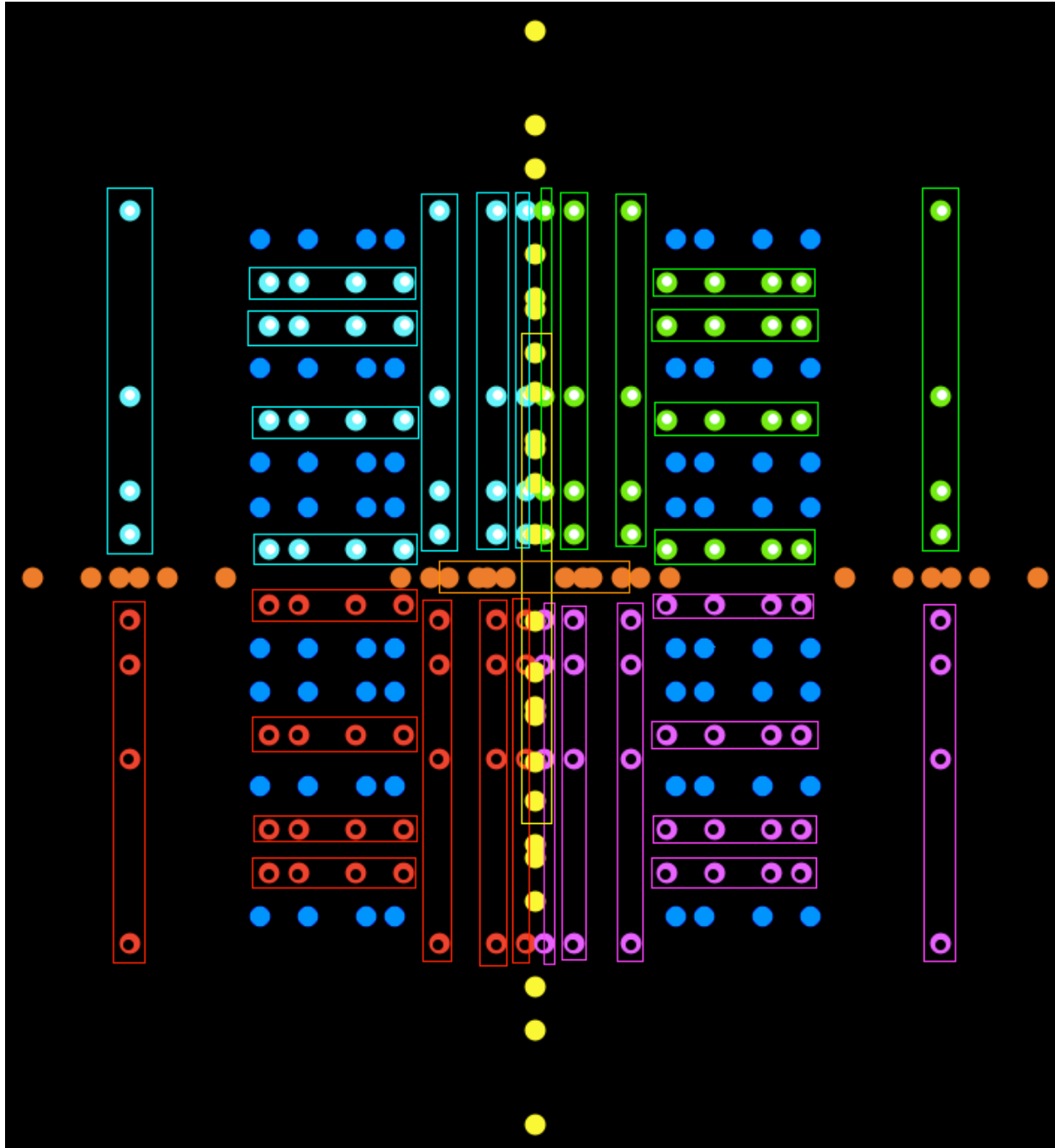

$$240 = 24 + 24 + 64 + 64 + 64$$

Orange and Yellow dots correspond to Root Vectors of the two D4 subalgebras of E8 each of which has 24 Root Vectors.

Blue dots correspond to the 64 elements of D8 that make up D8 / D4xD4.

Green and Cyan dots with white centers (32+32 = 64 dots) and
Red and Magenta dots with black centers (32+32 = 64 dots)
correspond to the 128 elements of E8 / D8.

The 24 Orange Root Vectors of the D4 of E8 Standard Model + Gravity Ghosts are on the Horizontal X-axis.



8 of them in the Orange Box represent the 8 Root Vectors of the Standard Model Gauge Groups SU(3) SU(2) U(1).
Their 4 Cartan Subalgebra elements correspond to the 4 Cartan Subalgebra elements of D4 of E8 Standard Model + Gravity Ghosts and to half of the 8 Cartan Subalgebra elements of E8.

The other 24-8 = 16 Orange Root Vectors represent Ghosts of 16D U(2,2) which contains the Conformal Group SU(2,2) = Spin(2,4) that produces Gravity + Dark Energy by the MacDowell-Mansouri mechanism.

Standard Model Gauge groups come from CP2 = SU(3) / SU(2) x U(1)
(as described by Batakis in Class. Quantum Grav. 3 (1986) L99-L105)

Electroweak SU(2) x U(1) is gauge group as isotropy group of CP2.

SU(3) is global symmetry group of CP2 but due to Kaluza-Klein M4 x CP2 structure of compact CP2 at every M4 spacetime point, it acts as Color gauge group with respect to M4.

The $24-8 = 16$ D4 of CP2 Root Vectors represent Ghosts of SU(2,2) Conformal Gravity and Propagator Phase Internal Clock U(1) of U(2,2) .

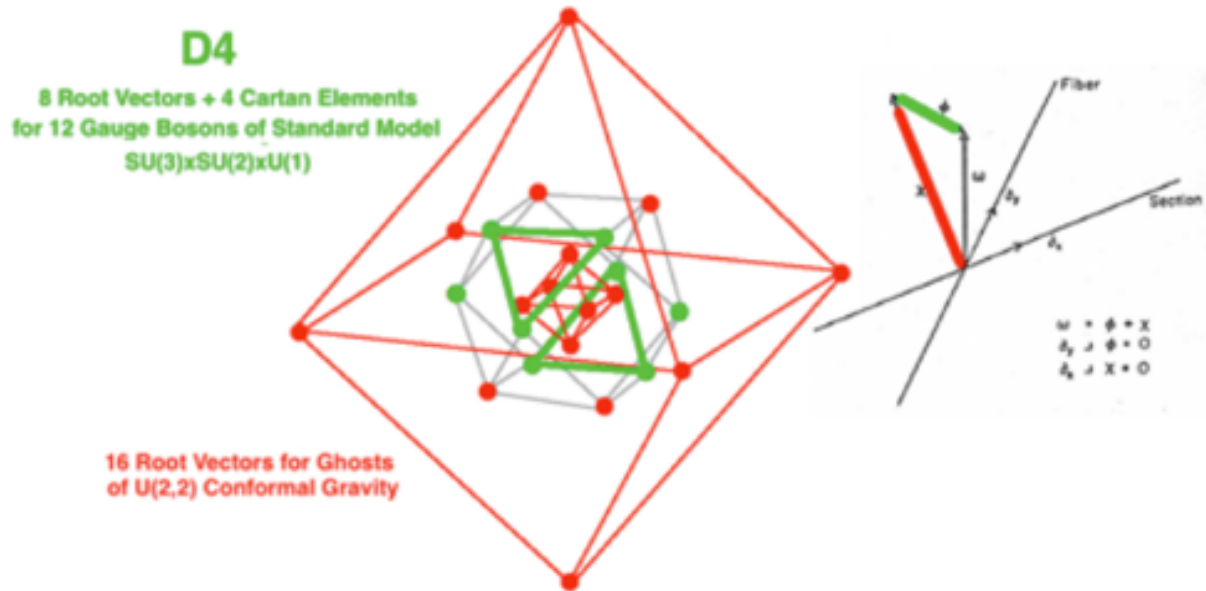

Jean Thierry-Mieg in J. Math. Phys. 21 (1980) 2834-2838 said:

“... The ghost and the gauge field:

The single lines represent a local coordinate system of a principal fiber bundle of base space-time.

The double lines are 1 forms.

The connection of the principle bundle w is assumed to be vertical.

Its contravariant components ϕ and X are recognized, respectively, as the Yang-Mills gauge field and the Faddeev-Popov ghost form ...”.

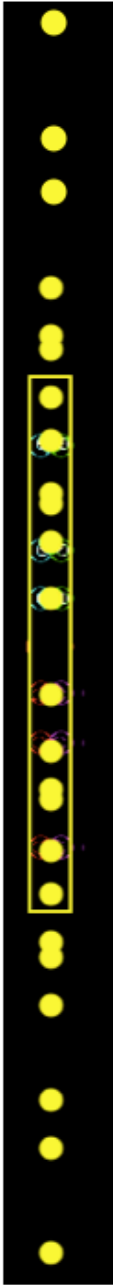

The 24 Yellow Root Vectors of the D4 of E8 Gravity + Standard Model Ghosts are on the Vertical Y-axis.

12 of them in the Yellow Box represent the 12 Root Vectors of the Conformal Gauge Group $SU(2,2) = Spin(2,4)$ of Conformal Gravity + Dark Energy.

The 4 Cartan Subalgebra elements of $SU(2,2) \times U(1) = U(2,2)$ correspond to the 4 Cartan Subalgebra elements of D4 of E8 Gravity + Standard Model Ghosts and to the other half of the 8 Cartan Subalgebra elements of E8.

The other $24 - 12 = 12$ Yellow Root Vectors represent Ghosts of 12D Standard Model whose Gauge Groups are $SU(3) SU(2) U(1)$.

Gravity and Dark Energy come from its Conformal Subgroup $SU(2,2) = Spin(2,4)$
(see Appendix - Details of Conformal Gravity and ratio DE : DM : OM)

$SU(2,2) = Spin(2,4)$ has 15 generators:

1 Dilation representing Higgs Ordinary Matter

4 Translations representing Primordial Black Hole Dark Matter

10 = 4 Special Conformal + 6 Lorentz representing Dark Energy
(see Irving Ezra Segal, "Mathematical Cosmology and Extragalactic Astronomy" (Academic 1976))

The basic ratio Dark Energy : Dark Matter : Ordinary Matter = 10:4:1 = 0.67 : 0.27 : 0.06
 When the dynamics of our expanding universe are taken into account, the ratio is calculated to be **0.75 : 0.21 : 0.04**

The U(1) of $SU(2,2) \times U(1) = U(2,2)$ represents the Propagator Phase Internal Clock

David Finkelstein in "The Space-Time Code" Phys. Rev. 184 (1969) 1261-1271 said "... Since Einstein we have ... one four-dimensional continuum. More important, the structure of this continuum is not that of a changing metric space but that of a space with an order relation between its points, causal or chronological precedence ...

The important thing about the line for us is its order ... not the metric structure ...

The basic object of the ordered quantum space - a quantum set of quantum digits - is then called a quantum "word." We set the problem of "breaking the space-time code": finding finite quantum rules for word generation such that the order of generation gives the causal order of space-time and thus ...[its]... entire geometrical structure ...

we could ... call them **chronons**, since their creation is to be the passage of time ...
The singular code (repetitions of one digit) gives a linearly ordered external world of one time dimension and a circular internal space ...
 the words of the singular code ($n=1$) in their causal order are $\emptyset, 0, 00, 000, \dots$

FIG. 1. Quantized time axis. This graph defines the causal order of a causal quantum space whose classical limit is the real time axis. The quantum space is isomorphic to the linear harmonic oscillator and is the space of a character in the quantum singular code. A dot (\bullet) is an element of a frame in the Hilbert space. An upward line segment implies a causal order relation. In the classical limit, this space becomes the positive time axis with the usual causal order and measure and an internal space in the form of a circle arising from the possibility of coherent superpositions of adjoint elements.



... An external coordinate system ... determine[s] the causal relation ...
 An internal coordinate ... generates an internal symmetry ...”.

D4 of E8 Gravity + Standard Model Ghosts = M4 External part of E8 Physics.

D4 of E8 Standard Model + Gravity Ghosts = CP2 Internal part of E8 Physics.

The $24-12 = 12$ D4 of M4 Root Vectors represent Standard Model Ghosts

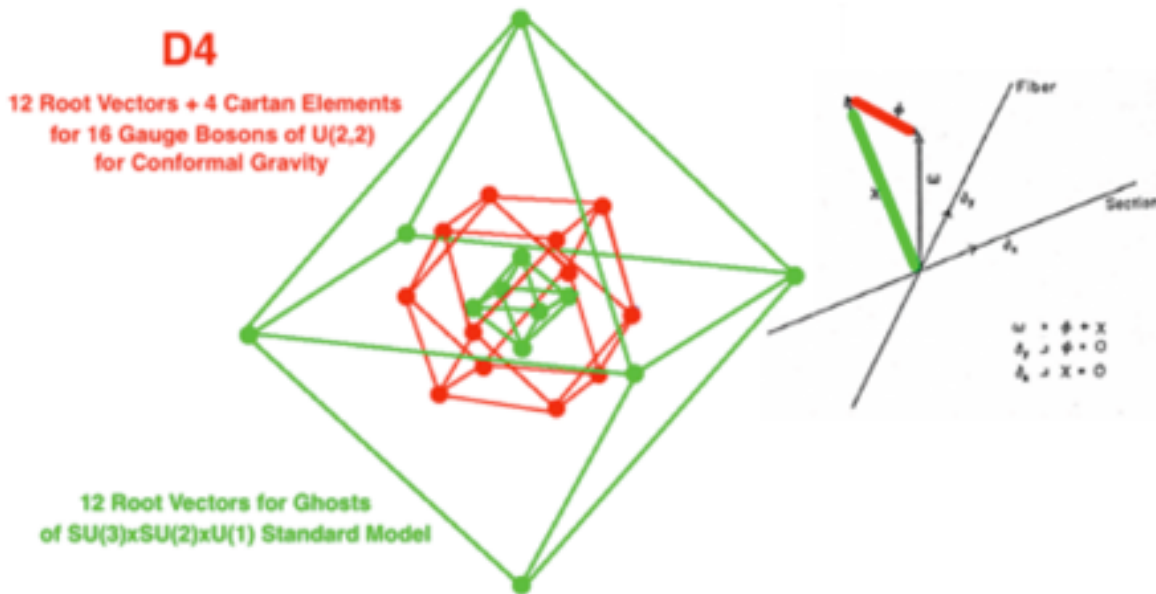

Jean Thierry-Mieg in J. Math. Phys. 21 (1980) 2834-2838 said:

“... The ghost and the gauge field:

The single lines represent a local coordinate system of a principal fiber bundle of base space-time.

The double lines are 1 forms.

The connection of the principle bundle w is assumed to be vertical.

Its contravariant components Φ and X are recognized, respectively, as the Yang-Mills gauge field and the Faddeev-Popov ghost form ...”.

Spacetime, Unimodular Gravity, and Strong CP

The 64 Blue Root Vectors of the space $D_8 / D_4 \times D_4$ represent 8D Spacetime and the $A_7 = SL(8, R)$ of Unimodular Gravity that is in the Maximal Contraction Heisenberg Algebra of E_8 with structure $28 + 64 + (A_7+1) = 64 + 28$.

(see Rutwig Campoamor-Stursberg in "Contractions of Exceptional Lie Algebras and SemiDirect Products" (Acta Physica Polonica B 41 (2010) 53-77)

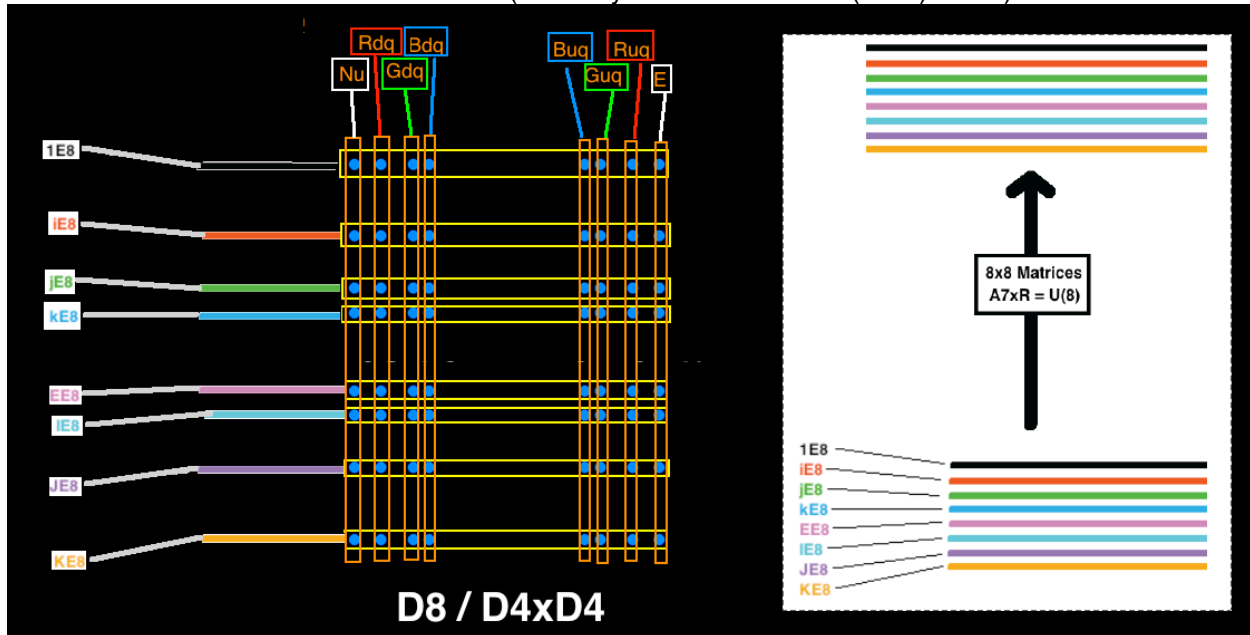

The 64 blue correspond to the 64-dim symmetric space $D_8 / D_4 \times D_4$
 Creation-Annihilation Operators are the grade-0 part of the E_8 Maximal Contraction
 generalized Heisenberg Algebra $h_{92} \times A_7 = 28 + 64 + ((SL(8, R)+1) + 64 + 28$

E_8 Physics, with World-Lines interpreted as Strings, is described by 26D String Theory with 8-dim Vector SpaceTime Base Manifold, 8 Fermion Particle Types, and 8 Fermion AntiParticle Types, related by Triality.

The 64 generators correspond to an 8-dim base manifold of an E_8 Lagrangian in which Spacetime $8v$ of 26D String Theory is represented by 8-branes whose Planck-Scale Lattice Structure is that of a superposition of 8 types of E_8 Lattice: 7 E_8 Integral Domains corresponding to the 7 Imaginary Octonion Basis Elements and 1 E_8 Lattice (not an Integral Domain - Kirmse's Mistake) corresponding to the Octonion Real Axis.

The 8 Fermion Particle and AntiParticle Types are
 { Neutrino, Red Down Quark, Green Down Quark, Blue Down Quark ;
 Blue Up Quark, Green Up Quark, Red Up Quark, Electron }
 each of which has 8 components corresponding to Octonion Basis Elements
 { 1, i, j, k, E, I, J, K }

The map from one 8-brane superposition to the next is by 8x8 Matrices representing the central grade-0 part $A_7 \times R$ of the Heisenberg Algebra $A_7 \times R$,

which gives Unimodular $SL(8, \mathbb{R})$ Gravity which effectively describes a generalized checkerboard of 8-dim SpaceTime HyperVolume Elements and, with respect to $Cl(16) = Cl(8) \times Cl(8)$, is the tensor product of the two 8v vector spaces of the two $Cl(8)$ factors of $Cl(16)$.

Bradonjic and Stachel in arXiv 1110.2159 said: "... in ... Unimodular relativity ... the metric tensor ... break[s up] ... into the conformal structure represented by a conformal metric ... with $\det = -1$ and a four-volume element ... at each point of space-time ... [that]... may be the remnant, in the ... continuum limit, of a more fundamental discrete quantum structure of space-time itself ...".

Conformal $Spin(2,4) = SU(2,2)$ Gravity and Unimodular $SL(4, \mathbb{R}) = Spin(3,3)$ Gravity seem to be effectively equivalent. Padilla and Saltas in arXiv 1409.3573 said: "... classical unimodular gravity and classical GR are the same thing, and they can be extended into the UV such that the equivalence is maintained. ... Classical unimodular gravity = classical GR. ... Quantum unimodular gravity = quantum GR provided we make certain assumptions about how we extend into the UV. ...".

Frampton, Ng, and Van Dam in J. Math. Phys. 33 (1992) 3881-3882 said: "... Because of the existence of topologically nontrivial solutions, instantons, of the classical field equations associated with quantum chromodynamics (QCD), the quantized theory contains a dimensionless parameter θ ($0 < \theta < 2\pi$) not explicit in the classical lagrangian. Since θ multiplies an expression odd in CP, **QCD predicts violation of ... CP ... symmetry unless the phase θ takes one of the special values ... $0 \pmod{\pi}$... this fine tuning is the strong CP problem ... the quantum dynamics of ... unimodular gravity ... may lead to the relaxation of θ to $\theta = 0 \pmod{\pi}$ without the need ... for a new particle ... such as the axion ...".**

The 64 Green and Cyan Root Vectors represent half of the First Generation Fermions of E8 / D8.
 The White Centers of their dots indicate that they are Particles.

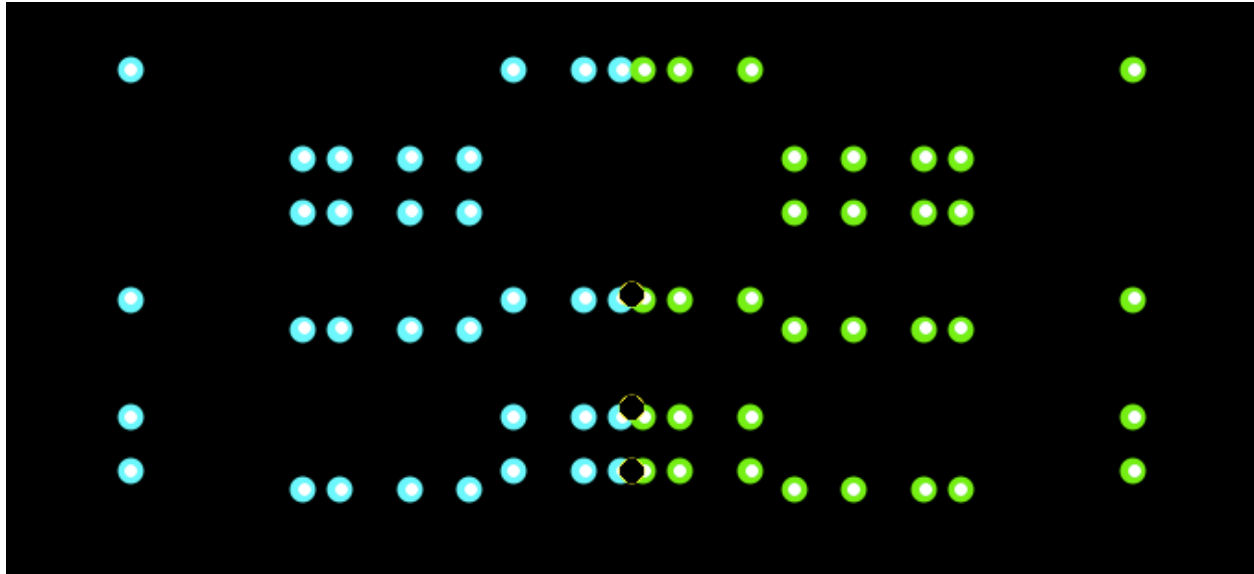

Their physical interpretations are

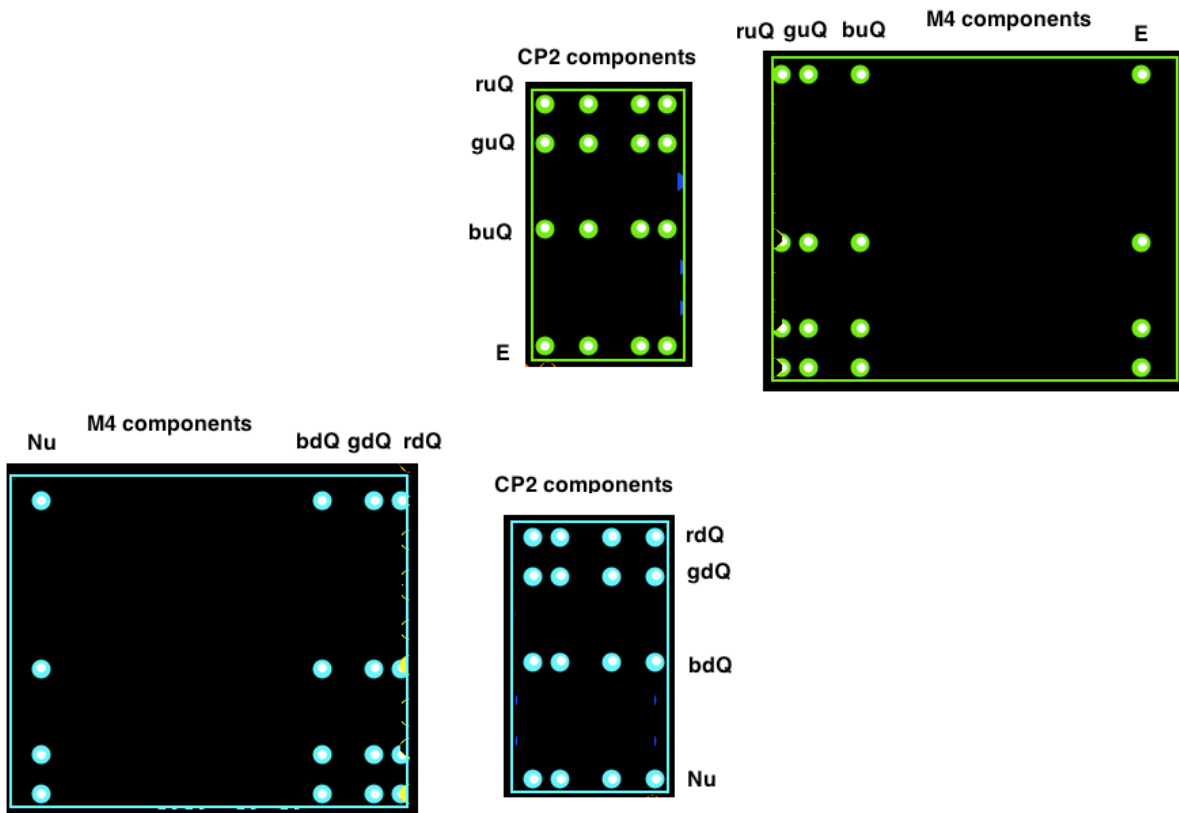

The 64 Red and Magenta Root Vectors represent the other half of the First Generation Fermions of E8 / D8.
 The Black Centers of their dots indicate that they are AntiParticles.

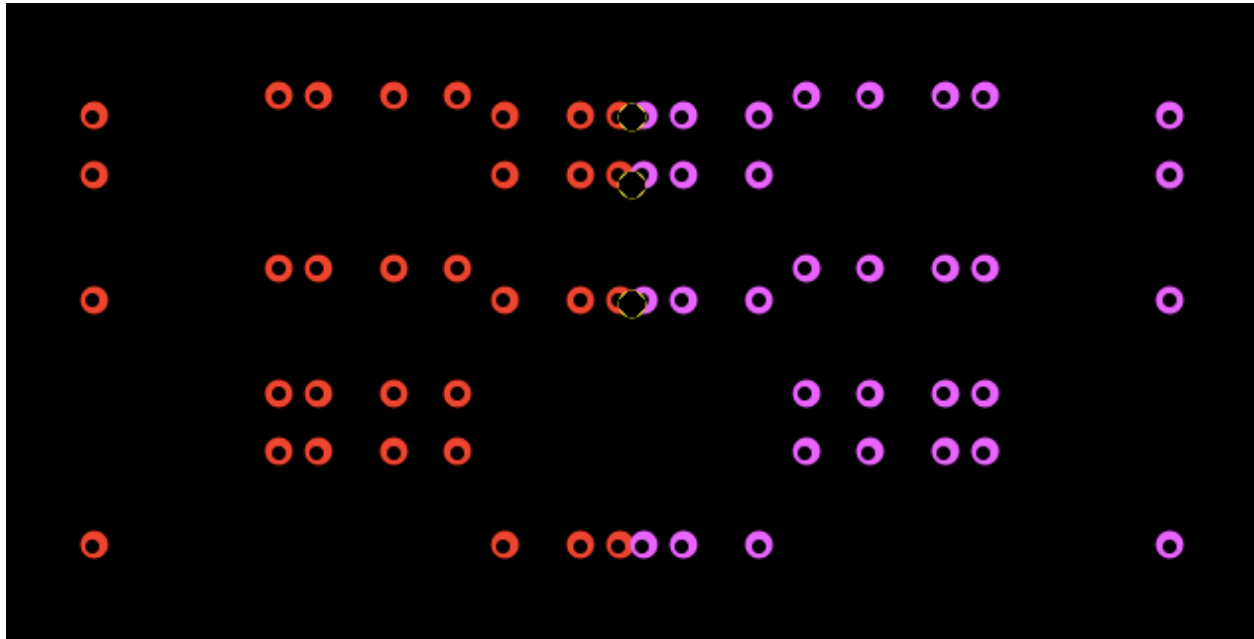

Their physical interpretations are

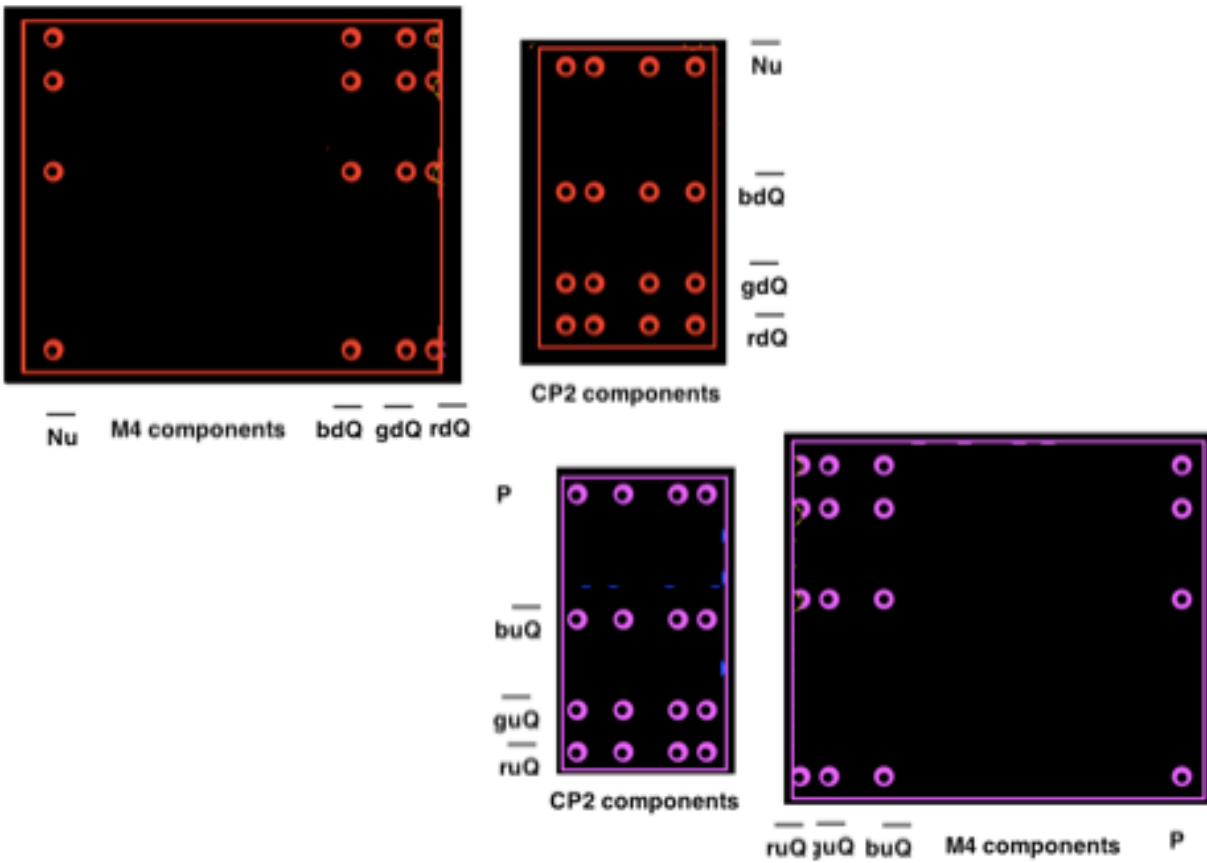

Evolution of our Universe and E8 Real Forms

From Void to Algebraic Quantum Field Theory via David Finkelstein's Iteration of Real Clifford Algebras

All Universes obey the same Laws of Physics and have the same Particle Masses, Force Strengths, and Spacetime Structure because they all begin with Void and evolve according to the Quantum Process of

David Finkelstein's Iteration of Real Clifford Algebras:

Void -> Cl(Void) -> Cl(0) -> Cl(2^0=1) -> Cl(2^1=2) -> Cl(2^2=4) -> Cl(2^4=16)

Cl(16) contains 248-dim Lie Algebra E8 = 120-dim BiVectors + 128-dim Half-Spinors. The 120-dim BiVectors of Cl(16) form the D8 Lie Algebra of SO(16) subalgebra of E8. By 8-Periodicity of Real Clifford Algebras Cl(16) can be factored into the tensor product 65,536-dim Cl(16) = 256-dim Cl(8) x 256-dim Cl(8)

so the Quantum Evolution Process does not use Iterated Clifford Algebra beyond Cl(16) but

uses Iterated Tensor Product of Cl(8) with E8 Lattice Vector Space

$$\text{Cl}(16) = \text{Cl}(8) \times \text{Cl}(8) \rightarrow \text{Cl}(8) \times \text{Cl}(8) \times \text{Cl}(8) = \text{Cl}(24)$$

to get to the Leech Lattice 24-dim Vector Space

and

uses Conformal Structure of 2x2 matrices with entries in Cl(24)

(Porteous, Clifford Algebras and the Classical Groups and

Lounesto and Porteous, Lectures on Clifford (Geometric) Algebras and Applications)

to get to $M(2, \text{Cl}(24)) = \text{Cl}(1, 25)$ with Lorentz Leech Lattice Vector Space.

Since all the matrix entries are $\text{Cl}(0, 24) =$ tensor product of 3 copies of Cl(0,8)

8-Periodicity allows formation of the tensor products of copies of Cl(1,25)

**Completion of Union of All Tensor Products of Cl(1,25) = hyperfinite AQFT =
= Algebraic Quantum Field Theory containing**

**a copy of E8 within Cl(16) within each copy of Cl(1,25) The E8 is a Recipe for a
Realistic Physics Lagrangian (viXra 1602.0319, 1701.0495, 1701.0496)**

the Vector Space of Cl(1,25) is the Spacetime of a 26D String Theory in which

Strings are World-Lines of Particles and

the Massless Spin 2 State is the Carrier of the Bohm Quantum Potential

with Sarfatti Back-Reaction (viXra 1602.0319, 1701.0495)

and

24 of the 26 dimensions of 26D String Theory are

the off-diagonal parts of traceless part J(3,0) of the Jordan Algebra J(3,0)

8v of Vector Spacetime +

8s+ of +half-spinor Fermion Particles +

8s- of -half-spinor Fermion AntiParticles

E8 Real Forms

Thanks to Alessio Marrani for correcting my thinking about E8 Real Forms. Also, I apologize for my inconsistent and unconventional use of the terms Spinor and Pinor. Sometimes I use the term Spinor, or Spin(p,q), when I really should use the term Pin, or Pin(p,q). A physical significance of the difference is that Spinors and Spin(n) are related to the even subalgebra of the Clifford algebra Cl(p,q) (where Cle(p,q) = Cl(p,q-1) and Cle(p,0) = Cl(0,p-1)) and so do not contain some reflection-related characteristics (such as parity reversal, etc.), while such things are contained in Pin and Pin(p,q) because they are related to the full Clifford algebra Cl(p,q) including its odd part. A paper by Marcus Berg, Cecile DeWitt-Morette, Shangji Gwo, and Eric Kramer, math-ph/0012006, discusses Pin and Spin. ... I hope that readers can see what I mean from context, because I have misused the terminology in so many places throughout my materials that I have not had the energy to correct them. However, I do not think that my misuse of math terminology has resulted in wrong physics. That is, the ... E8 ... Physics model is in my opinion physically realistic and valid, even though my description of it may use some incorrect math terminology.

Wikipedia and Einstein Manifolds by Arthur L. Besse say "... There is a unique complex Lie algebra of type E8, corresponding to a complex group of complex dimension 248. ... This is simply connected, has maximal compact subgroup the compact form ... of E8, and has an outer automorphism group of order 2 generated by complex conjugation. As well as the complex Lie group of type E8,

**there are three real forms of the ... E8 ... Lie algebra ...
compact form E8(-248) [and] split form, EVIII (or E8(8)) [and] EIX (or E8(-24)) ...**

The **compact form ... E8(-248)** ... has symmetric space E8/SO(16) of dimension 128 ... rank 8 with Isotropy representation Spin(16) ... **Rosenfeld's elliptic projective plane** (Ca x Ca)P2 (where Ca = Cayley Octonions and x = tensor product) It is simply connected ... has trivial outer automorphism group ... maximal subgroups of E8 ... E7 x SI(2)/(-1,-1) and E6 x SU(3)/(Z/3Z) ... Symmetric space ...
E8 / SO(16) ...

... E8 / E7 x Sp(1) ...

The **split form, EVIII (or E8(8))** ... has symmetric space E8/SO(16) of dimension 128 ... rank 8 with Isotropy representation Spin(16) ... **Rosenfeld's hyperbolic projective plane** (Ca x Ca)P2hyp It has maximal compact subgroup Spin(16)/(Z/2Z), fundamental group of order 2 (implying that it has a double cover, which is a simply connected Lie real group but is not algebraic ...) and has trivial outer automorphism group ... Symmetric space ...
E8(8) / SO(16) ... E8(8) / SO(8,8) ... E8(8) / Sk(8,H) [= E8(8) / SO*(16)]...
... E8(8) / E7(7) x SL(2,R) ... E8(8) / E8(8) / E7(-5) x SU(2) ...

EIX (or E8(-24)) ... has symmetric space E8 / E7 x SU(2) of dimension 112 and rank 4 with Isotropy representation $\wedge^2 E7 \times SU(2)$ that is the Set of (H x Ca)P2hyp 's in "(Ca x Ca)P2hyp" (where \wedge denotes exterior product representation and H = Quaternions) It has maximal compact subgroup E7xSU(2)/(-1,-1), fundamental group of order 2 (implying a double cover, which is not algebraic) and has trivial outer automorphism group ...
Symmetric Space ...
E8(-24) / SO(12,4) ... E8(-24) / Sk(8,H) [= E8(-24) / SO*(16)]...
... E8(-24) / E7(-5) x SU(2) [Quaternion-Kahler] ... E8(-24) / E7(-25) x SL(2,R) ...".

Since my E8 Physics model is based on the 240 E8 Root Vectors being decomposed into 128 corresponding to D8 Half-Spinors and 112 corresponding to D8 Root Vectors

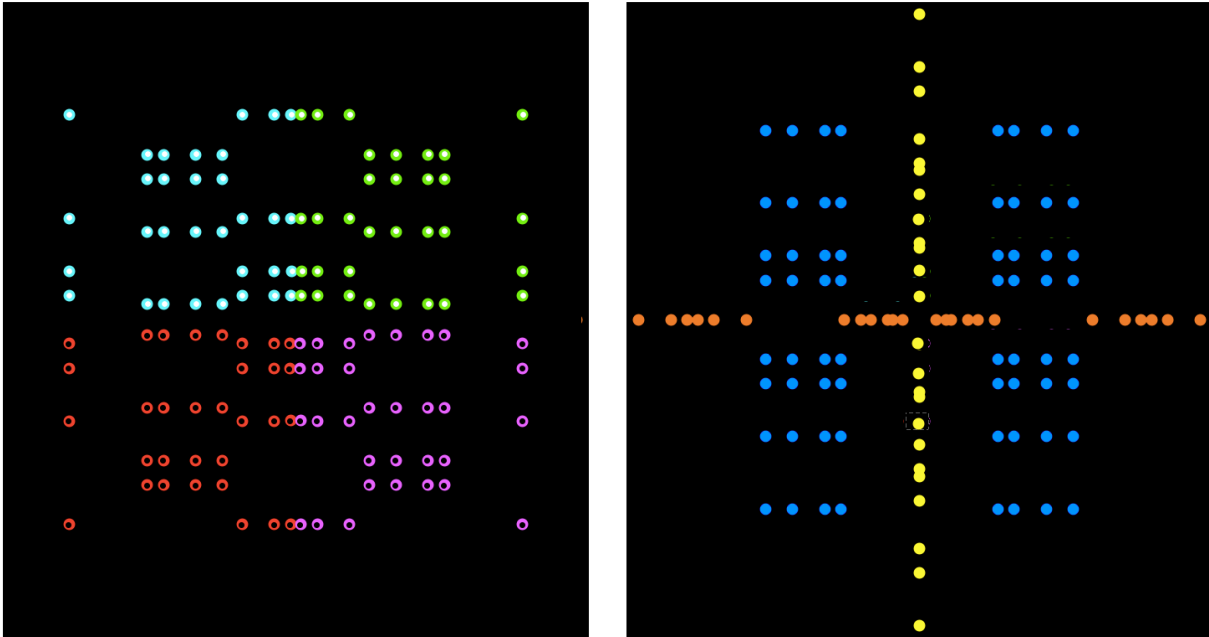

the Real Forms of E8 for my E8 Physics model with Octonionic 8-dim Spacetime prior to Post-Inflation Transition to (4+4)-dim Quaternionic M4 x CP2 Kaluza-Klein are

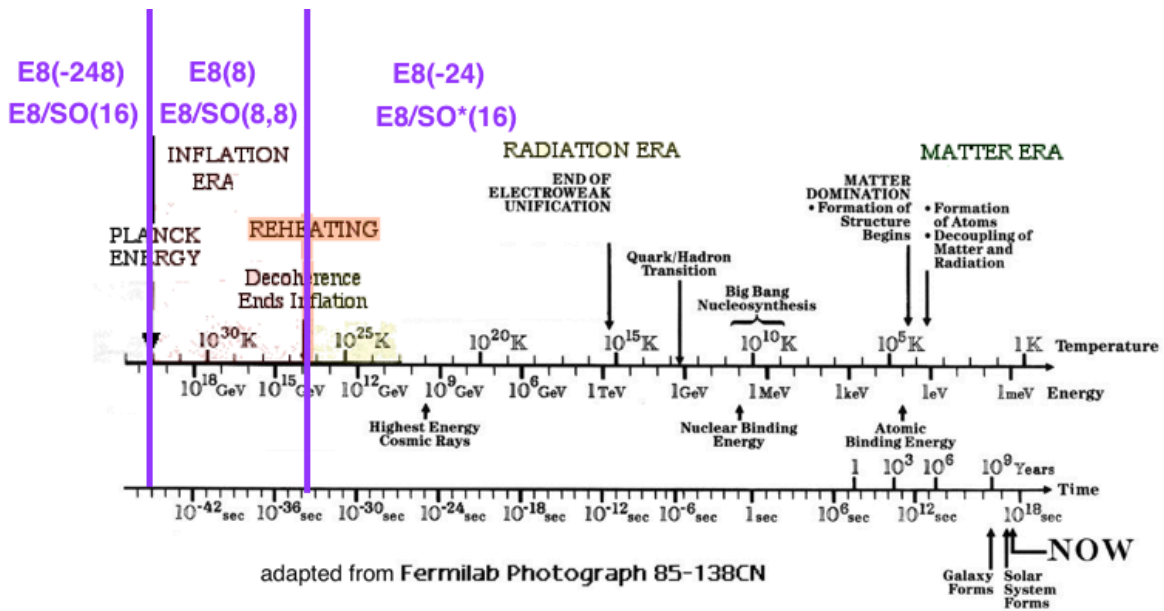

Big Bang has Compact E8(-248) and Inflation has NonCompact Split EVIII E8(8)

Our Universe emerged from Our Parent Universe which is only one of many Universes in the huge Family of Universes:

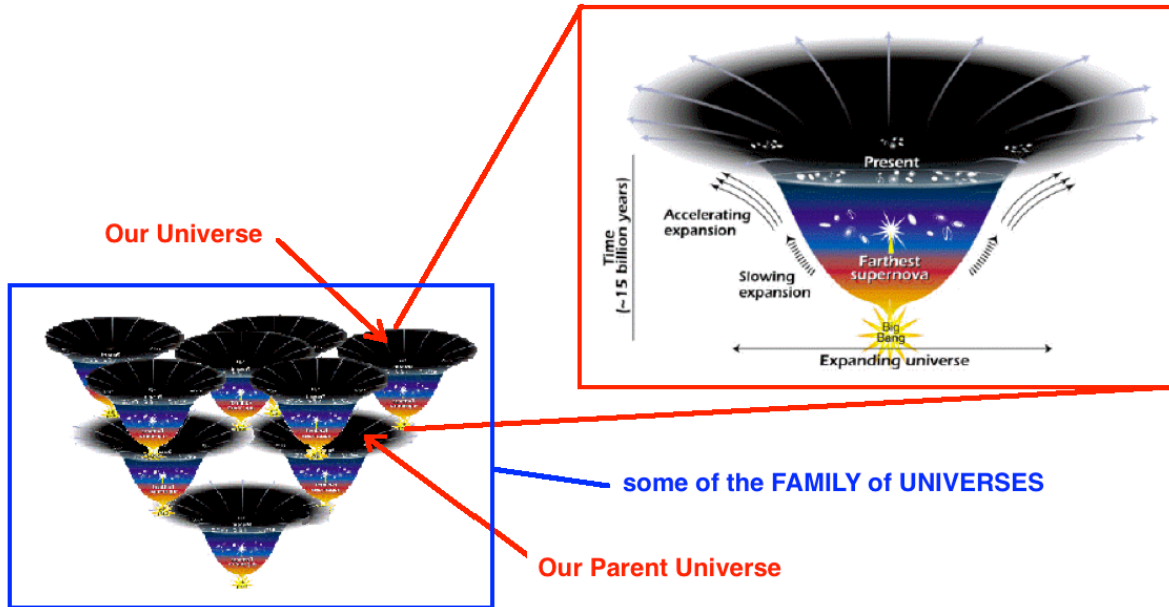

The First Stage of the Evolution of Our Universe was the Initial Planck Cell Big Bang of Compact E8(-248)



a compact vacuum fluctuation in a single Planck-scale cell of Our Parent Universe. That Planck cell (like all other Planck cells in any Universe) can be described by taking the quotient of its 24-dimensional subspace modulo the 24-dimensional Leech lattice. Its automorphism group is the largest finite sporadic group, the Monster Group, of order 8080, 17424, 79451, 28758, 86459, 90496, 17107, 57005, 75436, 80000, 00000 = $2^{46} \cdot 3^{20} \cdot 5^9 \cdot 7^6 \cdot 11^2 \cdot 13^3 \cdot 17 \cdot 19 \cdot 23 \cdot 29 \cdot 31 \cdot 41 \cdot 47 \cdot 59 \cdot 71$ or about 8×10^{53} .

E8 describes the physics in that Big Bang Planck Cell which is Compact so that the Real Form of E8 representing the physics of the Big Bang Planck Cell is E8(-248) with symmetric space E8 / SO(16) of dimension 128 and rank 8 and isotropy representation Spin(16) that is Rosenfeld's Elliptic Projective Plane (OxO)P2 .

Use of Compact structures in Physics Models

Robert Gilmore in Phys. Rev. Lett. 28 (1972) 462-464 showed that Armand Wyler's use to calculate force strengths and particle masses as ratios of volumes of compact domains of unit radius instead of measures on noncompact projectively related domains is justified, saying "... the replacement of a divergent value by a finite value can lead to a well-defined and significant result. The occurrence of the Euclidean volumes $V(Q_n)$ and $V(D_n)$ should be considered a strong point of Wyler's result, rather than an objectionable feature. These volumes arise naturally as the normalizing coefficients in the Poisson and Bergman kernels, which are reproducing functions and are defined in a nonlinear way. The Poisson kernel is the image of a space-time scalar Green's function, when both arguments of the kernel are on the boundary Q_n of D_n ... Wyler's work has pointed out that it is possible to map an unbounded physical domain - the interior of the forward light cone - onto the interior of a bounded domain on which there also exists a complex structure. This mapping should prove of immense calculational value in the future. This transformation from unbounded to bounded complex domains is mathematically rigorous, and is valid ...".

My E8 Physics model makes use of Wyler's valid technique in calculation of ratios of force strengths and particle masses, and it seems clear to me that the validity extends to use of both Compact E8(-248) and NonCompact Split EVIII E8(8) Real Forms.

**Compact E8(-248) and NonCompact Split EVIII E8(8)
are both useful in describing E8 Physics of 8-dim Octonionic Spacetime
at High (from Planck through Inflation to End of Inflation) Energies.**

The Second Stage of the Evolution of Our Universe was Octonionic Inflation

Octonionic Inflation



The Real Form of E8 representing the physics of Octonionic Inflation is E8(8) with symmetric space E8 / SO(8,8).

Our Universe expands by Octonionic Inflation beyond its initial Big Bang Planck Cell to form an Octonionic 8-dim Spacetime based on the 64 generators of the A7 x R center of the Maximal Contraction Heisenberg Algebra of E8. Effectively, the 64 generators correspond to 8 position x 8 momentum components of an 8-dim base manifold of an E8 Lagrangian in which Spacetime 8v of 26D String Theory is represented by 8-branes whose Planck-Scale Lattice Structure is that of superpositions of 8 types of E8 Lattice: There is a 1-1 correspondence between Octonion Basis Elements and E8 Integral Domains

- 1 \Leftrightarrow 0E8
- i \Leftrightarrow 1E8
- j \Leftrightarrow 2E8
- k \Leftrightarrow 3E8
- E \Leftrightarrow 4E8
- I \Leftrightarrow 5E8
- J \Leftrightarrow 6E8
- K \Leftrightarrow 7E8

where 1E8,2E8,3E8,4E8,5E8,6E8,7E8 are 7 independent Integral Domain E8 Lattices and 0E8 is an 8th E8 Lattice (Kirmse's mistake) not closed as an Integral Domain.

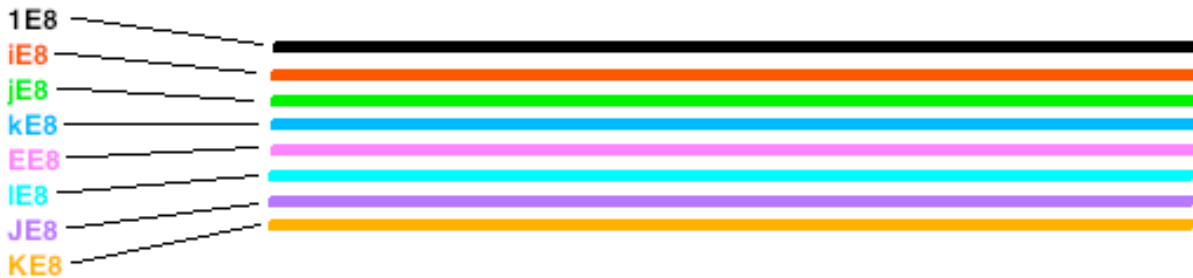

and
 Gauge Boson / Ghost terms are represented by the 28+28 = 56 axis root vectors other than the 64 (blue) that correspond to A7 + R
 and
 Fermion (8s+ and 8s- of 26D String Theory) terms are represented by the 128 = (8+8)x8 off-axis root vectors of E8

The 26D Lagrangian Structure is

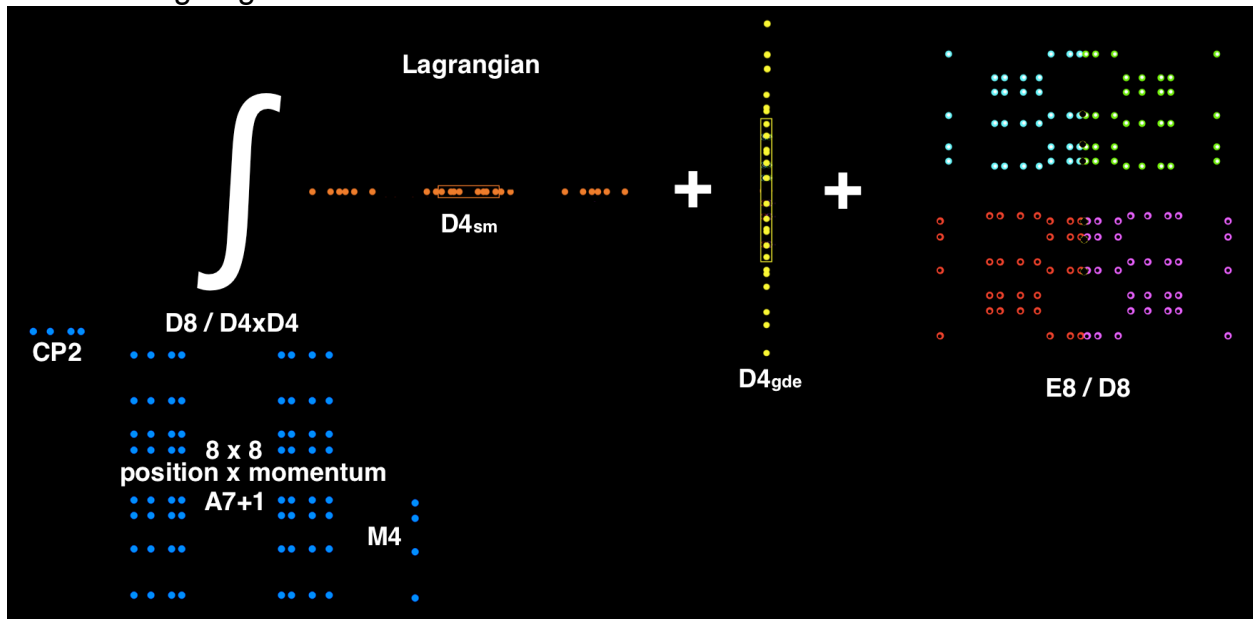

having terms for

E8 / D8 Fermions (with Fermion Generations 2 and 3 from Quaternionic structure)

and

D4 Standard Model Gauge Bosons and Gravity Ghosts

and

D4 Conformal Gravity Gauge Bosons and Standard Model Ghosts

that is integrated over

D8 / D4xD4 (4+4)-dim M4 x CP2 Kaluza-Klein base manifold

with Higgs from the Mayer mechanism

The E8 Lagrangian is Chiral because

E8 contains $Cl(16)$ half-spinors (64+64) for a Fermion Generation

but does not contain $Cl(16)$ Fermion AntiGeneration half-spinors (64+64).

Fermion +half-spinor Particles with high enough velocity are seen as left-handed.

Fermion -half-spinor AntiParticles with high enough velocity are seen as right-handed.

The E8 Lagrangian obeys Spin-Statistics because

the CP2 part of M4xCP2 Kaluza-Klein has index structure Euler number $2+1 = 3$ and

Atiyah-Singer index $-1/8$ which is not the net number of generations because

CP2 has no spin structure but you can use a generalized spin structure

(Hawking and Pope (Phys. Lett. 73B (1978) 42-44))

to get (for integral m) the generalized CP2 index $n_R - n_L = (1/2) m (m+1)$

Prior to Dimensional Reduction: $m = 1$, $n_R - n_L = (1/2) \times 1 \times 2 = 1$ for 1 generation

After Reduction to 4+4 Kaluza-Klein: $m = 2$, $n_R - n_L = (1/2) \times 2 \times 3 = 3$ for 3 generations

Hawking and Pope say: "Generalized Spin Structures in Quantum Gravity ...what happens in CP2 ... is a two-surface K which cannot be shrunk to zero. ... However, one could replace the electromagnetic field by a Yang-Mills field whose group G had a double covering $G\sim$. The fermion field would have to occur in representations which changed sign under the non-trivial element of the kernel of the projection ... $G\sim \rightarrow G$ while the bosons would have to occur in representations which did not change sign ...".

For the E8 model gauge bosons are in the $28+28=56$ -dim D4 + D4 subalgebra of E8. D4 = SO(8) is the Hawking-Pope G which has double covering $G\sim = \text{Spin}(8)$.

The 8 fermion particles / antiparticles are D4 half-spinors represented within E8 by anti-commutators and so do change sign while the 28 gauge bosons are D4 adjoint represented within E8 by commutators and so do not change sign.

**E8 inherits from F4 the property whereby
its Spinor Part need not be written as Commutators
but can also be written in terms of Fermionic AntiCommutators.**

Pierre Ramond has shown in hep-th/0112261 as shown that the exceptional Lie Algebra F4 can be described using anticommutators as well as commutators. The periodicity property of Real Clifford Algebras shows that E8 Spinor Fermions can also be described using anticommutators as well as commutators so that the E8 Physics model describes both Bosons and Fermions realistically.

Realistic Physics models must describe both integer-spin Bosons whose statistics are described by commutators (examples are Photons, W and Z bosons, Gluons, Gravitons, Higgs bosons) and half-integer-spin Fermions whose statistics are described by anticommutators. (examples are 3 generations of Electrons, Neutrinos, Quarks and their antiparticles)

Lie Algebra elements are usually described by commutators of their elements so if a Physics model attempts to describe both Bosons and Fermions as elements of a single unifying Lie Algebra (for example, Garrett Lisi's E8 TOE) a common objection is:

since the Lie Algebra is described by commutators,
it can only describe Bosons and cannot describe Fermions
therefore
models (such as Garrett Lisi's) using E8 as a single unifying Lie Algebra
violate the consistency of spin and statistics
and are wrong.

However,
Pierre Ramond has shown in hep-th/0112261 as shown that the exceptional Lie Algebra F4 can be described using anticommutators as well as commutators.

The periodicity property of Real Clifford Algebras shows that E8 inherits from F4 a description using anticommutators as well as commutators so that it may be possible to construct a realistic Physics model that uses the exceptional Lie Algebra E8 to describe both Bosons and Fermions.

Here are relevant quotes from hep-th/0112261 by Pierre Ramond:

"... exceptional algebras relate tensor and spinor representations of their orthogonal subgroups, while Spin-Statistics requires them to be treated differently ... all representations of the exceptional group F4 are generated by three sets of oscillators transforming as 26. We label each copy of 26 oscillators as A_{k_0} , A_{k_i} , $i = 1, \dots, 9$, B_{k_a} , $a = 1, \dots, 16$, and their hermitian conjugates, and where $k = 1, 2, 3$.

... One can ...

use a coordinate representation of the oscillators by introducing real coordinates ... [for A_i]... which transform as transverse space vectors, ... [for A_0]... which transform ... as scalars, and ... [for B_a]... which transform ... as space spinors which satisfy Bose commutation rules ...

Under SO(9), the A_{k_i} transform as 9, B_{k_a} transform as 16, and A_{k_0} is a scalar.

They satisfy the commutation relations of ordinary harmonic oscillators ...

Note that the SO(9) spinor operators satisfy Bose-like commutation relations ...

both A_0 and B_a ... obey Bose commutation relations

... Curiously,

if both ... A_0 and B_a ... are anticommuting, the F4 algebra is still satisfied ...".

To see how the anticommuting property of the 16 B_a elements of F4 can be inherited by some of the elements of E8, consider that 52-dimensional F4 is made up of:

28-dimensional D4 Lie Algebra Spin(8) (in commutator part of F4)

8-dimensional D4 Vector Representation V8 (in commutator part of F4)

8-dimensional D4 +half-Spinor Representation S+8 (in anticommutator part of F4)

8-dimensional D4 -half-Spinor Representation S-8 (in anticommutator part of F4)

Since 28-dimensional D4 Spin(8) is the BiVector part BV28

of the Real Clifford Algebra Cl(8) with graded structure

$Cl(8) = 1 + V8 + BV28 + 56 + 70 + 56 + 28 + 8 + 1$

and with Spinor structure

$Cl(8) = (S+8 + S-8) \times (8 + 8)$

F4 can be embedded in Cl(8) (blue commutator part, red anticommutator part):

$F4 = V8 + BV28 + S+8 + S-8$

Note that V8 and S+8 and S-8 are related by the Triality Automorphism.

Also consider the 8-periodicity of Real Clifford Algebras, according to which for all N

$$Cl(8N) = Cl(8) \times \dots (N \text{ times tensor product}) \dots Cl(8)$$

so that in particular $Cl(16) = Cl(8) \times Cl(8)$

where $Cl(16)$ graded structure is $1 + 16 + BV120 + 560 + \dots + 16 + 1$

and $Cl(16)$ Spinor structure is $((S+64 + S-64) + (64 + 64)) \times (128 + 128)$

and $Cl(16)$ contains 248-dimensional E8 as

$$E8 = BV120 + S+64 + S-64$$

where $BV120 = 120\text{-dimensional D8 Lie Algebra Spin}(16)$

and $S+64 + S-64 = 128\text{-dimensional D8 half-Spinor Representation}$

Consider two copies of F4 embedded into two copies of $Cl(8)$.

For commutator structure:

The tensor product of the two copies of $Cl(8)$ can be seen as

$$\begin{aligned} &1 + V8 + BV28 + 56 + 70 + 56 + 28 + 8 + 1 \\ &\quad \times \\ &1 + V8 + BV28 + 56 + 70 + 56 + 28 + 8 + 1 \end{aligned}$$

which produces the Real Clifford Algebra $Cl(16)$ with graded structure

$$1 + 16 + BV120 + 560 + 1820 + \dots + 16 + 1$$

where the $Cl(16)$ BiVector $BV120$ is made up of 3 parts

$$BV120 = BV28 \times 1 + 1 \times BV28 + V8 \times V8$$

that come from the $V8$ and $BV28$ commutator parts of the two copies of F4.

This gives the commutator part of E8 as $BV120$ inheriting commutator structure from the two copies of F4 embedded in two copies of $Cl(8)$ whose tensor product produces $Cl(16)$ containing E8.

For anticommutator structure:

The tensor product of the two copies of 256-dim Cl(8) can also be seen as

$$\begin{aligned} & ((S+8 + S-8) \times (8 + 8)) \\ & \quad \times \\ & ((S+8 + S-8) \times (8 + 8)) \end{aligned}$$

which produces the $2^{16} = 65,536 = 256 \times 256$ -dim Real Clifford Algebra Cl(16)

$$\begin{aligned} & ((S+8 + S-8) \times (S+8 + S-8)) \\ & \quad \times \\ & ((8 + 8) \times (8 + 8)) \end{aligned}$$

with 256-dimensional Spinor structure

$$\begin{aligned} & ((S+8 + S-8) \times (S+8 + S-8)) = \\ & = ((S+8 \times S+8) + (S-8 \times S-8)) + ((S+8 \times S-8) + (S-8 \times S+8)) \end{aligned}$$

that comes from the S+8 and S-8 anticommutator parts of the two copies of F4.

Since the (S+8 x S-8) and (S-8 x S+8) terms inherit mixed helicities from F4

only the (S+8 x S+8) and (S-8 x S-8) terms inherit consistent helicity from F4.

Therefore, define S+64 = (S+8 x S+8) and S-64 = (S-8 x S-8)
so that

$$(S+64 + S-64) = 128\text{-dimensional D8 half-Spinor Representation}$$

This gives the anticommutator part of E8 as S+64 + S-64 inheriting anticommutator structure from the two copies of F4 embedded in two copies of Cl(8) whose tensor product produces Cl(16) containing E8.

The result is that 248-dimensional E8 is made up of:

BV120 = 120-dimensional D8 Lie Algebra Spin(16) (commutator part of E8)

128-dimensional (S+64 + S-64) D8 half-Spinor (anticommutator part of E8)

Note that since the V8 and S+8 and S-8 components of F4 are related by Triality, and since

the E8 component BV120 contains 64-dimensional V8xV8

and

the 64-dimensional E8 component S+64 = S+8 x S+8

and

the 64-dimensional E8 component S-64 = S-8 x S-8

E8 inherits from the two copies of F4 a Triality relation

$$V8xV8 = S+64 = S-64$$

The commutator - anticommutator structure of E8 allows construction of realistic Physics models that not only unify both Bosons and Fermions within E8

but

also contain Triality-based symmetries between Bosons and Fermions

that can give the useful results of SuperSymmetry

without requiring conventional SuperPartner particles that are unobserved by LHC.

CONCLUSION:

Unified E8 Physics models can be constructed without violating spin-statistics.

F4 in Cl(8) x F4 in Cl(8) = E8 in Cl(16) and Giza

That F4 in Cl(8) x F4 in Cl(8) = E8 in Cl(16) may have been known to the builders of the Pyramids at Giza.

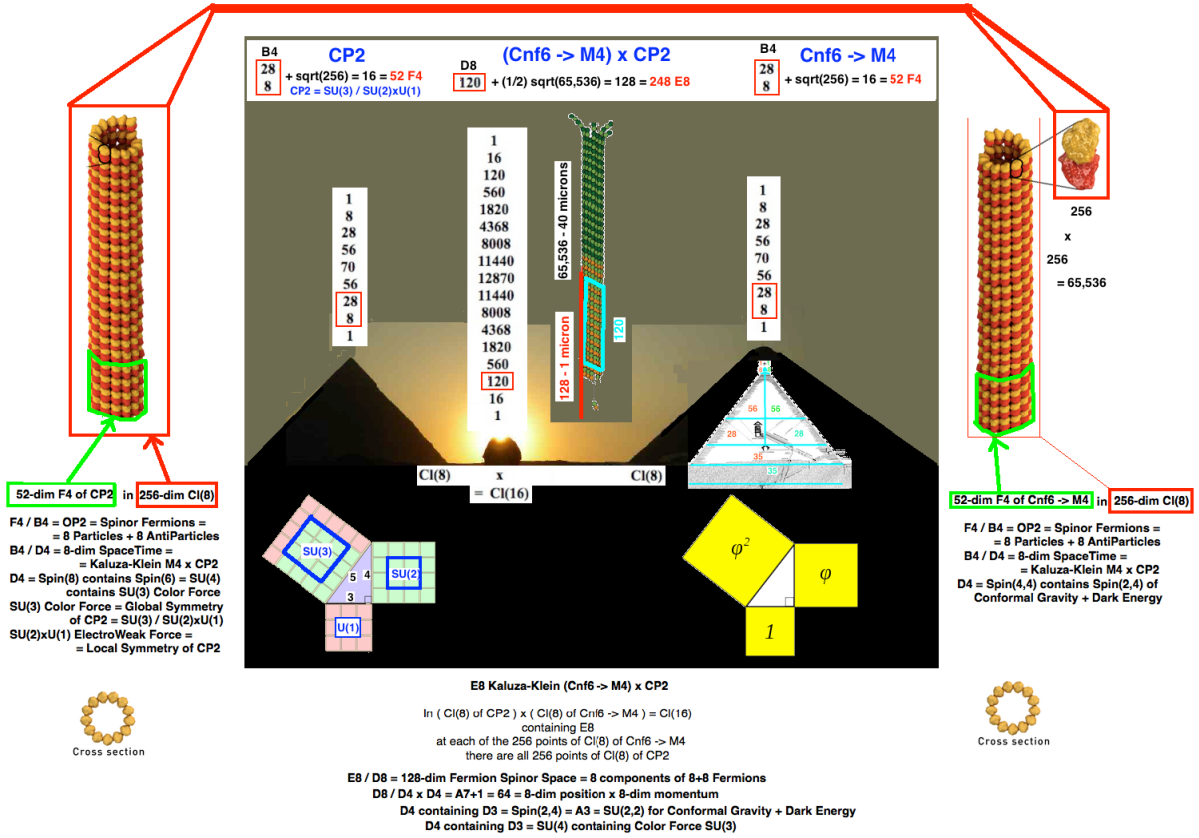

Giulio Magli in arXiv 0708.3632 and 1401.0508 and Journal of Cosmology, 2010, Vol 9, 2232-2244 said: "... the two main pyramids of Giza together with their temples ... were conceived as parts of a common project ...



Clifford Algebras were not known to European mathematicians until Clifford in the 19th century and not known to European physicists until Dirac in the 20th century but it seems to me that their structure was known to Africans in ancient times. For example, the courses of the Great Pyramid of Giza correspond to the graded structure of $Cl(8)$:

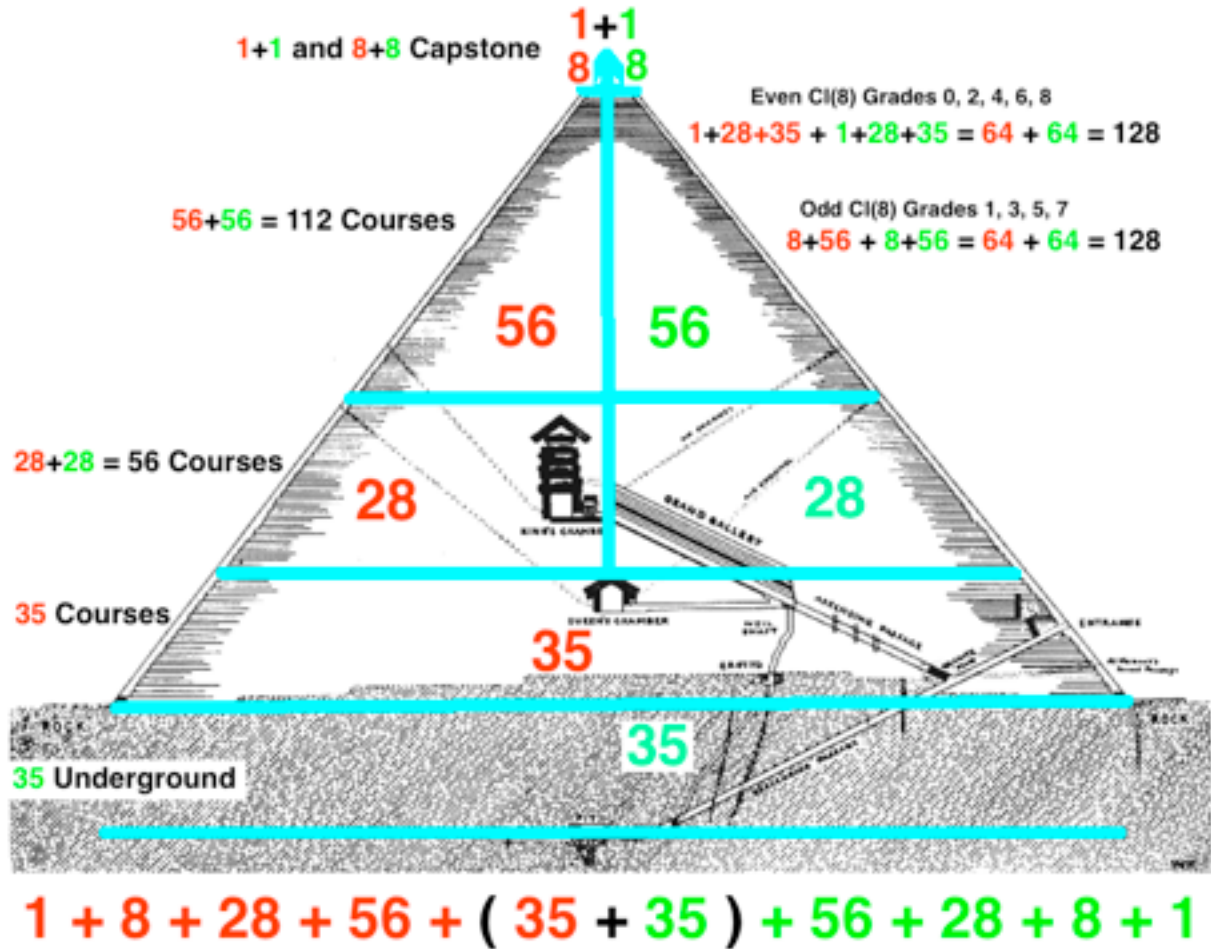

(image adapted from David Davidson image - for larger size see tony5m17h.net/GreatPyrCl8.png)
 Above the Grand Gallery is a Great Void leading to Ceiling Chambers above the Upper Chamber - (image from ScanPyramids web site)



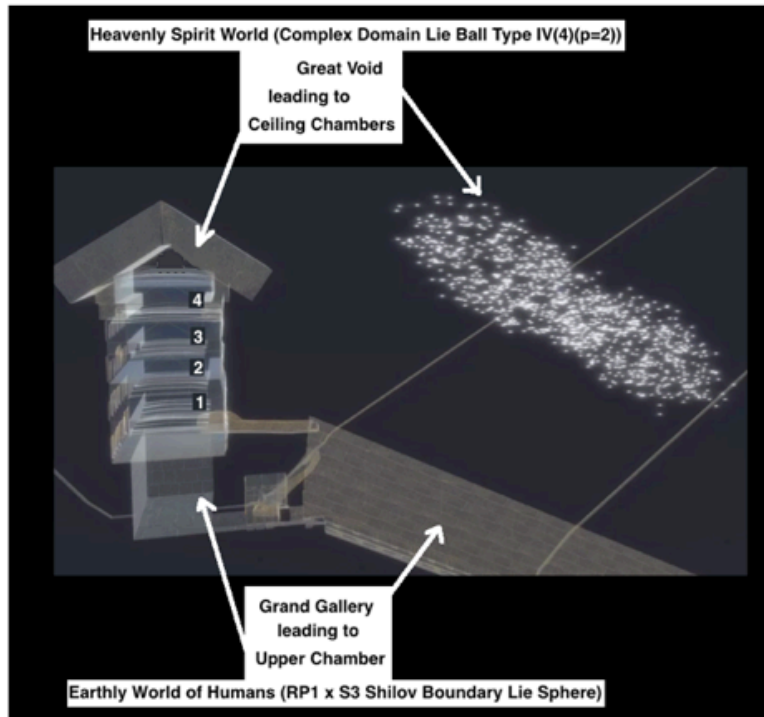

The Builders of the Great Pyramid represented the Real Shilov Boundary Physical world by the Grand Gallery and Upper Chamber that are easily accessible by Humans with Microtubule Quantum Consciousness and they represented the Imaginary Complex World of $CI(16)$ Spacetime Cells mirroring the Human Microtubule World as Ceiling Chamber spaces and the Great Void that are more accessible to Souls of the Spirit World than to Physical Humans.

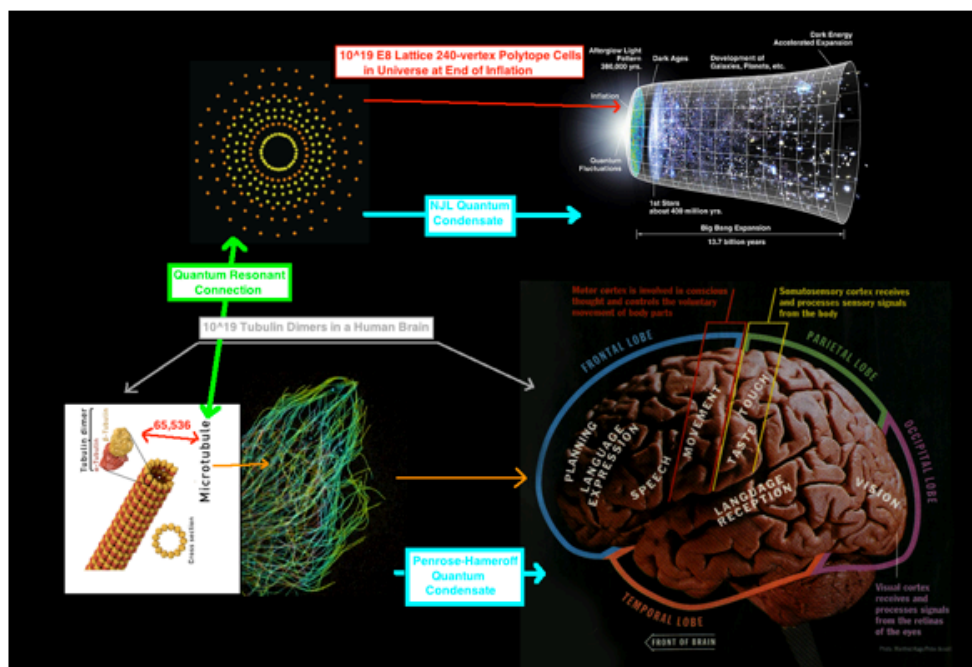

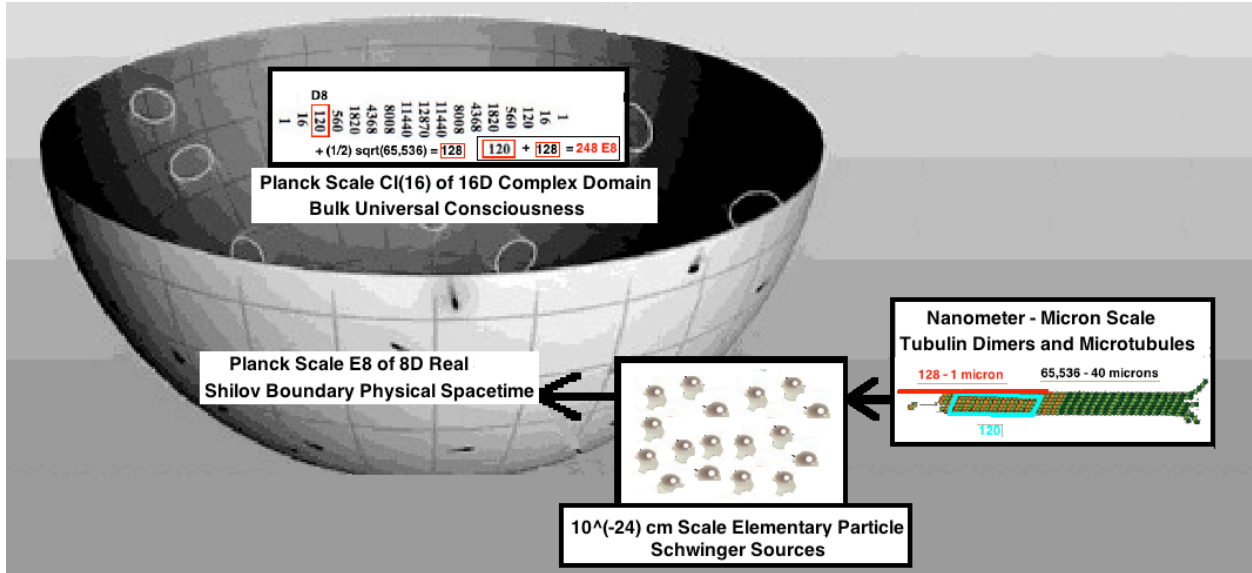

As to when the Giza Pyramids and Sphinx were built, it could have been about 36,000 years ago when Geminga shock wave hit and Vega was North Star. 36,000 years ago was the beginning of Manetho's Rule of Gods on Earth and was when humans migrated up the Nile River to Giza, according to the National Geographic Genographic program



The Builders of the Great Pyramid had migrated throughout the length of the Nile along which substantially contiguous settlements enabled them to maintain enough contact to maintain the details of the oral traditions of IFA so that when they built the earliest of the pyramids, the Great Pyramid and the Second Pyramid, and Sphinx they did not deface them with any writing but instead encoded the IFA Clifford Algebra in the structure of the Pyramids themselves.

Manetho's Rule of Gods on Earth ended 22,000 years ago when human genotype M35 left M96 and Africa to cross Mediterranean into the Middle East and Kosovo/Macedonia. Manetho's Rule by Demigods and Spirits of the Dead (22,000 to 11,000 BP) ended after Ice Age when sea levels rose requiring agri-tech for survival. Manetho's Rule of Mortal Humans began 11,000 BP which was about 25-26,000 years after the Geminga shock wave. 11,000 BP also had a supernova (Vela X) and Vega as North Star.

Ultraviolet Finiteness

Each Fermion part of the Fermionic Term has in 8-dim Spacetime units of mass^(7/2).

Each Gauge Boson + Ghost part of the Bosonic Term has units of mass⁽¹⁾

Since (8+8)x(7/2) = 56 = 28 + 28 the Fermionic Terms cancel the Bosonic Terms
the Lagrangian is UltraViolet finite.

Gauge Gravity and Standard Model terms of Lagrangian have total weight 28 x 1 = 28

12 generators for SU(3) and U(2) Standard Model +

+ 16 generators for U(2,2) of Conformal Gravity =

= 28 D4 Gauge Bosons each with 8-dim Lagrangian weight = 1

Fermion Particle-AntiParticle term also has total weight 8 x (7/2) = 28

8 Fermion Particle/Antiparticle types each with 8-dim Lagrangian weight = 7/2

Since Boson Weight 28 = Fermion Weight 28

the CI(1,25) E8 model has a Subtle SuperSymmetry and is UltraViolet Finite.

Here is what Steven Weinberg says in his part of the book 1986 Dirac Lectures
Elementary Particles and the Laws of Physics: "...

$$\begin{aligned} \mathcal{L} = & -\bar{\psi} \left(\gamma^\mu \frac{\partial}{\partial x^\mu} + m \right) \psi - \frac{1}{4} \left(\frac{\partial A_\nu}{\partial x^\mu} - \frac{\partial A_\mu}{\partial x^\nu} \right)^2 \\ & + ie A_\mu \bar{\psi} \gamma^\mu \psi - \mu \left(\frac{\partial A_\nu}{\partial x^\mu} - \frac{\partial A_\mu}{\partial x^\nu} \right) \bar{\psi} \sigma^{\mu\nu} \psi - G \bar{\psi} \psi \bar{\psi} \psi + \dots \end{aligned}$$

Fortunately almost all of the details are irrelevant for the points that I want to make. Let me explain briefly what all the symbols mean. \mathcal{L} stands for Lagrangian density; roughly speaking you can think

of it as the density of energy. Energy is the quantity that determines how the state vector rotates with time, so this is the role that the Lagrangian density plays; it tells us how the system evolves. It's written as a sum of products of fields and their rates of change. ψ is the field of the electron (a function of the spacetime position x), and m is the mass of the electron. $\partial/\partial x^\mu$ means the rate of change of the field with position. γ^μ and $\sigma^{\mu\nu}$ are matrices about which I will say nothing, except that the γ^μ matrices are called Dirac matrices. A_μ is the field of the photon, called the electromagnetic field.

Looking in order at each term on the right-hand side of the equation, the first term involves the electron field twice, the next term involves the photon field twice because the bracket is squared, the third and fourth terms involve two electron fields and one photon field, the fifth term involves four electron fields, and so on. The symmetries of quantum electrodynamics give us well-defined rules for the construction of the terms in the Lagrangian, but there are an infinite number of terms allowed, with increasing numbers of fields, and also increasing numbers of derivative operators acting on them. Each term has an independent constant, called the coupling constant, that multiplies it. These are the quantities e , μ , G, \dots in (1). The coupling constant

gives the strength with which the term affects the dynamics. No coupling constants appear in the first two terms simply because I have chosen to absorb them into the definition of the two fields ψ and A_μ . If there were a constant in front of the first term, for example, I would just redefine ψ to absorb it. But for all the other terms, infinity minus two of them, there is a constant in front of each term. In principle all these constants are there, and they are all unknown. How in the world can you make any money out of a theory like this?

In fact, it's not that bad. Experimentally we know that the formula consisting of just the first three terms, with all higher terms neglected, is adequate to describe electrons and photons to a fantastic level of accuracy. This theory is known as quantum electrodynamics, or QED.

it would be very easy to figure out what contribution an observable gets from its cloud of virtual photons and electron-positron pairs at very high energy E . Let's suppose an observable \mathcal{O} has dimensions $[\text{mass}]^{-\alpha}$, where α is positive. (Of course, since the speed of light is one in these natural units, mass and energy are essentially the same quantity.) Now, at very high virtual-particle energy, E , much higher than any mass, or any energy of a particle in the initial or final state, there is nothing to fix a unit of energy. The contribution of high energy virtual particles to the observable \mathcal{O} must then be given an integral like

$$\mathcal{O} = \int^{\infty} \frac{dE}{E^{\alpha+1}} \quad (3)$$

because this is the only quantity which has the right dimensions, the right units, to give the observable \mathcal{O} . (The lower bound in the integral is some finite energy that marks the dividing line between what we call high and low energy.) This argument only works because there are no other quantities in the theory that have the units of mass or energy. All physicists use this sort of argument from time to time, especially when they can't think of anything else to do.

On the other hand, suppose that there are other

constants around that have units of mass raised to a negative power. Then if you have an expression involving a constant C_1 with units $[\text{mass}]^{-\beta_1}$, and another constant C_2 with units $[\text{mass}]^{-\beta_2}$ and so on, then instead of the simple answer obtained above we get a sum of terms of the form

$$\mathcal{O} = C_1 C_2 \cdots \int^\infty \frac{E^{\beta_1 + \beta_2 + \cdots}}{E^{\alpha+1}} dE \quad (4)$$

again because these are the only quantities that have the right units for the observable \mathcal{O} . Expression (3) is perfectly well-defined, the integral converges (it doesn't add up to infinity), as long as the number α is greater than zero. However, if $\beta_1 + \beta_2 + \cdots$ is greater than α , then (4) will not be well-defined, because the numerator will have more powers of energy than the denominator and so the integral will diverge. The point is that no matter how many powers of energy you have in the denominator, i.e. no matter how large α is, (4) eventually will diverge when you get up to sufficiently high order in the coupling constants, C_1, C_2 , etc., that have dimensions of negative powers of mass, because if you have enough of these constants, then eventually $\beta_1 + \cdots$ is greater than α .

Looking at the Lagrangian density in (1), we can easily work out what the units of the constant e, μ, G , etc., are.

All terms in the Lagrangian density must have units $[\text{mass}]^4$, because length and time have units of inverse mass and the Lagrangian density integrated over spacetime must have no units. From the $m\psi\psi$ term, we see that the electron field must have units $[\text{mass}]^{3/2}$, because $\frac{3}{2} + \frac{3}{2} + 1 = 4$. The derivative operator (the rate of change operator) has units of $[\text{mass}]^1$, and so the photon field also has units $[\text{mass}]^1$. Now we can work out what the units of the coupling constants are. As I said before, the electric charge turns out to be a pure number, to have no units. But then as you add more and more powers of fields, more and more derivatives, you are adding more and more quantities that have units of positive powers of mass, and since the Lagrangian density has to have fixed units of $[\text{mass}]^4$, therefore the mass dimensions of the associated coupling constants must get lower and lower, until eventually you come to constants like μ and G which have negative units of mass. (Specifically, μ has the units of $[\text{mass}]^{-1}$, while G has the units $[\text{mass}]^{-2}$.) Such terms in (1) would completely spoil the agreement between theory and experiment for the magnetic moment of the electron, so experimentally we can say that they are not there to a fantastic order of precision, and for many years it seems that this could be explained by saying that such terms must be excluded because they would give infinite results, as in (4).

Coleman-Mandula

The Lagrangian has 8-dim Lorentz structure satisfying Coleman-Mandula because its fermionic fundamental spinor representations are built with respect to spinor representations for 8-dim Spin(1,7) spacetime.

The Cl(1,25) E8 model has 8-dim Lorentz structure satisfying Coleman-Mandula because its fermionic fundamental spinor representations are built with respect to spinor representations for 8-dim Spin(1,7) spacetime.

The Quantum Theory of Fields

Volume III
Supersymmetry

Steven Weinberg

University of Texas at Austin



CAMBRIDGE
UNIVERSITY PRESS

32

Supersymmetry Algebras in Higher Dimensions

Ever since the ground-breaking work of Kaluza¹ and Klein,² theorists have from time to time tried to formulate a more nearly fundamental physical theory in spacetimes of higher than four dimensions. This approach was revived in superstring theories, which take their simplest form in 10 spacetime dimensions.³ More recently, it has been suggested that the various versions of string theory may be unified in a theory known as *M theory*, which in one limit is approximately described by supergravity in 11 spacetime dimensions.⁴ In this chapter we shall catalog the different types of supersymmetry algebra possible in higher dimensions, and use them to classify supermultiplets of particles.

32.1 General Supersymmetry Algebras

Our analysis of the general supersymmetry algebra in higher dimensions will follow the same logical outline as the work of Haag, Lopuszanski, and Sohnius⁵ on supersymmetry algebras in four spacetime dimensions, described in Section 25.2. The proof of the Coleman–Mandula theorem in the appendix of Chapter 24 makes it clear that the list of possible bosonic symmetry generators is essentially the same in $d > 2$ spacetime dimensions as in four spacetime dimensions: in an *S*-matrix theory of particles, there are only the momentum d -vector P^μ , a Lorentz generator $J^{\mu\nu} = -J^{\nu\mu}$ (with μ and ν here running over the values $1, 2, \dots, d-1, 0$), and various Lorentz scalar ‘charges.’ (In some theories there are topologically stable extended objects such as closed strings, membranes, etc., in addition to particles, which make possible other conserved quantities, to which we will return in Section 32.3.) The anticommutators of the fermionic symmetry generators with each other are bosonic symmetry generators, and therefore must be a linear combination of P^μ , $J^{\mu\nu}$, and various conserved scalars. This puts severe limits on the Lorentz transformation properties of the fermionic generators, and on the superalgebra to which they belong.

We will first prove that the general fermionic symmetry generator must transform according to the fundamental spinor representations of the Lorentz group, which are reviewed in the appendix to this chapter, and not in higher spinor representations, such those obtained by adding vector indices to a spinor. As we saw in Section 25.2, the proof for $d = 4$ by Haag, Lopuszanski, and Sohnius made use of the isomorphism of $SO(4)$ to $SU(2) \times SU(2)$, which has no analog in higher dimensions. Here we will use an argument of Nahm,⁶ which is actually somewhat simpler and applies in any number of dimensions.

Since the Lorentz transform of any fermionic symmetry generator is another fermionic symmetry generator, the fermionic symmetry generators furnish a representation of the homogeneous Lorentz group $O(d-1, d)$ (or, strictly speaking, of its covering group $Spin(d-1, 1)$). Assuming that there are at most a finite number of fermionic symmetry generators, they must transform according to a finite-dimensional representation of the homogeneous Lorentz group. All of these representations can be obtained from the finite-dimensional *unitary* representations of the corresponding orthogonal group $O(d)$ (actually $Spin(d)$) by setting $x^d = ix^0$. So let us first consider the transformation of the fermionic generators under $O(d)$. For d even or odd, we can find $d/2$ or $(d-1)/2$ Lorentz generators J_{d1} , J_{23} , J_{45}, \dots , which all commute with each other, and classify fermionic generators Q according to the values σ_{d1} , σ_{23} , \dots that they destroy:

$$[J_{d1}, Q] = -\sigma_{d1}Q, \quad [J_{23}, Q] = -\sigma_{23}Q, \quad [J_{45}, Q] = -\sigma_{45}Q, \dots \quad (32.1.1)$$

Since the finite-dimensional representations of $O(d)$ are all unitary, the σ s are all real.

Let us focus on one of these quantum numbers, $\sigma_{d1} \equiv w$ and refer to any fermionic or bosonic operator O as having *weight* w if

$$[J_{d1}, O] = -wO, \quad (32.1.2)$$

or, in terms of the Minkowski component $J_{01} = iJ_{d1}$,

$$[J_{01}, O] = -iwO. \quad (32.1.3)$$

The reason for concentrating on this particular quantum number is that it has the special property of being the same for an operator and its Hermitian adjoint. This is because J_{01} must be represented on Hilbert space (though not on field variables or symmetry generators) by a Hermitian operator, so that (remembering that w is real) the Hermitian adjoint of Eq. (32.1.3) is

$$-[J_{01}, O^*] = +iwO^*, \quad (32.1.4)$$

so O^* has the same weight as O .

Now consider the anticommutator $\{Q, Q^*\}$ of any fermionic symmetry generator Q with its Hermitian adjoint. According to the Coleman-Mandula theorem, it is at most a linear combination of P_μ , $J_{\mu\nu}$, and scalars. To calculate the weights of the components of P_μ , we recall the commutation relation (2.4.13)

$$i[P_\mu, J_{\rho\sigma}] = \eta_{\mu\rho}P_\sigma - \eta_{\mu\sigma}P_\rho,$$

which shows that $P_0 \pm P_1$ has weight $w = \pm 1$, while the other components P_2, P_3, \dots, P_{d-1} all have weight zero. In the same way, the commutation relation (2.4.12) of the $J_{\mu\nu}$ with each other show that $J_{0i} \pm J_{1i}$ with $i = 2, 3, \dots, d-1$ have weight $w = \pm 1$, the J_{ij} with both i and j between 2 and $d-1$ have weight zero, J_{10} has weight zero, and of course all scalars have weight zero. We conclude then that all bosonic symmetry generators have weight ± 1 or 0 and the anticommutator $\{Q, Q^*\}$ must be a linear combination of operators with such weights. If Q has weight w then $\{Q, Q^*\}$ has weight $2w$, and it is manifestly non-zero for any non-zero Q , so each fermionic generator can only have weight $\pm 1/2$. (Weight zero is excluded by the connection between spin and statistics — fermionic operators can only be constructed from odd numbers of operators with half-integer weights.) Going back to the Euclidean formalism, since the commutators of the particular $O(d)$ generator J_{01} with all generators Q in a representation of $O(d)$ are given by Eq. (32.1.2) with $w = \pm 1/2$, and there is nothing special about the 01 plane, $O(d)$ invariance requires that the same is true for all $O(d)$ generators J_{ij} , so that all the σ s in Eq. (32.1.1) are $\pm 1/2$. The only irreducible representations of the homogeneous Lorentz group with all σ s equal to $\pm 1/2$ are the fundamental spinor representations, so Q must belong to some direct sum of these representations.

We can also use this approach to show that the fermionic generators Q all commute with the d -momentum P_μ . For this purpose, note that the double commutator of a momentum operator $P_0 \pm P_1$ of weight ± 1 with any fermionic generator Q would have weight either $\pm 5/2$ if Q has weight $\pm 1/2$ or weight $\pm 3/2$ if Q has weight $\mp 1/2$, and since we have found that there are no fermionic symmetry generators of weight $\pm 3/2$ or $\pm 5/2$, these double commutators must all vanish:

$$[P_0 \pm P_1, [P_0 \pm P_1, Q]] = 0.$$

It follows then that

$$[P_0 \pm P_1, [P_0 \pm P_1, \{Q, Q^*\}]] = -2\{Q_\pm, Q_\pm^*\},$$

where

$$Q_\pm \equiv [P_0 \pm P_1, Q].$$

Now, $\{Q, Q^*\}$ is at most a linear combination of J s, P s, and scalar

symmetry generators. The commutators of $P_0 \pm P_1$ with the P s and scalar symmetry generators vanish, while the commutators of $P_0 \pm P_1$ with the J s are linear combinations of P s, which commute with the other $P_0 \pm P_1$, so the double commutator $[P_0 \pm P_1, [P_0 \pm P_1, \{Q, Q^*\}]]$ must vanish and therefore $\{Q_\pm, Q_\pm^*\} = 0$, which implies that $Q_\pm = 0$. Since *all* members of the representation of the Lorentz group provided by the Q s thus commute with P_0 and P_1 , Lorentz invariance implies that all Q s commute with all P s, as was to be shown.

There is an important corollary that since the Lorentz generators $J_{\mu\nu}$ do not commute with the momentum operators, they cannot appear on the right-hand side of the anticommutation relations. For the moment let us label the Q s as Q_n , where n runs over the labels for the different (not necessarily inequivalent) irreducible spinor representations among the Q s, now *including* their adjoints Q^* , and also over the index labelling members of these representations. The general anticommutation relation is then of the form

$$\{Q_n, Q_m\} = \Gamma_{nm}^\mu P_\mu + Z_{nm}, \quad (32.1.5)$$

where the Γ_{nm}^μ are c-number coefficients and the Z_{nm} are conserved scalar symmetry generators, which commute with the P_μ and $J_{\mu\nu}$. We now want to show that the Z_{nm} are *central charges* of the supersymmetry algebra — that is, that they commute with the Q_ℓ and each other as well as with the P_μ and $J_{\mu\nu}$ and all other symmetry generators.

To prove this for $d \geq 4$, note that for a given Z_{nm} to be non-zero, since it is a scalar all of the σ s in Eq. (32.1.1) must be opposite for Q_n and Q_m . Consider another fermionic symmetry generator Q_ℓ , for which the σ s of Eq. (32.1.1) are not all the same as those of either Q_n or Q_m . (For $d \geq 4$ there is always such a Q_ℓ in each set of Q s forming an irreducible spinor representation of $O(d)$.) We apply the super-Jacobi identity

$$[Q_\ell, \{Q_m, Q_n\}] + [Q_m, \{Q_n, Q_\ell\}] + [Q_n, \{Q_\ell, Q_m\}] = 0. \quad (32.1.6)$$

The anticommutators $\{Q_n, Q_\ell\}$ and $\{Q_\ell, Q_m\}$ are operators that have some σ s non-zero, so they can only be linear combinations of P s rather than Z s, and so must commute with all Q s. This leaves just

$$0 = [Q_\ell, \{Q_m, Q_n\}] = [Q_\ell, Z_{mn}]. \quad (32.1.7)$$

Thus in each set of Q s forming an irreducible spinor representation of $O(d)$ there is at least one that commutes with the given Z_{mn} . But Z_{mn} is a Lorentz scalar, so it must then commute with all Q s. It follows then immediately from Eq. (32.1.5) that they also commute with each other.

The fermionic generators must form a representation (perhaps trivial) of the algebra \mathcal{A} consisting of *all* scalar bosonic symmetry generators. It follows then by precisely the same argument used in Section 25.2 that

the central charges Z_{mn} furnish an invariant Abelian subalgebra of \mathcal{A} . The Coleman–Mandula theorem tells us that \mathcal{A} must be a direct sum of a compact semi-simple Lie algebra, which by definition contains no invariant Abelian subalgebras, together with $U(1)$ generators, so the Z_{mn} must be $U(1)$ generators, which commute with all other bosonic symmetry generators, not just with each other.

To obtain more detailed information about the structure of the anti-commutation relations (32.1.5), we must be more specific about the Lorentz transformation and reality properties of the fermionic symmetry generators Q_n . These are very different for spacetimes of even and odd dimensionality.

Odd Dimensionality

The appendix to this chapter shows that for odd spacetime dimensions d there is just one fundamental spinor representation of the Lorentz algebra, by matrices $\mathcal{J}_{\mu\nu}$ given in terms of Dirac matrices by Eq. (32.A.2), so we must label the fermionic generators as Q_{ar} , where α is a $2^{(d-1)/2}$ -valued Dirac index, and $r = 1, 2, \dots, N$ labels different spinors in the case of N -extended supersymmetry. With this notation, the Lorentz transformation properties of the Q s imply that

$$[J_{\mu\nu}, Q_{ar}] = - \sum_{\beta} (\mathcal{J}_{\mu\nu})_{\alpha\beta} Q_{\beta r}, \quad (32.1.8)$$

so that the anticommutators of these generators have the transformation rule

$$[J_{\mu\nu}, \{Q_{ar}, Q_{\beta s}\}] = - \sum_{\bar{\alpha}} (\mathcal{J}_{\mu\nu})_{\alpha\bar{\alpha}} \{Q_{\bar{\alpha}r}, Q_{\beta s}\} - \sum_{\bar{\beta}} (\mathcal{J}_{\mu\nu})_{\beta\bar{\beta}} \{Q_{ar}, Q_{\bar{\beta}s}\}.$$

Recalling the Lorentz transformation rule (2.4.13) for the momentum operator P_λ , we see that the matrix Γ_{rs}^λ and the operator Z_{rs} in Eq. (32.1.5) (with Dirac indices now suppressed) must satisfy the conditions

$$\mathcal{J}_{\mu\nu}(\Gamma_\lambda)_{rs} + (\Gamma_\lambda)_{rs}\mathcal{J}_{\mu\nu}^\text{T} = -i(\Gamma_\mu)_{rs}\eta_{\nu\lambda} + i(\Gamma_\nu)_{rs}\eta_{\mu\lambda}, \quad (32.1.9)$$

$$\mathcal{J}_{\mu\nu}Z_{rs} + Z_{rs}\mathcal{J}_{\mu\nu}^\text{T} = 0. \quad (32.1.10)$$

But Eq. (32.A.38) gives $\mathcal{J}_{\mu\nu}^\text{T} = -\mathcal{C}^{-1}\mathcal{J}_{\mu\nu}\mathcal{C}$, so Eqs. (32.1.9) and (32.1.10) may be expressed as the requirement that $(\Gamma_\mu)_{rs}\mathcal{C}^{-1}$ satisfies the same commutation relation (32.A.32) with $\mathcal{J}_{\mu\nu}$ as γ_μ , while $Z_{rs}\mathcal{C}^{-1}$ commutes with $\mathcal{J}_{\mu\nu}$. For odd d the matrices satisfying these conditions are unique up to multiplication with constants, so we can conclude that

$$\Gamma_{\alpha r \beta s}^\lambda = i g_{rs} (\gamma^\lambda \mathcal{C})_{\alpha\beta} \quad (32.1.11)$$

Octonionic NonUnitary Inflation Particle Creation

The tensor product $Cl(8) \times Cl(8) = Cl(16)$

			1	
			16	
			120	
			560	
			1820	
			4368	
			8008	
			11440	
			12870	
			11440	
			8008	
			4368	
			1820	
			560	
			120	
			16	
			1	
			Cl(16)	
Cl(8)	x	Cl(8)	=	Cl(16)

Spinors: $(\boxed{8s \times 8s} + \boxed{8c \times 8c})$
 $(8s+8c) \times (8s+8c) = \quad + \quad (8s \times 8c + 8c \times 8s)$

- 256 = $\sqrt{2^{16}}$ = 128 + 128 Cl(16) spinors
- 128 Cl(16) half-spinors = 64 + 64 fermions + antifermions
- 120 = Cl(16) bivectors = D8 root vectors
- 120 + 64 + 64 = E8 root vectors
- E8 / D8 = 128-dim (OxO)P2 OctoOctonionic Projective Plane
- D8 / D4xD4 = Gr(8,16) = 64-dim Octonionic Subspaces of R16
- (Gr = Grassmanian and R16 = Vectors of Clifford Cl(16) Matrix Algebra for D8)
- one D4 contains D3 of Conformal Gravity+Dark Energy
- other D4 contains A3 of Standard Model Color Force SU(3)
- (CP2 = SU(3) / SU(2)xU(1) of Kaluza-Klein contains SU(2)xU(1) of Electroweak Forces)
- (Cl(16) = Cl(0,16) lives in Cl(1,25) of E8 26D String Theory)

One $CI(1,25)$ containing one $CI(0,16)$ containing one $E8$ gives a Lagrangian description of one local spacetime neighborhood. To get a realistic global spacetime structure, take the tensor product $CI(1,25) \times \dots \times CI(1,25)$ with all $E8$ local 8-dim Octonionic spacetimes consistently aligned as described by **64-dim $D8 / D4 \times D4$ (blue dots)** (this visualization hexagonal 2D projection of the 240 $E8$ root vectors).

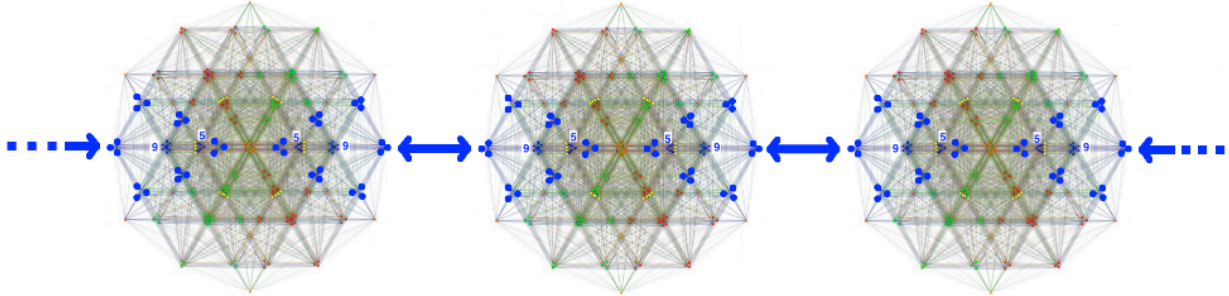

which then fill up spacetime according to Gray Code Hilbert's curves:

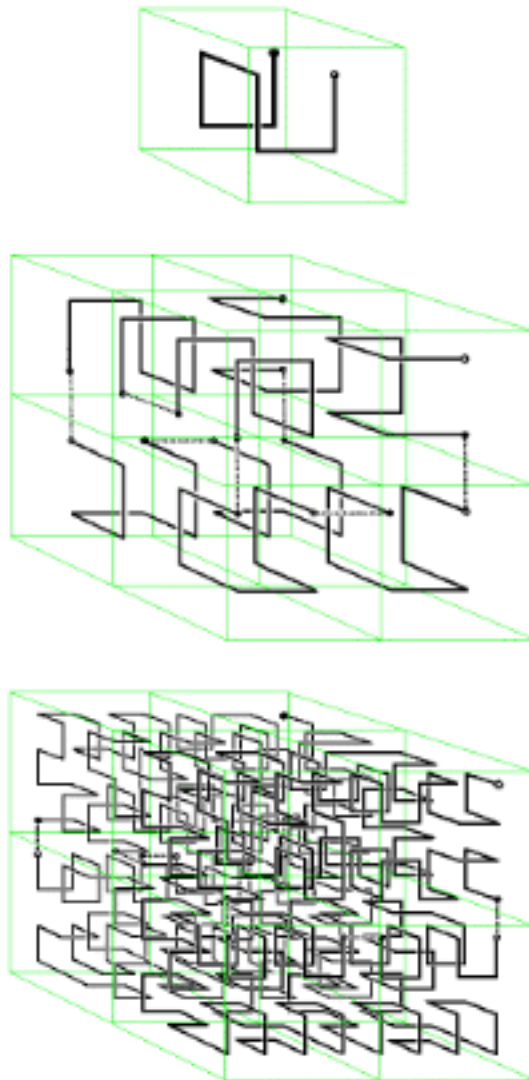

Our Universe emerged from its parent in Octonionic Inflation

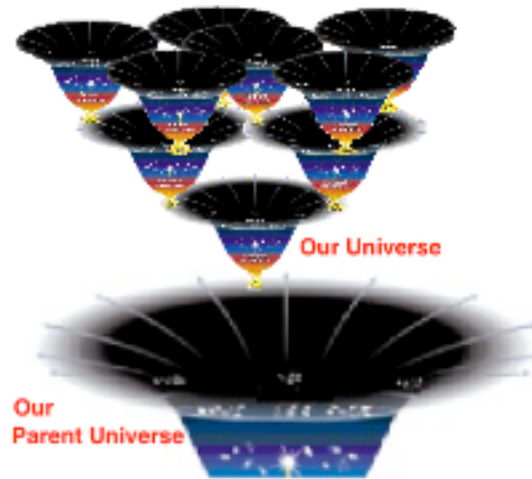

As Our Parent Universe expanded to a Cold Thin State Quantum Fluctuations occurred. Most of them just appeared and disappeared as Virtual Fluctuations, but at least one Quantum Fluctuation had enough energy to produce 64 Unfoldings and reach Paola Zizzi's State of Decoherence thus making it a Real Fluctuation that became Our Universe.

As Our Universe expands to a Cold Thin State, it will probably give birth to Our Child, GrandChild, etc, Universes.

Unlike "the inflationary multiverse" described by Andrei Linde in arXiv 1402.0526 as "a scientific justification of the anthropic principle", in the $Cl(16,25)$ E8 model ALL Universes (Ours, Ancestors, Descendants) have the SAME Physics Structure as E8 Physics (viXra 1312.0036 and 1310.0182)

In the $Cl(1,25)$ E8 model, our SpaceTime remains Octonionic 8-dimensional throughout inflation.

Stephen L. Adler in his book Quaternionic Quantum Mechanics and Quantum Fields (1995) said at pages 50-52, 561: "... If the multiplication is associative, as in the complex and quaternionic cases, we can remove parentheses in ... Schroedinger equation dynamics ... to conclude that ... the inner product $\langle f(t) | g(t) \rangle$... is invariant ... this proof fails in the octonionic case, and hence one cannot follow the standard procedure to get a unitary dynamics. ...[so there is a]... **failure of unitarity in octonionic quantum mechanics ...**".

Creation-Annihilation Operators are the 64-dim grade-0 part of the E8 Maximal Contraction generalized Heisenberg Algebra
 $\mathfrak{h}_{92} \times \mathfrak{A}_7 = 28 + 64 + ((\mathfrak{SL}(8, \mathbb{R}) + 1) + 64 + 28$

The NonAssociativity and Non-Unitarity of Octonions accounts for particle creation without the need for a conventional inflaton field.

E8 Physics has Representation space for 8 Fermion Particles + 8 Fermion Antiparticles on the original Cl(1,25) E8 Local Lagrangian Region



where a Fermion Representation slot _ of the 8+8 = 16 slots can be filled

by Real Fermion Particles ■ or Real Fermion Antiparticles ■

IF the Quantum Fluctuation(QF) has enough Energy to produce them as Real and

IF the Cl(1,25) E8 Local Lagrangian Region has an Effective Path from its QF Energy to that Particular slot.

Let Cl(16) = Cl(8) x Cl(8) contained in Cl(1,25) where the first Cl(8) contains the D4 of Conformal Gravity with actions on M4 physical spacetime whose CPT symmetry determines the property matter - antimatter.

Consider, following basic ideas of Geoffrey Dixon related to his characterization of 64-dimensional spinor spaces as C x H x O (C = complex, H = quaternion, O = octonion), 64-dim 64s₊₊ = 8s₊ x 8s₊ of Cl(8) x Cl(8) = Cl(16)

and

64-dim 64s_{+ -} = 8s₊ x 8s₋ of Cl(8) x Cl(8) = Cl(16)

so that

64s₊₊ + 64s_{+ -} = 128s₊ are +half-spinors of Cl(16) which is in E8

Then Cl(16) contains

128-dim +half-spinor space 64s₊₊ + 64s_{+ -} of Cl(16) in E8 = Fermion Generation

and

128-dim -half-spinor space 64s_{- +} + 64s₋₋ of Cl(16) not in E8 = Fermion AntiGeneration

Since E8 contains only the 128 +half-spinors and none of the 128 -half-spinors of Cl(16)

and

since, due to their +half-spinor property with respect to the first Cl(8),

the 128s₊ = 64s₊₊ + 64s_{+ -} have only Effective Paths of QF Energy that go

to the Fermion Particle slots that are also of type +

that is, to the 8 Fermion Particle Representation slots



Next, consider **the first Unfolding step of Octonionic Inflation**. It is based on all 16 = 8 Fermion Particle slots + 8 Fermion Antiparticle Representation slots whether or not they have been filled by QF Energy.

7 of the 8 Fermion Particle slots correspond to the 7 Imaginary Octonions and therefore to the 7 Independent E8 Integral Domain Lattices and therefore to 7 New CI(1,25) E8 Local Lagrangian Regions. The 8th Fermion Particle slot corresponds to the 1 Real Octonion and therefore to the 8th E8 Integral Domain Lattice (not independent - see Kirmse's mistake) and therefore to the 8th New CI(1,25) E8 Local Lagrangian Region. Similarly, the 8 Fermion Antiparticle slots Unfold into 8 more New New CI(1,25) E8 Local Lagrangian Regions, so that one Unfolding Step is a 16-fold multiplication of CI(1,25) E8 Local Lagrangian Regions:

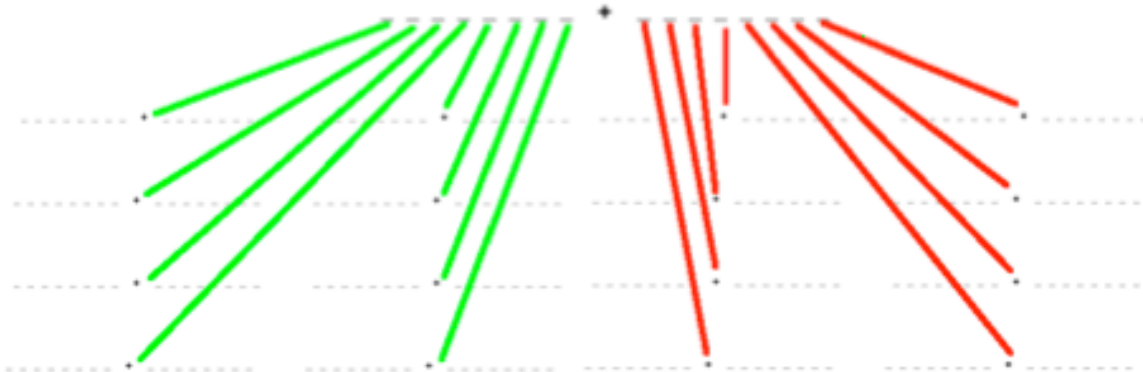

If the QF Energy is sufficient, the Fermion Particle content after the first Unfolding is is

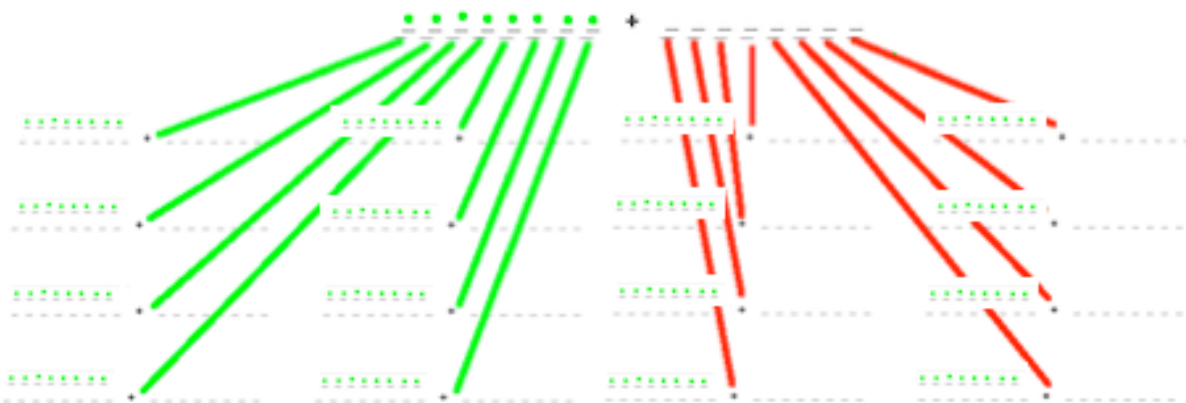

so it is clear that **the Octonionic Inflation Unfolding Process creates Fermion Particles with no Antiparticles, thus explaining the dominance of Matter over AntiMatter in Our Universe.**

Each Unfolding has duration of the Planck Time T_{Planck} and none of the components of the Unfolding Process Components are simultaneous, so that **the total duration of N Unfoldings is $2^N T_{\text{Planck}}$.**

Paola Zizzi in gr-qc/0007006 said: "... **during inflation, the universe can be described as a superposed state of quantum ... [qubits].** the self-reduction of the superposed quantum state is ... reached at the end of inflation ...[at]... **the decoherence time ... [$T_{\text{decoh}} = 10^9 T_{\text{Planck}} = 10^{-(34)}$ sec] ...** and **corresponds to a superposed state of ... [$10^{19} = 2^{64}$ qubits]. ...".**

Why decoherence at 64 Unfoldings = 2^{64} qubits ?

2^{64} qubits corresponds to the Clifford algebra $Cl(64) = Cl(8 \times 8)$.

By the periodicity-8 theorem of Real Clifford algebras, $Cl(64)$ is the smallest Real Clifford algebra for which we can reflexively identify each component $Cl(8)$

with a vector in the $Cl(8)$ vector space. This reflexive identification/reduction causes our universe to decohere at $N = 2^{64} = 10^{19}$

which is roughly the number of Quantum Consciousness Tubulins in the Human Brain.

The Real Clifford Algebra $Cl(8)$ is the basic building block of Real Clifford Algebras due to 8-Periodicity whereby $Cl(8N) = Cl(8) \times \dots (N \text{ times tensor product}) \dots \times Cl(8)$

An Octonionic basis for the $Cl(8)$ 8-dim vector space is $\{1, i, j, k, E, I, J, K\}$

NonAssociativity, NonUnitarity, and Reflexivity of Octonions is exemplified by

the 1-1 correspondence between Octonion Basis Elements and $E8$ Integral Domains

$$1 \Leftrightarrow 0E8$$

$$i \Leftrightarrow 1E8$$

$$j \Leftrightarrow 2E8$$

$$k \Leftrightarrow 3E8$$

$$E \Leftrightarrow 4E8$$

$$I \Leftrightarrow 5E8$$

$$J \Leftrightarrow 6E8$$

$$K \Leftrightarrow 7E8$$

where $1E8, 2E8, 3E8, 4E8, 5E8, 6E8, 7E8$ are 7 independent Integral Domain $E8$ Lattices and $0E8$ is an 8th $E8$ Lattice (Kirmse's mistake) not closed as an Integral Domain.

Using that correspondence expands the basis $\{1, i, j, k, E, I, J, K\}$ to

$$\{0E8, 1E8, 2E8, 3E8, 4E8, 5E8, 6E8, 7E8\}$$

Each of the $E8$ Lattices has 240 nearest neighbor vectors so the total dimension of the Expanded Space is $240 \times 240 \times 240 \times 240 \times 240 \times 240 \times 240 \times 240$

Everything in the Expanded Space comes directly from the original $Cl(8)$ 8-dim space so all Quantum States in the Expanded Space can be held in Coherent Superposition.

However,

if further expansion is attempted, there is no direct connection to original $Cl(8)$ space and any Quantum Superposition undergoes Decoherence.

If each 240 is embedded reflexively into the 256 elements of $Cl(8)$ the total dimension is

$$256 \times 256 \times 256 \times 256 \times 256 \times 256 \times 256 \times 256 = 256^8 = 2^{(8 \times 8)} = 2^{64} = \\ = Cl(8) \times Cl(8) \times Cl(8) \times Cl(8) \times Cl(8) \times Cl(8) \times Cl(8) \times Cl(8) = Cl(8 \times 8) = Cl(64)$$

so the largest Clifford Algebra that can maintain Coherent Superposition is $Cl(64)$

which is why Zizzi Quantum Inflation ends at the $Cl(64)$ level.

At the end of 64 Unfoldings, Non-Unitary Octonionic Inflation ended having produced about $(1/2) 16^{64} = (1/2) (2^4)^{64} = 2^{255} = 6 \times 10^{76}$ Fermion Particles

The End of Inflation time was at about $10^{(-34)}$ sec = 2^{64} Tplanck

and

the size of our Universe was then about $10^{(-24)}$ cm

which is about the size of a Fermion Schwinger Source Kerr-Newman Cloud.

Bohm Quantum Potential with Sarfatti Back-Reaction and AQFT as Third Grothendieck Universe

The First Grothendieck Universe is the Empty Set.

**The Second Grothendieck Universe is Hereditarily Finite Sets such as a
Generalized Feynman Checkerboard Quantum Theory
based on E8 Lattices and Discrete Cl(1,25) Clifford Algebra.**

**The Third Grothendieck Universe is the Completion of Union of all tensor
products of Cl(1,25) Real Clifford algebra**

Since the Cl(1,25) E8 Lagrangian is Local and Classical,
it is necessary to patch together Local Lagrangian Regions to form a Global Structure
describing a Global Cl(1,25) E8 Algebraic Quantum Field Theory (AQFT).

The usual Hyperfinite II1 von Neumann factor for creation and annihilation operators on
Fermionic Fock Space over $C^{(2n)}$ is constructed by completion of the union of all
tensor products of 2x2 Complex Clifford algebra matrices, which have Periodicity 2,
so for the Cl(1,25) E8 model based on Real Clifford Algebras with Periodicity 8,
Cl(1,25) = 2x2 matrices of Cl(0,24) where Cl(0,24) = Cl(0,8) x Cl(0,8) x Cl(0,8),
**the completion of the union of all tensor products of Cl(1,25)
produces a generalized Hyperfinite II1 von Neumann factor
that gives the Cl(1,25) E8 model a natural Algebraic Quantum Field Theory.**

In other words, consider E8 to be Local Classical
and embed E8 into the real Clifford Algebra Cl(0,16)
and use 8-Periodicity to form the Completion of the Union of all Tensor Products of
Cl(0,16) which produces a natural realistic Algebraic Quantum Field Theory (AQFT).

The structure is related to unconventional 26D String Theory by

$Cl(0,16) \rightarrow Cl(0,16) \times Cl(0,8) = Cl(0,24) \rightarrow M(2, Cl(0,24)) = Cl(1,25)$
where $M(2, Cl(0,24)) = 2 \times 2$ matrices with entries in Cl(0,24) and \times = tensor product.

Cl(0,24) contains the Vector Space of the 24-dim Leech Lattice Λ_{24} that is composed of
3 copies of E8 Lattices (2 being Integral Domains and 1 not Algebraically closed)

Since all the matrix entries are Cl(0,24) = tensor product of 3 copies of Cl(0,8)
8-Periodicity allows formation of the tensor products of copies of Cl(1,25) and therefore

the Completion of Union of All Tensor Products of Cl(1,25)

which is the String Theory formulation of the hyperfinite AQFT

with Real / Octonionic structure inherited from Cl(0,8) and also Quaternionic structure
due to Cl(1,25) = Cl(1,9) x Cl(0,8) x Cl(0,8) and Cl(1,9) = Cl(1,5) x Cl(0,4) =
= Cl(2,4) x Cl(0,4) where the vector space of Cl(2,4) is 6-dim Conformal Spacetime

(see "Clifford Algebras and the Classical Groups" by Ian Porteous
and his Chapter 2 of "Lectures on Clifford (Geometric) Algebras and Applications")

The overall structure of $Cl(160-E8)$ AQFT is similar to the Many-Worlds picture described by David Deutsch in his 1997 book "The Fabric of Reality" said (pages 276-283): "... there is no fundamental demarcation between snapshots of other times and snapshots of other universes ... Other times are just special cases of other universes ... Suppose ... we toss a coin ... Each point in the diagram represents one snapshot

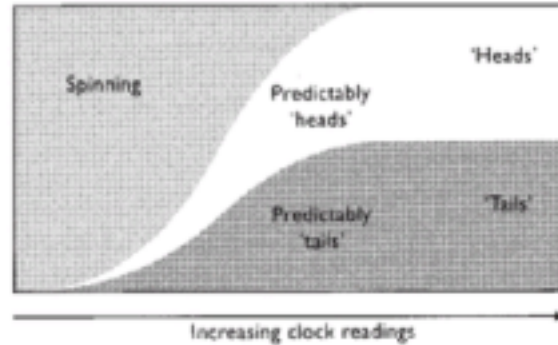

... in the multiverse there are far too many snapshots for clock readings alone to locate a snapshot relative to the others. To do that, we need to consider the intricate detail of which snapshots determine which others. ...

in some regions of the multiverse, and in some places in space, the snapshots of some physical objects do fall, for a period, into chains, each of whose members determines all the others to a good approximation ...".

The Real Clifford Algebra $Cl(1,25)$ containing $E8$ for the Local Lagrangian of a Region is equivalent to a "snapshot" of the Deutsch "multiverse".

The completion of the union of all tensor products of all $Cl(1,25)$ $E8$ Local Lagrangian Regions forms a generalized hyperfinite II_1 von Neumann factor AQFT and emergently self-assembles into a structure = Deutsch multiverse.

For the $Cl(1,25)$ $E8$ model AQFT to be realistic, it must be consistent with **EPR entanglement relations**. Joy Christian in arXiv 0904.4259 said: "... a [geometrically] correct local-realistic framework ... provides exact, deterministic, and local underpinnings ... The alleged non-localities ... result from misidentified [geometries] of the EPR elements of reality. ... The correlations are ... the classical correlations [such as those] among the points of a 3 or 7-sphere ... S^3 and S^7 ... are ... parallelizable ... The correlations ... can be seen most transparently in the elegant language of Clifford algebra ...".

Since $E8$ is a Lie Group and therefore parallelizable and lives in Clifford Algebra $Cl(1,25)$, **the $Cl(1,25)$ $E8$ model is consistent with EPR.**

The Creation-Annihilation Operator structure of Cl(1,25) E8 AQFT is given by the
 Maximal Contraction of E8 = semidirect product A7 x h92

where h92 = 92+1+92 = 185-dim Heisenberg algebra and A7 = 63-dim SL(8)
 The Maximal E8 Contraction A7 x h92 can be written as a 5-Graded Lie Algebra

$$28 + 64 + (\text{SL}(8, \mathbb{R}) + 1) + 64 + 28$$

$$\text{Central Even Grade } 0 = \text{SL}(8, \mathbb{R}) + 1$$

The 1 is a scalar and SL(8,R) = Spin(8) + Traceless Symmetric 8x8 Matrices,
 so SL(8,R) represents a local 8-dim SpaceTime in Polar Coordinates.

$$\text{Odd Grades } -1 \text{ and } +1 = 64 + 64$$

Each = 64 = 8x8 = Creation/Annihilation Operators for 8 components of 8 Fundamental Fermions.

$$\text{Even Grades } -2 \text{ and } +2 = 28 + 28$$

Each = Creation/Annihilation Operators for 28 Gauge Bosons of Gravity + Standard Model.

The Cl(1,25) E8 AQFT inherits structure from the Cl(1,25)- 8 Local Lagrangian

$$\int_{\text{8-dim SpaceTime}} \text{Gauge Gravity} + \text{Standard Model} + \text{Fermion Particle-AntiParticle}$$

The Cl(1,25)-E8 generalized Hyperfinite II1 von Neumann factor Algebraic Quantum Field Theory is based on the Completion of the Union of all Tensor Products of the form

$$\text{Cl}(1,25) \times \dots (\text{N times tensor product}) \dots \times \text{Cl}(1,25)$$

For N = 2^8 = 256 the copies of Cl(1,25) are on the 256 vertices of the 8-dim HyperCube



For N = 2^16 = 65,536 = 4^8 the copies of Cl(1,25) fill in the 8-dim HyperCube as described by William Gilbert's web page: "... The n-bit reflected binary Gray code will describe a path on the edges of an n-dimensional cube that can be used as the initial stage of a Hilbert curve that will fill an n-dimensional cube. ...".

The vertices of the Hilbert curve are at the centers of the 2^8 sub-8-HyperCubes whose edge lengths are 1/2 of the edge lengths of the original 8-dim HyperCube

As N grows, the copies of $Cl(1,25)$ continue to fill the 8-dim HyperCube of E_8 SpaceTime

using higher Hilbert curve stages from the 8-bit reflected binary Gray code subdividing the initial 8-dim HyperCube into more and more sub-HyperCubes.

If edges of sub-HyperCubes, equal to the distance between adjacent copies of $Cl(1,25)$, remain constantly at the Planck Length, then the

full 8-dim HyperCube of our Universe expands as N grows to 2^{16} and beyond

similarly to the way shown by this 3-HyperCube example for $N = 2^3, 4^3, 8^3$

from William Gilbert's web page:

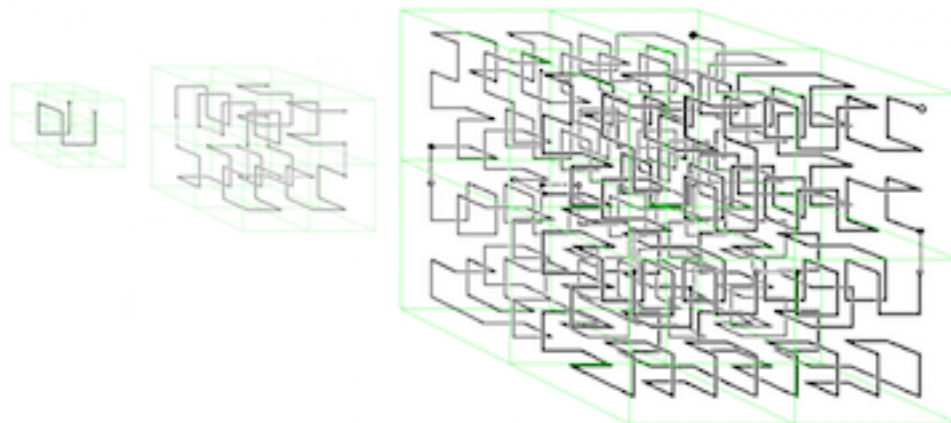

**The Union of all $Cl(1,25)$ tensor products is
the Union of all subdivided 8-HyperCubes
and**

**their Completion is a huge superposition of 8-HyperCube Continuous Volumes
which Completion belongs to the Third Grothendieck Universe.**

AQFT Quantum Code

Cerf and Adami in quantum-ph/9512022 describe virtual qubit-anti-qubit pairs (they call them ebit-anti-ebitpairs) that are related to negative conditional entropies for quantum entangled systems and are similar to fermion particle-antiparticle pairs. Therefore quantum information processes can be described by particle-antiparticle diagrams much like particle physics diagrams and

the Algebraic Quantum Field Theory of the CI(1,25) E8 Physics Model should have a Quantum Code Information System

that is **based on structure of a unit cell in 26D String Theory**
 represented by **Real Clifford Algebra CI(0,8) x CI(0,8) x CI(0,8) = CI(0,24)**
 (see Appendix - Details of World-Line String Bohm Quantum Theory)

Since Quantum Reed-Muller code [[256 , 0 , 24]]
 corresponds to
Real Clifford Algebra CI(0,8)

Tensor Product Quantum Reed-Muller code
[[256 , 0 , 24]] x **[[256 , 0 , 24]]** x **[[256 , 0 , 24]]**
 corresponds to

AQFT (Algebraic Quantum Field Theory) hyperfinite von Neumann factor algebra
that is Completion of the Union of All Tensor Products of CI(1,25)

Quantum Reed-Muller code [[256 , 0 , 24]]

is described in quantum-ph/9608026 by Steane as mapping a quantum state space of 256 qubits into 256 qubits, correcting $((24-1)/2) = 11$ errors, and detecting $24/2 = 12$ errors.

Let $C(n,t) = n! / t! (n-t)!$

Then

[[256, 0, 24]]

is of the form

[[2 ⁿ ,	2 ⁿ - C(n,t) - 2 SUM(0 k t-1) C(n,k),	2 ^t + 2 ^(t-1)]]
[[2 ⁸ ,	2 ⁸ - C(8,4) - 2 SUM(0 k 3) C(8,k),	2 ⁴ + 2 ⁽⁴⁻¹⁾]]
[[2 ⁸ ,	2 ⁸ - 70 - (1+8+28+56) - (1+8+28+56),	16 + 8]]
[[256,	256 - (1+8+28+56+70+56+28+8+1),	16 + 8]]
[[256,	16x16 - SUM(0 k 8) 8/\8/\...(k)../\8,	16 + 8]]

The quantum code [[256, 0, 24]]

can be constructed from the classical Reed-Muller code (256, 93, 32) of the form

(2 ⁸ ,	2 ⁸ - SUM(0 k t) C(n,k),	2 ^(t+1))
(2 ⁸ ,	2 ⁸ - SUM(0 k 4) C(n,k),	2 ⁵)
(2 ⁸ ,	2 ⁸ - (70+56+28+8+1),	32)
(2 ⁸ ,	1+8+28+56,	32)

To construct the quantum code $[[256, 0, 24]]$:

First, form a quantum code generator matrix from the 128×256 generator matrix G of the classical code $(256, 93, 32)$:

$$\begin{array}{c|c|c} | & & | \\ | & G & | 0 \\ | & 0 & | G \\ | & & | \end{array}$$

Second, form the generator matrix of a quantum code of distance 16 by adding to the quantum generator matrix a matrix D_x such that G and D_x together generate the classical Reed-Muller code $(256, 163, 16)$:

$$(2^8, 1+8+28+56+70, 16) :$$

$$\begin{array}{c|c|c} | & & | \\ | & G & | 0 \\ | & 0 & | G \\ | & D_x & | 0 \\ | & & | \end{array}$$

This quantum code has been made by combining the classical codes $(256, 93, 32)$ and $(256, 163, 16)$, so that it is of the form $[[256, 93 + 163 - 256, \min(32, 16)]] = [[256, 0, 16]]$.

It is close to what we want, but has distance 16. For the third and final step, increase the distance to $16+8 = 24$ by adding D_z to the quantum generator matrix:

$$\begin{array}{c|c|c} | & & | \\ | & G & | 0 \\ | & 0 & | G \\ | & D_x & | D_z \\ | & & | \end{array}$$

This is the generator matrix of the quantum code $[[256, 0, 24]]$ as constructed by Steane.

The two classical Reed-Muller codes used to build $[[256, 0, 24]]$ are $(256, 163, 32)$ and $(256, 93, 16)$, classical Reed-Muller codes of orders 4 and 3, which are dual to each other. Due to the nested structure of Reed-Muller codes, they contain the Reed-Muller codes of orders 2, 1, and 0 :

Classical Reed-Muller Codes of Length $2^8 = 256$				Order
(256,	$1+8+28+56+70+56+28+8+1,$	1)	8
(256,	$1+8+28+56+70+56+28+8,$	2)	7
(256,	$1+8+28+56+70+56+28,$	4)	6
(256,	$1+8+28+56+70+56,$	8)	5
(256,	$1+8+28+56+70,$	16)	4
(256,	$1+8+28+56,$	32)	3
(256,	$1+8+28,$	64)	2
(256,	$1+8,$	128)	1
(256,	1,	256)	0

In the Lagrangian of the $Cl(1,25)$ E8 Physics Model

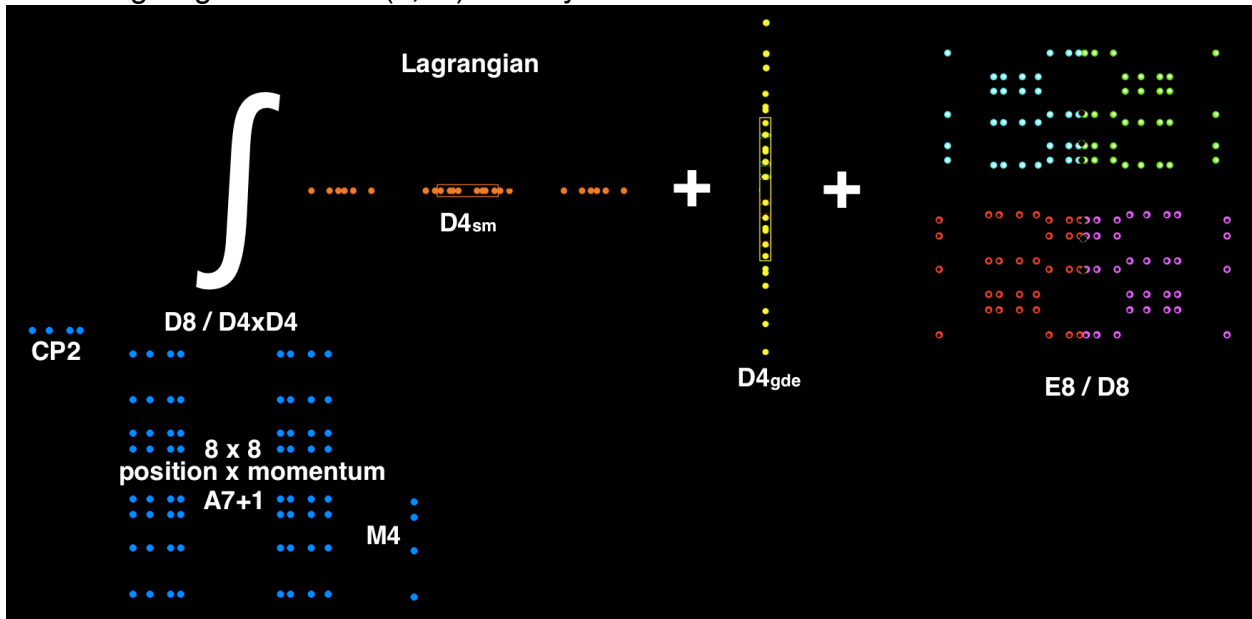

the Higgs scalar prior to dimensional reduction corresponds to the 0th order classical Reed-Muller code $(256, 1, 256)$, the classical repetition code;

the 8-dimensional vector spacetime

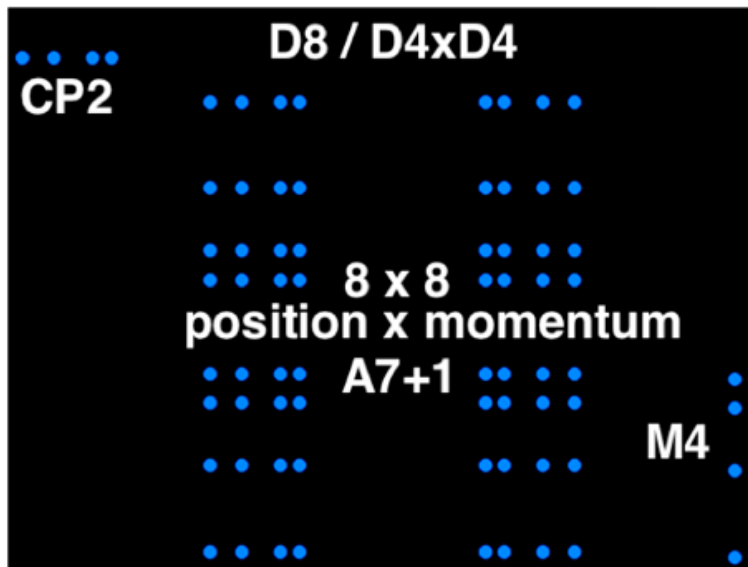

prior to dimensional reduction corresponds to non-0th-order part of the 1st order classical Reed-Muller code (256, 9, 128), which is dual to the 6th order classical Reed-Muller code (256, 247, 4), which is the extended Hamming code, extended from the binary Hamming code (255, 247, 3), which is dual to the simplex code (255, 8, 128) ;

the 28-dimensional bivector adjoint gauge boson spaces

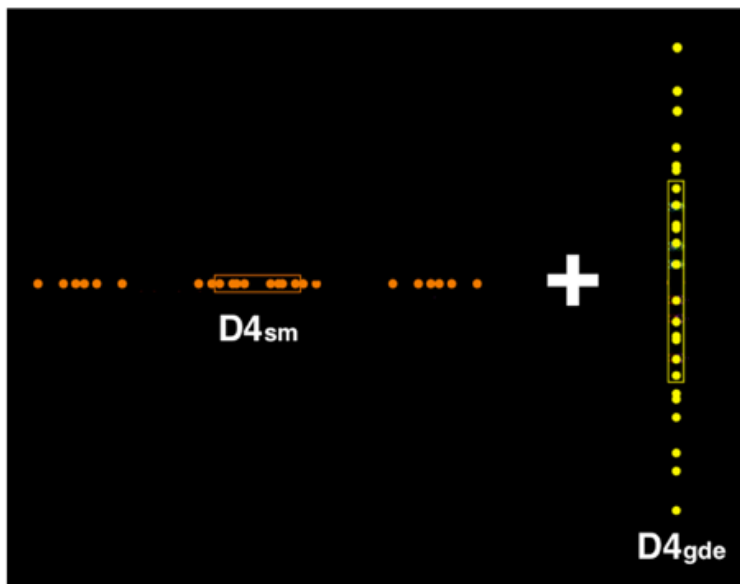

prior to dimensional reduction correspond to the non-1st-order part of the 2nd order classical Reed-Muller code (256, 37, 64) .

The 8 first generation fermion particles and 8 first generation fermion antiparticles of the 16-dim full spinor representation of the 256-dimensional $Cl(0,8)$ Clifford algebra

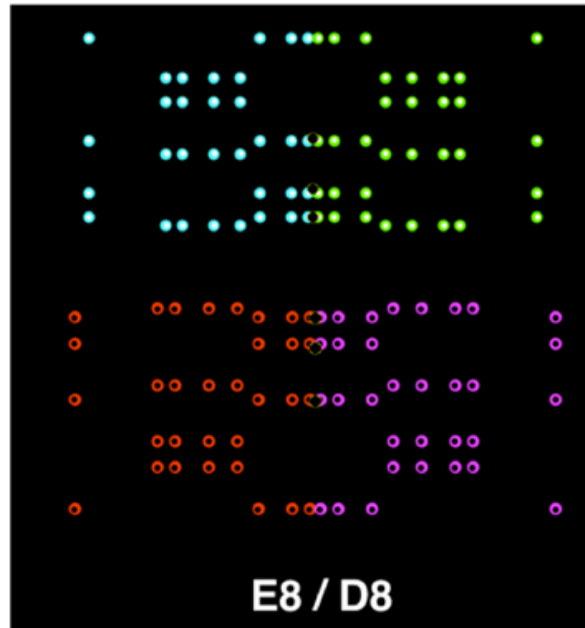

correspond to the distance of the classical Reed-Muller code (256, 93, 16), and to the 16-dimensional Barnes-Wall lattice Λ_{16} , which lattice comes from the (16,5,8) Reed-Muller code. Each Λ_{16} vertex has 4320 nearest neighbors.

The other 8 of the $16+8 = 24$ distance of the quantum Reed-Muller code $[[256, 0, 24]]$ corresponds to the 8-dimensional vector spacetime, and to the 8-dimensional E_8 lattice which comes from the (8,4,4) Hamming code, with weight distribution $0(1) 4(14) 8(1)$. It can also be constructed from the repetition code (8,1,1).

The dual of (8,1,1) is (8,7,2), a zero-sum even weight code, containing all binary vectors with an even number of 1s.

Each E_8 lattice vertex has 240 nearest neighbors. In Euclidean R_8 , there is only one way to arrange 240 spheres so that they all touch one sphere, and only one way to arrange 56 spheres so that they all touch a set of two spheres in contact with each other, and so forth, giving the following classical spherical codes:

(8,240,1/2), (7,56,1/3), (6,27,1/4), (5,16,1/5), (4,10,1/6), and (3,6,1/7).

(If you use an Octonion Integral Domain instead of Euclidean R_8 without multiplication then there are 7 algebraically independent ways to arrange the 240 spheres.)

The total 24 distance of the quantum Reed-Muller code $[[256, 0, 24]]$

corresponds to the 24-dimensional Leech lattice,

and to the classical extended Golay code (24, 12, 8)

in which lattice each vertex has 196,560 nearest neighbors. In Euclidean R_{24} , there is only one way to arrange 196,560 spheres so that they all touch one sphere, and only one way to arrange 4600 spheres so that they all touch a set of two spheres in contact with each other, and so forth, giving the following classical spherical codes: (24,196560,1/2), (23,4600,1/3), (22,891,1/4), (21,336,1/5), (20,170,1/6),

World-Line String Bohm Quantum Theory

A physically realistic Lattice Bosonic String Theory with Strings = World-Lines and
 Monster Group Symmetry
 containing gravity and the Standard Model
 can be constructed consistently with the E8 physics model
 248-dim E8 = 120-dim adjoint D8 + 128-dim half-spinor D8
 = (28 + 28 + 64) + (64 + 64)

In “Space-Time Code. III” Phys. Rev. D (1972) 2922-2931 David Finkelstein said
 “... According to relativity, the world is a collection of processes (events) with an
 unexpectedly unified causal or chronological structure. Then an object is secondary ...
 [to]... a long causal sequence of processes, **world line**. .. [if] we assemble these ... into
 chromosomelike code sequences ... and braid and cross-link these strands to make
 more complex objects and their interactions. ...[then]... The idea of the quantum jump
 comes into its own, and reigns supreme, even over space and time. ...”.

Andrew Gray in arXiv quant-ph/9712037 said:
 “... probabilities are ... assigned to entire fine-grained histories ...
 base[d] ... on the Feynman path integral formulation ...
 The formulation is fully relativistic and applicable to multi-particle systems.
 It ... makes the same experimental predictions as quantum field theory ...”.

Luis E. Ibanez and Angel M. Uranga in “String Theory and Particle Physics” said:
 “... String theory proposes ... small one-dimensional extended objects, strings,
 of typical size $L_s = 1/M_s$, with M_s known as the string scale ...
 As a string evolves in time, it sweeps out a two-dimensional surface in spacetime,
 known as the worldsheet, which is the analog of the ... worldline of a point particle ...
 for the bosonic string theory ... the classical string action is the total area spanned by
 the worldsheet ... This is the ... Nambu– Goto action ...”.

In my unconventional view

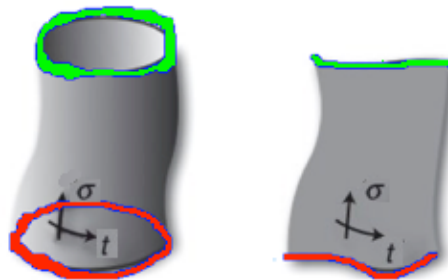

the red line and the green line are different strings/worldlines/histories and
**the world-sheet is the minimal surface connecting them,
 carrying the Bohm Potential,
 as Standard Model gauge bosons carry Force Potential between Point Particles.**

The t world-sheet coordinate is for Time of the string-world-line history.
 The sigma world-sheet coordinate is for Bohm Potential Gauge Boson at a given Time.
 (images adapted from “String Theory and Particle Physics” by Ibanez and Uranga)

Further, Ibanez and Uranga also said:

“... The string groundstate corresponds to a 26d spacetime tachyonic scalar field $T(x)$. This **tachyon** ... is ... unstable

...

The massless two-index tensor splits into irreducible representations of $SO(24)$... Its **trace** corresponds to a scalar field, the **dilaton** ϕ , whose vev fixes the string interaction coupling constant g_s

...

the **antisymmetric** part is the 26d 2-form field BMN

...

The **symmetric traceless** part is the 26d graviton GMN ...”.

Closed string **tachyons** localized at orbifolds of fermions produce virtual clouds of particles / antiparticles that dress fermions.

Dilatons are Goldstone bosons of spontaneously broken scale invariance that (analogous to Higgs) go from mediating a long-range scalar gravity-type force to the nonlocality of the Bohm-Sarfatti Quantum Potential.

The **antisymmetric** $SO(24)$ little group is related to the Monster automorphism group that is the symmetry of each cell of Planck-scale local lattice structure.

Joe Polchinski in “String Theory, Volume 1, An Introduction to the Bosonic String” said: “... we find at $m^2 = -4/\alpha'$ the tachyon, and at $m^2 = 0$ the 24×24 states of the graviton, dilaton, and antisymmetric tensor ...”.

Must the 24×24 symmetric matrices be interpreted as the graviton ? - !!! NO !!!

The 24×24 Real Symmetric Matrices form the Jordan Algebra $J(24, \mathbb{R})$.

Jordan algebras correspond to the matrix algebra of quantum mechanical states, that is, from a particle physics point of view, the configuration of particles in spacetime upon which the gauge groups act.

24-Real-dim space has a natural Octonionic structure of 3-Octonionic-dim space.

The corresponding Jordan Algebra is $J(3, \mathbb{O}) = 3 \times 3$ Hermitian Octonion matrices.

Their 26-dim traceless part $J(3, \mathbb{O})_0$ describes the 26-dim of Bosonic String Theory
and
the algebra of its Quantum States,
so that

the 24×24 traceless symmetric spin-2 particle is the Quantum Bohmion.

Joseph Polchinski, in his books String Theory vols. I and II(Cambridge 1998), says: "... the **closed ... unoriented ... bosonic string ... theory** has the maximal 26-dimensional Poincare invariance ... It is possible to have a consistent theory ...[with]... the **dilaton** ... the **[string-]graviton** ...[and]... the **tachyon** ...[whose]... negative mass-squared means that the no-string 'vacuum' is actually unstable ... "

The **dilaton** of E8 Physics sets the Planck scale as the scale for the 16 dimensions that are orbifolded fermion particles and anti-particles and the 4 dimensions of the CP2 Internal Symmetry Space of M4xCP2 spacetime. The remaining $26-16-4 = 6$ dimensions are the Conformal Physical Spacetime with $\text{Spin}(2,4) = \text{SU}(2,2)$ symmetry that produces M4 Physical Spacetime

E8 Physics 26D String Theory Spacetime
10D = 6D Conformal Spacetime + 4D Compact CP2 Internal Symmetry Space
with CP2 = SU(3) / SU(2)xU(1) as unique Compactification
which specifies Gauge Groups of the Standard Model.

If Strings = World Lines and World Lines are past and future histories of particles, then **spin-2 string entities carry Bohm Quantum Potential** with Sarfatti Back-Reaction related to Cramer Transaction Quantum Theory.

Roger Penrose in "Road to Reality" (Knopf 2004) says: "... **quantum** mechanics ... alternates between ... **unitary** evolution **U** ... and state reduction **R** ... quantum state **reduction** ... is ... **objective** ... **OR** ... it is always a gravitational phenomenon ... [A] conscious event ... would be ... orchestrated **OR** ... of ... large-scale quantum coherence ... of ... microtubules ...".

String-Gravity produces Sarfatti-Bohm Quantum Potential with Back-Reaction.

It is distinct from the MacDowell-Mansouri Gravity of stars and planets.

The **tachyon** produces the instability of a truly empty vacuum state with no strings. It is natural, because if our Universe were ever to be in a state with no strings, then tachyons would create strings = World Lines thus filling our Universe with the particles and World-Lines = strings that we see. Something like this is necessary for particle creation in the Inflationary Era of non-unitary Octonionic processes.

Our construction of a 26D String Theory consistent with E8 Physics uses a structure that is not well-known, so I will mention it here before we start:

There are 7 independent E8 lattices, each corresponding to one of the 7 imaginary octonions denoted by $iE8$, $jE8$, $kE8$, $EE8$, $IE8$, $JE8$, and $KE8$ and related to both D8 adjoint and half-spinor parts of E8 and with 240 first-shell vertices. An 8th E8 lattice $1E8$ with 240 first-shell vertices related to the D8 adjoint part of E8 is related to the 7 octonion imaginary lattices (viXra 1301.0150v2) .

It can act as an effectively independent lattice as part of the basis subsets $\{1E8, EE8\}$ or $\{1E8, iE8, jE8, kE8\}$.

With that in mind, here is the construction:

Step 1:

Consider the 26 Dimensions of Bosonic String Theory as the 26-dimensional traceless part $J_3(O)$

$$\begin{array}{ccc} a & O_+ & O_v \\ O_+^* & b & O_- \\ O_v^* & O_-^* & -a-b \end{array}$$

(where O_v , O_+ , and O_- are in Octonion space with basis $\{1, i, j, k, E, I, J, K\}$ and a and b are real numbers with basis $\{1\}$) of the 27-dimensional Jordan algebra $J_3(O)$ of 3×3 Hermitian Octonion matrices.

Step 2:

Take a D3 brane to correspond to the Imaginary Quaternionic associative subspace spanned by $\{i, j, k\}$ in the 8-dimensional Octonionic O_v space.

Step 3:

Compactify the 4-dimensional co-associative subspace spanned by $\{E, I, J, K\}$ in the Octonionic O_v space as a $CP^2 = SU(3)/U(2)$, with its 4 world-brane scalars corresponding to the 4 covariant components of a Higgs scalar. Add this subspace to D3, to get D7.

Step 4:

Orbifold the 1-dimensional Real subspace spanned by $\{1\}$ in the Octonionic O_v space by the discrete multiplicative group $Z_2 = \{-1, +1\}$, with its fixed points $\{-1, +1\}$ corresponding to past and future time. This discretizes time steps and gets rid of the world-brane scalar corresponding to the subspace spanned by $\{1\}$ in O_v . It also gives our brane a 2-level timelike structure, so that its past can connect to the future of a preceding brane and its future can connect to the past of a succeeding brane.

Add this subspace to D7, to get D8.

D8, our basic Brane, looks like two layers (past and future) of D7s.

Beyond D8 our String Theory has $26 - 8 = 18$ dimensions, of which $25 - 8$ have corresponding world-brane scalars:

- 8 world-brane scalars for Octonionic O_+ space;
- 8 world-brane scalars for Octonionic O_- space;
- 1 world-brane scalars for real a space; and
- 1 dimension, for real b space, in which the D8 branes containing spacelike D3s are stacked in timelike order.

Step 5:

To get rid of the world-brane scalars corresponding to the Octonionic O_+ space, orbifold it by the 16-element discrete multiplicative group

$$\text{Oct16} = \{+/-1, +/-i, +/-j, +/-k, +/-E, +/-I, +/-J, +/-K\}$$

to reduce O_+ to 16 singular points $\{-1, -i, -j, -k, -E, -I, -J, -K, +1, +i, +j, +k, +E, +I, +J, +K\}$.

Let the 8 O_+ singular points $\{-1, -i, -j, -k, -E, -I, -J, -K\}$ correspond to the fundamental fermion particles
{neutrino, red up quark, green up quark, blue up quark,
electron, red down quark, green down quark, blue down quark}
located on the past D7 layer of D8.

Let the 8 O_+ singular points $\{+1, +i, +j, +k, +E, +I, +J, +K\}$ correspond to the fundamental fermion particles
{neutrino, red up quark, green up quark, blue up quark,
electron, red down quark, green down quark, blue down quark}
located on the future D7 layer of D8.

The 8 components of the 8 fundamental first-generation fermion particles = $8 \times 8 = 64$ correspond to the 64 of the 128-dim half-spinor D8 part of E8.

This gets rid of the 8 world-brane scalars corresponding to O_+ , and leaves:

8 world-brane scalars for Octonionic O_- space;

1 world-brane scalars for real a space; and

1 dimension, for real b space, in which the D8 branes containing spacelike D3s are stacked in timelike order.

Step 6:

To get rid of the world-brane scalars corresponding to the Octonionic O_- space, orbifold it by the 16-element discrete multiplicative group

$$\text{Oct16} = \{+/-1, +/-i, +/-j, +/-k, +/-E, +/-I, +/-J, +/-K\}$$

to reduce O_- to 16 singular points $\{-1, -i, -j, -k, -E, -I, -J, -K, +1, +i, +j, +k, +E, +I, +J, +K\}$.

Let the 8 O_- singular points $\{-1, -i, -j, -k, -E, -I, -J, -K\}$ correspond to the fundamental fermion anti-particles {anti-neutrino, red up anti-quark, green up anti-quark, blue up anti-quark, positron, red down anti-quark, green down anti-quark, blue down anti-quark}
located on the past D7 layer of D8.

Let the 8 O_- singular points $\{+1, +i, +j, +k, +E, +I, +J, +K\}$ correspond to the fundamental fermion anti-particles {anti-neutrino, red up anti-quark, green up anti-quark, blue up anti-quark, positron, red down anti-quark, green down anti-quark, blue down anti-quark}
located on the future D7 layer of D8.

The 8 components of 8 fundamental first-generation fermion anti-particles = $8 \times 8 = 64$ correspond to the 64 of the 128-dim half-spinor D8 part of E8.

This gets rid of the 8 world-brane scalars corresponding to O_- , and leaves:

1 world-brane scalars for real a space; and

1 dimension, for real b space, in which the D8 branes containing spacelike D3s are stacked in timelike order.

Step 7:

Let the 1 world-brane scalar for real a space correspond to a Bohm-type Quantum Potential acting on strings in the stack of D8 branes.

Interpret strings as world-lines in the Many-Worlds, short strings representing virtual particles and loops.

Step 8:

Fundamentally, physics is described on HyperDiamond Lattice structures.

There are 7 independent E8 lattices, each corresponding to one of the 7 imaginary octonions. denoted by $iE8$, $jE8$, $kE8$, $EE8$, $IE8$, $JE8$, and $KE8$ and related to both D8 adjoint and half-spinor parts of E8 and with 240 first-shell vertices.

An 8th 8-dim lattice $1E8$ with 240 first-shell vertices related to

the E8 adjoint part of E8 is related to the 7 octonion imaginary lattices.

Give each D8 brane structure based on Planck-scale E8 lattices so that

each D8 brane is a superposition/intersection/coincidence of the eight E8 lattices.

(see viXra 1301.0150)

Step 9:

Since Polchinski says "... If r D-branes coincide ... there are r^2 vectors, forming the adjoint of a $U(r)$ gauge group ...", make the following assignments:

a gauge boson emanating from D8 from its $1E8$ and $EE8$ lattices is

a $U(2)$ ElectroWeak boson thus accounting for the photon and $W+$, $W-$ and $Z0$ bosons.

a gauge boson emanating from D8 from its $IE8$, $JE8$, and $KE8$ lattices is

a $U(3)$ Color Gluon boson thus accounting for the 8 Color Force Gluon bosons.

The $4+8 = 12$ bosons of the Standard Model Electroweak and Color forces correspond to 12 of the 28 dimensions of 28-dim $Spin(8)$

that corresponds to one of the 28 of the 120-dim adjoint D8 parts of E8.

a gauge boson emanating from D8 from its $1E8$, $iE8$, $jE8$, and $kE8$ lattices is

a $U(2,2)$ boson for conformal $U(2,2) = Spin(2,4) \times U(1)$ MacDowell-Mansouri gravity plus conformal structures consistent with the Higgs mechanism and with observed Dark Energy, Dark Matter, and Ordinary matter.

The 16-dim $U(2,2)$ is a subgroup of 28-dim $Spin(2,6)$

that corresponds to the other 28 of the 120-dim adjoint D8 part of E8.

Step 10:
Since Polchinski says

"... there will also be r^2 massless scalars from the components normal to the D-brane. ... the collective coordinates ... X^u ... for the embedding of n D-branes in spacetime are now enlarged to $n \times n$ matrices.

This 'noncommutative geometry' ...[may be]... an important hint about the nature of spacetime. ...",

make the following assignment:

The 8×8 matrices for the collective coordinates linking a D8 brane to the next D8 brane in the stack are needed to connect the eight E8 lattices of the D8 brane to the eight E8 lattices of the next D8 brane in the stack.

The $8 \times 8 = 64$ correspond to the 64 of the 120 adjoint D8 part of E8.

We have now accounted for all the scalars
and
have shown that the model has the physics content of the realistic E8 Physics model with Lagrangian structure based on $E8 = (28 + 28 + 64) + (64 + 64)$
and
AQFT structure based on $Cl(1,25)$ with real Clifford Algebra periodicity and generalized Hyperfinite II1 von Neumann factor algebra.

26D String Theory structure can also be formulated directly in the Root Vector picture using redundancy in the E8 description of Quantum States:

Fermion components carry 8-dim Spacetime information

so $E8 / D8 = 8 \times 8 + 8 \times 8$ can be reduced to 8+8

Spacetime position and momentum are redundant

so $D8 / D4 \times D4 = 8 \times 8$ can be reduced to 8

Gauge Bosons and Ghosts are redundant

so $D4 \times D4 = 28+28$ can be reduced to $28 = 16$ for Gravity + 12 for Standard Model

Elimination of Redundancy gives $8+8 + 8 + 28 = 52$ -dim F4 with 48 Root Vectors forming a 24-cell plus its dual

52-dim F4 has 26-dim smallest non-trivial representation

which has structure of

$J(3,O)_o =$ traceless part of 27-dim exceptional Jordan Algebra $J(3,O)$

and is

the minimal structure containing the basic information of E8 Physics.

so

E8 Physics Quantum Theory can be formulated in terms of 26-dim $J(3,O)_o$.

The $Cl(1,25)$ E8 AQFT inherits structure from the $Cl(1,25)$ E8 Local Lagrangian

$$\int_{8\text{-dim SpaceTime}} \text{Gauge Gravity} + \text{Standard Model} + \text{Fermion Particle-AntiParticle}$$

whereby World-Lines of Particles are represented by Strings moving in a space whose dimensionality includes $8v = 8$ -dim SpaceTime Dimensions + $8s+ = 8$ Fermion Particle Types + $8s- = 8$ Fermion AntiParticle Types combined in the traceless part $J(3,O)_o$ of the 3×3 Octonion Hermitian Jordan Algebra

a	$8s+$	$8v$
$8s+^*$	b	$8s-$
$8v^*$	$8s-^*$	-a-b

which has total dimension $8v + 8s+ + 8s- + 2 = 26$ and is the space of a 26D String Theory with Strings seen as World-Lines.

$24 = 8v + 8s+ + 8s-$ of the 26 dimensions of 26D String Theory correspond to $24 \times 8 = 192$ of the 240 E8 Root Vectors by representing the $8v + 8s+ + 8s-$ as superpositions of their respective 8 components

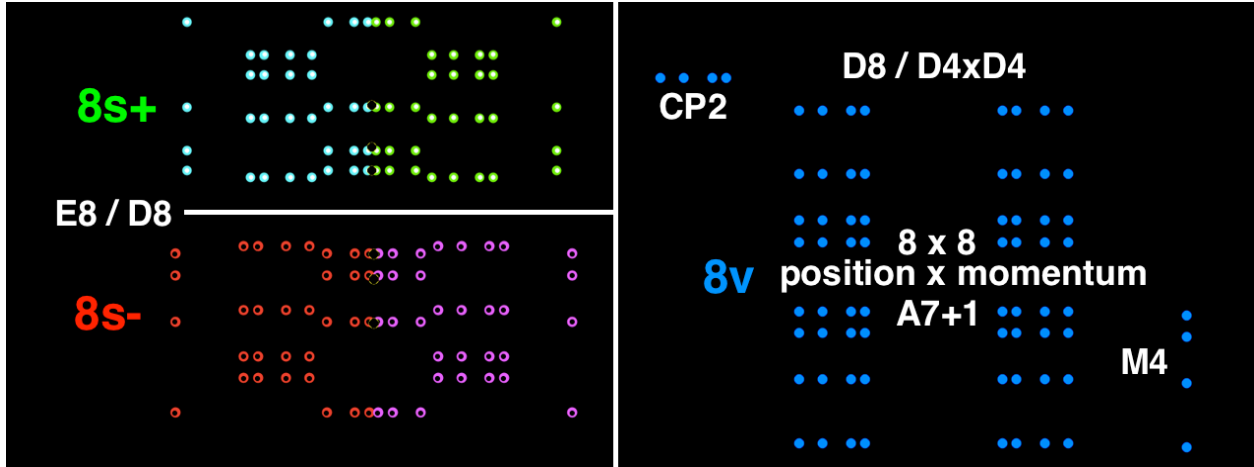

8v SpaceTime is represented by D8 branes. A D8 brane has Planck-Scale Lattice Structure superpositions of 8 types of E8 Lattice denoted by 1E8, iE8, jE8, kE8, EE8, IE8, JE8, KE8

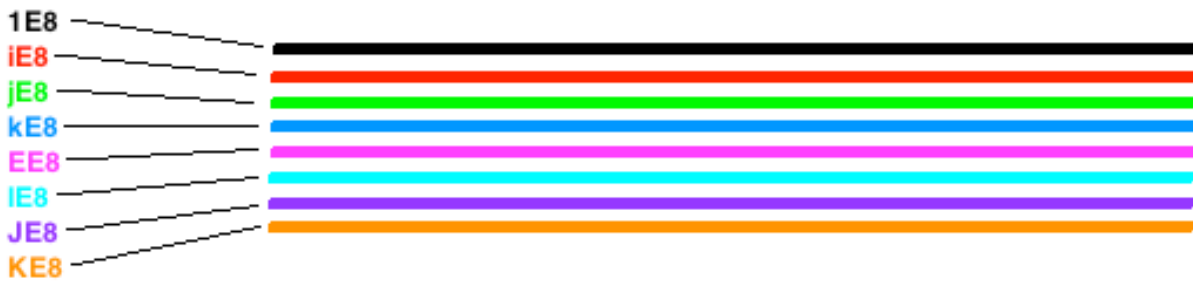

A single Snapshot of SpaceTime is represented by a D8 brane at each point of which is placed Fermion Particles or AntiParticles represented by 8+8 = 16 orbifolded dimensions of the 26 dimensions of 26D String Theory.

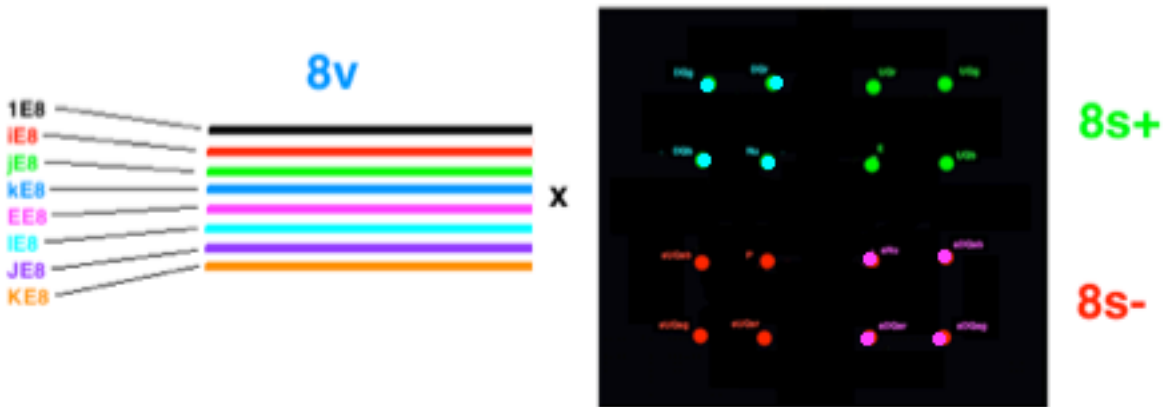

It is necessary to patch together SpaceTime Snapshots to form a Global Structure describing a Many-Worlds Global Algebraic Quantum Field Theory (AQFT) whose structure is described by Deutsch in "The Fabric of Reality" (Penguin 1997 pp. 276-283): "... there is no fundamental demarcation between snapshots of other times and snapshots of other universes ... Other times are just special cases of other universes ... Suppose ... we toss a coin ... Each point in the diagram represents one snapshot ... in the multiverse there are far too many snapshots for clock readings alone to locate a snapshot relative to the others. To do that, we need to consider the intricate detail of which snapshots determine which others. ...

in some regions of the multiverse, and in some places in space, the snapshots of some physical objects do fall, for a period, into chains, each of whose members determines all the others to a good approximation ...".

The Many-Worlds Snapshots are structured as a 26-dim Lorentz Leech Lattice of 26D String Theory parameterized by the a and b of $J(3,0)_0$ as indicated in this 64-element subset of Snapshots

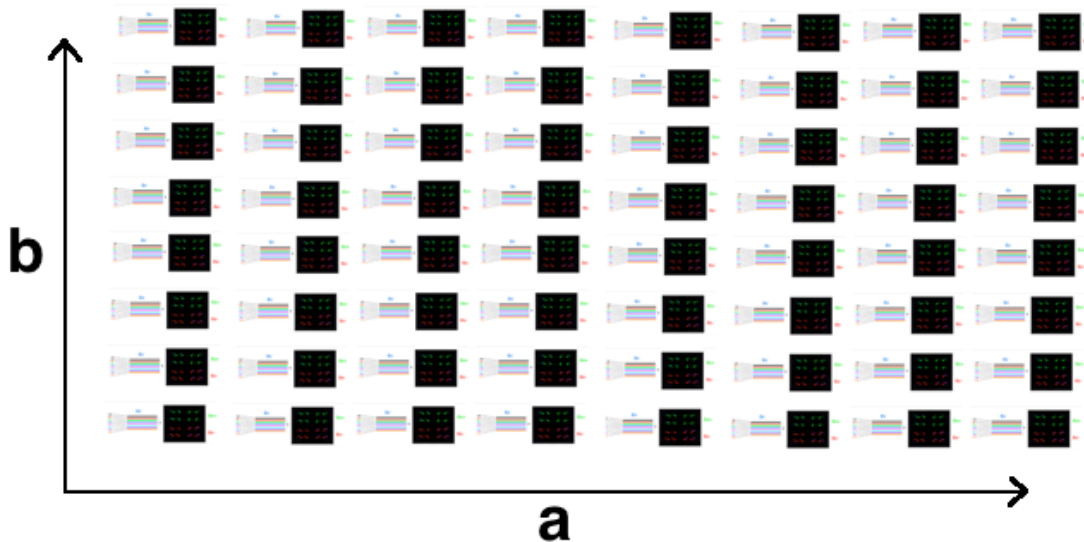

The $240 - 192 = 48 = 24+24$ Root Vector Vertices of E_8 that do not represent the 8-dim D8 brane or the $8+8 = 16$ dim of Orbifolds for Fermions do represent the **Gauge Bosons (and their Ghosts) of E_8 Physics**:

Gauge Bosons from $1E_8, iE_8, jE_8,$ and kE_8 parts of a D8 give **$U(2,2)$ Conformal Gravity**

Gauge Bosons from EE_8 part of a D8 give **$U(2)$ Electroweak Force**

Gauge Bosons from $IE_8, JE_8,$ and KE_8 parts of a D8 give **$SU(3)$ Color Force**



Each Deutsch chain of determination represents a World-Line of Particles / AntiParticles corresponding to a String of 26D String Theory such as the red line in this 64-element subset of Snapshots



26D String Theory is the Theory of Interactions of Strings = World-Lines.

Interactions of World-Lines can describe Quantum Theory

according to Andrew Gray (arXiv quant-ph/9712037): "... probabilities are ... assigned to entire fine-grained histories ... base[d] ... on the Feynman path integral formulation ...

The formulation is fully relativistic and applicable to multi-particle systems.

It ... makes the same experimental predictions as quantum field theory ...".

Green, Schwarz, and Witten say in their book "Superstring Theory" vol. 1 (Cambridge 1986)

"... For the ... closed ... bosonic string [**26D String Theory**] The first excited level ... consists of ... the ground state ... tachyon ... and ... a scalar ... 'dilaton' ... and ...

SO(24) ... little group of a ...[26-dim]... massless particle ... and ...

a ... massless ... spin two state ...".

Closed string tachyons localized at orbifolds of fermions produce virtual clouds of particles / antiparticles that dress fermions.

Dilatons are Goldstone bosons of spontaneously broken scale invariance that (analogous to Higgs) go from mediating a long-range scalar gravity-type force to the nonlocality of the Bohm-Sarfatti Quantum Potential.

The SO(24) little group is related to the Monster automorphism group that is the symmetry of each cell of Planck-scale local lattice structure.

The massless spin 2 state = Bohmion = Carrier of the Bohm Force of the Bohm Quantum Potential.

Roderick Sutherland (arXiv 1509.02442) gave a Lagrangian for the Bohm Potential saying: "... This paper focuses on interpretations of QM in which the underlying reality is taken to consist of particles have definite trajectories at all times ... An example ... is the Bohm model ... This paper ... provid[es]... a Lagrangian ...[for]... the unfolding events describing more than one particle while maintaining a relativistic description requires the introduction of final boundary conditions as well as initial, thereby entailing retrocausality ...

In addition ... the Lagrangian approach pursued here to describe particle trajectories also entails the natural inclusion of an accompanying field to influence the particle's motion away from classical mechanics and reproduce the correct quantum predictions. In so doing, it is ... providing a physical explanation for why quantum phenomena exist at all ... the particle is seen to be

the source of a field which alters the particle's trajectory via self-interaction ...

The Dirac case ... each particle in an entangled many-particle state will be described by an individual Lagrangian density ... of the form:

$$\mathcal{L} = \text{Re} \left[\frac{1}{\langle f|i \rangle} \left(-i\bar{\Psi}_f \gamma^\alpha \partial_\alpha \Psi_i + m\bar{\Psi}_f \Psi_i \right) \right] \mp \sigma_0 \rho_0 \left| \mathbf{u}_\alpha \mathbf{u}^\alpha \right|^{\frac{1}{2}} + \sigma_0 \mathbf{u}_\alpha \mathbf{j}^\alpha$$

... the ...[first]... term ...[is]... the ... Lagrangian densities for the PSI field alone ...

... sigma_o is the rest density distribution of the particle through space ... j is the current density ...

... rho_o and u are the rest density and 4-velocity of the probability flow ...".

Jack Sarfatti extended the Sutherland Lagrangian to include Back-Reaction entanglement.

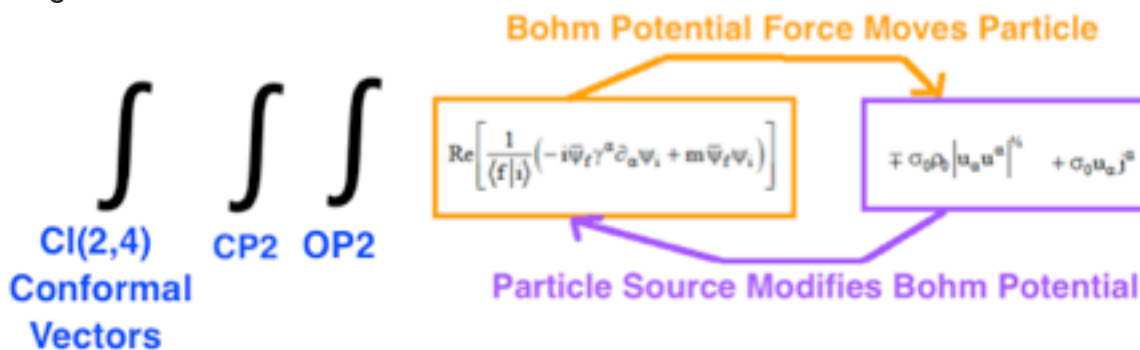

where a, b and VM4 form CI(2,4) vectors and VCP2 forms CP2 and S+ and S- form OP2 so that

26D = 16D orbifolded fermions + 10D and 10D = 6D Conformal Space + 4D CP2 ISS (ISS = Internal Symmetry Space and 6D Conformal contains 4D M4 of Kaluza-Klein M4xCP2)

saying (linkedin.com Pulse 13 January 2016): "... the reason entanglement cannot be used as a direct messaging channel between subsystems of an entangled complex quantum system, is the lack of direct back-reaction of the classical particles and classical local gauge fields on their shared entangled Bohmian quantum information pilot wave ... Roderick. I. Sutherland ... using Lagrangian field theory, shows how to make the original 1952 Bohm pilot-wave theory completely relativistic,

and how to avoid the need for configuration space for many-particle entanglement. The trick is that final boundary conditions on the action as well as initial boundary conditions influence what happens in the present. The general theory is "post-quantum" ... and it is non-statistical ... There is complete two-way action-reaction between quantum pilot waves and the classical particles and classical local gauge fields ... orthodox statistical quantum theory, with no-signaling ...[is derived]... in two steps, first arbitrarily set the back-reaction (of particles and classical gauge field on their pilot waves) to zero. This is analogous to setting the curvature equal to zero in general relativity, or more precisely in setting G to zero. Second, integrate out the final boundary information, thereby adding the statistical Born rule to the mix. ... the mathematical condition for zero post-quantum back-reaction of particles and classical fields (aka "beables" J.S. Bell's term) is exactly de Broglie's guidance constraint. That is, in the simplest case, the classical particle velocity is proportional to the gradient of the phase of the quantum pilot wave. It is for this reason, that the independent existence of the classical beables can be ignored in most quantum calculations. However, orthodox quantum theory assumes that the quantum system is thermodynamically closed between strong von Neumann projection measurements that obey the Born probability rule. The new post-quantum theory in the equations of Sutherland, prior to taking the limit of orthodox quantum theory, should apply to pumped open dissipative structures. Living matter is the prime example. This is a clue that should not be ignored. ...".

Jack Sarfatti (email 31 January 2016) said: "... Sabine [Hossenfelder]'s argument ... "... two types of fundamental laws ... appear in contemporary theories. One type is deterministic, which means that the past entirely predicts the future. There is no free will in such a fundamental law because there is no freedom. The other type of law we know appears in quantum mechanics and has an indeterministic component which is random. This randomness cannot be influenced by anything, and in particular it cannot be influenced by you, whatever you think "you" are. There is no free will in such a fundamental law because there is no "will" - there is just some randomness sprinkled over the determinism. In neither case do you have free will in any meaningful way." ... However ...[There is a Third Way]... post-quantum theory with action-reaction between quantum information pilot wave and its be-able is compatible with free will. ...".

In "Space-Time Code. III" Phys. Rev. D (1972) 2922-2931 David Finkelstein said
 "... The primitive quantum processes or chronons of which world lines are made
 can be thought of as acts of emission or creation,
 Their duals, antichronons, represent acts of absorption or annihilation. ...".

**The Creation-Annihilation Operator structure of the Bohm Quantum Potential of
 26D String Theory** is given by the

Maximal Contraction of E8 = semidirect product A7 x h92
 where h92 = 92+1+92 = 185-dim Heisenberg algebra and A7 = 63-dim SL(8)

The Maximal E8 Contraction A7 x h92 can be written as a 5-Graded Lie Algebra

$$28 + 64 + (SL(8,R) + 1) + 64 + 28$$

$$\text{Central Even Grade } 0 = SL(8,R) + 1$$

The 1 is a scalar and SL(8,R) = Spin(8) + Traceless Symmetric 8x8 Matrices,
 so SL(8,R) represents a local 8-dim SpaceTime in Polar Coordinates.

$$\text{Odd Grades } -1 \text{ and } +1 = 64 + 64$$

Each = 64 = 8x8 = Creation/Annihilation Operators for 8 components of 8 Fundamental Fermions.

$$\text{Even Grades } -2 \text{ and } +2 = 28 + 28$$

Each = Creation/Annihilation Operators for 28 Gauge Bosons of Gravity + Standard Model.

The 8x8 matrices linking one D8 to the next D8 of a World-Line String
 give A7xR = U(8)

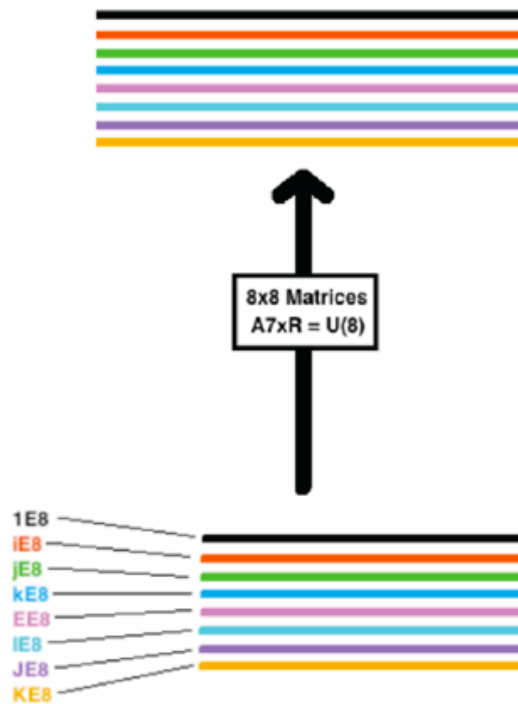

The Algebraic Quantum Field Theory (AQFT) structure of the Bohm Quantum Potential of 26D String Theory is given by the Cl(1,25) E8 Local Lagrangian

$$\int_{8\text{-dim SpaceTime}} \text{Gauge Gravity} + \text{Standard Model} + \text{Fermion Particle-AntiParticle}$$

and by 8-Periodicity of Real Clifford Algebras,
as the Completion of the Union of all Tensor Products of the form

$$\text{Cl}(1,25) \times \dots (\text{N times tensor product}) \dots \times \text{Cl}(1,25)$$

For $N = 2^8 = 256$ the copies of Cl(1,25) are on the 256 vertices of the 8-dim HyperCube



For $N = 2^{16} = 65,536 = 4^8$ the copies of Cl(1,25) fill in the 8-dim HyperCube as described by William Gilbert’s web page: “... The n-bit reflected binary Gray code will describe a path on the edges of an n-dimensional cube that can be used as the initial stage of a Hilbert curve that will fill an n-dimensional cube. ...”.

The vertices of the Hilbert curve are at the centers of the 2^8 sub-8-HyperCubes whose edge lengths are 1/2 of the edge lengths of the original 8-dim HyperCube

As N grows, the copies of Cl(1,25) continue to fill the 8-dim HyperCube of E8 SpaceTime

using higher Hilbert curve stages from the 8-bit reflected binary Gray code subdividing the initial 8-dim HyperCube into more and more sub-HyperCubes.

If edges of sub-HyperCubes, equal to the distance between adjacent copies of Cl(1,25), remain constantly at the Planck Length, then the

full 8-dim HyperCube of our Universe expands as N grows to 2^{16} and beyond similarly to the way shown by this 3-HyperCube example for $N = 2^3, 4^3, 8^3$ from Wiliam Gilbert’s web page:

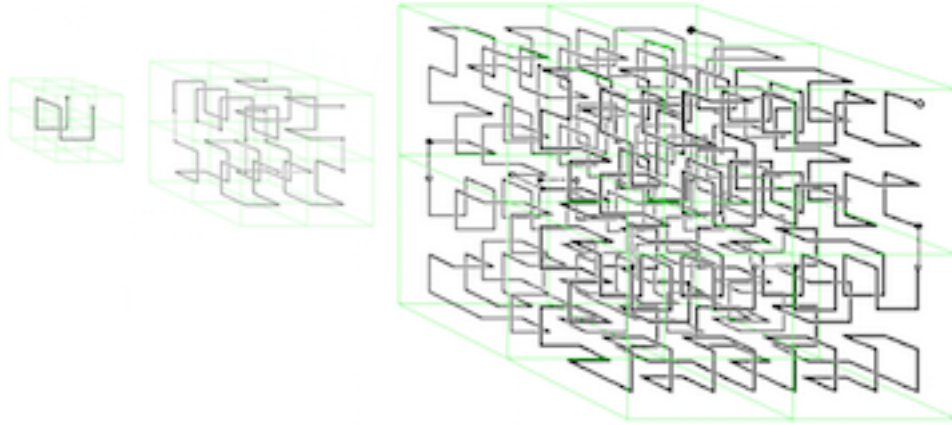

The Union of all $Cl(1,25)$ tensor products is
 the Union of all subdivided 8-HyperCubes
 and
 their Completion is a huge superposition of 8-HyperCube Continuous Volumes
 which Completion belongs to the Third Grothendieck Universe.

26D String Theory Structure is

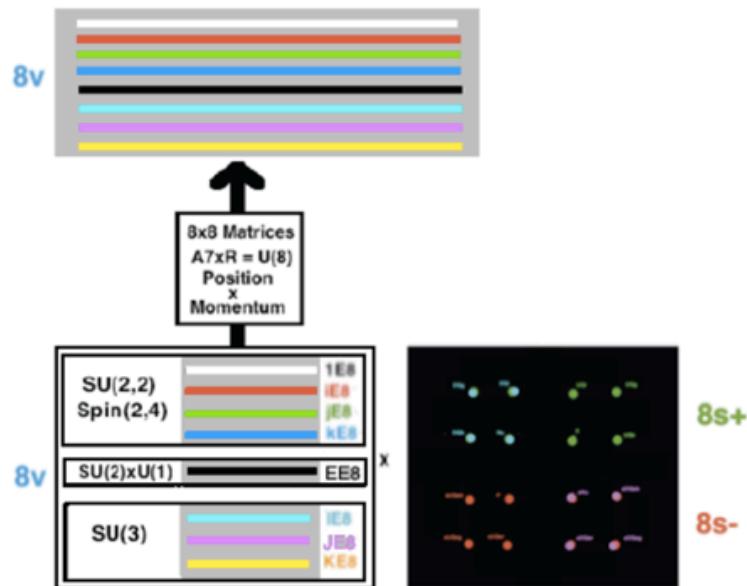

Green, Schwartz, and Witten, in "Superstring Theory" vol. 1, describe 26D String Theory saying "... The first excited level ... consists of ...

the ground state ... **tachyon** ...

and ... a scalar ... **'dilaton'** ...

and ... **SO(24)** ... **little group of a ...[26-dim]... massless particle** ...

and ... a ... **massless ... spin two state** ...".

Tachyons localized at orbifolds of fermions produce virtual clouds of particles / antiparticles that dress fermions by filling their Schwinger Source regions.

Dilatons are Goldstone bosons of spontaneously broken scale invariance that (analogous to Higgs) go from mediating a long-range scalar gravity-type force to the nonlocality of the Bohm-Sarfatti Quantum Potential.

The SO(24) little group is related to the Monster automorphism group that is the symmetry of each cell of Planck-scale local lattice structure.

The massless spin 2 state = Bohmion = Carrier of the Bohm Force of the Bohm Quantum Potential.

Similarity of the spin 2 Bohmion to the spin 2 Graviton accounts for the Bohmion's ability to support Penrose Consciousness with Superposition Separation Energy Difference $G m^2 / a$

where, for a Human Brain, m = mass of electron and a = 1 nanometer in Tubulin Dimer

"... Bohm's Quantum Potential can be viewed as an internal energy of a quantum system ..."

according to Dennis, de Gosson, and Hiley (arXiv 1412.5133)

and

Bohm Quantum Potential inherits Sarfatti Back-Reaction from its spin-2 structure similar to General Relativity

Peter R. Holland says in "The Quantum Theory of Motion" (Cambridge 1993):

"... the total force ... from the quantum potential ... does not ... fall off with distance ... because ... the quantum potential ... depends on the form of ...[the quantum state]... rather than ... its ... magnitude ...".

Penrose-Hameroff-type Quantum Consciousness is due to Resonant Quantum Potential Connections among Quantum State Forms.

The Quantum State Form of a Conscious Brain is determined by the configuration of a subset of its 10^{18} to 10^{19} Tubulin Dimers described by a large Real Clifford Algebra.

Paola Zizzi in gr-qc/0007006 describes the Octonionic Inflation Era of Our Universe as a Quantum Consciousness Superposition of States ending with Self-Decoherence after 64 doublings of Octonionic Inflation, at which time Our Universe is

"... a superposed state of quantum ... [qubits].

the self-reduction of the superposed quantum state is ... reached at the end of inflation ...[at]... the decoherence time ... [Tdecoh = 10^9 Tplanck = $10^{(-34)}$ sec] ... and corresponds to a superposed state of ... [$10^{19} = 2^{64}$ qubits]. ...".

64 doublings to 2^{64} qubits corresponds to the Clifford algebra

$$Cl(64) = Cl(8 \times 8) = Cl(8) \times Cl(8) \times Cl(8) \times Cl(8) \times Cl(8) \times Cl(8) \times Cl(8) \times Cl(8)$$

By the periodicity-8 theorem of Real Clifford algebras, Cl(64) is the smallest Real Clifford algebra for which we can reflexively identify each component Cl(8) with a basis vector in the Cl(8) vector space.

This reflexive identification causes our universe to decohere at $N = 2^{64} = 10^{19}$. Octonionic Quantum Processes are Not Unitary and so can produce Fermions.

(see Stephen Adler's book "Quaternionic Quantum Mechanics ..." at pages 50-52 and 561).

At the end of 64 Unfoldings, Non-Unitary Octonionic Inflation ended having produced about $(1/2) 16^{64} = (1/2) (2^4)^{64} = 2^{255} = 6 \times 10^{76}$ Fermions. At the End of Inflation Our Universe had Temperature / Energy $10^{27} \text{ K} = 10^{14} \text{ GeV}$ so each of the 10^{77} Fermions had energy of 10^{14} GeV and collisions among them would for each of the 10^{77} Fermions produce jets containing about 10^{12} particles of energy 100 GeV or so so that the total number created by Inflation was about 10^{89} .

The End of Inflation time was at about $10^{(-34)} \text{ sec} = 2^{64} \text{ Tplanck}$ and the size of our Universe was then about $10^{(-24)} \text{ cm}$ which is about the size of a Fermion Schwinger Source Kerr-Newman Cloud. The 2^{64} qubits created by Inflation is roughly 10^{19} which is roughly the number of Quantum Consciousness Tubulins in the Human Brain. Therefore

the Human Brain Quantum Consciousness has evolved in Our Universe to be roughly equivalent to the Maximum Consciousness of Our Inflationary Era Universe.

Further, each cell of E8 Lagrangian Spacetime corresponds to 65,536-dim $Cl(16)$ which contains 248-dim $E_8 = 120$ -dim D_8 bivectors + 128-dim D_8 half-spinors Human Brain Microtubules 40 microns long have 65,536 Tubulin Dimers

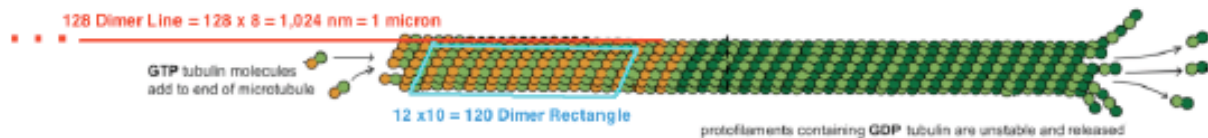

(image adapted from 12biophys.blogspot.com Lecture 11)

and so can have Bohm Quantum Resonance with $Cl(16)$ Spacetime cells so that **at any and all Times the State of Consciousness of a Human is in exact resonant correspondence with a subset of the cells of E8 Classical Lagrangian Spacetime**

Therefore **E8 Lagrangian Spacetime (as a Nambu-Jona-Lasinio Condensate) is effectively the Spirit World in which the Human States of Consciousness = Souls exist.**

After the death of the Human Physical Body the Spirit World interactions with its Soul are no longer constrained by Physical World interactions with its Body so that the Spirit World can harmonize the individual Soul with the collective Universal Soul.

A Single Cell of E8 26-dimensional Bosonic String Theory,
in which Strings are physically interpreted as World-Lines,
can be described by taking the quotient of its 24-dimensional O+, O-, Ov
subspace modulo the 24-dimensional Leech lattice.
Its automorphism group is the largest finite sporadic group, the Monster Group,
whose order is
8080, 17424, 79451, 28758, 86459, 90496, 17107, 57005, 75436, 80000, 00000
=
2⁴⁶ .3²⁰ .5⁹ .7⁶ .11² .13³ .17.19.23.29.31.41.47.59.71
or about 8 x 10⁵³.

A Leech lattice construction is described by Robert A. Wilson in his 2009 paper "Octonions and the Leech lattice":

"... The (real) octonion algebra is an 8-dimensional (non-division) algebra with an orthonormal basis { 1=i00 , i0 , i1 , i2 , i3 , i4 , i5 , i6 } labeled by the projective line PL(7) = { oo } u F7

...

The E8 root system embeds in this algebra ... take the 240 roots to be ...
112 octonions ... +/- it +/- iu for any distinct t,u

... and ...

128 octonions (1/2)(+/- 1 +/- i0 +/- ... +/- i6) which have an odd number of minus signs.

Denote by L the lattice spanned by these 240 octonions

...

Let s = (1/2)(- 1 + i0 + ... + i6) so s is in L ... write R for Lbar ...

...

(1/2) (1 + i0) L = (1/2) R (1 + i0) is closed under multiplication ... Denote this ...by A
 ... Writing B = (1/2) (1 + i0) A (1 + i0) ...from ... Moufang laws ... we have
 L R = 2 B , and ... B L = L and R B = R ...[also]... 2 B = L sbar

...

the roots of B are

[16 octonions]... +/- it for t in PL(7)

... together with

[112 octonions]... (1/2) (+/- 1 +/- it +/- i(t+1) +/- i(t+3)) ...for t in F7

... and ...

[112 octonions]... (1/2) (+/- i(t+2) +/- i(t+4) +/- i(t+5) +/- i(t+6)) ...for t in F7

...

the octonionic Leech lattice ... contains the following 196560 vectors of norm 4 ,
 where M is a root of L and j,k are in J = { +/- it | t in PL(7) },
 and all permutations of the three coordinates are allowed:

(2 M, 0 , 0)

Number: 3x240 = 720

(M sbar, +/- (M sbar) j , 0)

Number: 3x240 x 16 = 11520

((M s) j , +/- M k , +/- (M j) k)

Number: 3x240 x 16 x 16 = 184320

...

The key to the simple proofs above is the observation that $LR = 2B$ and $BL = L$: these remarkable facts appear not to have been noticed before ... some work ... by Geoffrey Dixon ...". Geoffrey Dixon says in his book "Division Algebras, Lattices, Physics, Windmill Tilting" using notation $\{e_0, e_1, e_2, e_3, e_4, e_5, e_6, e_7\}$ for the Octonion basis elements that Robert A. Wilson denotes by $\{1=i_0, i_1, i_2, i_3, i_4, i_5, i_6\}$ and I often denote by $\{1, i, j, k, E, I, J, K\}$: "...

$$\begin{aligned} \Xi_0 &= \{\pm e_a\}, \\ \Xi_2 &= \{(\pm e_a \pm e_b \pm e_c \pm e_d)/2 : a, b, c, d \text{ distinct}, \\ &\quad e_a(e_b(e_c e_d)) = \pm 1\}, \end{aligned}$$

$$\begin{aligned} \Xi^{\text{even}} &= \Xi_0 \cup \Xi_2, \\ \mathcal{E}_8^{\text{even}} &= \text{span}\{\Xi^{\text{even}}\}, \end{aligned}$$

$$\begin{aligned} \Xi_1 &= \{(\pm e_a \pm e_b)/\sqrt{2} : a, b \text{ distinct}\}, \\ \Xi_3 &= \{(\sum_{a=0}^7 \pm e_a)/\sqrt{8} : \text{even number of '+'s}\}, \end{aligned}$$

$$\begin{aligned} \Xi^{\text{odd}} &= \Xi_1 \cup \Xi_3, \\ \mathcal{E}_8^{\text{odd}} &= \text{span}\{\Xi^{\text{odd}}\} \end{aligned}$$

(spans over integers) ...

Ξ^{even} has $16+224 = 240$ elements ... Ξ^{odd} has $112+128 = 240$ elements ... $\mathcal{E}_8^{\text{even}}$ does not close with respect to our given octonion multiplication ...[but]... the set $\Xi^{\text{even}}[0-a]$, derived from Ξ^{even} by replacing each occurrence of e_0 ... with e_a , and vice versa, is multiplicatively closed. ...".

Geoffrey Dixon's Ξ^{even} corresponds to B

Geoffrey Dixon's $\Xi^{\text{even}}[0-a]$ corresponds to the seven At

Geoffrey Dixon's Ξ^{odd} corresponds to L

Ignoring factors like 2, j, k, and +/-1 the Leech lattice structure is:

(L , 0 , 0)	Number: $3 \times 240 = 720$
(B , B , 0)	Number: $3 \times 240 \times 16 = 11520$
(L s , L , L)	Number: $3 \times 240 \times 16 \times 16 = 184320$
(Ξ^{odd} , 0 , 0)	Number: $3 \times 240 = 720$
(Ξ^{even} , Ξ^{even} , 0)	Number: $3 \times 240 \times 16 = 11520$
(Ξ^{odd} s , Ξ^{odd} , Ξ^{odd})	Number: $3 \times 240 \times 16 \times 16 = 184320$

My view is that **the E8 domain B is fundamental** and the E8 domains L and L s are derived from it.

That view is based on analogy with the 4-dimensional 24-cell and its dual 24-cell. Using Quaternionic coordinates $\{1, i, j, k\}$ the 24-cell of 4-space has one Superposition Vertex for each 16-region of 4-space.

A Dual 24-cell gives a new Superposition Vertex at each edge of the region.

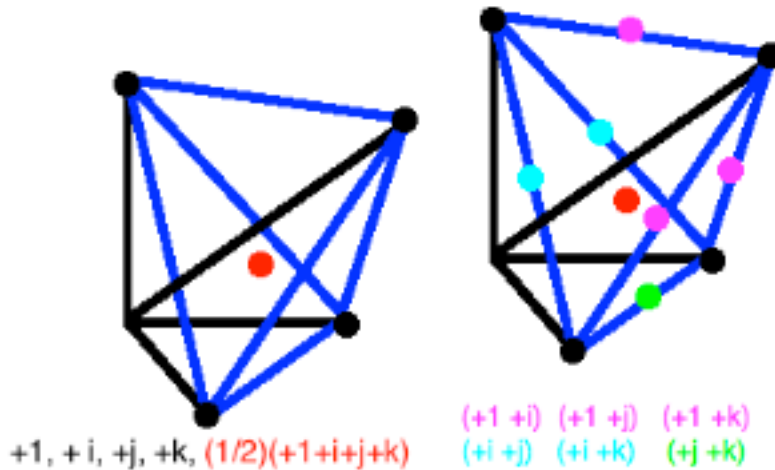

The Initial 24-cell Quantum Operators act with respect to 4-dim Physical Spacetime. $\{1,i,j,k\}$ represent time and 3 space coordinates.

$(1/2)(+1+i+j+k)$ represents a fundamental first-generation Fermion particle/antiparticle (there is one for for each of the 16-regions).

The Dual 24-cell Quantum Operators act with respect to 4-dim CP2 Internal Symmetry Space. Since $CP2 = SU(3)/SU(2) \times U(1)$,

$(+1+i)$ $(+1+j)$ $(+1+k)$ are permuted by $S3$ to form the Weyl Group of Color Force $SU(3)$,

$(+i+j)$ $(+i+k)$ are permuted by $S2$ to form the Weyl Group of Weak Force $SU(2)$,

$(+j+k)$ is permuted by $S1$ to form the Weyl Group of Electromagnetic Force $U(1)$.

The B-type 24-cell is fundamental because it gives Fundamental Fermions.

The L-type dual 24-cell is derivative because it gives Standard Model Gauge Bosons.

Robert A.Wilson in "Octonions and the Leech lattice" also said

"... **B is not closed under multiplication** ... Kirmse's mistake ... [but]... as Coxeter ... pointed out ...

... there are seven non-associative rings $A_t = (1/2) (1 + it) B (1 + it)$,
obtained from B by swapping 1 with it ... for t in F7 ...".

H. S. M. Coxeter in "Integral Cayley Numbers" (Duke Math. J. 13 (1946) 561-578) said

"... Kirmse ... defines ... an integral domain ... which he calls J1 [Wilson's B] ... [but]...

J1 itself is not closed under multiplication ... Bruck sent ... a revised description ... [of a]...

domain J ... derived from J1 by transposing two of the i's [imaginary Octonions]...

It is closed under multiplication ... there are ... seven such domains, since the

$(7 \text{ choose } 2) = 21$ possible transpositions fall into 7 sets of 3, each set having the same

effect. In each of the seven domains, one of the ... seven i's ... plays a special role, viz.,

that one which is not affected by any of the three transpositions. ...

J contains ... 240 units ... ". J is one of Wilson's seven A_t and, in Octonionic coordinates

$\{1,i,j,k,e,ie,je,ke\}$, is shown below with physical interpretation color-coded as

8-dim Spacetime Coordinates x 8-dim Momentum Dirac Gammas

Gravity $SU(2,2)=Spin(2,4)$ in a D4 + Standard Model $SU(3) \times U(2)$ in a D4

8 First-Generation Fermion Particles x 8 Coordinate Components

8 First-Generation Fermion AntiParticles x 8 Coordinate Components

112 = (16+48=64) + (24+24=48) Root Vectors corresponding to D8:

$\pm 1, \pm i, \pm j, \pm k, \pm e, \pm ie, \pm je, \pm ke,$

$(\pm 1 \pm i \quad \quad \quad \pm e \pm ie \quad \quad \quad)/2$
 $(\pm 1 \quad \quad \pm j \quad \quad \quad \pm e \quad \quad \quad \pm je \quad \quad \quad)/2$
 $(\pm 1 \quad \quad \quad \pm k \pm e \quad \quad \quad \pm ke)/2$

$(\quad \quad \quad \pm j \pm k \quad \quad \quad \pm je \pm ke)/2$
 $(\quad \pm i \quad \quad \quad \pm k \quad \quad \quad \pm ie \quad \quad \quad \pm ke)/2$
 $(\quad \pm i \pm j \quad \quad \quad \pm ie \pm je \quad \quad \quad)/2$

128 = 64 + 64 Root Vectors corresponding to half-spinor of D8:

$(\pm 1 \quad \quad \quad \pm ie \pm je \pm ke)/2$
 $(\pm 1 \quad \quad \pm j \pm k \quad \quad \quad \pm ie \quad \quad \quad)/2$
 $(\pm 1 \pm i \quad \quad \quad \pm k \quad \quad \quad \pm je \quad \quad \quad)/2$
 $(\pm 1 \pm i \pm j \quad \quad \quad \pm ke)/2$

$(\quad \pm i \pm j \pm k \pm e \quad \quad \quad)/2$
 $(\quad \pm i \quad \quad \quad \pm e \quad \quad \quad \pm je \pm ke)/2$
 $(\quad \quad \quad \pm j \pm e \pm ie \quad \quad \quad \pm ke)/2$
 $(\quad \quad \quad \pm k \pm e \pm ie \pm je \quad \quad \quad)/2$

The above Coxeter-Bruck J is, in the notation I usually use, denoted 7E8 .
 It is one of Coxeter's seven domains (Wilson's seven {A0,A1,A2,A3,A4,A5,A6})
 that I usually denote as { 1E8 , 2E8 , 3E8 , 4E8 , 5E8 , 6E8 , 7E8 } .

Since the Leech lattice structure is

$(L , 0 , 0)$ **Number: 3x240 = 720**
 $(B , B , 0)$ **Number: 3x240 x 16 = 11520**
 $(L s , L , L)$ **Number: 3x240 x 16 x 16 = 184320**

if you replace the structural B with 7E8 and the Leech lattice structure becomes

$(L , 0 , 0)$ **Number: 3x240 = 720**
 $(7E8 , 7E8 , 0)$ **Number: 3x240 x 16 = 11520**
 $(L s , L , L)$ **Number: 3x240 x 16 x 16 = 184320**

and the Leech lattice of E8 26-dim String Theory is the Superposition of
8 Leech lattices based on each of { B , 1E8 , 2E8 , 3E8 , 4E8 , 5E8 , 6E8 , 7E8 }
 just as the D8 branes of E8 26-dim String Theory are each the Superposition of
 the 8 domains { B , 1E8 , 2E8 , 3E8 , 4E8 , 5E8 , 6E8 , 7E8 } .

Fundamental Fermion as Schwinger Source

The Fundamental Fermion Particle does not remain a single Planck-scale entity. **Tachyons create clouds of particles/antiparticles** as described by Bert Schroer in hep-th/9908021: "... any compactly localized operator applied to the vacuum generates clouds of pairs of particle/antiparticles ... More specifically it leads to the impossibility of having a local generation of pure one-particle vectors unless the system is interaction-free ...".

What is the structural form of the Fundamental Fermion Cloud ?

In "**Kerr-Newman [Black Hole] solution as a Dirac particle**", hep-th/0210103, H. I. Arcos and J. G. Pereira say: "... For $m^2 < a^2 + q^2$, with m , a , and q respectively the source mass, angular momentum per unit mass, and electric charge, the Kerr-Newman (KN) solution of Einstein's equation reduces to a naked singularity of circular shape, enclosing a disk across which the metric components fail to be smooth ... due to its topological structure, the extended KN spacetime does admit states with half-integral angular momentum. ... The state vector ... evolution is ... governed by the Dirac equation. ... for symmetry reasons, the electric dipole moment of the KN solution vanishes identically, a result that is within the limits of experimental data ... a and m are thought of as parameters of the KN solution, which only asymptotically correspond respectively to angular momentum per unit mass and mass. Near the singularity, a represents the radius of the singular ring ... With ... renormalization ... for the usual scattering energies, the resulting radius is below the experimental limit for the extendedness of the electron ...".

What is the size of the Fundamental Fermion Kerr-Newman Cloud ?

The FFKN Cloud is one Planck-scale Fundamental Fermion Valence Particle plus an effectively neutral cloud of particle/antiparticle pairs. The symmetry of the cloud is governed by the 24-dimensional Leech lattice by which the Single Cell was formed.

Here (adapted from Wikipedia) is a chart of the Monster M and its relation to other Sporadic Finite Groups and some basic facts and commentary:

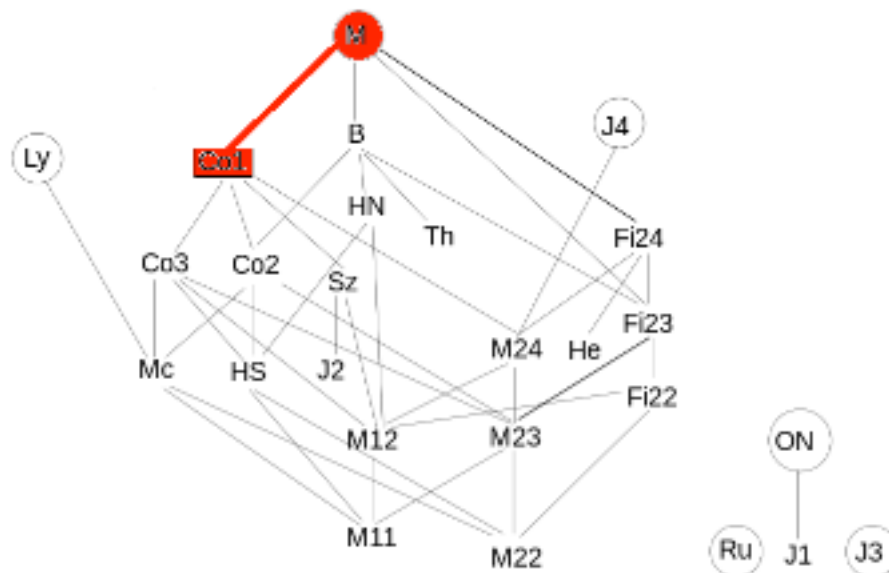

The largest such subgroups of M are B, Fi24, and Co1.

B, the Baby Monster, is sort of like a downsized version of M, as B contains Co2 and Fi23 while M contains Co1 and Fi24.

Fi24 (more conventionally denoted Fi_{24}') is of order $1255205709190661721292800 = 1.2 \times 10^{24}$. It is the centralizer of an element of order 3 in the monster group M and is a triple cover of a 3-transposition group. It may be that Fi_{24}' symmetry has its origin in the Triality of E8 26-dim String Theory.

The order of Co1 is $2^{21} \cdot 3^9 \cdot 5^4 \cdot 7^2 \cdot 11 \cdot 13 \cdot 23$ or about 4×10^{18} .

$Aut(\text{Leech Lattice}) = \text{double cover of Co1}$.

The order of the double cover $2 \cdot \text{Co1}$ is $2^{22} \cdot 3^9 \cdot 5^4 \cdot 7^2 \cdot 11 \cdot 13 \cdot 23$ or about 0.8×10^{19} .

Taking into account the non-sporadic part of the Leech Lattice symmetry

according to the ATLAS at brauer.maths.qmul.ac.uk/Atlas/v3/spor/M/

the maximal subgroup of M involving Co1 is $2^{(1+24)} \cdot \text{Co1}$ of order

$139511839126336328171520000 = 1.4 \times 10^{26}$

As $2 \cdot \text{Co1}$ is the Automorphism group of the Leech Lattice modulo to which the Single Cell was formed, and as

the E8 26-dim String Theory Leech Lattice is a superposition of 8 Leech Lattices,

$8 \times 2^{(1+24)} \cdot \text{Co1}$ describes the structure of the FFKN Cloud. Therefore,

the volume of the FFKN Cloud should be on the order of 10^{27} x Planck scale, and

the FFKN Cloud should contain on the order of 10^{27} particle/antiparticle pairs

and **its size should be** somewhat larger than, but roughly similar to,

$10^{(27/3)} \times 1.6 \times 10^{(-33)} \text{ cm} = \text{roughly } 10^{(-24)} \text{ cm}.$

The full 26-dimensional Lattice Bosonic String Theory can be regarded as an infinite-dimensional Affinization of the Theory of a Single Cell.

James Lepowsky said in math.QA/0706.4072:

"... **the Fischer-Griess Monster M ... was constructed by Griess as a symmetry group (of order about 10^{54}) of a remarkable new commutative but very, very highly nonassociative, seemingly ad-hoc, algebra B of dimension 196,883.** The "structure constants" of the Griess algebra B were "forced" by expected properties of the conjectured-to-exist Monster. It was proved by J. Tits that M is actually the full symmetry group of B. ...

There should exist a (natural) infinite-dimensional Z-graded module for M (i.e., representation of M)

$$V = \text{DIRSUM}(n=-1,0,1,2,3,\dots) V_n \dots$$

such that

... the graded dimension of the graded vector space $V \dots = \dots \text{SUM}(n=-1,0,1,2,3,\dots) (\dim V_n) q^n$

where

$J(q) = q^{-1} + 0 + 196884q + \text{higher-order terms}$,
the classical modular function with its constant term set to 0. $J(q)$ is the suitably normalized generator of the field of $SL(2, Z)$ -modular invariant functions on the upper half-plane, with $q = \exp(2\pi i \tau)$, τ in the upper half-plane ...

Conway and Norton conjectured ... for every g in M (not just $g = 1$), the the generating function

$$\dots \text{the graded trace of the action of } g \text{ on the graded space } V \dots = \dots \text{SUM}(n=-1,0,1,2,3,\dots) (\text{tr } g | V_n) q^n$$

should be the analogous "Hauptmodul" for a suitable discrete subgroup of $SL(2, R)$, a subgroup having a fundamental "genus-zero property," so that its associated field of modular-invariant functions has a single generator (a Hauptmodul) ... (... the graded dimension is of course the graded trace of the identity element $g = 1$.) The Conway-Norton conjecture subsumed a remarkable coincidence that had been noticed earlier

- that the 15 primes giving rise to the genus-zero property ... are precisely the primes dividing the order of the ... Monster ...

the McKay-Thompson conjecture ... that there should exist a natural ... infinite-dimensional Z-graded M -module V whose graded dimension is $J(q)$... was (constructively) proved The graded traces of some, but not all, of the elements of the Monster - the elements of an important subgroup of M , namely, a certain involution centralizer involving the largest Conway sporadic group Co_1 - were consequences of the construction, and these graded traces were indeed (suitably) modular functions ... We called this V "**the moonshine module $V[\text{flat}]$ "** ...

The construction ... needed ... a natural infinite-dimensional "affinization" of the Griess algebra B acting on $V[\text{flat}]$

This "affinization," which was part of the new algebra of vertex operators, is analogous to, but more subtle than, the notion of affine Lie algebra ... More precisely, the vertex operators were needed for a "commutative affinization" of a certain natural 196884-dimensional enlargement B' of B , with an identity element (rather than a "zero" element) adjoined to B . This enlargement B' naturally incorporated the Virasoro algebra - the central extension of the Lie algebra of formal vector fields on the circle - acting on $V[\text{flat}]$...

The vertex operators were also needed for a natural "lifting" of Griess's action of M from the finite-dimensional space B to the infinite-dimensional structure $V[\text{flat}]$, including its algebra of vertex operators and its copy of the affinization of B' .

Thus the Monster was now realized as the symmetry group of a certain explicit "algebra of vertex operators" based on an infinite-dimensional \mathbb{Z} -graded structure whose graded dimension is the modular function $J(q)$.

Griess's construction of B and of M acting on B was a crucial guide for us, although we did not start by using his construction; rather, we recovered it, as a finite-dimensional "slice" of a new infinite-dimensional construction using vertex operator considerations. ...

The initially strange-seeming finite-dimensional Griess algebra was now embedded in a natural new infinite-dimensional space on which a certain algebra of vertex operators acts ... At the same time, the Monster, a finite group, took on a new appearance by now being understood in terms of a natural infinite-dimensional structure. ... the largest sporadic finite simple group, the Monster, was "really" infinite-dimensional ...

The very-highly-nonassociative Griess algebra, or rather, from our viewpoint, the natural modification of the Griess algebra, with an identity element adjoined, coming from a "forced" copy the Virasoro algebra, became simply the conformalweight-two subspace of an algebra of vertex operators of a certain "shape." ...

the constant term of $J(q)$ is zero, and this choice of constant term, which is not uniquely determined by number-theoretic principles, is not traditional in number theory. It turned out that the vanishing of the constant term ... was canonically "forced" by the requirement that the Monster should act naturally on $V[\text{flat}]$ and on an associated algebra of vertex operators.

This vanishing of the degree-zero subspace of $V[\text{flat}]$ is actually analogous in a certain strong sense to the absence of vectors in the Leech lattice of square-length two; the Leech lattice is a distinguished rank-24 even unimodular (self-dual) lattice with no vectors of square-length two.

In addition, this vanishing of the degree-zero subspace of $V[\text{flat}]$ and the absence of square-length-two elements of the Leech lattice are in turn analogous to the absence

of code-words of weight 4 in the Golay error-correcting code, a distinguished selfdual binary linear code on a 24-element set, with the lengths of all code-words divisible by 4. In fact, the Golay code was used in the original construction of the Leech lattice, and the Leech lattice was used in the construction of $V[\text{flat}]$

This was actually to be expected ... because it was well known that the automorphism groups of both the Golay code and the Leech lattice are (essentially) sporadic finite simple groups; the automorphism group of the Golay code is the Mathieu group M_{24} and the automorphism group of the Leech lattice is a double cover of the Conway group Co_1 mentioned above, and both of these sporadic groups were well known to be involved in the Monster ... in a fundamental way....

The Golay code is actually unique subject to its distinguishing properties mentioned above ... and **the Leech lattice is unique** subject to its distinguishing properties mentioned above ... **Is $V[\text{flat}]$ unique? If so, unique subject to what? ... this uniqueness is an unsolved problem ...**

$V[\text{flat}]$ came to be viewed in retrospect by string theorists as an inherently stringtheoretic structure: the "chiral algebra" underlying the Z_2 -orbifold conformal field theory based on the Leech lattice.

The string-theoretic geometry is this: One takes the torus that is the quotient of 24-dimensional Euclidean space modulo the Leech lattice, and then one takes the quotient of this manifold by the "negation" involution $x \rightarrow -x$, giving rise to an orbit space called an "orbifold"—a manifold with, in this case, a "conical" singularity. Then one takes the "conformal field theory" (presuming that it exists mathematically) based on this orbifold, and from this one forms a "string theory" in two-dimensional space-time by compactifying a 26-dimensional "bosonic string" on this 24-dimensional orbifold. The string vibrates in a 26-dimensional space, 24 dimensions of which are curled into this 24-dimensional orbifold ...

Borcherds used ... ideas, including his results on generalized Kac-Moody algebras, also called Borcherds algebras, together with certain ideas from string theory, including the "physical space" of a bosonic string along with the "no-ghost theorem" ... to prove the remaining Conway-Norton conjectures for the structure $V[\text{flat}]$... What had remained to prove was ... that ... the conjugacy classes outside the involution centralizer - were indeed the desired Hauptmoduls ... He accomplished this by constructing a copy of his "Monster Lie algebra" from the "physical space" associated with $V[\text{flat}]$ enlarged to a central-charge-26 vertex algebra closely related to the 26-dimensional bosonic-string structure mentioned above. He transported the known action of the Monster from $V[\text{flat}]$ to this copy of the Monster Lie algebra, and ... he proved certain recursion formulas ... he succeeded in concluding that all the graded traces for $V[\text{flat}]$ must coincide with the formal series for the Hauptmoduls ...

this vertex operator algebra $V[\text{flat}]$ has the following three simply-stated

properties ...

- (1) $V[\text{flat}]$, which is an irreducible module for itself ... , is its only irreducible module, up to equivalence ... every module for the vertex operator algebra $V[\text{flat}]$ is completely reducible and is in particular a direct sum of copies of itself. Thus the vertex operator algebra $V[\text{flat}]$ has no more representation theory than does a field! (I mean a field in the sense of mathematics, not physics. Given a field, every one of its modules - called vector spaces, of course - is completely reducible and is a direct sum of copies of itself.)
- (2) $\dim V[\text{flat}]_0 = 0$. This corresponds to the zero constant term of $J(q)$; while the constant term of the classical modular function is essentially arbitrary, and is chosen to have certain values for certain classical numbertheoretic purposes, the constant term must be chosen to be zero for the purposes of moonshine and the moonshine module vertex operator algebra.
- (3) The central charge of the canonical Virasoro algebra in $V[\text{flat}]$ is 24. "24" is the "same 24" so basic in number theory, modular function theory, etc. As mentioned above, this occurrence of 24 is also natural from the point of view of string theory.

These three properties are actually "smallness" properties in the sense of conformal field theory and string theory. These properties allow one to say that $V[\text{flat}]$ essentially defines the smallest possible nontrivial string theory ... (These "smallness" properties essentially amount to: "no nontrivial representation theory," "no nontrivial gauge group," i.e., "no continuous symmetry," and "no nontrivial monodromy"; this last condition actually refers to both the first and third "smallness" properties.)

Conversely, conjecturally ... $V[\text{flat}]$ is the unique vertex operator algebra with these three "smallness" properties (up to isomorphism). This conjecture ... remains unproved. It would be the conformal-field-theoretic analogue of the uniqueness of the Leech lattice in sphere-packing theory and of the uniqueness of the Golay code in error-correcting code theory ...

Proving this uniqueness conjecture can be thought of as the "zeroth step" in the program of classification of (reasonable classes of) conformal field theories. M. Tuite has related this conjecture to the genus-zero property in the formulation of monstrous moonshine.

Up to this conjecture, then, we have the following remarkable characterization of the largest sporadic finite simple group: **The Monster is the automorphism group of the smallest nontrivial string theory that nature allows ... Bosonic 26-dimensional space-time ... "compactified" on 24 dimensions, using the orbifold construction $V[\text{flat}]$...** or more precisely, the automorphism group of the vertex operator algebra with the canonical "smallness" properties. ...

This definition of the Monster in terms of "smallness" properties of a vertex operator algebra provides a remarkable motivation for the definition of the precise notion of vertex (operator) algebra. The discovery of string theory (as a mathematical, even if not necessarily physical) structure sooner or later must lead naturally to the question of whether this "smallest" possible nontrivial vertex operator algebra V exists, and the question of what its symmetry group (which turns out to be the largest sporadic finite simple group) is.

And on the other hand, the classification of the finite simple groups - a mathematical problem of the absolutely purest possible sort - leads naturally to the question of what natural structure the largest sporadic group is the symmetry group of; the answer entails the development of string theory and vertex operator algebra theory (and involves modular function theory and monstrous moonshine as well).

The Monster, a singularly exceptional structure - in the same spirit that the Lie algebra E_8 is "exceptional," though M is far more "exceptional" than E_8 - helped lead to, and helps shape, the very general theory of vertex operator algebras. (The exceptional nature of structures such as E_8 , the Golay code and the Leech lattice in fact played crucial roles in the construction of $V[\text{flat}]$...

$V[\text{flat}]$ is defined over the field of real numbers, and in fact over the field of rational numbers, in such a way that the Monster preserves the real and in fact rational structure, and that the Monster preserves a rational-valued positive-definite symmetric bilinear form on this rational structure. ...

the "orbifold" construction of $V[\text{flat}]$...[has been]... interpreted in terms of algebraic quantum field theory, specifically, in terms of local conformal nets of von Neumann algebras on the circle ...

the notion of vertex operator algebra is actually the "one-complex-dimensional analogue" of the notion of Lie algebra. But at the same time that it is the "one-complex-dimensional analogue" of the notion of Lie algebra, the notion of vertex operator algebra is also the "one-complex-dimensional analogue" of the notion of commutative associative algebra (which again is the corresponding "one-realdimensional" notion). ... This analogy with the notion of commutative associative algebra comes from the "commutativity" and "associativity" properties of the vertex operators ... in a vertex operator algebra ...

The remarkable and paradoxical-sounding fact that the notion of vertex operator algebra can be, and is, the "one-complex-dimensional analogue" of BOTH the notion of Lie algebra AND the notion of commutative associative algebra lies behind much of the richness of the whole theory, and of string theory and conformal field theory.

When mathematicians realized a long time ago that complex analysis was

qualitatively entirely different from real analysis (because of the uniqueness of analytic continuation, etc., etc.), a whole new point of view became possible. In vertex operator algebra theory and string theory, there is again a fundamental passage from "real" to "complex," this time leading from the concepts of both Lie algebra and commutative associative algebra to the concept of vertex operator algebra and to its theory, and also leading from point particle theory to string theory. ...

While a string sweeps out a two-dimensional (or, as we've been mentioning, one-complex-dimensional) "worldsheet" in space-time, **a point particle of course sweeps out a one-real-dimensional "world-line" in space-time**, with time playing the role of the "one real dimension," and this "one real dimension" is related in spirit to the "one real dimension" of the classical operads that I've briefly referred to - the classical operads "mediating" the notion of associative algebra and also the notion of Lie algebra (and indeed, any "classical" algebraic notion), and in addition "mediating" the classical notion of braided tensor category. The "sequence of operations performed one after the other" is related (not perfectly, but at least in spirit) to the ordering ("time-ordering") of the real line.

But as we have emphasized, the "algebra" of vertex operator algebra theory and also of its representation theory (vertex tensor categories, etc.) is "mediated" by an (essentially) one-complex-dimensional (analytic partial) operad (or more precisely, as we have mentioned, the infinite-dimensional analytic structure built on this). When one needs to compose vertex operators, or more generally, intertwining operators, after the formal variables are specialized to complex variables, one must choose not merely a (time-)ordered sequencing of them, but instead, a suitable complex number, or more generally, an analytic local coordinate as well, for each of the vertex operators.

This process, very familiar in string theory and conformal field theory, is a reflection of how the one-complex-dimensional operadic structure "mediates" the algebraic operations in vertex operator algebra theory.

Correspondingly, "algebraic" operations in this theory are not intrinsically "timeordered"; they are instead controlled intrinsically by the one-complex-dimensional operadic structure. The "algebra" becomes intrinsically geometric.

"Time," or more precisely, as we discussed above, the one-real-dimensional world-line, is being replaced by a one-complex-dimensional world-sheet.

This is the case, too, for the vertex tensor category structure on suitable module categories. In vertex operator algebra theory, "algebra" is more concerned with one-complex-dimensional geometry than with one-real-dimensional time. ..."

ADE World-Line String Bohm Quantum Consciousness

(see Saul-Paul Sirag's ADEX and Consciousness: A Hyperspace View (extensively paraphrased here))

**Universal Geometric Entity = completion of union of tensor products of $CI(1,25)$
Each $CI(1,25)$ contains Lie Algebra $E8$ corresponding to McKay Group Algebra $C[ID]$
so $E8 \times C[ID]$ is basic Local Geometric Entity**

**Universal Body Physical World =
= 240 Root Vectors (120 pairs) of $E8$ Lie Algebra**
240 $E8$ Root Vectors decompose into 112 of $D8$ and 128 of $E7xA1$
 $D8 = \text{Bosonic Part} = 8\text{-dim Spacetime} + \text{Conformal Gravity} + \text{Standard Model}$
 $D8$ contains two copies of 24 $D4$ Root Vectors
plus 63-dim $SL(8)$ of unimodular 8-dim spacetime
plus 1-dim Center of a Creation-Annihilation Heisenberg Group
One $D4$ contains generators of Conformal Gravity plus Standard Model Ghosts
Other $D4$ contains Standard Model Generators plus Conformal Gravity Ghosts
 $E7xA1 = \text{Fermionic Part} = \text{Fermion Particles} + \text{Fermion AntiParticles}$
The $126+2 = 128$ Root Vectors of $E7xA1$ represent
8 components of 8 first-generation fermion particles = 64
plus
8 components of 8 first-generation fermion antiparticles = 64

$WE8 = \text{Weyl Group of } E8 = 128 \times 27 \times 5 \times 8!$ divides Complex 8-dim $C8$ into $C8 / WE8$

**Universal Mind Mental World =
= 120 elements of $C[ID]$ Group Algebra of ID McKay Group of $E8$**
ID McKay Group of $E8$ decomposes into McKay Groups of $D8$ and $E7xA1$
McKay Group of $D8 = Q6 = 24 = 8 \times 3 \times 1 = \text{vertices of 24-cell}$
McKay Group of $E7xA1 = 2OD = 96 = 8 \times 3 \times 4 = \text{edges of 24-cell}$
McKay Group of $E8 = ID = 120 = 8 \times 3 \times 5 = \text{vertices of 600-cell}$

$ME8 = ID = \text{McKay Group of } E8$ divides Complex Plane $C2$ into $C2 / ME8$

120 $WE8$ mirror planes in $C8$ are mapped into $C8 / WE8$
The point where all the mirrors intersect is the origin of $C8 / WE8$
to which is attached the identity fiber $C2 / ME8$.
Paths in $C8 / WE8$ correspond to World-Lines of Observers.
(World-Lines = Bosonic Strings)
Each deformation of $C2 / ME8$ selects a different path in $C8 / WE8$ so
 $C2 / ME8$ is the source of Mental Images of the Physical World.

E8 Dynkin Balance Numbers:

$$\begin{array}{cccccccc}
 & & & & & 3 & & \\
 & & & & & | & & \\
 1 & - & 2 & - & 3 & - & 4 & - & 5 & - & 6 & - & 4 & - & 2
 \end{array}$$

E8 Dynkin Representations:

$$\begin{array}{cccccccc}
 & & & & & 147,250 & & \\
 & & & & & | & & \\
 248 & - & 30,380 & - & 2,450,240 & - & 146,325,270 & - & 6,899,079,264 & - & 6,696,000 & - & 3,875
 \end{array}$$

E8 deformation mapping form:

$$E_8: V = x^3 + y^5 + z^2 + t_1x + t_2y + t_3xy + t_4y^2 + t_5y^3 + t_6xy^2 + t_7xy^3 + t_8.$$

The 7D separatrix Σ is in C_8 / WE_8 , since $\{t_1, \dots, t_8\}$ are invariants of the E8 Coxeter group (also called the Weyl group). Since there are 120 mirror hyperplanes in C_8 , 120 is the maximum number of points in the special orbits making up Σ in C_8 / WE_8 .

By contrast, the regular orbits have $128 \times 27 \times 5 \times 8! = 696729600$ elements, which is the order of WE_8 . These regular orbits are the points inside the chambers between the 7D walls of Σ . Note that $128 \times 27 \times 5$ is the product of the E8 balance numbers (1, 2, 3, 4, 5, 6, 4, 2, 3), while $8!$ is 40320, the order of the Symmetric-8 group which permutes the eight basic mirrors of E8 ... the sum of the squares of the E8 balance numbers is (via the McKay correspondence) the dimension of ID ...

- 1 - The control parameters of the catastrophe bundle are $\{t_1, \dots, t_8\}$.
- 2 - The t_8 parameter (always with 1 as coefficient) plays the role of time along the many paths ramifying out from the origin of C_8 / WE_8 , where there is attached the identity fiber C_2 / ME_8 .
- 3 - Movement along any of these paths corresponds to the selection of different values of the control parameters, and thus different fibers which entail an unfolding of the singularity structure C_2 / ME_8 .
- 4 - The changes in the fiber attached to a path are mild if the movement along the path (while picking out different fibers) remains within a chamber of the separatrix. If movement along the path crosses the separatrix, the change will be drastic.
- 5 - As fibers farther and farther from the origin in C_8 / W are encountered and more separatrix walls are crossed, the fibers become more unfolded.

Beyond the unfoldings of the fibers as described above, the E8 Lie algebra itself provides the structures for the resolution of the deformed (unfolded) fibers, including most importantly the identity fiber C_2 / ME_8 .

The Unfolding of the Mental Images of the Physical World based on the Bosonic String World-Line Paths in C_8 / WE_8 corresponds to the Unfolding of the Bohm Implicate Order

Unfolding of the Implicate Order of Bohm Quantum Theory

The Unfolding can be clarified by the projection diagram:

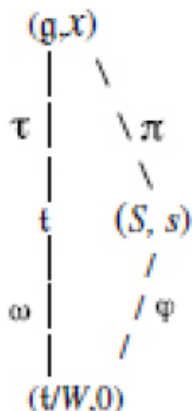

where g is E_8 and X is a subregular nilpotent element within the nilpotent variety in E_8 . The Lie Group version of this projection diagram takes $G(E_8)$ to its maximal torus T and then to T / WE_8 .

The projection τ is from E_8 onto its Cartan subalgebra t .

The projection w is from t to the orbit space t / WE_8 , where 0 is the origin in t / WE_8 .

The projection π is from E_8 to S which is the 10-dim slice transverse to the nilpotent variety in E_8 and s is a subregular (i.e., singular) element in this variety.

The nilpotent variety n in E_8 is the identity fiber in the fiber bundle with projection $X: (E_8, X) \rightarrow (t / WE_8, 0)$

so the dimensionality of n is $\dim(E_8) - \dim(t / WE_8) = (\text{Coxeter } \#)(\text{Rank}) = 30 \times 8 = 240$

The projection ϕ maps the Kleinian singularity C_2 / ME_8 onto the origin of t / WE_8 and as a universal deformation maps

unfolded versions of C_2 / ME_8 onto the parameters $\{t_1, \dots, t_8\}$ which are homogeneous polynomial invariants of WE_8 .

ϕ provides for the deformation (or unfolding) of the Kleinian singularities.

(THIS IS CONVENTIONAL BOHM PILOT ACTION)

the lifting of the slice S into the nilpotent variety n that provides for the simultaneous resolution (or desingularization) of all the fibers in S .

(THIS IS JACK SARFATTI'S UNCONVENTIONAL BACKREACTION)

the most singular fiber is the identity fiber in S , the singularity structure C_2 / ME_8 .

In the process of desingularization,

the singular point evolves into a series of exceptional curves,

which are 1D complex projective lines P^1 ,

which geometrically are a "bouquet" of 2D spheres which takes the form

of a dual structure to the E_8 Coxeter graph. For E_8 , the Kleinian singularity C_2 / ME_8 has its singular point resolved into a bouquet of 8 (2D)-spheres

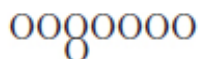

The Unfolding of the Implicate Order originates at the Origin Singularity $C2 / ME8$ which has structure $C2 / ID$ of the 600-cell



The resolution of the ADE singularity structure $C2 / ME8$ at the origin of $C8 / WE8$ where $ME8$ is a finite subgroup of $SU(2)$ corresponding to the 600-cell is accomplished by the lifting of $C2 / ME8$ to a higher dimensional space $C8$. This lifting is a key part of the universal resolution of the unfolding of $C2 / ME8$.

Lifting goes from Origin to an ALE (Asymptotically Locally Euclidean) space at Infinity. The $E8$ ALE space is the $E8$ McKay group ID. ALE means that this 4D space looks like a Euclidean space, except that the boundary at infinity is not the 3-sphere S^3 (which is the boundary at infinity of R^4) but is $S^3 / ID = 600\text{-cell}$



As a hyper-Kähler (H-K) space it has a metric which respects three complex structures I, J, K that obey the quaternion group formula $I^2 = J^2 = K^2 = IJK = -1$. As a 4D H-K space an ALE space is not compact but at infinity looks like $R^4 / ME8$ with boundary $S^3 / ME8$ in the sense that the singular point becomes desingularized as a “bouquet” of S^2 -spheres idual of the ADE Coxeter graph for $E8$.

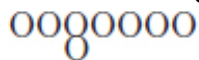

The Unfolding of the Origin C2 /ME8 onto the parameters $\{t_1, \dots, t_8\}$ in the space C8 is along World-Line Strings emanating from the 120 vertices of the Origin 600-cell and forms a Bosonic String Theory with 2D worldsheets swept out by World-Line Strings and embedded in 26D spacetime reduced by orbifolding of fermions to 10D spacetime which produces Standard Bohm Quantum Potential without Back-Reaction.

When the 120 basic World-Line Strings leading from the C2 / ID Origin 600-cell connect up with the 120 vertices of the ALE S3 / ID 600-cell at Infinity

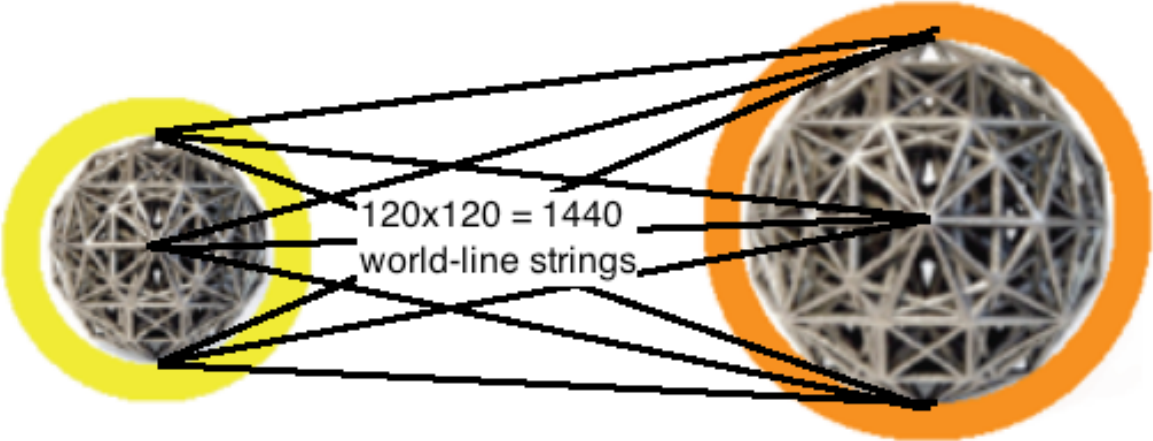

and the corresponding 120 basic World-Line Strings back to the Origin C2 / ID 600-cell are taken into account, you get Sarfatti-Bohm Quantum Potential with Back-Reaction.

“... **Bohm’s Quantum Potential can be viewed as an internal energy** of a quantum system ...” according to Dennis, de Gosson, and Hiley (arXiv 1412.5133) and Peter R. Holland says in "The Quantum Theory of Motion" (Cambridge 1993): "... **the total force ... from the quantum potential ... does not ... fall off with distance ...** because ... the quantum potential ... depends on the form of ...[the quantum state]... rather than ... its ... magnitude ...".

Penrose-Hameroff-type Quantum Consciousness is due to Resonant Quantum Potential Connections among Quantum State Forms.

The Quantum State Form of a Conscious Brain is determined by the configuration of a subset of its 10^{18} to 10^{19} Tubulin Dimers with math description in terms of a large Real Clifford Algebra:

Resonance is discussed by Carver Mead in “Collective Electrodynamics“ (MIT 2000): "... we can build ... a resonator from ... electric dipole ... configuration[s] ...



[such as Tubulin Dimers]

Because there are charges at the two ends of the dipole, we can have a contribution to the electric coupling from the scalar potential ... as well [as] from the magnetic coupling ... from the vector potential ... electric dipole coupling is stronger than magnetic dipole coupling ... the coupling of ... two ... configurations ... is the same, whether retarded or advanced potentials are used. Any ... configuration ... couples to any other on its light cone, whether past or future. ... The total phase accumulation in a ... configuration ... is the sum of that due to its own current, and that due to currents in other ... configurations ... far away ...

The energy in a single resonator alternates between the kinetic energy of the electrons (inductance), and the potential energy of the electrons (capacitance). With the two resonators coupled, the energy shifts back and forth between the two resonators in such a way that the total energy is constant ... The conservation of energy holds despite an arbitrary separation between the resonators ... Instead of scaling linearly with the number of charges that take part in the motion, the momentum of a collective system scales as the square of the number of charges! ... The inertia of a collective system, however, is a manifestation of the interaction, and cannot be assigned to the elements separately. ... Thus, it is clear that collective quantum systems do not have a classical correspondence limit. ...”.

For the 10^{18} Tubulin Dimers of the human brain,
the resonant frequencies are the same and exchanges of energy among them
act to keep them **locked in a Quantum Protectorate collective coherent state**.

Philip W. Anderson in cond-mat/0007287 and cond-mat/007185 said:

"... Laughlin and Pines have introduced the term "Quantum protectorate" as a general descriptor of the fact that certain states of quantum many-body systems exhibit properties which are unaffected by imperfections, impurities and thermal fluctuations. They instance ... flux quantization in superconductors, equivalent to the Josephson frequency relation which again has mensuration accuracy and is independent of imperfections and scattering. ...

... the source of quantum protection is a collective state of the quantum field involved such that the individual particles are sufficiently tightly coupled that elementary excitations no longer involve a few particles but are collective excitations of the whole system, and therefore, macroscopic behavior is mostly determined by overall conservation laws ... **a "quantum protectorate" ... [is]... a state in which the many-body correlations are so strong that the dynamics can no longer be described in terms of individual particles, and therefore perturbations which scatter individual particles are not effective ...**"

Mershin, Sanabria, Miller, Nawarathna, Skoulakis, Mavromatos, Kolomenskii, Scheussler, Ludena, and Nanopoulos in physics/0505080 "Towards Experimental Tests of Quantum Effects in Cytoskeletal Proteins" said:



Classically, the various dimers can only be in the ...[those]... conformations. Each dimer is influenced by the neighboring dimers resulting in the possibility of a transition. This is the basis for classical information processing, which constitutes the picture of a (classical) cellular automaton. If we assume ... that each dimer can find itself in a QM superposition of ...[those]... states, a quantum nature results. Tubulin can then be viewed as a typical two-state quantum mechanical system, where the dimers couple to conformational changes with $10^{(-9)} - 10^{(-11)}$ sec transitions, corresponding to an angular frequency $\sim 10^{10} - 10^{12}$ Hz. In this approximation, the upper bound of this frequency range is assumed to represent (in order of magnitude) the characteristic frequency of the dimers, viewed as a two-state quantum-mechanical system ...[

The Energy Gap of our Universe as superconductor condensate spacetime is from $3 \times 10^{(-18)}$ Hz (radius of universe) to 3×10^{43} Hz (Planck length). Its RMS amplitude is 10^{13} Hz = 10 THz = energy of neutrino masses = critical temperature T_c of BSCCO superconducting crystal Josephson Junctions]... large-scale quantum coherence ...[has been observed]... at temperatures within a factor of three of biological temperatures. MRI magnets contain hundreds of miles of superconducting wire and routinely carry a persistent current. There is no distance limit - the macroscopic wave function of the superfluid condensate of electron pairs, or Cooper pairs, in a sufficiently long cable could maintain its quantum phase coherence for many thousands of miles ... there is no limit to the total mass of the electrons participating in the superfluid state. The condensate is "protected" from thermal fluctuations by the BCS energy gap at the Fermi surface ... The term "quantum protectorate" ... describe[s] this and related many-body systems ...".

The Human Brain has about 10^{11} Neuron cells, each about 1,000 nm in size.
 The cytoskeleton of cells, including neurons of the brain, is made up of Microtubules

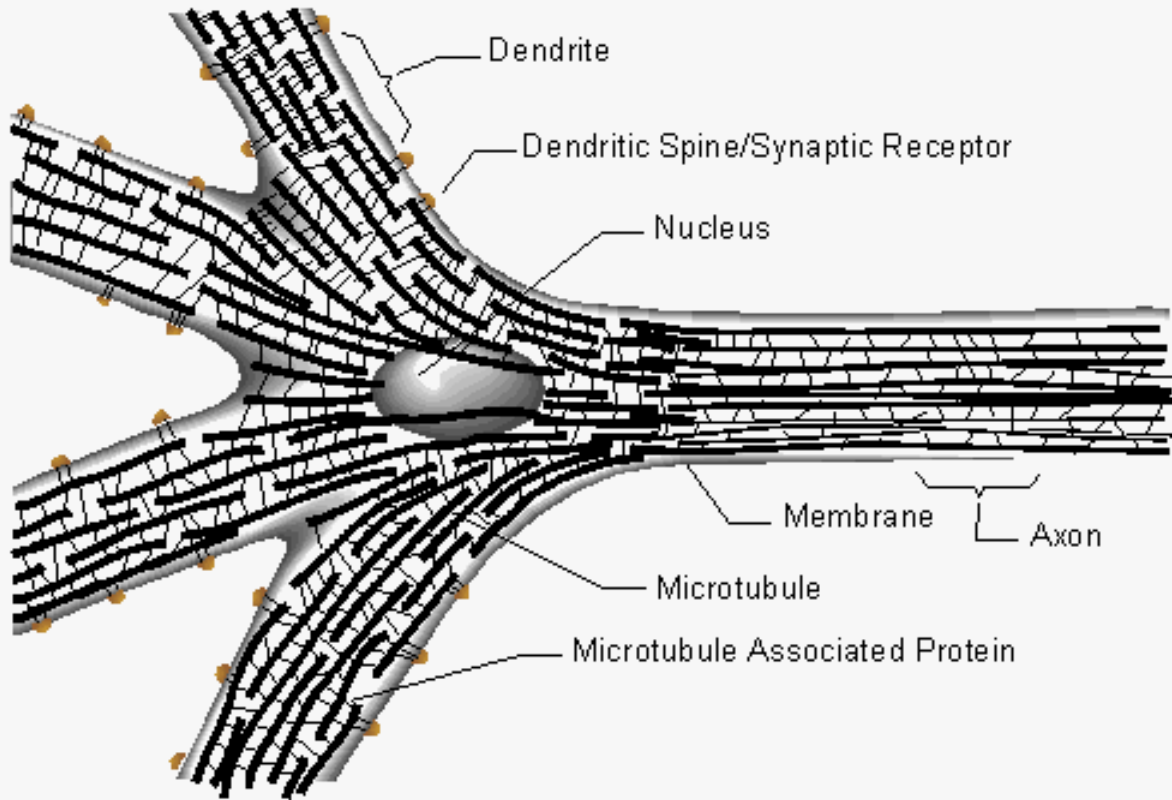

(image from "Orchestrated Objective Reduction of Quantum Coherence in Brain Microtubules: The "Orch OR" Model for Consciousness" by Penrose and Hameroff)

Each Neuron contains about 10^9 Tubulin Dimers, organized into Microtubules some of which are organized by a Centrosome. Centrosomes contain a pair of Centrioles.

A Centriole is about 200 nm wide and 400 nm long. Its wall is made up of 9 groups of 3 Microtubules, reflecting the symmetry of 27-dim $J(3,0)$

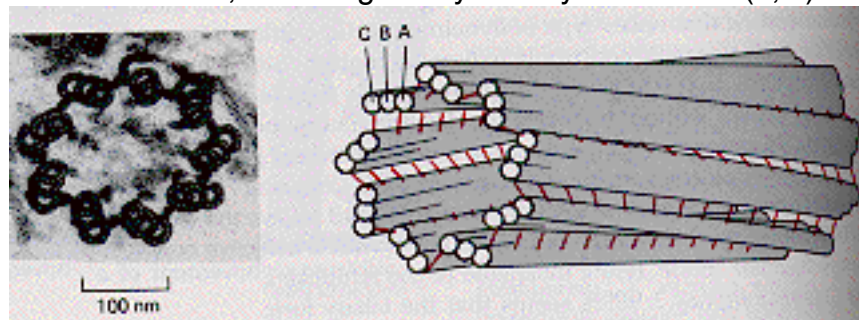

Each Microtubule is a hollow cylindrical tube with about 25 nm outside diameter and 14 nm inside diameter, made up of 13 columns of Tubulin Dimers

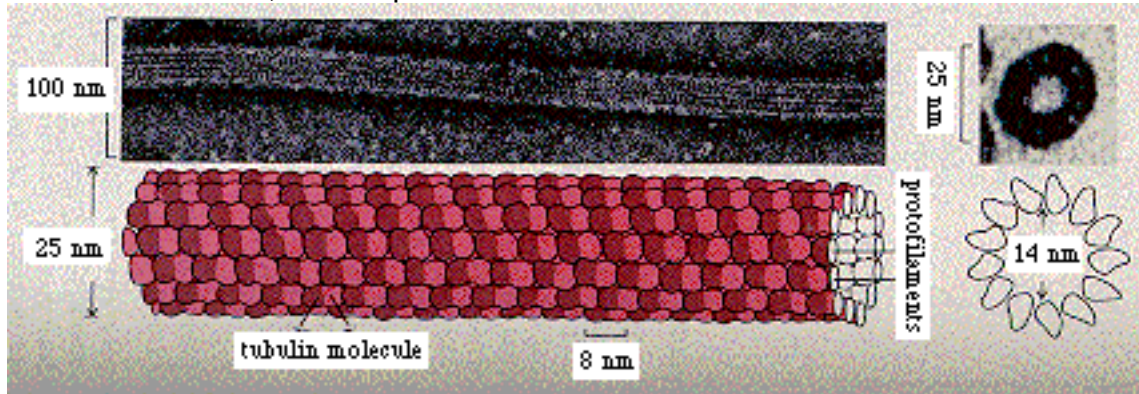

(illustrations and information about cells, microtubules, and centrioles are from Molecular Biology of the Cell, 2nd ed, by Alberts, Bray, Lewis, Raff, Roberts, and Watson (Garland 1989))

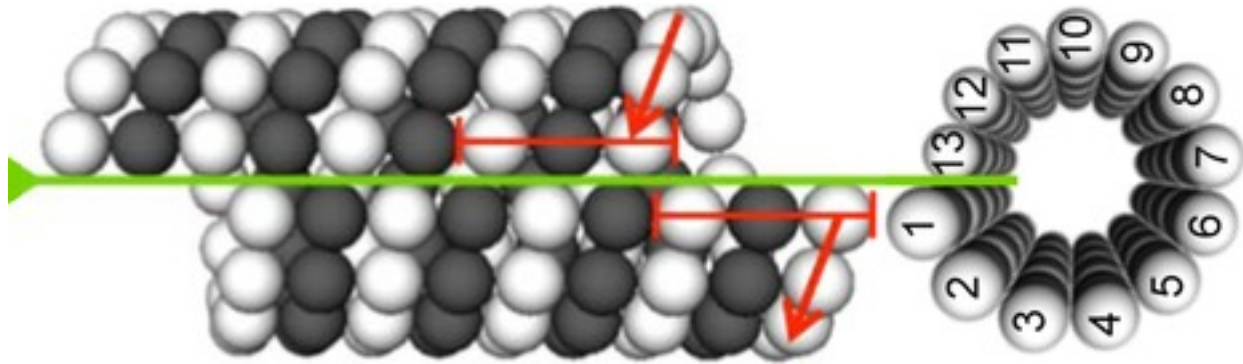

(image from Wikipedia on Microtubule)

Each Tubulin Dimer is about 8 nm x 4 nm x 4 nm, consists of two parts, alpha-tubulin and beta-tubulin (each made up of about 450 Amino Acids, each containing roughly 20 Atoms)
 A Microtubule 40 microns = 40,000 nm long contains $13 \times 40,000 / 8 = 65,000$ Dimers



(images adapted from nonlocal.com/hbar/microtubules.html by Rhett Savage)

The black dots indicate the position of the Conformation Electrons.

There are two energetically distinct configurations for the Tubulin Dimers:

Conformation Electrons Similarly Aligned (left image) - State 0

Conformation Electrons Maximally Separated (right image) - State 1

The two structures - State 0 ground state and State 1 higher energy state - make Tubulin Dimers the basis for a Microtubule binary math / code system.

Microtubule binary math / code system corresponds to Clifford Algebras $Cl(8)$ and $Cl(8) \times Cl(8) = Cl(16)$ containing E_8

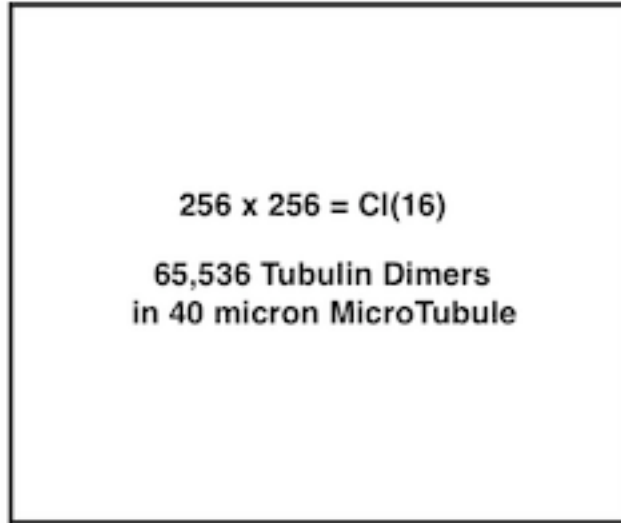

A 40 micron Microtubule contains Dimers representing the 65,536 elements of $Cl(16)$ which contains the 248 elements of Lie Algebra E_8 that defines E_8 Physics Lagrangian.

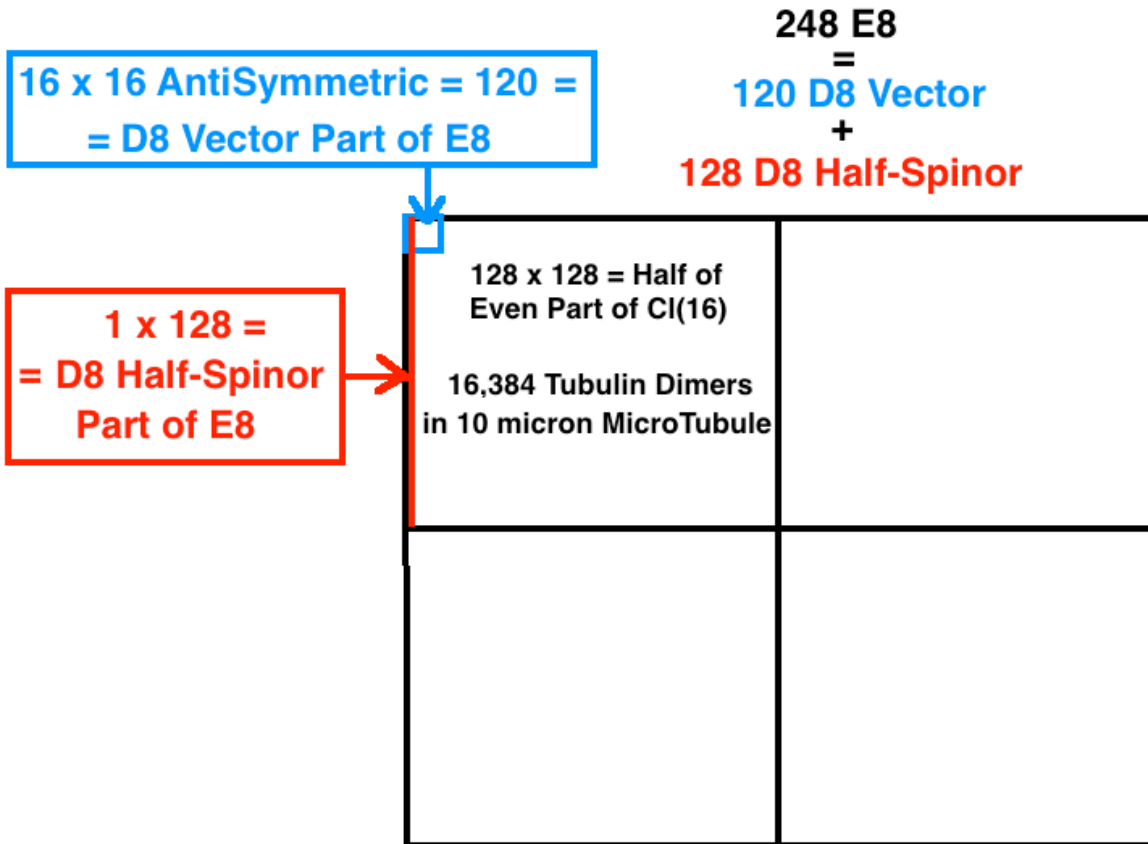

E_8 lives in only half of the block diagonal Even Part half of $Cl(16)$ so that E_8 of E_8 Physics can be represented by the 16,384 Dimers of a 10 micron Microtubule.

According to 12biophys.blogspot.com Lecture 11 Microtubule structure is dynamic: “... One end of the microtubule is composed of stable (GTP) monomers while the rest of the tubule is made up of unstable (GDP) monomers. The GTP end comprises a cap of stable monomers. Random fluctuations either increase or decrease the size of the cap. This results in 2 different dynamic states for the microtubule. Growing: cap is present Shrinking: cap is gone ...

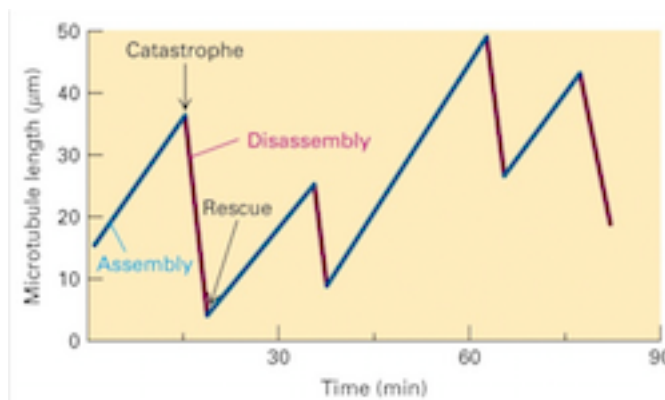

Microtubules spend most of their lives between 10 microns and 40 microns, sizes that can represent E8 as half of the Even Part (half) of Cl(16) (10 microns)

$$248 \text{ E8} = 120 \text{ D8 Vector } \square + 128 \text{ D8 Half-Spinor } \text{---}$$

<p>128 x 128 = Half of Even Part of Cl(16) 16,384 Tubulin Dimers in 10 micron MicroTubule</p>		<p>2 x (128 x 128) Even Part of Cl(16) 32,768 Tubulin Dimers in 20 micron MicroTubule</p>	<p>256 x 256 = Cl(16) 65,536 Tubulin Dimers in 40 micron MicroTubule</p>

or as the Even Part (half) of Cl(16) (20 microns) or as full Cl(16) (40 microns).

In a given Microtubule
the 128 D8 Half-Spinor part  is represented by a line of 128 Dimers in its stable GTP region and

the 120 D8 Vector part  by a 12 x 10 block of Dimers in its stable GTP region
(image adapted from 12biophys.blogspot.com Lecture 11)

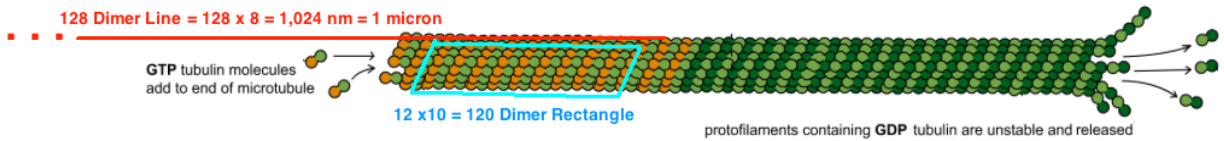

The image immediately above does not show how thin is the Microtubule.
The following image (from micro.magnet.fsu.edu) shows overall Microtubule shape

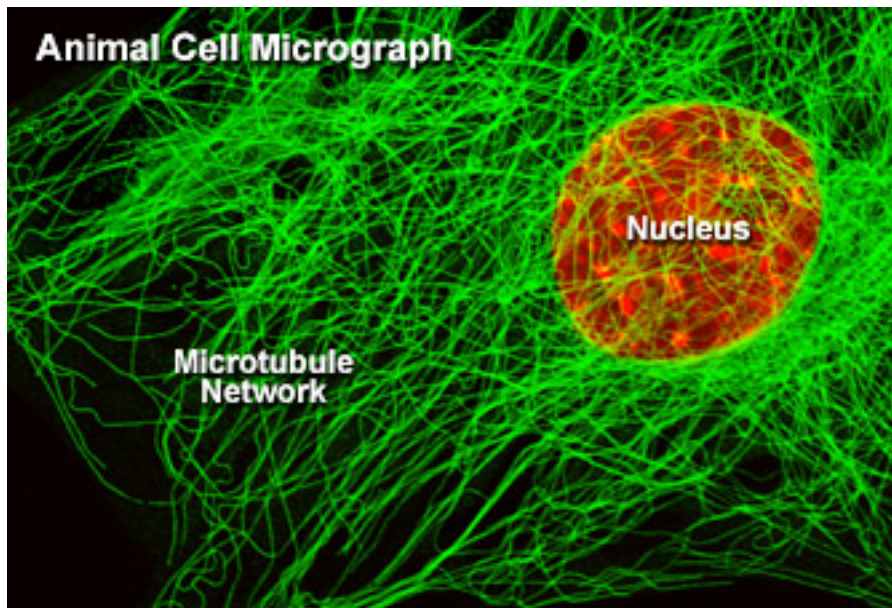

How do the Microtubules communicate with each other ?

Consider the Superposition of States State 0 and State 1 involving one Tubulin Dimer with Conformation Electron mass m and State1 / State 0 position separation a .

The Superposition Separation Energy Difference is the internal energy

$$E_{ssediff} = G m^2 / a$$

that can be seen as either the **energy of 26D String Theory spin two gravitons** or the **Bohm Quantum Potential internal energy**, equivalently.

Communication between two Microtubules is by the Bohm Quantum Potential between their respective corresponding Dimers (purple arrow) with the correspondence being based on connection between respective E8 subsets, the 128 D8 Half-Spinors (red arrow) and the 120 D8 BiVectors (cyan arrow)

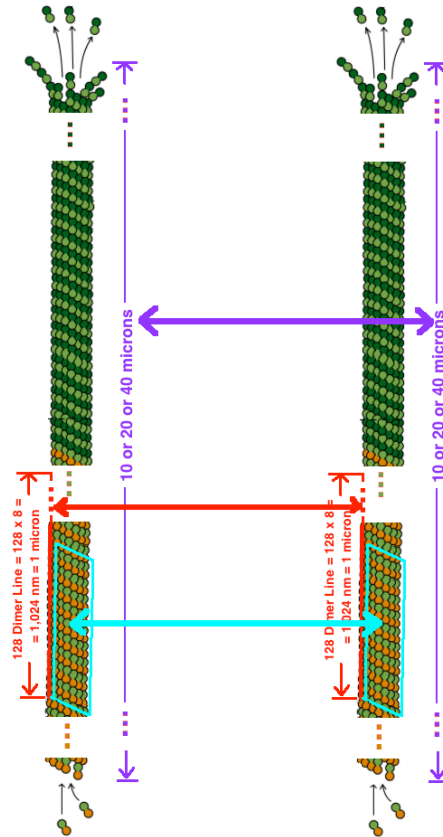

How is information encoded in the Microtubules ?

Each Microtubule contains E8, allowing Microtubules to be correlated with each other. The parts of the Microtubule beyond E8 are in Cl(16) for 40 micron Microtubules, or the Even Subalgebra of Cl(16) for 20 micron Microtubules, or half of the Even Subalgebra of Cl(16) for 10 micron Microtubules so since by 8-Periodicity of Real Clifford Algebras $Cl(16) = Cl(8) \times Cl(8)$ and since Cl(8) information is described by the Quantum Reed-Muller code $[[256, 0, 24]]$ **the information content of Cl(16) and its Subalgebras is described by the Tensor Product Quantum Reed-Muller code $[[256, 0, 24]]$ x $[[256, 0, 24]]$**

For a 40-micron Microtubule there are, outside the 248-E8 part, about 65,000 TD Qubits available to describe one Quantum Thought State among about $2^{65,000}$ possibilities, analogous to the Book of Genesis of $(22+5)^{78,064}$ Hebrew Letter/Final possibilities.

65,536-dimensional CI(16) not only contains the E8 of E8 Physics and the information content of Microtubules but also contains **the information content of DNA chromosome condensation and the information content of mRNA triple - amino acid transformations.**

In "Living Matter: Algebra of Molecules" (CRC Press 2016) Valery V. Stcherbic and Leonid P. Buchatsky say: "... DNA structure contains four nucleotides: adenine A, guanine G, cytosine C and thymine T. ...

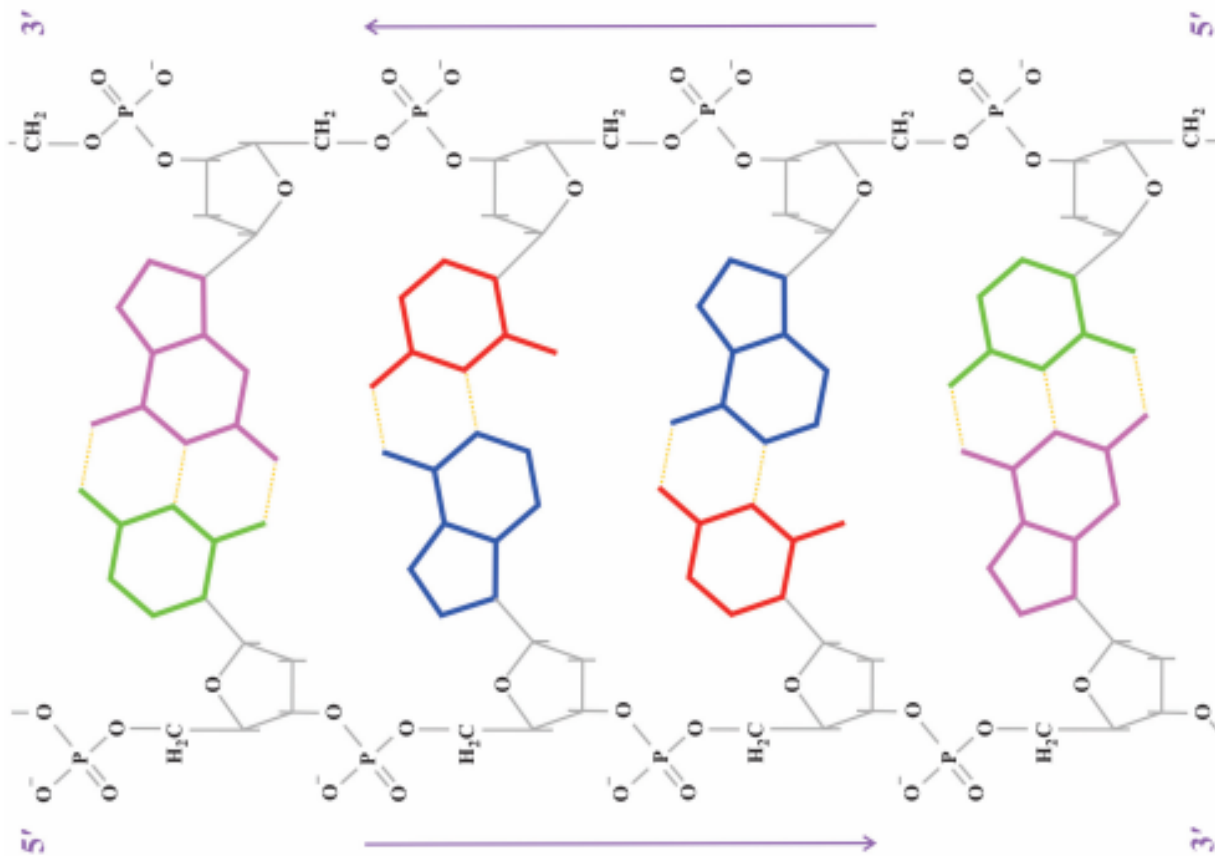

... The Sugar-phosphate group consists of 2-deoxyribose and phosphoric acid residues. DNA chain orientation is identified by carbon atoms of 2-deoxyribose: (5')CH₂ and (3')COH. The biological function of DNA and storage and transfer of genetic information to daughter cells is based on specific, complimentary pairing of nucleotides:

A is paired with T, and G with C.

...

... The Sugar-phosphate group consists of 2-deoxyribose and phosphoric acid residues. DNA chain orientation is identified by carbon atoms of 2-deoxyribose: (5')CH₂ and (3')COH. The biological function of DNA and storage and transfer of genetic information to daughter cells is based on specific, complimentary pairing of nucleotides:

A is paired with T, and G with C.

...

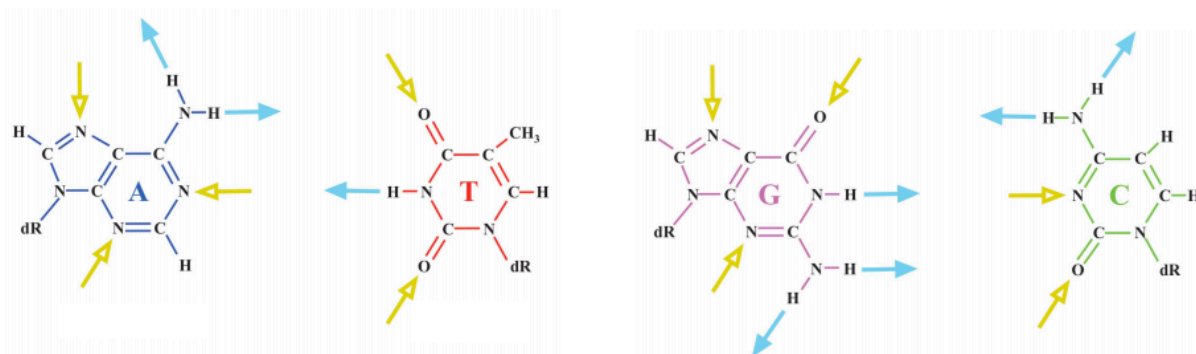

Figure 1.4 Potential vectors of hydrogen bond of DNA nucleotides.
Yellow arrows—acceptors, blue arrows—donors of hydrogen.

The space of DNA nucleotide states contains $2^3 \otimes 2^4 \otimes 2^5 \otimes 2^6 = 2^{18}$ elements of Clifford algebras. This space reduction to four nucleotides means compression of DNA information by a factor of $2^{18} / 4 = 65536$. Reduction of the nucleotide state space leads to DNA compactization and chromosome condensation. ...”.

In “Chromosome Condensation and Cohesion” (eLS December 2010) Laura Angelica Diaz-Martinez and Hongtau Yu say: “... The diploid human genome consists of 46 chromosomes, which collectively contain about 2 m of deoxyribonucleic acid (DNA). During mitosis, the genome is packaged into 46 pairs of sister chromatids, each less than 10 μm long. ...”.

The DNA information condensation factor of 65,536 is the dimension of $Cl(16)$ which is the Real Clifford Algebra containing 248-dim E_8 of E_8 Physics as 120-dim bivector D_8 plus 128-dim D_8 half-spinor and is also the Clifford Algebra of Microtubule information in Quantum Consciousness.

Microtubule information = 65,536 = CI(16) = DNA condensation information

Wikipedia describes interaction of Microtubules with DNA in mitosis condensation: “...

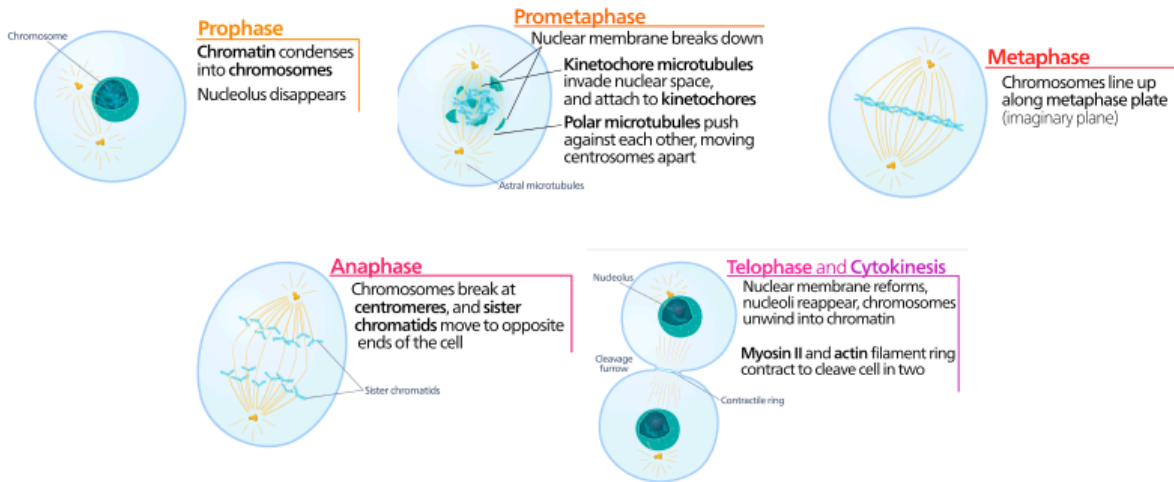

... Micrograph showing condensed chromosomes in blue, kinetochores in pink, and microtubules in green during metaphase of mitosis ...

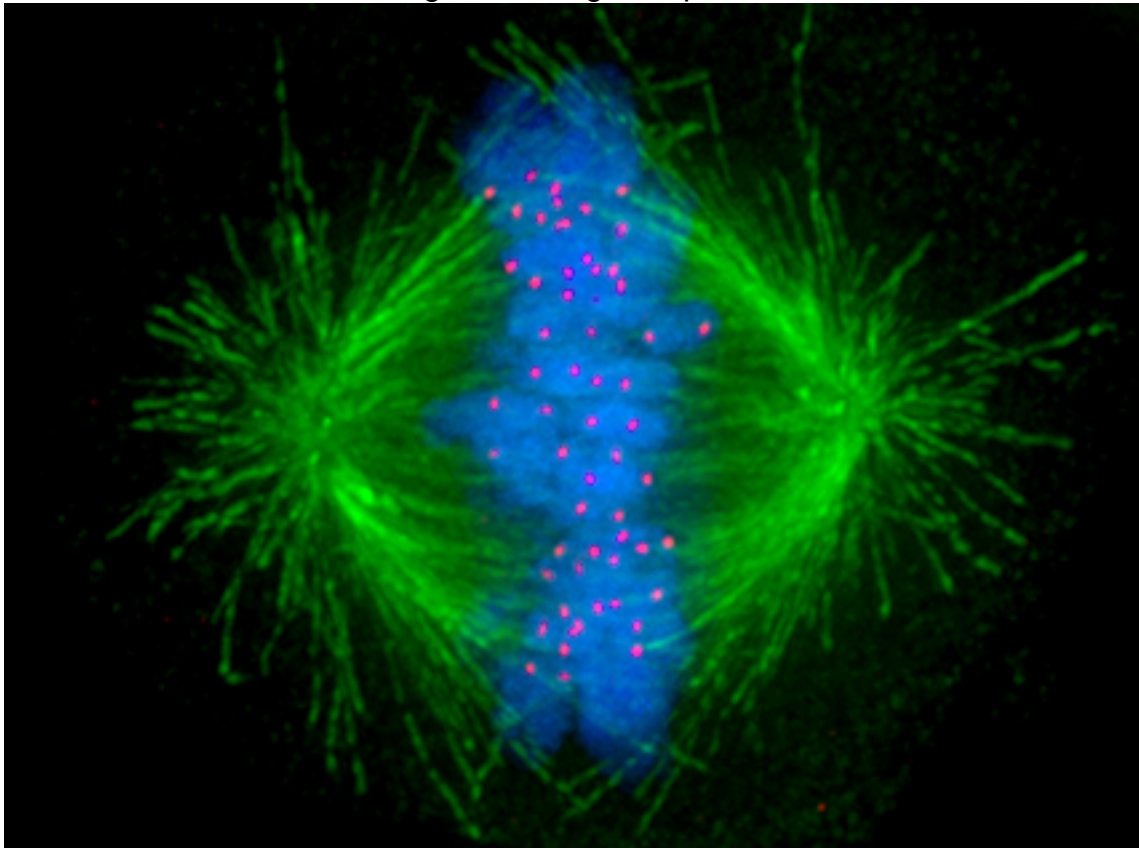

...”. Information lost by condensing DNA is stored in Microtubules through Anaphase after which it has been restored to the new Duplicated DNA.

Stcherbic and Buchatsky also say: "... Ribonucleic acid (RNA) can also store genetic information. A single RNA helix is seldom used as a carrier of genetic information (only in some viruses); its main role is storing DNA sites as copies of individual proteincoding genes (mRNA) or in formation of large structural complexes, e.g., ribosomes and spliceosomes. At self-splicing, RNA may perform the function of an enzyme. RNA also performs an important role during DNA replication. So called RNA-primers are necessary to synthesize DNA complementary chains, although this fact is not obvious. RNA contains sugar, ribose, which hydroxyl groups make more reactive than DNA. Besides, RNA contains uracil U, which is somewhat lighter than thymine.

...

At translation of mRNA triplets into genetic code amino acids, the dynamics of triplets to amino acids transformation should be taken into account.

...

At transition ... functional volume is equal to $3^5 = 243$.

To this volume there should be added the volume of auxiliary spaces, equal to $13 = 5 + 4 + 3 + 1$.

Accordingly, we get

256 functions of mRNA triplet transformation into amino acids of the genetic code.

Reverse transition ... from amino acids ... to triplet ... needs $5^3 + 3^1 = 128$ functions.

In addition, 128 triplets of mRNA-tRNA pairing should be added to this number. ...".

**The 256 of mRNA triplet to amino acids is represented by $Cl(8)$ Clifford algebra
and
the $128+128 = 256$ of amino acids to mRNA triplets is represented by another $Cl(8)$
so
that the mRNA triple - amino acid connection is represented by the tensor
product $Cl(8) \times Cl(8)$ which by 8-Periodicity of Real Clifford Algebras is the
Real Clifford Algebra $Cl(16)$
which also contains 248-dim E_8 of viXra 1508.0157 E_8 Physics
and is also the Clifford Algebra
of Microtubule information in viXra 1512.0300 Quantum Consciousness.**

What about information in the Many Microtubules of Human Consciousness ?

The information in one Microtubule is based on CI(16)
 which is contained in the CI(1,25) of 26D String Theory E8 Physics
 (see Chapter on E8 Quantum Theory)

How does this give rise to Penrose-Hameroff Quantum Consciousness ?

Consider the Superposition of States State 0 and State 1 involving one Tubulin Dimer with Conformation Electron mass m and State1 / State 0 position separation a .

The Superposition Separation Energy Difference is the internal energy

$$E_{\text{ssediff}} = G m^2 / a$$

that can be seen as the **energy of 26D String Theory spin two gravitons** which physically represent the **Bohm Quantum Potential internal energy**.

(see Appendix - Details of World-Line String Bohm Quantum Theory)

For a given Tubulin Dimer $a = 1$ nanometer = 10^{-7} cm so that

$$T = h / E_{\text{electron}} = (\text{Compton} / \text{Schwarzschild}) (a / c) = 10^{26} \text{ sec} = 10^{19} \text{ years}$$

Now consider the case of N Tubulin Dimers in Coherent Superposition connected by the Bohm Quantum Potential Force that does not fall off with distance.

Jack Sarfatti defines coherence length L by $L^3 = N a^3$ so that

the Superposition Energy E_N of N superposed Conformation Electrons is

$$E_N = G M^2 / L = N^{5/3} E_{\text{ssediff}}$$

The decoherence time for the system of N Tubulin Electrons is

$$T_N = h / E_N = h / N^{5/3} E_{\text{ssediff}} = N^{-5/3} 10^{26} \text{ sec}$$

so we have the following rough approximate Decoherence Times T_N

Number of Involved Tubulin Dimers	Time T_N
$10^{(11+9)} = 10^{20}$	$10^{(-33 + 26)} = 10^{(-7)} \text{ sec}$ 10^{11} neurons x 10^9 TD / neuron 10^{20} Tubulin Dimers in Human Brain
10^{16}	$10^{(-27 + 26)} = 10^{(-1)} \text{ sec} - 10 \text{ Hz}$ Human Alpha EEG is 8 to 13 Hz Fundamental Schumann Resonance is 7.8 Hz Time of Traverse by a String World-Line Quantum Bohmion of a Quantum Consciousness Hamiltonian Circuit of 10^{16} TD separated from nearest neighbors by 10 nm is $10^{16} \times 10 \text{ nm} / c = (10^{16} \times 10^{(-6)}) \text{ cm} / c = 10^{10} \text{ cm} / c = 0.3 \text{ sec}$

Condensate Structure of Higgs and Spacetime

“... The Nambu Jona-Lasinio model ...
 is a theory of Dirac particles with a local 4-fermion interaction and, as such, it belongs to
 the same class of effective theories as the BCS theory of superconducting metals ...
 the Nambu Jona-Lasinio model has very recently been applied to the standard model.
 In this application the Higgs meson is a t \bar{t} top quark mass excitation ...”.

(from Nambu Jona-Lasinio Models Applied to Dense Hadronic Matter, by Georges Ripka,
 in a Workshop on Nuclear Physics, Iguazu Falls, 28 Aug - 1 Sep 1989)

E8 Physics identifies the Higgs with Primitive Idempotents of the Cl(8) real Clifford algebra, so the Higgs is not seen as a simple-minded fundamental scalar particle, but rather the Higgs is seen as a quantum process that creates a fermionic condensate with which it interacts to make the fermions appear massive.

The Primitive Idempotent Higgs is part of my E8 Physics model in terms of which the Primitive Idempotent Higgs is seen to do all the nice things that the fundamental scalar particle Higgs needs to do, and to be effectively a Higgs-Tquark system with 3 mass states.

The conventional Standard Model has structure:
 spacetime is a base manifold;
 particles are representations of gauge groups
 gauge bosons are in the adjoint representation
 fermions are in other representations (analogous to spinor)
 Higgs boson is in scalar representation.

E8 Physics has 248-dim E8 = 120-dim adjoint D8 + 128-dim half-spinor D8) so:
 spacetime is in the adjoint D8 part of E8 (64 of 120 D8 adjoints)
 gauge bosons are in the adjoint D8 part of E8 (56 of the 120 D8 adjoints)
 fermions are in the half-spinor D8 part of E8 (64+64 of the 128 D8 half-spinors).

There is no room for a fundamental Higgs in the E8 of E8 Physics.
 However, for E8 Physics to include the observed results of the Standard Model it must have something that acts like the Standard Model Higgs even though it will NOT be a fundamental particle.

To see how the E8 Physics Higgs works,
 embed E8 into the 256-dimensional real Clifford algebra Cl(8):

Cl(8)	$256 = 1 + 8 + 28 + 56 + 70 + 56 + 28 + 8 + 1$
Primitive Idempotent	$16 = 1 + 6 + 8 + 1$
E8 Root Vectors	$240 = 8 + 28 + 56 + 56 + 28 + 8$

The $Cl(8)$ Primitive Idempotent is 16-dimensional and can be decomposed into two 8-dimensional half-spinor parts each of which is related by Triality to 8-dimensional spacetime and has Octonionic structure. In that decomposition: the $1+6+1 = (1+3)+(3+1)$ is related to two copies of a 4-dimensional Associative Quaternionic subspace of the Octonionic structure and the $8 = 4+4$ is related to two copies of a 4-dimensional Co-Associative subspace of the Octonionic structure (see the book "Spinors and Calibrations" by F. Reese Harvey)

The $8 = 4+4$ Co-Associative part of the $Cl(8)$ Primitive Idempotent when combined with the 240 E_8 Root Vectors forms the full 248-dimensional E_8 .

It represents a Cartan subalgebra of the E_8 Lie algebra.

The $(1+3)+(3+1)$ Associative part of the $Cl(8)$ Primitive Idempotent is the Higgs of E_8 Physics.

The half-spinors generated by the E_8 Higgs part of the $Cl(8)$ Primitive Idempotent represent:

neutrino; red, green, blue down quarks; red, green, blue up quarks; electron
so

the E_8 Higgs effectively creates/annihilates the fundamental fermions and
the E_8 Higgs is effectively a condensate of fundamental fermions.

In E_8 Physics the high-energy 8-dimensional Octonionic spacetime reduces, by freezing out a preferred 4-dim Associative Quaternionic subspace, to a $4+4$ -dimensional Batakis Kaluza-Klein of the form $M_4 \times CP^2$ with 4-dim M_4 physical spacetime.

Since the $(1+3)+(3+1)$ part of the $Cl(8)$ Primitive Idempotent includes the $Cl(8)$ grade-0 scalar 1 and $3+3 = 6$ of the $Cl(8)$ grade-4 which act as pseudoscalars for 4-dim spacetime and the $Cl(8)$ grade-8 pseudoscalar 1

the E_8 Higgs transforms with respect to 4-dim spacetime as a scalar (or pseudoscalar) and in that respect is similar to Standard Model Higgs.

Not only does the E_8 Higgs fermion condensate transform with respect to 4-dim physical spacetime like the Standard Model Higgs but

the geometry of the reduction from 8-dim Octonionic spacetime to $4+4$ -dimensional Batakis Kaluza-Klein, by the Mayer mechanism, gives E_8 Higgs the ElectroWeak Symmetry-Breaking Ginzburg-Landau structure.

Since the second and third fermion generations emerge dynamically from the reduction from 8-dim to 4+4 -dim Kaluza-Klein, they are also created/annihilated by the Primitive Idempotent E8 Higgs and are present in the fermion condensate. Since the Truth Quark is so much more massive than the other fermions,

the E8 Higgs is effectively a Truth Quark condensate.

When Triviality and Vacuum Stability are taken into account,

the E8 Higgs and Truth Quark system has 3 mass states.

As to the Higgs in the E8 physics model

consider a generalized Nambu Jona-Lasinio model in which the Higgs is a Fermion-AntiFermion condensate. As the most massive fermion, the Truth Quark - AntiQuark pairs would be so dominant that the Higgs could be effectively considered as a condensate of Truth Quark - Truth AntiQuark pairs but the detailed picture would be as a condensate of Fermion - Anti-Fermion pairs where there are 24 types of Fermions, each Quark coming in color R, G, or B:

E-Neutrino and Electron
Down Quark (R, G, B) and Up Quark (R, G, B)
M-Neutrino and Muon
Strange Quark (R, G, B) and Charm Quark (R, G, B)
T-Neutrino and Tauon
Beauty Quark (R, G, B) and Truth Quark (R, G, B)

so that there are $24 \times 24 = 576$ Fermion-AntiFermion pairs for each Higgs and each Higgs can be in Bohm Quantum Resonance with 24×24 Bohm Quantum String states: dilaton; antisymmetric Planck-cell group; and symmetric Bohm Quantum Potential.

As to Spacetime in the E8 physics model (viXra 1602.0319),

consider a generalized Nambu Jona-Lasinio model in which 8-dim Classical Lagrangian Spacetime is a condensate of Geoffrey Dixon's 64-dim Particle spinor $T = RxCxHxO = \text{Real} \times \text{Complex} \times \text{Quaternion} \times \text{Octonion}$ and its corresponding 64-dim AntiParticle spinor $Tbar$.

The T - Tbar pairs of the condensate form the 128-dim part of E8 that lives in the $Cl(16)$ Real Clifford Algebra as

248-dim E8 = 120-dim bivector D8 + 128-dim half-spinor D8

By Triality, the $D8 / D4 \times D4 = 64$ -dim part of E8 representing Spacetime is equivalent to T and Tbar, with T representing Fermions and Tbar representing AntiFermions.

Each cell of E8 Classical Lagrangian Spacetime corresponds to 65,536-dim CI(16) which contains 248-dim E8 = 120-dim D8 bivectors +128-dim D8 half-spinors

Human Brain Microtubules 40 microns long have 65,536 Tubulin Dimers

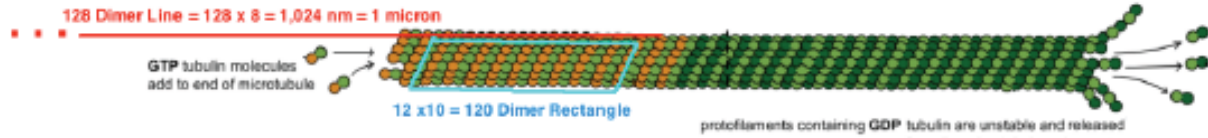

(image adapted from 12biophys.blogspot.com Lecture 11)
and so

can have Bohm Quantum Resonance with CI(16) Spacetime cells

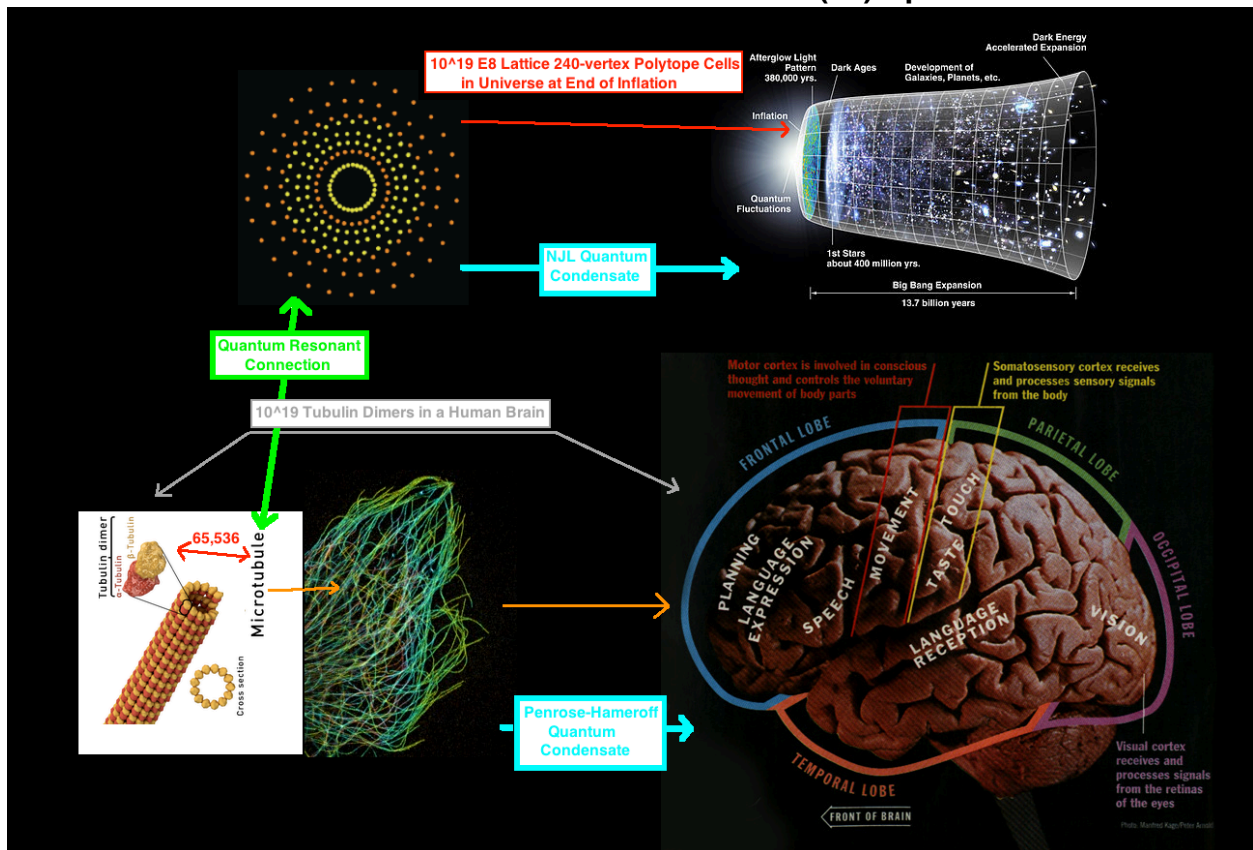

(image from Wikipedia and Time)

so that at any and all Times
the State of Consciousness of a Human
is in exact resonant correspondence with
a subset of the cells of E8 Classical Lagrangian Spacetime

Therefore

E8 Classical Lagrangian Spacetime NJL Condensate is effectively the **Spirit World** in which the **Human States of Consciousness = Souls** exist.

After the death of the Human Physical Body the Spirit World interactions with its Soul are no longer constrained by Physical World interactions with its Body so that the Spirit World can harmonize the individual Soul with the collective Universal Soul by the process of Gehinnom whereby the Soul is prepared for Gan Eden.

End of Inflation and Low Initial Entropy

After the End of Inflation **E8 Physics** has a transition
from 8-dim Octonionic Spacetime to
(4+4)-dim Quaternionic Kaluza-Klein Spacetime $M4 \times CP2$
where $M4$ is 4-dim physical Minkowski Spacetime
and $CP2 = SU(3) / SU(2) \times U(1)$ Internal Symmetry Space
so that
the **Symmetric Space of E8 Physics goes from Octonionic $SO(16)$ or $SO(8,8)$**
to
Quaternionic $Sk(8,H) = SO^*(16)$
therefore Compact $E8(-248)$, with no $SO^*(16)$ symmetry, is no longer useful
and
the useful **Real Forms of E8 for E8 Physics after Inflation** are
NonCompact Split $EVIII E8(8)$ with $E8(8) / Sk(8,H) = E8(8) / SO^*(16)$
and
 $EIX E8(-24)$ with $E8(-24) / Sk(8,H) = E8(-24) / SO^*(16)$

Roger Penrose in his book *The Emperor's New Mind* (Oxford 1989, pages 316-317) said:
"... in our universe ... Entropy ... increases ... Something forced the entropy to be low in
the past. ... **the low-entropy states in the past are a puzzle.** ...".
The key to solving Penrose's Puzzle is given by Paola Zizzi in gr-qc/0007006:
"... **The self-reduction of the superposed quantum state is ... reached at the end of
inflation ...[at]... the decoherence time ... [$T_{decoh} = 10^9 T_{planck} = 10(-34)$ sec] ...
and corresponds to a superposed state of ... [$10^{19} = 2^{64}$ qubits]. ...
... **This is also the number of
superposed tubulins-qubits in our brain ... leading to a conscious event.** ...".
The Zizzi Inflation phase of our universe ends with decoherence "collapse" of
the 2^{64} Superposition Inflated Universe into Many Worlds of Quantum Theory,**

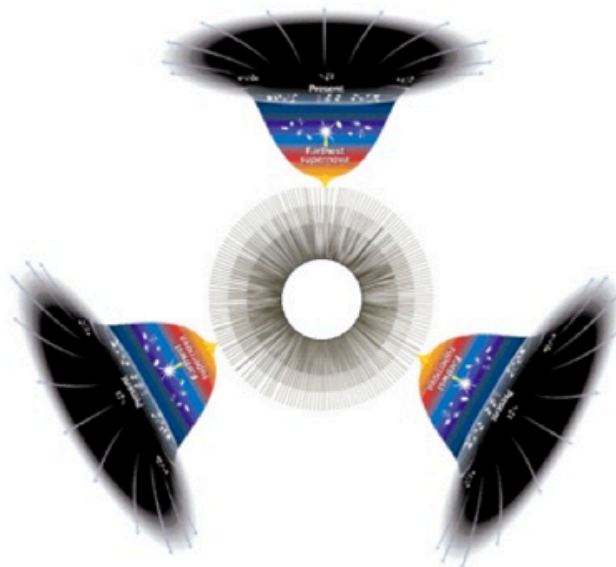

only one of which Worlds is our World. The central white circle is the Inflation Era in

which everything is in Superposition; the boundary of the central circle marks the decoherence/collapse at the End of Inflation; and each line radiating from the central circle corresponds to one decohered/collapsed Universe World (of course, there are many more lines than actually shown), only three of which are explicitly indicated in the image, and only one of which is Our Universe World.

**Since our World is only a tiny fraction of all the Worlds,
it carries
only a tiny fraction of the entropy of the 2^{64} Superposition Inflated Universe,
thus solving Penrose's Puzzle.**

End of Inflation and Quaternionic Structure

In $Cl(1,25)$ E8 Physics (vixra 1405.0030) Octonionic symmetry of 8-dim spacetime is broken at the End of Non-Unitary Octonionic Inflation to Quaternionic symmetry of $(4+4)$ -dim Kaluza-Klein $M4 \times CP2$ physical spacetime x internal symmetry space.

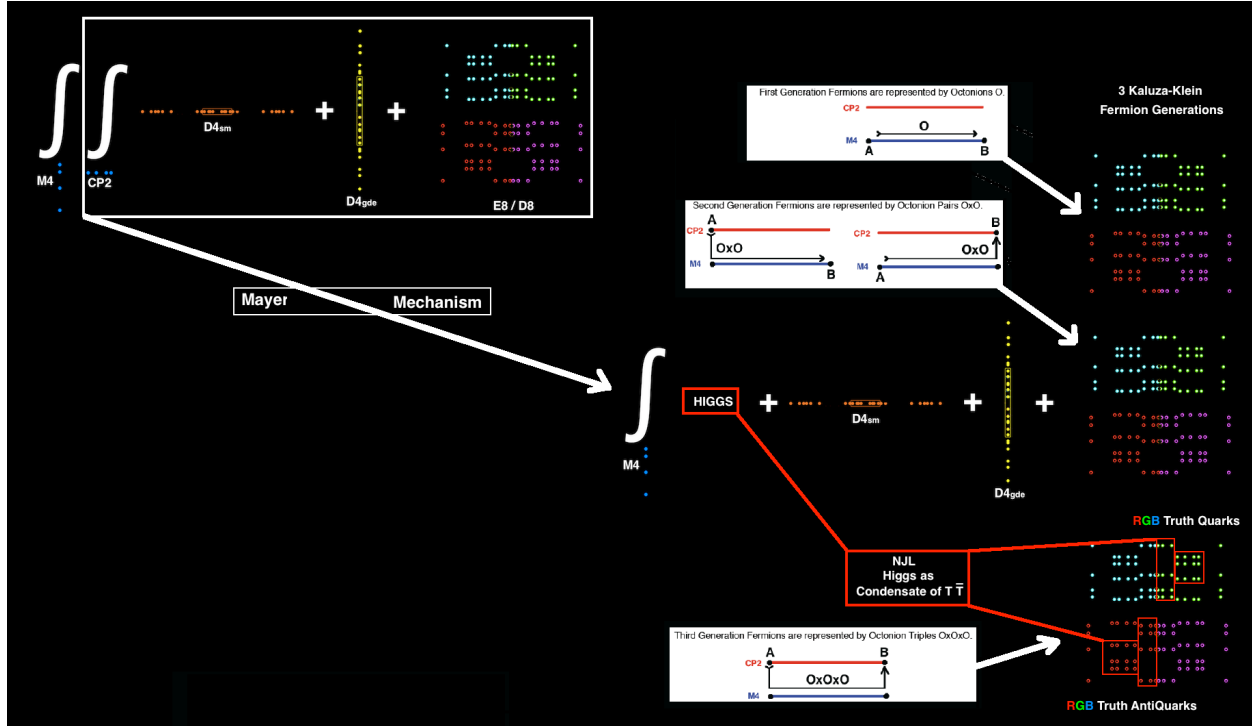

Here are some details about that transition:

The basic local entity of $Cl(1,25)$ E8 Physics is $Cl(1,25)$ which contains $Cl(0,16) = Cl(1,15) = Cl(4,12) = Cl(5,11) = Cl(8,8) = M(R,256) = 256 \times 256$ Real Matrices which contains E8 with 8-dim Octonionic spacetime and is the tensor product $Cl(0,8) \times Cl(0,8) = Cl(1,7) \times Cl(1,7)$ where $Cl(0,8) = Cl(1,7) = M(R,16)$ is the Clifford Algebra of the 8-dim spacetime.

Non-Unitary Octonionic Inflation is based on Octonionic spacetime structure with superposition of E8 integral domain lattices. At the End of Inflation the superposition ends and Octonionic 8-dim structure is replaced by Quaternionic $(4+4)$ -dim structure.

Since $M(R,16) = M(Q,2) \times M(Q,2)$ and $M(Q,2) = Cl(1,3) = Cl(0,4)$
 $Cl(0,8) = Cl(1,7)$ can be represented as $Cl(1,3) \times Cl(0,4)$
 where

$Cl(1,3)$ is the Clifford Algebra for $M4$ physical spacetime
 and

$Cl(0,4)$ is the Clifford Algebra for $CP2 = SU(3) / U(2)$ internal symmetry space
 thus

making explicit the Quaternionic structure of $(4+4)$ -dim $M4 \times CP2$ Kaluza-Klein.

Quaternionic structure similar to that of $Cl(1,3) = Cl(0,4) = M(Q,2)$ is seen in $Cl(2,4) = M(Q,4) = 4 \times 4$ Quaternion matrices with grading based on $4 \times 4 = 1 \ 4 \ 6 \ 4 \ 1$

1	2	1				
4	8	4				
	6	12	6			
		4	8	4		
			1	2	1	
1	6	15	20	15	6	1

$Cl(0,4)$	$M_{16}(C)$	$M_{16}(H)$	$M_{16}(H) \oplus M_{16}(H)$	$M_{16}(H)$	$M_{16}(C)$	$M_{16}(H)$	$M_{16}(H) \oplus M_{16}(H)$	$M_{16}(H)$	$M_{16}(C)$	$M_{16}(H)$	$M_{16}(H) \oplus M_{16}(H)$	$M_{16}(H)$	$M_{16}(C)$	$M_{16}(H)$	$M_{16}(H) \oplus M_{16}(H)$	$M_{16}(H)$	$M_{16}(C)$	$M_{16}(H)$	$M_{16}(H) \oplus M_{16}(H)$	$M_{16}(H)$	$M_{16}(C)$	$M_{16}(H)$	$M_{16}(H) \oplus M_{16}(H)$	$M_{16}(H)$
$M_4(C)$	$M_4(H)$	$M_4(H) \oplus M_4(H)$	$M_4(H)$	$M_{16}(C)$	$M_4(H)$	$M_4(H) \oplus M_4(H)$	$M_4(H)$	$M_{16}(C)$	$M_4(H)$	$M_4(H) \oplus M_4(H)$	$M_4(H)$	$M_{16}(C)$	$M_4(H)$	$M_4(H) \oplus M_4(H)$	$M_4(H)$	$M_{16}(C)$	$M_4(H)$	$M_4(H) \oplus M_4(H)$	$M_4(H)$	$M_{16}(C)$	$M_4(H)$	$M_4(H) \oplus M_4(H)$	$M_4(H)$	
$M_4(H)$	$M_4(H) \oplus M_4(H)$	$M_4(H)$	$M_{16}(C)$	$M_4(H)$	$M_4(H) \oplus M_4(H)$	$M_4(H)$	$M_{16}(C)$	$M_4(H)$	$M_4(H) \oplus M_4(H)$	$M_4(H)$	$M_{16}(C)$	$M_4(H)$	$M_4(H) \oplus M_4(H)$	$M_4(H)$	$M_{16}(C)$	$M_4(H)$	$M_4(H) \oplus M_4(H)$	$M_4(H)$	$M_{16}(C)$	$M_4(H)$	$M_4(H) \oplus M_4(H)$	$M_4(H)$	$M_{16}(C)$	
$M_2(H) \oplus M_2(H)$	$M_4(H)$	$M_4(C)$	$M_2(H)$	$M_2(H) \oplus M_2(H)$	$M_{16}(C)$	$M_2(H)$	$M_2(H) \oplus M_2(H)$	$M_{16}(C)$	$M_2(H)$	$M_2(H) \oplus M_2(H)$	$M_{16}(C)$	$M_2(H)$	$M_2(H) \oplus M_2(H)$	$M_{16}(C)$	$M_2(H)$	$M_2(H) \oplus M_2(H)$	$M_{16}(C)$	$M_2(H)$	$M_2(H) \oplus M_2(H)$	$M_{16}(C)$	$M_2(H)$	$M_2(H) \oplus M_2(H)$	$M_{16}(C)$	
$M_2(H)$	$M_4(C)$	$M_2(H)$	$M_2(H) \oplus M_2(H)$	$M_{16}(C)$	$M_2(H)$	$M_2(H) \oplus M_2(H)$	$M_{16}(C)$	$M_2(H)$	$M_2(H) \oplus M_2(H)$	$M_{16}(C)$	$M_2(H)$	$M_2(H) \oplus M_2(H)$	$M_{16}(C)$	$M_2(H)$	$M_2(H) \oplus M_2(H)$	$M_{16}(C)$	$M_2(H)$	$M_2(H) \oplus M_2(H)$	$M_{16}(C)$	$M_2(H)$	$M_2(H) \oplus M_2(H)$	$M_{16}(C)$	$M_2(H)$	
$M_2(C)$	$M_2(H)$	$M_2(H) \oplus M_2(H)$	$M_4(C)$	$M_4(H)$	$M_4(H) \oplus M_4(H)$	$M_4(H)$	$M_{16}(C)$	$M_2(H)$	$M_2(H) \oplus M_2(H)$	$M_{16}(C)$	$M_2(H)$	$M_2(H) \oplus M_2(H)$	$M_{16}(C)$	$M_2(H)$	$M_2(H) \oplus M_2(H)$	$M_{16}(C)$	$M_2(H)$	$M_2(H) \oplus M_2(H)$	$M_{16}(C)$	$M_2(H)$	$M_2(H) \oplus M_2(H)$	$M_{16}(C)$	$M_2(H)$	
$Cl(2,2)$	$M_2(H) \oplus M_2(H)$	$M_4(C)$	$M_4(H)$	$M_4(H) \oplus M_4(H)$	$M_4(H)$	$M_{16}(C)$	$Cl(2,2)$	$M_4(C)$	$M_4(H)$	$M_4(H) \oplus M_4(H)$	$M_4(H)$	$M_{16}(C)$	$Cl(2,2)$	$M_4(C)$	$M_4(H)$	$M_4(H) \oplus M_4(H)$	$M_4(H)$	$M_{16}(C)$	$Cl(2,2)$	$M_4(C)$	$M_4(H)$	$M_4(H) \oplus M_4(H)$	$M_4(H)$	
$Cl(2,0)$	$M_2(H)$	$M_2(H)$	$M_2(H) \oplus M_2(H)$	$M_4(H)$	$M_4(C)$	$M_4(H) \oplus M_4(H)$	$M_4(H)$	$M_2(C)$	$M_2(H)$	$M_2(H) \oplus M_2(H)$	$M_4(H)$	$M_4(C)$	$M_4(H) \oplus M_4(H)$	$M_4(H)$	$M_2(C)$	$M_2(H)$	$M_2(H) \oplus M_2(H)$	$M_4(H)$	$M_4(C)$	$M_4(H) \oplus M_4(H)$	$M_4(H)$	$M_2(C)$	$M_2(H)$	

Conformal Gravity Spin(2,4) = SU(2,2) of $Cl(2,4) = M(Q,4)$ 4×4 Quaternion Matrices

How does the transition from $SO(16)$ and $SO(8,8)$ to $SO^*(16)$ work ?

Sigurdur Helgason,

in his 1978 book *Differential Geometry, Lie Groups, and Symmetric Spaces*, says: "...

$SO(n, \mathbf{C})$: The group of matrices g in $SL(n, \mathbf{C})$ which leave invariant the quadratic form

$$z_1^2 + \dots + z_n^2 \quad \text{i.e.,} \quad {}^t g g = I_n.$$

$SO(p, q)$: The group of matrices g in $SL(p + q, \mathbf{R})$ which leave invariant the quadratic form

$$-x_1^2 - \dots - x_p^2 + x_{p+1}^2 + \dots + x_{p+q}^2 \quad \text{i.e.,} \quad {}^t g I_{p,q} g = I_{p,q}.$$

We put $SO(n) = SO(0, n) = SO(n, 0)$.

$SO^*(2n)$: The group of matrices in $SO(2n, \mathbf{C})$ which leave invariant the skew Hermitian form

$$-z_1 \bar{z}_{n+1} + z_{n+1} \bar{z}_1 - z_2 \bar{z}_{n+2} + z_{n+2} \bar{z}_2 - \dots - z_n \bar{z}_{2n} + z_{2n} \bar{z}_n.$$

Thus $g \in SO^*(2n) \Leftrightarrow {}^t g J_n \bar{g} = J_n, {}^t g g = I_{2n}$.

... The groups listed above are all topological Lie subgroups of a general linear group ...
The Lie algebra for each of the groups above ... will be denoted by ... small ... letters ...

$\mathfrak{so}(n, \mathbf{C})$: {all $n \times n$ skew symmetric complex matrices},

$\mathfrak{so}(p, q)$: $\left\{ \begin{pmatrix} X_1 & X_2 \\ {}^t X_2 & X_3 \end{pmatrix} \mid \text{All } X_i \text{ real, } X_1, X_3 \text{ skew symmetric of order } p \text{ and } q, \text{ respectively, } X_2 \text{ arbitrary} \right\}$,

$\mathfrak{so}^*(2n)$: $\left\{ \begin{pmatrix} Z_1 & Z_2 \\ -Z_2 & Z_1 \end{pmatrix} \mid Z_1, Z_2 \text{ } n \times n \text{ complex matrices, } Z_1 \text{ skew, } Z_2 \text{ Hermitian} \right\}$,

$$SO^*(2n) \cap U(2n) = SO(2n) \cap Sp(n, \mathbf{C}) = SO(2n) \cap Sp(n) \approx U(n).$$

Robert Gilmore
in his 1974 book Lie Groups, Lie Algebras, and Some of Their Applications, says “...

WEYL UNITARY TRICK. A real space with a signature (N_+, N_-) can be converted to a space with metric $(N_+ + N_-, 0)$ by choosing a new set of bases

$$(\mathbf{e}_1, \mathbf{e}_2, \dots, \mathbf{e}_{N_+}, \mathbf{e}_{N_++1}, \dots, \mathbf{e}_{N_++N_-}) \rightarrow (\mathbf{e}_1, \mathbf{e}_2, \dots, \mathbf{e}_{N_+}, i\mathbf{e}_{N_++1}, \dots, i\mathbf{e}_{N_++N_-}) \quad (3.19)$$

Of course, we have to go outside the field of real numbers to perform this transformation. For example, the space-time of special relativity has metric $(+++ -)$ with respect to the real contravariant bases (x, y, z, ct) but metric $(++++)$ with respect to (x, y, z, ict) . This transformation from a mixed to a positive metric is called the **Weyl unitary trick**. It was apparently first used by Minkowski.

Orthogonal	$SO(n, c)$	(M)	
	$SO(p, q; r)$	$\left[\begin{array}{c c} A & B \\ \hline B^t & C \end{array} \right]$	$\left[\begin{array}{c c} A & \\ \hline & C \end{array} \right]$
	$SO^*(2n)$	$\left[\begin{array}{c c} A & B \\ \hline -B^* & A^* \end{array} \right]$	B
	$SO(n, r)$	(A)	A iB

3. ORTHOGONAL GROUPS. The real and complex orthogonal groups $SO(n, r)$ and $SO(n, c)$ preserve the canonical bilinear symmetric metric $g_{ij} = \delta_{ij}$. By (1.5), their algebras consist of real and complex antisymmetric matrices:

$$\begin{aligned} M &= A^{ij}E_{ij}^{(n)} \\ M^t &= -M \quad A^{ij} = -A^{ji} \end{aligned} \quad (1.20)$$

The complex extension of $SO(n, r)$ is $SO(n, c)$.

The Lie algebra for $SO(p, q; r)$ is related to the Lie algebra for $SO(p + q; r)$ by the Weyl unitary trick:

$$\begin{array}{ccc} \begin{array}{c} \leftarrow p \rightarrow \quad \leftarrow q \rightarrow \\ \uparrow p \\ \downarrow \\ \uparrow q \\ \downarrow \end{array} \left[\begin{array}{c|c} M_{11} & M_{12} \\ \hline -M_{12}^t & M_{22} \end{array} \right] & \begin{array}{c} \text{Weyl} \\ \text{unitary} \\ \rightarrow \\ \text{trick} \end{array} & \begin{array}{c} \leftarrow p \rightarrow \quad \leftarrow q \rightarrow \\ \uparrow p \\ \downarrow \\ \uparrow q \\ \downarrow \end{array} \left[\begin{array}{c|c} M_{11} & iM_{12} \\ \hline -iM_{12}^t & M_{22} \end{array} \right] \\ \mathfrak{so}(p + q; r) & & \mathfrak{so}(p, q; r) \end{array} \quad (1.21)$$

Here M_{11} , M_{22} are the compact subalgebras for $SO(p, r)$ and $SO(q, r)$. The subspace generated by the $p \times q$ matrices M_{12} and iM_{12} are compact generators for $SO(p + q; r)$ and noncompact generators for $SO(p, q; r)$, respectively.

The matrix elements of M_{12} are all real. Under complex extension,

$$SO(p, q; r) \xrightarrow[\text{extension}]{\text{complex}} SO(p, q; c) \quad (1.22)$$

It is easily verified that $SO(p + q; c)$ and $SO(p, q; c)$ have identical Lie algebras. Therefore, the groups $SO(p, q; r)$ are all real forms of the group $SO(p + q; c)$.

The group $SO^*(2n)$ is the subgroup of $SO(2n, c)$ which preserves the sesquilinear antisymmetric metric.¹ With respect to the antisymmetric metric

$$\left[\begin{array}{c|c} & I_n \\ \hline -I_n & \end{array} \right] \quad (1.23)$$

it is easily verified that the Lie algebra of $2n \times 2n$ matrices for $SO^*(2n)$ has the structure

$$\left[\begin{array}{c|c} M_{11} & M_{12} \\ \hline -M_{12}^* & M_{11} \end{array} \right] \quad \begin{array}{l} M_{11} \text{ skew symmetric} \\ M_{12} \text{ hermitian} \end{array} \quad (1.24)$$

It may be easily verified that the complex extension of this algebra is identical to the algebra of $SO(2n, c)$.

A convenient set of bases for the common complex extension is

$$O_{ij}^{(n)} = E_{ij}^{(n)} - E_{ji}^{(n)} = -O_{ji}^{(n)} \quad (1.25)$$

The commutation relations for the generators $O_{ij}^{(n)}$ are given by

$$[O_{ij}^{(n)}, O_{rs}^{(n)}] = O_{is}^{(n)} \delta_{jr} + O_{jr}^{(n)} \delta_{is} - O_{ir}^{(n)} \delta_{js} - O_{js}^{(n)} \delta_{ir} \quad (1.26)$$

6. ORIGIN OF THE EMBEDDING GROUPS $SO^*(2n)$ AND $SU^*(2n)$. The existence of the two unfamiliar "embedding groups" $SO^*(2n)$ and $SU^*(2n)$ as real forms of $SO(2n, c)$ and $Sl(2n, c)$ often comes as a rude shock to aficionados of Lie group theory. The difficulty is further compounded by the lack of a simple explanation for their existence. We present one now.

The group $U(n, c)$ consists of those $n \times n$ complex matrices which preserve the canonical positive definite sesquilinear symmetric metric $g_{ij} = \delta_{ij}$. Each matrix element is a complex number; the Lie algebra obeys

$$M_i^j = -M_j^{i*}$$

There is a canonical representation of the complex numbers by real-valued 2×2 matrices [see Chapter 1, (3.10)]

$$\begin{array}{ccc} re^{i\phi} \rightarrow r \begin{bmatrix} \cos \phi & \sin \phi \\ -\sin \phi & \cos \phi \end{bmatrix} & & \\ \begin{array}{cc} x + iy & (x + iy)^* \\ \downarrow & \downarrow \end{array} & & \\ \begin{bmatrix} x & y \\ -y & x \end{bmatrix} & \begin{bmatrix} x & -y \\ y & x \end{bmatrix} & (1.38) \end{array}$$

Under this representation of the complex numbers, every complex entry in $U(n, c)$ is replaced by a real 2×2 matrix. Since the $2n \times 2n$ real matrices so obtained preserve the metric

$$g'_{ij} = \delta_{ij} \otimes I_2 \quad (1.39c)$$

they form a subgroup of $SO(2n, r)$.

We investigate the Lie algebra of this subgroup under

$$u_i^j \rightarrow r_i^j + ic_i^j \quad (1.40)$$

$$\begin{array}{c} \text{in } C_n \\ \text{in } R_{2n} \end{array} \begin{array}{cc} 1 & 2 \\ 1 & -1 \\ 2 & -2 \end{array} \delta M \rightarrow \begin{array}{c} 1 \\ -1 \\ 2 \\ -2 \\ \vdots \\ \vdots \\ \vdots \end{array} \left[\begin{array}{cc|cc|ccc} 0 & c_1^1 & r_1^2 & c_1^2 & & & \\ -c_1^1 & 0 & -c_1^2 & r_1^2 & & & \\ \hline -r_1^2 & c_1^2 & 0 & c_2^2 & & & \\ -c_1^2 & -r_1^2 & -c_2^2 & 0 & & & \\ \hline \vdots & \vdots & \vdots & \vdots & \vdots & \vdots & \\ \vdots & \vdots & \vdots & \vdots & \vdots & \vdots & \\ \vdots & \vdots & \vdots & \vdots & \vdots & \vdots & \end{array} \right] \quad (1.41)$$

Since the Lie algebra consists of real antisymmetric matrices, it is clearly a Lie subalgebra of $\mathfrak{so}(2n, r)$.

It is useful at this point to rearrange the rows and columns of this matrix:

$$\delta M \rightarrow \begin{array}{c} 1 \\ 2 \\ \vdots \\ \vdots \\ -1 \\ -2 \\ \vdots \\ \vdots \end{array} \left[\begin{array}{ccc|ccc} 1 & 2 & \cdots & -1 & -2 & \cdots \\ 0 & r_1^2 & \cdots & c_1^1 & c_1^2 & \cdots \\ -r_1^2 & 0 & \cdots & c_1^2 & c_2^2 & \cdots \\ \vdots & \vdots & \vdots & \vdots & \vdots & \vdots \\ \vdots & \vdots & \vdots & \vdots & \vdots & \vdots \\ \hline -c_1^1 & -c_1^2 & \cdots & 0 & r_1^2 & \cdots \\ -c_1^2 & -c_2^2 & \cdots & -r_1^2 & 0 & \cdots \\ \vdots & \vdots & \vdots & \vdots & \vdots & \vdots \\ \vdots & \vdots & \vdots & \vdots & \vdots & \vdots \end{array} \right] \quad (1.42)$$

$$= \left[\begin{array}{c|c} A & B \\ \hline -B & A \end{array} \right] \quad \begin{array}{l} B^t = +B \\ A^t = -A \\ A, B \quad \text{real} \end{array} \quad (1.43)$$

The Lie algebra $\mathfrak{so}(2n, r)$ can be written as the direct sum of two vector subspaces $\mathfrak{f} \oplus \mathfrak{p}$:

\mathfrak{f} : The subspace of matrices (1.43), which form a $2n \times 2n$ real matrix representation of $u(n, c)$.

\mathfrak{p} : An orthogonal complementary subspace whose matrices have the general structure

$$\left[\begin{array}{c|c} C & D \\ +D & -C \end{array} \right] \quad \begin{array}{l} C^t = -C \\ D^t = -D \end{array} \quad (1.44)$$

In short, we have the decomposition

$$\begin{aligned} \mathfrak{so}(2n, r) &= u(n, c) \oplus V_{\perp} \\ &= \left[\begin{array}{c|c} A & B \\ -B & A \end{array} \right] \oplus \left[\begin{array}{c|c} C & D \\ D & -C \end{array} \right] \\ &= \mathfrak{f} \oplus \mathfrak{p} \end{aligned} \quad (1.45)$$

It may be verified by direct calculation that the subspaces \mathfrak{f} , \mathfrak{p} obey the commutation relations given symbolically by

$$\begin{aligned} [\mathfrak{f}, \mathfrak{f}] &= \mathfrak{f} \\ [\mathfrak{f}, \mathfrak{p}] &= \mathfrak{p} \\ [\mathfrak{p}, \mathfrak{p}] &= \mathfrak{f} \end{aligned} \quad (1.46)$$









The commutation properties are most easily seen after making a similarity transformation using

$$S = \frac{1}{\sqrt{2}} \left[\begin{array}{c|c} +1I_n & -iI_n \\ \hline -iI_n & +1I_n \end{array} \right] \quad (1.47)$$

$$S \left[\begin{array}{c|c} A & B \\ -B & A \end{array} \right] S^{-1} = \left[\begin{array}{c|c} A + iB & 0 \\ 0 & A - iB \end{array} \right] \quad \begin{array}{l} A^t = -A \\ B^t = +B \end{array} \quad (1.48k)$$

$$S \left[\begin{array}{c|c} C & D \\ D & -C \end{array} \right] S^{-1} = \left[\begin{array}{c|c} 0 & D + iC \\ D - iC & 0 \end{array} \right] \quad \begin{array}{l} C^t = -C \\ D^t = -D \end{array} \quad (1.48p)$$

In this representation, the commutation properties of the matrix vector subspaces are especially easy to compute. The results are indicated in the following diagram:

$[M_1, M_2]$		block diagonal	off diagonal
M_2			
M_1			
	block diagonal	block diagonal	off diagonal
block diagonal			
	off diagonal	off diagonal	block diagonal
off diagonal			

(1.49)

Since $\mathfrak{so}(2n, r)$ is closed under commutation, any block diagonal submatrix arising from commutators belongs to the subalgebra \mathfrak{k} ; any off-diagonal submatrix arising from commutators belongs to the subspace \mathfrak{p} .

If the Weyl unitary trick is now applied to the compact generators in the subspace \mathfrak{p} , they are converted to noncompact generators. Using (1.46), we find that the commutation relations obeyed by \mathfrak{k} and $\mathfrak{p}^* = i\mathfrak{p}$ are

$$\begin{aligned}
 [\mathfrak{k}, \mathfrak{k}] &\subset \mathfrak{k} \\
 [\mathfrak{k}, \mathfrak{p}^*] &= \mathfrak{p}^* \\
 [\mathfrak{p}^*, \mathfrak{p}^*] &= (-)\mathfrak{k}
 \end{aligned}
 \tag{1.46*}$$

Therefore, the matrices $\mathfrak{k} \oplus \mathfrak{p}^*$ are closed under commutation and form the Lie algebra of some noncompact group

$$\begin{aligned}
 \mathfrak{so}^*(2n) &= \mathfrak{k} \oplus i\mathfrak{p} \\
 &= \mathfrak{u}(n, c) \oplus i[\mathfrak{so}(2n, r) \bmod \mathfrak{u}(n, c)]
 \end{aligned}
 \tag{1.50}$$

Comment 1. The subalgebra of matrices in \mathfrak{k} is antihermitian and therefore maps onto a compact group under the EXPOnential mapping. The matrices in the subspace $\mathfrak{p}(\mathfrak{p}^* = i\mathfrak{p})$ are antihermitian (hermitian) and therefore map onto compact (noncompact) cosets. The maximal compact subgroup of $SO^*(2n)$ is $U(n, c)$.

Comment 2. The Lie algebra of $SO^*(2n)$ satisfies the condition (1.24). The group thus obeys the condition giving rise to (1.24) and may be defined accordingly: $SO^*(2n)$ is the subgroup of $SO(2n, c)$ which preserves the sesquilinear antisymmetric metric.

$SU(2, 2) + 1 SO(4, 2)$ $SO(4, 2)$ is one of the groups whose Green's functions 13,14 may give information on the fine structure constant.

13. A. Wyler, L'espace symétrique du groupe des équations de Maxwell, *C.R. Acad. Sci. Paris* **269**, Ser. A, 743-745 (1969).
14. A. Wyler, Les groupes des potentiels de Coulomb et de Yukawa, *C.R. Acad. Sci. Paris* **272**, Ser. A, 186-188 (1971).

which is perhaps the only serious reference in any influential math or physics books to the techniques of Armand Wyler that I use in my E8 Physics.

In summary,
here is how Our Universe Evolved in terms of my E8 Physics model:

When Our Planck Scale Universe emerged from its Parent Universe by Quantum Fluctuation it was described by $SO(16)$ symmetry of Compact $E8(-248)$.

When Our Universe was expanding rapidly during Octonionic Non-Unitary Inflation it unfolded from Finite Elliptic Compact to Infinite Hyperbolic NonCompact $SO(8,8)$ symmetry of NonCompact Split $E8(8)$. That transition was a shifting of $SO(16)$ symmetry from $E8(-248)$ to $E8(8)$ followed by a Weyl Unitary Trick within $E8(8)$ from $SO(16)$ to $SO(8,8)$.

When Inflation ended 8-dim Octonionic Spacetime was broken into (4+4)-dim Unitary Quaternionic $M4 \times CP2$ Kaluza-Klein Spacetime with $SO^*(16)$ symmetry of $E8(-24)$. That transition was a Weyl Unitary Trick within $E8(8)$ from $SO(8,8)$ to $SO^*(16)$ followed by a shifting of $SO^*(16)$ symmetry from $E8(8)$ to $E8(-24)$.

In resulting E8 Physics model, the geometry of E8 defines a realistic Classical Local Lagrangian. Since E8 is embedded in the Real Clifford Algebra $Cl(16) = Cl(8) \times Cl(8)$, 8-Periodicity allows construction of a generalized Hyperfinite II1 von Neumann factor by taking the completion of the union of all tensor products of $Cl(16)$ which is an Algebraic Quantum Field Theory (AQFT) that is naturally compatible with the realistic E8 Lagrangian. Therefore E8 Physics, which allows calculation of Force Strength and Particle Mass ratios, etc, using the basic ideas of Armand Wyler, fulfills the prediction of Robert Gilmore in his 1974 "long and difficult" book:

? (1970-)).

It now

seems possible that Lie group theory, together with differential geometry, harmonic analysis, and some devious arguments, might be able to predict some of Nature's dimensionless numbers (α , m_p/m_e , m_μ/m_e , G^2/hc , ...). In retrospect, it seems clear that the application of group theory to physical problems represents the dividing line between kinematics and dynamics. The group theory gives the overall structure of the spectrum; the dynamics serves to define only the scale. We are looking forward to the day when Lie groups can be pushed to give also the dynamics, or scale.

Higgs and 3-state Higgs-Tquark Sysytem

Quaternionic $SO^*(16)$ structure breaks 8-dim Spacetime Octonionic Symmetry to Quaternionic (4+4)-dim Associative x CoAssociative Kaluza-Klein Spacetime

(see Reese Harvey “Spinors and Calibrations” (Academic 1990))

where M_4 = 4-dim Minkowski Physical Spacetime is Associative

and $CP^2 = SU(3) / SU(2) \times U(1)$ Internal Symmetry Space is CoAssociative

Meinhard Mayer said (Hadronic Journal 4 (1981) 108-152): “... each point of ... the ... fibre bundle ... E ...

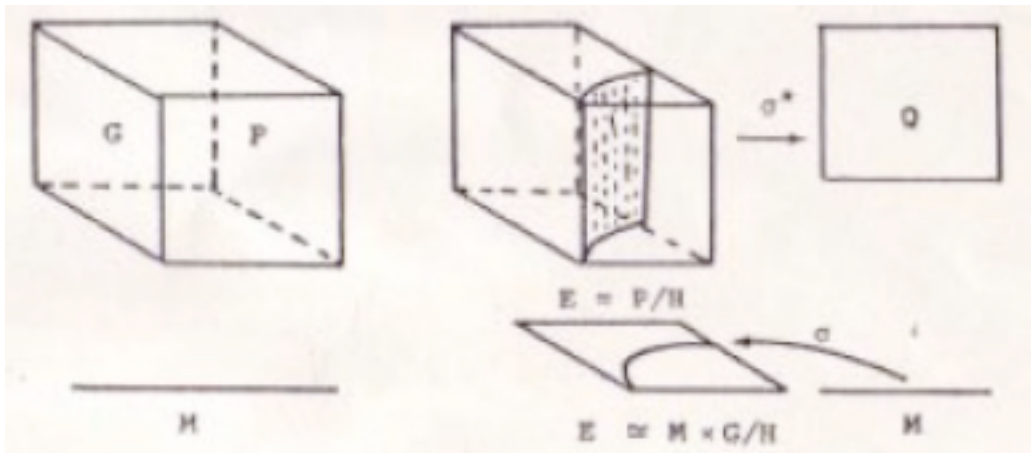

... consists of

a four- dimensional spacetime point x [in M_4]

to which is attached the homogeneous space G / H [$SU(3) / U(2) = CP^2$]

...

the components of the curvature lying in the homogeneous space G / H could be reinterpreted as Higgs scalars (with respect to spacetime [M_4])

...

the Yang-Mills action reduces to a Yang-Mills action for the h -components [$U(2)$ components] of the curvature over M [M_4] and a quartic functional for the “Higgs scalars”, which not only reproduces the Ginzburg-Landau potential, but also gives the correct relative sign of the constants, required for the BEHK ... Brout-Englert-Higgs-Kibble ... mechanism to work. ...”.

Here are some details of the Mayer Higgs Mechanism:

Excerpts from:

Meinhard Mayer and A. Trautman in
“A Brief Introduction to the Geometry of Gauge Fields”
and
Meinhard Mayer in
“The Geometry of Symmetry Breaking in Gauge Theories”,
Acta Physica Austriaca, Suppl. XXIII (1981))

and

Shoshichi Kobayashi and Katsumi Nomizu in
“Foundations of Differential Geometry Vol. I”,
Interscience (1963)

New Developments in Mathematical Physics

Edited by

Heinrich Mitter and Ludwig Pittner, Graz

A BRIEF INTRODUCTION TO THE GEOMETRY OF GAUGE FIELDS
M. E. Mayer and A. Trautman

THE GEOMETRY OF SYMMETRY BREAKING IN GAUGE THEORIES
M. E. Mayer

GEOMETRIC ASPECTS OF QUANTIZED GAUGE THEORIES
M. E. Mayer

With 54 Figures

1981

Springer-Verlag
Wien New York



FOREWORD

The papers contained in this volume are lectures and seminars presented at the 20th "Universitätswochen für Kernphysik" in Schladming in February 1981. The goal of this school was to review some rapidly developing branches in mathematical physics. Thanks to the generous support provided by the Austrian Federal Ministry of Science and Research, the Styrian Government and other sponsors, it has been possible to keep up with the - by now already traditional - standards of this school. The lecture notes have been reexamined by the authors after the school and are now published in their final form, so that a larger number of physicists may profit from them. Because of necessary limitations in space all details connected with the meeting have been omitted and only brief outlines of the seminars were included. It is a pleasure to thank all the lecturers for their efforts, which made it possible to speed up the publication. Thanks are also due to Mrs. Krenn for the careful typing of the notes.

H.Mitter

L.Pittner

A BRIEF INTRODUCTION TO THE GEOMETRY OF GAUGE FIELDS[†]

by

M. E. MAYER

Dept. of Physics, Univ. of California
Irvine, California, 92717, USA

and

A. TRAUTMAN

Inst. of Theoretical Physics, Warsaw Univ.
Hoża 69, OO-681 Warsaw, Poland

1. INTRODUCTION

In view of the common background required for the understanding of the lectures of both authors, and in order to avoid unnecessary duplications, we have decided to present jointly this brief introduction to the language and properties of fiber bundles. By now the advantages of the fiber-bundle formulation of gauge field theories have led to a widespread acceptance of this language, and a number of reviews of the subject have appeared or are in course of publication. These, together with a number of standard textbooks are listed in the references to this

[†]Lectures given at the XX. Internationale Universitätswochen für Kernphysik, Schladming, Austria, February 17 - 26, 1981.

introduction. Nevertheless, we felt that it would be convenient for the reader of these proceedings to have at his disposal a summary of the basic facts. We also tried to clarify a number of concepts and propose an acceptable terminology wherever a standard has not been established in the literature. This refers, in particular, to the terms gauge transformation, pure gauge transformation, and the related (infinite-dimensional) groups as well as to the concepts of extension, prolongation, restriction, and reduction of bundles, which are used with slightly varying meaning in different texts.

In the oral presentation most of the general background material was presented by Andrzej Trautman, and the material related to reduction and symmetry of connections was given in Meinhard Mayer's lectures. Little, if anything, in this introduction is original. The actual text has been written in California by the first author and slightly revised by the second during his stay in France after the Schladming meeting.

No detailed proofs are given here, but wherever possible illustrations and examples are used to make the concepts plausible to physicists. Many proofs are straightforward and can be carried out by introducing local coordinates and bases. However, we recommend to the reader who wants to become familiar with the spirit of modern, coordinate-free, differential geometry to try to stay away from bases and indices as much as possible.

It is easy to see that the orbit space of P under the action of the subgroup H of G , P/H , can be identified with the associated bundle E . Denoting by γ the canonical projection of G onto G/H , we can set for $p \in P$, $\delta(p) = p \cdot \gamma(e)$, where e is the identity of G . The mapping $\delta: P \rightarrow E$ is a projection for the new principal bundle (P, H, E, δ) over the larger base $E = P \times_G G/H$ which is canonically identified with the orbit space P/H (this is illustrated in Fig. 4, in the middle).

Let now $\sigma: M \rightarrow E$ denote a section of E and $\sigma^*: (P, H, E, \delta) \rightarrow (Q, H, M, \rho)$ the pullback (induced bundle) of this map. It is obvious (cf. Fig. 4, right) that this is now a principal bundle with structure group H over M , and its extension to G is isomorphic to the original bundle P . Two different sections σ_1 and σ_2 of E will define isomorphic restrictions iff they are mapped into each other by a pure gauge transformation (G - M -automorphism) of P . Otherwise different sections of E determine different (nonisomorphic) restrictions.

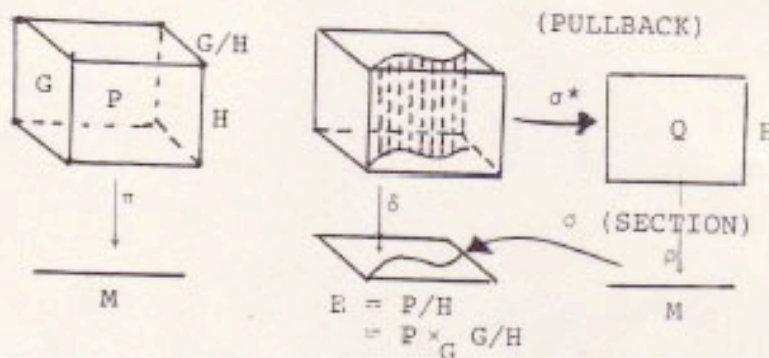

Fig. 4

6. INVARIANCE AND SYMMETRIES OF CONNECTIONS

In spite of the fact that conditions for the invariance of a connection have been discussed in the mathematical literature over twenty years ago, and Wang's theorem can be found in textbooks, physicists rediscovered them only in 1978-79. This section contains a brief survey of this topic, which has been discussed from a more physical point of view by Jackiw in last year's Schladming lectures.

The problem is quite simple when viewed globally, on the principal bundle; complications arise only when one tries to express the invariance conditions for the connection forms on local trivializations of P .

Before discussing connections we summarize the definitions of gauge transformations to be used. An isomorphism of a principal bundle onto itself is called an automorphism of the bundle. Such an automorphism consists of a pair of diffeomorphisms (u,v) of P and M such that $\pi \circ u = v \circ \pi$ (Eq. (3.1)), and $u(p \cdot g) = u(p) \cdot g$ for all $p \in P$, $g \in G$. An automorphism is called vertical if $v = \text{Id}_M$. If we denote the group of all automorphisms (an infinite-dimensional group) by $\text{Aut } P$, the subgroup of all vertical automorphisms $\text{Aut}_M P$ is a normal subgroup, the quotient being the group of all diffeomorphisms of M onto itself, i.e., we have the exact sequence of homomorphisms:

$$I \rightarrow \text{Aut}_M P \xrightarrow{i} \text{Aut } P \xrightarrow{j} \text{Diff } M \rightarrow I, \quad (6.1)$$

where i is the canonical injection and $v = j(u)$. If $u \in \text{Aut}_M P$, its action is in the fiber and therefore can be implemented by an element $U(p)$ of G such that for any p in P and g in G

$$u(p) = p \cdot U(p), \quad U(p \cdot g) = g^{-1} U(p) g. \quad (6.2)$$

Thus, there is a natural isomorphism of $\text{Aut}_M P$ onto the multiplicative group of (smooth) maps $U : P \rightarrow G$, subject to the equivariance condition (6.2), or equivalently, to sections of the associated bundle $P \times_{\text{Ad}G} G$ with fibers G , but the right action replaced by the adjoint action.

The group $\text{Aut} P$ (as well as $\text{Aut}_M P$) acts on (local) sections of P in the following manner: if $s : V \rightarrow P$ (V an open subset of M), then its transform is $s' = u \circ s \circ v^{-1}$. If $u \in \text{Aut}_M P$, the subset V of M is left invariant and the section is subject to what a physicist would call a gauge transformation:

$$s'(x) = s(x) \cdot U(s(x)), \quad x \in V \subset M. \quad (6.3)$$

If one deals only with Yang-Mills fields over a flat spacetime (or a Euclidean, compact version thereof) one is thus entitled to identify $\text{Aut}_M P$ with the group of gauge transformations (this is the definition adopted by Atiyah, Singer, and many other mathematicians). However, in theories involving gravity, or other structures on spacetime, it is convenient to introduce a further differentiation.

Definition. The gauge group of a theory in which the bundle has some absolute elements, such as the metric tensor of special relativity, or some other structure element of P or M , is the subgroup \mathcal{G} of $\text{Aut} P$ such that the diffeomorphism v and the projection preserve the absolute elements of M . The group of pure gauge transformations consists of the vertical automorphisms in \mathcal{G} ; this group will be denoted by $\mathcal{G}_0 = \mathcal{G} \cap \text{Aut}_M P$, it is a normal subgroup of \mathcal{G} , and the quotient $\mathcal{G}/\mathcal{G}_0$ in the exact sequence

$$1 \rightarrow \mathcal{G}_0 \xrightarrow{i} \mathcal{G} \xrightarrow{j} \mathcal{G}/\mathcal{G}_0 \rightarrow 1 \quad (6.4)$$

is the subgroup of $\text{Diff } M$ leaving the absolute elements invariant (e.g., if M is Minkowski space, $\mathfrak{G}/\mathfrak{G}_0$ is the Poincaré group; this corresponds to the necessity of sometimes combining a gauge transformation with a change of Lorentz frame in some calculations).

Invariance of connections under automorphisms of the bundle P is simply expressed as the fact that the pullback of the connection form ω on P by the mapping $u \in \text{Aut } P$, $\omega' = u^*\omega$ is again a connection form on P . If u is a vertical automorphism (in particular, a pure gauge transformation), then

$$\omega' = \text{Ad}(U^{-1}(p))\omega + U^{-1}(p)dU(p) , \quad (6.5)$$

where $U(p)$ is the map defined in Eq.(6.2). We see that the form ω is subject to the usual gauge transformation of a gauge potential (albeit, on P rather than on M). The curvature form Ω' of the pullback $u^*\omega$ is given by the adjoint action of $U(p)$ on the original curvature form:

$$\Omega' = \text{Ad}(U^{-1}(p))\Omega . \quad (6.6)$$

The equations (6.5), (6.6) can easily be pulled down to the forms A, F on the base space given by a locally trivializing section s . Here one can either pull ω back to M by the transformed section, or pull ω' back by the original section, obtaining the usual gauge transformation formulas for A and F :

$$A' = \text{Ad}(S^{-1})A + S^{-1}dS , \quad F' = \text{Ad}(S^{-1})F , \quad (6.7)$$

where $S = U \circ s$.

Among the automorphisms of the principal bundle P with a connection ω and the associated bundles carrying the particle fields, symmetries are distinguished by the

fact that they preserve the connection ω and the absolute elements of the theory (e.g., they preserve the action, or they modify the Lagrangian density by a divergence). In particular, a symmetry of a gauge theory is a gauge transformation (in the wider sense defined above) which leaves the connection form ω invariant (in addition to the other absolute elements):

$$u^*\omega = \omega, \quad u^*\Omega = \Omega \quad ; \quad (6.8)$$

since a nonabelian gauge theory is not completely determined by the curvature, it is not sufficient to require invariance only of the curvature form.

When this condition is pulled back by a local trivialization to the base space, it will usually be formulated as the requirement that the one-form A be unchanged up to a pure gauge transformation, or in other words, a gauge field is invariant under a symmetry, if the symmetry transformation can be compensated by a gauge transformation of the locally trivializing section (this is the formulation given by Bergmann and Flaherty, Trautman, Jackiw, and other authors).

To write the invariance condition (6.8) for the physical fields A, F , we consider first a one-parameter group $u_t : \mathbb{R} \rightarrow \text{Aut } P$ of automorphisms of P . Let Y denote the corresponding vector field on P , and X the projection of Y onto M :

$$X = \pi_* Y \quad . \quad (6.9)$$

The vector field X generates a one-parameter group $v_t = j(u_t)$ of transformations on M . Let ω be a u_t -invariant connection on P ,

$$u_t^*\omega = \omega, \quad u_t^*\Omega = \Omega \quad . \quad (6.10)$$

For an arbitrary point p_0 in P the groups u_t, v_t define curves in P, M , respectively:

$$p_t = u_t(p_0), \quad x_t = v_t(\pi p_0) = \pi(p_t). \quad (6.11)$$

The connection defines a horizontal lift of x_t which we denote by h_t . Then it is obvious that $p_t = h_t g_t$ for a suitable element g_t of G , and g_t is a one-parameter Lie subgroup of G , generated by the Lie algebra element $T = \omega_{p_0}(Y)$. The invariance of the connection and its curvature on P can be expressed infinitesimally as the vanishing of their Lie derivatives with respect to Y :

$$L_Y \omega = 0, \quad L_Y \Omega = 0. \quad (6.12)$$

(Recall that for forms the Lie derivative is defined by $L_Y = d \circ Y \rfloor + Y \rfloor \circ d$, where \rfloor denotes the interior product of Y with the differential form following the sign.)

The expressions (6.12) for the invariance of connections are identical to the usual conditions for the invariance of fields encountered in physics, but hidden behind the simple form is the gauge freedom inherent in the theory, particularly if one works in terms of the pullbacks A, F , to the base space. If we denote the value of the one-form ω_p (at the point p in P) on the vector field Y at p by $Z = \omega_p(Y)$, we obtain an equivariant map of P into the Lie algebra $Z : P \rightarrow \mathfrak{G}$, $Z \circ R_g = \text{Ad}(g^{-1}) \circ Z$. Its covariant exterior differential

$$DZ = dZ + [\omega, Z] \quad (6.13)$$

is a horizontal one-form (with values in \mathfrak{G}) of type Ad , and the definition of the Lie derivative and Eq.(6.14) yield the detailed form of the invariance condition:

$$L_Y \omega = Y \lrcorner \Omega + DZ = 0, \quad L_Y \Omega = D(Y \lrcorner \Omega) + [\Omega, Z] = 0 \quad (6.14)$$

(Trautman, 1979). If we use a local section s to pull back the connection and curvature to the gauge potential A , and the field strength F on M , the vector field Y is to be replaced by the generator X of the transformations in M , and the Lie-algebra-valued function on P , Z , defines a function on M , $\phi = Z \circ s : M \rightarrow \mathfrak{G}$. Then the invariance conditions for A and F under the symmetry induced on M by the vector field X (such a vector field always has a horizontal lift under the given connection; adding an arbitrary vertical vector field of the type of Z to it, will give a field on P) can be written in the form

$$X \lrcorner F + D\phi = 0 \quad (6.15)$$

where $D\phi = d\phi + [A, \phi]$, and

$$D(X \lrcorner F) + [F, \phi] = 0. \quad (6.16)$$

In terms of the potential one-form A the invariance condition can be rewritten as $L_X A = DW(X)$, where $W(X)$ differs from ϕ by the zero-form $-X \lrcorner A$. The right-hand side of the last equation has the infinitesimal form of a gauge transformation, and under a change of chart (gauge transformation) with transition functions g_{ij} the function W is subject to the transformation

$$W_j = \text{Ad}(g_{ij}^{-1}) W_i + g_{ij}^{-1} X \lrcorner dg_{ij}. \quad (6.17)$$

If X_1 and X_2 denote two vector fields on M inducing symmetries of the connection A , then consistency requires that

$$2F(X_1, X_2) = \phi([X_1, X_2]) - [\phi(X_1), \phi(X_2)], \quad (6.18)$$

where the left-hand side denotes the value of the two-form

F on the two vector fields X_1, X_2 , and the right-hand side expresses the dependence of the G -valued 0-form on the vector field X_1 (and implicitly, on the trivializing section s). The infinitesimal forms of the invariance conditions have been independently discovered by Forgacs and Manton, Harnad, Shnider and Vinet, and Jackiw (cf. the bibliography to Mayer's contribution for references), and the usefulness of Eqs. (6.15), (6.18) (with a difference in sign) has been discussed in Jackiw's 1980 Schladming lectures.

To end this section we give, for the convenience of the reader, a brief statement of Wang's theorems on invariant connections, in a notation which is close to the one used by Kobayashi and Nomizu, where the detailed proofs can be found.

Consider, as before, a principal bundle $P(M, G)$, with a connection ω which is invariant with respect to a group of automorphisms K of $P(M, G)$, assumed to be a connected Lie group with fiber-transitive action, i.e., for any two fibers there is an element of K which maps one into the other, hence K acts transitively on the base space M . We denote by u_0 a reference point in P , chosen once and for all, and by x_0 its projection in M , $x_0 = \pi(u_0)$. Furthermore we denote by J the isotropy subgroup of K at x_0 , i.e., the subgroup of all transformations in K which leave x_0 invariant (it is clear that M can then be viewed as the homogeneous space K/J). We denote the Lie algebras of the groups G, K, J by $\mathfrak{g}, \mathfrak{k}, \mathfrak{j}$, respectively and, when it exists, the subspace of \mathfrak{k} complementary to \mathfrak{j} by \mathfrak{m} : $\mathfrak{k} = \mathfrak{j} \dot{+} \mathfrak{m}$ (direct sum). Then we define a linear mapping $\Lambda : \mathfrak{k} \rightarrow \mathfrak{g}$ by $\Lambda(X) = \omega_{u_0}(X)$, where $X \in \mathfrak{k}$ and \hat{X} is the vector field on P induced by X , which has the properties

(i) $\Lambda(X) = \lambda_{x_0}(X)$ for $X \in \mathfrak{j}$; here λ_{x_0} is the homomorphism $\lambda_{x_0} : \mathfrak{j} \rightarrow \mathfrak{g}$ defined as the differential of the homomorphism

$\lambda : J \rightarrow G$, which assigns an element $g \in G$ taking the point u_0 into the same point as the left action of $j \in J : ju_0 = u_0g : g = \lambda(j)$;

(ii) for $j \in J$ and $X \in \mathfrak{k}$, $\Lambda(\text{Ad}(j)(X)) = \text{Ad}(\lambda(j))(\Lambda(X))$, where $\text{Ad}(j)$ is the adjoint action of J on \mathfrak{k} and $\text{Ad}(\lambda(j))$ is that of G on \mathfrak{g} . The geometric meaning of these homomorphisms should be clear from our discussion of the lifting of the horizontal projection of any one-parameter group of automorphisms given by Eq.(6.11) and the discussion following it. Note that u_0 denotes our previous p_0 (and not the value of the automorphism at $t = 0$), and the vertical action $\lambda(j)$ is the same as the previous g_t .

It is easy to verify, by using the definition of curvature (the structure equation), that the curvature form Ω satisfies the condition (from which Eq.(6.18) follows by pullback to M):

$$2\Omega_{u_0}(\tilde{X}, \tilde{Y}) = [\Lambda(X), \Lambda(Y)] - \Lambda([X, Y]), \text{ for } X, Y \in \mathfrak{k}. \quad (6.19)$$

What Wang's theorem asserts is the existence of a bijection between the set of K -invariant connections in P and the set of linear mappings $\Lambda : \mathfrak{k} \rightarrow \mathfrak{g}$ satisfying the conditions listed above, bijection which is given by

$$\Lambda(X) = \omega_{u_0}(X), \text{ for } X \in \mathfrak{k}. \quad (6.20)$$

The proof is straightforward and can be found, e.g., in Kobayashi and Nomizu (p.107, with the same notations as here).

It also follows immediately that a K -invariant connection is flat (i.e., has vanishing curvature) iff $\Lambda : \mathfrak{k} \rightarrow \mathfrak{g}$ is a Lie algebra homomorphism (since then the right-hand side of Eq.423^{6.19} vanishes, and hence so does the left-hand side).

Moreover, if in addition the Lie subalgebra \mathfrak{j} admits a complementary subspace \mathfrak{m} in \mathfrak{k} such that $\text{Ad}(J)(\mathfrak{m}) = \mathfrak{m}$, then there is a bijection between the set of K -invariant connections in P and the set of linear mappings $\Lambda_{\mathfrak{m}} : \mathfrak{m} \rightarrow \mathfrak{g}$, such that for $X \in \mathfrak{m}$, $j \in \mathfrak{j}$ we have $\Lambda_{\mathfrak{m}}(\text{Ad}(j)(X)) = \text{Ad}(\lambda(j))(\Lambda_{\mathfrak{m}}(X))$, with the bijection given in terms of the Λ defined above by $\Lambda(X) = \lambda(X)$ if $X \in \mathfrak{j}$, and $\Lambda(X) = \Lambda_{\mathfrak{m}}(X)$ if $X \in \mathfrak{m}$. The curvature form of the K -invariant connection defined by the linear mapping $\Lambda_{\mathfrak{m}}$ satisfies the following condition:

$$2\Omega_{u_0}(X, Y) = [\Lambda_{\mathfrak{m}}(X), \Lambda_{\mathfrak{m}}(Y)] - \Lambda_{\mathfrak{m}}([X, Y]_{\mathfrak{m}}) - \lambda([X, Y]_{\mathfrak{j}}),$$

$$X, Y \in \mathfrak{m},$$

where the subscripts on the brackets denote components in the corresponding subspaces of the algebra \mathfrak{k} where the bracket is originally defined. If $\Lambda_{\mathfrak{m}} = 0$ then the corresponding invariant connection is called the canonical invariant connection with respect to the decomposition $\mathfrak{k} = \mathfrak{j} \dot{+} \mathfrak{m}$. Physically, this corresponds to choosing the gauge functions Z and the connection A in eqs. (6.13) - (6.18) so that the components of ϕ in the subspace \mathfrak{m} , corresponding to the given decomposition, should vanish.

It is to be noted that the existence of a complementary subspace \mathfrak{m} invariant under the adjoint action of J is equivalent to the reductivity of the homogeneous space $K/J = M$, a rather restrictive condition on the base space M .

Finally, it should be noted that the Lie algebra of the holonomy group of a K -invariant connection at u_0 is defined by a sum of iterated brackets of $\Lambda(\mathfrak{k})$ with the subspace \mathfrak{m}_0 of \mathfrak{g} spanned by the right-hand side of eq. (6.19) (for details we refer the reader again to Kobayashi-Nomizu, p.110-111).

THE GEOMETRY OF SYMMETRY BREAKING IN GAUGE THEORIES⁺

by

M. E. MAYER

Department of Physics, Univ. of California
Irvine, California, 92717, USA

ABSTRACT

This together with Sections 3 and 6 of the joint contribution with A. Trautman (this volume, pp. 433 to be referred to as Mayer-Trautman) constitutes a summary of the first two lectures. Much of the material is available elsewhere [1], so only results and some open questions are discussed. The subject matter of the second two lectures is treated in the following contribution (pp. 491).

1. INTRODUCTION

The motivation of these lectures is a search for an alternative to the traditional Brout-Englert-Higgs-Kibble (BEHK) method of symmetry breaking in gauge theories, based on the geometry of principal bundles with connections. In the BEHK approach the action of the classical theory of a Dirac or Weyl field interacting with a Klein-Yang-Mills field A, F is

⁺Lectures given at the XX. Internationale Universitätswochen für Kernphysik, Schladming, Austria, February 17-26, 1981.

$$S_{\text{DYM}} = \frac{1}{4} \int_M \text{Tr} F \wedge *F + \int_M * \{ \psi \not{\partial} \psi \} , \quad (1.1)$$

where M denotes the spacetime base manifold of the bundles, F is the Yang-Mills field strength two-form on M (the pull-down of the curvature two-form to M , cf. Mayer-Trautman, Eq.(4.12)), $*$ is the Hodge-dual on M , ψ denotes a Dirac or Weyl spinor which transforms under a representation of the structure group G (a local representation of a section in a tensor product of a spin bundle and a vector bundle associated to the gauge principal bundle P by that representation). $\not{\partial}$ denotes the "gauge-covariant Dirac-Weyl operator" (in coordinates, with e_a a basis for the representation of the Lie algebra G , in which I denotes the unit matrix, and γ^μ the usual Dirac matrices) $\not{\partial} = I \not{\partial} + A_\mu^a \gamma^\mu e_a$. In order to produce the symmetry breaking, leading to a restriction of the original bundle P to a subbundle $Q(M, H)$, the BEHK model introduces "by hand" a scalar field ϕ which represents a section of an associated bundle (or a smooth function on P with values in some representation space V of G , cf. Mayer-Trautman, Eq.(2.5)), which is supposed to be an extremal of the Ginzburg-Landau action:

$$S_{\text{GL}} = \int D\phi \wedge *D + V[\phi], \quad V[\phi] = -\mu \|\phi\|^2 + \lambda \|\phi\|^4 , \quad (1.2)$$

where the norms in the Ginzburg-Landau functional V are to be understood as the result of integration over M of the hermitian norm in V . For positive λ, μ the functional V has nontrivial critical points ϕ_0 and the stabilizer subgroup of these is H , the symmetry group of the "vacuum" to which the bundle is then restricted. Reducing the connection form A and the curvature form F to the corresponding Lie algebra \mathfrak{h} , one can choose a gauge in which the terms involving the nonvanishing ϕ_0^2 in (1.2) appear like "mass terms" for the components of A in the complement $\mathfrak{m} = \mathfrak{g} - \mathfrak{h}$ of the Lie algebra of H in that of G , thus leading to a loss of con-

formal invariance for the appropriate Yang-Mills equations. The surviving Higgs fields and the fermions are also acquiring "masses" by this mechanism. For details of this and other aspects of traditional symmetry breaking the reader is referred to the review by O'Raiifeartaigh [2] where further references can be found.

A closer look at the BEHK mechanism (and this will partially be true of the geometric models discussed in this lecture too) shows that the presence of the Ginzburg-Landau potential is not really at the heart of the matter. The scalar field and the quartic interaction were chosen because they lead to a renormalizable quantum theory and are the simplest combination which does the job. In effect, the reason why they do the job is revealed by a careful analysis of group actions on manifolds, particularly of pairs of groups such as G and H , and their homogeneous spaces G/H . Such an analysis was carried out in other contexts of symmetry breaking by Michel and Radicati [3] over a decade ago, and a good summary can be found in Ref.[2]. It turns out that if one is given G and H , there are relatively few invariants which lead to the desired physical results, among them the Ginzburg-Landau action.

The same remarks apply, *mutatis mutandis*, to the orbit structure of the associated bundles $E(M,P,G/H,p)$ discussed below in symmetry breaking models. In fact, the symmetry breaking sections should appear from a detailed analysis, in the spirit of Michel and Radicati, of the orbits and strata of group actions in these bundles. There does not seem to exist in the literature an explicit discussion of this topic, and it was hoped that such a discussion could be included here. However, time pressure forced me to defer this to a future publication.

Until recently, Higgs fields were considered almost sacrosanct, but the view that they really exist (and the

appropriate particles should indeed manifest themselves experimentally) is becoming less widely held. Many of us who were not satisfied by the artificial introduction of the Higgs fields have been searching for alternatives to the introduction of the Higgs bosons, yielding the same results which made this model so appealing and successful in the electroweak unification, and in all grand unified gauge theories. I will not discuss theories in which the Higgs scalars are treated as bound states of more elementary fermions, or metric theories of the Kaluza-Klein type (for an interesting recent attempt to obtain the putative $SU(3) \times SU(2) \times U(1)$ symmetry of strong and electroweak interactions, I refer the reader to a recent paper by Witten [4]) but will describe briefly two "geometric" approaches to the problem which can be described in the language of bundle restrictions (cf. Mayer-Trautman, Secs. 3 and 6).

The second is based on the introduction of hidden dimensions followed by a "dimensional reduction" [7,8,9] and makes use of symmetries of connections and curvatures discussed in Sec. 6 of Mayer-Trautman, and should be considered a direct application of the methods discussed there.

3. HIDDEN DIMENSIONS AND SYMMETRY BREAKING

Another approach to symmetry breaking (more correctly, a whole class of approaches) is based on the introduction of "hidden dimensions" into the principal bundle on which a gauge theory is based, with the result that certain components of the connection take over the role of the Higgs bosons and produce the required violation of conformal invariance of the Yang-Mills equations. There are essentially two ways of introducing hidden dimensions into a principal bundle, which I will call the Kaluza-Klein, and Weyl methods, respectively. In a Kaluza-Klein approach one starts from a Riemannian or pseudo-Riemannian manifold of dimension $4 + k$, writes down the Einstein-Hilbert action (linear in the curvature) for the metric in this space, and treats the non-block-diagonal terms as a Yang-Mills connection. The appropriate terms in the action then yield, among others, terms which are quadratic

in the Yang-Mills curvature and can thus be interpreted as a Yang-Mills action. The general theory of such models has been discussed in many places; cf., e.g., Trautman's lecture in this volume, the forthcoming book by Bleecker [12], and Witten's recent attempt [4] to obtain an $SU(3) \times SU(2) \times U(1)$ gauge theory from an eleven-dimensional Kaluza-Klein model.

The Weyl approach, also known as "dimensional reduction" or "fiberflipping", has been particularly popular among supersymmetrists (I will not discuss supersymmetric gauge models here), and has been successfully used by Manton [8] in a model which derives many of the features of the standard electroweak unification from a G_2 -principal bundle by this method.

The general theory of such symmetry breaking can be formulated as follows. We start out from a principal bundle $P(M,G)$ over four-dimensional M , with hidden symmetry group G as the structure group. The symmetry group of the vacuum H , a closed subgroup of G , is assumed known. A given symmetry breaking is then described, as already discussed, by a section of the associated bundle $E(M,P,G/H,p)$. We now take E as the base space of a new bundle $R(E,G)$ with structure group G (not H , as was the case for the restriction $Q(M,H)$) obtained as the pullback of P under the projection p of the associated bundle E : $R = p^*P$. (Pictorially, one can think of R as the bundle obtained from P by "reattaching, or flipping" part of the fiber, G/H , so that it appears both in the base space and in the fiber.)

The result is a larger principal bundle, where the "hidden dimensions" of the manifold G/H appear both in the base space E and in the fiber G . The group G acts both on the base space and the bundle space, and therefore the results obtained in Sec. 6 of the Mayer-Trautman article in this volume apply. The connection on P is pulled back into

a connection on R , and both this connection and its curvature acquire extra components, since they are now defined on a larger base space. Let us denote by script letters the pullbacks to E of the connection and curvature on R in a local trivialization determined by a section $s: U \subset E \rightarrow R$:

$$A = s^*p^*\omega, \quad F = s^*p^*\Omega, \quad (3.1)$$

where ω and Ω are the connection and curvature on P , and s^*p^* denote their pullback to R pulled down to E by s (this symbolic notation can be interpreted easily in terms of local bases, which we leave as an exercise for the reader). If G/H is k -dimensional, then A is a G -valued one-form on the $4 + k$ -dimensional manifold E , and F is a G -valued two-form. Thus A can be thought of as a set of $4 + k$ matrices, and F as a set of $(4 + k)(3 + k)/2$ matrices. Moreover, one can choose in the Lie algebra G a basis adapted to the splitting $G = H + M$, $\dim G = n$, $\dim H = m$, $\dim M = n - m = k$. Clearly, the physical surviving components of A and F , which we will denote by A and F , respectively, are a one-form and two form on M with values in H , and the remaining components will be subjected to symmetry and gauge transformations, thus reducing the Yang-Mills action on E to a Yang-Mills-Ginzburg-Landau action on M !

Consider the Yang-Mills action on R (numerical factors are omitted)

$$S_{YM} = \int \text{Tr} (F \wedge *F), \quad (3.2)$$

where the trace is the Killing-Cartan trace on G , and the Hodge-dual is taken on the oriented Riemannian manifold E . (This presupposes a fiber metric on G/H , which is the same as the h of the preceding section; it should be recalled that F is a two-form, hence $*F$ is a $(2 + k)$ -form, and the integrand is a $(4 + k)$ -form, as it should be.) The connection

Handwritten notes:
 $k=3$
 $k=4$
 78
 $m=3$
 $m=24$
 28
 15
 $n=6$
 $n=28$
 6 -form
 8 -form

and its curvature are clearly invariant under the action of G on the base space E , hence we can apply Eqs. (6.15) and (6.18) of Mayer-Trautman (p.433 this volume). We can obviously split the curvature F into components along M (spacetime) and those along directions tangent to G/H . We denote the former components by $F_{!!}$ and the latter by $F_{??}$, whereas the mixed components (one along M , the other along G/H) will be denoted by $F_{!?}$; the Hodge-dual can be reexpressed in terms of the corresponding contravariant components. Then the integrand of (3.2) becomes

$$\text{Tr} (F_{!!} F^{!!} + 2F_{!?} F^{!?} + F_{??} F^{??}) . \quad (3.3)$$

Exploiting the invariance of the connection with respect to transformations in the $?$ -directions, i.e., assuming the vector fields X, Y in Eqs. (6.15) and (6.18) in Mayer-Trautman to be along G/H , the components $F_{!?}$ can be expressed as the $D_! \phi(?)$, where $\phi(?)$ is the Lie-algebra-valued 0-form corresponding to the invariance of A with respect to the vector field $?$, in the G/H direction of E . Thus, the middle term in Eq. (3.3) becomes, symbolically,

$$\text{Tr} \sum D_! \phi(?) D^! \phi(?) , \quad (3.4)$$

where the summation is over the repeated symbols $!, ?$. The first term in (3.3), after integration over the homogeneous spaces G/H and reduction to the Lie-algebra \mathfrak{H} , becomes the Yang-Mills action for the reduced Yang-Mills theory on Q . Finally, in order to handle the third term, which involves the contraction $F_{??}$ of F with two vector fields lying along G/H , we make use of the equation (6.18) in Mayer-Trautman, which becomes:

$$2F_{??} = [\phi(?), \phi(?)] - \phi([?, ?]) , \quad (3.5)$$

with the obvious meaning for the bracket of two $?$. Thus, the third term in Eq. (3.3) reduces to what is essentially

a Ginzburg-Landau polynomial in the components of ϕ :

$$\text{Tr} F_{\mu\nu}^2 = \frac{1}{4} \text{Tr} ([\phi, \phi] - \phi)^2, \quad (3.6)$$

where the square means contraction in the appropriate vector field directions with the metric h on G/H . As was pointed out by Professor O'Riada, it is necessary to analyze the expression (3.6) more carefully, since the presence of the brackets may in some cases lead to instability problems. However, special cases which were considered show that Eq. (3.6) has indeed the properties required of a Ginzburg-Landau-Higgs potential, and moreover the relative signs of the quartic and quadratic terms are correct, and only one overall normalization constant (rather than the two which are usual in the expression (1.2)) is needed.

There remains, of course, the problem of how to introduce spinors into a model of this type, and how to couple the spinors to the new fields ϕ which have been introduced. There are two obvious ways in which spinors can be handled in this context, neither of which leads to satisfactory results in physical contexts. ~~The first is to treat the spinors as tensor products of four-dimensional spinors with objects behaving trivially on G/H .~~ The second is to introduce spinors on E (i.e., objects transforming under the group $\text{Spin}(4+k)$), and then carry out the reduction.

$k=4$ $\text{Spin}(8)$

FOUNDATIONS OF DIFFERENTIAL GEOMETRY

VOLUME I

SHOSHICHI KOBAYASHI

University of California, Berkeley, California

and

KATSUMI NOMIZU

Brown University, Providence, Rhode Island

1963

INTERSCIENCE PUBLISHERS

a division of John Wiley & Sons, New York • London

we have $\dot{u}_t = \varphi_t(X_{u_0})$ and hence $\omega(\dot{u}_t) = \omega(X_{u_0}) = A$, since the connection form ω is invariant by φ_t . Thus we obtain $a_t^{-1}\dot{a}_t = A$. QED.

Let K be a Lie group acting on a principal fibre bundle $P(M, G)$ as a group of automorphisms. Let u_0 be an arbitrary point of P which we choose as a reference point. Every element of K induces a transformation of M in a natural manner. The set J of all elements of K which fix the point $x_0 = \pi(u_0)$ of M forms a closed subgroup of K , called the isotropy subgroup of K at x_0 . We define a homomorphism $\lambda: J \rightarrow G$ as follows. For each $j \in J$, ju_0 is a point in the same fibre as u_0 and hence is of the form $ju_0 = u_0a$ with some $a \in G$. We define $\lambda(j) = a$. If $j, j' \in J$, then

$$\begin{aligned} u_0\lambda(jj') &= (jj')u_0 = j(u_0\lambda(j')) = (ju_0)\lambda(j') \\ &= (u_0\lambda(j))\lambda(j') = u_0(\lambda(j)\lambda(j')). \end{aligned}$$

Hence, $\lambda(jj') = \lambda(j)\lambda(j')$, which shows that $\lambda: J \rightarrow G$ is a homomorphism. It is also easy to check that λ is differentiable. The induced Lie algebra homomorphism $\mathfrak{j} \rightarrow \mathfrak{g}$ will be also denoted by the same λ . Note that λ depends on the choice of u_0 ; the reference point u_0 is chosen once for all and is fixed throughout this section.

PROPOSITION 11.3. *Let K be a group of automorphisms of $P(M, G)$ and Γ a connection in P invariant by K . We define a linear mapping $\Lambda: \mathfrak{k} \rightarrow \mathfrak{g}$ by*

$$\Lambda(X) = \omega_{u_0}(\tilde{X}), \quad X \in \mathfrak{k},$$

where \tilde{X} is the vector field on P induced by X . Then

- (1) $\Lambda(X) = \lambda(X)$ for $X \in \mathfrak{j}$;
- (2) $\Lambda(\text{ad}(j)(X)) = \text{ad}(\lambda(j))(\Lambda(X))$ for $j \in J$ and $X \in \mathfrak{k}$,

where $\text{ad}(j)$ is the adjoint representation of J in \mathfrak{k} and $\text{ad}(\lambda(j))$ is that of G in \mathfrak{g} .

Note that the geometric meaning of $\Lambda(X)$ is given by Proposition 11.2.

Proof. (1) We apply Proposition 11.2 to the 1-parameter subgroup φ_t of K generated by X . If $X \in \mathfrak{j}$, then the curve $x_t = \pi(\varphi_t(u_0))$ reduces to a single point $x_0 = \pi(u_0)$. Hence we have $\varphi_t(u_0) = u_0\lambda(\varphi_t)$. Comparing the tangent vectors of the orbits $\varphi_t(u_0)$ and $u_0\lambda(\varphi_t)$ at u_0 , we obtain $\Lambda(X) = \lambda(X)$.

(2) Let $X \in \mathfrak{k}$ and $j \in J$. We set $Y = \text{ad}(j)(X)$. Then Y generates the 1-parameter subgroup $j\varphi_t j^{-1}$ which maps u_0 into $j\varphi_t j^{-1}(u_0) = j\varphi_t(u_0 \lambda(j^{-1})) = j(R_{\lambda(j^{-1})} \varphi_t u_0)$. It follows that $\tilde{Y}_{u_0} = j(R_{\lambda(j^{-1})} \tilde{X}_{u_0})$. Since the connection form ω is invariant by j , we have

$$\begin{aligned} \omega_{u_0}(\tilde{Y}) &= \omega_{u_0}(j(R_{\lambda(j^{-1})} \tilde{X}_{u_0})) = \omega_{j^{-1}u_0}(R_{\lambda(j^{-1})} \tilde{X}_{u_0}) \\ &= \text{ad}(\lambda(j))(\omega_{u_0}(\tilde{X}_{u_0})) = \text{ad}(\lambda(j))(\Lambda(X)). \end{aligned}$$

QED.

PROPOSITION 11.4. *With the notation of Proposition 11.3, the curvature form Ω of Γ satisfies the following condition:*

$$2\Omega_{u_0}(\tilde{X}, \tilde{Y}) = [\Lambda(X), \Lambda(Y)] - \Lambda([X, Y]) \quad \text{for } X, Y \in \mathfrak{k}.$$

Proof. From the structure equation (Theorem 5.2) and Proposition 3.11 of Chapter I, we obtain

$$\begin{aligned} 2\Omega(\tilde{X}, \tilde{Y}) &= 2d\omega(\tilde{X}, \tilde{Y}) + [\omega(\tilde{X}), \omega(\tilde{Y})] \\ &= \tilde{X}(\omega(\tilde{Y})) - \tilde{Y}(\omega(\tilde{X})) - \omega([\tilde{X}, \tilde{Y}]) + [\omega(\tilde{X}), \omega(\tilde{Y})]. \end{aligned}$$

Since ω is invariant by K , we have by (c) of Proposition 3.2 of Chapter I (cf. also Proposition 3.5 of Chapter I)

$$\begin{aligned} \tilde{X}(\omega(\tilde{Y})) - \omega([\tilde{X}, \tilde{Y}]) &= (L_{\tilde{X}}\omega)(\tilde{Y}) = 0, \\ \tilde{Y}(\omega(\tilde{X})) - \omega([\tilde{Y}, \tilde{X}]) &= (L_{\tilde{Y}}\omega)(\tilde{X}) = 0. \end{aligned}$$

On the other hand, $X \rightarrow \tilde{X}$ being a Lie algebra homomorphism, we have

$$\omega_{u_0}([\tilde{X}, \tilde{Y}]) = \Lambda([X, Y]).$$

Thus we obtain

$$\begin{aligned} 2\Omega_{u_0}(\tilde{X}, \tilde{Y}) &= [\omega_{u_0}(\tilde{X}), \omega_{u_0}(\tilde{Y})] - \Lambda([X, Y]) \\ &= [\Lambda(X), \Lambda(Y)] - \Lambda([X, Y]). \end{aligned}$$

QED.

We say that K acts *fibre-transitively* on P if, for any two fibres of P , there is an element of K which maps one fibre into the other, that is, if the action of K on the base M is transitive. If J is the isotropy subgroup of K at $x_0 = \pi(u_0)$ as above, then M is the homogeneous space K/J .

The following result is due to Wang [1].

THEOREM 11.5. *If a connected Lie group K is a fibre-transitive automorphism group of a bundle $P(M, G)$ and if J is the isotropy subgroup of*

K at $x_0 = \pi(u_0)$, then there is a 1:1 correspondence between the set of K -invariant connections in P and the set of linear mappings $\Lambda: \mathfrak{k} \rightarrow \mathfrak{g}$ which satisfies the two conditions in Proposition 11.3; the correspondence is given by

$$\Lambda(X) = \omega_{u_0}(\tilde{X}) \quad \text{for } X \in \mathfrak{k},$$

where \tilde{X} is the vector field on P induced by X .

Proof. In view of Proposition 11.3, it is sufficient to show that, for every $\Lambda: \mathfrak{k} \rightarrow \mathfrak{g}$ satisfying (1) and (2) of Proposition 11.3, there is a K -invariant connection form ω on P such that $\Lambda(X) = \omega_{u_0}(\tilde{X})$ for $X \in \mathfrak{k}$. Let $X^* \in T_u(P)$. Since K is fibre-transitive, we can write

$$u_0 = kua = k \circ R_a u$$

$$k \circ R_a X^* = \tilde{X}_{u_0} + A_{u_0}^*,$$

where $k \in K$, $a \in G$, $X \in \mathfrak{k}$ and A^* is the fundamental vector field corresponding to $A \in \mathfrak{g}$. We then set

$$\omega(X^*) = \text{ad}(a)(\Lambda(X) + A).$$

We first prove that $\omega(X^*)$ is independent of the choice of X and A . Let

$$\tilde{X}_{u_0} + A_{u_0}^* = \tilde{Y}_{u_0} + B_{u_0}^*, \quad \text{where } Y \in \mathfrak{k} \text{ and } B \in \mathfrak{g},$$

so that $\tilde{X}_{u_0} - \tilde{Y}_{u_0} = B_{u_0}^* - A_{u_0}^*$. From the definition of $\lambda: \mathfrak{j} \rightarrow \mathfrak{g}$, it follows that $\lambda(X - Y) = B - A$. By condition (1) of Proposition 11.3, we have $\lambda(X - Y) = \Lambda(X - Y) = \Lambda(X) - \Lambda(Y)$. Hence, $\Lambda(X) + A = \Lambda(Y) + B$.

We next prove that $\omega(X^*)$ is independent of the choice of k and a . Let

$$u_0 = kua = k_1 u a_1 \quad (k_1 \in K \text{ and } a_1 \in G),$$

so that $k_1 k^{-1} u_0 = u_0 a_1^{-1} a$ and $k_1 k^{-1} \in J$. We set $j = k_1 k^{-1}$. Then $\lambda(j) = a_1^{-1} a$. We have

$$\begin{aligned} k_1 \circ R_{a_1} X^* &= jk \circ R_{a\lambda(j^{-1})} X^* \\ &= j \circ R_{\lambda(j^{-1})} (k \circ R_a X^*) = j \circ R_{\lambda(j^{-1})} (\tilde{X}_{u_0} + A_{u_0}^*). \end{aligned}$$

By Proposition 1.7 of Chapter I, we have

$$j \circ R_{\lambda(j^{-1})} (\tilde{X}_{u_0}) = j(\tilde{X}_{u_0 \lambda(j^{-1})}) = \tilde{Z}_{u_0}, \quad \text{where } Z = \text{ad}(j)(X).$$

By Proposition 5.1 of Chapter I, we have

$$j \circ R_{\lambda(j^{-1})}(A_{u_0}^*) = R_{\lambda(j^{-1})}(jA_{u_0}^*) = R_{\lambda(j^{-1})}A_{ju_0}^* = R_{\lambda(j^{-1})}A_{u_0\lambda(j)}^* = C_{u_0}^*,$$

where $C = \text{ad}(\lambda(j))(A)$. Hence we have

$$\begin{aligned} k_1 \circ R_{a_1}X^* &= \tilde{Z}_{u_0} + C_{u_0}^*, \\ \text{ad}(a_1)(\Lambda(Z) + C) &= \text{ad}(a_1)(\Lambda(\text{ad}(j)(X)) + \text{ad}(\lambda(j))A) \\ &= \text{ad}(a_1)[\text{ad}(\lambda(j))(\Lambda(X) + A)] \\ &= \text{ad}(a)(\Lambda(X) + A). \end{aligned}$$

This proves our assertion that $\omega(X^*)$ depends only on X^* .

We now prove that ω is a connection form. Let $X^* \in T_u(P)$ and $u_0 = kua$ as above. Let b be an arbitrary element of G . We set

$$Y^* = R_bX^* \in T_v(P), \quad \text{where } v = ub,$$

so that $u_0 = kub(b^{-1}a) = kv(b^{-1}a)$. We then have

$$k \circ R_{b^{-1}a}Y^* = k \circ R_{b^{-1}a}R_bX^* = k \circ R_aX^* = (\tilde{X}_{u_0} + A_{u_0}^*)$$

and hence

$$\omega(R_bX^*) = \omega(Y^*) = \text{ad}(b^{-1}a)(\Lambda(X) + A) = \text{ad}(b^{-1})(\omega(X^*)),$$

which shows that ω satisfies condition (b') of Proposition 1.1. Now, let A be any element of \mathfrak{g} and let $u_0 = kua$. Then

$$k \circ R_a(A_u^*) = R_a \circ k(A_u^*) = R_a(A_{ku}^*) = B_{u_0}^*, \quad \text{where } B = \text{ad}(a^{-1})(A).$$

Hence we have

$$\omega(A_u^*) = \text{ad}(a)(B) = A,$$

which shows that ω satisfies condition (a') of Proposition 1.1.

To prove that ω is differentiable, let u_1 be an arbitrary point of P and let $u_0 = k_1u_1a_1$. Consider the fibre bundle $K(M, J)$, where $M = K/J$. Let $\sigma: U \rightarrow K$ be a local cross section of this bundle defined in a neighborhood U of $\pi(u_1)$ such that $\sigma(\pi(u_1)) = k_1$. For each $u \in \pi^{-1}(U)$, we define $k \in K$ and $a \in G$ by

$$k = \sigma(\pi(u)) \quad \text{and} \quad u_0 = kua.$$

Then both k and a depend differentiably on u . We decompose the vector space \mathfrak{k} into a direct sum of subspaces: $\mathfrak{k} = \mathfrak{j} + \mathfrak{m}$. For an

arbitrary $X^* \in T_u(P)$, we set

$$k \circ R_a(X^*) = \tilde{X}_{u_0} + A_{u_0}^*, \quad \text{where } X \in \mathfrak{m}.$$

Then both X and A are uniquely determined and depend differentiably on X^* . Thus $\omega(X^*) = \text{ad}(a)(\Lambda(X) + A)$ depends differentiably on X^* .

Finally, we prove that ω is invariant by K . Let $X^* \in T_u(P)$ and $u_0 = kua$. Let k_1 be an arbitrary element of K . Then $k_1 X^* \in T_{k_1 u}(P)$ and $u_0 = k k_1^{-1}(k_1 u)a$. Hence,

$$k k_1^{-1} \circ R_a(k_1 X^*) = k \circ R_a(X^*).$$

From the construction of ω , we see immediately that $\omega(k_1 X^*) = \omega(X^*)$. QED.

In the case where K is fibre-transitive on P , the curvature form Ω , which is a tensorial form of type $\text{ad } G$ (cf. §5) and is invariant by K , is completely determined by the values $\Omega_{u_0}(\tilde{X}, \tilde{Y})$, $X, Y \in \mathfrak{k}$. Proposition 11.4 expresses $\Omega_{u_0}(\tilde{X}, \tilde{Y})$ in terms of Λ . As a consequence of Proposition 11.4 and Theorem 11.5, we obtain

COROLLARY 11.6. *The K -invariant connection in P defined by Λ is flat if and only if $\Lambda: \mathfrak{k} \rightarrow \mathfrak{g}$ is a Lie algebra homomorphism.*

Proof. A connection is flat if and only if its curvature form vanishes identically (Theorem 9.1). QED.

THEOREM 11.7. *Assume in Theorem 11.5 that \mathfrak{k} admits a subspace \mathfrak{m} such that $\mathfrak{k} = \mathfrak{j} + \mathfrak{m}$ (direct sum) and $\text{ad}(J)(\mathfrak{m}) = \mathfrak{m}$, where $\text{ad}(J)$ is the adjoint representation of J in \mathfrak{k} . Then*

(1) *There is a 1:1 correspondence between the set of K -invariant connections in P and the set of linear mappings $\Lambda_{\mathfrak{m}}: \mathfrak{m} \rightarrow \mathfrak{g}$ such that*

$$\Lambda_{\mathfrak{m}}(\text{ad}(j)(X)) = \text{ad}(\lambda(j))(\Lambda_{\mathfrak{m}}(X)) \quad \text{for } X \in \mathfrak{m} \text{ and } j \in J;$$

the correspondence is given via Theorem 11.5 by

$$\Lambda(X) = \begin{cases} \lambda(X) & \text{if } X \in \mathfrak{j}, \\ \Lambda_{\mathfrak{m}}(X) & \text{if } X \in \mathfrak{m}. \end{cases}$$

(2) *The curvature form Ω of the K -invariant connection defined by $\Lambda_{\mathfrak{m}}$ satisfies the following condition:*

$$2\Omega_{u_0}(\tilde{X}, \tilde{Y}) = [\Lambda_{\mathfrak{m}}(X), \Lambda_{\mathfrak{m}}(Y)] - \Lambda_{\mathfrak{m}}([X, Y]_{\mathfrak{m}}) - \lambda([X, Y]_{\mathfrak{j}}) \\ \text{for } X, Y \in \mathfrak{m},$$

3 Generations of Fermions

In Kaluza-Klein $M4 \times CP2$ there are 3 possibilities for a fermion represented by an Octonion O basis element to go from point A to point B :

1 - A and B are both in $M4$: First Generation Fermion whose path can be represented by the single O basis element so that First Generation Fermions are represented by Octonions O .

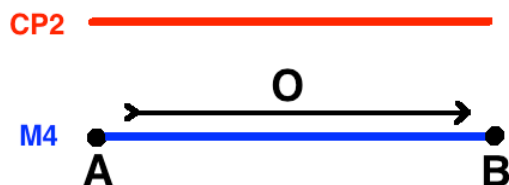

2 - Either A or B , but not both, is in $CP2$: Second Generation Fermion whose path must be augmented by one projection from $CP2$ to $M4$, which projection can be represented by a second O basis element so that Second Generation Fermions are represented by Octonion Pairs OxO .

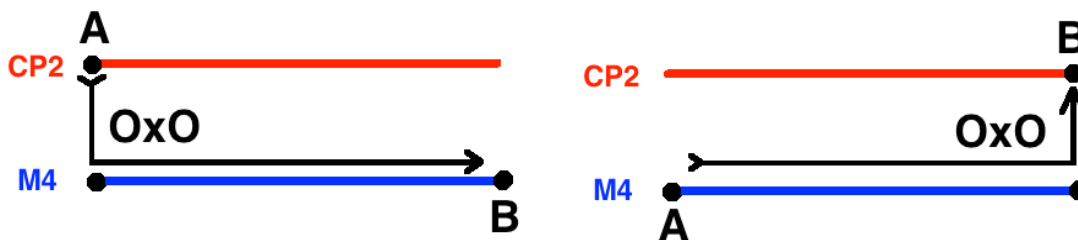

3 - Both A and B are in $CP2$: Third Generation Fermion whose path must be augmented by two projections from $CP2$ to $M4$, which projections can be represented by a second O and a third O , so that Third Generation Fermions are represented by Octonion Triples $OxOxO$.

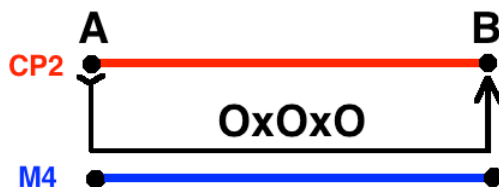

Schwinger Sources, Hua Geometry, and Wyler Calculations

Fock “Fundamental of Quantum Mechanics” (1931) showed that it requires Linear Operators “... represented by a definite integral [of a]... kernel ... function ...”.

Hua “Harmonic Analysis of Functions of Several Complex Variables in the Classical Domains” (1958) showed Kernel Functions for Complex Classical Domains.

Schwinger (1951 - see Schweber, PNAS 102, 7783-7788) “... introduced a description in terms of Green’s functions, what Feynman had called propagators ... The Green’s functions are vacuum expectation values of time-ordered Heisenberg operators, and the field theory can be defined non-perturbatively in terms of these functions ...[which]... gave deep structural insights into QFTs; in particular ... the structure of the Green's functions when their variables are analytically continued to complex values ...”.

Wolf (J. Math. Mech 14 (1965) 1033-1047) showed that the Classical Domains (complete simply connected Riemannian symmetric spaces) representing 4-dim Spacetime with Quaternionic Structure are:

$$\begin{aligned}
 S^1 \times S^1 \times S^1 \times S^1 &= 4 \text{ copies of } U(1) \\
 S^2 \times S^2 &= 2 \text{ copies of } SU(2) \\
 CP^2 &= SU(3) / SU(2) \times U(1) \\
 S^4 &= Spin(5) / Spin(4) = \text{Euclidean version of } Spin(2,3) / Spin(1,3)
 \end{aligned}$$

Armand Wyler (1971 - C. R. Acad. Sc. Paris, t. 271, 186-188) showed how to use **Green’s Functions = Kernel Functions** of Classical Domain structures characterizing **Sources = Leptons, Quarks, and Gauge Bosons, to calculate Particle Masses and Force Strengths**

Schwinger (1969 - see physics/0610054) said: “... operator field theory ... replace[s] the particle with ... properties ... distributed throughout ... small volumes of three-dimensional space ... particles ... must be created ... even though we vary a number of experimental parameters ... The properties of the particle ... remain the same ... We introduce a quantitative description of the particle source in terms of a source function ... we do not have to claim that we can make the source arbitrarily small ... the experimenter... must detect the particles ...[by]... collision that annihilates the particle ... the source ... can be ... an abstraction of an annihilation collision, with the source acting negatively, as a sink ... The basic things are ... the source functions ... describing the intermediate propagation of the particle ...”.

Creation and Annihilation operators indicate a Clifford Algebra, and 8-Periodicity shows that the basic Clifford Algebra is formed by tensor products of 256-dim $Cl(8)$ such as $Cl(8) \times Cl(8) = Cl(16)$ containing 248-dim $E_8 = 120\text{-dim } D_8 + 128\text{-dim } D_8$ half-spinor whose maximal contraction is a realistic generalized Heisenberg Algebra

$$\mathfrak{h}_{92} \times \mathfrak{A}_7 = 5\text{-graded } 28 + 64 + ((SL(8, \mathbb{R}) + 1) + 64 + 28$$

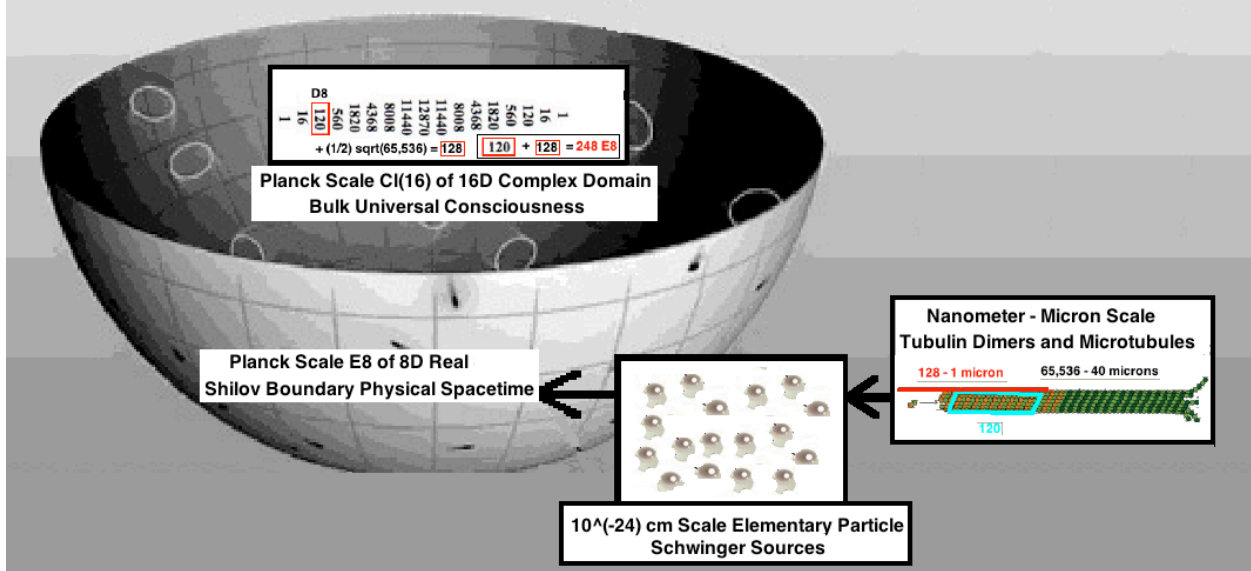

In E8 Physics (viXra 1602.0319) **Spacetime is the 8-dimensional Shilov Boundary RP1 x S7** of the **Type IV8 Bounded Complex Domain Bulk Space** of the Symmetric Space Spin(10) / Spin(8)xU(1) which **Bulk Space** has 16 Real dimensions and is the Vector Space of the Real Clifford Algebra Cl(16). By 8-Periodicity, Cl(16) = tensor product Cl(8) x Cl(8) = Real 256x256 Matrix Algebra M(R,256) and so has 256x256 = 65,536 elements.

D8																				
1	16	120	560	1820	4368	8008	11440	12870	11440	8008	4368	1820	560	120	16	1				
		120																		
																	+ (1/2) sqrt(65,536) = 128	120 + 128 = 248 E8		

Cl(8) has 8 Vectors, 28 BiVectors, and 16 Spinors with 8+28+16 = 52 = F4 Lie Algebra.
 Cl(16) has 120 BiVectors, and 128 Half-Spinors with 120+128 = 248 = E8 Lie Algebra.
 The 248 E8 elements of Cl(16) define a Lagrangian for the Standard Model and for Gravity - Dark Energy so that 65,536 - 248 = 65,288 elements of Cl(16) can carry Bits of Information.
 The Complex Bulk Space Cl(16) contains the Maximal Contraction of E8 which is H92 + A7 a generalized Heisenberg Algebra of Quantum Creation-Annihilation Operators with graded structure
 $28 + 64 + ((SL(8,R)+1) + 64 + 28$

We live in the Physical Minkowski M4 part of Kaluza-Klein M4 x CP2 structure of RP1 x S7 **Boundary**.
 (where CP2 = SU(3) / SU(2)xU(1) is Internal Symmetry Space of Standard Model gauge groups)
 Our Consciousness is based on Binary States of Tubulin Dimers (each 4x4x8 nm size) in Microtubules.

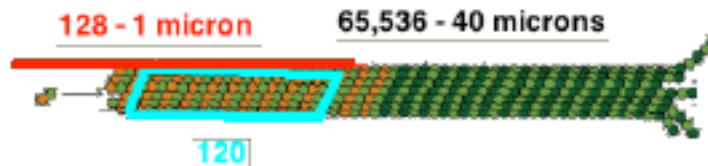

Microtubules are cylinders of sets of 13 Dimers with maximal length about 40,000 nm so that each Microtubule can contain about 13 x 40,000 / 8 = 65,000 Bits of Information.
 The Physical Boundary in which we live is a Real Shilov Boundary in which E8 is manifested as Lagrangian Structure of Real Forms of E8 with Lagrangian Symmetric Space structure:

$$E8 / D8 = (OxO)P2 \text{ for } 8 \text{ componets of } 8+8 \text{ First-Generation Fermions}$$

$$D8 / D4 \times D4 \text{ for } 8\text{-dim spacetime position } \times 8\text{-dim spacetime momentum}$$

D4 for Standard Model Gauge Bosons and Gravity - Dark Energy Ghosts
 D4 for Gravity - Dark Energy Gauge Bosons and Standard Model Ghosts

Microtubule Information in the Boundary has Resonant Connection to Cl(16) Information in Bulk Space by the spin-2 Bohm Quantum Potential with Sarfatti Back-Reaction of 26D String Theory of World-Lines consistent with Poisson Kernel as derivative of Green's function.

The Bulk Space Domain Type IV8 corresponds to the Symmetric Space Spin(10) / Spin(8)xU(1) and is a Lie Ball whose Shilov Boundary RP1 x S7 is a Lie Sphere 8-dim Spacetime.

It is related to the Stiefel Manifold V(10,2) = Spin(10) / Spin(8) of dimension 20-3 = 17

by the fibration Spin(10) / Spin(8)xU(1) -> V(10,2) -> U(1)

It can also be seen as a tube $z = x + iy$ whose imaginary part is physically inverse momentum so that its points give both position and momentum

(see R. **Coquereaux** Nuc. Phys. B. 18B (1990) 48-52) "Lie Balls and Relativistic Quantum Fields".

In "Harmonic Analysis of Functions of Several Complex Variables in the Classical Domains" L. K. Hua said: "... Editor's Foreword ... M. I. Graev ...

Poisson kernel can be defined in group-theoretic terms. Let \mathfrak{R} be one of the domains considered in the book, and \mathfrak{C} its characteristic manifold. Let z be a point in \mathfrak{R} and C_z the group of those analytic automorphisms of \mathfrak{R} which leave z invariant. It can be shown that the group C_z is transitive on \mathfrak{C} , i.e., transforms any point of \mathfrak{C} into any other point. The measure on \mathfrak{C} which is invariant under the transformations in C_z is then simply equal to the Poisson kernel.

...[Characteristic Manifold = Shilov Boundary]...

In 1935, E. Cartan [1] proved that there exist only six types of irreducible homogeneous bounded symmetric domains. Beside the four types, RI, RII, RIII, RIV there exist only two; their dimensions are 16 and 27.

[16-Complex-Dimensional E6 / Spin(10)xU(1) = (CxO)P2
 27-Complex-Dimensional E7 / E6xU(1) = J(3,(CxO))]

The domain \mathfrak{R}_{IV} of n -dimensional ($n > 2$) vectors

$$z = (z_1, z_2, \dots, z_n)$$

(z_k are complex numbers) satisfying the conditions

$$|zz'|^2 + 1 - 2zz' > 0, \quad |zz'| < 1.$$

The complex dimension of the four domains is $mn, n(n+1)/2, n(n-1)/2, n$.

The author has shown (cf. L. K. Hua [3]) that \mathfrak{R}_{IV} can also be regarded as a homogeneous space of $2 \times n$ real matrices. Therefore, the study of all these domains can be reduced to a study of the geometry of matrices.

The manifolds \mathfrak{G}_I , \mathfrak{G}_{II} , \mathfrak{G}_{III} and \mathfrak{G}_{IV} have real dimension $m(2n-m)$, $n(n+1)/2$, $n(n-1)/2 + (1+(-1)^n)(n-1)/2$ and n , respectively.

The characteristic manifold of the domain \mathfrak{R}_{IV} consists of vectors of the form $e^{i\theta}x$, where $0 \leq \theta \leq \pi$, and $x = (x_1, \dots, x_n)$ is a real vector which satisfies the condition $xx' = 1$.

$$H(z, \theta, x) = \frac{1}{V(\mathfrak{G}_{IV}) [(x - e^{-i\theta}z)(x - e^{-i\theta}z)']^{n/2}},$$

the magnitude of the volume $V(\mathfrak{G}_{IV})$:
$$V(\mathfrak{G}_{IV}) = \frac{2\pi^{\frac{n}{2}+1}}{\Gamma\left(\frac{n}{2}\right)}.$$

The Bergman kernel of the domain \mathfrak{R}_{IV} is

$$\frac{1}{V(\mathfrak{R}_{IV})} (1 + |zz'|^2 - 2\bar{z}z')^{-n},$$

where,
$$V(\mathfrak{R}_{IV}) = \frac{\pi^n}{2^{n-1} \cdot n!}.$$

THE POISSON KERNEL For \mathfrak{R}_{IV}

$$P(z, \xi) = \frac{1}{V(\mathfrak{G}_{IV})} \cdot \frac{(1 + |zz'|^2 - 2\bar{z}z')^{\frac{n}{2}}}{|(z - \xi)(z - \xi)'|^n},$$

where $\xi \in \mathfrak{G}_{IV}$.

HARMONIC ANALYSIS ON LIE SPHERES

$$\begin{aligned} & \int_{\mathfrak{R}_{IV}} |zz'|^{2l} \Phi_{f-2l}(z, \bar{z}) \dot{z} \\ &= (N_{f-2l} - N_{f-2l-2}) \frac{l! \Gamma(n) \Gamma\left(\frac{n}{2} + 1\right) \Gamma\left(f + \frac{n}{2} - l\right)}{2\pi^{\frac{n}{2}} \Gamma\left(l + \frac{n}{2} + 1\right) \Gamma(f + n - l)} V(\mathfrak{R}_{IV}). \end{aligned}$$

...

In Annals of Mathematics 55 (1952) 19-33 P. R. **Garabedian** said “...

we turn here to a more direct development of the theory of boundary value problems associated with the Cauchy-Riemann equations for analytic functions of several complex variables.

This boundary value problem is solved by means of a Dirichlet principle, and we introduce a Green's function in terms of which the solution can be expressed as a boundary integral. A formula giving the Bergman kernel function for several variables [1] in terms of this Green's function is obtained, and we thus generalize known theorems from the theory of functions of one complex variable

for analytic functions of several complex variables.

Bergman [1] defines a kernel function $k(z, t)$, analytic in z and \bar{t} for $z, t \in D$

THEOREM 3. *The analytic kernel function $k(z, t)$ with*

$$g(t) = \int_D g(z) \overline{k(z, t)} d\tau$$

for each analytic function g in D has the representation

$k(z, t) = \Delta_z \theta(z, t)$ in terms of the Green's function $\theta(z, t)$.

...”

Schwinger (1951 - see Schweber, PNAS 102, 7783-7788) “... introduced a description in terms of **Green's functions ...[of]... what Feynman had called propagators** ... The Green's functions are vacuum expectation values of time-ordered Heisenberg operators, and the field theory can be defined non-perturbatively in terms of these functions ...[which]... gave deep structural insights into QFTs; in particular ... the structure of the Green's functions when their variables are analytically continued to complex values ...”.

Wolf (J. Math. Mech 14 (1965) 1033-1047) showed that the Classical Domains (complete simply connected Riemannian symmetric spaces) representing 4-dim Spacetime with Quaternionic Structure are:

$$S^1 \times S^1 \times S^1 \times S^1 = 4 \text{ copies of } U(1)$$

$$S^2 \times S^2 = 2 \text{ copies of } SU(2)$$

$$CP^2 = SU(3) / SU(2) \times U(1)$$

$$S^4 = Spin(5) / Spin(4) = \text{Euclidean version of } Spin(2,3) / Spin(1,3)$$

Armand **Wylter** (1971 - C. R. Acad. Sc. Paris, t. 271, 186-188) showed how to use Green's Functions = Kernel Functions of Classical Domain structures characterizing Sources = Leptons, Quarks, and Gauge Bosons, to calculate Particle Masses and Force Strengths

Schwinger (1969 - see physics/0610054) said: “... operator field theory ... replace[s] the particle with ... properties ... distributed throughout ... small volumes of three-dimensional space ... particles ... must be created ... even though we vary a number of experimental parameters ... The properties of the particle ... remain the same ... We introduce a quantitative description of the particle source in terms of a source function ... we do not have to claim that we can make the source arbitrarily small ... the experimenter... must detect the particles ...[by]... collision that annihilates the particle ... the source ... can be ... an abstraction of an annihilation collision, with the source acting negatively, as a sink ... **The basic things are ... the source functions ... describing the intermediate propagation of the particle ...**”.

E8 Physics constructs the **Lagrangian** integral such that the **mass m emerges as the integral over the Schwinger Source spacetime region** of its Kerr-Newman cloud of virtual particle/antiparticle pairs plus the valence fermion so that the volume of the Schwinger Source fermion defines its mass, which, being dressed with the particle/antiparticle pair cloud, gives **quark mass as constituent mass**.

Schwinger Sources as described above are continuous manifold structures of Bounded Complex Domains and their Shilov Boundaries but the E8 model at the Planck Scale has spacetime condensing out of Clifford structures forming a Lorentz Leech lattice underlying 26-dim String Theory of World-Lines with $8 + 8 + 8 = 24$ -dim of fermion particles and antiparticles and of spacetime.

The automorphism group of a single 26-dim String Theory cell modulo the Leech lattice is the Monster Group of order about 8×10^{53} .

When a fermion particle/antiparticle appears in E8 spacetime it does not remain a single Planck-scale entity because **Tachyons create a cloud of particles/antiparticles**. The cloud is one Planck-scale Fundamental Fermion Valence Particle plus an effectively neutral cloud of particle/antiparticle pairs forming a Kerr-Newman black hole. That cloud constitutes the **Schwinger Source**. Its **structure comes from the 24-dim Leech lattice part of the Monster Group which is $2^{(1+24)}$ times the double cover of Co_1 , for a total order of about 10^{26} .**

Since a Leech lattice is based on copies of an E8 lattice and since there are 7 distinct E8 integral domain lattices there are 7 (or 8 if you include a non-integral domain E8 lattice) distinct Leech lattices. The physical Leech lattice is a superposition of them, effectively adding a factor of 8 to the order.

The volume of the Kerr-Newman Cloud is on the order of 10^{27} x Planck scale, so the Kerr-Newman Cloud **Source should contain about 10^{27} particle/antiparticle pairs and its size should be about $10^{(27/3)} \times 1.6 \times 10^{(-33)}$ cm = roughly $10^{(-24)}$ cm.**

Each Schwinger Source particle-antiparticle pair should see (with Bohm Potential) the rest of our Universe in the perspective of 8×10^{53} Monster Symmetry so **a Schwinger Source acting as a Jewel of Indra's Net** of Schwinger Source Bohm Quantum Blockchain Physics (viXra 1801.0086) **can see / reflect $10^{27} \times 8 \times 10^{53} = 8 \times 10^{80}$ Other Schwinger Source Jewels of Indra's Net.**

How many Schwinger Sources are in the Indra's Net of Our Universe ?

Based on gr-qc/0007006 by Paola Zizzi, the Inflation Era of Our Universe ended with Quantum Decoherence when its number of qubits reached 2^{64} for $Cl(64) = Cl(8)^8$ self-reflexivity whereby each $Cl(8)$ 8-Periodicity component corresponded to each basis element of the $Cl(8)$ Vector Space.

At the End of Inflation, each of the 2^{64} qubits transforms into 2^{64} elementary first-generation fermion particle-antiparticle pairs. The resulting $2^{64} \times 2^{64}$ pairs constitute a Zizzi Quantum Register of order $2^{64} \times 2^{64} = 2^{128}$.

At Reheating time $T_n = (n+1) T_{Planck}$ the Register has $(n+1)^2$ qubits so at Reheating Our Universe has $(2^{128})^2 = 2^{256} = 10^{77}$ qubits and since each qubit corresponds to fermion particle-antiparticle pairs that average about 0.66 GeV so

the number of particles in our Universe at Reheating is about 10^{77} nucleons which, being less than 10^{80} , can be reflected by Schwinger Source Indra Jewels.

The Reheating process raises the energy/temperature at Reheating to $E_{reh} = 10^{14}$ GeV, the geometric mean of the $E_{Planck} = 10^{19}$ GeV and $E_{decoh} = 10^{10}$ GeV. After Reheating, our Universe enters the Radiation-Dominated Era, and, since there is no continuous creation, particle production stops, so the **10^{77} nucleon Baryonic Mass of our Universe has been mostly constant since Reheating,** and will continue to be mostly constant until Proton Decay.

How are the Elements of Indra Net Information positioned in a Schwinger Source that can reflect 10^{80} Other Schwinger Source Indra Jewels ?

To be evenly distributed in a 3D cube of size $10^{(-24)}$ cm each Information Element would have a volume of $10^{(-24 \times 3)} / 10^{80} = 10^{(-72-80)} = 10^{(-152)}$ cm³ or a size of roughly $10^{(-50)}$ cm which is much smaller than the Planck scale of $1.6 \times 10^{(-33)}$ cm so an even distribution of Information Elements is not realistic.

To fit inside a Schwinger Source the Information Elements should be distributed as a Fractal.

Peitgen, Jurgens, and Saupe in Chaos and Fractals (1992) say
 "... Riemann Mapping Theorem ... [gives] A one-to-one correspondence between the potential of the unit disk and the potential of any connected prisoner set ... corresponding to $z \rightarrow z^2 + c$...

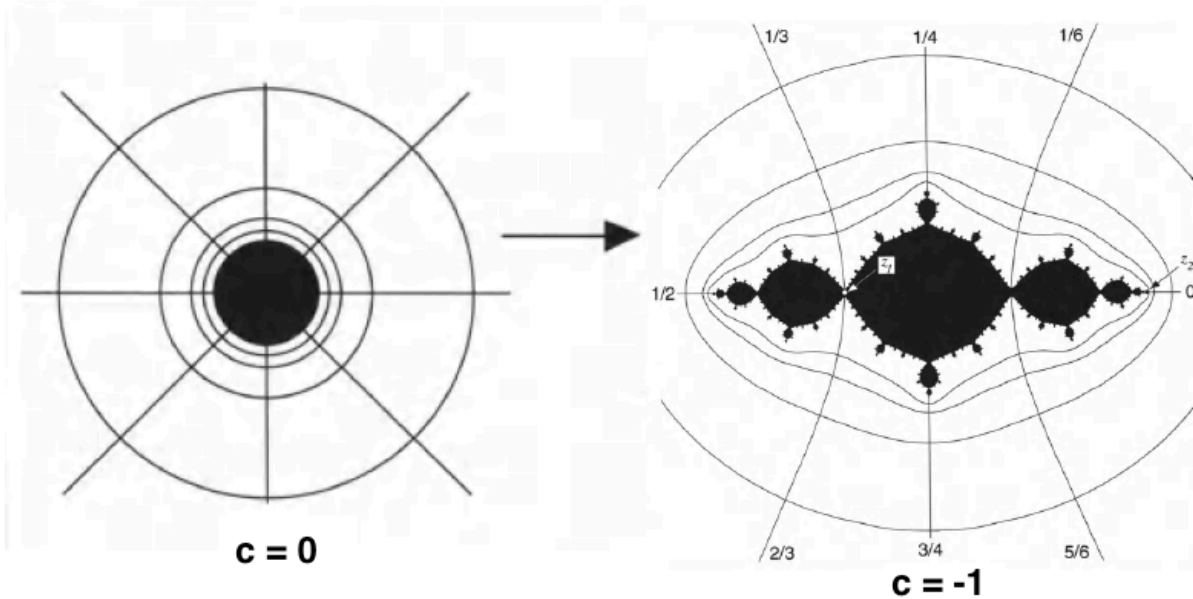

... using $c = -1$... There are two fixed points,
 $z_1 = (1 - \sqrt{5}) / 2$ and $z_2 = (1 + \sqrt{5}) / 2$
 ... The derivatives ... at z_1 and z_2 are $|1 \pm \sqrt{5}| > 1$.
 Thus, both fixed points are repelling and consequently points of the Julia set ...
 therefore ... each will identify a field line ...
 The potential function ...
 induce[s] a natural decomposition of the escape set ... into level sets ...
 a binary decomposition of ... level sets ... provide[s] a means of identifying field lines and dynamics ...

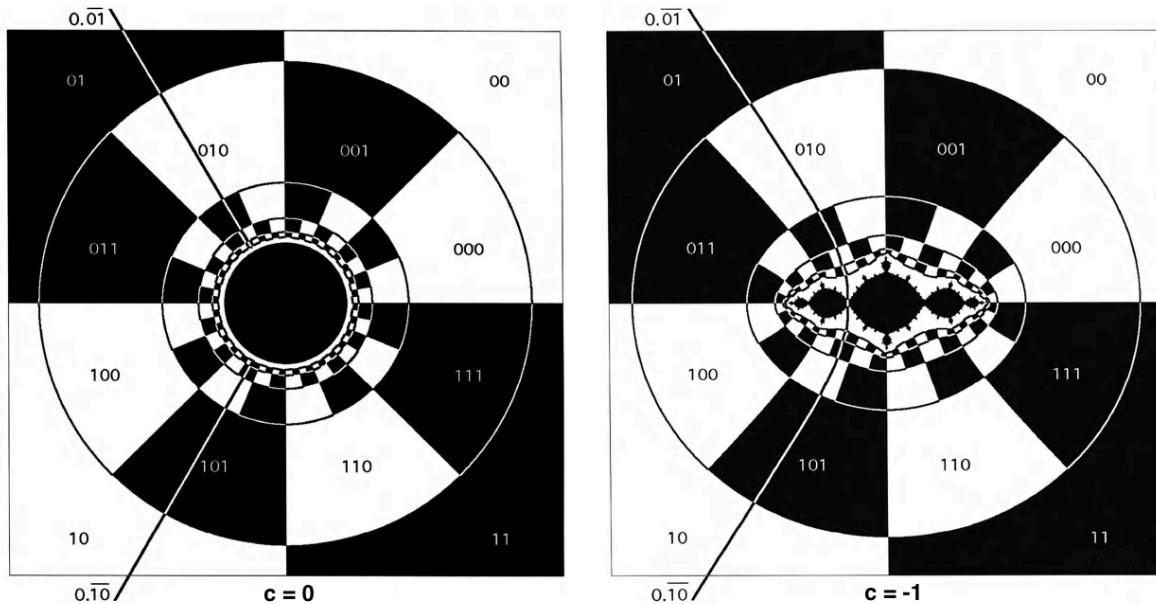

... There are 2^{2n} stage- n cells in a level set ...".
A stage-256 Julia level set based on Binary Decomposition has $2^{256} = \text{about } 10^{77}$ cells so Full Indra Net information can be seen / reflected by each Schwinger Source Indra Jewel.

The **2D Complex Number** Binary Decomposition gives $2^{256} = 10^{77}$ cells distributed over spatial 1D space of $RP1 \times S1$ with $c = 0$ S1 circle and equivalently to $c = -1$ Complex Julia Set. Each of the 2^{256} Indra Schwinger Source Cells is a 1D neighborhood of an S1 Julia Set point. $RP1 \times S1$ can represent a 2D Feynman Checkerboard.

4D Quaternion Binary Decomposition gives $2^{256} = 10^{77}$ cells distributed over spatial 3D space of $RP1 \times S3 = M4$ with $c = 0$ S3 and equivalently to $c = -1$ Quaternion Julia Set. Peitgen and Richter in Beauty of Fractals say

“... A Quaternionic Julia set image by Prokofiev (wikimedia) shows the Quaternion Julia Set for $c = -1$ with a cross-section in the XY plane. in which the corresponding Complex "San Marco fractal" is visible:

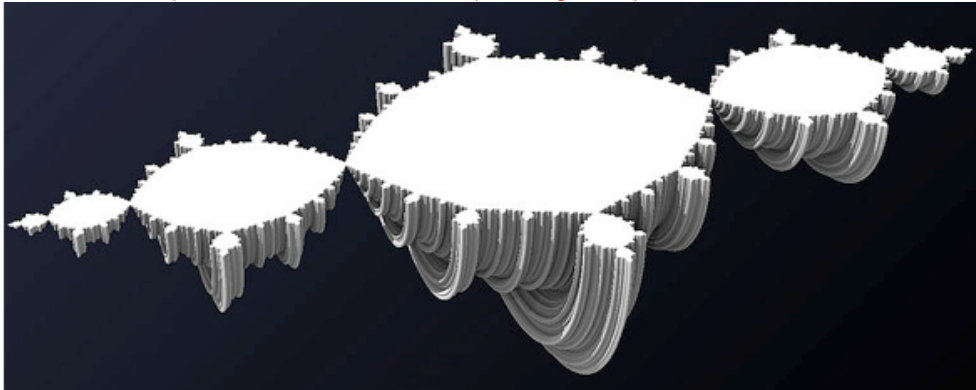

...”. Each of the 2^{256} Indra Schwinger Source Cells is a 3D neighborhood of an S3 Julia Set point. $RP1 \times S3$ can represent 4D Minkowski M4 Spacetime.

8D Octonion Binary Decomposition gives $2^{256} = 10^{77}$ cells distributed over spatial 7D space of $RP1 \times S7$ spacetime with $c = 0$ S7 and equivalently to $c = -1$ Octonion Julia Set. Each of the 2^{256} Indra Schwinger Source Cells is a 7D neighborhood of an S7 Julia Set point. $RP1 \times S7$ can represent 8D M4 x CP2 Kaluza-Klein Spacetime.

16D Sedenion Binary Decomposition gives $2^{256} = 10^{77}$ cells distributed over spatial 15D space of **Bulk 16D spacetime** with $c = 0$ S15 and equivalently to $c = -1$ Sedenion Julia Set. Each of the 2^{256} Indra Schwinger Source Cells is a 15D neighborhood of an S15 Julia Set point. 16D Sedenion can represent 16D Bulk Domain of which $RP1 \times S7$ is Shilov Boundary.

24D Leech Binary Decomposition gives $2^{256} = 10^{77}$ cells distributed over spatial 23D space of **26D String Theory** with $c = 0$ S23 and equivalently to $c = -1$ Julia Set for 24-ons. Each of the 2^{256} Indra Schwinger Source Cells is a 23D neighborhood of an S23 Julia Set point. 24D Leech can represent Fundamental Cells of 26D String Theory with Monster Group Symmetry. 24D Leech corresponds to $B24 = Spin(10)/Spin(7)$ of Porteous showing $Spin(10)$ not transitive on S31

64D Binary Decomposition gives $2^{256} = 10^{77}$ cells distributed over spatial **63D space of A7** with $c = 0$ S63 and equivalently to $c = -1$ Julia Set for 64-ons. Each of the 2^{256} Indra Schwinger Source Cells is a 63D neighborhood of an S63 Julia Set point. 64D can represent 8 Position x 8 Momentum of 8D Octonionic and (4+4)D Kaluza-Klein Spacetimes. $Cl(64) = Cl(8)^8$ is self-reflexive End of Inflation with $dim = 2^{64} = 10^{19} = 10 \times$ Brain Tubulin Dimers.

128D Binary Decomposition gives $2^{256} = 10^{77}$ cells distributed over 128D space of Half-Spinors of $Cl(16)$ with $c = 0$ S127 and equivalently to $c = -1$ Julia Set for 128-ons. 128D also represents Geoffrey Dixon’s T2 Spinor Space.

256D Binary Decomposition gives $2^{256} = 10^{77}$ cells distributed over 256D $Cl(8)$ and Spinors of $Cl(16)$ with $c = 0$ S255 and equivalently to $c = -1$ Julia Set for 256-ons.

16D Sedenions and Higher Cayley-Dickson Algebras have Zero Divisors

Guillermo **Moreno** (arXiv math/0512517) has shown that $V(7,2) = \text{Spin}(7) / \text{Spin}(5)$ can be identified with the Zero Divisors of the 4th Cayley-Dickson Algebra $A_4 = \text{Sedenions}$ for which Zero Divisors are given by the fibration $V(7,2) \rightarrow G_2 \rightarrow S_3$ and which have $7+28 = 35$ Associative Triples and which have $4-2=2$ ZD Irreducible Components and 10-dim Lie Sphere $\text{Spin}(7) / \text{Spin}(5) \times U(1)$ whose 10D correspond to $Cl(1,9) = Cl(2,8)$ Conformal over $Cl(1,7)$ and that $V(15,2) = \text{Spin}(15) / \text{Spin}(13)$ is related to, but not identified with, the Zero Divisors of the 5th Cayley-Dickson Algebra $A_5 = 32\text{-ons}$ which have $35 + 120 = 155$ Associative Triples and which have $8-2=6$ ZD Irreducible Components and 26-dim Lie Sphere $\text{Spin}(15) / \text{Spin}(13) \times U(1)$ whose 26D correspond to 26D String Theory and to 26-dim traceless $J(3,O)_o$ and that $V(127,2) = \text{Spin}(127) / \text{Spin}(125)$ is related to, but not identified with, the Zero Divisors of the 8th Cayley-Dickson Algebra $A_8 = 256\text{-ons}$ which have $1+6+28+120+496+2016+8128=10795$ Associative Triples and which have $64-2=62$ ZD Irreducible Components and 250-dim Lie Sphere $\text{Spin}(127) / \text{Spin}(125) \times U(1)$ whose 256D correspond to 8-Periodicity building block $Cl(8)$.

Robert de Marrais in arXiv 0804.3416 and math.RA/0207003 said "... Moreno ... determines that the automorphism group of the ZD's of all 2^{2n} -ions ... obey a simple pattern: for $n > 4$, this group has the form $G_2 \times (n-3) \times S_3$ (... order-6 permutation group on 3 elements) ... This says the automorphism group of the Sedenions' ZD's has order $14 \times 1 \times 6 = 84$... based on 7 octahedral lattices ("Box-Kites") ...

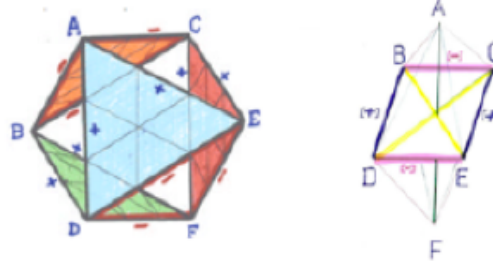

... Harmonics of Box-Kites, called here "Kite-Chain Middens," ... extend indefinitely into higher forms of 2^{2n} -ions. All non-Midden-collected ZD diagonals in the ... 32-ons ... belong... to a set of 15 "emanation tables," ... they house 168 ... $PSL(2,7)$... cells ... 8 ... 32-ons ... ET's ... from $S = 8$ to 15 ...

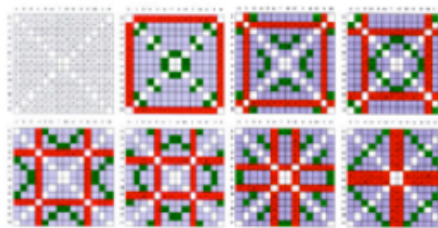

[here are] ... Emanation Tables ... ET's for $S = 15$, $N = 5,6,7$... and fractal limit ...



Schwinger Source: Monster Size and Mandelbrot Julia Structure

This section is motivated by discussion with Jonathan Dickau.

Abstract

Planck Scale is about 10^{-33} cm. Schwinger Source Scale is about 10^{-24} cm, a scale about 10^9 larger than the Planck Scale. The number of particles in the Schwinger Source cloud is determined by the Monster Group Symmetry of the Planck Scale Unit Cells of E8 Physics (viXra 1602.0319). Schwinger Sources have external structure related to Kerr-Newman Black Holes and Bounded Complex Domains whose Bergman Kernels correspond to the Green's Functions of the Schwinger Source. Schwinger Source internal structure is determined by the Octonionic Mandelbrot Set corresponding to each Unit Cell and their Julia Sets. Julia Sets give the Green's Function Potential and Field Lines of the Schwinger Source.

Table of Contents

Schwinger Source Size and the Monster Group ... page 2

Mandelbrot Sets ... page 6

Julia Sets ... page 8

Schwinger Source Structure and Julia Sets ... page 10

Julia Sets of Schwinger Sources and Green's Functions ... page 16

Schwinger Source Size and the Monster Group

Fock “Fundamental of Quantum Mechanics” (1931) showed that it requires Linear Operators “... represented by a definite integral [of a]... kernel ... function ...”.

Hua “Harmonic Analysis of Functions of Several Complex Variables in the Classical Domains” (1958) showed Kernel Functions for Complex Classical Domains.

Schwinger (1951 - see Schweber, PNAS 102, 7783-7788) “... introduced a description in terms of Green’s functions, what Feynman had called propagators ... The Green’s functions are vacuum expectation values of time-ordered Heisenberg operators, and the field theory can be defined non-perturbatively in terms of these functions ...[which]... gave deep structural insights into QFTs; in particular ... the structure of the Green's functions when their variables are analytically continued to complex values ...”.

Wolf (J. Math. Mech 14 (1965) 1033-1047) showed that the Classical Domains (complete simply connected Riemannian symmetric spaces) representing 4-dim Spacetime with Quaternionic Structure are:

$$\begin{aligned} S^1 \times S^1 \times S^1 \times S^1 &= 4 \text{ copies of } U(1) \\ S^2 \times S^2 &= 2 \text{ copies of } SU(2) \\ CP^2 &= SU(3) / SU(2) \times U(1) \\ S^4 = Spin(5) / Spin(4) &= \text{Euclidean version of } Spin(2,3) / Spin(1,3) \end{aligned}$$

Armand Wyler (1971 - C. R. Acad. Sc. Paris, t. 271, 186-188) showed how to use Green’s Functions = Kernel Functions of Classical Domain structures characterizing Sources = Leptons, Quarks, and Gauge Bosons, to calculate Particle Masses and Force Strengths

Schwinger (1969 - see physics/0610054) said: “... operator field theory ... replace[s] the particle with... properties ... distributed throughout ... small volumes of three-dimensional space ... particles ... must be created ... even though we vary a number of experimental parameters ... The properties of the particle ... remain the same ... We introduce a quantitative description of the particle source in terms of a source function ... we do not have to claim that we can make the source arbitrarily small ... the experimenter... must detect the particles ...[by]... collision that annihilates the particle ... the source ... can be ... an abstraction of an annihilation collision, with the source acting negatively, as a sink ... The basic things are ... the source functions ... describing the intermediate propagation of the particle ...”.

Schwinger Sources can be described by continuous manifold structures of Bounded Complex Domains and their Shilov Boundaries
but

the $Cl(16)$ -E8 model at the Planck Scale has spacetime condensing out of Clifford structures forming a Leech lattice underlying 26-dim String Theory of World-Lines with $8 + 8 + 8 = 24$ -dim of fermion particles and antiparticles and of spacetime.

The automorphism group of a single 26-dim String Theory cell modulo the Leech lattice is the Monster Group of order about 8×10^{53} .

When a fermion particle/antiparticle appears in E8 spacetime it does not remain a single Planck-scale entity because Tachyons create a cloud of particles/antiparticles. The cloud is one Planck-scale Fundamental Fermion Valence Particle plus an effectively neutral cloud of particle/antiparticle pairs forming a Kerr-Newman black hole. That Kerr-Newman cloud constitutes the E8 Physics model Schwinger Source.

The cloud structure comes from the 24-dim Leech lattice part of the Monster Group which is $2^{(1+24)}$ times the double cover of Co1, for a total order of about 10^{26} .

Since a Leech lattice is based on copies of an E8 lattice and since there are 7 distinct E8 integral domain lattices there are 7 (or 8 if you include a non-integral domain E8 lattice) distinct Leech lattices. The physical Leech lattice is a superposition of them, effectively adding a factor of 8 to the order, so the volume of the Kerr-Newman Cloud is on the order of 10^{27} x Planck scale and the Kerr-Newman Cloud should contain about 10^{27} particle/antiparticle pairs and its size should be about $10^{(27/3)} \times 1.6 \times 10^{(-33)} \text{ cm} = \text{roughly } 10^{(-24)} \text{ cm}$.

The Monster Group is of order
 8080 , 17424, 79451, 28758, 86459, 90496, 17107, 57005, 75436, 80000, 00000
 =
 $2^{46} \cdot 3^{20} \cdot 5^9 \cdot 7^6 \cdot 11^2 \cdot 13^3 \cdot 17 \cdot 19 \cdot 23 \cdot 29 \cdot 31 \cdot 41 \cdot 47 \cdot 59 \cdot 71$
 or about 8×10^{53}

This chart (from Wikipedia) shows the Monster M and other Sporadic Finite Groups

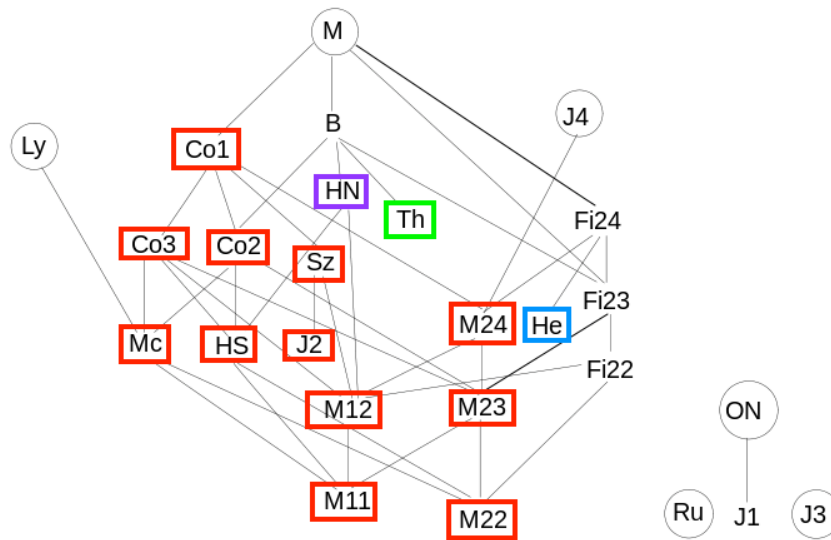

The order of Co1 is $2^{21} \cdot 3^9 \cdot 5^4 \cdot 7^2 \cdot 11 \cdot 13 \cdot 23$ or about 4×10^{18} .

Aut(Leech Lattice) = double cover of Co1.

The order of the double cover $2 \cdot \text{Co1}$ is $2^{22} \cdot 3^9 \cdot 5^4 \cdot 7^2 \cdot 11 \cdot 13 \cdot 23$ or about 0.8×10^{19} .

Taking into account the non-sporadic part of the Leech Lattice symmetry

according to the ATLAS at brauer.maths.qmul.ac.uk/Atlas/v3/spor/M/

the Schwinger Source Kerr-Newman Cloud Symmetry $s 2^{(1+24)} \cdot \text{Co1}$

of order $139511839126336328171520000 = 1.4 \times 10^{26}$

Co1 and its subgroups account for 12 of the 19 subgroups of the Monster M.

Of the remaining 7 subgroups, Th and He are independent of the Co1 related

subgroups and HN has substantial independent structure.

Th = Thompson Group. Wikipedia says "... Th ... was ... constructed ... as the automorphism group of a certain lattice in the 248-dimensional Lie algebra of E8.

It does not preserve the Lie bracket of this lattice, but

does preserve the Lie bracket mod 3, so is a subgroup of the Chevalley group E8(3).

The subgroup preserving the Lie bracket (over the integers) is a maximal

subgroup of the Thompson group called the Dempwolff group (which unlike the

Thompson group is a subgroup of the compact Lie group E8) ...

the Thompson group acts on a vertex operator algebra over the field with 3 elements.

This vertex operator algebra contains the E8 Lie algebra over \mathbf{F}_3 ,

giving the embedding of Th into E8(3) ...

The Schur multiplier and the outer automorphism group of ... Th ... are both trivial.

Th is a sporadic simple group of order $215 \cdot 310 \cdot 53 \cdot 72 \cdot 13 \cdot 19 \cdot 31$

$= 90745943887872000 \approx 9 \times 10^{16}$...".

He = Held Group. Wikipedia says "... The smallest faithful complex representation has dimension 51; there are two such representations that are duals of each other.

It centralizes an element of order 7 in the Monster group. ...

the prime 7 plays a special role in the theory of the group ...

the smallest representation of the Held group over any field is

the 50 dimensional representation over the field with 7 elements ...

He ... acts naturally on a vertex operator algebra over the field with 7 elements ...

The outer automorphism group has order 2 and the Schur multiplier is trivial. ...

He is a sporadic simple group of order $210 \cdot 33 \cdot 52 \cdot 73 \cdot 17$

$= 4030387200 \approx 4 \times 10^9$...".

HN = Harada-Norton Group. Wikipedia says "... The prime 5 plays a special role ...

it centralizes an element of order 5 in ... the Monster group ...and as a result acts

naturally on a vertex operator algebra over the field with 5 elements ... it acts on

a 133 dimensional algebra over \mathbf{F}_5 with a commutative but nonassociative product ...

Its Schur multiplier is trivial and its outer automorphism group has order 2 ...

HN is a sporadic simple group of order $2^{14} \cdot 3^6 \cdot 5^6 \cdot 7 \cdot 11 \cdot 19$

$= 273030912000000 \approx 3 \times 10^{14}$...

HN has an involution whose centralizer is of the form $2.HS.2$, where HS is the Higman-Sims group ... of order $2^9 \cdot 3^2 \cdot 5^3 \cdot 7 \cdot 11 = 44352000 \approx 4 \times 10^7$... [whose] Schur multiplier has order 2 ... [and whose] outer automorphism group has order 2 ... HS is ... a subgroup of ... the Conway groups Co0, Co2 and Co3 ...".

Co1 x Th x He x HN / HS together have order about $4 \times 9 \times 4 \times 10^{(18+16+9+7)}$
= about 10^{52} which is close to the order of M = about 10^{54} .

The components of the Monster Group describe the composition of Schwinger Sources:

Co1 gives the number of particles in the Schwinger Source Kerr-Newman Cloud emanating from a Valence particle in a Planck-scale cell of E8 Physics SpaceTime.

Th gives the 3-fold E8 Triality structure relating 8-dim SpaceTime to First-Generation Fermion Particles and AntiParticles.

He gives the 7-fold algebraically independent Octonion Imaginary E8 Integral Domains that make up 7 of the 8 components of Octonion Superposition E8 SpaceTime.

HN / HS gives the 5-fold symmetry of 120-element Binary Icosahedral E8 McKay Group beyond the 24-element Binary Tetrahedral E6 McKay Group at which level the Shilov Boundaries of Bounded Complex Domains emerge to describe SpaceTime and Force Strengths and Particle Masses.

Mandelbrot Sets

Peitgen, and Richter in *The Beauty of Fractals* (1986) say

“... the Mandelbrot set embodies a principle of the transition from order to chaos more general than the Feigenbaum universality. ... Mandelbrot's ingenuity was to look at complex numbers ... to follow the process ... on a plane ... The focus has shifted to the nature of boundaries between different regions. We can think of centers - attractors - which compete for influence on the plane: an initial point ... is driven by the process to one center or another, or it is on the boundary and cannot decide.

If the parameter is changed, the regions belonging to the attractors change, and with them the boundaries. It can happen that the boundary falls to dust, and this decay is one of the most important scenarios. ... Mandelbrot's process is ... $x \rightarrow x^2 + c$...

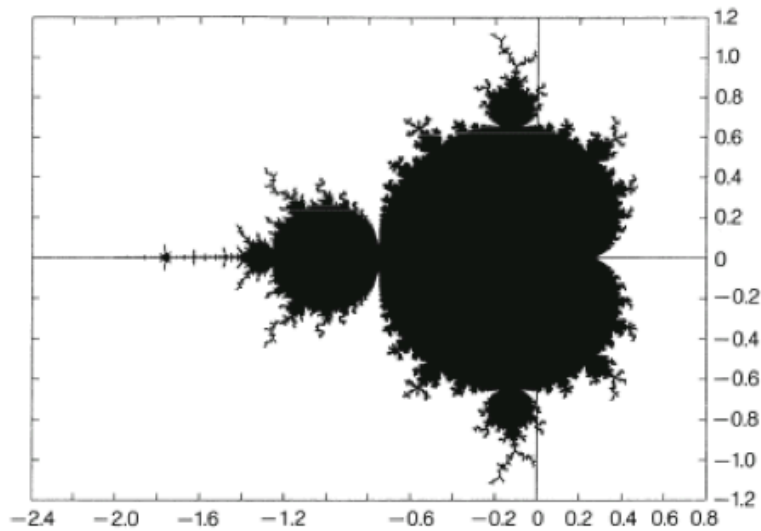

... Charged Mandelbrot set with equipotential and field lines ...

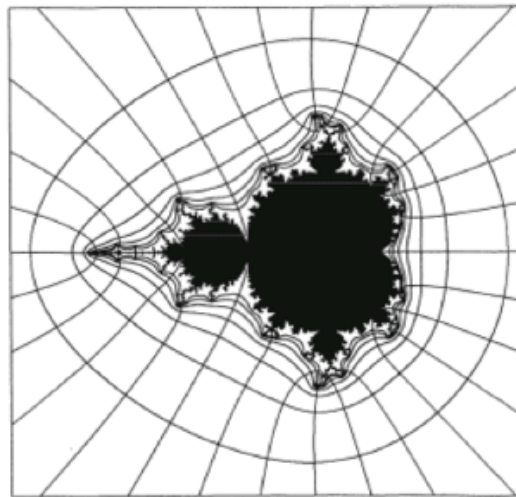

... Level sets ... in alternating colors for c in \mathbf{M} ... Outside of \mathbf{M} : equipotential lines ...

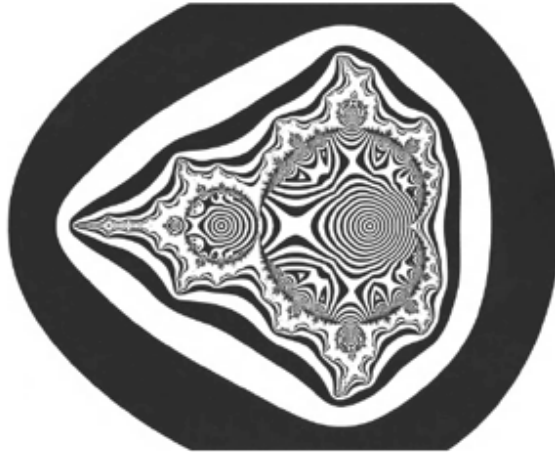

... Domains of index (c) = constant ... Indices organize according to Fibonacci sequences. Outside of \mathbf{M} : equipotential lines ...”.

The Complex Mandelbrot set is symmetric about the real axis, so it has symmetry of the dihedral group of order 2. For details see <https://www.math.uwaterloo.ca/~wgilbert/FractalGallery/Mandel/MandelMath.html>

The symmetry group dihedral(2) for the Mandelbrot set of $f(z) = z^2 + c$ can be expanded to the Binary Dihedral Group $\{2,2,2\}$ by going from 2-dim Complex Numbers to Quaternions of 4-dim M4 SpaceTime. McKay says: “... $D[4] \{2,2,4-2\}$ Generalized quaternion $[4-2]$...”.

$D[4]$ is the D_4 Lie algebra $Spin(8)$, the bivector Lie Algebra of the $Cl(8)$ Clifford Algebra that by Real Clifford Algebra 8-Periodicity tensor product produces $Cl(8) \times Cl(8) = Cl(16)$ which contains 248-dim E_8 as 120-dim D_8 + 128-dim half-spinor D_8 and by completing the union of all tensor products of $Cl(16)$ produces an AQFT. The corresponding String Theory, with Strings seen as World-Lines of Particles, has Planck-scale local lattice structure each cell of which has Monster Group symmetry.

Here is a Quaternionic Mandelbrot set image by Mikael Hvidtfeldt Christensen:

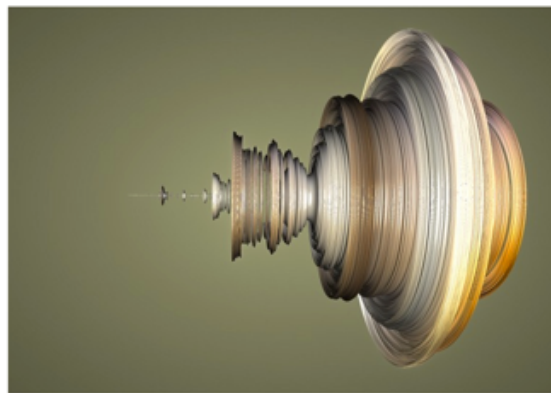

it is basically a 2-dim Mandelbrot set rotated about the real axis. An Octonionic Mandelbrot set would be similar, so the Complex Mandelbrot Set gives most of the useful structure.

Julia Sets

Points of the Mandelbrot Set represent Julia Sets.

Characteristics of the Julia Sets and Bifurcations vary with their position on the Mandelbrot Set. First consider positions along the Real Axis from $-L = -2$ to $-L = 0.25$:

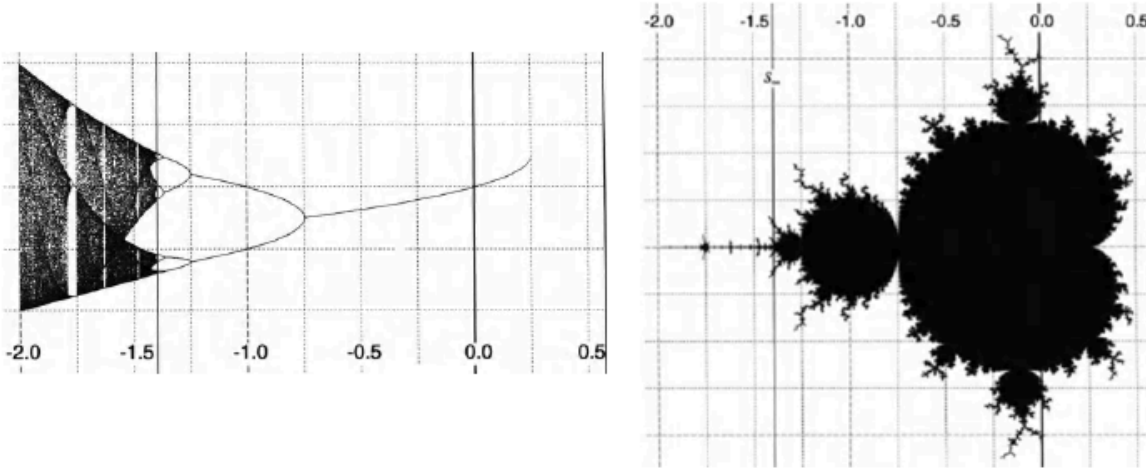

(images above from Peitgen, Jurgens and Saupe, Chaos and Fractals)

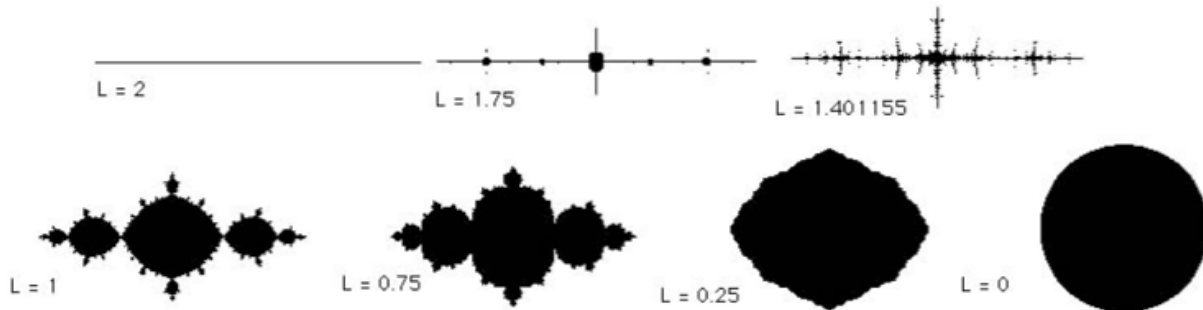

Lennart Carleson and Theodore W. Gamelin in their book *Complex Dynamics* say:
 "... Let us see how the Julia set changes shape as c moves along the real axis.
 If we move c to the right of $1/4$, it leaves the Mandelbrot set and the Julia set becomes totally disconnected. ...the cauliflower set, corresponding to $c = 1/4$... is a simple closed Jordan curve ... though it cannot be a quasicircle due to the cusps.
 ... the Julia set for $c = -3/5$... is a quasicircle, symmetric with respect to R .
 ... at the left edge of the main cardioid we arrive at the point $c = -3/4$...
 There are two petals at $-1/2$, which cycle back and forth. ...

When we continue to the left of $-3/4$, the fixed point bifurcates to an attracting cycle of length two, corresponding to the two petals.

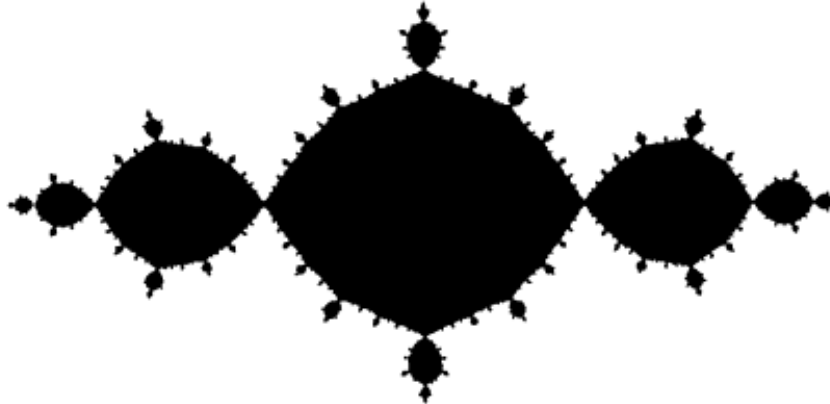

FIGURE 8. $c = -1$, superattracting cycle of period two.

This process is called "budding," and the point $-3/4$ is the "root" of the bud. ...

For $c = -1$, we have the superattracting cycle $0 \rightarrow -1 \rightarrow 0$ pictured in Figure 8. The basic shape of the Julia set is preserved as we cross from $c = -3/5$ over $c = -3/4$ to $c = -1$.

At $c = -5/4$ we have a parabolic cycle of petals of order 4, and there is further budding. Continuing to decrease c gives a sequence

$c_0 > c_1 > c_2 > \dots$ of parameter values corresponding to parabolic cycles of order n . In the complementary intervals, there are attracting cycles of order n . This behavior is known as the period doubling of Feigenbaum, and $c_n \rightarrow c_\infty = -1.401$.

In the interval $[-2, c_\infty]$ periods of many different orders occur ...".

Here, near their locations on the Mandelbrot Set, are some Julia Sets useful in describing Schwinger Source Geometry: $c = -2$, $c = -1$, $c = i$, $c = 0$, $c = -i$:

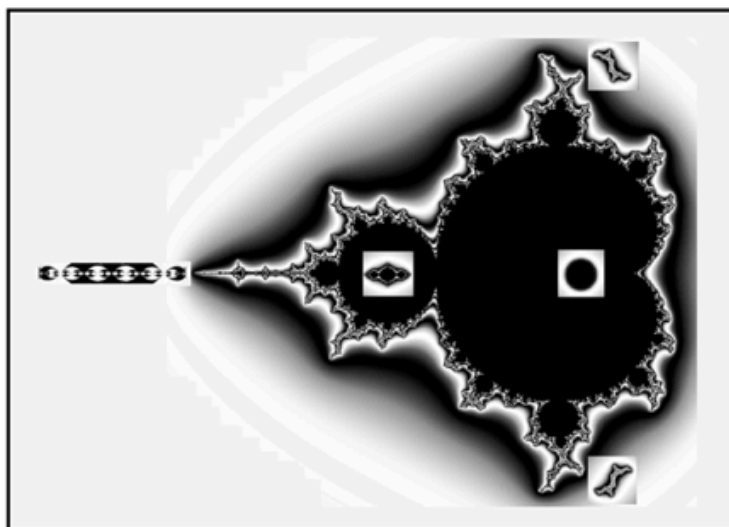

(image from Mandelbrot and Julia by Dany Shaanan and by Peitgen, Jurgens, and Saupe)

Schwinger Source Structure and Julia Sets

Planck scale is about $10^{(-33)}$ cm. Schwinger Source Scale is about $10^{(-24)}$ cm.
What is the structure of the cloud in the 10^9 Planck units between those scales ?

My conjecture is that it may be Fractal Julia Set structure.

Mark McClure on the Math Stack Exchange 30 May 2013 said:

“... Julia sets of rational functions can be computed using an inverse iteration technique that shows them to be something close to self-similar. This helps explain the extreme regularity displayed when zooming into *most* Julia sets. For example, here we zoom in to the Julia set for $f(z) = z^2 - 1$ increasing the magnification by a factor of the Golden ratio with each step. ...

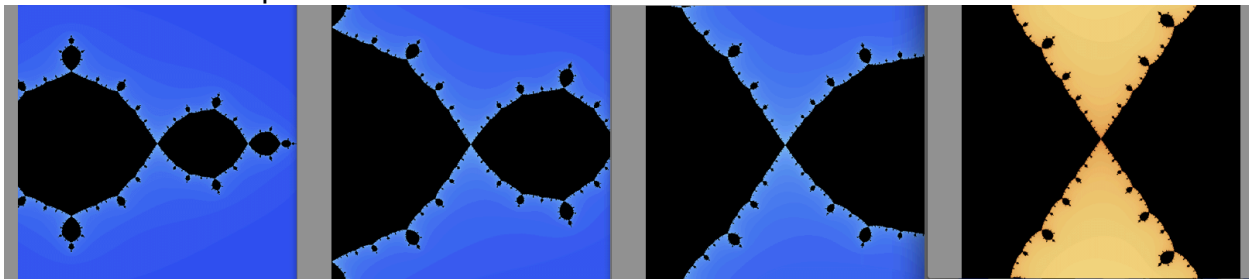

The first three images are at steps 0, 1, and 2. The fourth image is at step 41. Since $1.6^{41} = 2.3 \times 10^8$, the same similarity exists all the way down from Schwinger Source scale $10^{(-24)}$ cm to the Planck scale $10^{(-33)}$ cm.

How would such a Julia Set emerge from a single Fundamental Fermion Particle ?

At the Planck-scale E8 Lattice level each Fundamental Fermion Particle is represented by an Octonion Basis Element

- 1 - Neutrino**
- i - Red Down Quark**
- j - Green Down Quark**
- k - Blue Down Quark**
- E - Electron**
- I - Red Up Quark**
- J - Green Up Quark**
- K - Blue Up Quark**

If the Red Down Quark represented by i is at the origin of Planck-scale E8 SpaceTime then a Virtual Cloud of Particles will form around it.

Let z be the Octonion representing the first Particle to appear in the Virtual Cloud. Then form the Octonion Product z^2 and add to it the Octonion i of the Red Down Quark and let that $z^2 + i$ represent the second particle to appear in the Virtual Cloud. Then iterate the process many times. Peitgen and Richter in Beauty of Fractals say "... for the process $x \rightarrow x^2 + c$... $c = i$... Figure 12 shows the example $c = i$...

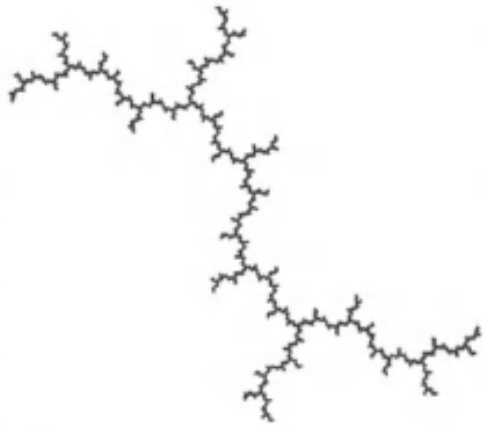

*Dendrite,
for the process $x \mapsto x^2 + c$
 $c = i$*

... Such dendrites have no interior, there is no attractor other than the one at infinity. The Julia set is now just the boundary of a single domain of attraction and contains those points that do not go to that attractor ...".

Note that the Beauty of Fractals material assumes 2-dim Complex Numbers whereas realistic physics requires 4-dim Quaternions for M4 Physical SpaceTime and 8-dim Octonions for Inflationary Era E8 Physics.

4-dim Quaternions are needed for j - Green Down Quark and k - Blue Down Quark
 A Quaternionic Julia set image by Prokofiev (wikimedia) shows the Julia Set for Imaginary Quaternion basis elements $\{ i, j, k \}$ with a cross-section in the XY plane in which the "dendrite" Complex Julia Set is visible:

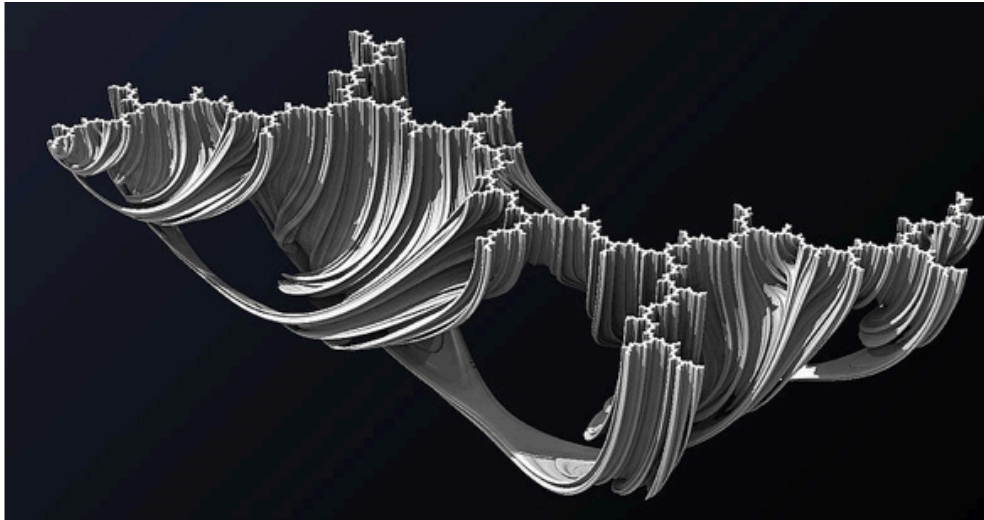

8-dim Octonions are needed for E - Electron and I - Red Up Quark and J - Green Up Quark and K - Blue Up Quark

Octonionic images would be similar to the Quaternionic with rotation about the real axis, so the Complex Julia Sets give most of the useful structure.

In the Octonion Julia Set, the 7+7 imaginaries $\pm i, \pm j, \pm k, \pm E, \pm I, \pm J, \pm K$ are all located on the unit 7-sphere S^7 centered on the origin $c = 0$.

Julia Sets for all points on that S^7 are of the same type - dendrite - as for i and $-i$.

Geoffrey Dixon (see Division Algebras, Lattices, Physics, Windmill Tilting, section 4.1) has defined an **X-Product for the unit Octonions on a 7-sphere S^7** :

“... Let A, B, X be Octonions, with X a unit Octonion ...

Define $A \text{ ox } B = (AX)(X^*B) = (A(BX)X^* = X((X^*A)B)$ the X-product of A and B .

Because of the nonassociativity of O , $A \text{ ox } B \neq AB$ in general.

But remarkably, for fixed X , the algebra O_x (O endowed with the X-product) is isomorphic to O itself. Modulo sign change each X gives rise to a distinct copy of O ...”.

What about 1 - Neutrino and -1 Anti-Neutrino ?

The 1 and -1 of the Neutrino and Anti-Neutrino do not represent the 1 and -1 on the real axis of the Mandelbrot Set. They represent the 1 and -1 on the Julia Set S^7 defined by the Dixon X-Products of the 7 imaginary basis elements $\{i,j,k,E,I,J,K\}$.

What about Standard Model Spin 1 Gauge Bosons ?

They can be represented as antisymmetric pairs of representative Fermions and therefore as points on the Julia Set S^7 defined by the Dixon X-Products.

What about the Higgs Spin 0 Scalar ?

Higgs can be represented by the Julia Set of the point $c = 0$ on the Mandelbrot real axis.

What about the Conformal Spin(2,4) = SU(2,2) Graviphoton Spin 1 Bosons ?

The Conformal Bosons of Gravity and Dark Energy can be represented by the Julia Set of the point $c = -1$ on the Mandelbrot real axis.

Peitgen and Richter in Beauty of Fractals say

“... The Inverse Iteration Method (IIM) ... should give a good picture of [the Julia Set] ... if ... it is uniformly distributed over [the Julia Set] ... Figure 26 ... show[s] ...[a] Julia Set from the quadratic family ... $x^2 + c$... [and $c = -1$] ...

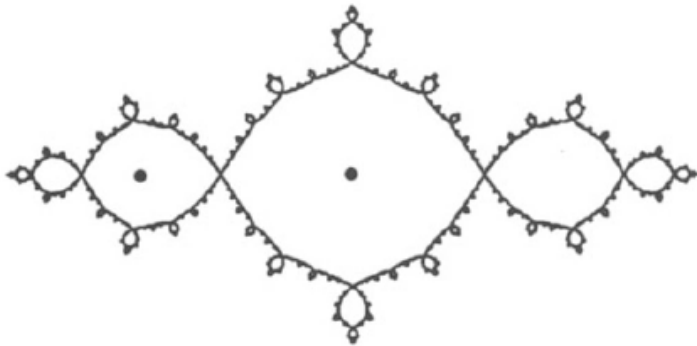
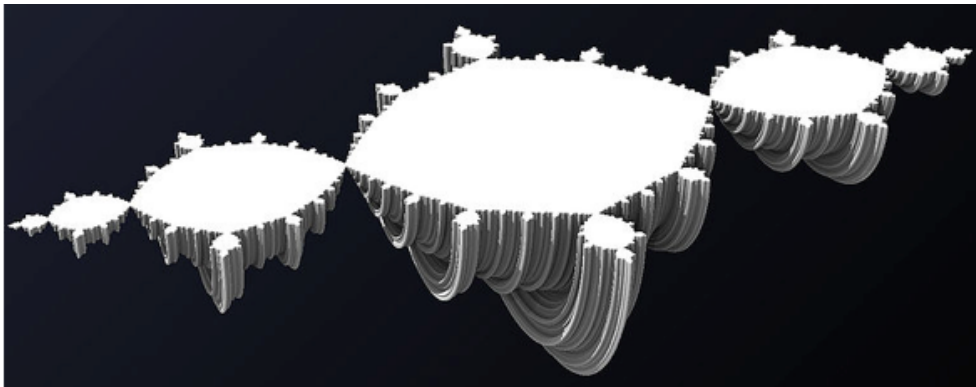

Fig. 26. $J_R, R(x) = x^2 + c$ and $c = -1$
 $\{0, -1\}$ is a super-attractive cycle

... the tips of [the Julia Set] are visited most frequently, while the branch points seem to be avoided most often. Nevertheless ... the non uniformity has little effect on Fig.26 ...”. A Quaternionic Julia set image by Prokofiev (wikimedia) shows the Quaternion Julis Set for $c = -1$ with a cross-section in the XY plane. in which the corresponding Complex "San Marco fractal" is visible:



What about the Bohm Quantum Potential Spin 2 Bosons ?

The Bohm Quantum Potential Spin 2 Bosons can be represented by the Julia Set of the point $c = -2$ on the Mandelbrot real axis.

Peitgen and Richter in Beauty of Fractals say "... Equipotential and field lines for the Julia set of $x \rightarrow x^2 + c$, $c = -2$...

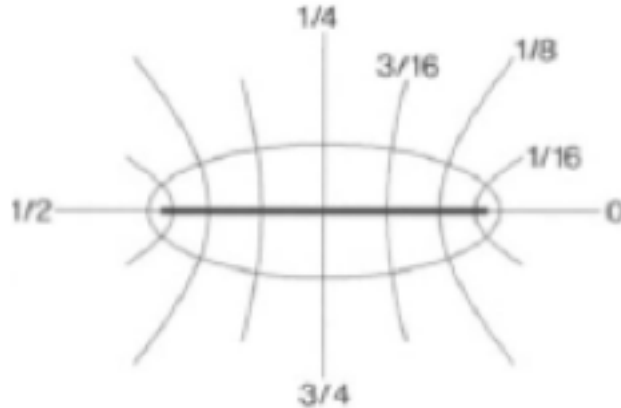

... a binary decomposition ...

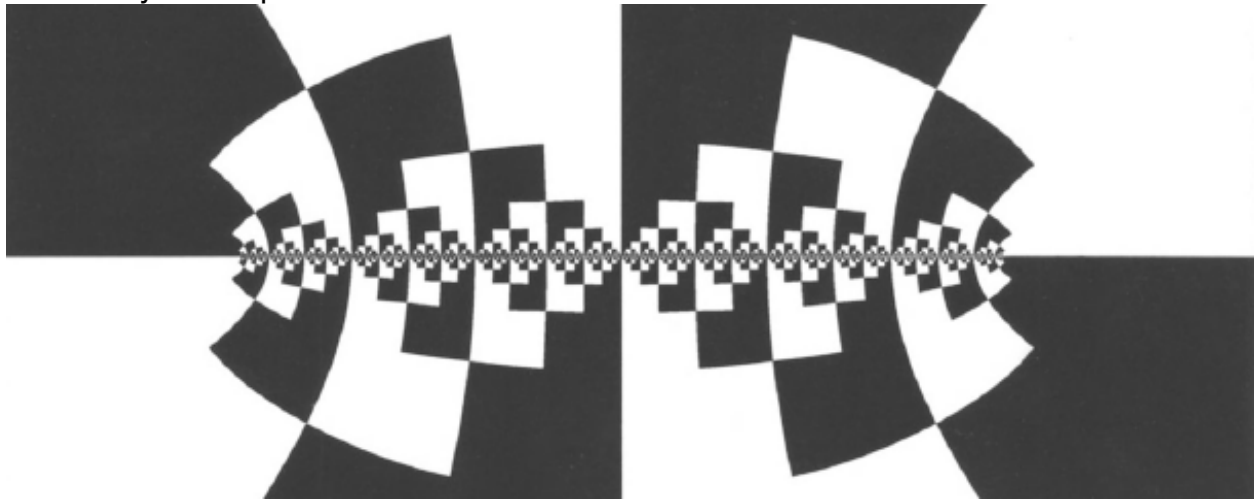

...”.

Peitgen, Jurgens, and Saupe in Chaos and Fractals say
“... Encirclements for ... $c = -2$...

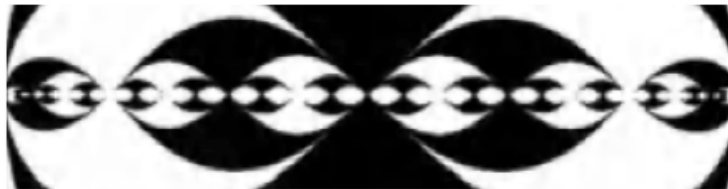

... for $c = -2$... the Julia set is a single connected set ...”.

According to usefuljs.net web page on Julia Sets and The Mandelbrot Set:

“... Why is ... $J(z^2 - 2)$ a straight line?

It's easier to understand if we imagine the inverse iteration: start with a circle of radius 2 and then repeatedly apply the iteration function: $z \rightarrow \sqrt{z - c}$... $c = -2$...

Each iteration, we shift all points of the circle left by 2 (which discards half of the points).

We then take the square root which has three effects:

values whose magnitude is > 1 contract,

values whose magnitude is < 1 expand

and the square root creates a mirror image since each number has two square roots.

The result is two teardrops that are pinched at the origin.

Repeat and you double the pinched teardrops each iteration while making them smaller.

At infinity, the repeated pinching has made the tear drops infinitesimally small,

leaving a straight line segment. ...

The Julia set of $z^2 - 2$ after 1, 2, 3, 4, 20 and 10000 iterations ...

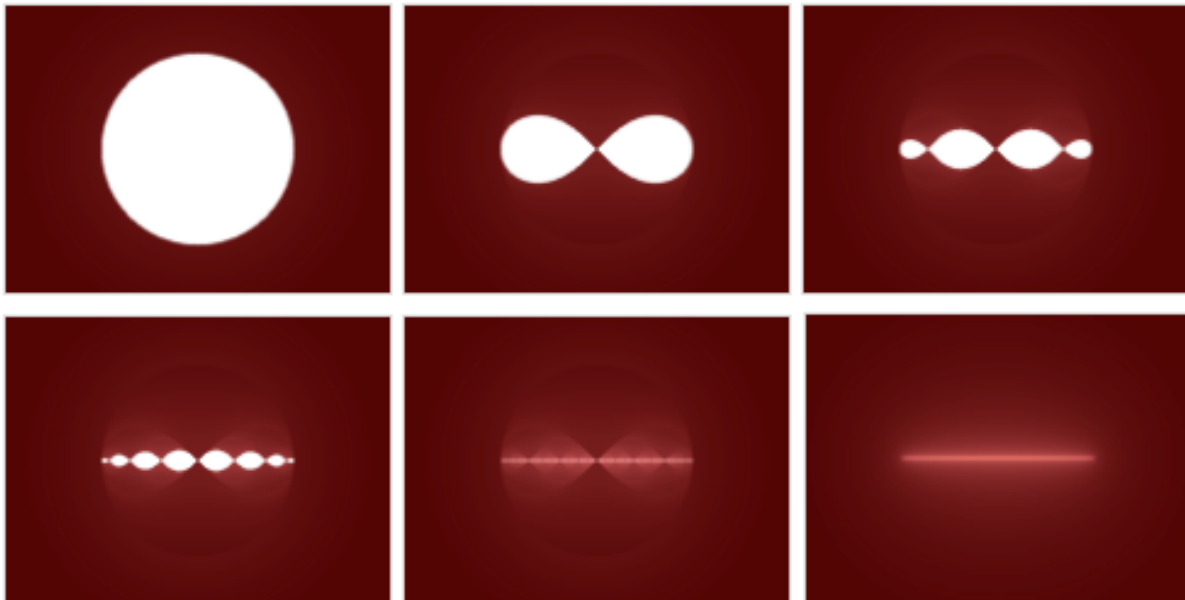

”
...

Julia Sets of Schwinger Sources and Green's Functions

The Schwinger Source Particles that we deal with experimentally are Kerr-Newman Cloud Shilov Boundaries of Bounded Complex Domains that have symmetry from the 24-dim Leech lattice part of the Monster Group and have volume about 10^{27} Planck Volumes and size about $10^{(-24)}$ cm.

The Bounded Complex Domain structure of each Schwinger Source gives it (through Bergman Kernel) a Green's Function for its force interactions. The Green's Function is manifested in the interior of the Schwinger Source Cloud by Julia Set organization of the component small particles in the Cloud.

Each cell of the Planck-scale local lattice has a Mandelbrot structure that contains potential Julia Sets. When a Valence Particle manifests itself at a cell of the Planck-scale local lattice it uses a Julia set with matching Green's Function.

M. F. Barnsley, J. S. Geronimo, and A. N. Harrington say in Geometrical and Electrical Properties of Some Julia Sets (Georgia Tech August 1982) "... electrical properties of Julia sets of an arbitrary potential ... are developed with the aid of the Bottcher equation and Green's star domains ... We use Julia sets for $T(z) = (z - L)^2$ as examples and relate the electrical properties to the geometry of the Julia set ...".

Peitgen, Jurgens, and Saupe in Chaos and Fractals (1992) say "... points for which the iteration escapes ... is called the escape set ... The iteration for all other initial values remains in a bounded region forever ... the ... prisoner set ... the boundary ... between the basins of attraction ... is ... the Julia set ... Encirclement of the Prisoner Set ... [by] iteration ... [of] approximation ... shad[ing] the encirclements ... using alternating black and white sets ... for $c = -2$... $c = -1$... $c = i$...

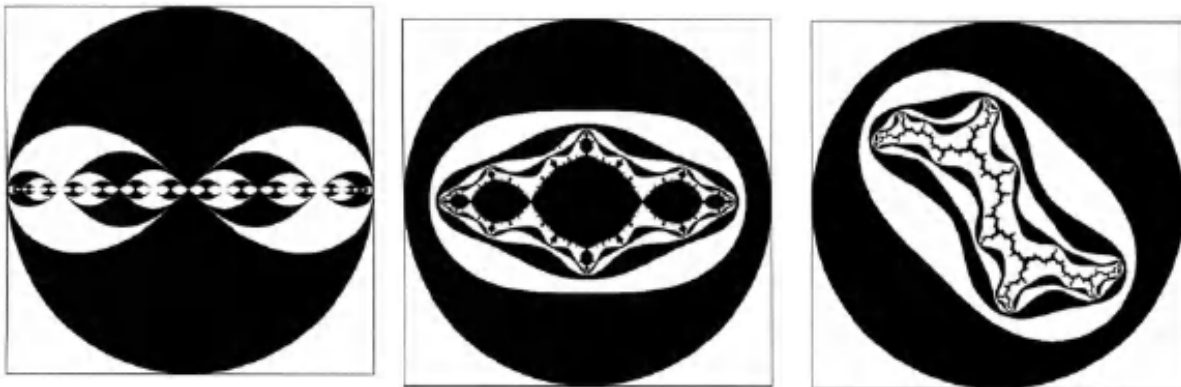

... Think of the prisoner set as a piece of metal charged with electrons ... produc[ing] an electrostatic field in the surrounding space ... [which has] field lines ... an electrostatic field ... is conservative ... there is ... a potential function ... equipotential surfaces ... on which the potential is constant ... are perpendicular everywhere to the direction of the electrostatic field ... the intensity of the field is inversely proportional to the distance between equipotential surfaces ... Riemann Mapping Theorem ... [gives] A one-to-one correspondence between the potential of the unit disk and the potential of any connected prisoner set ...

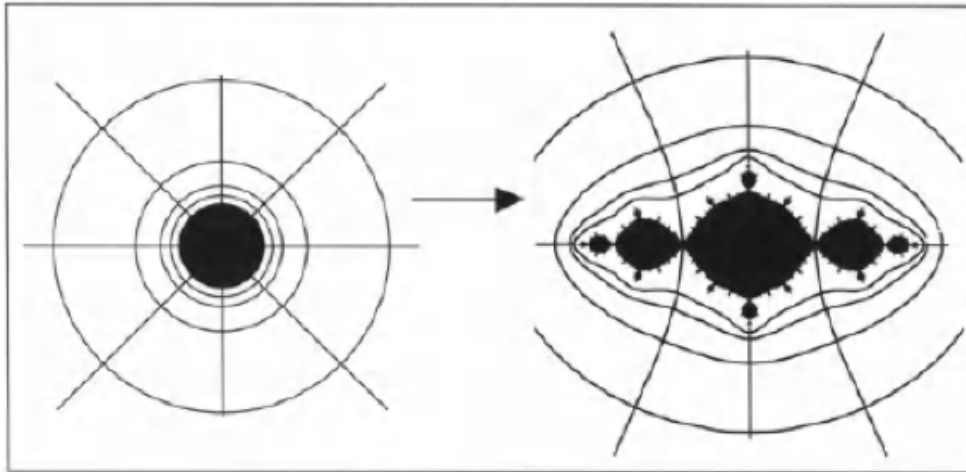

... Equipotential and field lines for $c = -1$.

The angles of the field lines are given in multiples of 2π ...

Binary decomposition for $c = -1$... [and] $c = i$...

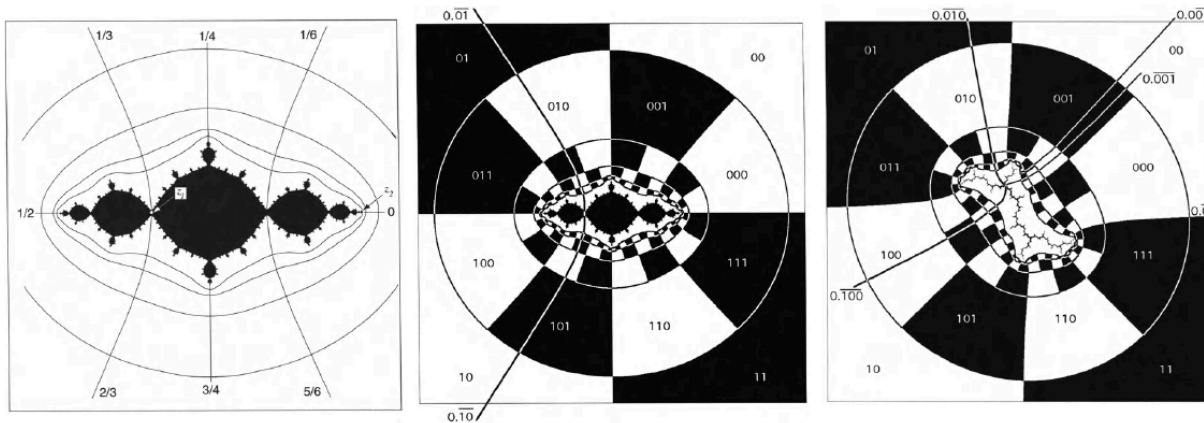

... potential ... level sets capture ... the magnitude of the iterates ...

Now ... turn to the binary decomposition of these level sets ...

There are 2^n stage- n cells in a level set ...

Binary decomposition allows us to approximate arbitrary field lines of the potential.

the labelling of these cells converges to the binary expansion of the angles of the field lines passing through the cells ... Only in the limit ... do field lines become ... straight ...

from the point of view of field line dynamics ... the dynamics of $z \rightarrow z^2 + c$, $c \neq 0$, acts like angle doubling, just as for $c = 0$...”.

Tomoki Kawahira of the math department of Tokyo Institute of Technology says
“...The black and white pictures below show ... Potential functions (Green functions) ...
defined outside the (filled) Julia sets ...

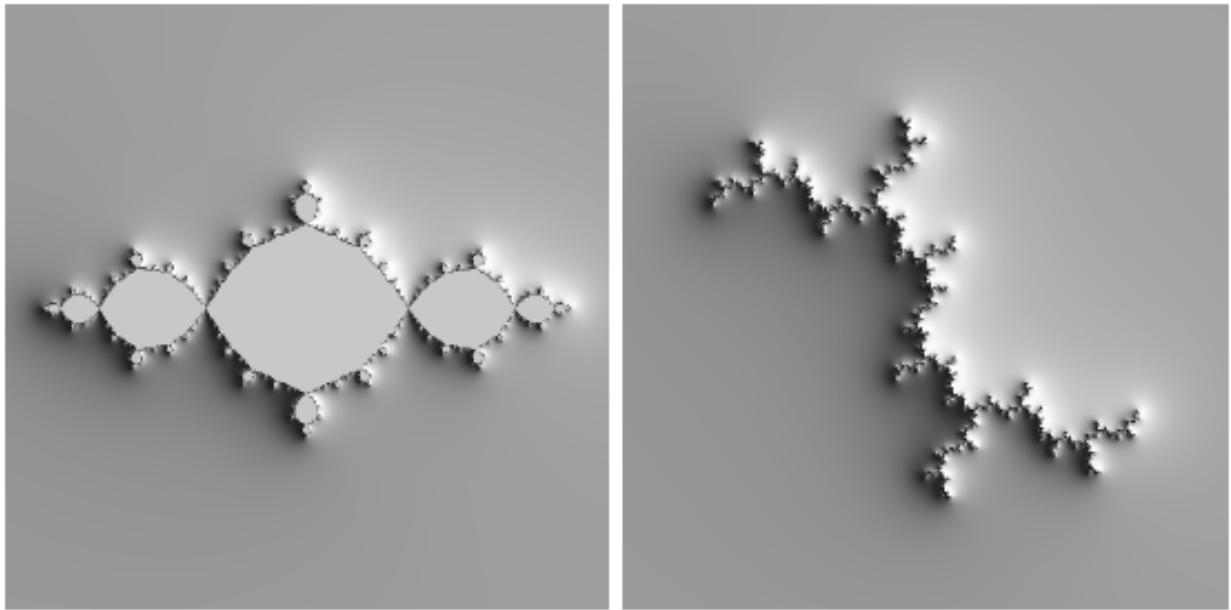

...”

Here are the corresponding Field Lines from 2008 YouTube of ImpoliteFruit for
Julia fractal, X axis (Distance and field lines) and
Julia fractal, Y axis (Distance and field lines):

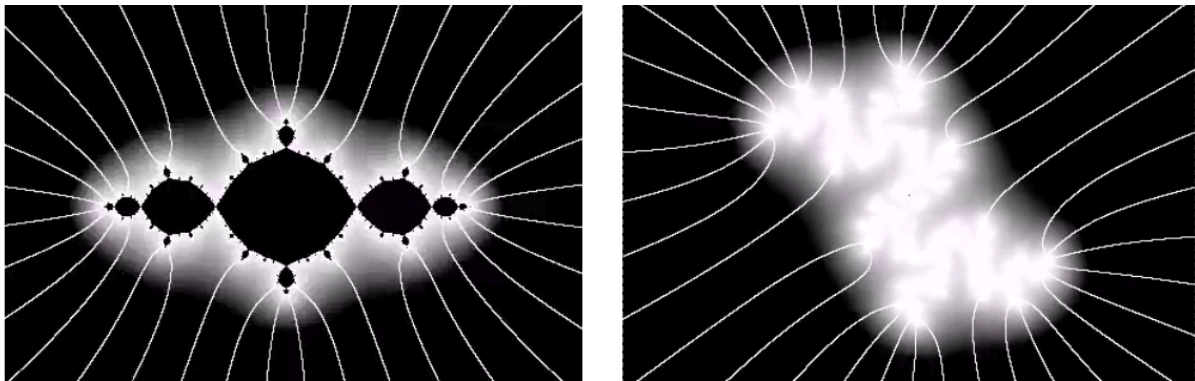

Indra's Net

“... "Indra's net" is the net of the Vedic deva Indra, whose net hangs over his palace on Mount Meru, the axis mundi of Buddhist and Hindu cosmology. In this metaphor, Indra's net has a multifaceted jewel at each vertex, and each jewel is reflected in all of the other jewels ... the image of "Indra's net" is used to describe the interconnectedness of the universe ... Francis H Cook describes Indra's net thus:

“Far away in the heavenly abode of the great god Indra, there is a wonderful net ... a single glittering jewel in each "eye" of the net ... in ... each of the jewels ... its polished surface ... reflect[s] all the other jewels in the net ... Not only that, but each of the jewels reflected in this one jewel is also reflecting all the other jewels ...” “.

Image from <https://brightwayzen.org/meetings-placeholder/indras-net-honoring-interdependence-scales/> :

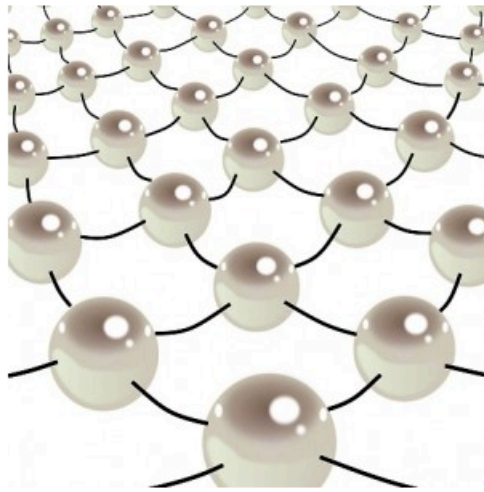

In realistic E8 Physics (viXra 1602.0319 and 1701.0495 and 1701.0496)
each Indra Jewel is a Schwinger Source.

26D J(3,0) String Theory - Bohm Quantum Potential

To understand **Schwinger Sources of E8 Physics start with 26D String Theory**:
interpret **Strings as World-Lines** of Particles and
spin-2 String Theory 24x24 symmetric matrices
as carriers of Bohm Quantum Potential (not gravitons).

Luis E. Ibanez and Angel M. Uranga in “String Theory and Particle Physics” said:
“... String theory proposes ... small one-dimensional extended objects, strings,
of typical size $L_s = 1/M_s$, with M_s known as the string scale ...
As a string evolves in time, it sweeps out a two-dimensional surface in spacetime,
known as the worldsheet, which is the analog of the ... worldline of a point particle ...
for the bosonic string theory ... the classical string action is the total area spanned by
the worldsheet ... This is the ... Nambu– Goto action ...”.

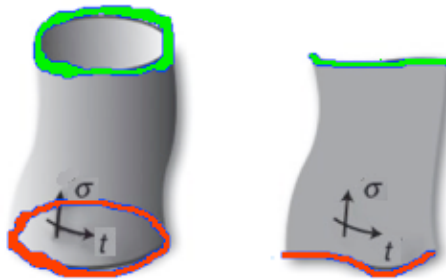

(images adapted from “String Theory and Particle Physics” by Ibanez and Uranga)
In my unconventional view the red line and the green line are different strings/
worldlines/histories and the world-sheet is the minimal surface connecting them,
carrying the Bohm Potential.

The t world-sheet coordinate is for Time of the string-world-line history.
The σ world-sheet coordinate is for Bohm Potential Gauge Boson at a given Time.
Further, Ibanez and Uranga also said:
“... The string groundstate corresponds to a 26d spacetime tachyonic scalar field $T(x)$.
This tachyon ... is ... unstable

...

The massless two-index tensor splits into irreducible representations of $SO(24)$...
Its trace corresponds to a scalar field, the dilaton ϕ , whose vev fixes the string
interaction coupling constant g_s

...

the antisymmetric part is the 26d 2-form field B_{MN}

...

The symmetric traceless part is the 26d graviton G_{MN} ...”.

My interpretation of the symmetric traceless part
differs from that of Ibanez and Uranga in that it
is the carrier of the Bohm Quantum Potential.

Closed string tachyons localized at orbifolds of fermions produce virtual clouds of particles / antiparticles that dress fermions.

Dilatons are Goldstone bosons of spontaneously broken scale invariance that (analogous to Higgs) go from mediating a long-range scalar gravity-type force to the nonlocality of the Bohm-Sarfatti Quantum Potential.

The antisymmetric $SO(24)$ little group is related to the Monster automorphism group that is the symmetry of each cell of Planck-scale local lattice structure.

Joe Polchinski in "String Theory, Volume 1, An Introduction to the Bosonic String" said: "... we find at $m^2 = -4/\alpha'$ the tachyon, and at $m^2 = 0$ the 24×24 states of the graviton, dilaton, and antisymmetric tensor ...".

My interpretation of what Polchinski describes as the graviton differs from that of Polchinski in that it is the carrier of the Bohm Quantum Potential.

The 24×24 Real Symmetric Matrices form the Jordan Algebra $J(24, \mathbb{R})$. Jordan algebras correspond to the matrix algebra of quantum mechanical states, that is, from a particle physics point of view, the configuration of particles in spacetime upon which the gauge groups act. 24 -Real-dim space has a natural Octonionic structure of 3 -Octonionic-dim space. The corresponding Jordan Algebra is $J(3, \mathbb{O}) = 3 \times 3$ Hermitian Octonion matrices. **Their 26 -dim traceless part $J(3, \mathbb{O})_0$ describes the 26 -dim of Bosonic String Theory and the algebra of its Quantum States, so that**

the 24×24 traceless symmetric spin-2 particle is the Quantum Bohmion that carries the Bohm Quantum Potential for interactions among Strings = World-Line Histories of Schwinger Sources.

26D J(3,O)o String Theory - Lagrangian Structure

The 26-dim traceless part J(3,O)o of 27-dim Jordan Algebra J(3,O)

gives a realistic Lagrangian. J(3,O)o has

2 of its 3 Octonion parts as 8+8=16-dim representation of 8 first-gen Fermions

and 26-16 = 10-dim as String Theory spacetime that decomposes into

Kaluza-Klein 6-dim Conformal space of Spin(2,4) x 4-dim CP2 = SU(3) / SU(2)xU(1)

which then gives 4-dim M4 x 4-dim CP2 Kaluza-Klein.

The conformal Spin(2,4) gives Gravity via MacDowell-Mansouri

The CP2 gives Standard Model SU(3) x SU(2) x U(1) via Batakis

Decomposition to M4 x CP2 Kaluza-Klein gives Higgs via Mayer-Trautman

and gives 2nd and 3rd generations of fermions.

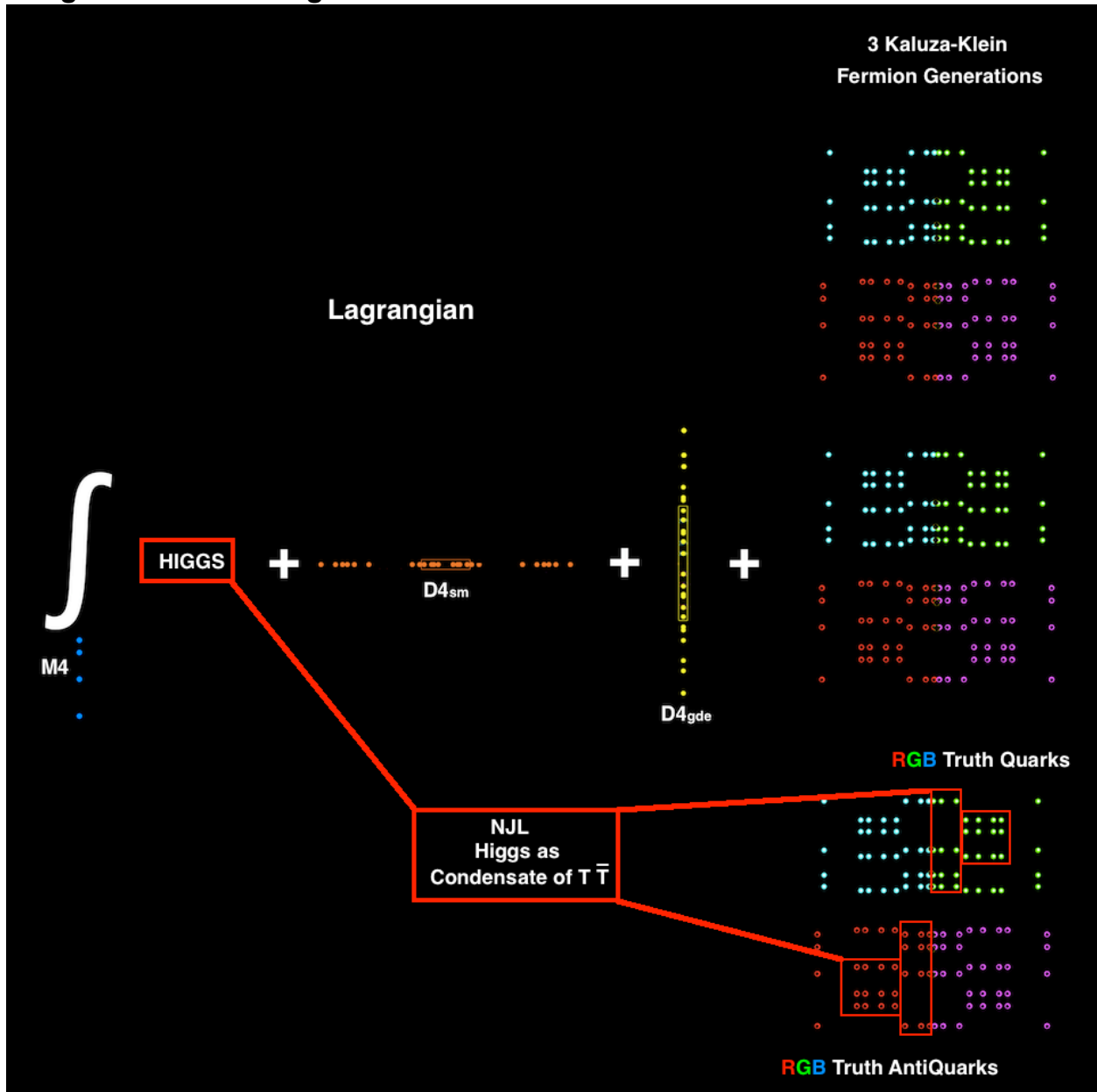

J(3,0) represents Lie Algebra F4 - Two copies of F4 give E8 Physics

F4 lives in the Real Clifford Algebra Cl(8) as
 52-dim F4 = 8-dim Vectors of Cl(8) + 28-dim D4 BiVectors of Cl(8) + 16-dim D4 Spinors
 16-dim D4 Spinors of F4 can be represented by anti-commutators and commutators
 (via Ramond and viXra 1208.0145) so they can physically represent Fermions.

By 8-Periodicity of Real Clifford Algebras the tensor product Cl(8) x Cl(8) = Cl(16).
 E8 lives in the Real Clifford Algebra Cl(16) as
 248-dim E8 = 120-dim D8 BiVectors of Cl(16) + 128-dim D8 Half-Spinors

Label the two copies of Cl(8) as Cl(8)sm and Cl(8)grav because

Cl(8)sm contains F4sm and D4sm with subalgebra SU(3) of Standard Model
 as well as ghosts of Conformal Gravity

and

Cl(8)grav contains F4grav and D4grav with subalgebra Spin(2,4) of Gravity
 as well as ghosts of Standard Model

$$120\text{-dim D8 of E8} = 28\text{-dim D4sm} \times 1\text{grav} + 1\text{sm} \times 28\text{-dim D4grav} + 8\text{vsm} \times 8\text{vgrav}$$

$$\mathbf{64\text{-dim } 8\text{vsm} \times 8\text{vgrav} = 63\text{-dim } \mathbf{A7+1}}$$

where **A7 = SL(8,R) of UniModular 8-dim Spacetime**

$$\begin{aligned} 256\text{-dim D8 Spinors} &= (8\text{+hspD4grav} + 8\text{-hspD4grav}) + (8\text{+hspD4sm} + 8\text{-hspD4sm}) = \\ &= (8\text{+hspD4grav} \times 8\text{+hspD4sm} + 8\text{+hspD4grav} \times 8\text{-hspD4sm}) + \\ &+ (8\text{-hspD4grav} \times 8\text{+hspD4sm} + 8\text{-hspD4grav} \times 8\text{-hspD4sm}) \end{aligned}$$

so

since the D4grav Half-Spinors determine whether D8 Half-Spinors
 represent normal (8+hspD4grav) or mirror (8-hspD4grav) Fermions
 since E8 only contains normal Fermions

$$\begin{aligned} \mathbf{128\text{-dim D8 Spinors}} &= 8\text{+hspD4grav} \times (8\text{+hspD4sm} + 8\text{-hspD4sm}) \\ &= (8\text{+hspD4grav} \times 8\text{+hspD4sm} + 8\text{+hspD4grav} \times 8\text{-hspD4sm}) \\ &= \mathbf{8 \text{ components of 8 Gen1 Fermion Particles} +} \\ &+ \mathbf{8 \text{ components of 8 Gen1 Fermion Anti-Particles}} \end{aligned}$$

Decomposition to M4 x CP2 Kaluza-Klein
gives 2nd and 3rd generations of Fermions
and gives Higgs via Mayer-Trautman
 and **gives Standard Model SU(2)xU(1) via Batakis from CP2 = SU(3) / SU(2)xU(1)**

26D J(3,0) String Theory - Schwinger Sources

To understand **Schwinger Sources of E8 Physics start with 26D String Theory**: interpret **Strings as World-Lines** of Particles and **spin-2 String Theory things as carriers of Bohm Quantum Potential** (not gravitons).

Fock “Fundamental of Quantum Mechanics” (1931) showed that it requires Linear Operators “... represented by a definite integral [of a]... kernel ... function ...”.

Hua “Harmonic Analysis of Functions of Several Complex Variables in the Classical Domains” (1958) showed Kernel Functions for Complex Classical Domains.

Schwinger (1951 - see Schweber, PNAS 102, 7783-7788) “... introduced a description in terms of Green’s functions, what Feynman had called propagators ... The Green’s functions are vacuum expectation values of time-ordered Heisenberg operators, and the field theory can be defined non-perturbatively in terms of these functions ...[which]... gave deep structural insights into QFTs; in particular ... the structure of the Green’s functions when their variables are analytically continued to complex values ...”.

Wolf (J. Math. Mech 14 (1965) 1033-1047) showed that the Classical Domains (complete simply connected Riemannian symmetric spaces) representing 4-dim Spacetime with Quaternionic Structure are:

$S^1 \times S^1 \times S^1 \times S^1 = 4$ copies of $U(1)$

$S^2 \times S^2 = 2$ copies of $SU(2)$

$CP^2 = SU(3) / SU(2) \times U(1)$

$S^4 = Spin(5) / Spin(4) =$ Euclidean version of $Spin(2,3) / Spin(1,3)$

Armand Wyler (1971 - C. R. Acad. Sc. Paris, t. 271, 186-188) showed how to use Green’s Functions = Kernel Functions of Classical Domain structures characterizing Sources = Leptons, Quarks, and Gauge Bosons, to calculate Particle Masses and Force Strengths

(for results of E8 Physics Wyler-type calculations see Appendix of this paper)

Schwinger (1969 - physics/0610054) said: “... operator field theory ... replace[s] the particle[s] with ... small volumes of three-dimensional space ...

The properties of the particle ... remain the same ...

We introduce a quantitative description of the particle source in terms of a source function ... we do not have to claim that we can make the source arbitrarily small ...

The basic things are ... the source functions ...

describing the intermediate propagation of the particle ...”.

Schwinger Sources as described above are continuous manifold structures of Bounded Complex Domains and their Shilov Boundaries but

the E8 model at the Planck Scale has spacetime forming a Leech lattice underlying 26-dim String Theory of World-Lines

with $8 + 8 + 8 = 24$ -dim of fermion particles and antiparticles and of spacetime.

The automorphism group of a single 26-dim String Theory cell modulo the Leech lattice is the Monster Group of order about 8×10^{53} .

When a fermion particle/antiparticle appears in E8 spacetime it does not remain a single Planck-scale entity because Tachyons create a cloud of particles/antiparticles.

The cloud is one Planck-scale Fundamental Fermion Valence Particle plus an effectively neutral cloud of particle/antiparticle pairs forming a Kerr-Newman black hole.

That cloud constitutes the Schwinger Source.

Its structure comes from the 24-dim Leech lattice part of the Monster Group which is $2^{(1+24)}$ times the double cover of Co_1 , for a total order of about 10^{26} .

Since a Leech lattice is based on copies of an E8 lattice and since there are 7 distinct E8 integral domain lattices there are 7 (or 8 if you include a non-integral domain E8 lattice) distinct Leech lattices. The physical Leech lattice is a superposition of them, effectively adding a factor of 8 to the order of the Schwinger Source, so that the volume of the Kerr-Newman Cloud is on the order of 10^{27} x Planck scale. Therefore,

the Kerr-Newman Cloud should contain about 10^{27} particle/antiparticle pairs and its size should be about $10^{(27/3)} \times 1.6 \times 10^{(-33)}$ cm = roughly $10^{(-24)}$ cm.

Each of those particle-antiparticle pairs should see (with Bohm Potential) the rest of our Universe in the perspective of 8×10^{53} Monster Symmetry so

a single Schwinger Source acting as a Jewel of Indra's Net should see / reflect $10^{27} \times 8 \times 10^{53} = 8 \times 10^{80}$ Other Schwinger Source Jewels of Indra's Net which is consistent with the number of Schwinger Sources in our Universe.

Blockchain Structure of Bohm Quantum Potential

Andrew Gray in arXiv quant-ph/9712037 said:

“... probabilities are ... assigned to entire fine-grained histories ...
base[d] ... on the Feynman path integral formulation ...”

so in E8 Physics the Indra's Net of Schwinger Source Jewels

would not have Bohm Quantum Potential interactions between two Jewels,
rather the interactions would be between the two entire World-Line History Strings



(image adapted from <http://www.blockchaintechnologies.com/>)

According to <https://hbr.org/2017/01/the-truth-about-blockchain> “... **How Blockchain Works ...**

1. Distributed Database

Each party on a blockchain has access to the entire database and its complete history. No single party controls the data or the information. Every party can verify the records of its transaction partners directly, without an intermediary.

2. Peer-to-Peer Transmission

Communication occurs directly between peers instead of through a central node. Each node stores and forwards information to all other nodes.

3. Transparency with Pseudonymity

Every transaction and its associated value are visible to anyone with access to the system. Each node, or user, on a blockchain has a unique 30-plus-character alphanumeric address that identifies it. Users can choose to remain anonymous or provide proof of their identity to others. Transactions occur between blockchain addresses.

4. Irreversibility of Records

Once a transaction is entered in the database and the accounts are updated, the records cannot be altered, because they're linked to every transaction record that came before them (hence the term “chain”). Various computational algorithms and approaches are deployed to ensure that the recording on the database is permanent, chronologically ordered, and available to all others on the network.

5. Computational Logic

The digital nature of the ledger means that blockchain transactions can be tied to computational logic and in essence programmed. So users can set up algorithms and rules that automatically trigger transactions between nodes. ...”.

With respect to Bohm Quantum Potential of E8 Physics Schwinger Sources there is no Human directly controlling any Event / Interaction / Transaction, as they are all completely controlled by the Laws of Physics which define “algorithms and rules that automatically trigger transactions between nodes” .

Each Node is a Schwinger Source that is connected by Bohm Quantum Potential to all other Schwinger Source Nodes in our Universe and governed by the “algorithms and rules” of the E8 Physics Lagrangian and the Algebraic Quantum Field Theory arising from the completion of the union of all tensor products of copies of $Cl(16)$ each copy of $Cl(16)$ containing E8 and the E8 Lagrangian.

According to <http://www.blockchaintechnologies.com/> “... A blockchain is a type of distributed ledger, comprised of unchangable, digitally recorded data in packages called *blocks*. These digitally recorded "blocks" of data is stored in a linear *chain* ...



... A distributed ledger is a consensus of replicated, shared, and synchronized digital data geographically spread across multiple sites, countries, and/or institutions ...”

or, in the case of the E8 Physics Indra’s Net of Schwinger Source Jewels, spread across the entirety of our Universe.

The idea of Schwinger Sources as more than mere points is in David Finkelstein’s Space-Time Code 1968 in which David said “... “... What is too simple about general relativity is the space-time point ... each point of space-time is some kind of assembly of some kind of thing ... Each point, as Feynman once put it, has to remember with precision the values of indefinitely many fields describing many elementary particles; has to have data inputs and outputs connected to neighboring points; has to have a little arithmetic element to satisfy the field equations; and all in all might just as well be a complete computer ...” .

Schwinger Source Green's Function Geometry

The $Cl(1,25)$ E8 model Lagrangian over 4-dim Minkowski SpaceTime $M4$ is

$$\int_{4\text{-dim } M4} GG + SM + \text{Fermion Particle-AntiParticle} + \text{Higgs}$$

Consider the **Fermion Term**.

In the conventional picture, the spinor fermion term is of the form $m S S^*$ where m is the fermion mass and S and S^* represent the given fermion.

The Higgs coupling constants are, in the conventional picture, ad hoc parameters, so that effectively the mass term is, in the conventional picture, an ad hoc inclusion.

The $Cl(1,25)$ E8 model constructs the Lagrangian integral such that the mass m emerges as the integral over the Schwinger Source spacetime region of its Kerr-Newman cloud of virtual particle/antiparticle pairs plus the valence fermion so that the volume of the Schwinger Source fermion defines its mass, which, being dressed with the particle/antiparticle pair cloud, gives quark mass as constituent mass.

Fermion Schwinger Sources correspond to the Lie Sphere Symmetric space
 $Spin(10) / Spin(8) \times U(1)$

which has

local symmetry of the $Spin(8)$ gauge group from which the first generation spinor fermions are formed as **+half-spinor** and **-half-spinor** spaces

and

Bounded Complex Domain $D8$ of type $IV8$ and Shilov Boundary $Q8 = RP1 \times S7$

Consider the **GG + SM** term from Gauge Gravity and Standard Model Gauge Bosons. The process of breaking Octonionic 8-dim SpaceTime down to Quaternionic (4+4)-dim $M4 \times CP2$ Kaluza-Klein creates differences in the way gauge bosons "see" 4-dim Physical SpaceTime. There 4 equivalence classes of 4-dimensional Riemannian Symmetric Spaces with Quaternionic structure consistent with 4-dim Physical SpaceTime:

S4 = 4-sphere = $Spin(5) / Spin(4)$ where $Spin(5)$ = Schwinger-Euclidean version of the Anti-DeSitter subgroup of the Conformal Group that gives **MacDowell-Mansouri Gravity**

CP2 = complex projective 2-space = $SU(3) / U(2)$ with **the SU(3) of the Color Force**

S2 x S2 = $SU(2)/U(1) \times SU(2)/U(1)$ with two copies of **the SU(2) of the Weak Force**

S1 x S1 x S1 x S1 = $U(1) \times U(1) \times U(1) \times U(1)$ = 4 copies of **the U(1) of the EM Photon** (1 copy for each of the 4 covariant components of the Photon)

The Gravity Gauge Bosons (Schwinger-Euclidean versions) live in a Spin(5) subalgebra of the Spin(6) Conformal subalgebra of $D_4 = \text{Spin}(8)$. They "see" M4 Physical spacetime as the 4-sphere S^4 so that their part of the Physical Lagrangian is

\int Gravity Gauge Boson Term

S^4 .

an integral over SpaceTime S^4 .

The Schwinger Sources for GRb bosons are the Complex Bounded Domains and Shilov Boundaries for Spin(5) MacDowell-Mansouri Gravity bosons.

However, due to Stabilization of Condensate SpaceTime by virtual Planck Mass Gravitational Black Holes,

for Gravity, the effective force strength that we see in our experiments

is not just composed of the S^4 volume and the Spin(5) Schwinger Source volume, but is suppressed by the square of the Planck Mass.

The unsuppressed Gravity force strength is the Geometric Part of the force strength.

The Standard Model SU(3) Color Force bosons live in a SU(3) subalgebra of the SU(4) subalgebra of $D_4 = \text{Spin}(8)$.

They "see" M4 Physical spacetime as the complex projective plane CP^2 so that their part of the Physical Lagrangian is

\int SU(3) Color Force Gauge Boson Term

CP^2 .

an integral over SpaceTime CP^2 .

The Schwinger Sources for SU(3) bosons are the Complex Bounded Domains and Shilov Boundaries for SU(3) Color Force bosons.

The Color Force Strength is given by

the SpaceTime CP^2 volume and the SU(3) Schwinger Source volume.

Note that since the Schwinger Source volume is dressed with the particle/antiparticle pair cloud, the calculated force strength is

for the characteristic energy level of the Color Force (about 245 MeV).

The Standard Model SU(2) Weak Force bosons live in a SU(2) subalgebra of the U(2) local group of CP2 = SU(3) / U(2). They "see" M4 Physical spacetime as two 2-spheres S2 x S2 so that their part of the Physical Lagrangian is

$\int_{S^2 \times S^2}$ SU(2) Weak Force Gauge Boson Term

an integral over SpaceTime S2xS2.

The Schwinger Sources for SU(2) bosons are the Complex Bounded Domains and Shilov Boundaries for SU(2) Weak Force bosons.

However, due to the action of the Higgs mechanism, for the Weak Force, the effective force strength that we see in our experiments is not just composed of the S2xS2 volume and the SU(2) Schwinger Source volume, but is suppressed by the square of the Weak Boson masses.

The unsuppressed Weak Force strength is the Geometric Part of the force strength.

The Standard Model U(1) Electromagnetic Force bosons (photons) live in a U(1) subalgebra of the U(2) local group of CP2 = SU(3) / U(2). They "see" M4 Physical spacetime as four 1-sphere circles S1xS1xS1xS1 = T4 (T4 = 4-torus) so that their part of the Physical Lagrangian is

\int_{T^4} (U(1) Electromagnetism Gauge Boson Term

T4 .

an integral over SpaceTime T4.

The Schwinger Sources for U(1) photons

are the Complex Bounded Domains and Shilov Boundaries for U(1) photons.

The Electromagnetic Force Strength is given by the SpaceTime T4 volume and the U(1) Schwinger Source volume.

Schwinger Sources as described above are continuous manifold structures of Bounded Complex Domains and their Shilov Boundaries but

the E8 model at the Planck Scale has spacetime condensing out of Clifford structures forming a Leech lattice underlying 26-dim String Theory of World-Lines with $8 + 8 + 8 = 24$ -dim of fermion particles and antiparticles and of spacetime.

The automorphism group of a single 26-dim String Theory cell modulo the Leech lattice is the Monster Group of order about 8×10^{53} .

(see Appendix - Details of World-Line String Bohm Quantum Theory)

When a fermion particle/antiparticle appears in E8 spacetime it does not remain a single Planck-scale entity because Tachyons create a cloud of particles/antiparticles.

The cloud is one Planck-scale Fundamental Fermion Valence Particle plus an effectively neutral cloud of particle/antiparticle pairs forming a Kerr-Newman black hole. That cloud constitutes the Schwinger Source.

Its structure comes from the 24-dim Leech lattice part of the Monster Group which is $2^{(1+24)}$ times the double cover of Co_1 , for a total order of about 10^{26} .

(Since a Leech lattice is based on copies of an E8 lattice and since there are 7 distinct E8 integral domain lattices there are 7 (or 8 if you include a non-integral domain E8 lattice) distinct Leech lattices. The physical Leech lattice is a superposition of them, effectively adding a factor of 8 to the order.)

The volume of the Kerr-Newman Cloud is on the order of 10^{27} x Planck scale, so the Kerr-Newman Cloud should contain about 10^{27} particle/antiparticle pairs and its size should be about $10^{(27/3)} \times 1.6 \times 10^{(-33)}$ cm = roughly $10^{(-24)}$ cm.

Force Strength and Boson Mass Calculation

Cl(8) bivector Spin(8) is the D4 Lie algebra two copies of which are in the Cl(1,25) E8 model Lagrangian (as the D4xD4 subalgebra of the D8 subalgebra of E8)

$$\int_{4\text{-dim } M4} GG + SM + \text{Fermion Particle-AntiParticle} + \text{Higgs}$$

with the Higgs term coming from integrating over the CP2 Internal Symmetry Space of M4 x CP2 Kaluza-Klein by the Mayer-Trautman Mechanism

This shows that the Force Strength is made up of two parts:
 the relevant spacetime manifold of gauge group global action
 and
 the relevant symmetric space manifold of gauge group local action.

The 4-dim spacetime Lagrangian GG SM gauge boson term is:
 the integral over spacetime as seen by gauge boson acting globally
 of the gauge force term of the gauge boson acting locally
 for the gauge bosons of each of the four forces:

- U(1) for electromagnetism
- SU(2) for weak force
- SU(3) for color force

Spin(5) - compact version of antiDeSitter Spin(2,3) subgroup of Conformal Spin(2,4) for gravity by the MacDowell-Mansouri mechanism.

In the conventional picture,
 for each gauge force the gauge boson force term contains the force strength,
 which in Feynman's picture is the amplitude to emit a gauge boson,
 and can also be thought of as the probability = square of amplitude,
 in an explicit (like $g |F|^2$) or an implicit (incorporated into the $|F|^2$) form.
 Either way, the conventional picture is that the force strength g is an ad hoc inclusion.

The Cl(1,25) E8 model does not put in force strength g ad hoc,
 but constructs the integral such that
 the force strength emerges naturally from the geometry of each gauge force.

To do that, for each gauge force:

1 - make the spacetime over which the integral is taken be spacetime as it is seen by that gauge boson, that is, in terms of the symmetric space with global symmetry of the gauge boson:

the U(1) photon sees 4-dim spacetime as $T^4 = S^1 \times S^1 \times S^1 \times S^1$
the SU(2) weak boson sees 4-dim spacetime as $S^2 \times S^2$
the SU(3) weak boson sees 4-dim spacetime as CP^2
the Spin(5) of gravity sees 4-dim spacetime as S^4

2 - make the gauge boson force term have the volume of the Shilov boundary corresponding to the symmetric space with local symmetry of the gauge boson. The nontrivial Shilov boundaries are:

for SU(2) Shilov = $RP^1 \times S^2$
for SU(3) Shilov = S^5
for Spin(5) Shilov = $RP^1 \times S^4$

The result is (ignoring technicalities for exposition) the geometric factor for force strengths.

Each gauge group is the global symmetry of a symmetric space

S^1 for U(1)
 $S^2 = SU(2)/U(1) = Spin(3)/Spin(2)$ for SU(2)
 $CP^2 = SU(3)/SU(2) \times U(1)$ for SU(3)
 $S^4 = Spin(5)/Spin(4)$ for Spin(5)

Each gauge group is the local symmetry of a symmetric space

U(1) for itself
SU(2) for Spin(5) / $SU(2) \times U(1)$
SU(3) for SU(4) / $SU(3) \times U(1)$
Spin(5) for Spin(7) / $Spin(5) \times U(1)$

The nontrivial local symmetry symmetric spaces correspond to bounded complex domains

SU(2) for Spin(5) / $SU(2) \times U(1)$ corresponds to IV3
SU(3) for SU(4) / $SU(3) \times U(1)$ corresponds to B^6 (ball)
Spin(5) for Spin(7) / $Spin(5) \times U(1)$ corresponds to IV5

The nontrivial bounded complex domains have Shilov boundaries

SU(2) for Spin(5) / $SU(2) \times U(1)$ corresponds to IV3 Shilov = $RP^1 \times S^2$
SU(3) for SU(4) / $SU(3) \times U(1)$ corresponds to B^6 (ball) Shilov = S^5
Spin(5) for Spin(7) / $Spin(5) \times U(1)$ corresponds to IV5 Shilov = $RP^1 \times S^4$

Very roughly, think of the force strength as
integral over global symmetry space of physical (ie Shilov Boundary) volume =
= strength of the force.

That is:

the geometric strength of the force is given by the product of the volume of a 4-dim thing with global symmetry of the force and the volume of the Shilov Boundary for the local symmetry of the force.

When you calculate the product volumes (using some tricky normalization stuff), you see that roughly:

Volume product for gravity is the largest volume so since (as Feynman says) force strength = probability to emit a gauge boson means that the highest force strength or probability should be 1 the gravity Volume product is normalized to be 1, and so (approximately):

Volume product for gravity = 1

Volume product for color = 2/3

Volume product for weak = 1/4

Volume product for electromagnetism = 1/137

There are two further main components of a force strength:

1 - for massive gauge bosons, a suppression by a factor of $1 / M^2$

2 - renormalization running (important for color force)

Consider Massive Gauge Bosons:

Gravity as curvature deformation of SpaceTime, with SpaceTime as a condensate of Planck-Mass Black Holes, must be carried by virtual Planck-mass black holes, so that the geometric strength of gravity should be reduced by $1/M_p^2$

The weak force is carried by weak bosons,

so that the geometric strength of the weak force should be reduced by $1/M_W^2$

That gives the result (approximate):

gravity strength = G (Newton's G)

color strength = 2/3

weak strength = G_F (Fermi's weak force G)

electromagnetism = 1/137

Consider Renormalization Running for the Color Force:: That gives the result:

gravity strength = G (Newton's G)

color strength = 1/10 at weak boson mass scale

weak strength = G_F (Fermi's weak force G)

electromagnetism = 1/137

The use of compact volumes is itself a calculational device, because it would be more nearly correct, instead of the integral over the compact global symmetry space of the compact physical (ie Shilov Boundary) volume=strength of the force to use the integral over the hyperbolic spacetime global symmetry space of the noncompact invariant measure of the gauge force term.

However, since the strongest (gravitation) geometric force strength is to be normalized to 1, the only thing that matters is ratios, and the compact volumes (finite and easy to look up in the book by Hua) have the same ratios as the noncompact invariant measures.

In fact, I should go on to say that continuous spacetime and gauge force geometric objects are themselves also calculational devices, and that it would be even more nearly correct to do the calculations with respect to a discrete generalized hyperdiamond Feynman checkerboard.

Here are more details:

Here are more detailed force strength calculations:

The force strength of a given force is

$$\text{alphaforce} = (1 / \text{Mforce}^2) (\text{Vol}(\text{MISforce})) (\text{Vol}(\text{Qforce}) / \text{Vol}(\text{Dforce})^{(1 / \text{mforce})})$$

where:

alphaforce represents the force strength;

Mforce represents the effective mass;

MISforce represents the relevant part of the target Internal Symmetry Space;

Vol(MISforce) stands for volume of MISforce and is sometimes also denoted by Vol(M);

Qforce represents the link from the origin to the relevant target for the gauge boson;

Vol(Qforce) stands for volume of Qforce;

Dforce represents the complex bounded homogeneous domain of which Qforce is the Shilov boundary;

mforce is the dimensionality of Qforce, which is

- 4 for Gravity and the Color force,
- 2 for the Weak force (which therefore is considered to have two copies of QW for SpaceTime),
- 1 for Electromagnetism (which therefore is considered to have four copies of QE for SpaceTime)

Vol(Dforce)^(1 / mforce) stands for a dimensional normalization factor (to reconcile the dimensionality of the Internal Symmetry Space of the target vertex with the dimensionality of the link from the origin to the target vertex).

The Qforce, Hermitian symmetric space, and Dforce manifolds for the four forces are:

Spin(5)	Spin(7) / Spin(5)xU(1)	IV5	4	RP ¹ xS ⁴
SU(3)	SU(4) / SU(3)xU(1)	B ⁶ (ball)	4	S ⁵
SU(2)	Spin(5) / SU(2)xU(1)	IV3	2	RP ¹ xS ²
U(1)	-	-	1	-

The geometric volumes needed for the calculations are mostly taken from the book Harmonic Analysis of Functions of Several Complex Variables in the Classical Domains (AMS 1963, Moskva 1959, Science Press Peking 1958) by L. K. Hua [unit radius scale].

Force	M	Vol(M)
gravity	S^4	$8\pi^2/3$ - S^4 is 4-dimensional
color	CP^2	$8\pi^2/3$ - CP^2 is 4-dimensional
weak	$S^2 \times S^2$	$2 \times 4\pi$ - S^2 is a 2-dim boundary of 3-dim ball 4-dim $S^2 \times S^2$ = topological boundary of 6-dim 2-polyball Shilov Boundary of 6-dim 2-polyball = $S^2 + S^2$ = = 2-dim surface frame of 4-dim $S^2 \times S^2$
e-mag	T^4	$4 \times 2\pi$ - S^1 is 1-dim boundary of 2-dim disk 4-dim $T^4 = S^1 \times S^1 \times S^1 \times S^1$ = topological boundary of 8-dim 4-polydisk Shilov Boundary of 8-dim 4-polydisk = $S^1 + S^1 + S^1 + S^1$ = = 1-dim wire frame of 4-dim T^4

Note (thanks to Carlos Castro for noticing this) also that the volume listed for CP^2 is unconventional, but physically justified by noting that S^4 and CP^2 can be seen as having the same physical volume, with the only difference being structure at infinity.

Note that for U(1) electromagnetism, whose photon carries no charge, the factors Vol(Q) and Vol(D) do not apply and are set equal to 1, and from another point of view, the link manifold to the target vertex is trivial for the abelian neutral U(1) photons of Electromagnetism, so we take QE and DE to be equal to unity.

Force	M	Vol(M)	Q	Vol(Q)	D	Vol(D)
gravity	S^4	$8\pi^2/3$	$RP^1 \times S^4$	$8\pi^3/3$	IV_5	$\pi^5/2^4 5!$
color	CP^2	$8\pi^2/3$	S^5	$4\pi^3$	$B^6(\text{ball})$	$\pi^3/6$
Weak	$S^2 \times S^2$	$2 \times 4\pi$	$RP^1 \times S^2$	$4\pi^2$	IV_3	$\pi^3/24$
e-mag	T^4	$4 \times 2\pi$	-	-	-	-

Note (thanks to Carlos Castro for noticing this) that the volume listed for S^5 is for a squashed S^5 , a Shilov boundary of the complex domain corresponding to the symmetric space $SU(4) / SU(3) \times U(1)$.

Using the above numbers, the results of the calculations are the relative force strengths at the characteristic energy level of the generalized Bohr radius of each force:

Spin(5)	gravity	approx 10^{19} GeV	1	$G G m_{\text{proton}}^2$	approx 5×10^{-39}
SU(3)	color	approx 245 MeV	0.6286		0.6286
SU(2)	weak	approx 100 GeV	0.2535	$G W m_{\text{proton}}^2$	approx 1.05×10^{-5}
U(1)	e-mag	approx 4 KeV	1/137.03608		1/137.03608

The force strengths are given at the characteristic energy levels of their forces, because the force strengths run with changing energy levels.

The effect is particularly pronounced with the color force.

The color force strength was calculated using a simple perturbative QCD renormalization group equation at various energies, with the following results:

Energy Level	Color Force Strength
245 MeV	0.6286
5.3 GeV	0.166
34 GeV	0.121
91 GeV	0.106

Taking other effects, such as Nonperturbative QCD, into account, should give a Color Force Strength of about 0.125 at about 91 GeV

Higgs, W+, W-, Z0:

As with forces strengths, the calculations produce ratios of masses, so that only one mass need be chosen to set the mass scale.

In the Cl(1,25) E8 model, the value of the fundamental mass scale vacuum expectation value $v = \langle \text{PHI} \rangle$ of the Higgs scalar field is set to be the sum of the physical masses of the weak bosons, W+, W-, and Z0, whose tree-level masses will then be shown by ratio calculations to be 80.326 GeV, 80.326 GeV, and 91.862 GeV, respectively, and therefore the electron mass will be 0.5110 MeV.

The relationship between the Higgs mass and v is given by the Ginzburg-Landau term from the Mayer Mechanism as

$$(1/4) \text{Tr} ([\text{PHI} , \text{PHI}] - \text{PHI})^2$$

or, i

n the notation of quant-ph/9806009 by Guang-jiong Ni

$$(1/4!) \lambda \text{PHI}^4 - (1/2) \sigma \text{PHI}^2$$

where the Higgs mass $M_H = \sqrt{2 \sigma}$

Ni says:

"... the invariant meaning of the constant λ in the Lagrangian is not the coupling constant, the latter will change after quantization ... The invariant meaning of λ is nothing but the ratio of two mass scales:

$$\lambda = 3 (M_H / \text{PHI})^2$$

which remains unchanged irrespective of the order ...".

Since $\langle \text{PHI} \rangle^2 = v^2$, and assuming that $\lambda = (\cos(\pi / 6))^2 = 0.866^2$ (a value consistent with the Higgs-Tquark condensate model of Michio Hashimoto, Masaharu Tanabashi, and Koichi Yamawaki in their paper at hep-ph/0311165) we have

$$M_H^2 / v^2 = (\cos(\pi / 6))^2 / 3$$

In the Cl(1,25) E8 model, the fundamental mass scale vacuum expectation value v of the Higgs scalar field is the fundamental mass parameter that is to be set to define all other masses by the mass ratio formulas of the model and v is set to be 252.514 GeV so that

$$M_H = v \cos(\pi / 6) / \sqrt{1 / 3} = 126.257 \text{ GeV}$$

This is the value of the Low Mass State of the Higgs observed by the LHC. Middle and High Mass States come from a Higgs-Tquark Condensate System. The Middle and High Mass States may have been observed by the LHC at 20% of the Low Mass State cross section, and that may be confirmed by the LHC 2015-1016 run.

A Non-Condensate Higgs is represented by a Higgs at a point in M4 that is connected to a Higgs representation in CP2 ISS by a line whose length represents the Higgs mass

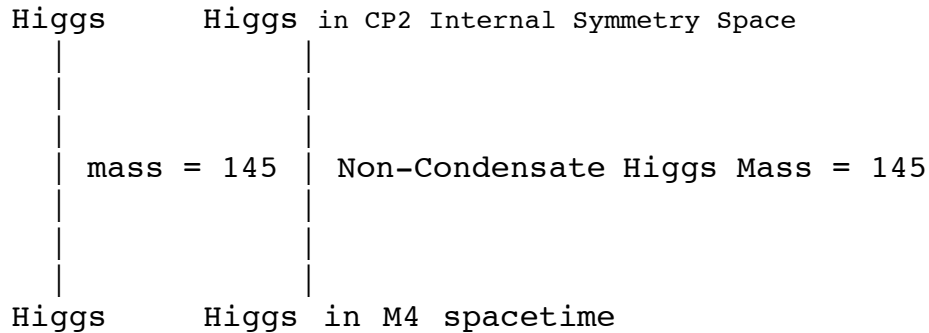

and the value of lambda is $1 = 1^2$
 so that the Higgs mass would be $M_H = v / \sqrt{3} = 145.789 \text{ GeV}$

However, in the $Cl(1,25) E8$ model, the Higgs has structure of a Tquark condensate

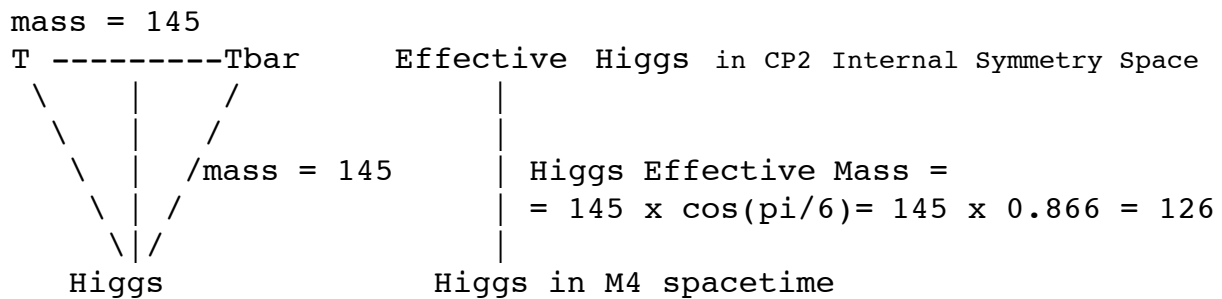

in which the Higgs at a point in M4 is connected to a T and Tbar in CP2 ISS so that the vertices of the Higgs-T-Tbar system are connected by lines forming an equilateral triangle composed of 2 right triangles (one from the CP2 origin to the T and to the M4 Higgs and another from the CP2 origin to the Tbar and to the M4 Higgs).

In the T-quark condensate picture
 $\lambda = 1^2 = \lambda(T) + \lambda(H) = (\sin(\pi/6))^2 + (\cos(\pi/6))^2$
 and
 $\lambda(H) = (\cos(\pi/6))^2$

Therefore the Effective Higgs mass observed by LHC is:

$$\text{Higgs Mass} = 145.789 \times \cos(\pi/6) = 126.257 \text{ GeV.}$$

To get W-boson masses,
denote the 3 SU(2) high-energy weak bosons
(massless at energies higher than the electroweak unification)
by W_+ , W_- , and W_0 ,
corresponding to the massive physical weak bosons W_+ , W_- , and Z_0 .

The triplet $\{ W_+, W_-, W_0 \}$ couples directly with the T - Tbar quark-antiquark pair,
so that the total mass of the triplet $\{ W_+, W_-, W_0 \}$ at the electroweak unification
is equal to the total mass of a T - Tbar pair, 259.031 GeV.

The triplet $\{ W_+, W_-, Z_0 \}$ couples directly with the Higgs scalar,
which carries the Higgs mechanism by which the W_0 becomes the physical Z_0 ,
so that the total mass of the triplet $\{ W_+, W_-, Z_0 \}$
is equal to the vacuum expectation value v of the Higgs scalar field, $v = 252.514$ GeV.

What are individual masses of members of the triplet $\{ W_+, W_-, Z_0 \}$?

First, look at the triplet $\{ W_+, W_-, W_0 \}$ which can be represented by the 3-sphere S^3 .
The Hopf fibration of S^3 as

$$S^1 \rightarrow S^3 \rightarrow S^2$$

gives a decomposition of the W bosons into the neutral W_0 corresponding to S^1
and the charged pair W_+ and W_- corresponding to S^2 .

The mass ratio of the sum of the masses of W_+ and W_- to the mass of W_0
should be the volume ratio of the S^2 in S^3 to the S^1 in S^3 .

The unit sphere S^3 in R^4 is normalized by $1/2$.

The unit sphere S^2 in R^3 is normalized by $1/\sqrt{3}$.

The unit sphere S^1 in R^2 is normalized by $1/\sqrt{2}$.

The ratio of the sum of the W_+ and W_- masses to the W_0 mass should then be
 $(2/\sqrt{3}) V(S^2) / (2/\sqrt{2}) V(S^1) = 1.632993$

Since the total mass of the triplet $\{ W_+, W_-, W_0 \}$ is 259.031 GeV,
the total mass of a T - Tbar pair, and the charged weak bosons have equal mass,
we have

$$M_{W_+} = M_{W_-} = 80.326 \text{ GeV and } M_{W_0} = 98.379 \text{ GeV.}$$

The charged W_{\pm} neutrino-electron interchange must be symmetric
with the electron-neutrino interchange, so that the tree-level absence
of right-handed neutrino particles requires that

the charged W_{\pm} SU(2) weak bosons act only on left-handed electrons.

Each gauge boson must act consistently on the entire Dirac fermion particle sector,
so that the
charged W_{\pm} SU(2) weak bosons act only on left-handed fermion particles of all types.

The neutral W_0 weak boson does not interchange Weyl neutrinos with Dirac fermions, and so is not restricted to left-handed fermions, but also has a component that acts on both types of fermions, both left-handed and right-handed, conserving parity.

However, the neutral W_0 weak bosons are related to the charged $W_{+/-}$ weak bosons by custodial $SU(2)$ symmetry, so that the left-handed component of the neutral W_0 must be equal to the left-handed (entire) component of the charged $W_{+/-}$.

Since the mass of the W_0 is greater than the mass of the $W_{+/-}$, there remains for the W_0 a component acting on both types of fermions.

Therefore the full W_0 neutral weak boson interaction is proportional to $(M_{W_{+/-}}^2 / M_{W_0}^2)$ acting on left-handed fermions and $(1 - (M_{W_{+/-}}^2 / M_{W_0}^2))$ acting on both types of fermions.

If $(1 - (M_{W_{+/-}}^2 / M_{W_0}^2))$ is defined to be $\sin(\theta_w)^2$ and denoted by K , and if the strength of the $W_{+/-}$ charged weak force (and of the custodial $SU(2)$ symmetry) is denoted by T , then the W_0 neutral weak interaction can be written as $W_0L = T + K$ and $W_0LR = K$.

Since the W_0 acts as W_0L with respect to the parity violating $SU(2)$ weak force and as W_0LR with respect to the parity conserving $U(1)$ electromagnetic force, the W_0 mass m_{W_0} has two components: the parity violating $SU(2)$ part m_{W_0L} that is equal to $M_{W_{+/-}}$ and the parity conserving part M_{W_0LR} that acts like a heavy photon.

As $M_{W_0} = 98.379 \text{ GeV} = M_{W_0L} + M_{W_0LR}$, and as $M_{W_0L} = M_{W_{+/-}} = 80.326 \text{ GeV}$, we have $M_{W_0LR} = 18.053 \text{ GeV}$.

Denote by $\alpha_E = e^2$ the force strength of the weak parity conserving $U(1)$ electromagnetic type force that acts through the $U(1)$ subgroup of $SU(2)$.

The electromagnetic force strength $\alpha_E = e^2 = 1 / 137.03608$ was calculated above using the volume $V(S^1)$ of an S^1 in R^2 , normalized by $1 / \sqrt{2}$.

The α_E force is part of the $SU(2)$ weak force whose strength $\alpha_W = w^2$ was calculated above using the volume $V(S^2)$ of an $S^2 \subset R^3$, normalized by $1 / \sqrt{3}$.

Also, the electromagnetic force strength $\alpha_E = e^2$ was calculated above using a 4-dimensional spacetime with global structure of the 4-torus T^4 made up of four S^1 1-spheres, while the $SU(2)$ weak force strength $\alpha_W = w^2$ was calculated above using two 2-spheres $S^2 \times S^2$, each of which contains one 1-sphere of the α_E force.

Therefore

$$\begin{aligned} *alphaE &= alphaE (\sqrt{ 2 } / \sqrt{ 3 })(2 / 4) = alphaE / \sqrt{ 6 } , \\ *e &= e / (4th \text{ root of } 6) = e / 1.565 , \end{aligned}$$

and

the mass mW0LR must be reduced to an effective value

$$M_W0LReff = M_W0LR / 1.565 = 18.053/1.565 = 11.536 \text{ GeV}$$

for the *alphaE force to act like an electromagnetic force in the E8 model:

$$*e M_W0LR = e (1/1.565) M_W0LR = e M_Z0,$$

where the physical effective neutral weak boson is denoted by Z0.

Therefore, the correct Cl(1,25) E8 model values for weak boson masses and the Weinberg angle theta_w are:

$$M_W+ = M_W- = 80.326 \text{ GeV};$$

$$M_Z0 = 80.326 + 11.536 = 91.862 \text{ GeV};$$

$$\text{Sin}(\text{theta}_w)^2 = 1 - (M_W+/- / M_Z0)^2 = 1 - (6452.2663 / 8438.6270) = 0.235.$$

Radiative corrections are not taken into account here, and may change these tree- level values somewhat.

Fermion Mass Calculations

In the $Cl(1,25)$ E8 model, the first generation spinor fermions are seen as +half-spinor and -half-spinor spaces of $Cl(1,7) = Cl(8)$. Due to Triality, $Spin(8)$ can act on those 8-dimensional half-spinor spaces similarly to the way it acts on 8-dimensional vector spacetime.

Take the the spinor fermion volume to be the Shilov boundary corresponding to the same symmetric space on which $Spin(8)$ acts as a local gauge group that is used to construct 8-dimensional vector spacetime:

the symmetric space $Spin(10) / Spin(8) \times U(1)$
corresponding to a bounded domain of type IV8
whose Shilov boundary is $RP^1 \times S^7$

Since all first generation fermions see the spacetime over which the integral is taken in the same way (unlike what happens for the force strength calculation), the only geometric volume factor relevant for calculating first generation fermion mass ratios is in the spinor fermion volume term.

$Cl(1,25)$ E8 model fermions correspond to Schwinger Source Kerr-Newman Black Holes,
so the quark mass in the $Cl(1,25)$ E8 model is a constituent mass.

Fermion masses are calculated as a product of four factors:

$$V(Q\text{fermion}) \times N(\text{Graviton}) \times N(\text{octonion}) \times \text{Sym}$$

$V(Q\text{fermion})$ is the volume of the part of the half-spinor fermion particle manifold $S^7 \times RP^1$ related to the fermion particle by photon, weak boson, or gluon interactions.

$N(\text{Graviton})$ is the number of types of $Spin(0,5)$ graviton related to the fermion. The 10 gravitons correspond to the 10 infinitesimal generators of $Spin(0,5) = Sp(2)$. 2 of them are in the Cartan subalgebra. 6 of them carry color charge, and therefore correspond to quarks. The remaining 2 carry no color charge, but may carry electric charge and so may be considered as corresponding to electrons. One graviton takes the electron into itself, and the other can only take the first generation electron into the massless electron neutrino. Therefore only one graviton should correspond to the mass of the first-generation electron.

The graviton number ratio of the down quark to the first-generation electron is therefore $6/1 = 6$.

$N(\text{octonion})$ is an octonion number factor relating up-type quark masses to down-type quark masses in each generation.

Sym is an internal symmetry factor, relating 2nd and 3rd generation massive

leptons to first generation fermions. It is not used in first-generation calculations.

The first generation down quark constituent mass : electron mass ratio is:

The electron, E, can only be taken into the tree-level-massless neutrino, 1, by photon, weak boson, and gluon interactions.

The electron and neutrino, or their antiparticles, cannot be combined to produce any of the massive up or down quarks.

The neutrino, being massless at tree level, does not add anything to the mass formula for the electron.

Since the electron cannot be related to any other massive Dirac fermion, its volume $V(Q_{\text{electron}})$ is taken to be 1.

Next consider a red down quark i.

By gluon interactions, i can be taken into j and k, the blue and green down quarks.

By also using weak boson interactions,

it can also be taken into I, J, and K, the red, blue, and green up quarks.

Given the up and down quarks, pions can be formed from quark-antiquark pairs, and the pions can decay to produce electrons and neutrinos.

Therefore the red down quark (similarly, any down quark)

is related to all parts of $S^7 \times RP^1$,

the compact manifold corresponding to $\{ 1, i, j, k, E, I, J, K \}$

and therefore a down quark should have

a spinor manifold volume factor $V(Q_{\text{down quark}})$ of the volume of $S^7 \times RP^1$.

The ratio of the down quark spinor manifold volume factor

to the electron spinor manifold volume factor is

$$V(Q_{\text{down quark}}) / V(Q_{\text{electron}}) = V(S^7 \times RP^1) / 1 = \pi^5 / 3.$$

Since the first generation graviton factor is 6,

$$m_d / m_e = 6 V(S^7 \times RP^1) = 2 \pi^5 = 612.03937$$

As the up quarks correspond to I, J, and K, which are the octonion transforms under E of i, j, and k of the down quarks, the up quarks and down quarks have the same constituent mass

$$m_u = m_d.$$

Antiparticles have the same mass as the corresponding particles.

Since the model only gives ratios of masses,

the mass scale is fixed so that the electron mass $m_e = 0.5110 \text{ MeV}$.

Then, the constituent mass of the down quark is $m_d = 312.75 \text{ MeV}$,

and the constituent mass for the up quark is $m_u = 312.75 \text{ MeV}$.

These results when added up give a total mass of first generation fermion particles:

$$\Sigma_{\text{maf1}} = 1.877 \text{ GeV}$$

As the proton mass is taken to be the sum of the constituent masses of its constituent quarks

$$m_{\text{proton}} = m_u + m_u + m_d = 938.25 \text{ MeV}$$

which is close to the experimental value of 938.27 MeV.

The third generation fermion particles correspond to triples of octonions.

There are $8^3 = 512$ such triples.

The triple $\{1, 1, 1\}$ corresponds to the tau-neutrino.

The other 7 triples involving only 1 and E correspond to the tauon:

$\{E, E, E\}$

$\{E, E, 1\}$

$\{E, 1, E\}$

$\{1, E, E\}$

$\{1, 1, E\}$

$\{1, E, 1\}$

$\{E, 1, 1\}$

The symmetry of the 7 tauon triples is the same as the symmetry of the first generation tree-level-massive fermions, 3 down, quarks, the 3 up quarks, and the electron,

so by the Sym factor the tauon mass should be the same as the sum of the masses of the first generation massive fermion particles.

Therefore the tauon mass is calculated at tree level as 1.877 GeV.

The calculated tauon mass of 1.88 GeV is a sum of first generation fermion masses, all of which are valid at the energy level of about 1 GeV.

However, as the tauon mass is about 2 GeV, the effective tauon mass should be renormalized from the energy level of 1 GeV at which the mass is 1.88 GeV to the energy level of 2 GeV.

Such a renormalization should reduce the mass.

If the renormalization reduction were about 5 percent, the effective tauon mass at 2 GeV would be about 1.78 GeV.

The 1996 Particle Data Group Review of Particle Physics gives a tauon mass of 1.777 GeV.

All triples corresponding to the tau and the tau-neutrino are colorless.

The beauty quark corresponds to 21 triples.
 They are triples of the same form as the 7 tauon triples involving 1 and E,
 but for 1 and I, 1 and J, and 1 and K,
 which correspond to the red, green, and blue beauty quarks, respectively.
 The seven red beauty quark triples correspond to the seven tauon triples,
 except that the beauty quark interacts with 6 Spin(0,5) gravitons
 while the tauon interacts with only two.

The red beauty quark constituent mass should be the tauon mass times
 the third generation graviton factor $6/2 = 3$,
 so the red beauty quark mass is $m_b = 5.63111 \text{ GeV}$.

The blue and green beauty quarks are similarly determined to also be 5.63111 GeV .

The theoretical model calculated Beauty Quark mass of 5.63 GeV
 corresponds to a pole mass of 5.32 GeV ,
 which is somewhat higher than the conventional value of 5.0 GeV .
 However, the theoretical model calculated value
 of the color force strength constant α_s at about 5 GeV is about 0.166 ,
 while the conventional value
 of the color force strength constant α_s at about 5 GeV is about 0.216 ,
 and the theoretical model calculated value
 of the color force strength constant α_s at about 90 GeV is about 0.106 ,
 while the conventional value
 of the color force strength constant α_s at about 90 GeV is about 0.118 .

Triples of the type $\{ 1, I, J \}$, $\{ I, J, K \}$, etc.,
 do not correspond to the beauty quark, but to the truth quark.
 The truth quark corresponds to those $512 - 1 - 7 - 21 = 483$ triples,
 so the constituent mass of the red truth quark
 is $161 / 7 = 23$ times the red beauty quark mass,
 and the red T-quark mass is
 $m_t = 129.5155 \text{ GeV}$

The blue and green truth quarks are similarly determined to also be 129.5155 GeV .
 This is the value of the Low Mass State of the Truth calculated in the CI(1,25) E8 model.
 The Middle Mass State of the Truth Quark has been observed by Fermilab since 1994.
 The Low and High Mass States of the Truth Quark have, in my opinion, also been
 observed by Fermilab but the Fermilab and CERN establishments disagree.

These results when added up give a total mass of third generation fermion
 particles:

$$\Sigma m_f = 1,629 \text{ GeV}$$

Here are more details:

Here are more detailed Fermion Mass Calculations

In the $Cl(1,25)$ E8 model, the first generation spinor fermions are seen as +half-spinor and -half-spinor spaces of $Cl(1,7) = Cl(8)$.

Due to Triality,

$Spin(8)$ can act on those 8-dimensional half-spinor spaces similarly to the way it acts on 8-dimensional vector spacetime.

Take the the spinor fermion volume to be the Shilov boundary corresponding to the same symmetric space on which $Spin(8)$ acts as a local gauge group that is used to construct 8-dimensional vector spacetime:

the symmetric space $Spin(10) / Spin(8) \times U(1)$

corresponding to a bounded domain of type IV8

whose Shilov boundary is $RP^1 \times S^7$

Since all first generation fermions see the spacetime over which the integral is taken in the same way (unlike what happens for the force strength calculation), the only geometric volume factor relevant for calculating first generation fermion mass ratios is in the spinor fermion volume term.

$Cl(1,25)$ E8 model fermions correspond to Schwinger Source Kerr-Newman Black Holes,

so the quark mass in the $Cl(1,25)$ E8 model is a constituent mass.

Fermion masses are calculated as a product of four factors:

$$V(Q\text{fermion}) \times N(\text{Graviton}) \times N(\text{octonion}) \times \text{Sym}$$

$V(Q\text{fermion})$ is the volume of the part of the half-spinor fermion particle manifold $S^7 \times RP^1$ related to the fermion particle by photon, weak boson, or gluon interactions.

$N(\text{Graviton})$ is the number of types of $Spin(0,5)$ graviton related to the fermion.

The 10 gravitons correspond to the 10 infinitesimal generators of $Spin(0,5) = Sp(2)$. 2 of them are in the Cartan subalgebra.

6 of them carry color charge, and therefore correspond to quarks.

The remaining 2 carry no color charge, but may carry electric charge and so may be considered as corresponding to electrons.

One graviton takes the electron into itself, and the other can only take the first-generation electron into the massless electron neutrino. Therefore only one graviton should correspond to the mass of the first-generation electron. The graviton number ratio of the down quark to the first-generation electron is therefore $6/1 = 6$.

$N(\text{octonion})$ is an octonion number factor relating up-type quark masses to down-type quark masses in each generation.

Sym is an internal symmetry factor, relating 2nd and 3rd generation massive leptons to first generation fermions. It is not used in first-generation calculations.

3 Generation Fermion Combinatorics

First Generation (8)

(geometric representation of Octonions is from arXiv 1010.2979)

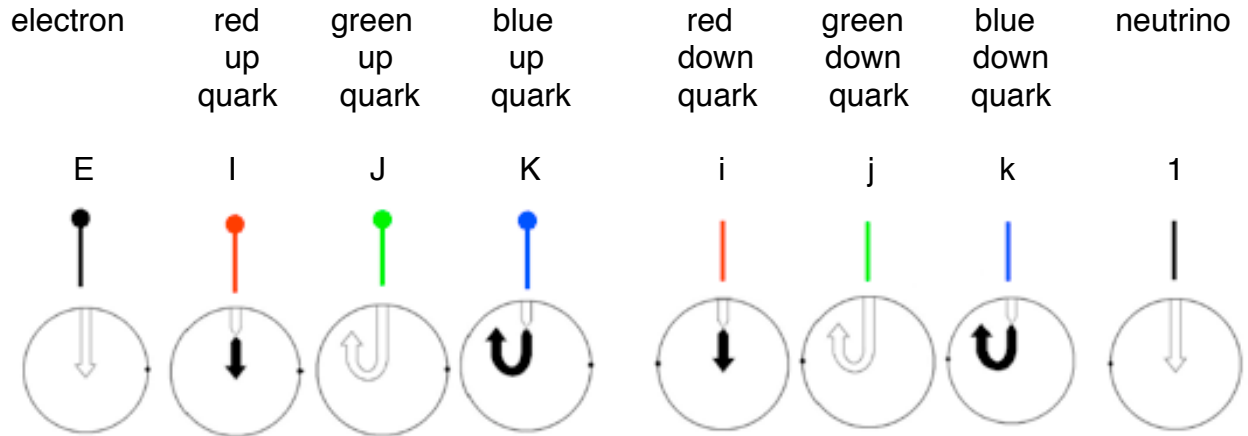

Second Generation (64)

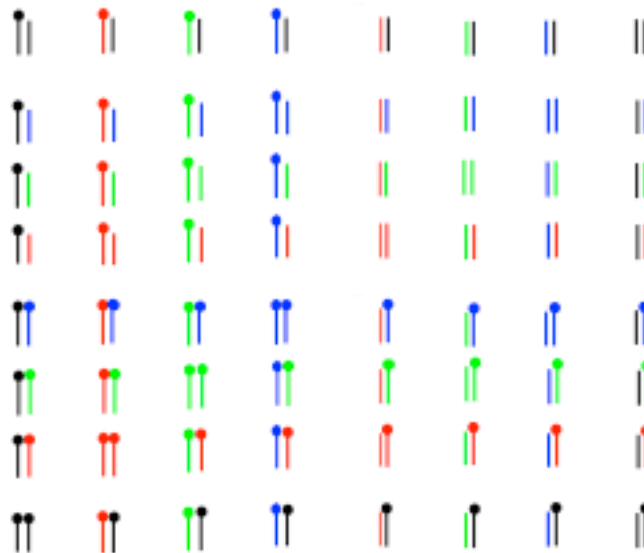

Mu Neutrino (1)

Rule: a Pair belongs to the Mu Neutrino if:
 All elements are Colorless (black)
 and all elements are Associative

(that is, is 1 which is the only Colorless Associative element) .

Muon (3)

Rule: a Pair belongs to the Muon if:
All elements are Colorless (black)
and at least one element is NonAssociative
(that is, is E which is the only Colorless NonAssociative element).

Blue Strange Quark (3)

Rule: a Pair belongs to the Blue Strange Quark if:
There is at least one Blue element and the other element is Blue or Colorless (black)
and all elements are Associative (that is, is either 1 or i or j or k).

Blue Charm Quark (17)

Rules: a Pair belongs to the Blue Charm Quark if:
1 - There is at least one Blue element and the other element is Blue or Colorless (black)
and at least one element is NonAssociative (that is, is either E or I or J or K)
2 - There is one Red element and one Green element (Red x Green = Blue).

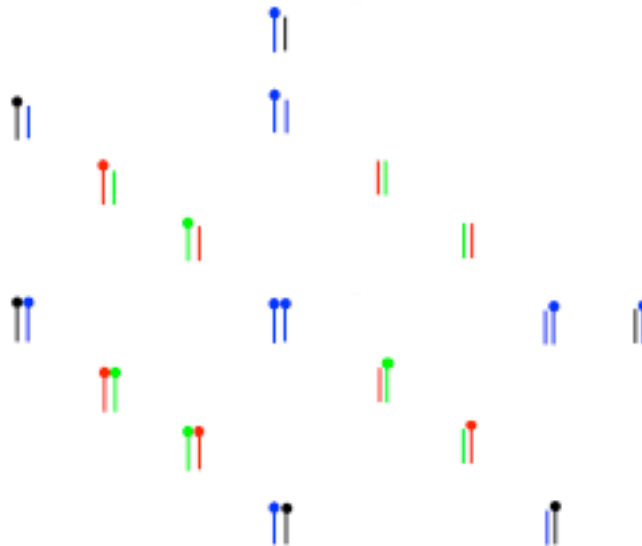

(Red and Green Strange and Charm Quarks follow similar rules)

Third Generation (512)

	<table border="1"> <tr><td>Te</td><td>Te</td><td>Te</td><td>Te</td><td>ue</td><td>ue</td><td>ue</td><td>ue</td></tr> <tr><td>Te</td><td>Te</td><td>Te</td><td>Te</td><td>ue</td><td>ue</td><td>ue</td><td>ue</td></tr> <tr><td>Te</td><td>Te</td><td>Te</td><td>Te</td><td>ue</td><td>ue</td><td>ue</td><td>ue</td></tr> <tr><td>Te</td><td>Te</td><td>Te</td><td>Te</td><td>ue</td><td>ue</td><td>ue</td><td>ue</td></tr> <tr><td>Te</td><td>Te</td><td>Te</td><td>Te</td><td>ue</td><td>ue</td><td>ue</td><td>ue</td></tr> <tr><td>Te</td><td>Te</td><td>Te</td><td>Te</td><td>ue</td><td>ue</td><td>ue</td><td>ue</td></tr> <tr><td>Te</td><td>Te</td><td>Te</td><td>Te</td><td>ue</td><td>ue</td><td>ue</td><td>ue</td></tr> <tr><td>Te</td><td>Te</td><td>Te</td><td>Te</td><td>ue</td><td>ue</td><td>ue</td><td>ue</td></tr> </table>	Te	Te	Te	Te	ue	ue	ue	ue	Te	Te	Te	Te	ue	ue	ue	ue	Te	Te	Te	Te	ue	ue	ue	ue	Te	Te	Te	Te	ue	ue	ue	ue	Te	Te	Te	Te	ue	ue	ue	ue	Te	Te	Te	Te	ue	ue	ue	ue	Te	Te	Te	Te	ue	ue	ue	ue	Te	Te	Te	Te	ue	ue	ue	ue																																																																																																																																	
Te	Te	Te	Te	ue	ue	ue	ue																																																																																																																																																																																											
Te	Te	Te	Te	ue	ue	ue	ue																																																																																																																																																																																											
Te	Te	Te	Te	ue	ue	ue	ue																																																																																																																																																																																											
Te	Te	Te	Te	ue	ue	ue	ue																																																																																																																																																																																											
Te	Te	Te	Te	ue	ue	ue	ue																																																																																																																																																																																											
Te	Te	Te	Te	ue	ue	ue	ue																																																																																																																																																																																											
Te	Te	Te	Te	ue	ue	ue	ue																																																																																																																																																																																											
Te	Te	Te	Te	ue	ue	ue	ue																																																																																																																																																																																											
<table border="1"> <tr><td>Te</td><td>Te</td><td>Te</td><td>Te</td><td>ue</td><td>ue</td><td>ue</td><td>ue</td></tr> <tr><td>Te</td><td>Te</td><td>Te</td><td>Te</td><td>ue</td><td>ue</td><td>ue</td><td>ue</td></tr> <tr><td>Te</td><td>Te</td><td>Te</td><td>Te</td><td>ue</td><td>ue</td><td>ue</td><td>ue</td></tr> <tr><td>Te</td><td>Te</td><td>Te</td><td>Te</td><td>ue</td><td>ue</td><td>ue</td><td>ue</td></tr> <tr><td>Te</td><td>Te</td><td>Te</td><td>Te</td><td>ue</td><td>ue</td><td>ue</td><td>ue</td></tr> <tr><td>Te</td><td>Te</td><td>Te</td><td>Te</td><td>ue</td><td>ue</td><td>ue</td><td>ue</td></tr> <tr><td>Te</td><td>Te</td><td>Te</td><td>Te</td><td>ue</td><td>ue</td><td>ue</td><td>ue</td></tr> <tr><td>Te</td><td>Te</td><td>Te</td><td>Te</td><td>ue</td><td>ue</td><td>ue</td><td>ue</td></tr> </table>	Te	Te	Te	Te	ue	ue	ue	ue	Te	Te	Te	Te	ue	ue	ue	ue	Te	Te	Te	Te	ue	ue	ue	ue	Te	Te	Te	Te	ue	ue	ue	ue	Te	Te	Te	Te	ue	ue	ue	ue	Te	Te	Te	Te	ue	ue	ue	ue	Te	Te	Te	Te	ue	ue	ue	ue	Te	Te	Te	Te	ue	ue	ue	ue	<table border="1"> <tr><td>Te</td><td>Te</td><td>Te</td><td>Te</td><td>ue</td><td>ue</td><td>ue</td><td>ue</td></tr> <tr><td>Te</td><td>Te</td><td>Te</td><td>Te</td><td>ue</td><td>ue</td><td>ue</td><td>ue</td></tr> <tr><td>Te</td><td>Te</td><td>Te</td><td>Te</td><td>ue</td><td>ue</td><td>ue</td><td>ue</td></tr> <tr><td>Te</td><td>Te</td><td>Te</td><td>Te</td><td>ue</td><td>ue</td><td>ue</td><td>ue</td></tr> <tr><td>Te</td><td>Te</td><td>Te</td><td>Te</td><td>ue</td><td>ue</td><td>ue</td><td>ue</td></tr> <tr><td>Te</td><td>Te</td><td>Te</td><td>Te</td><td>ue</td><td>ue</td><td>ue</td><td>ue</td></tr> <tr><td>Te</td><td>Te</td><td>Te</td><td>Te</td><td>ue</td><td>ue</td><td>ue</td><td>ue</td></tr> <tr><td>Te</td><td>Te</td><td>Te</td><td>Te</td><td>ue</td><td>ue</td><td>ue</td><td>ue</td></tr> </table>	Te	Te	Te	Te	ue	ue	ue	ue	Te	Te	Te	Te	ue	ue	ue	ue	Te	Te	Te	Te	ue	ue	ue	ue	Te	Te	Te	Te	ue	ue	ue	ue	Te	Te	Te	Te	ue	ue	ue	ue	Te	Te	Te	Te	ue	ue	ue	ue	Te	Te	Te	Te	ue	ue	ue	ue	Te	Te	Te	Te	ue	ue	ue	ue	<table border="1"> <tr><td>Te</td><td>Te</td><td>Te</td><td>Te</td><td>ue</td><td>ue</td><td>ue</td><td>ue</td></tr> <tr><td>Te</td><td>Te</td><td>Te</td><td>Te</td><td>ue</td><td>ue</td><td>ue</td><td>ue</td></tr> <tr><td>Te</td><td>Te</td><td>Te</td><td>Te</td><td>ue</td><td>ue</td><td>ue</td><td>ue</td></tr> <tr><td>Te</td><td>Te</td><td>Te</td><td>Te</td><td>ue</td><td>ue</td><td>ue</td><td>ue</td></tr> <tr><td>Te</td><td>Te</td><td>Te</td><td>Te</td><td>ue</td><td>ue</td><td>ue</td><td>ue</td></tr> <tr><td>Te</td><td>Te</td><td>Te</td><td>Te</td><td>ue</td><td>ue</td><td>ue</td><td>ue</td></tr> <tr><td>Te</td><td>Te</td><td>Te</td><td>Te</td><td>ue</td><td>ue</td><td>ue</td><td>ue</td></tr> <tr><td>Te</td><td>Te</td><td>Te</td><td>Te</td><td>ue</td><td>ue</td><td>ue</td><td>ue</td></tr> </table>	Te	Te	Te	Te	ue	ue	ue	ue	Te	Te	Te	Te	ue	ue	ue	ue	Te	Te	Te	Te	ue	ue	ue	ue	Te	Te	Te	Te	ue	ue	ue	ue	Te	Te	Te	Te	ue	ue	ue	ue	Te	Te	Te	Te	ue	ue	ue	ue	Te	Te	Te	Te	ue	ue	ue	ue	Te	Te	Te	Te	ue	ue	ue	ue
Te	Te	Te	Te	ue	ue	ue	ue																																																																																																																																																																																											
Te	Te	Te	Te	ue	ue	ue	ue																																																																																																																																																																																											
Te	Te	Te	Te	ue	ue	ue	ue																																																																																																																																																																																											
Te	Te	Te	Te	ue	ue	ue	ue																																																																																																																																																																																											
Te	Te	Te	Te	ue	ue	ue	ue																																																																																																																																																																																											
Te	Te	Te	Te	ue	ue	ue	ue																																																																																																																																																																																											
Te	Te	Te	Te	ue	ue	ue	ue																																																																																																																																																																																											
Te	Te	Te	Te	ue	ue	ue	ue																																																																																																																																																																																											
Te	Te	Te	Te	ue	ue	ue	ue																																																																																																																																																																																											
Te	Te	Te	Te	ue	ue	ue	ue																																																																																																																																																																																											
Te	Te	Te	Te	ue	ue	ue	ue																																																																																																																																																																																											
Te	Te	Te	Te	ue	ue	ue	ue																																																																																																																																																																																											
Te	Te	Te	Te	ue	ue	ue	ue																																																																																																																																																																																											
Te	Te	Te	Te	ue	ue	ue	ue																																																																																																																																																																																											
Te	Te	Te	Te	ue	ue	ue	ue																																																																																																																																																																																											
Te	Te	Te	Te	ue	ue	ue	ue																																																																																																																																																																																											
Te	Te	Te	Te	ue	ue	ue	ue																																																																																																																																																																																											
Te	Te	Te	Te	ue	ue	ue	ue																																																																																																																																																																																											
Te	Te	Te	Te	ue	ue	ue	ue																																																																																																																																																																																											
Te	Te	Te	Te	ue	ue	ue	ue																																																																																																																																																																																											
Te	Te	Te	Te	ue	ue	ue	ue																																																																																																																																																																																											
Te	Te	Te	Te	ue	ue	ue	ue																																																																																																																																																																																											
Te	Te	Te	Te	ue	ue	ue	ue																																																																																																																																																																																											
Te	Te	Te	Te	ue	ue	ue	ue																																																																																																																																																																																											
<table border="1"> <tr><td>Te</td><td>Te</td><td>Te</td><td>Te</td><td>ue</td><td>ue</td><td>ue</td><td>ue</td></tr> <tr><td>Te</td><td>Te</td><td>Te</td><td>Te</td><td>ue</td><td>ue</td><td>ue</td><td>ue</td></tr> <tr><td>Te</td><td>Te</td><td>Te</td><td>Te</td><td>ue</td><td>ue</td><td>ue</td><td>ue</td></tr> <tr><td>Te</td><td>Te</td><td>Te</td><td>Te</td><td>ue</td><td>ue</td><td>ue</td><td>ue</td></tr> <tr><td>Te</td><td>Te</td><td>Te</td><td>Te</td><td>ue</td><td>ue</td><td>ue</td><td>ue</td></tr> <tr><td>Te</td><td>Te</td><td>Te</td><td>Te</td><td>ue</td><td>ue</td><td>ue</td><td>ue</td></tr> <tr><td>Te</td><td>Te</td><td>Te</td><td>Te</td><td>ue</td><td>ue</td><td>ue</td><td>ue</td></tr> <tr><td>Te</td><td>Te</td><td>Te</td><td>Te</td><td>ue</td><td>ue</td><td>ue</td><td>ue</td></tr> </table>	Te	Te	Te	Te	ue	ue	ue	ue	Te	Te	Te	Te	ue	ue	ue	ue	Te	Te	Te	Te	ue	ue	ue	ue	Te	Te	Te	Te	ue	ue	ue	ue	Te	Te	Te	Te	ue	ue	ue	ue	Te	Te	Te	Te	ue	ue	ue	ue	Te	Te	Te	Te	ue	ue	ue	ue	Te	Te	Te	Te	ue	ue	ue	ue	<table border="1"> <tr><td>Te</td><td>Te</td><td>Te</td><td>Te</td><td>ue</td><td>ue</td><td>ue</td><td>ue</td></tr> <tr><td>Te</td><td>Te</td><td>Te</td><td>Te</td><td>ue</td><td>ue</td><td>ue</td><td>ue</td></tr> <tr><td>Te</td><td>Te</td><td>Te</td><td>Te</td><td>ue</td><td>ue</td><td>ue</td><td>ue</td></tr> <tr><td>Te</td><td>Te</td><td>Te</td><td>Te</td><td>ue</td><td>ue</td><td>ue</td><td>ue</td></tr> <tr><td>Te</td><td>Te</td><td>Te</td><td>Te</td><td>ue</td><td>ue</td><td>ue</td><td>ue</td></tr> <tr><td>Te</td><td>Te</td><td>Te</td><td>Te</td><td>ue</td><td>ue</td><td>ue</td><td>ue</td></tr> <tr><td>Te</td><td>Te</td><td>Te</td><td>Te</td><td>ue</td><td>ue</td><td>ue</td><td>ue</td></tr> <tr><td>Te</td><td>Te</td><td>Te</td><td>Te</td><td>ue</td><td>ue</td><td>ue</td><td>ue</td></tr> </table>	Te	Te	Te	Te	ue	ue	ue	ue	Te	Te	Te	Te	ue	ue	ue	ue	Te	Te	Te	Te	ue	ue	ue	ue	Te	Te	Te	Te	ue	ue	ue	ue	Te	Te	Te	Te	ue	ue	ue	ue	Te	Te	Te	Te	ue	ue	ue	ue	Te	Te	Te	Te	ue	ue	ue	ue	Te	Te	Te	Te	ue	ue	ue	ue	<table border="1"> <tr><td>Te</td><td>Te</td><td>Te</td><td>Te</td><td>ue</td><td>ue</td><td>ue</td><td>ue</td></tr> <tr><td>Te</td><td>Te</td><td>Te</td><td>Te</td><td>ue</td><td>ue</td><td>ue</td><td>ue</td></tr> <tr><td>Te</td><td>Te</td><td>Te</td><td>Te</td><td>ue</td><td>ue</td><td>ue</td><td>ue</td></tr> <tr><td>Te</td><td>Te</td><td>Te</td><td>Te</td><td>ue</td><td>ue</td><td>ue</td><td>ue</td></tr> <tr><td>Te</td><td>Te</td><td>Te</td><td>Te</td><td>ue</td><td>ue</td><td>ue</td><td>ue</td></tr> <tr><td>Te</td><td>Te</td><td>Te</td><td>Te</td><td>ue</td><td>ue</td><td>ue</td><td>ue</td></tr> <tr><td>Te</td><td>Te</td><td>Te</td><td>Te</td><td>ue</td><td>ue</td><td>ue</td><td>ue</td></tr> <tr><td>Te</td><td>Te</td><td>Te</td><td>Te</td><td>ue</td><td>ue</td><td>ue</td><td>ue</td></tr> </table>	Te	Te	Te	Te	ue	ue	ue	ue	Te	Te	Te	Te	ue	ue	ue	ue	Te	Te	Te	Te	ue	ue	ue	ue	Te	Te	Te	Te	ue	ue	ue	ue	Te	Te	Te	Te	ue	ue	ue	ue	Te	Te	Te	Te	ue	ue	ue	ue	Te	Te	Te	Te	ue	ue	ue	ue	Te	Te	Te	Te	ue	ue	ue	ue
Te	Te	Te	Te	ue	ue	ue	ue																																																																																																																																																																																											
Te	Te	Te	Te	ue	ue	ue	ue																																																																																																																																																																																											
Te	Te	Te	Te	ue	ue	ue	ue																																																																																																																																																																																											
Te	Te	Te	Te	ue	ue	ue	ue																																																																																																																																																																																											
Te	Te	Te	Te	ue	ue	ue	ue																																																																																																																																																																																											
Te	Te	Te	Te	ue	ue	ue	ue																																																																																																																																																																																											
Te	Te	Te	Te	ue	ue	ue	ue																																																																																																																																																																																											
Te	Te	Te	Te	ue	ue	ue	ue																																																																																																																																																																																											
Te	Te	Te	Te	ue	ue	ue	ue																																																																																																																																																																																											
Te	Te	Te	Te	ue	ue	ue	ue																																																																																																																																																																																											
Te	Te	Te	Te	ue	ue	ue	ue																																																																																																																																																																																											
Te	Te	Te	Te	ue	ue	ue	ue																																																																																																																																																																																											
Te	Te	Te	Te	ue	ue	ue	ue																																																																																																																																																																																											
Te	Te	Te	Te	ue	ue	ue	ue																																																																																																																																																																																											
Te	Te	Te	Te	ue	ue	ue	ue																																																																																																																																																																																											
Te	Te	Te	Te	ue	ue	ue	ue																																																																																																																																																																																											
Te	Te	Te	Te	ue	ue	ue	ue																																																																																																																																																																																											
Te	Te	Te	Te	ue	ue	ue	ue																																																																																																																																																																																											
Te	Te	Te	Te	ue	ue	ue	ue																																																																																																																																																																																											
Te	Te	Te	Te	ue	ue	ue	ue																																																																																																																																																																																											
Te	Te	Te	Te	ue	ue	ue	ue																																																																																																																																																																																											
Te	Te	Te	Te	ue	ue	ue	ue																																																																																																																																																																																											
Te	Te	Te	Te	ue	ue	ue	ue																																																																																																																																																																																											
Te	Te	Te	Te	ue	ue	ue	ue																																																																																																																																																																																											
	<table border="1"> <tr><td>Te</td><td>Te</td><td>Te</td><td>Te</td><td>ue</td><td>ue</td><td>ue</td><td>ue</td></tr> <tr><td>Te</td><td>Te</td><td>Te</td><td>Te</td><td>ue</td><td>ue</td><td>ue</td><td>ue</td></tr> <tr><td>Te</td><td>Te</td><td>Te</td><td>Te</td><td>ue</td><td>ue</td><td>ue</td><td>ue</td></tr> <tr><td>Te</td><td>Te</td><td>Te</td><td>Te</td><td>ue</td><td>ue</td><td>ue</td><td>ue</td></tr> <tr><td>Te</td><td>Te</td><td>Te</td><td>Te</td><td>ue</td><td>ue</td><td>ue</td><td>ue</td></tr> <tr><td>Te</td><td>Te</td><td>Te</td><td>Te</td><td>ue</td><td>ue</td><td>ue</td><td>ue</td></tr> <tr><td>Te</td><td>Te</td><td>Te</td><td>Te</td><td>ue</td><td>ue</td><td>ue</td><td>ue</td></tr> <tr><td>Te</td><td>Te</td><td>Te</td><td>Te</td><td>ue</td><td>ue</td><td>ue</td><td>ue</td></tr> </table>	Te	Te	Te	Te	ue	ue	ue	ue	Te	Te	Te	Te	ue	ue	ue	ue	Te	Te	Te	Te	ue	ue	ue	ue	Te	Te	Te	Te	ue	ue	ue	ue	Te	Te	Te	Te	ue	ue	ue	ue	Te	Te	Te	Te	ue	ue	ue	ue	Te	Te	Te	Te	ue	ue	ue	ue	Te	Te	Te	Te	ue	ue	ue	ue																																																																																																																																	
Te	Te	Te	Te	ue	ue	ue	ue																																																																																																																																																																																											
Te	Te	Te	Te	ue	ue	ue	ue																																																																																																																																																																																											
Te	Te	Te	Te	ue	ue	ue	ue																																																																																																																																																																																											
Te	Te	Te	Te	ue	ue	ue	ue																																																																																																																																																																																											
Te	Te	Te	Te	ue	ue	ue	ue																																																																																																																																																																																											
Te	Te	Te	Te	ue	ue	ue	ue																																																																																																																																																																																											
Te	Te	Te	Te	ue	ue	ue	ue																																																																																																																																																																																											
Te	Te	Te	Te	ue	ue	ue	ue																																																																																																																																																																																											

Tau Neutrino (1)

Rule: a Triple belongs to the Tau Neutrino if:
 All elements are Colorless (black)
 and all elements are Associative
 (that is, is 1 which is the only Colorless Associative element)

Tauon (7)

Rule: a Triple belongs to the Tauon if:
 All elements are Colorless (black)
 and at least one element is NonAssociative (that is, is E which is the only Colorless NonAssociative element)

Blue Beauty Quark (7)

Rule: a Triple belongs to the Blue Beauty Quark if:
 There is at least one Blue element and all other elements are Blue or Colorless (black)
 and all elements are Associative (that is, is either 1 or i or j or k).

Blue Truth Quark (161)

- Rules: a Triple belongs to the Blue Truth Quark if:
- 1 - There is at least one Blue element and all other elements are Blue or Colorless (black)
 and at least one element is NonAssociative (that is, is either E or I or J or K)
 - 2 - There is one Red element and one Green element and the other element is Colorless (Red x Green = Blue)
 - 3 - The Triple has one element each that is Red, Green, or Blue, in which case the color of the Third element (for Third Generation) is determinative and must be Blue.

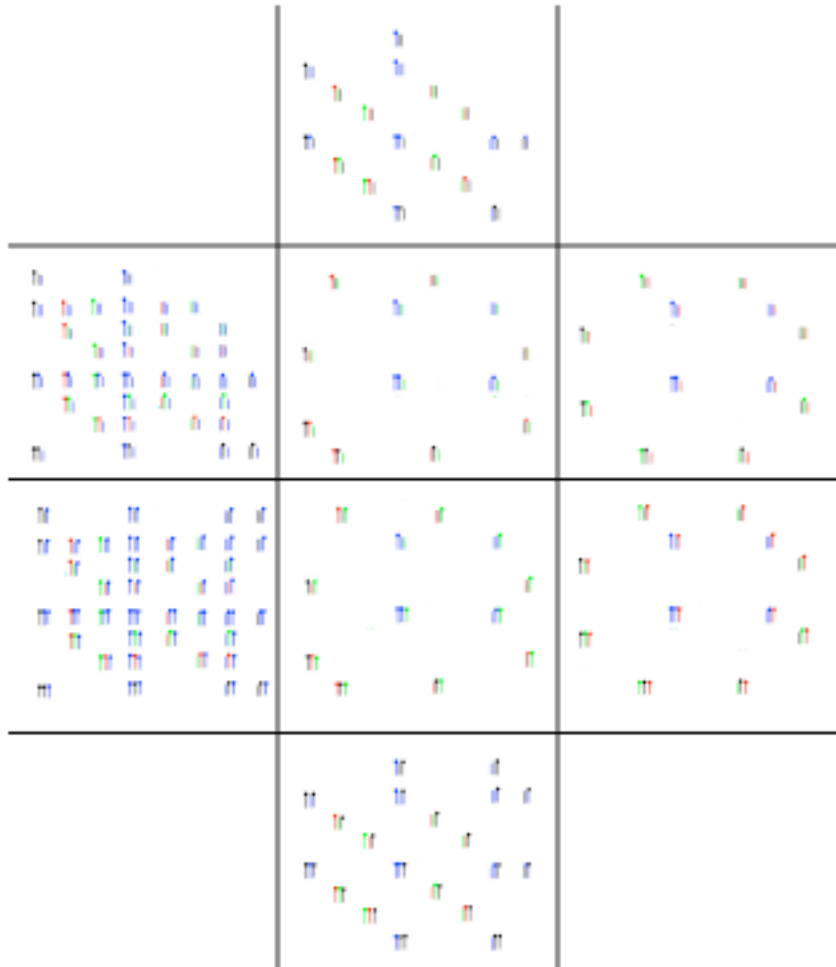

(Red and Green Beauty and Truth Quarks follow similar rules)

The first generation down quark constituent mass : electron mass ratio is:

The electron, E, can only be taken into the tree-level-massless neutrino, 1, by photon, weak boson, and gluon interactions.

The electron and neutrino, or their antiparticles, cannot be combined to produce any of the massive up or down quarks.

The neutrino, being massless at tree level, does not add anything to the mass formula for the electron.

Since the electron cannot be related to any other massive Dirac fermion, its volume $V(Q_{\text{electron}})$ is taken to be 1.

Next consider a red down quark i.

By gluon interactions, i can be taken into j and k, the blue and green down quarks.

By also using weak boson interactions,

it can also be taken into I, J, and K, the red, blue, and green up quarks.

Given the up and down quarks, pions can be formed from quark-antiquark pairs, and the pions can decay to produce electrons and neutrinos.

Therefore the red down quark (similarly, any down quark)

is related to all parts of $S^7 \times RP^1$,

the compact manifold corresponding to $\{ 1, i, j, k, E, I, J, K \}$

and therefore

a down quark should have

a spinor manifold volume factor $V(Q_{\text{down quark}})$ of the volume of $S^7 \times RP^1$.

The ratio of the down quark spinor manifold volume factor

to the electron spinor manifold volume factor is

$$V(Q_{\text{down quark}}) / V(Q_{\text{electron}}) = V(S^7 \times RP^1) / 1 = \pi^5 / 3.$$

Since the first generation graviton factor is 6,

$$m_d / m_e = 6 V(S^7 \times RP^1) = 2 \pi^5 = 612.03937$$

As the up quarks correspond to I, J, and K, which are the octonion transforms under E of i, j, and k of the down quarks, the up quarks and down quarks have the same constituent mass

$$m_u = m_d.$$

Antiparticles have the same mass as the corresponding particles.

Since the model only gives ratios of masses,

the mass scale is fixed so that the electron mass $m_e = 0.5110 \text{ MeV}$.

Then, the constituent mass of the down quark is $m_d = 312.75 \text{ MeV}$,

and the constituent mass for the up quark is $m_u = 312.75 \text{ MeV}$.

These results when added up give a total mass of first generation fermion particles:

$$\Sigma_{\text{maf1}} = 1.877 \text{ GeV}$$

As the proton mass is taken to be the sum of the constituent masses of its constituent quarks

$$m_{\text{proton}} = m_u + m_u + m_d = 938.25 \text{ MeV}$$

which is close to the experimental value of 938.27 MeV.

The third generation fermion particles correspond to triples of octonions. There are $8^3 = 512$ such triples.

The triple $\{ 1, 1, 1 \}$ corresponds to the tau-neutrino.

The other 7 triples involving only 1 and E correspond to the tauon:

$\{ E, E, E \}$
 $\{ E, E, 1 \}$
 $\{ E, 1, E \}$
 $\{ 1, E, E \}$
 $\{ 1, 1, E \}$
 $\{ 1, E, 1 \}$
 $\{ E, 1, 1 \}$

The symmetry of the 7 tauon triples is the same as the symmetry of the first generation tree-level-massive fermions, 3 down, quarks, the 3 up quarks, and the electron, so by the Sym factor the tauon mass should be the same as the sum of the masses of the first generation massive fermion particles.

Therefore the tauon mass is calculated at tree level as 1.877 GeV.

The calculated tauon mass of 1.88 GeV is a sum of first generation fermion masses, all of which are valid at the energy level of about 1 GeV.

However, as the tauon mass is about 2 GeV, the effective tauon mass should be renormalized from the energy level of 1 GeV at which the mass is 1.88 GeV to the energy level of 2 GeV. Such a renormalization should reduce the mass.

If the renormalization reduction were about 5 percent, the effective tauon mass at 2 GeV would be about 1.78 GeV. The 1996 Particle Data Group Review of Particle Physics gives a tauon mass of 1.777 GeV.

All triples corresponding to the tau and the tau-neutrino are colorless.

The beauty quark corresponds to 21 triples.
They are triples of the same form as the 7 tauon triples involving 1 and E,
but for 1 and I, 1 and J, and 1 and K,
which correspond to the red, green, and blue beauty quarks,
respectively.

The seven red beauty quark triples correspond to the seven tauon triples,
except that
the beauty quark interacts with 6 Spin(0,5) gravitons
while the tauon interacts with only two.

The red beauty quark constituent mass should be the tauon mass times
the third generation graviton factor $6/2 = 3$,
so the red beauty quark mass is $m_b = 5.63111$ GeV.

The blue and green beauty quarks are similarly determined to also be 5.63111 GeV.

The calculated beauty quark mass of 5.63 GeV is a constituent mass,
that is, it corresponds to the conventional pole mass plus 312.8 MeV.
Therefore, the calculated beauty quark mass of 5.63 GeV
corresponds to a conventional pole mass of 5.32 GeV.

The 1996 Particle Data Group Review of Particle Physics gives
a lattice gauge theory beauty quark pole mass as 5.0 GeV.

The pole mass can be converted to an MSbar mass
if the color force strength constant α_s is known.
The conventional value of α_s at about 5 GeV is about 0.22.

Using $\alpha_s(5 \text{ GeV}) = 0.22$, a pole mass of 5.0 GeV
gives an MSbar 1-loop beauty quark mass of 4.6 GeV,
and
an MSbar 1,2-loop beauty quark mass of 4.3, evaluated at about 5 GeV.

If the MSbar mass is run from 5 GeV up to 90 GeV,
the MSbar mass decreases by about 1.3 GeV,
giving an expected MSbar mass of about 3.0 GeV at 90 GeV.

DELPHI at LEP has observed the Beauty Quark
and found a 90 GeV MSbar beauty quark mass of about 2.67 GeV,
with error bars ± 0.25 (stat) ± 0.34 (frag) ± 0.27 (theo).

The theoretical model calculated Beauty Quark mass of 5.63 GeV corresponds to a pole mass of 5.32 GeV, which is somewhat higher than the conventional value of 5.0 GeV.

However, the theoretical model calculated value of the color force strength constant α_s at about 5 GeV is about 0.166, while the conventional value of the color force strength constant α_s at about 5 GeV is about 0.216, and the theoretical model calculated value of the color force strength constant α_s at about 90 GeV is about 0.106, while the conventional value of the color force strength constant α_s at about 90 GeV is about 0.118.

The theoretical model calculations gives a Beauty Quark pole mass (5.3 GeV) that is about 6 percent higher than the conventional Beauty Quark pole mass (5.0 GeV), and a color force strength α_s at 5 GeV (0.166) such that $1 + \alpha_s = 1.166$ is about 4 percent lower than the conventional value of $1 + \alpha_s = 1.216$ at 5 GeV.

Triples of the type $\{ 1, I, J \}$, $\{ I, J, K \}$, etc., do not correspond to the beauty quark, but to the truth quark. The truth quark corresponds to those $512 - 1 - 7 - 21 = 483$ triples, so the constituent mass of the red truth quark is $161 / 7 = 23$ times the red beauty quark mass, and the red T-quark mass is $m_t = 129.5155$ GeV

The blue and green truth quarks are similarly determined to also be 129.5155 GeV.

This is the value of the Low Mass State of the Truth calculated in the Cl(1,25) E8 model. The Middle Mass State of the Truth Quark has been observed by Fermilab since 1994. The Low and High Mass States of the Truth Quark have, in my opinion, also been observed by Fermilab (see Chapter 17 of this paper) but the Fermilab and CERN establishments disagree.

All other masses than the electron mass (which is the basis of the assumption of the value of the Higgs scalar field vacuum expectation value $v = 252.514$ GeV), including the Higgs scalar mass and Truth quark mass, are calculated (not assumed) masses in the Cl(1,25) E8 model. These results when added up give a total mass of third generation fermion particles:

$$\mathbf{\Sigma_{maf3} = 1,629 \text{ GeV}}$$

The second generation fermion particles correspond to pairs of octonions. There are $8^2 = 64$ such pairs.

The pair $\{ 1, 1 \}$ corresponds to the mu-neutrino.

The pairs $\{ 1, E \}$, $\{ E, 1 \}$, and $\{ E, E \}$ correspond to the muon.

For the Sym factor, compare the symmetries of the muon pairs to the symmetries of the first generation fermion particles: The pair $\{ E, E \}$ should correspond to the E electron. The other two muon pairs have a symmetry group S_2 , which is $1/3$ the size of the color symmetry group S_3 which gives the up and down quarks their mass of 312.75 MeV.

Therefore the mass of the muon should be the sum of the $\{ E, E \}$ electron mass and the $\{ 1, E \}$, $\{ E, 1 \}$ symmetry mass, which is $1/3$ of the up or down quark mass. Therefore, $m_{\mu} = 104.76$ MeV .

According to the 1998 Review of Particle Physics of the Particle Data Group, the experimental muon mass is about 105.66 MeV which may be consistent with radiative corrections for the calculated tree-level $m_{\mu} = 104.76$ MeV as Bailin and Love, in "Introduction to Gauge Field Theory", IOP (rev ed 1993), say: "... considering the order alpha radiative corrections to muon decay ... Numerical details are contained in Sirlin ... 1980 Phys. Rev. D 22 971 ... who concludes that the order alpha corrections have the effect of increasing the decay rate about 7% compared with the tree graph prediction ...". Since the decay rate is proportional to m_{μ}^5 the corresponding effective increase in muon mass would be about 1.36%, which would bring 104.8 MeV up to about 106.2 MeV.

All pairs corresponding to the muon and the mu-neutrino are colorless.

The red, blue and green strange quark each corresponds to the 3 pairs involving 1 and i, j, or k.

The red strange quark is defined as the three pairs $\{ 1, i \}$, $\{ i, 1 \}$, $\{ i, i \}$ because i is the red down quark.

Its mass should be the sum of two parts:

the $\{ i, i \}$ red down quark mass, 312.75 MeV, and

the product of the symmetry part of the muon mass, 104.25 MeV, times the graviton factor.

Unlike the first generation situation, massive second and third generation leptons can be taken, by both of the colorless gravitons that may carry electric charge, into massive particles.

Therefore the graviton factor for the second and third generations is $6/2 = 3$.

So the symmetry part of the muon mass times the graviton factor 3 is 312.75 MeV, and the red strange quark constituent mass is $m_s = 312.75 \text{ MeV} + 312.75 \text{ MeV} = 625.5 \text{ MeV}$

The blue strange quarks correspond to the three pairs involving j, the green strange quarks correspond to the three pairs involving k, and their masses are similarly determined to also be 625.5 MeV.

The charm quark corresponds to the remaining $64 - 1 - 3 - 9 = 51$ pairs.

Therefore, the mass of the red charm quark should be the sum of two parts:

the $\{ i, i \}$, red up quark mass, 312.75 MeV;

and

the product of the symmetry part of the strange quark mass, 312.75 MeV, and the charm to strange octonion number factor $51 / 9$, which product is 1,772.25 MeV.

Therefore the red charm quark constituent mass is

$$m_c = 312.75 \text{ MeV} + 1,772.25 \text{ MeV} = 2.085 \text{ GeV}$$

The blue and green charm quarks are similarly determined to also be 2.085 GeV.

The calculated Charm Quark mass of 2.09 GeV is a constituent mass, that is, it corresponds to the conventional pole mass plus 312.8 MeV.

Therefore, the calculated Charm Quark mass of 2.09 GeV corresponds to a conventional pole mass of 1.78 GeV.

The 1996 Particle Data Group Review of Particle Physics gives a range for the Charm Quark pole mass from 1.2 to 1.9 GeV.

The pole mass can be converted to an MSbar mass if the color force strength constant α_s is known.

The conventional value of α_s at about 2 GeV is about 0.39, which is somewhat lower than the theoretical model value.

Using $\alpha_s(2 \text{ GeV}) = 0.39$, a pole mass of 1.9 GeV gives an MSbar 1-loop mass of 1.6 GeV, evaluated at about 2 GeV.

These results when added up give a total mass of second generation fermion particles:

$$\mathbf{\Sigma_{f2} = 32.9 \text{ GeV}}$$

Kobayashi-Maskawa Parameters

In E8 Physics the KM Unitarity Triangle angles can be seen on the Stella Octangula

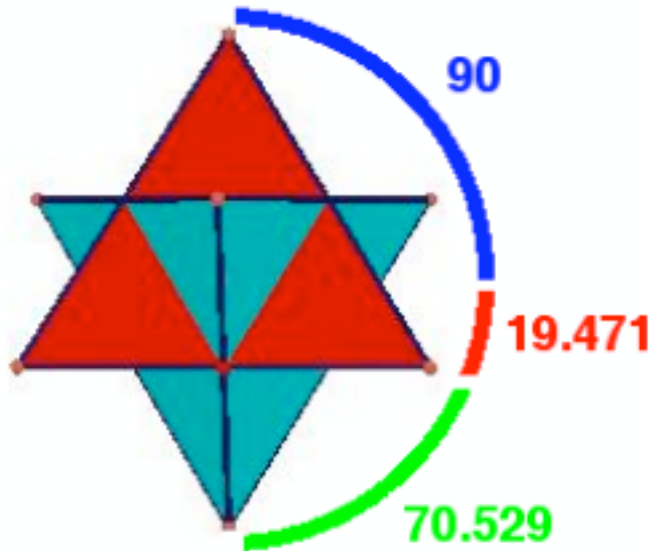

The Kobayashi-Maskawa parameters are determined in terms of the sum of the masses of the 30 first-generation fermion particles and antiparticles, denoted by

$$S_{mf1} = 7.508 \text{ GeV},$$

and the similar sums for second-generation and third-generation fermions, denoted by

$$S_{mf2} = 32.94504 \text{ GeV} \text{ and } S_{mf3} = 1,629.2675 \text{ GeV}.$$

The resulting KM matrix is:

d		s	b
u	0.975	0.222 0.00249	-0.00388i
c	-0.222 -0.000161i	0.974 -0.0000365i	0.0423
t	0.00698 -0.00378i	-0.0418 -0.00086i	0.999

**Below the energy level of ElectroWeak Symmetry Breaking
the Higgs mechanism gives mass to particles.**

According to a Review on the Kobayashi-Maskawa mixing matrix by Ceccucci, Ligeti, and Sakai in the 2010 Review of Particle Physics (note that I have changed their terminology of CKM matrix to the KM terminology that I prefer because I feel that it was Kobayashi and Maskawa, not Cabibbo, who saw that 3x3 was the proper matrix structure): "... the charged-current W_{\pm} interactions couple to the ... quarks with couplings given by ...

$$\begin{matrix} V_{ud} & V_{us} & V_{ub} \\ V_{cd} & V_{cs} & V_{cb} \\ V_{td} & V_{ts} & V_{tb} \end{matrix}$$

This Kobayashi-Maskawa (KM) matrix is a 3x3 unitary matrix. It can be parameterized by three mixing angles and the CP-violating KM phase ... The most commonly used unitarity triangle arises from $V_{ud} V_{ub}^* + V_{cd} V_{cb}^* + V_{td} V_{tb}^* = 0$, by dividing each side by the best-known one, $V_{cd} V_{cb}^*$

... $\bar{\rho} + i\bar{\eta} = -(V_{ud} V_{ub}^*)/(V_{cd} V_{cb}^*)$ is phase-convention-independent ...

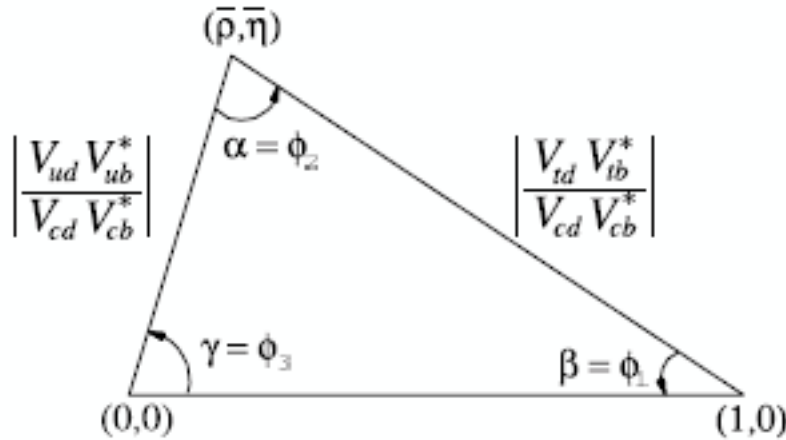

Figure 11.1: Sketch of the unitarity triangle.

... $\sin 2\beta = 0.673 \pm 0.023$... $\alpha = 89.0 +4.4 -4.2$ degrees ... $\gamma = 73 +22 -25$ degrees ... The sum of the three angles of the unitarity triangle, $\alpha + \beta + \gamma = (183 +22 -25)$ degrees, is ... consistent with the SM expectation. ...

The area... of ...[the]... triangle...[is]... half of the Jarlskog invariant, J , which is a phase-convention-independent measure of CP violation, defined by $\text{Im } V_{ij} V_{kl} V_{il}^* V_{kj}^* = J \sum(m,n) \epsilon_{ikm} \epsilon_{jln}$

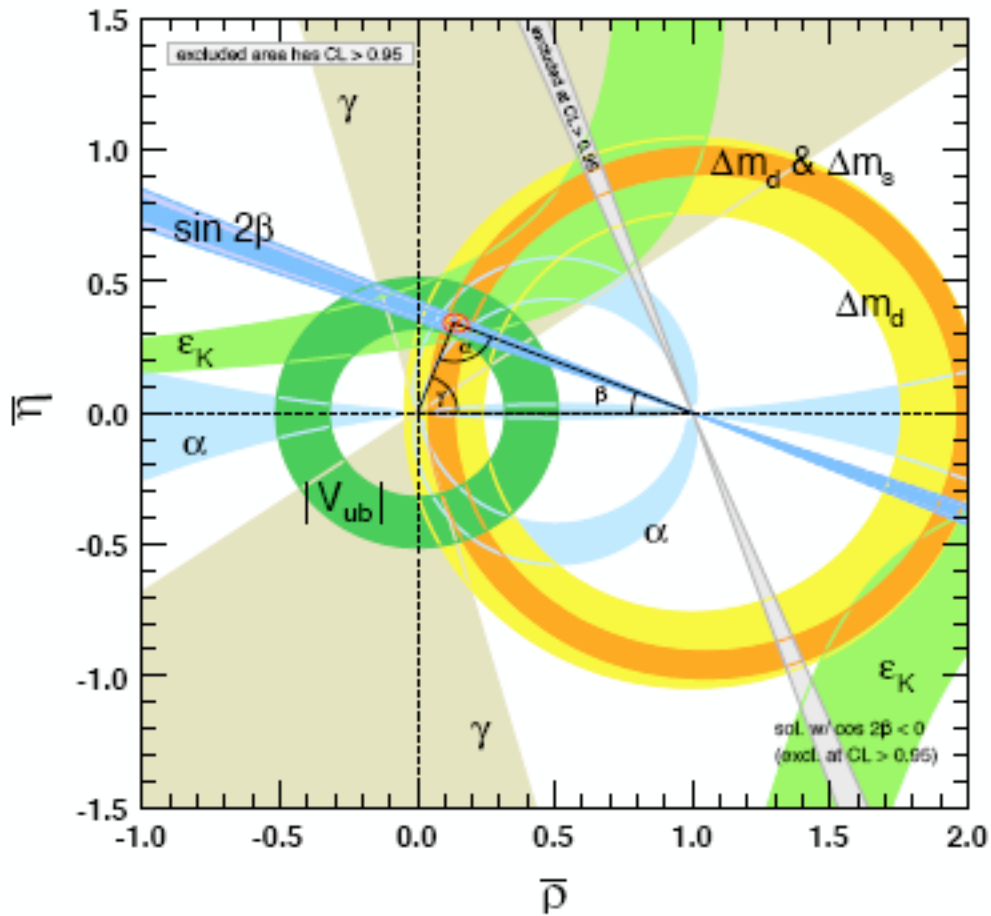

Figure 11.2: Constraints on the $\bar{\rho}, \bar{\eta}$ plane.
The shaded areas have 95% CL.

The fit results for the magnitudes of all nine KM elements are ...

0.97428 ± 0.00015	0.2253 ± 0.0007	$0.00347 +0.00016 -0.00012$
0.2252 ± 0.0007	$0.97345 +0.00015 -0.00016$	$0.0410 +0.0011 -0.0007$
$0.00862 +0.00026 -0.00020$	$0.0403 +0.0011 -0.0007$	$0.999152 +0.000030 -0.000045$

and the Jarlskog invariant is $J = (2.91 +0.19 -0.11) \times 10^{-5}$".

**Above the energy level of ElectroWeak Symmetry Breaking
particles are massless.**

Kea (Marni Sheppeard) proposed
that in the Massless Realm the mixing matrix might be democratic.
In Z. Phys. C - Particles and Fields 45, 39-41 (1989) Koide said: "...
the mass matrix ... MD ... of the type ... $1/3 \times m \times$

$$\begin{matrix} 1 & 1 & 1 \\ 1 & 1 & 1 \\ 1 & 1 & 1 \end{matrix}$$

... has name... "democratic" family mixing ...
the ... democratic ... mass matrix can be diagonalized by the transformation matrix A ...

$$\begin{matrix} 1/\sqrt{2} & -1/\sqrt{2} & 0 \\ 1/\sqrt{6} & 1/\sqrt{6} & -2/\sqrt{6} \\ 1/\sqrt{3} & 1/\sqrt{3} & 1/\sqrt{3} \end{matrix}$$

as $A M D A^t =$

$$\begin{matrix} 0 & 0 & 0 \\ 0 & 0 & 0 \\ 0 & 0 & m \end{matrix}$$

...".

Up in the Massless Realm you might just say that there is no mass matrix,
just a democratic mixing matrix of the form $1/3 \times$

$$\begin{matrix} 1 & 1 & 1 \\ 1 & 1 & 1 \\ 1 & 1 & 1 \end{matrix}$$

with no complex stuff and no CP violation in the Massless Realm.

When go down to our Massive Realm by ElectroWeak Symmetry Breaking
then you might as a first approximation use $m = 1$
so that all the mass first goes to the third generation as

$$\begin{matrix} 0 & 0 & 0 \\ 0 & 0 & 0 \\ 0 & 0 & 1 \end{matrix}$$

which is physically like the Higgs being a T-Tbar quark condensate.

Consider a 3-dim Euclidean space of generations:

The case of mass only going to one generation
can be represented as a line or 1-dimensional simplex



in which the blue mass-line covers the entire black simplex line.

If mass only goes to one other generation
that can be represented by a red line extending to a second dimension
forming a small blue-red-black triangle

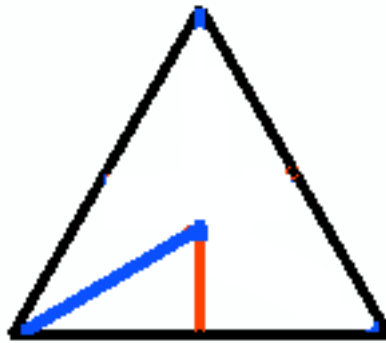

that can be extended by reflection to form six small triangles making up a large triangle

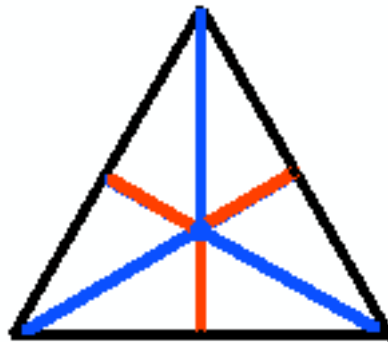

Each of the six component triangles has 30-60-90 angle structure:



If mass goes on further to all three generations that can be represented by a green line extending to a third dimension

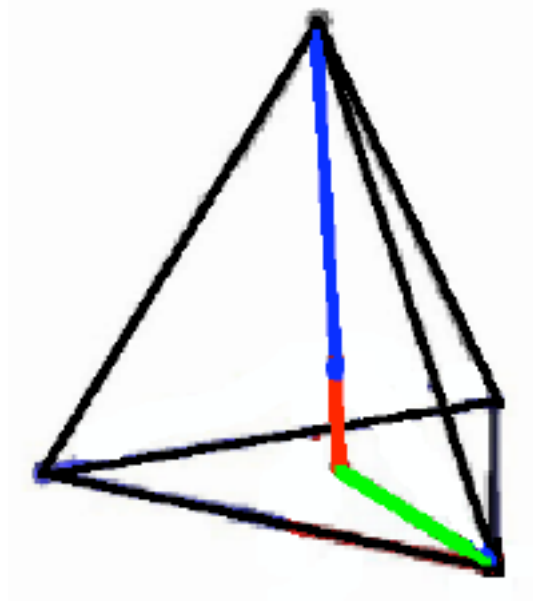

If you move the blue line from the top vertex to join the green vertex

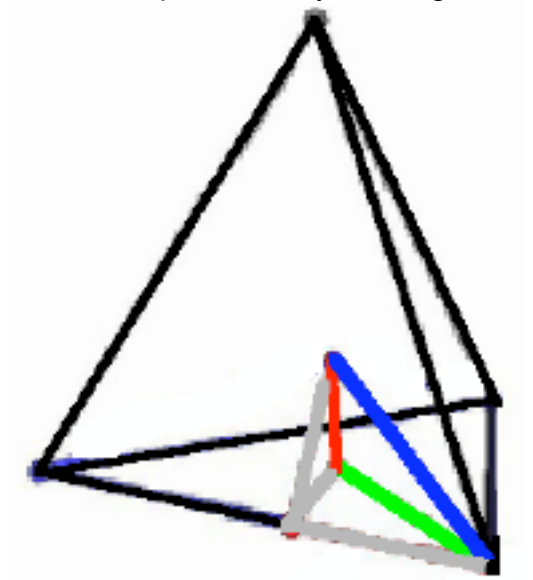

you get a small blue-red-green-gray-gray-gray tetrahedron that can be extended by reflection to form 24 small tetrahedra making up a large tetrahedron.

Reflection among the 24 small tetrahedra corresponds to the $12+12 = 24$ elements of the Binary Tetrahedral Group.

The basic blue-red-green triangle of the basic small tetrahedron

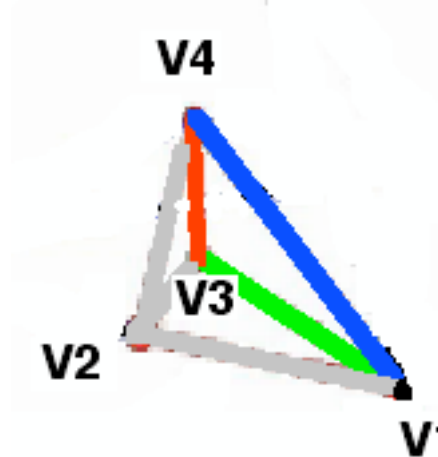

has the angle structure of the K-M Unitary Triangle.

Using data from R. W. Gray's "Encyclopedia Polyhedra: A Quantum Module" with lengths

$V1.V2 = (1/2) EL \equiv$ Half of the regular Tetrahedron's edge length.

$V1.V3 = (1 / \sqrt{3}) EL \approx 0.577\ 350\ 269 EL$

$V1.V4 = 3 / (2 \sqrt{6}) EL \approx 0.612\ 372\ 436 EL$

$V2.V3 = 1 / (2 \sqrt{3}) EL \approx 0.288\ 675\ 135 EL$

$V2.V4 = 1 / (2 \sqrt{2}) EL \approx 0.353\ 553\ 391 EL$

$V3.V4 = 1 / (2 \sqrt{6}) EL \approx 0.204\ 124\ 145 EL$

the Unitarity Triangle angles are:

$\beta = V3.V1.V4 = \arccos(2 \sqrt{2} / 3) \approx 19.471\ 220\ 634$ degrees so $\sin 2\beta = 0.6285$

$\alpha = V1.V3.V4 = 90$ degrees

$\gamma = V1.V4.V3 = \arcsin(2 \sqrt{2} / 3) \approx 70.528\ 779\ 366$ degrees

which is substantially consistent with the 2010 Review of Particle Properties

$\sin 2\beta = 0.673 \pm 0.023$ so $\beta = 21.1495$ degrees

$\alpha = 89.0 +4.4 -4.2$ degrees

$\gamma = 73 +22 -25$ degrees

and so also consistent with the Standard Model expectation.

The constructed Unitarity Triangle angles can be seen on the Stella Octangula configuration of two dual tetrahedra (image from gauss.math.nthu.edu.tw):

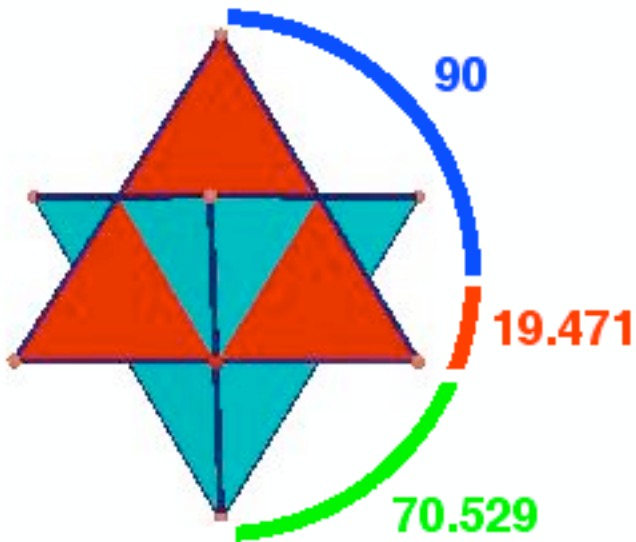

In the $Cl(1,25)$ E_8 model the Kobayashi-Maskawa parameters are determined in terms of the sum of the masses of the 30 first-generation fermion particles and antiparticles, denoted by $S_{mf1} = 7.508$ GeV,

and the similar sums for second-generation and third-generation fermions, denoted by $S_{mf2} = 32.94504$ GeV and $S_{mf3} = 1,629.2675$ GeV.

The reason for using sums of all fermion masses (rather than sums of quark masses only) is that all fermions are in the same spinor representation of $Spin(8)$, and the $Spin(8)$ representations are considered to be fundamental.

The following formulas use the above masses to calculate Kobayashi-Maskawa parameters:

phase angle $d_{13} = \gamma = 70.529$ degrees

$$\sin(\theta_{12}) = s_{12} = [m_e + 3m_d + 3m_\mu] / \sqrt{[m_e^2 + 3m_d^2 + 3m_\mu^2] + [m_\nu^2 + 3m_s^2 + 3m_c^2]} = 0.222198$$

$$\sin(\theta_{13}) = s_{13} = [m_e + 3m_d + 3m_\mu] / \sqrt{[m_e^2 + 3m_d^2 + 3m_\mu^2] + [m_\tau^2 + 3m_b^2 + 3m_t^2]} = 0.004608$$

$$\sin(\theta_{23}) = [m_\nu + 3m_s + 3m_c] / \sqrt{[m_\tau^2 + 3m_b^2 + 3m_t^2] + [m_\nu^2 + 3m_s^2 + 3m_c^2]}$$

$$\sin(\theta_{23}) = s_{23} = \sin(\theta_{23}) \sqrt{(\Sigma_{f2} / \Sigma_{f1})} = 0.04234886$$

The factor $\sqrt{(\Sigma_{f2} / \Sigma_{f1})}$ appears in s_{23} because an s_{23} transition is to the second generation and not all the way to the first generation, so that the end product of an s_{23} transition has a greater available energy than s_{12} or s_{13} transitions by a factor of $\Sigma_{f2} / \Sigma_{f1}$.

Since the width of a transition is proportional to the square of the modulus of the relevant KM entry and the width of an s_{23} transition has greater available energy than the s_{12} or s_{13} transitions by a factor of $\Sigma_{f2} / \Sigma_{f1}$ the effective magnitude of the s_{23} terms in the KM entries is increased by the factor $\sqrt{(\Sigma_{f2} / \Sigma_{f1})}$.

The Chau-Keung parameterization is used, as it allows the K-M matrix to be represented as the product of the following three 3x3 matrices:

$$\begin{pmatrix} 1 & 0 & 0 \\ 0 & \cos(\theta_{23}) & \sin(\theta_{23}) \\ 0 & -\sin(\theta_{23}) & \cos(\theta_{23}) \end{pmatrix}$$

$$\begin{pmatrix} \cos(\theta_{13}) & 0 & \sin(\theta_{13})\exp(-i d_{13}) \\ 0 & 1 & 0 \\ -\sin(\theta_{13})\exp(i d_{13}) & 0 & \cos(\theta_{13}) \end{pmatrix}$$

$$\begin{pmatrix} \cos(\theta_{12}) & \sin(\theta_{12}) & 0 \\ -\sin(\theta_{12}) & \cos(\theta_{12}) & 0 \\ 0 & 0 & 1 \end{pmatrix}$$

The resulting Kobayashi-Maskawa parameters
for W^+ and W^- charged weak boson processes, are:

	d	s	b
u	0.975	0.222	0.00249 -0.00388i
c	-0.222 -0.000161i	0.974 -0.0000365i	0.0423
t	0.00698 -0.00378i	-0.0418 -0.00086i	0.999

The matrix is labelled by either (u c t) input and (d s b) output,
or, as above, (d s b) input and (u c t) output.

For Z^0 neutral weak boson processes, which are suppressed by the GIM
mechanism of cancellation of virtual subprocesses, the matrix is labelled by either
(u c t) input and (u'c't') output, or, as below, (d s b) input and (d's'b') output:

	d	s	b
d'	0.975	0.222	0.00249 -0.00388i
s'	-0.222 -0.000161i	0.974 -0.0000365i	0.0423
b'	0.00698 -0.00378i	-0.0418 -0.00086i	0.999

Since neutrinos of all three generations are massless at tree level,
the lepton sector has no tree-level K-M mixing.

In hep-ph/0208080, Yosef Nir says: "... Within the Standard Model,
the only source of CP violation is the Kobayashi-Maskawa (KM) phase ...
The study of CP violation is, at last, experiment driven. ...
The CKM matrix provides a consistent picture
of all the measured flavor and CP violating processes. ...
There is no signal of new flavor physics. ...
Very likely,
the KM mechanism is the dominant source of CP violation in flavor changing processes.
... The result is consistent with the SM predictions. ...".

Neutrino Masses Beyond Tree Level

Consider the three generations of neutrinos:
nu_e (electron neutrino); nu_mu (muon neutrino); nu_tau
and three neutrino mass states: nu_1 ; nu_2 : nu_3
and
the division of 8-dimensional spacetime into
4-dimensional physical Minkowski spacetime
plus
4-dimensional CP2 internal symmetry space.

The heaviest mass state nu_3 corresponds to a neutrino
whose propagation begins and ends in CP2 internal symmetry
space, lying entirely therein. According to the Cl(1,25) E8 model
the mass of nu_3 is zero at tree-level
but it picks up a first-order correction
propagating entirely through internal symmetry space by merging
with an electron through the weak and electromagnetic forces,
effectively acting not merely as a point
but
as a point plus an electron loop at beginning and ending points
so
the first-order corrected mass of nu_3 is given by
 $M_{\nu_3} \times (1/\sqrt{2}) = M_e \times GW(m_{\text{proton}}^2) \times \alpha_E$
where the factor $(1/\sqrt{2})$ comes from the Ut3 component
of the neutrino mixing matrix
so that

$$\begin{aligned} M_{\nu_3} &= \sqrt{2} \times M_e \times GW(m_{\text{proton}}^2) \times \alpha_E = \\ &= 1.4 \times 5 \times 10^5 \times 1.05 \times 10^{(-5)} \times (1/137) \text{ eV} = \\ &= 7.35 / 137 = 5.4 \times 10^{(-2)} \text{ eV}. \end{aligned}$$

The neutrino-plus-electron loop can be anchored by weak force
action through any of the 6 first-generation quarks
at each of the beginning and ending points, and that the
anchor quark at the beginning point can be different from
the anchor quark at the ending point,
so that there are $6 \times 6 = 36$ different possible anchorings.

The intermediate mass state ν_2 corresponds to a neutrino whose propagation begins or ends in CP2 internal symmetry space and ends or begins in M4 physical Minkowski spacetime, thus having only one point (either beginning or ending) lying in CP2 internal symmetry space where it can act not merely as a point but as a point plus an electron loop.

According to the Cl(1,25) E8 model the mass of ν_2 is zero at tree-level but it picks up a first-order correction at only one (but not both) of the beginning or ending points so that so that there are 6 different possible anchorings for ν_2 first-order corrections, as opposed to the 36 different possible anchorings for ν_3 first-order corrections, so that the first-order corrected mass of ν_2 is less than the first-order corrected mass of ν_3 by a factor of 6, so

the first-order corrected mass of ν_2 is
$$M_{\nu_2} = M_{\nu_3} / \text{Vol}(\text{CP}2) = 5.4 \times 10^{(-2)} / 6$$
$$= 9 \times 10^{(-3)} \text{eV}.$$

The low mass state ν_1 corresponds to a neutrino whose propagation begins and ends in physical Minkowski spacetime. thus having only one anchoring to CP2 interna symmetry space.

According to the Cl(1,25) E8 model the mass of ν_1 is zero at tree-level but it has only 1 possible anchoring to CP2 as opposed to the 36 different possible anchorings for ν_3 first-order corrections or the 6 different possible anchorings for ν_2 first-order corrections so that the first-order corrected mass of ν_1 is less than the first-order corrected mass of ν_2 by a factor of 6, so

the first-order corrected mass of ν_1 is
$$M_{\nu_1} = M_{\nu_2} / \text{Vol}(\text{CP}2) = 9 \times 10^{(-3)} / 6$$
$$= 1.5 \times 10^{(-3)} \text{eV}.$$

Therefore:

$$\begin{aligned} \text{the mass-squared difference } D(M_{23}^2) &= M_{\nu_3}^2 - M_{\nu_2}^2 = \\ &= (2916 - 81) \times 10^{(-6)} \text{ eV}^2 = \\ &= 2.8 \times 10^{(-3)} \text{ eV}^2 \end{aligned}$$

and

$$\begin{aligned} \text{the mass-squared difference } D(M_{12}^2) &= M_{\nu_2}^2 - M_{\nu_1}^2 = \\ &= (81 - 2) \times 10^{(-6)} \text{ eV}^2 = \\ &= 7.9 \times 10^{(-5)} \text{ eV}^2 \end{aligned}$$

The 3x3 unitary neutrino mixing matrix neutrino mixing matrix U

	nu_1	nu_2	nu_3
nu_e	Ue1	Ue2	Ue3
nu_m	Um1	Um2	Um3
nu_t	Ut1	Ut2	Ut3

can be parameterized (based on the 2010 Particle Data Book)
by 3 angles and 1 Dirac CP violation phase

$$U = \begin{pmatrix} c_{12} c_{13} & s_{12} c_{13} & s_{13} e^{-i\delta} \\ -s_{12} c_{23} - c_{12} s_{23} s_{13} e^{i\delta} & c_{12} c_{23} - s_{12} s_{23} s_{13} e^{i\delta} & s_{23} c_{13} \\ s_{12} s_{23} - c_{12} c_{23} s_{13} e^{i\delta} & -c_{12} s_{23} - s_{12} c_{23} s_{13} e^{i\delta} & c_{23} c_{13} \end{pmatrix}$$

where $c_{ij} = \cos(\theta_{ij})$, $s_{ij} = \sin(\theta_{ij})$

The angles are

$\theta_{23} = \pi/4 = 45$ degrees

because

ν_3 has equal components of ν_m and ν_t so
that $U_{m3} = U_{t3} = 1/\sqrt{2}$ or, in conventional
notation, mixing angle $\theta_{23} = \pi/4$

so that $\cos(\theta_{23}) = 0.707 = \sqrt{2}/2 = \sin(\theta_{23})$

$\theta_{13} = 9.594$ degrees = $\arcsin(1/6)$

and $\cos(\theta_{13}) = 0.986$

because $\sin(\theta_{13}) = 1/6 = 0.167 = |U_{e3}|$ = fraction of ν_3 that is ν_e

$\theta_{12} = \pi/6 = 30$ degrees

because

$\sin(\theta_{12}) = 0.5 = 1/2 = U_{e2}$ = fraction of ν_2 begin/end points
that are in the physical spacetime where massless ν_e lives

so that $\cos(\theta_{12}) = 0.866 = \sqrt{3}/2$

$\delta = 70.529$ degrees is the Dirac CP violation phase

$e^{i(70.529)} = \cos(70.529) + i \sin(70.529) = 0.333 + 0.943 i$

This is because the neutrino mixing matrix has 3-generation structure

and so has the same phase structure as the KM quark mixing matrix

in which the Unitarity Triangle angles are:

$\beta = V_3.V_1.V_4 = \arccos(2 \sqrt{2} / 3) \cong 19.471 220 634$ degrees so $\sin 2\beta = 0.6285$

$\alpha = V_1.V_3.V_4 = 90$ degrees

$\gamma = V_1.V_4.V_3 = \arcsin(2 \sqrt{2} / 3) \cong 70.528 779 366$ degrees

The constructed Unitarity Triangle angles can be seen on the Stella Octangula configuration of two dual tetrahedra (image from gauss.math.nthu.edu.tw):

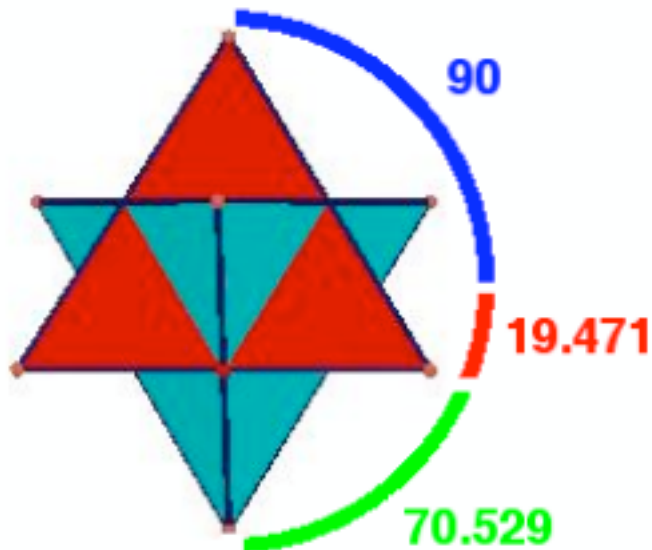

Then we have for the neutrino mixing matrix:

	nu_1	nu_2	nu_3
nu_e	0.866 x 0.986	0.50 x 0.986	0.167 x e-id
nu_m	-0.5 x 0.707 -0.866 x 0.707 x 0.167 x eid	0.866 x 0.707 -0.5 x 0.707 x 0.167 x eid	0.707 x 0.986
nu_t	0.5 x 0.707 -0.866 x 0.707 x 0.167 x eid	-0.866 x 0.707 -0.5 x 0.707 x 0.167 x eid	0.707 x 0.986

	nu_1	nu_2	nu_3
nu_e	0.853	0.493	0.167 e-id
nu_m	-0.354 -0.102 eid	0.612 -0.059 eid	0.697
nu_t	0.354 -0.102 eid	-0.612 -0.059 eid	0.697

Since $e^{i(70.529)} = \cos(70.529) + i \sin(70.529) = 0.333 + 0.943 i$
and $.333e^{-i(70.529)} = \cos(70.529) - i \sin(70.529) = 0.333 - 0.943 i$

	nu_1	nu_2	nu_3
nu_e	0.853	0.493	0.056 - 0.157 i
nu_m	-0.354 -0.034 - 0.096 i	0.612 -0.020 - 0.056 i	0.697
nu_t	0.354 -0.034 - 0.096 i	-0.612 -0.020 - 0.056 i	0.697

for a result of

	nu_1	nu_2	nu_3
nu_e	0.853	0.493	0.056 - 0.157 i
nu_m	-0.388 - 0.096 i	0.592 - 0.056 i	0.697
nu_t	0.320 - 0.096 i	0.632 - 0.056 i	0.697

which is consistent with the approximate experimental values of mixing angles shown in the Michaelmas Term 2010 Particle Physics handout of Prof Mark Thomson if the matrix is modified by taking into account the March 2012 results from Daya Bay observing non-zero $\theta_{13} = 9.54$ degrees.

Proton-Neutron Mass Difference

An up valence quark, constituent mass 313 Mev,
 does not often swap places with a 2.09 Gev charm sea quark,
 but
 a 313 Mev down valence quark
 can more often swap places with a 625 Mev strange sea quark.

Therefore the Quantum color force
 constituent mass of the down valence quark is heavier by about

$$(m_s - m_d) (m_d/m_s)^2 a(w) |V_{ds}| = 312 \times 0.25 \times 0.253 \times 0.22 \text{ Mev} = 4.3 \text{ Mev},$$

(where $a(w) = 0.253$ is the geometric part of the weak force strength
 and $|V_{ds}| = 0.22$ is the magnitude
 of the K-M parameter mixing first generation down and second generation strange)

so that the Quantum color force constituent mass Q_{md} of the down quark is

$$Q_{md} = 312.75 + 4.3 = 317.05 \text{ MeV}.$$

Similarly, the up quark Quantum color force mass increase is about

$$(m_c - m_u) (m_u/m_c)^2 a(w) |V_{uc}| = 1777 \times 0.022 \times 0.253 \times 0.22 \text{ Mev} = 2.2 \text{ Mev},$$

(where $|V_{uc}| = 0.22$ is the magnitude
 of the K-M parameter mixing first generation up and second generation charm)

so that the Quantum color force constituent mass Q_{mu} of the up quark is

$$Q_{mu} = 312.75 + 2.2 = 314.95 \text{ MeV}.$$

Therefore, the Quantum color force Neutron-Proton mass difference is

$$m_N - m_P = Q_{md} - Q_{mu} = 317.05 \text{ Mev} - 314.95 \text{ Mev} = 2.1 \text{ Mev}.$$

Since the electromagnetic Neutron-Proton mass difference is roughly

$$m_N - m_P = -1 \text{ MeV}$$

the total theoretical Neutron-Proton mass difference is

$$m_N - m_P = 2.1 \text{ Mev} - 1 \text{ Mev} = 1.1 \text{ Mev},$$

an estimate that is comparable to the experimental value of 1.3 Mev.

Pion as Sine-Gordon Breather

The quark content of a charged pion is a quark - antiquark pair: either Up plus antiDown or Down plus antiUp. Experimentally, its mass is about 139.57 MeV.

The quark is a Schwinger Source Kerr-Newman Black Hole with constituent mass M 312 MeV.

The antiquark is also a Schwinger Source Kerr-Newman Black Hole, with constituent mass M 312 MeV.

According to section 3.6 of Jeffrey Winicour's 2001 Living Review of the Development of Numerical Evolution Codes for General Relativity (see also a 2005 update):

"... The black hole event horizon associated with ... slightly broken ... degeneracy [of the axisymmetric configuration]... reveals new features not seen in the degenerate case of the head-on collision ... If the degeneracy is slightly broken, the individual black holes form with spherical topology but as they approach, tidal distortion produces two sharp pincers on each black hole just prior to merger. ...

Tidal distortion of approaching black holes ... Formation of sharp pincers just prior to merger ..

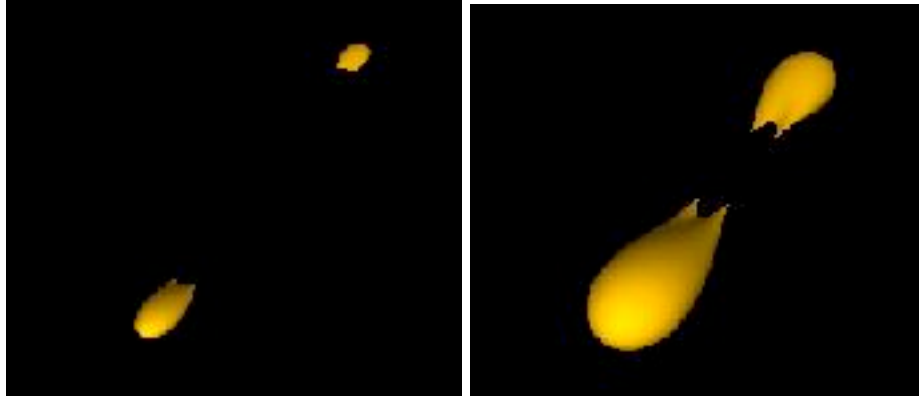

... toroidal stage just after merger ...

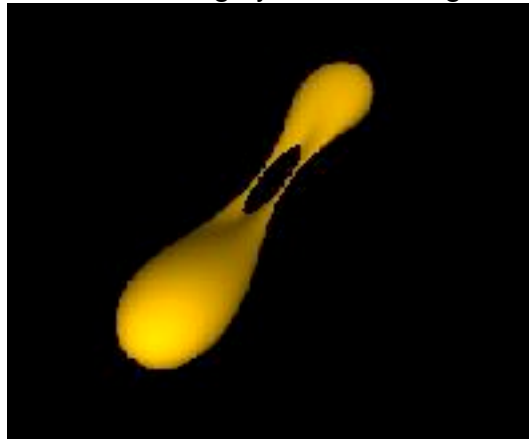

At merger, the two pincers join to form a single ... toroidal black hole.

The inner hole of the torus subsequently [begins to] close... up (superluminally) ... [If the closing proceeds to completion, it]... produce[s] first a peanut shaped black hole and finally a spherical black hole. ...".

In the physical case of quark and antiquark forming a pion, the toroidal black hole remains a torus.

The torus is an event horizon and therefore is not a 2-spacelike dimensional torus, but is a (1+1)-dimensional torus with a timelike dimension.

The effect is described in detail in Robert Wald's book General Relativity (Chicago 1984). It can be said to be due to extreme frame dragging, or to timelike translations becoming spacelike as though they had been Wick rotated in Complex SpaceTime.

As Hawking and Ellis say in The LargeScale Structure of Space-Time (Cambridge 1973):

"... The surface $r = r_+$ is ... the event horizon ... and is a null surface ...

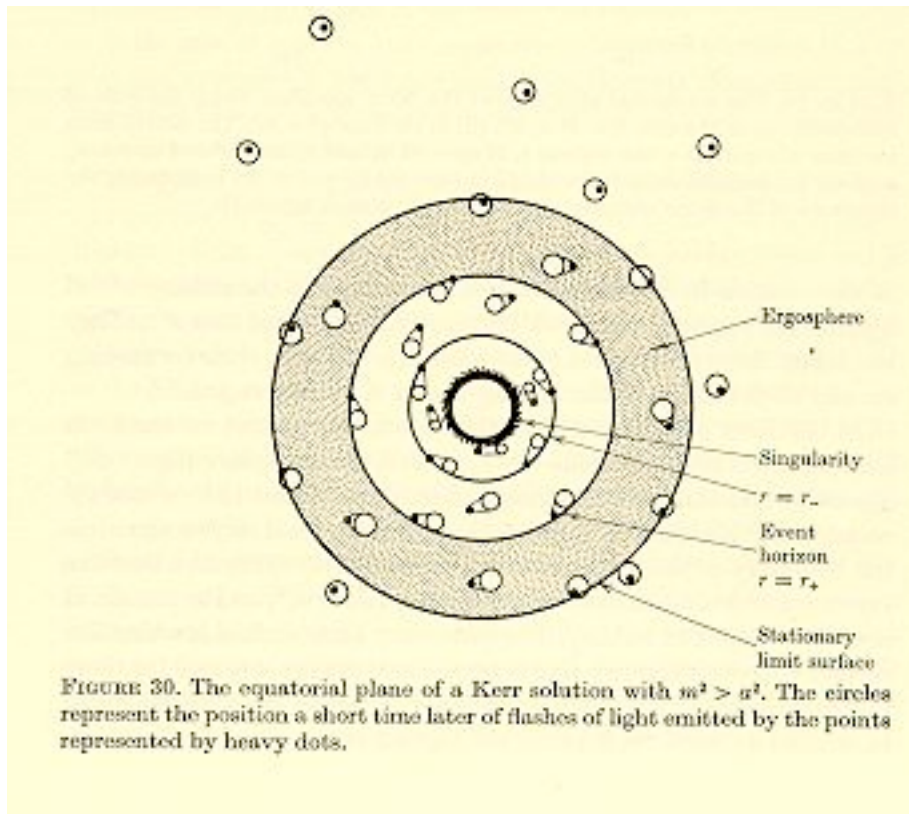

... On the surface $r = r_+$ the wavefront corresponding to a point on this surface lies entirely within the surface. ...".

A (1+1)-dimensional torus with a timelike dimension can carry a Sine-Gordon Breather. The soliton and antisoliton of a Sine-Gordon Breather correspond to the quark and antiquark that make up the pion, analogous to the Massive Thirring Model.

Sine-Gordon Breathers are described by Sidney Coleman in his Erica lecture paper Classical Lumps and their Quantum Descendants (1975), reprinted in his book Aspects of Symmetry (Cambridge 1985), where he writes the Lagrangian for the Sine-Gordon equation as (Coleman's eq. 4.3):

$$L = (1 / B^2) ((1/2) (df)^2 + A (\cos(f) - 1))$$

Coleman says: "... We see that, in classical physics, B is an irrelevant parameter: if we can solve the sine-Gordon equation for any non-zero B, we can solve it for any other B.

The only effect of changing B is the trivial one of changing the energy and momentum assigned to a given solution of the equation. This is not true in quantum physics, because the relevant object for quantum physics is not L but [eq. 4.4]

$$L / \hbar = (1 / (B^2 \hbar)) ((1/2) (df)^2 + A (\cos(f) - 1))$$

An other way of saying the same thing is to say that in quantum physics we have one more dimensional constant of nature, Planck's constant, than in classical physics. ... the classical limit, vanishing \hbar , is exactly the same as the small-coupling limit, vanishing B ... from now on I will ... set \hbar equal to one. ...

... the sine-Gordon equation ...[has]... an exact periodic solution ...[eq. 4.59]...

$$f(x, t) = (4 / B) \arctan((n \sin(w t) / \cosh(n w x))$$

where [eq. 4.60] $n = \sqrt{ A - w^2 } / w$ and w ranges from 0 to A.

This solution has a simple physical interpretation ... a soliton far to the left ...[and]... an antisoliton far to the right. As $\sin(w t)$ increases, the soliton and antisoliton move farther apart from each other. When $\sin(w t)$ passes through one, they turn around and begin to approach one another. As $\sin(w t)$ comes down to zero ... the soliton and antisoliton are on top of each other ... when $\sin(w t)$ becomes negative .. the soliton and antisoliton have passed each other.

... Thus, Eq. (4.59) can be thought of as a soliton and an antisoliton oscillation about their common center-of-mass. For this reason, it is called 'the doublet [or Breather] solution'. ... the energy of the doublet ...[eq. 4.64]

$$E = 2 M \sqrt{ 1 - (w^2 / A) }$$

where [eq. 4.65] $M = 8 \sqrt{ A } / B^2$ is the soliton mass.

Note that the mass of the doublet is always less than twice the soliton mass, as we would expect from a soliton-antisoliton pair. ...

Dashen, Hasslacher, and Neveu ... Phys. Rev. D10, 4114; 4130; 4138 (1974).
 ...[found that]... there is only a single series of bound states, labeled by the integer N ...
 The energies ... are ... [eq. 4.82]

$$E_N = 2 M \sin(B'^2 N / 16)$$

where $N = 0, 1, 2 \dots < 8 \pi / B'^2$, [eq. 4.83]

$B'^2 = B^2 / (1 - (B^2 / 8 \pi))$ and M is the soliton mass.

M is not given by Eq. (4.65), but is the soliton mass corrected by the DHN formula, or, equivalently, by the first-order weak coupling expansion. ...

I have written the equation in this form .. to eliminate A, and thus avoid worries about renormalization conventions.

Note that the DHN formula is identical to the Bohr-Sommerfeld formula, except that B is replaced by B'

Bohr and Sommerfeld[']s ... quantization formula says that if we have a one-parameter family of periodic motions, labeled by the period, T, then an energy eigenstate occurs whenever [eq. 4.66]

$$[\text{Integral from 0 to T}](dt p \dot{q} = 2 \pi N,$$

where N is an integer. ... Eq.(4.66) is cruder than the WKB formula, but it is much more general;

it is always the leading approximation for any dynamical system ...

Dashen et al speculate that Eq. (4.82) is exact. ...

the sine-Gordon equation is equivalent ... to the massive Thirring model.

This is surprising,

because the massive Thirring model is a canonical field theory

whose Hamiltonian is expressed in terms of fundamental Fermi fields only.

Even more surprising, when $B^2 = 4 \pi$, that sine-Gordon equation is equivalent to a free massive Dirac theory, in one spatial dimension. ...

Furthermore, we can identify the mass term in the Thirring model with the sine-Gordon interaction, [eq. 5.13]

$$M = - (A / B^2) N_m \cos(B f)$$

.. to do this consistently ... we must say [eq. 5.14]

$$B^2 / (4 \pi) = 1 / (1 + g / \pi)$$

....[where]... g is a free parameter, the coupling constant [for the Thirring model]...

Note that if $B^2 = 4 \pi$, $g = 0$,

and the sine-Gordon equation is the theory of a free massive Dirac field. ...

It is a bit surprising to see a fermion appearing as a coherent state of a Bose field.

Certainly this could not happen in three dimensions,

where it would be forbidden by the spin-statistics theorem.

However, there is no spin-statistics theorem in one dimension,

for the excellent reason that there is no spin. ...

the lowest fermion-antifermion bound state of the massive Thirring model

is an obvious candidate for the fundamental meson of sine-Gordon theory. ...

equation (4.82) predicts that

all the doublet bound states disappear when B^2 exceeds 4π .

This is precisely the point where the Thirring model interaction switches from attractive to repulsive. ... these two theories ... the massive Thirring model .. and ... the sine-Gordon equation ... define identical physics. ...

I have computed the predictions of ...[various]... approximation methods for the ration of the soliton mass to the meson mass for three values of B^2 : 4π (where the qualitative picture of the soliton as a lump totally breaks down), 2π , and π . At 4π we know the exact answer ... I happen to know the exact answer for 2π , so I have included this in the table. ...

Method	$B^2 = \pi$	$B^2 = 2\pi$	$B^2 = 4\pi$
Zeroth-order weak coupling expansion eq2.13b	2.55	1.27	0.64
Coherent-state variation	2.55	1.27	0.64
First-order weak coupling expansion	2.23	0.95	0.32
Bohr-Sommerfeld eq4.64	2.56	1.31	0.71
DHN formula eq4.82	2.25	1.00	0.50
Exact	?	1.00	0.50

...[eq. 2.13b]

$$E = 8 \sqrt{A} / B^2$$

...[is the]... energy of the lump ... of sine-Gordon theory ... frequently called 'soliton...' in the literature ...

[Zeroth-order is the classical case, or classical limit.] ...

... Coherent-state variation always gives the same result as the ... Zeroth-order weak coupling expansion The ... First-order weak-coupling expansion ... explicit formula ... is $(8 / B^2) - (1 / \pi)$".

Using the $Cl(1,25)$ E8 model constituent mass of the Up and Down quarks and antiquarks, about 312.75 MeV, as the soliton and antisoliton masses, and setting $B^2 = \pi$ and using the DHN formula, the mass of the charged pion is calculated to be $(312.75 / 2.25)$ MeV = 139 MeV which is close to the experimental value of about 139.57 MeV.

Why is the value $B^2 = \pi$ the special value that gives the pion mass ?

(or, using Coleman's eq. (5.14), the Thirring coupling constant $g = 3\pi$)

Because $B^2 = \pi$ is where the First-order weak coupling expansion substantially coincides with the (probably exact) DHN formula. In other words,

The physical quark - antiquark pion lives where the first-order weak coupling expansion is exact.

Planck Mass as Superposition Fermion Condensate

At a single spacetime vertex, a Planck-mass black hole is the Many-Worlds quantum sum of all possible virtual first-generation particle-antiparticle fermion pairs allowed by the Pauli exclusion principle to live on that vertex.

Once a Planck-mass black hole is formed, it is stable in the E8 model. Less mass would not be gravitationally bound at the vertex. More mass at the vertex would decay by Hawking radiation.

There are 8 fermion particles and 8 fermion antiparticles for a total of 64 particle-antiparticle pairs. Of the 64 particle-antiparticle pairs, 12 are bosonic pions.

A typical combination should have about 6 pions so it should have a mass of about $.14 \times 6 \text{ GeV} = 0.84 \text{ GeV}$.

Just as the pion mass of .14 GeV is less than the sum of the masses of a quark and an antiquark, pairs of oppositely charged pions may form a bound state of less mass than the sum of two pion masses.

If such a bound state of oppositely charged pions has a mass as small as .1 GeV, and if the typical combination has one such pair and 4 other pions, then the typical combination could have a mass in the range of 0.66 GeV.

Summing over all 2^{64} combinations, the total mass of a one-vertex universe should give a Planck mass roughly around $0.66 \times 2^{64} = 1.217 \times 10^{19} \text{ GeV}$.

The value for the Planck mass given in by the 1998 Particle Data Group is $1.221 \times 10^{19} \text{ GeV}$.

Conformal Gravity and ratio DE : DM : OM

MacDowell-Mansouri Gravity is described by Rabindra Mohapatra in section 14.6 of his book "Unification and Supersymmetry":

§14.6. Local Conformal Symmetry and Gravity

Before we study supergravity, with the new algebraic approach developed, we would like to discuss how gravitational theory can emerge from the gauging of conformal symmetry. For this purpose we briefly present the general notation for constructing gauge covariant fields. The general procedure is to start with the Lie algebra of generators X_A of a group

$$[X_A, X_B] = f_{AB}^C X_C, \quad (14.6.1)$$

where f_{AB}^C are structure constants of the group. We can then introduce a gauge field connection h_μ^A as follows:

$$h_\mu = h_\mu^A X_A. \quad (14.6.2)$$

Let us denote the parameter associated with X_A by ϵ^A . The gauge transformations on the fields h_μ^A are given as follows:

$$\delta h_\mu^A = \partial_\mu \epsilon^A + h_\mu^B \epsilon^C f_{CB}^A \equiv (D_\mu \epsilon)^A. \quad (14.6.3)$$

We can then define a covariant curvature

$$R_{\mu\nu}^A = \partial_\nu h_\mu^A - \partial_\mu h_\nu^A + h_\nu^B h_\mu^C f_{CB}^A. \quad (14.6.4)$$

Under a gauge transformation

$$\delta_{\text{gauge}} R_{\mu\nu}^A = R_{\mu\nu}^B \epsilon^C f_{CB}^A. \quad (14.6.5)$$

We can then write the general gauge invariant action as follows:

$$I = \int d^4x Q_{AB}^{\mu\nu\sigma\tau} R_{\mu\nu}^A R_{\sigma\tau}^B. \quad (14.6.6)$$

Let us now apply this formalism to conformal gravity. In this case

$$h_\mu = P_\mu e_\nu^n + M_{nm} \omega_\mu^{nm} + K_n f_\mu^n + D b_\mu. \quad (14.6.7)$$

The various $R_{\mu\nu}$ are

$$R_{\mu\nu}(P) = \partial_\nu e_\mu^n - \partial_\mu e_\nu^n + \omega_\mu^{mn} e_\nu^n - \omega_\nu^{mn} e_\mu^n - b_\mu e_\nu^n + b_\nu e_\mu^n, \quad (14.6.8)$$

$$R_{\mu\nu}(M) = \partial_\nu \omega_\mu^{mn} - \partial_\mu \omega_\nu^{mn} - \omega_\nu^{mp} \omega_\mu^{nq} - \omega_\mu^{mp} \omega_\nu^{nq} - 4(e_\mu^n f_\nu^n - e_\nu^n f_\mu^n), \quad (14.6.9)$$

$$R_{\mu\nu}(K) = \partial_\nu f_\mu^n - \partial_\mu f_\nu^n - b_\mu f_\nu^n + b_\nu f_\mu^n + \omega_\mu^{mn} f_\nu^n - \omega_\nu^{mn} f_\mu^n, \quad (14.6.10)$$

$$R_{\mu\nu}(D) = \partial_\nu b_\mu - \partial_\mu b_\nu + 2e_\mu^n f_\nu^n - 2e_\nu^n f_\mu^n. \quad (14.6.11)$$

The gauge invariant Lagrangian for the gravitational field can now be written down, using eqn. (14.6.6), as

$$S = \int d^4x \epsilon_{\mu\nu\rho\sigma} \epsilon^{\alpha\beta\gamma\delta} R_{\mu\nu}^{\alpha\beta}(M) R_{\rho\sigma}^{\gamma\delta}(M). \quad (14.6.12)$$

We also impose the constraint that

$$R_{\mu\nu}(P) = 0, \quad (14.6.13)$$

which expresses ω_a^{mn} as a function of (e, b) . The reason for imposing this constraint has to do with the fact that P_m transformations must be eventually identified with coordinate transformation. To see this point more explicitly let us consider the vierbein e_a^μ . Under coordinate transformations

$$\delta_{GC}(\xi^\nu)e_a^\mu = \partial_\nu \xi^\lambda e_\lambda^\mu + \xi^\lambda \partial_\lambda e_a^\mu. \quad (14.6.14)$$

Using eqn. (14.6.8) we can rewrite

$$\delta_{GC}(\xi^\nu)e_a^\mu = \delta_P(\xi^\nu)e_a^\mu + \delta_M(\xi\omega^{mn})e_a^\mu + \delta_D(\xi b)e_a^\mu + \xi^\nu R_{\nu\alpha}^\mu(P),$$

where

$$\delta_P(\xi^\nu)e_a^\mu = \partial_\nu \xi^\mu + \xi^\nu \omega_a^{\mu\sigma} + \xi^\sigma b_{\nu a}. \quad (14.6.15)$$

If $R^{\mu\nu}(P) = 0$, the general coordinate transformation becomes related to a set of gauge transformations via eqn. (14.6.15).

At this point we also wish to point out how we can define the covariant derivative. In the case of internal symmetries $D_\mu = \partial_\mu - iX_A h_\mu^A$; now since momentum is treated as an internal symmetry we have to give a rule. This follows from eqn. (14.6.15) by writing a redefined translation generator \tilde{P} such that

$$\delta_{\tilde{P}}(\xi) = \delta_{GC}(\xi^\nu) - \sum_A \delta_A(\xi^\mu h_\mu^A), \quad (14.6.16)$$

where A' goes over all gauge transformations excluding translation. The rule is

$$\delta_{\tilde{P}}(\xi^\mu)\phi = \xi^\mu D_\mu^C \phi. \quad (14.6.17)$$

We also wish to point out that for fields which carry spin or conformal charge, only the intrinsic parts contribute to D_μ^C and the orbital parts do not play any role.

Coming back to the constraints we can then vary the action with respect to f_a^μ to get an expression for it, i.e.,

$$e_a^\mu f_{a\mu} = -\frac{1}{4}[e_a^\lambda e_{\lambda\sigma} R_{\lambda\sigma}^{mn} - \frac{1}{6}g_{\mu\nu} R], \quad (14.6.18)$$

where f_a^μ has been set to zero in R written in the right-hand side.

This eliminates (from the theory the degrees of freedom) ω_a^{mn} and f_a^μ and we are left with e_a^μ and $b_{\mu\nu}$. Furthermore, these constraints will change the transformation laws for the dependent fields so that the constraints do not change.

Let us now look at the matter coupling to see how the familiar gravity theory emerges from this version. Consider a scalar field ϕ . It has conformal weight $\lambda = 1$. So we can write a covariant derivative for it, eqn. (14.6.17)

$$D_\mu^C \phi = \partial_\mu \phi - \phi b_\mu. \quad (14.6.19)$$

We note that the conformal charge of ϕ can be assumed to be zero since $K_m = x^2 \partial$ and is the dimension of inverse mass. In order to calculate $\square^C \phi$ we

start with the expression for d'Alembertian in general relativity

$$\frac{1}{e} \partial_\nu (g^{\mu\nu} e D_\mu^c \phi). \quad (14.6.20)$$

The only transformations we have to compensate for are the conformal transformations and the scale transformations. Since

$$\delta b_\mu = -2\xi_k^m e_{m\mu}, \quad \delta(\phi b_\mu) = \phi \delta b_\mu = -2\phi f_\mu^m e_m^\nu = +\frac{1}{2} \phi R, \quad (14.6.21)$$

where, in the last step, we have used the constraint equation (14.6.18). Putting all these together we find

$$\square^c \phi = \frac{1}{e} \partial_\nu (g^{\mu\nu} e D_\mu^c \phi) + b_\mu D_\mu^c \phi + \frac{1}{2} \phi R. \quad (14.6.22)$$

Thus, the Lagrangian for conformal gravity coupled to matter fields can be written as

$$S = \int e d^4x \frac{1}{2} \phi \square^c \phi. \quad (14.6.23)$$

Now we can use conformal transformation to gauge $b_\mu = 0$ and local scale transformation to set $\phi = \kappa^{-1}$ leading to the usual Hilbert action for gravity. To summarize, we start with a Lagrangian invariant under full local conformal symmetry and fix conformal and scale gauge to obtain the usual action for gravity. We will adopt the same procedure for supergravity. An important technical point to remember is that, \square^c , the conformal d'Alembertian contains R , which for constant ϕ , leads to gravity. We may call ϕ the auxiliary field.

After the scale and conformal gauges have been fixed, the conformal Lagrangian becomes a de Sitter Lagrangian.

Einstein-Hilbert gravity can be derived from the de Sitter Lagrangian, as was first shown by MacDowell and Mansouri (Phys. Rev. Lett. 38 (1977) 739).

(Frank Wilczek, in hep-th/9801184 says that the MacDowell-Mansouri "... approach to casting gravity as a gauge theory was initiated by MacDowell and Mansouri ...

S. MacDowell and F. Mansouri, Phys. Rev. Lett. 38 739 (1977) ... ,

and independently Chamseddine and West ... A. Chamseddine and P. West Nucl. Phys. B 129, 39 (1977);

also quite relevant is A. Chamseddine, Ann. Phys. 113, 219 (1978). ...".)

**The minimal group required to produce Gravity,
and therefore the group that is used in calculating Force Strengths,
is the [anti] de Sitter group,** as is described by

Freund in chapter 21 of his book Supersymmetry (Cambridge 1986) (chapter 21 is a Non-Supersymmetry chapter leading up to a Supergravity description in the following chapter 22):

"... Einstein gravity as a gauge theory ... we expect a set of gauge fields w^{ab}_u for the Lorentz group and a further set e^a_u for the translations, ...

Everybody knows though, that Einstein's theory contains but one spin two field, originally chosen by Einstein as $g_{uv} = e^a_u e^b_v n_{ab}$ (n_{ab} = Minkowski metric).

What happened to the w^{ab}_u ?

The field equations obtained from the Hilbert-Einstein action by varying the w^{ab}_u are algebraic in the w^{ab}_u ... permitting us to express the w^{ab}_u in terms of the e^a_u ... The w do not propagate ...

We start from the four-dimensional de-Sitter algebra ... $so(3,2)$.

Technically this is the anti-de-Sitter algebra ...

We envision space-time as a four-dimensional manifold M .

At each point of M we have a copy of $SO(3,2)$ (a fibre ...) ...

and we introduce the gauge potentials (the connection) $h^A_\mu(x)$

$A = 1, \dots, 10$, $\mu = 1, \dots, 4$. Here x are local coordinates on M .

From these potentials h^A_μ we calculate the field-strengths (curvature components) [let $@$ denote partial derivative]

$R^A_\mu{}^\nu = @_\mu h^A_\nu - @_\nu h^A_\mu + f^A_{BC} h^B_\mu h^C_\nu$

...[where]... the structure constants f^C_{AB} ...[are for]... the anti-de-Sitter algebra

We now wish to write down the action S as an integral over the four-manifold M ... $S(Q) = \text{INTEGRAL}_M R^A \wedge R^B Q_{AB}$

where Q_{AB} are constants ... to be chosen ... we require

... the invariance of $S(Q)$ under local Lorentz transformations

... the invariance of $S(Q)$ under space inversions ...

...[AFTER A LOT OF ALGEBRA NOT SHOWN IN THIS QUOTE]...

we shall see ...[that]... the action becomes invariant

under all local [anti]de-Sitter transformations ...[and]... we recognize ... t

he familiar Hilbert-Einstein action with cosmological term in vierbein notation ...

Variation of the vierbein leads to the Einstein equations with cosmological term.

Variation of the spin-connection ... in turn ... yield the torsionless Christoffel connection ... the torsion components ... now vanish.

So at this level full $sp(4)$ invariance has been checked.

... Were it not for the assumed space-inversion invariance ...

we could have had a parity violating gravity. ...

Unlike Einstein's theory ...[MacDowell-Mansouri].... does not require Riemannian invertibility of the metric. ... the solution has torsion ... produced by an interference between parity violating and parity conserving amplitudes.

Parity violation and torsion go hand-in-hand.

Independently of any more realistic parity violating solution of the gravity equations this raises the cosmological question whether

the universe as a whole is in a space-inversion symmetric configuration. ...".

According to gr-qc/9809061 by R. Aldrovandi and J. G. Peireira:

"... If the fundamental spacetime symmetry of the laws of Physics is that given by the de Sitter instead of the Poincare group, the P-symmetry of the weak cosmological-constant limit and the Q-symmetry of the strong cosmological constant limit can be considered as limiting cases of the fundamental symmetry. ...

... N ... [is the space]... whose geometry is gravitationally related to an infinite cosmological constant ...[and]... is a 4-dimensional cone-space in which $ds = 0$, and whose group of motion is Q. Analogously to the Minkowski case, N is also a homogeneous space, but now under the kinematical group Q, that is, $N = Q/L$ [where L is the Lorentz Group of Rotations and Boosts]. In other words, the point-set of N is the point-set of the special conformal transformations.

Furthermore, the manifold of Q is a principal bundle $P(Q/L, L)$, with $Q/L = N$ as base space and L as the typical fiber. The kinematical group Q, like the Poincare group, has the Lorentz group L as the subgroup accounting for both the isotropy and the equivalence of inertial frames in this space. However, the special conformal transformations introduce a new kind of homogeneity. Instead of ordinary translations, all the points of N are equivalent through special conformal transformations. ...

... Minkowski and the cone-space can be considered as dual to each other, in the sense that their geometries are determined respectively by a vanishing and an infinite cosmological constants. The same can be said of their kinematical group of motions: P is associated to a vanishing cosmological constant and Q to an infinite cosmological constant.

The dual transformation connecting these two geometries is the spacetime inversion $x^u \rightarrow x^u / \sigma^2$. Under such a transformation, the Poincare group P is transformed into the group Q, and the Minkowski space M becomes the conespace N. The points at infinity of M are concentrated in the vertex of the conespace N, and those on the light-cone of M becomes the infinity of N. It is concepts of space isotropy and equivalence between inertial frames in the conespace N are those of special relativity. The difference lies in the concept of uniformity as it is the special conformal transformations, and not ordinary translations, which act transitively on N. ..."

Gravity and the Cosmological Constant come from the MacDowell-Mansouri Mechanism and the 15-dimensional Spin(2,4) = SU(2,2) Conformal Group, which is made up of:

**3 Rotations
3 Boosts
4 Translations
4 Special Conformal transformations
1 Dilatation**

The **Cosmological Constant / Dark Energy** comes from the **10 Rotation, Boost, and Special Conformal generators** of the Conformal Group Spin(2,4) = SU(2,2), so the fractional part of our Universe of the Cosmological Constant should be **about 10 / 15 = 67% for tree level.**

Black Holes, including **Dark Matter Primordial Black Holes**, are curvature singularities in our 4-dimensional physical spacetime, and since Einstein-Hilbert curvature comes from the **4 Translations** of the 15-dimensional Conformal Group Spin(2,4) = SU(2,2) through the MacDowell-Mansouri Mechanism (in which the generators corresponding to the 3 Rotations and 3 Boosts do not propagate), the fractional part of our Universe of Dark Matter Primordial Black Holes should be **about 4 / 15 = 27% at tree level.**

Since **Ordinary Matter** gets mass from the Higgs mechanism which is related to the **1 Scale Dilatation** of the 15-dimensional Conformal Group Spin(2,4) = SU(2,2), the fractional part of our universe of Ordinary Matter should be **about 1 / 15 = 6% at tree level.**

However,
as Our Universe evolves the Dark Energy, Dark Matter, and Ordinary Matter densities evolve at different rates,
so that the differences in evolution must be taken into account from the initial End of Inflation to the Present Time.

Without taking into account any evolutionary changes with time,
our Flat Expanding Universe should have roughly:

**67% Cosmological Constant
27% Dark Matter - possibly primordial stable Planck mass black holes
6% Ordinary Matter**

As Dennis Marks pointed out to me,
 since density ρ is proportional to $(1+z)^3(1+w)$ for red-shift factor z
 and a constant equation of state w :
 $w = -1$ for Λ and the average overall density of Λ Dark Energy remains constant
 with time and the expansion of our Universe;
 and
 $w = 0$ for nonrelativistic matter so that the overall average density of Ordinary
 Matter declines as $1 / R^3$ as our Universe expands;
 and
 $w = 0$ for primordial black hole dark matter - stable Planck mass black holes - so
 that Dark Matter also has density that declines as $1 / R^3$ as our Universe expands;
 so that the ratio of their overall average densities must vary with time, or scale
 factor R of our Universe, as it expands.
 Therefore,
 the above calculated ratio $0.67 : 0.27 : 0.06$ is valid
 only for a particular time, or scale factor, of our Universe.

When is that time ? Further, what is the value of the ratio now ?

Since WMAP observes Ordinary Matter at 4% NOW,
 the time when Ordinary Matter was 6% would be
 at redshift z such that
 $1 / (1+z)^3 = 0.04 / 0.06 = 2/3$, or $(1+z)^3 = 1.5$, or $1+z = 1.145$, or $z = 0.145$.
 To translate redshift into time,
 in billions of years before present, or Gy BP, use this chart

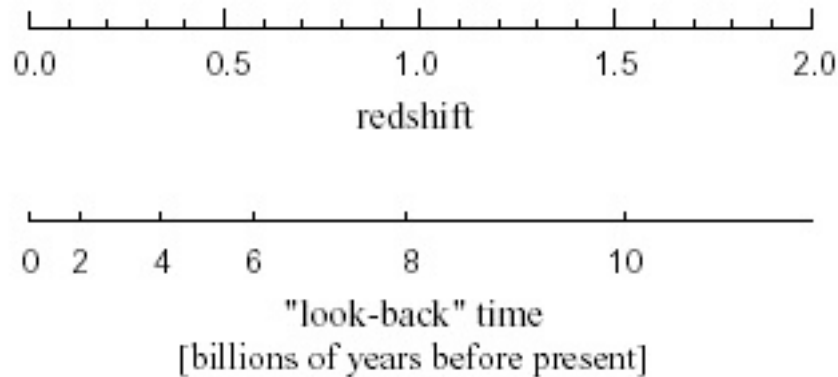

from a www.supernova.lbl.gov file SNAPoverview.pdf to see that
 the time when Ordinary Matter was 6%
 would have been a bit over 2 billion years ago, or 2 Gy BP.

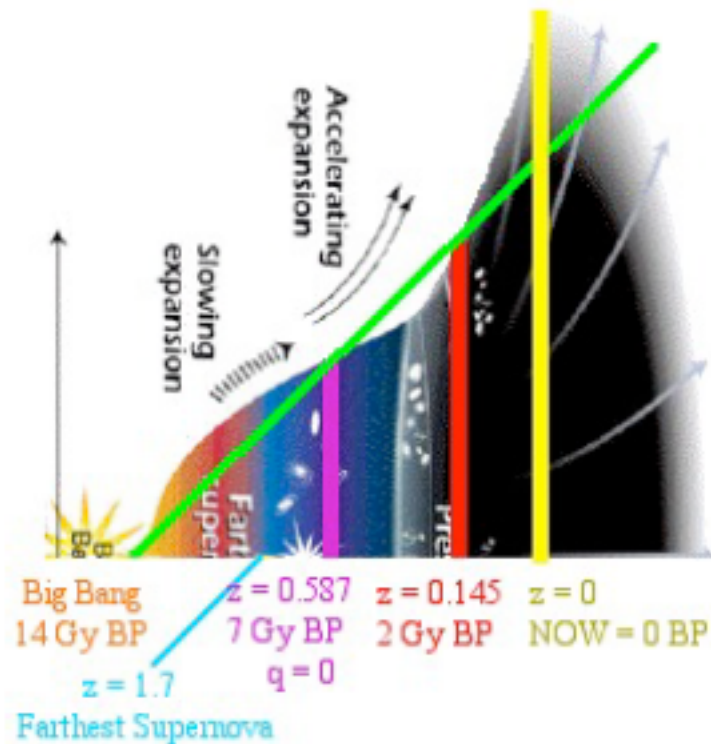

In the diagram, there are four Special Times in the history of our Universe:
the Big Bang Beginning of Inflation (about 13.7 Gy BP);

1 - the End of Inflation = Beginning of Decelerating Expansion
(beginning of green line also about 13.7 Gy BP);

2 - the End of Deceleration ($q=0$) = Inflection Point =
= Beginning of Accelerating Expansion
(purple vertical line at about $z = 0.587$ and about 7 Gy BP).

According to a hubblesite web page credited to Ann Feild, the above diagram "... reveals changes in the rate of expansion since the universe's birth 15 billion years ago. The more shallow the curve, the faster the rate of expansion. The curve changes noticeably about 7.5 billion years ago, when objects in the universe began flying apart as a faster rate. ...".

According to a CERN Courier web page: "... Saul Perlmutter, who is head of the Supernova Cosmology Project ... and his team have studied altogether some 80 high red-shift type Ia supernovae. Their results imply that the universe was decelerating for the first half of its existence, and then began accelerating approximately 7 billion years ago. ...".

According to astro-ph/0106051 by Michael S. Turner and Adam G. Riess: "... current supernova data ... favor deceleration at $z > 0.5$... SN 1997ff at $z = 1.7$ provides direct evidence for an early phase of slowing expansion if the dark energy is a cosmological constant ...".

3 - the Last Intersection of the Accelerating Expansion of our Universe of Linear Expansion (green line) with the Third Intersection (at red vertical line at $z = 0.145$ and about 2 Gy BP), which is also around the times of the beginning of the Proterozoic Era and Eukaryotic Life, Fe₂O₃ Hematite ferric iron Red Bed formations, a Snowball Earth, and the start of the Oklo fission reactor. 2 Gy is also about 10 Galactic Years for our Milky Way Galaxy and is on the order of the time for the process of a collision of galaxies.

4 - Now.

Those four Special Times define four Special Epochs:

The Inflation Epoch, beginning with the Big Bang and ending with the End of Inflation. The Inflation Epoch is described by Zizzi Quantum Inflation ending with Self-Decoherence of our Universe (see gr-qc/0007006).

The Decelerating Expansion Epoch, beginning with the Self-Decoherence of our Universe at the End of Inflation. During the Decelerating Expansion Epoch, the Radiation Era is succeeded by the Matter Era, and the Matter Components (Dark and Ordinary) remain more prominent than they would be under the "standard norm" conditions of Linear Expansion.

The Early Accelerating Expansion Epoch, beginning with the End of Deceleration and ending with the Last Intersection of Accelerating Expansion with Linear Expansion. During Accelerating Expansion, the prominence of Matter Components (Dark and Ordinary) declines, reaching the "standard norm" condition of Linear Expansion at the end of the Early Accelerating Expansion Epoch at the Last Intersection with the Line of Linear Expansion.

The Late Accelerating Expansion Epoch, beginning with the Last Intersection of Accelerating Expansion and continuing forever, with New Universe creation happening many times at Many Times. During the Late Accelerating Expansion Epoch, the Cosmological Constant Λ is more prominent than it would be under the "standard norm" conditions of Linear Expansion.

Now happens to be about 2 billion years into the Late Accelerating Expansion Epoch.

What about Dark Energy : Dark Matter : Ordinary Matter now ?

As to how the Dark Energy Λ and Cold Dark Matter terms have evolved during the past 2 Gy, a rough estimate analysis would be:

Λ and CDM would be effectively created during expansion in their natural ratio $67 : 27 = 2.48 = 5 / 2$, each having proportionate fraction $5 / 7$ and $2 / 7$, respectively; CDM Black Hole decay would be ignored; and pre-existing CDM Black Hole density would decline by the same $1 / R^3$ factor as Ordinary Matter, from 0.27 to $0.27 / 1.5 = 0.18$.

The Ordinary Matter excess $0.06 - 0.04 = 0.02$ plus the first-order CDM excess $0.27 - 0.18 = 0.09$ should be summed to get a total first-order excess of 0.11 , which in turn should be distributed to the Λ and CDM factors in their natural ratio $67 : 27$, producing, for NOW after 2 Gy of expansion:

CDM Black Hole factor = $0.18 + 0.11 \times 2/7 = 0.18 + 0.03 = 0.21$
for a total calculated Dark Energy : Dark Matter : Ordinary Matter ratio for now of

$$0.75 : 0.21 : 0.04$$

so that the present ratio of $0.73 : 0.23 : 0.04$ observed by WMAP seems to me to be substantially consistent with the cosmology of the E8 model.

2013 Planck Data (arxiv 1303.5062) showed "... anomalies ... previously observed in the WMAP data ... alignment between the quadrupole and octopole moments ... asymmetry of power between two ... hemispheres ... Cold Spot ... are now confirmed at ... 3 sigma ... but a higher level of confidence ...".

E8 model rough evolution calculation is: DE : DM : OM = 75 : 20 : 05

WMAP: DE : DM : OM = 73 : 23 : 04

Planck: DE : DM : OM = 69 : 26 : 05

basic unevolved E8 Conformal calculation: DE : DM : OM = 67 : 27 : 06

Since uncertainties are substantial, I think that there is reasonable consistency.

Conformal Gravity + Dark Energy and Pioneer Anomaly

After the Inflation Era and our Universe began its current phase of expansion, some regions of our Universe become Gravitationally Bound Domains (such as, for example, Galaxies) in which the 4 Conformal GraviPhoton generators are frozen out, forming domains within our Universe like IceBergs in an Ocean of Water. On the scale of our Earth-Sun Solar System, the region of our Earth, where we do our local experiments, is in a Gravitationally Bound Domain.

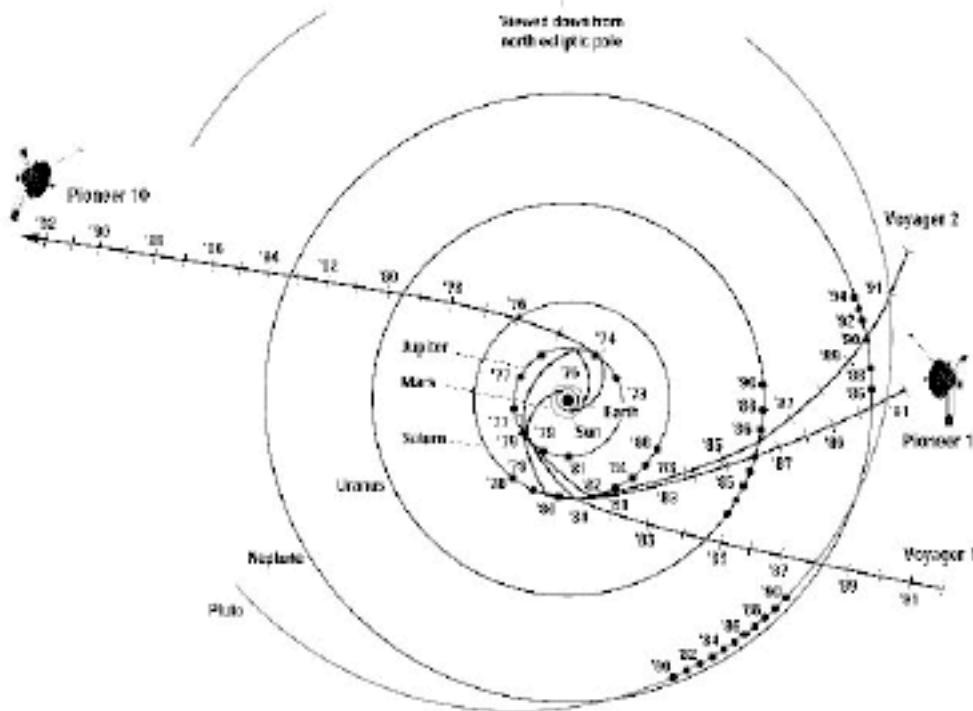

Pioneer spacecraft are not bound to our Solar System and are experiments beyond the Gravitationally Bound Domain of our Earth-Sun Solar System.

In their Study of the anomalous acceleration of Pioneer 10 and 11 gr-qc/0104064 John D. Anderson, Philip A. Laing, Eunice L. Lau, Anthony S. Liu, Michael Martin Nieto, and Slava G. Turyshev say: "... The latest successful precession maneuver to point ...[Pioneer 10]... to Earth was accomplished on 11 February 2000, when Pioneer 10 was at a distance from the Sun of 75 AU. [The distance from the Earth was [about] 76 AU with a corresponding round-trip light time of about 21 hour.] ... The next attempt at a maneuver, on 8 July 2000, was unsuccessful ... conditions will again be favorable for an attempt around July, 2001. ... At a now nearly constant velocity relative to the Sun of 12.24 km/s, Pioneer 10 will continue its motion into interstellar space, heading generally for the red star Aldebaran ... about 68 light years away ... it should take Pioneer 10 over 2 million years to reach its neighborhood....

[the above image is] Ecliptic pole view of Pioneer 10, Pioneer 11, and Voyager trajectories. Digital artwork by T. Esposito. NASA ARC Image # AC97-0036-3. ... on 1 October 1990 ... Pioneer 11 ... was [about] 30 AU away from the Sun ...

The last communication from Pioneer 11 was received in November 1995, when the spacecraft was at distance of [about] 40 AU from the Sun. ... Pioneer 11 should pass close to the nearest star in the constellation Aquila in about 4 million years ...

... Calculations of the motion of a spacecraft are made on the basis of the range time-delay and/or the Doppler shift in the signals. This type of data was used to determine the positions, the velocities, and the magnitudes of the orientation maneuvers for the Pioneer, Galileo, and Ulysses spacecraft considered in this study. ... The Pioneer spacecraft only have two- and three-way S-band Doppler. ... analyses of radio Doppler ... data ... indicated that an apparent anomalous acceleration is acting on Pioneer 10 and 11 ... The data implied an anomalous, constant acceleration with a magnitude $a_P = 8 \times 10^{-8}$ cm/cm/s², directed towards the Sun ...

... the size of the anomalous acceleration is of the order $c H$, where H is the Hubble constant ...

... Without using the apparent acceleration, CHASMP shows a steady frequency drift of about -6×10^{-9} Hz / s, or 1.5 Hz over 8 years (one-way only). ... This equates to a clock acceleration, $-a_t$, of -2.8×10^{-18} s / s². The identity with the apparent Pioneer acceleration is $a_P = a_t c$

... Having noted the relationships

$$a_P = c a_t$$

and that of ...

$$a_H = c H \rightarrow 8 \times 10^{-8} \text{ cm / s}^2$$

if $H = 82 \text{ km / s / Mpc}$...

we were motivated to try to think of any ... "time" distortions that might ... fit the CHASMP Pioneer results ... In other words ...

Is there any evidence that some kind of "time acceleration" is being seen?

... In particular we considered ... Quadratic Time Augmentation. This model adds a quadratic-in-time augmentation to the TAI-ET (International Atomic Time - Ephemeris Time) time transformation, as follows

$$ET \rightarrow ET + (1/2) a_{ET} ET^2$$

The model fits Doppler fairly well

...

There was one [other] model of the ...[time acceleration]... type that was especially fascinating. This model adds a quadratic in time term to the light time as seen by the DSN station:

$$\Delta TAI = TAI_{received} - TAI_{sent} \rightarrow$$

$$\rightarrow \Delta TAI + (1/2) a_{quad} (TAI_{received}^2 - TAI_{sent}^2)$$

It mimics a line of sight acceleration of the spacecraft, and could be thought of as an expanding space model.

Note that a_{quad} affects only the data. This is in contrast to the a_t ... that affects both the data and the trajectory. ... This model fit both Doppler and range very well. Pioneers 10 and 11 ... the numerical relationship between the Hubble constant and a_P ... remains an interesting conjecture. ...".

In his book "Mathematical Cosmology and Extragalactic Astronomy" (Academic Press 1976) (pages 61-62 and 72), Irving Ezra Segal says:

"... Temporal evolution in ... Minkowski space ... is

$$H \rightarrow H + s l$$

... unispace temporal evolution ... is ...

$$H \rightarrow (H + 2 \tan(a/2)) / (1 - (1/2) H \tan(a/2)) = H + a l + (1/4) a H^2 + O(s^2)$$

..."

Therefore,

the Pioneer Doppler anomalous acceleration is an experimental observation of a system that is not gravitationally bound in the Earth-Sun Solar System, and its results are consistent with Segal's Conformal Theory.

My view can be summarized as a 2-phase model based on Segal's work which has two phases with different metrics:

a metric for outside the inner solar system, a dark energy phase in which gravity is described in which all 15 generators of the conformal group are effective, some of which are related to the dark energy by which our universe expands;

and

a metric for where we are, in regions dominated by ordinary matter, in which the 4 special conformal and 1 dilation degrees of freedom of the conformal group are suppressed and the remaining 10 generators (antideSitter or Poincare, etc) are effective, thus describing ordinary matter phenomena.

Transition at Orbit of Uranus:

It may be that the observation of the Pioneer phase transition at Uranus from ordinary to anomalous acceleration is an experimental result that gives us a first look at dark energy / dark matter phenomena that could lead to energy sources that could be even more important than nuclear energy.

In gr-qc/0104064 Anderson et al say:

"... Beginning in 1980 ... at a distance of 20 astronomical units (AU) from the Sun ... we found that the largest systematic error in the acceleration residuals was a constant bias, a_P , directed toward the Sun. Such anomalous data have been continuously received ever since. ...",

so that the transition from inner solar system Minkowski acceleration to outer Segal Conformal acceleration occurs at about 20 AU, which is about the radius of the orbit of Uranus. That phase transition may account for the unique rotational axis of Uranus,

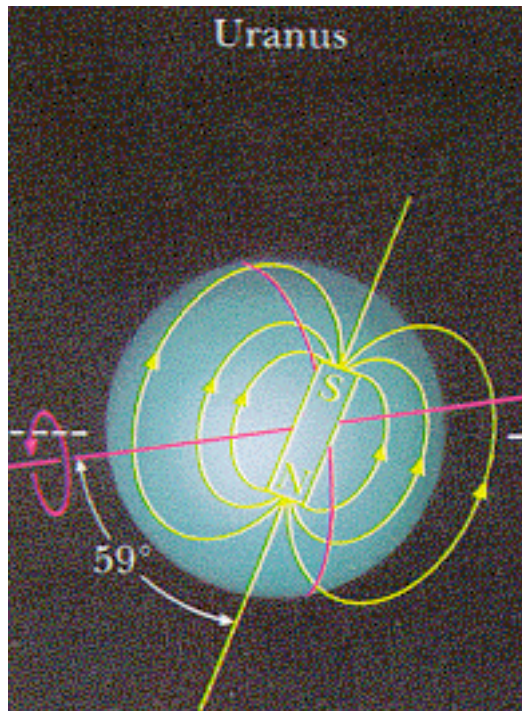

which lies almost in its orbital plane.

The most stable state of Uranus may be with its rotational axis pointed toward the Sun, so that the Solar hemisphere would be entirely in the inner solar system Minkowski acceleration phase and the anti-Solar hemisphere would be in entirely in the outer Segal Conformal acceleration phase.

Then the rotation of Uranus would not take any material from one phase to the other, and there would be no drag on the rotation due to material going from phase to phase.

Of course, as Uranus orbits the Sun, it will only be in that most stable configuration twice in each orbit, but an orbit in the ecliptic containing that most stable configuration twice (such as its present orbit) would be in the set of the most stable ground states, although such an effect would be very small now. However, such an effect may have been more significant on the large gas/dust cloud that was condensing into Uranus and therefore it may have caused Uranus to form initially with its rotational axis pointed toward the Sun.

In the pre-Uranus gas/dust cloud, any component of rotation that carried material from one phase to another would be suppressed by the drag of undergoing phase transition, so that, after Uranus condensed out of the gas/dust cloud, the only remaining component of Uranus rotation would be on an axis pointing close to the Sun, which is what we now observe.

In the pre-Uranus gas/dust cloud, any component of rotation that carried material from one phase to another would be suppressed by the drag of undergoing phase transition, so that, after Uranus condensed out of the gas/dust cloud, the only remaining component of Uranus rotation would be on an axis pointing close to the Sun, which is what we now observe.

Much of the perpendicular (to Uranus orbital plane) angular momentum from the original gas/dust cloud may have been transferred (via particles "bouncing" off the phase boundary) to the clouds forming Saturn (inside the phase boundary) or Neptune (outside the phase boundary), thus accounting for the substantial (relative to Jupiter) deviation of their rotation axes from exact perpendicularity (see images above and below from "Universe", 4th ed, by William Kaufmann, Freeman 1994).

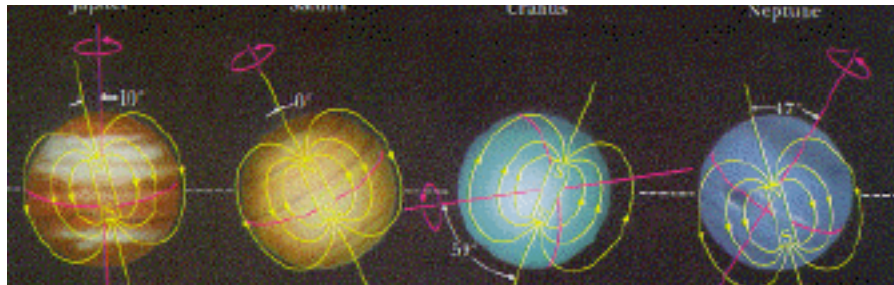

Conformal Gravity + Dark Energy and Warp Drive

Gabriele U. Variaschi and Zily Burstein in arXiv 1208.3706 showed that with Conformal Gravity Alcubierre Warp Drive does not need Exotic Matter.

In E8 Physics of viXra 1602.0319 Conformal Gravity gives Dark Energy which expands our Universe and can curve Spacetime.

Clovis Jacinto de Matos and Christian Beck in arXiv 0707.1797 said "... based on the model of dark energy a proposed by Beck and Mackey ... assume... that photons ... can exist in two different phases:

A gravitationally active phase where the zeropoint fluctuations contribute to the [dark energy] cosmological constant Λ ,

and a gravitationally inactive phase where they do not contribute to Λ .

... this type of model of dark energy can lead to measurable effects in superconductors, via ... interaction with the Cooper pairs in the superconductor. ...

the transition between the two graviphoton's phases ... occurs at the critical temperature T_c of the superconductor, which defines a cutoff frequency of opoint fluctuations ...

Graviphotons can form weakly bounded states with Cooper pairs ...

[which] ... form a condensate ...[in]... superconduct[ors] ...

the cosmological cutoff frequency [could be measured] through the measurement of the spectral density of the noise current in resistively shunted Josephson Junctions ...".

Xiao Hu and Shi-Zeng Lin in arXiv 0911.5371 and 1206.516 showed that BSCCO superconducting crystals are natural Josephson Junctions.

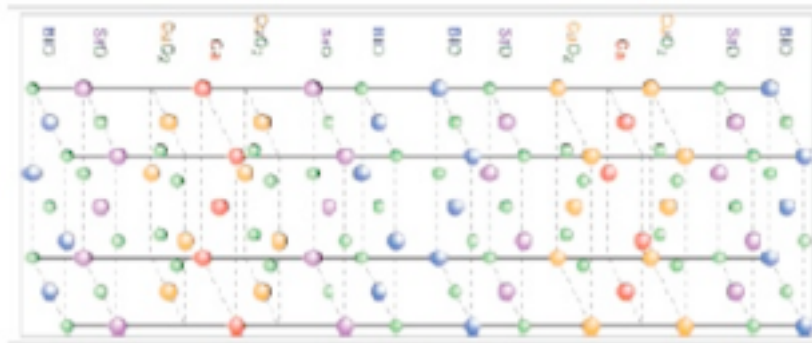

(BSCCO image from Wikipedia)

A Pentagonal Dipyramid configuration of 16 BSCCO crystals cannot close in flat 3-dim space, but can close if Conformal Dark Energy accumulated in the BSCCO Josephson Junctions curves spacetime. Such spacetime curvature allows construction of a Conformal Gravity Alcubierre Warp Drive that does not need Exotic Matter.

"... If you spend any time playing with Geomag models, you are sure to stumble upon the structure ...

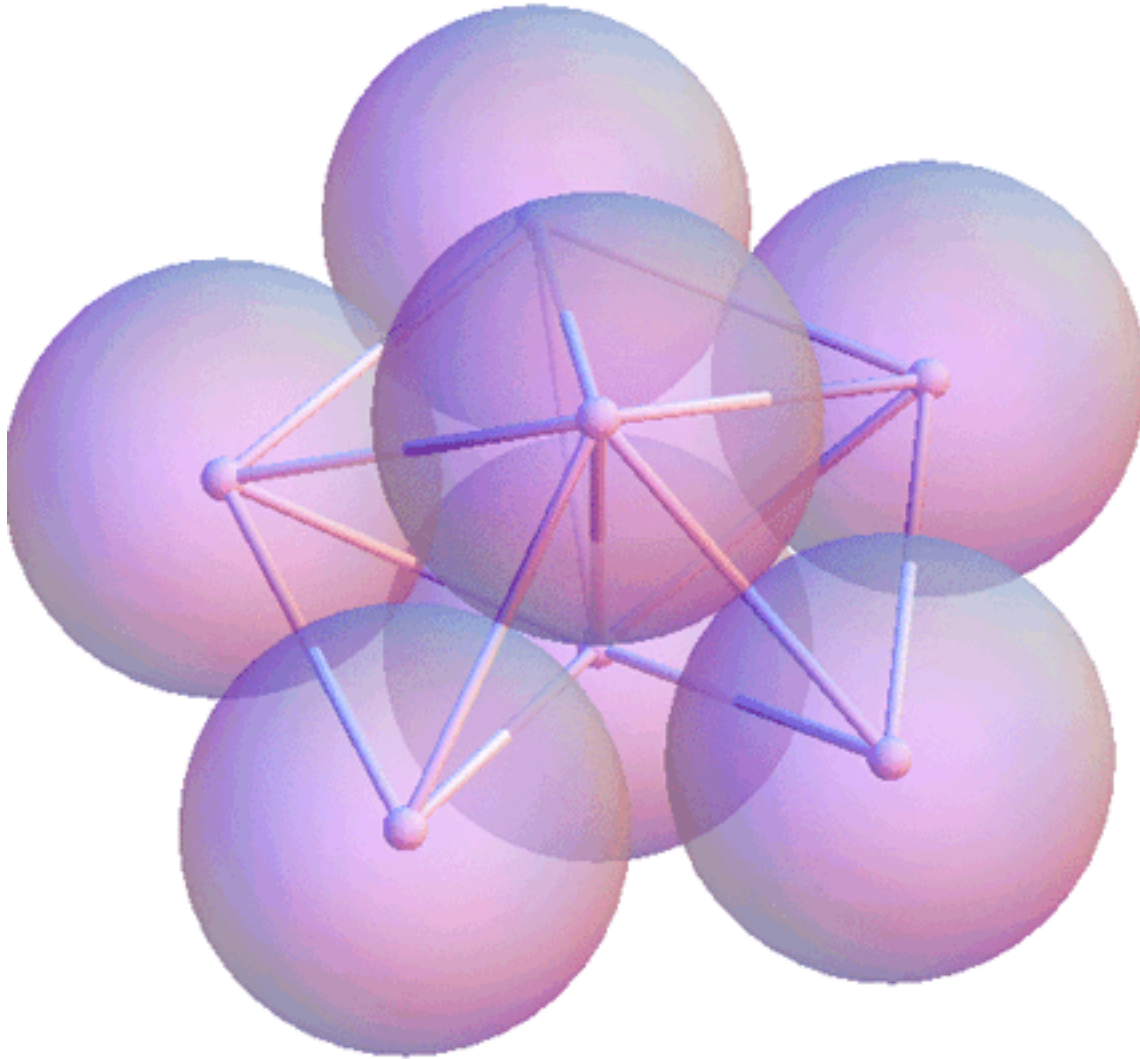

... which consists of four tetrahedra joined along faces. It looks as if you might be able to add one more bond to close the gap, creating a solid of five joined tetrahedra. But it doesn't work. The gap is slightly too wide. ..." (bit-player.org/2012/dancing-with-the-spheres)

To close the 7.36 degree gap,
you can contract space in the tetrahedron containing the gap,
keep unchanged the space in the other 4 tetrahedra, and
expand space just outside the structure and opposite to the gap tetrahedron.

In these images (from simplydifferently.org/Present/Data/Johnson_Solid/13.jpg)

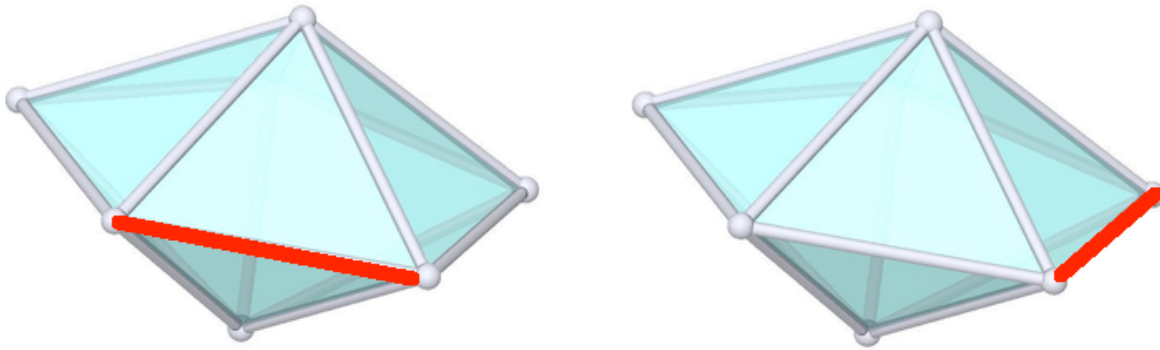

the red edge designates two of the choices of which tetrahedron contains the gap and
and
in this image (from Wikipedia on Alcubierre drive)

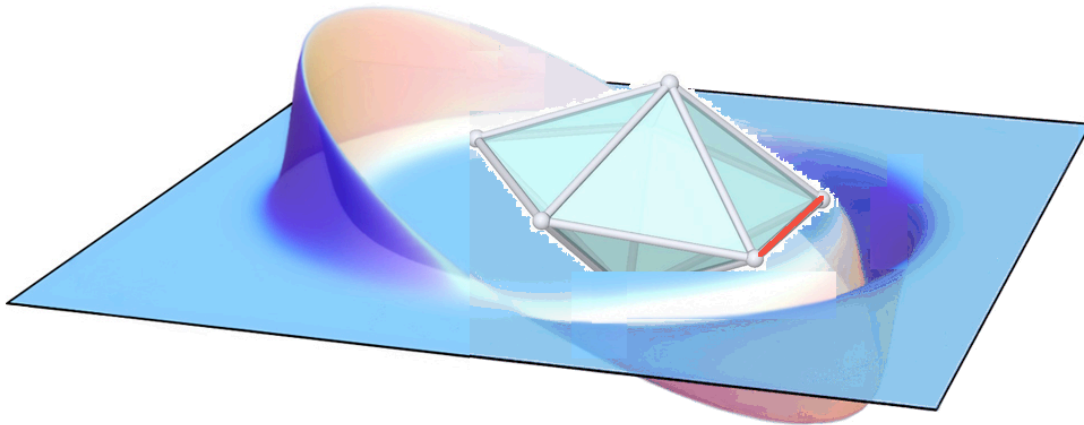

the structure is shown with space contracting in front of the gap tetrahedron
and expanding behind the structure.

“... Alcubierre drive (Wikipedia) ... Rather than exceeding the speed of light within a local reference frame, **a spacecraft would traverse distances by contracting space in front of it and expanding space behind it,** resulting in effective faster-than-light travel ... the Alcubierre drive shifts space around an object so that the object would arrive at its destination faster than light would in normal space ...”.

The Alcubierre Warp Drive (by John G. Cramer, Alternate View Column AV-81)

“... General relativity does not forbid faster-than-light [FTL] travel or communication, but it does require that the local restrictions of special relativity must apply ... One example of this is a wormhole connecting two widely separated locations in space ... by transiting the wormhole the object has traveled ...[at]... an effective speed of ...[many]... times the velocity of light.

Another example of FTL in general relativity is the expansion of the universe itself. As the universe expands, new space is being created between any two separated objects. The objects may be at rest with respect to their local environment and with respect to the cosmic microwave background, but the distance between them may grow at a rate greater than the velocity of light. According to the standard model of cosmology, parts of the universe are receding from us at FTL speeds, and therefore are completely isolated from us

...

Alcubierre has proposed a way of beating the FTL speed limit that is somewhat like the expansion of the universe, but on a more local scale. He has developed a "metric" for general relativity ... that describes a region of flat space surrounded by a "warp" that propels it forward at any arbitrary velocity, including FTL speeds. Alcubierre's warp is constructed of hyperbolic tangent functions which create a very peculiar distortion of space at the edges of the flat-space volume. In effect, new space is rapidly being created ... at the back side of the moving volume, and existing space is being annihilated ... at the front side of the moving volume.

Thus,

a space ship within the volume of the Alcubierre warp (and the volume itself) would be pushed forward by the expansion of space at its rear and the contraction of space in front.

Here's a figure from Alcubierre's paper showing the curvature of space ...

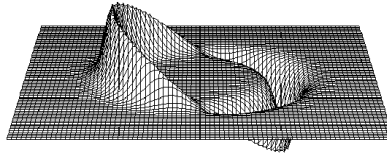

... Since a ship at the center of the moving volume of the metric is at rest with respect to locally flat space, there are no relativistic mass increase or time dilation effects. The on-board spaceship clock runs at the same speed as the clock of an external observer, and that observer will detect no increase in the mass of the moving ship, even when it travels at FTL speeds. Moreover, Alcubierre has shown that even when the ship is accelerating, it travels on a free-fall geodesic. In other words, a ship using the warp to accelerate and decelerate is always in free fall, and the crew would experience no accelerational gee-forces. Enormous tidal forces would be present near the edges of the flat-space volume because of the large space curvature there, but by suitable specification of the metric, these would be made very small within the volume occupied by the ship ...”.

(image below from George Dvorsky in Daily Explainer 11/26/12 at io9.gizmodo.com)

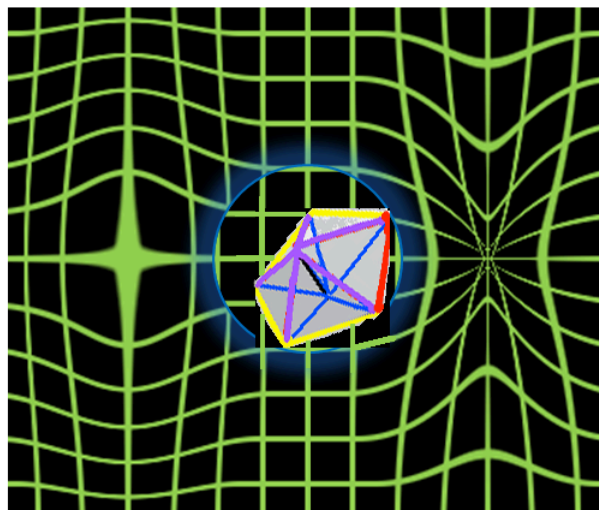

Kepler Polyhedra and Planets

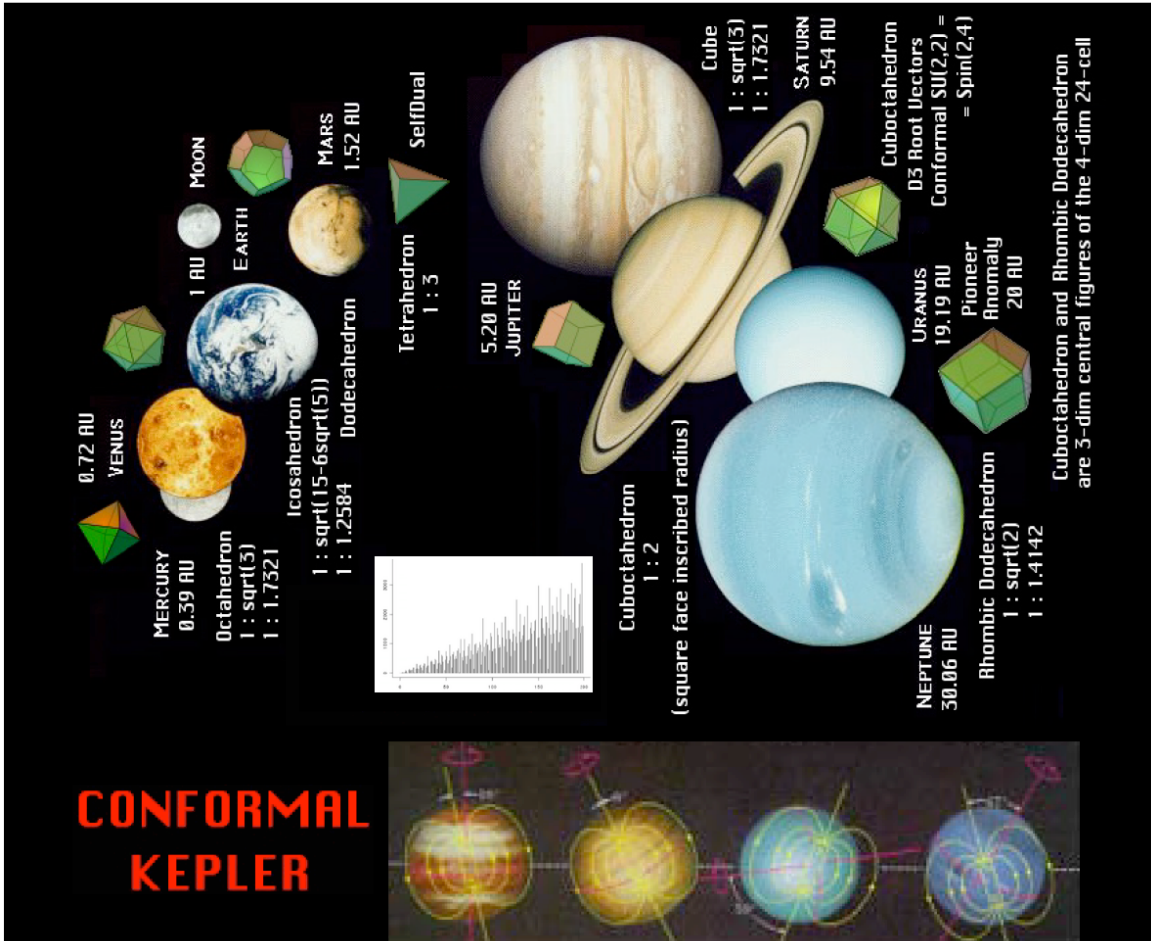

(images other than 24-cell are from, or adapted from, Wikipedia and Wolfram MathWorld)

Mercury = Outer Sun-Sphere = **Inner Octahedron**

Octahedron = 6 space Axes

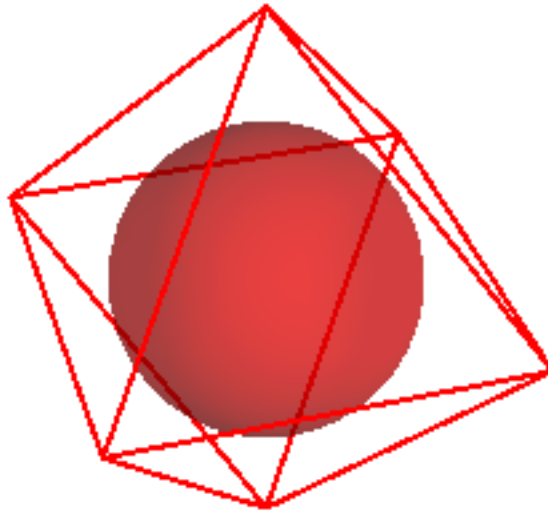

Venus / Mercury = 0.72 / 0.39 = 1.85

$$\text{Octahedron Outer / Inner} = \sqrt{3} / 1 = \frac{a}{2} \sqrt{2} \approx 0.707 \cdot a \quad / \quad \frac{a}{6} \sqrt{6} \approx 0.408 \cdot a = 1.732$$

Venus = **Outer Octahedron** = Inner Icosahedron

Icosahedron = 12 Golden Edge-Points of Octahedron

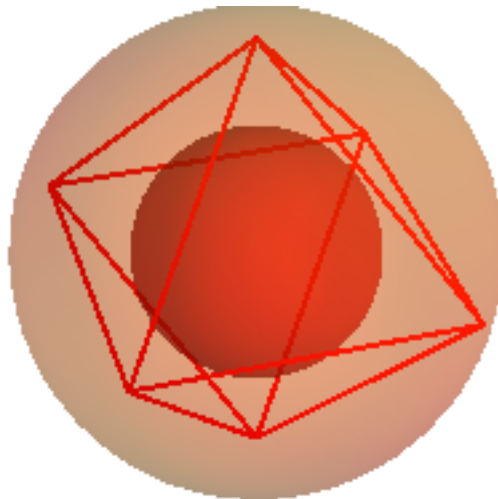

$$\text{Earth / Venus} = 1 / 0.72 = 1.39$$

$$\text{Icosahedron Outer / Inner} = \frac{a}{2} \sqrt{\phi\sqrt{5}} = \frac{a}{4} \sqrt{10 + 2\sqrt{5}} = a \sin \frac{2\pi}{5} \approx 0.9510565163 \cdot a \quad \Bigg/ \quad \frac{\phi^2 a}{2\sqrt{3}} = \frac{\sqrt{3}}{12} (3 + \sqrt{5}) a \approx 0.7557613141 \cdot a \approx 1.26$$

Earth = **Outer Icosahedron** = Inner Dodecahedron

Icosahedron = 2 Octahedral embeddings = Earth + Moon

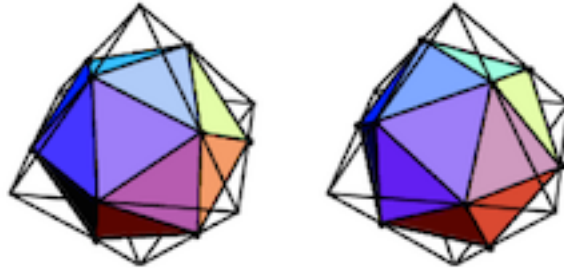

Dodecahedron = Dual Icosahedron

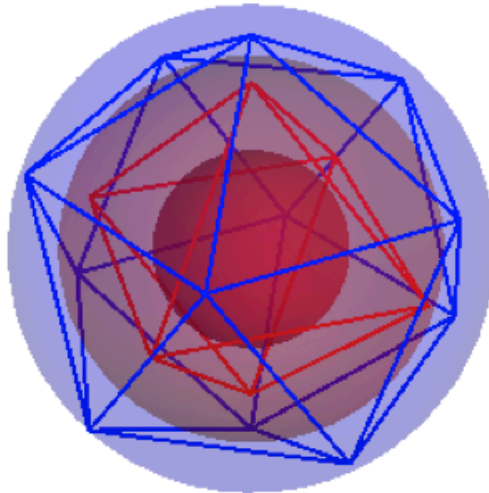

Mars / Earth = 1.52 / 1 = 1.52

$$\text{Dodecahedron Outer / Inner} = \frac{\sqrt{3}}{4} (1 + \sqrt{5}) \approx 1.401\,258\,538 \quad / \quad \frac{1}{2} \sqrt{\frac{5}{2} + \frac{11}{10} \sqrt{5}} \approx 1.113\,516\,364 \approx 1.26$$

Since Earth+Moon has 2 Outer Icosahedra, use $1.26 \times 1.26 = 1.59$

Mars = **Outer Dodecahedron** = Inner Tetrahedron

Tetrahedron = 4 / 20 of Dodecahedron Vertices

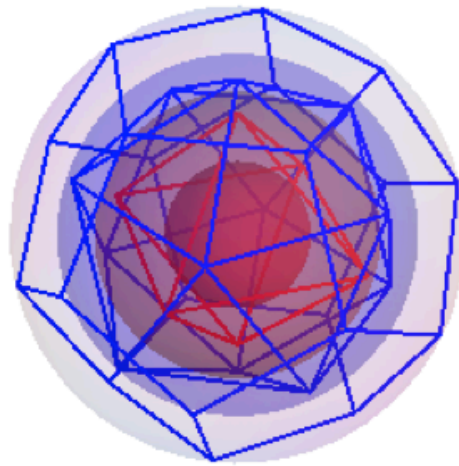

Tetrahedron = self-dual => stellated octahedron => unstable = Asteroids

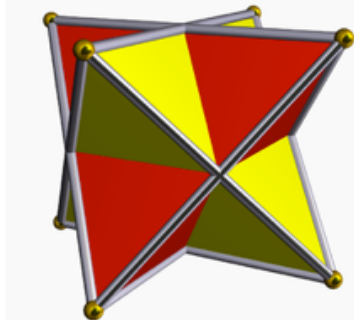

$$\text{Jupiter / Mars} = 5.2 / 1.52 = 3.42$$

$$\text{Tetrahedron Outer / Inner} = \sqrt{\frac{3}{8}} a \bigg/ \frac{a}{\sqrt{24}} = 3$$

Jupiter = **Outer Tetrahedron** = Inner Cube

Cube = 2 Tetrahedron Vertices = Dual Octahedron

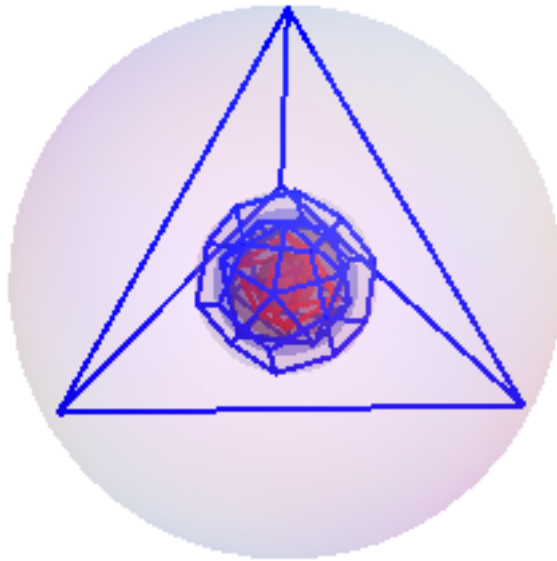

$$\text{Saturn / Jupiter} = 9.54 / 5.20 = 1.83$$

$$\text{Cube Outer / Inner} = \frac{\sqrt{3}}{2}a \bigg/ \frac{a}{2} = \sqrt{3} = 1.732$$

Saturn = **Outer Cube** = Inner CubOctahedron

Cuboctahedron = Truncated Cube

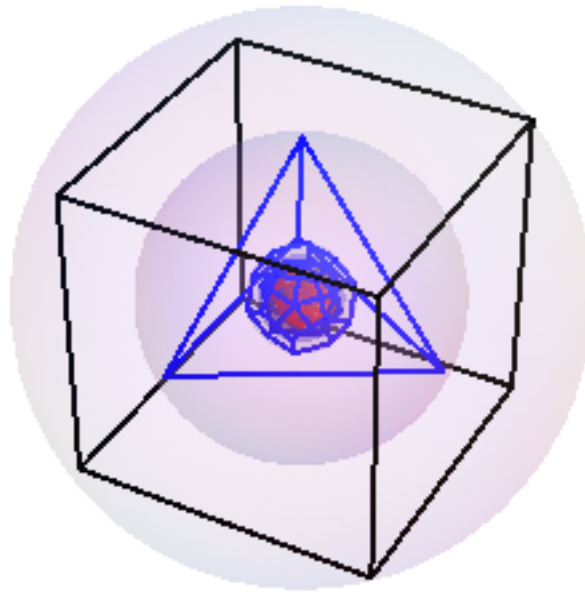

Poincare Gravity Space = Tiled by Cube

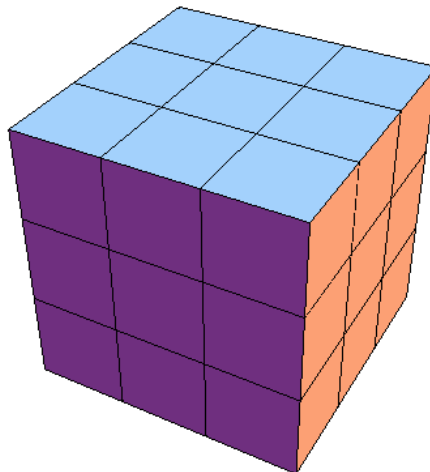

Uranus / Saturn = 19.19 / 9.54 = 2.01

$$\text{CubOctahedron Outer (dilated by Basic Cube Edge / CubOcta Edge) / Inner (square face)} = \sqrt{2} / \frac{1}{2} \sqrt{2} = 2$$

Uranus = **Outer CubOctahedron** = Inner Rhombic Dodecahedron

Rhombic Dodecahedron = Dual Cuboctahedron

Cuboctahedron containing Cube of centers of Triangle Faces and

Cuboctahedron within Basic Cube prior to Truncation

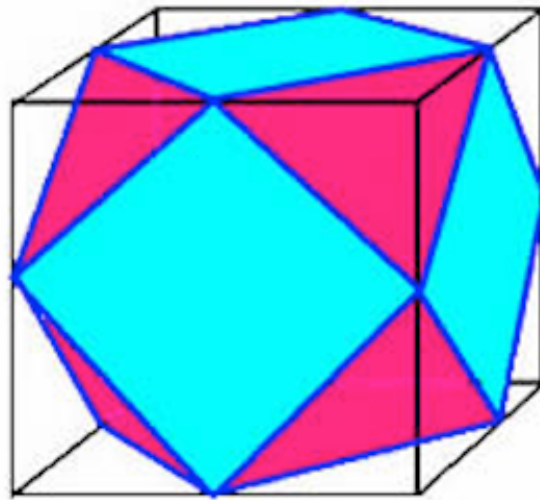
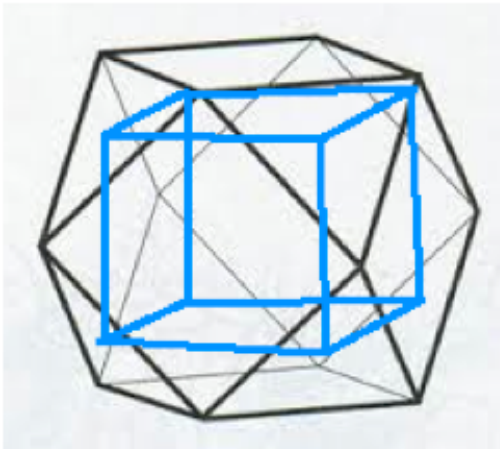

Uranus Orbit = Boundary of Pioneer Conformal Gravity Dark Energy

Cuboctahedron = Buckminster Fuller Vector Equilibrium = Center of 4-dim 24-cell

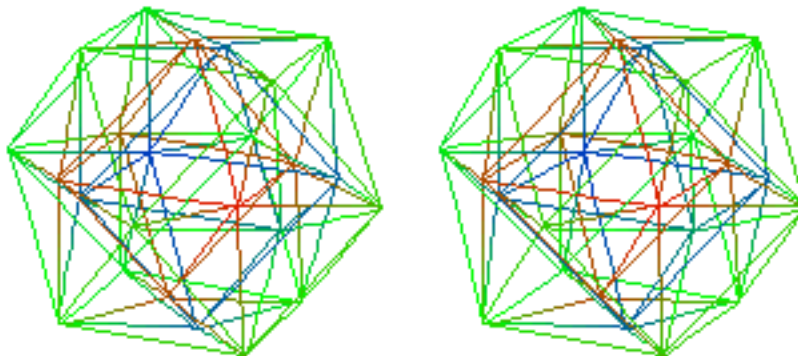

Neptune / Uranus= 30.06 / 19.19 = 1.57

$$\text{Rhombic Dodecahedron Outer / Inner} = \frac{2\sqrt{3}}{3}a \approx 1.154700538a \quad / \quad \frac{\sqrt{6}}{3}a \approx 0.8164965809a = \sqrt{2} = 1.414$$

Neptune = **Outer Rhombic Dodecahedron** = Inner Conformal Gravity Space

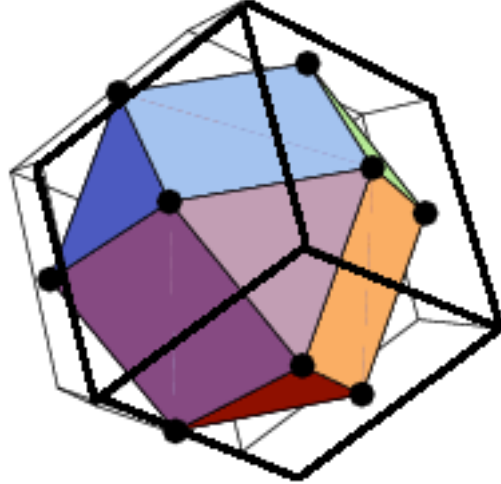

Rhombic Dodecahedron = Center of 4-dim 24-cell

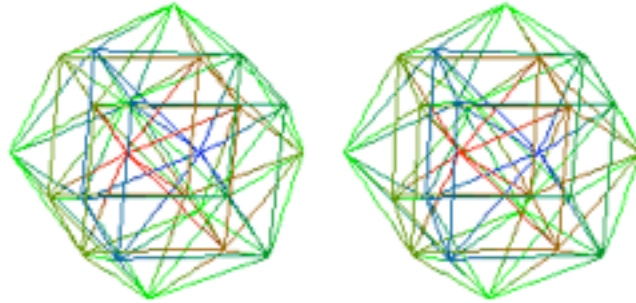

Conformal Gravity Space = Tiled by Rhombic Dodecahedra

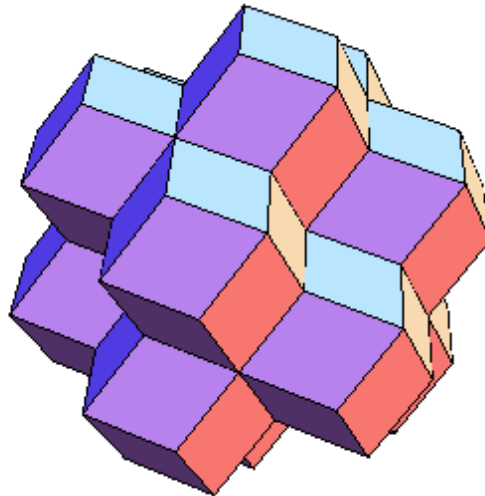

Nambu-Jona-Lasinio Higgs-Tquark 3-state System

In my CI(1,25) E8 physics model (viXra 1602.0319)
the Higgs is not seen as a single fundamental scalar particle,
but rather
the Higgs is seen as a fermionic condensate
and part of a 3-state Higgs-Tquark System:

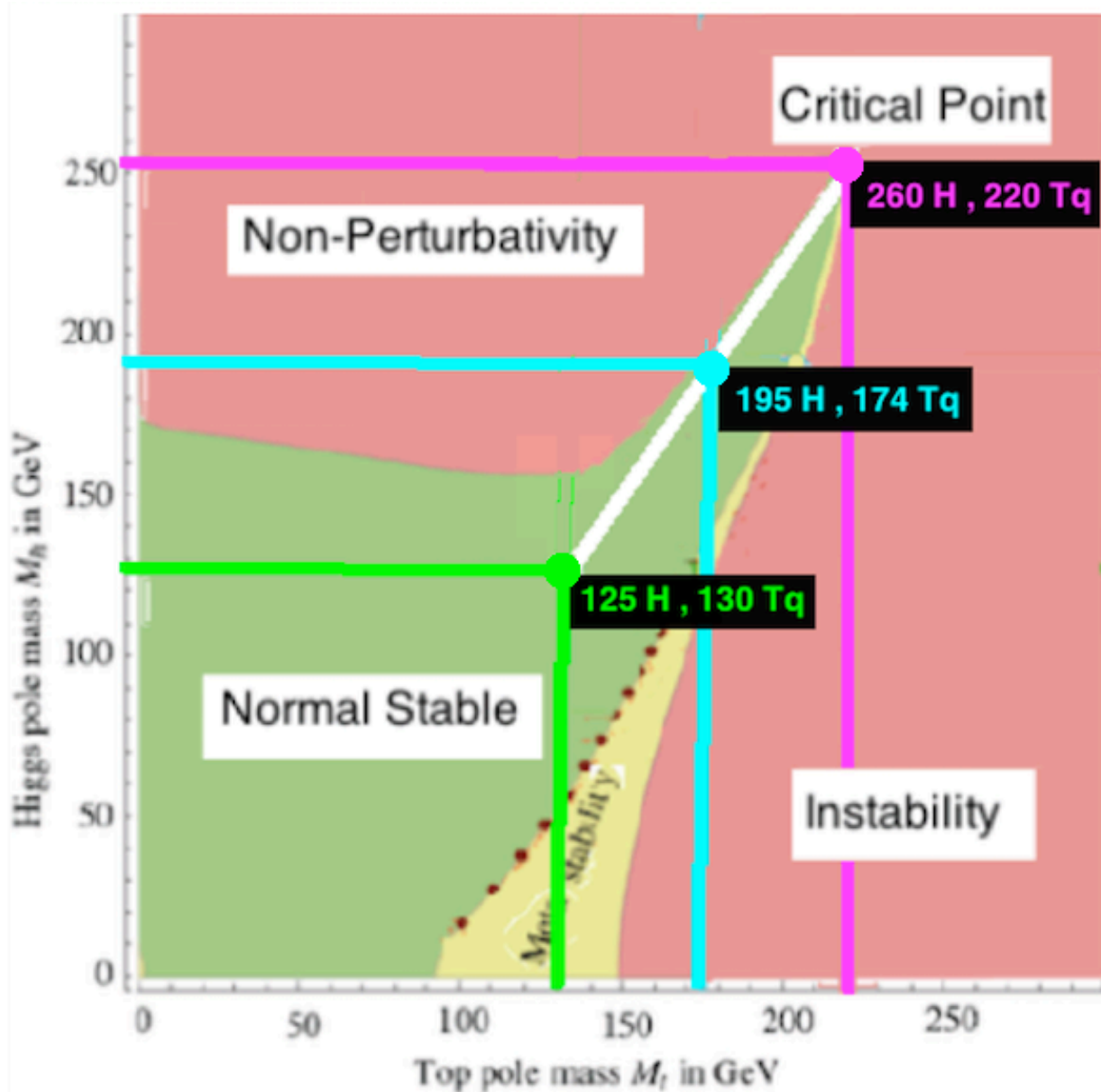

Fermilab and LHC Experiments from 1994 to 2016 have indicated the existence of the 3 Mass States of the Higgs-Tquark Nambu-Jona-Lasinio type System.

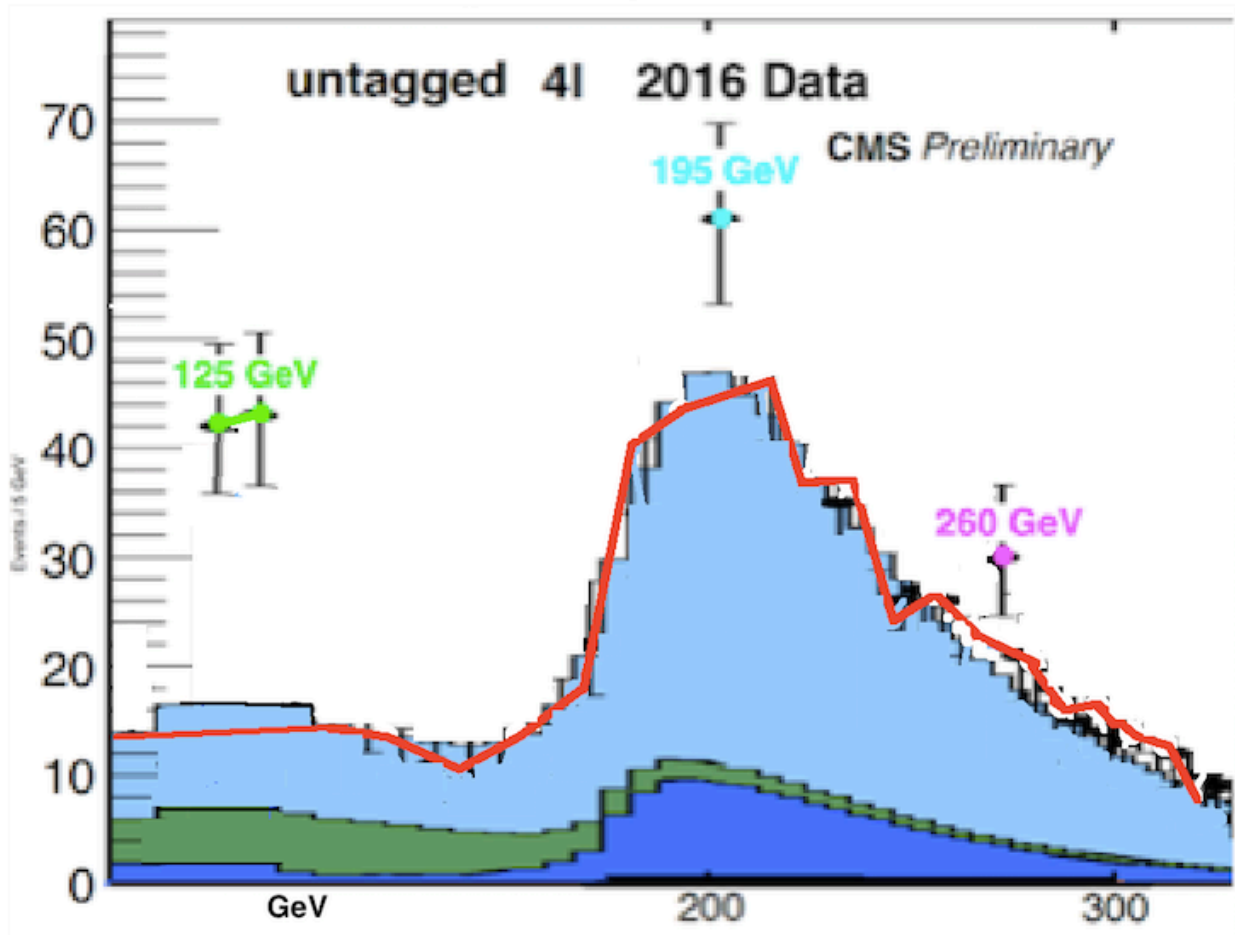
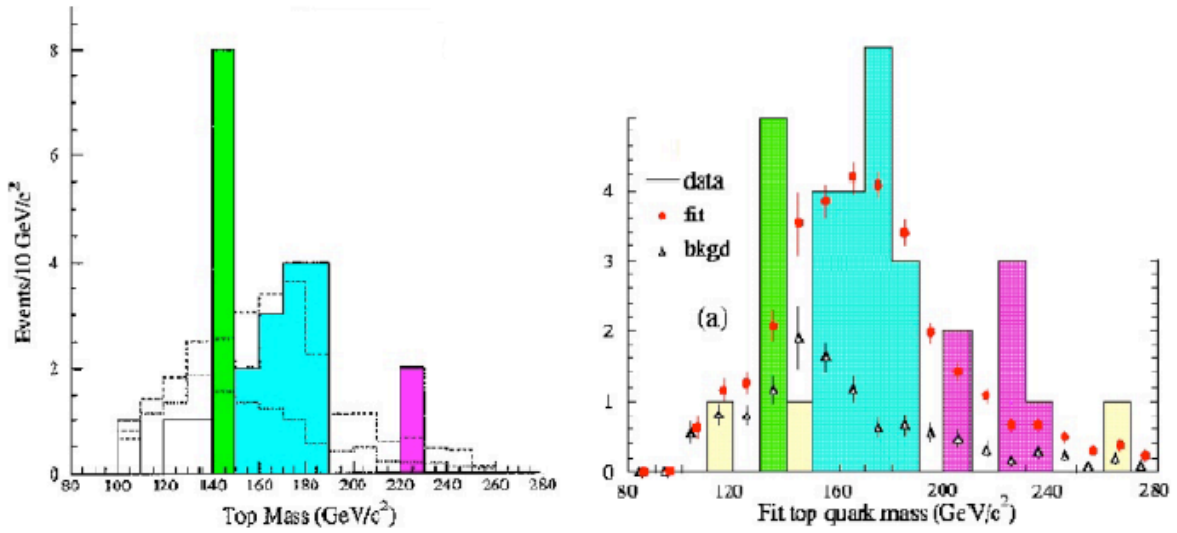

(for details see Appendix on History of Truth Quark and Higgs Observations)

The Green Dot  where the White Line originates in our Normal Stable Region is **the low-mass state of a 130 GeV Truth Quark and a 125 GeV Higgs.**

The Cyan Dot  where the White Line hits the Triviality Boundary leaving the Ordinary Phase is **the middle-mass state of a 174 GeV Truth Quark and Higgs around 200 GeV.** It corresponds to the Higgs mass calculated by Hashimoto, Tanabashi, and Yamawaki in hep-ph/0311165 where they say:

"... We perform **the most attractive channel (MAC)** analysis in the top mode standard model with TeV-scale extra dimensions, where the standard model gauge bosons and the third generation of quarks and leptons are put in $D(=6,8,10,\dots)$ dimensions. In such a model, bulk gauge couplings rapidly grow in the ultraviolet region. In order to make the scenario viable, only the attractive force of the top condensate should exceed the critical coupling, while other channels such as the bottom and tau condensates should not. We then find that **the top condensate can be the MAC for $D=8$** ... We predict masses of the top (m_t) and the Higgs (m_H) ... based on the renormalization group for the top Yukawa and Higgs quartic couplings with the compositeness conditions at the scale where the bulk top condenses ... **for ... [Kaluza-Klein type]... dimension... $D=8$... $m_t = 172-175$ GeV and $m_H=176-188$ GeV ...**".

As to **composite Higgs and the Triviality boundary**, Pierre Ramond says in his book Journeys Beyond the Standard Model (Perseus Books 1999) at pages 175-176: "... The Higgs quartic coupling has a complicated scale dependence. It evolves according to $d\lambda/dt = (1/16\pi^2)\beta_\lambda$ where the one loop contribution is given by $\beta_\lambda = 12\lambda^2 - \dots - 4H$... The value of λ at low energies is related [to] the physical value of the Higgs mass according to the tree level formula $m_H = v\sqrt{2\lambda}$ while the vacuum value is determined by the Fermi constant ... for a fixed vacuum value v , let us assume that the Higgs mass and therefore λ is large. In that case, β_λ is dominated by the λ^2 term, which drives the coupling towards its Landau pole at higher energies. Hence the higher the Higgs mass, the higher λ is and the closer [r] the Landau pole to experimentally accessible regions. This means that **for a given (large) Higgs mass, we expect the standard model to enter a strong coupling regime at relatively low energies**, losing in the process our ability to calculate. This does not necessarily mean that the theory is incomplete, only that we can no longer handle it ... it is natural to think that this effect is caused by new strong interactions, and that the **Higgs actually is a composite** ... The resulting bound on λ is sometimes called **the triviality bound**. The reason for this unfortunate name (the theory is anything but trivial) stems from lattice studies where the coupling is assumed to be finite everywhere; in that case the coupling is driven to zero, yielding in fact a trivial theory. In the standard model λ is certainly not zero. ...".

Middle Mass State Cross Section:

In the CI(1,25) E8 model the D = 8 Kaluza-Klein is M4 x CP2
 and the Middle-Mass Higgs structure is not restricted to Effective M4 Spacetime
 as is the case with the Low-Mass Higgs Ground State
 but extends to the full 4+4 = 8-dim structure of M4 x CP2 Kaluza-Klein.

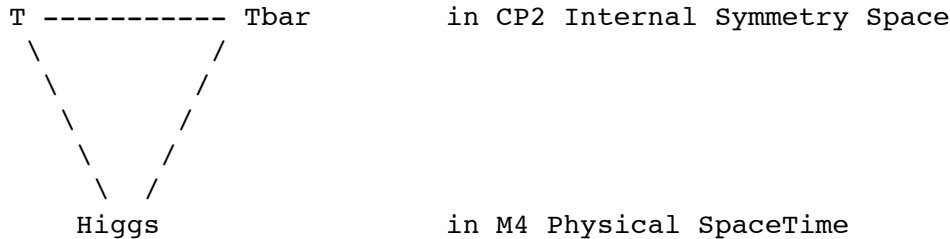

Therefore the Mid-Mass Higgs looks like a 3-particle system of Higgs + T + Tbar.

The T and Tbar form a Pion-like state.
 Since Tquark Mid-Mass State is 174 GeV
 the Middle-Mass T-Tbar that lives in the CP2 part of (4+4)-dim Kaluza-Klein
 has mass $(174+174) \times (135 / (312+312)) = 75$ GeV.

The Higgs that lives in the M4 part of (4+4)-dim Kaluza-Klein
 has, by itself, its Low-Mass Ground State Effective Mass of 125 GeV.
 So, the total Mid-Mass Higgs lives in full 8-dim Kaluza-Klein
 with mass $75+125 = 200$ GeV.

This is consistent with the Mid-Mass States of the Higgs and Tquark
 being on the Triviality Boundary of the Higgs - Tquark System
 and with the 8-dim Kaluza-Klein model in hep-ph/0311165 by Hashimoto, Tanabashi,
 and Yamawaki. As to the cross-section of the Middle-Mass Higgs

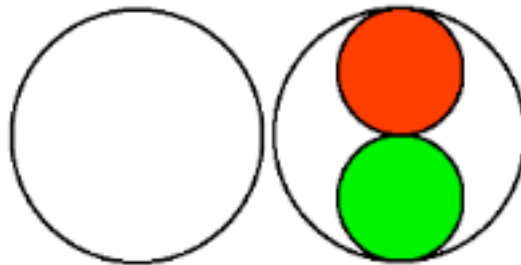

consider that the entire Ground State cross-section lives only in 4-dim M4 spacetime
 (left white circle)
 while the Middle-Mass Higgs cross-section lives in full 4+4 = 8-dim Kaluza-Klein
 (right circle with red area only in CP2 ISS and white area partly in CP2 ISS
 with only green area effectively living in 4-dim M4 spacetime)
 so that
 our 4-dim M4 Physical Spacetime experiments only see for the Middle-Mass Higgs
 a cross-section that is 25% of the full Ground State cross-section.

The Magenta Dot  at the end of the White Line is **the high-mass state of a 220 GeV Truth Quark and a 240 GeV Higgs.**

It is at the Critical Point of the Higgs-TruthQuark System with respect to Vacuum Instability and Triviality.

It corresponds to the description in hep-ph/9603293 by Koichi Yamawaki:

"... **the top quark condensate proposed by Miransky, Tanabashi and Yamawaki (MTY) and by Nambu independently** ... entirely replaces the standard Higgs doublet by a composite one formed by a strongly coupled short range dynamics (four-fermion interaction) which triggers the top quark condensate. **The Higgs boson emerges as a tbar-t bound state and hence is deeply connected with the top quark itself.** ... **the BHL [Bardeen-Hill-Lindner] formulation of the top quark condensate ... is based on the RG equation combined with the compositeness condition** ... [it] start[s] with the SM Lagrangian ... BHL is crucially based on the perturbative picture ... [which]... breaks down at high energy near the compositeness scale Λ ... [10^{19} GeV]... there must be a certain matching scale $\Lambda_{\text{Matching}}$ such that the perturbative picture (BHL) is valid for $\mu < \Lambda_{\text{Matching}}$, while only the nonperturbative picture (MTY) becomes consistent for $\mu > \Lambda_{\text{Matching}}$...

However, thanks to the presence of a quasi-infrared fixed point, BHL prediction is numerically quite stable against ambiguity at high energy region ...

Then we expect $m_t = m_t(\text{BHL}) = \dots = 1/(\sqrt{2}) y_{\text{bart}} v$ within 1-2%, where y_{bart} is the quasi-infrared fixed point given by $\text{Beta}(y_{\text{bart}}) = 0$ in ... the one-loop RG equation ...

The composite Higgs loop changes y_{bart}^2 by roughly the factor $N_c/(N_c + 3/2) = 2/3$ compared with the MTY value, i.e., $250 \text{ GeV} \rightarrow 250 \times \sqrt{2/3} = 204 \text{ GeV}$, while the electroweak gauge boson loop with opposite sign pulls it back a little bit to a higher value. **The BHL value is then given by $m_t = 218 \pm 3 \text{ GeV}$, at $\Lambda = 10^{19} \text{ GeV}$.**

The Higgs boson was predicted as a tbar-t bound state with a ... mass ... calculated by BHL through the full RG equation ...

the result being ... $M_H / m_t = 1.1$ at $\Lambda = 10^{19} \text{ GeV}$...".

Therefore $M_H = 1.1 \times 218 = 240 \text{ GeV}$ which is roughly the Higgs VEV.

High Mass State Cross Section:

As with the Middle-Mass Higgs,

the High-Mass Higgs lives in all $4+4 = 8$ Kaluza-Klein $M_4 \times CP_2$ dimensions so its cross-section is also about 25% of the Higgs Ground State cross-section.

The 25% may also be visualized in terms of 8-dim coordinates $\{1, i, j, k, E, I, J, K\}$ in which $\{1, i, j, k\}$ represent M_4 and $\{E, I, J, K\}$ represent CP_2 .

	1	i	j	k	E	I	J	K
1	11	12	13	14	15	16	17	18
i	21	22	23	24	25	26	27	28
j	31	32	33	34	35	36	37	38
k	41	42	43	44	45	46	47	48
E	51	52	53	54	55	56	57	58
I	61	62	63	64	65	66	67	68
J	71	72	73	74	75	76	77	78
K	81	82	83	84	85	86	87	88

E8 Physics Calculation Results

Here is a summary of E8 Physics model calculation results. Since ratios are calculated, values for one particle mass and one force strength are assumed. Quark masses are constituent masses. Most of the calculations are tree-level, so more detailed calculations might be even closer to observations.

Dark Energy : Dark Matter : Ordinary Matter = 0.75 : 0.21 : 0.04

Fermions as Schwinger Sources have geometry of Complex Bounded Domains with Kerr-Newman Black Hole structure size about $10^{(-24)}$ cm.

Particle/Force	Tree-Level	Higher-Order
e-neutrino	0	0 for nu_1
mu-neutrino	0	$9 \times 10^{(-3)}$ eV for nu_2
tau-neutrino	0	$5.4 \times 10^{(-2)}$ eV for nu_3
electron	0.5110 MeV	
down quark	312.8 MeV	charged pion = 139 MeV
up quark	312.8 MeV	proton = 938.25 MeV
		neutron - proton = 1.1 MeV
muon	104.8 MeV	106.2 MeV
strange quark	625 MeV	
charm quark	2090 MeV	
tauon	1.88 GeV	
beauty quark	5.63 GeV	
truth quark (low state)	130 GeV	(middle state) 174 GeV (high state) 218 GeV
W+	80.326 GeV	
W-	80.326 GeV	
W0	98.379 GeV	Z0 = 91.862 GeV
Mplanck	1.217×10^{19} GeV	
Higgs VEV (assumed)	252.5 GeV	
Higgs (low state)	126 GeV	(middle state) 182 GeV (high state) 239 GeV
Gravity Gg (assumed)	1	
(Gg)(Mproton ² / Mplanck ²)		$5 \times 10^{(-39)}$
EM fine structure	1/137.03608	
Weak Gw	0.2535	
Gw(Mproton ² / (Mw+ ² + Mw- ² + Mz0 ²))		$1.05 \times 10^{(-5)}$
Color Force at 0.245 GeV	0.6286	0.106 at 91 GeV

Kobayashi-Maskawa parameters for W+ and W- processes are:

	d	s	b
u	0.975	0.222	0.00249 -0.00388i
c	-0.222 -0.000161i	0.974 -0.0000365i	0.0423
t	0.00698 -0.00378i	-0.0418 -0.00086i	0.999

The phase angle d13 is taken to be 1 radian.

Massless Realm Beyond EW Symmetry Breaking

At Temperature / Energy above $3 \times 10^{15} \text{ K} = 300 \text{ GeV}$:
 the Higgs mechanism is not in effect so there is full ElectroWeak Symmetry
 and no particles have any mass from the Higgs.

Questions arise:

- 1 - Can we build a collider that will explore the Massless Phase ?
- 2 - How did our Universe evolve in that early Massless Phase
 of its first $10^{(-11)}$ seconds or so ?
- 3 - What do physical phenomena look like in the Massless Phase ?

1 - Can we build a collider that will explore the Massless Phase ?

Yes: In hep-ex00050008 Bruce King has a chart and he gives a cost estimate of

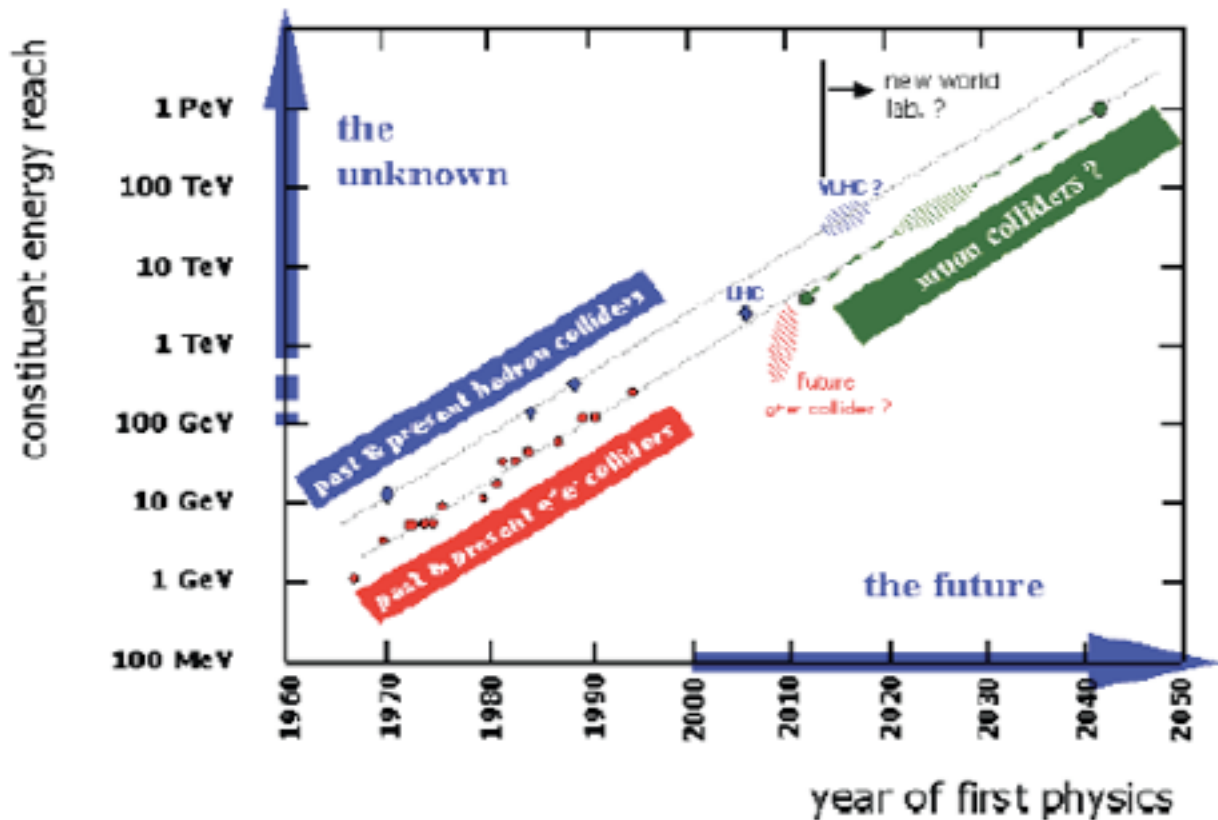

about \$12 billion for a 1000 TeV (1 PeV) Linear Muon Collider with tunnel length about 1000 km. Marc Sher has noted that by now (late 2012 / early 2013) the cost estimate of \$12 billion should be doubled or more. My view is that a cost of \$100 billion is easily affordable by the USA as it is far less than the Trillions given annually since 2008 by the USA Fed/Treasury to Big Banks as Quantitative Easing to support their Derivatives Casino. Science will advance AND non-Bankster people will get paying jobs.

2 - How did our Universe evolve in that early Massless Phase of its first $10^{(-11)}$ seconds or so ?

In the context of E8 Physics our Universe began as a Quantum Fluctuation from a Parent Universe whereby our Universe initially had Planck Scale Temperature / Energy 10^{32} K = 1.22×10^{19} GeV.

Its physics was then described by a Lagrangian with:

Gauge Boson term of 28-dimensional adjoint Spin(8) that eventually produces the 12-dim $SU(3) \times SU(2) \times U(1)$ Standard Model along with 16-dim $U(2,2)$ Conformal Gravity Ghosts.

Fermion term of 8-dimensional half-spinor Spin(8) corresponding to first-generation fermion particles and antiparticles (electron, RGB Up quarks; neutrino, RGB down quarks);

Base Manifold of 8-dimensional Octonionic Spacetime.

With respect to 8-dimensional Spacetime the dimensionality of the Gauge Boson term is $28 \times 1 = 28$ and the dimensionality of the Fermion term is $8 \times 7/2 = 28$ (see Weinberg's 1986 Dirac Memorial Lecture at page 88 and note that $7/2 + 7/2 + 1 = 8$) so the E8 Physics Lagrangian is clearly Ultraviolet Finite at the Planck Scale due to Triality-based cancellations, an effective Subtle Supersymmetry.

Since the lower energy forms of E8 Physics are derived from the Planck Scale Lagrangian, they also benefit from the cancellations.

As Our Universe began to cool down below the Planck Scale Inflationary Expansion started due to Octonionic Quantum Non-Unitarity (see Adler's book "Quaternionic Quantum Mechanics ..." at pages 50-52 and 561).

Paola Zizzi describes the Octonionic Inflationary Era in terms of Clifford Algebras in gr-qc/0007006 and related papers. In short, the 64 doublings of Zizzi Inflation produce about 10^{77} fermion particles.

At the End of Inflation Our Universe had Temperature / Energy 10^{27} K = 10^{14} GeV

A consequence of the end of Octonionic Inflation was the freezing out of a preferred Quaternionic Subspace so that 8-dim Octonionic Spacetime was converted into (4+4)-dim Kaluza-Klein spacetime $M_4 \times CP^2$

where M_4 is Minkowski Physical 4-dim spacetime and $CP^2 = SU(3) / SU(2) \times U(1)$ is a Batakis 4-dim Internal Symmetry Space.

The geometry of that splitting of spacetime produces a Higgs mechanism. (see Meinhard Mayer and A. Trautman in "A Brief Introduction to the Geometry of Gauge Fields" and "The Geometry of Symmetry Breaking in Gauge Theories", Acta Physica Austriaca, Suppl. XXIII (1981))

Since each of the 10^{77} fermions had energy of 10^{14} GeV collisions among them would for each of the 10^{77} fermions produce jets containing about 10^{12} particles of energy 100 GeV or so so that the total number of such particles is about 10^{89} .

According to Weinberg's book "Cosmology":
"... above 10^{13} K, nucleons would not yet have formed from their three constituent quarks, and there would have been roughly as many quark-antiquark pairs in thermal equilibrium as photons ... before annihilation there must have been a slight excess ... of quarks over antiquarks, so that some quarks would survive to form nucleons when all the antiquarks had annihilated with quarks. There was also a slight excess of electrons over positrons, to maintain charge neutrality of the universe ...".

Therefore,
in the interval between the End of Inflation and ElectroWeak Symmetry Breaking most of the quarks in 10^{89} fermions formed quark-antiquark pairs that produced as a condensate the Higgs that is needed for Mayer-Higgs. The quark-antiquark condensate Higgs then Breaks ElectroWeak Symmetry at Temperature / Energy 3×10^{15} K = 300 GeV and gives mass to particles and at age 10^{-11} seconds ends the Massless Phase of the history of Our Universe.

3 - What do physical phenomena look like in the Massless Phase ?

The Weak Force Strength is $0.2535 \times (1 / MW^2) = 1.05 \times 10^{-5}$ where MW is a Weak Boson Mass factor that goes away in the Massless Realm where the Weak Force becomes a strong 0.25345.

As to Kobayashi-Maskawa Weak Force mixing in the Massless Realm, Kea (Marni Sheppard) proposed that in the Massless Realm the mixing matrix might be democratic which to me means that in the Massless Realm you might say that there is just a democratic mixing matrix of the form $1/3 \times$

$$\begin{pmatrix} 1 & 1 & 1 \\ 1 & 1 & 1 \\ 1 & 1 & 1 \end{pmatrix}$$

with no complex terms and no CP violation in the Massless Realm.

With no mass terms, the structure of particle interactions would be based on the Wave Picture instead of the Particle Picture.

Instead of a particle with mass moving slower than light the picture is a massless particle moving at light speed with its energy defined by its frequency.

In that picture, for example:

a Muon is distinguishable from an electron by higher frequency due to 2-fold 4+4 path of second generation fermions instead of simple 4 path of first generation fermions.

Quark wave paths have $S7 \times RP1$ structure whose greater complexity produces higher frequency than Lepton wave paths.

Bound structures (Hadrons, Mesons, Nuclei, Atoms, etc) are based on standing wave frequencies instead of masses of particles, nuclei, etc.

Appendix - E8 Physics and 256 Cellular Automata

The 256 Elementary Cellular Automata correspond to the 256-dim $Cl(8)$ Clifford Algebra with graded structure 1 8 28 56 (35+35=70) 56 28 8 1

The 8 Vectors have clear physical interpretation as 8-dim Spacetime.

The 28 BiVectors have clear physical interpretation as Gauge Bosons of

Standard Model and Gravity + Dark Energy

The 1 scalar, 1 pseudoscalar, and 7+7=14 of grade 4 have physical interpretation

as 8 +half-spinors and 8 -half-spinors

The 8+28+8+8 = 52 with fixed physical interpretation form 52-dim F_4 .

The remaining 256 - 8 - 28 - 8 - 8 = 204 $Cl(8)$ Cellular Automata are not bound to any physical interpretation but are available to carry information.

28

8+28+16 = 52 F4

256-dim Cl(8) as Cellular Automata

16

Cl(8) Primitive Idempotent has 16 Terms

$1 = (1/2)(1 + e_1 + e_2 + e_3 + e_4 + e_5 + e_6 + e_7 + e_8) (1/2)(1 + e_1 + e_2 + e_3 + e_4) (1/2)(1 + e_1 + e_2 + e_3) (1/2)(1 + e_1 + e_2) (1/2)(1 + e_1) (1/2)(1 + e_1)$

$= (1/16)(1 + e_1 + e_2 + e_3 + e_4 + e_5 + e_6 + e_7 + e_8 + e_1e_2 + e_1e_3 + e_1e_4 + e_1e_5 + e_1e_6 + e_1e_7 + e_1e_8 + e_2e_3 + e_2e_4 + e_2e_5 + e_2e_6 + e_2e_7 + e_2e_8 + e_3e_4 + e_3e_5 + e_3e_6 + e_3e_7 + e_3e_8 + e_4e_5 + e_4e_6 + e_4e_7 + e_4e_8 + e_5e_6 + e_5e_7 + e_5e_8 + e_6e_7 + e_6e_8 + e_7e_8 + e_1e_2e_3 + e_1e_2e_4 + e_1e_2e_5 + e_1e_2e_6 + e_1e_2e_7 + e_1e_2e_8 + e_1e_3e_4 + e_1e_3e_5 + e_1e_3e_6 + e_1e_3e_7 + e_1e_3e_8 + e_1e_4e_5 + e_1e_4e_6 + e_1e_4e_7 + e_1e_4e_8 + e_1e_5e_6 + e_1e_5e_7 + e_1e_5e_8 + e_1e_6e_7 + e_1e_6e_8 + e_1e_7e_8 + e_2e_3e_4 + e_2e_3e_5 + e_2e_3e_6 + e_2e_3e_7 + e_2e_3e_8 + e_2e_4e_5 + e_2e_4e_6 + e_2e_4e_7 + e_2e_4e_8 + e_2e_5e_6 + e_2e_5e_7 + e_2e_5e_8 + e_2e_6e_7 + e_2e_6e_8 + e_2e_7e_8 + e_3e_4e_5 + e_3e_4e_6 + e_3e_4e_7 + e_3e_4e_8 + e_3e_5e_6 + e_3e_5e_7 + e_3e_5e_8 + e_3e_6e_7 + e_3e_6e_8 + e_3e_7e_8 + e_4e_5e_6 + e_4e_5e_7 + e_4e_5e_8 + e_4e_6e_7 + e_4e_6e_8 + e_4e_7e_8 + e_5e_6e_7 + e_5e_6e_8 + e_5e_7e_8 + e_6e_7e_8)$

corresponding to 16 of the 256 Cellular Automata

Tensor Product Cl(8) x Cl(8) = Cl(16)

$(F_4 \text{ in } Cl(8)) \times (F_4 \text{ in } Cl(8)) =$
 $= 8 \times 8 + 28 \times 1 + 1 \times 28 + 1 \times 1 =$
 $= 120 Cl(16) \text{ BiVectors} + (128 + 128) Cl(16) \text{ Spinors}$
 $120 Cl(16) \text{ BiVectors} + 128 Cl(16) \text{ Half-Spinors} = E_8$

Cl(8) Triality

8

1

Grade 0

Grade 1

Grade 2

Grade 3

Grade 4

Grade 5

Grade 6

Grade 7

Grade 8

Guillermo Moreno (arXiv math/0512517) has shown that $V(7,2) = Spin(7) / Spin(6)$ can be identified with the Zero Divisors of Sedentons which have 7x28 = 196 Associative Triples and for which Zero Divisors are given by the fibration $V(7,2) \rightarrow C_2 \rightarrow S_3$ (3-sphere) and which have 4x28 2D Inducible Components and 100-dim Lie Sphere $Spin(7) / Spin(6)$ whose 100 correspond to $Cl(1,9) = Cl(8,8)$ Conformal over $Cl(1,7)$ that $V(16,2) = Spin(16) / Spin(15)$ is related to, but not identified with, the Zero Divisors of 3D-ons which have 35 + 120 = 155 Associative Triples and which have 8x48 2D Inducible Components and 26-dim Lie Sphere $Spin(16) / Spin(15)$ whose 260 correspond to 260 Spring Theory and to 26-dim traceless $A_0(O)$ that $V(17,2) = Spin(17) / Spin(16)$ is related to, but not identified with, the Zero Divisors of Voids 256-ons corresponding to $C(8)$ which have 1+6+28+120+496+2016+8128+10785 Associative Triples and which have 64+248 2D Inducible Components and 250-dim Lie Sphere $Spin(17) / Spin(16)$ (xU1)

Robert de Marrais said "256 ... 2^8 ions Voudons ... Moreno ... determines that the automorphism group of the ZD's of all 2^n ions ... obey a simple pattern. For $n \geq 4$ this group has the form $C_2 \times (n-3) \times S_3$ (order 6 permutation group on 3 elements). This says the automorphism group of the Sedentons' ZD's has order $14 \times 1 \times 6 = 84$... based on 7 octahedral lattices ('Box Kites') ...

... Harmonics of Box Kites, called here "Kite-Chain Middens," ... extend indefinitely into higher forms of 2^n ions. All non-Middens collected 2D diagonals in the ... 32-ons ... belong ... to a set of 15 'emanation tables.' ... they house 168 ... PSL(2,7) ... cells ... 8 ... 32-ons ... ET's ... from 5 - 8 to 15 ...

(there are) ... Emanation Tables ... ET's for S = 15, N = 5,6,7 ... and fractal limit ...

When $Cl(16)$ is formed from the tensor product $Cl(8) \times Cl(8)$ the two F_4 in $Cl(8)$ go to $1 \times 28 + 8 \times 8 + 28 \times 1 = 120$ D8 BiVectors and $(8+8) \times (8+8) = 256$ D8 Spinors all of which inherit clear physical interpretations leaving $65,536 - 120 - 256 = 65,160$ $Cl(16)$ elements available to carry information either in Lorentz Leech Lattice Spacetime Cells of Our Conscious Universe or in 40-micron Microtubules of Human Quantum Consciousness.

All of the 120 D8 BiVectors and 128 = half of the D8 Spinors form 248-dim E_8 which has fixed physical interpretation inherited from the F_4 in $Cl(8)$ so 248-dim E_8 and the other 128 half-Spinors are fixed structure markers in $Cl(16)$ that do not carry information.

Raymond Aschheim (email May 2015) said:

“... An elementary CA is defined by the next value (either 0 or 1) for a cell, depending on its ... value, and the ... value of it[s] left and of it[s] right neighbor cell (it is one dimensional, and involve only the first neighbors, and the cell itself) ... So the next value depends [on] 3 bits ... eight possible combination of three bits, and for each ... combination... the next value is either zero or one. So the[re] are 256 ... CAs ...”.

Since due to Real Clifford 8-periodicity any Real Clifford Algebra $Cl(8N)$ can be seen as the tensor product of N copies of $Cl(8)$, any Real Clifford Algebra has fundamental structure of $Cl(8) = Cl(1,7) = 16 \times 16$ real matrix algebra so Cellular Automata correspondence with $Cl(8)$ means that any Real Clifford Algebra can be described by Cellular Automata. Therefore Clifford Algebra E_8 physics can also be seen in terms of Cellular Automata.

Each initial state for a CA rule for 1-dim nearest neighbor automata is a triple $***$ in which each of the 3 * (left, middle, right) can be either 0 or 1. Each CA rule gives one of 2 outcomes 0 or 1 for each of the 8 states

```
1 1 1   0 1 1   0 0 1   0 0 0
      1 0 1   0 1 0
      1 1 0   1 0 0
```

so there are $2^8 = 256$ possible CA rules.

The 8 states correspond to the 8 vectors of the Clifford Algebra $Cl(8)$

The CA rule that gives 0 for all 8 states corresponds to the 1 scalar 0-vector of $Cl(8)$

There are 8 CA rules that give 1 for one of the 8 states and 0 for the other 7 and they correspond to the 8 vectors of $Cl(8)$

There are 28 CA rules that give 1 for 2 of the 8 states and 0 for the other 6 and they correspond to the 28 bivectors of $Cl(8)$

There are 56 CA rules that give 1 for 3 of the 8 states and 0 for the other 5 and they correspond to the 56 3-vectors of $Cl(8)$

There are 70 CA rules that give 1 for 4 of the 8 states and 0 for the other 4 and they correspond to the 70 4-vectors of $Cl(8)$

There are 56 CA rules that give 1 for 5 of the 8 states and 0 for the other 3 and they correspond to the 56 5-vectors of $Cl(8)$

There are 28 CA rules that give 1 for 6 of the 8 states and 0 for the other 2 and they correspond to the 28 6-vectors of $Cl(8)$

There are 8 CA rules that give 1 for 7 of the 8 states and 0 for the other 1 and they correspond to the 8 7-vectors of $Cl(8)$

There is 1 CA rule that gives 1 for all 8 states and it corresponds to the 1 pseudo-scalar 8-vector of $Cl(8)$

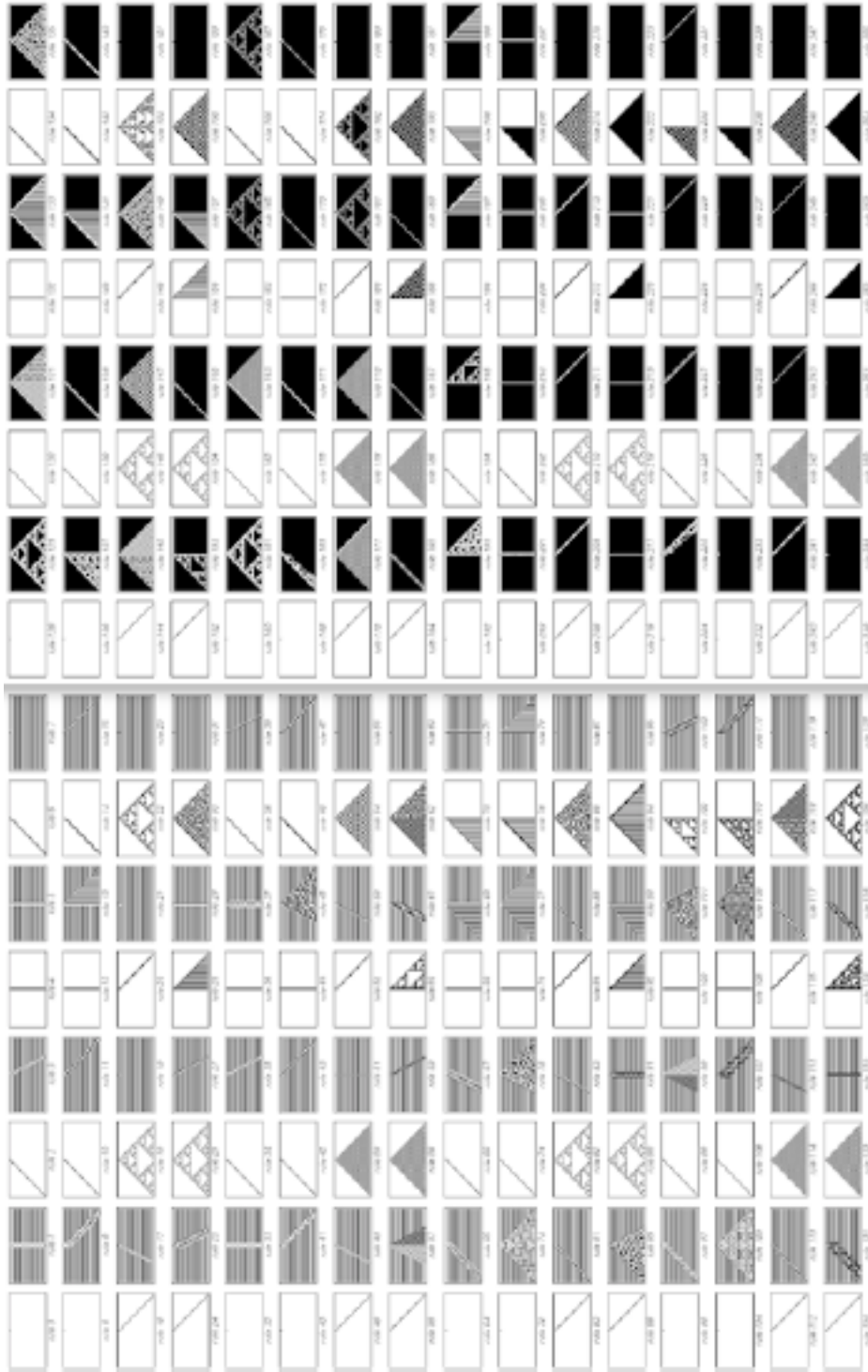

256 Cellular Automata
1 8 28 56 70 56 28 8 1

(images from "A New Kind of Science" by Stephen Wolfram (Wolfram 2002))

Grade: 0

1

7

8



rule 0

00000000



rule 1

00000001



rule 2

00000010

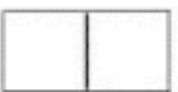

rule 4

00000100

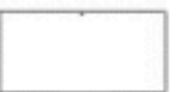

rule 8

00001000



rule 16

00010000

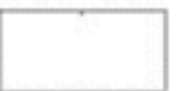

rule 32

00100000



rule 64

01000000



rule 128

10000000



rule 254

11111110



rule 255

11111111



rule 253

11111101



rule 251

11111011



rule 247

11110111



rule 239

11101111



rule 223

11011111



rule 191

10111111



rule 127

01111111

Grade:

2

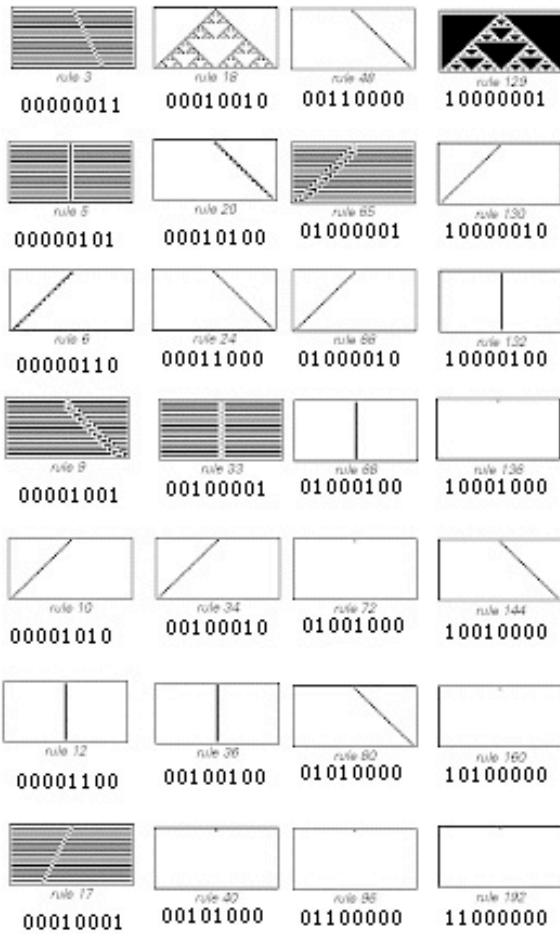

6

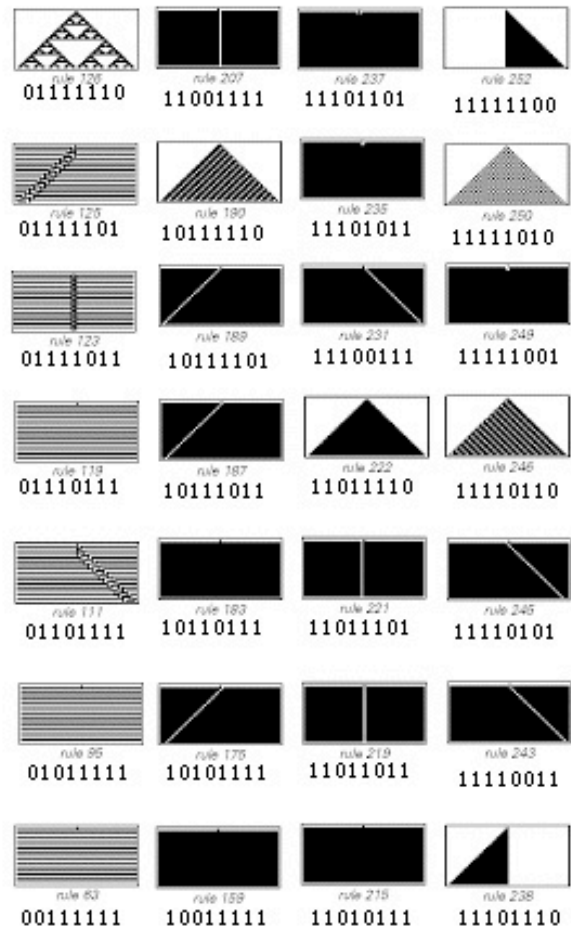

Grade:

3

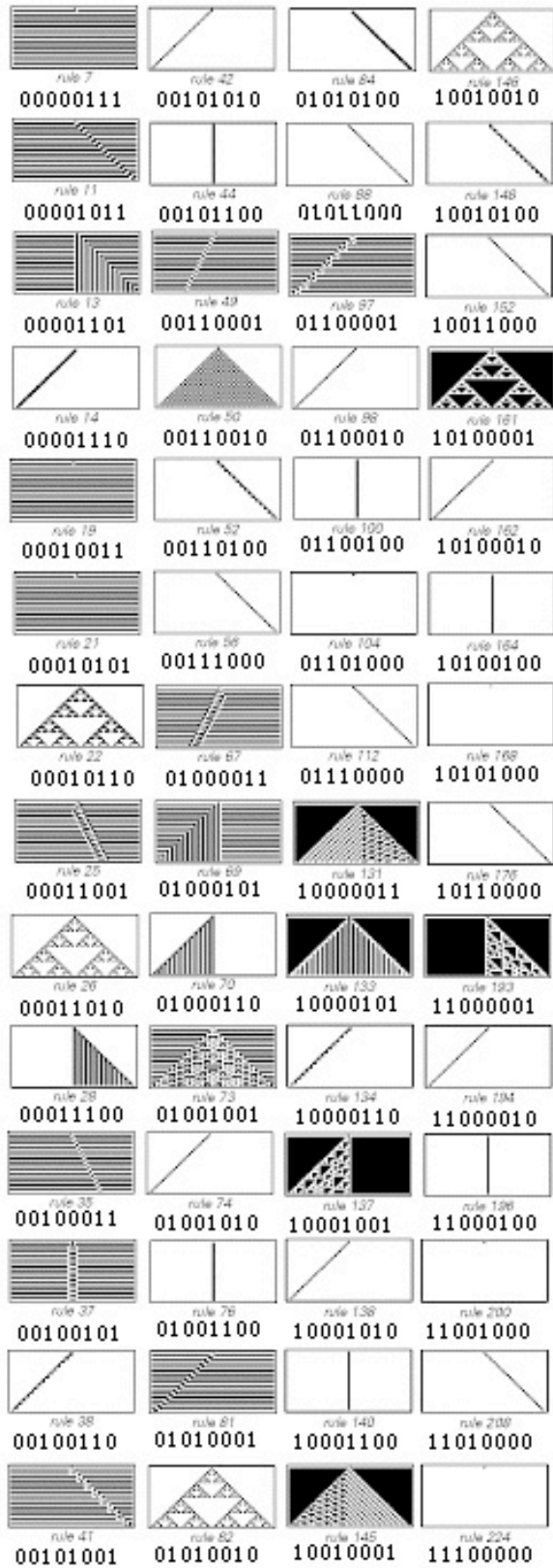

5

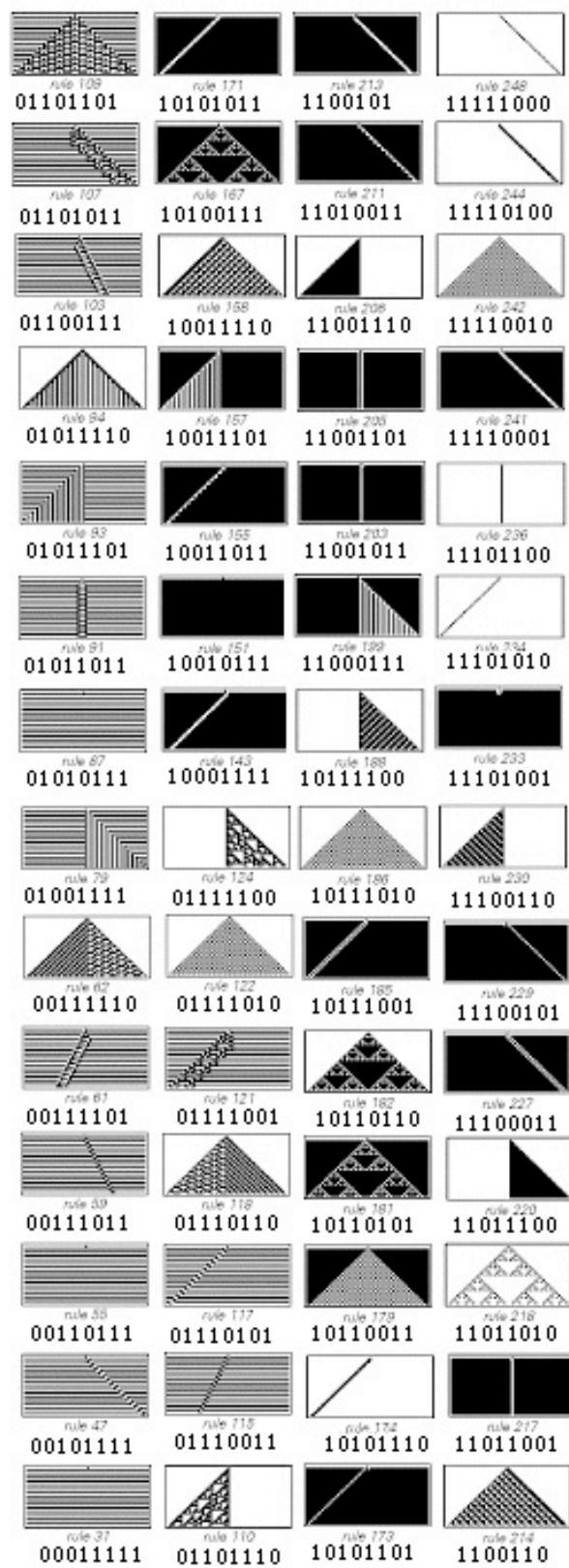

Grade:

4

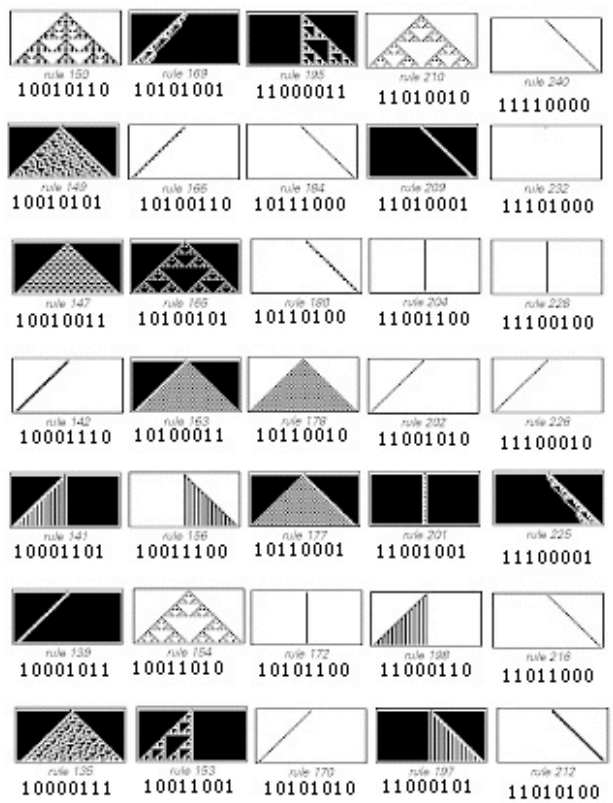
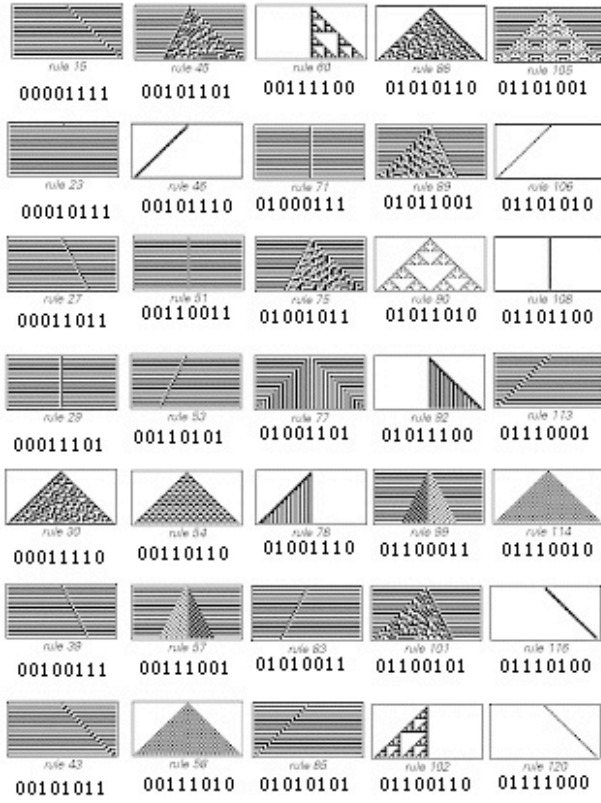

the 16 terms in the $CI(8)$ primitive idempotent

$$f = (1/2)(1 + e_{1248}) (1/2)(1 + e_{2358}) (1/2)(1 + e_{3468}) (1/2)(1 + e_{4578}) =$$

$$=(1/16)(1 + e_{1248} + e_{2358} + e_{3468} + e_{4578} + e_{5618} + e_{6728} + e_{7138} -$$

$$e_{3567} - e_{4671} - e_{5712} - e_{6123} - e_{7234} - e_{1345} - e_{2456} + e_J)$$

correspond to 16 of the 256 Cellular Automata

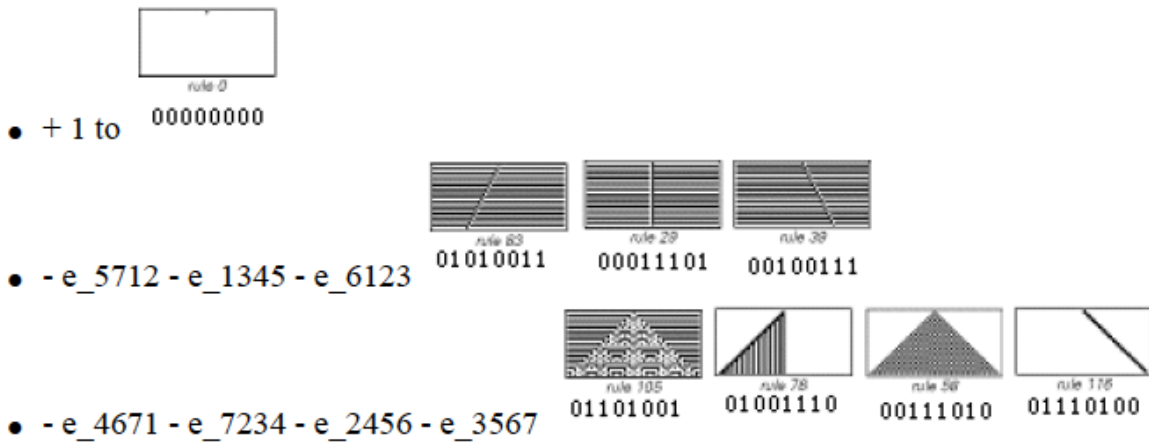
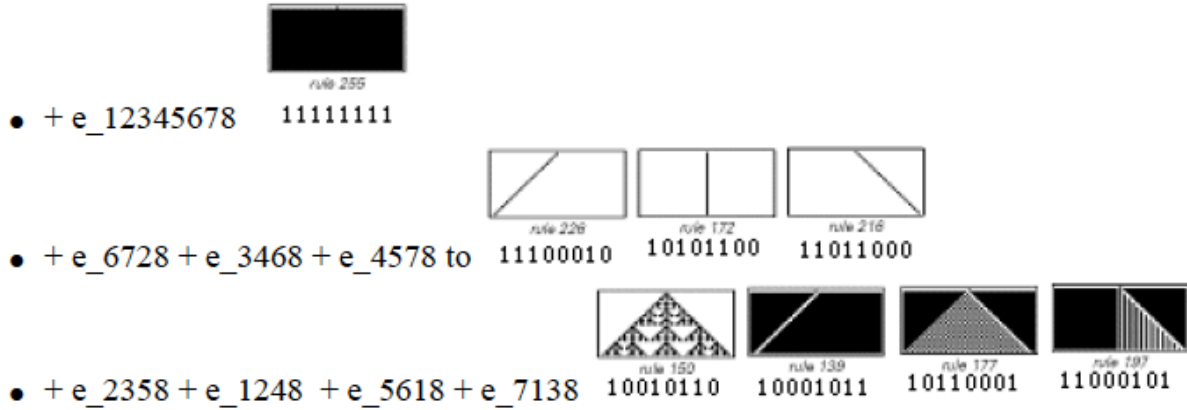

Note the $CI(0,8) = CI(1,7)$ triality correspondences among:

- the 8 [+half-spinors](#)



- the 8 [-half-spinors](#)

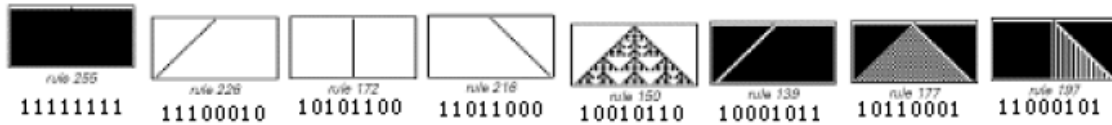

- [the 8 vectors](#)



Note that:

the grade-0 scalars



[are related to the Spinors and Primitive Idempotents of Cl\(0,8\);](#)

[the grade-1 vectors 1, 2, 4, 16](#) (the subset sequence $2^0 = 1, 2^1 = 2, 2^2 = 4, 2^4 = 16$ related to [Fermat primes](#))



correspond to [the 4 dimensions of physical spacetime;](#)

- o 1 gives a succession of bands, the procession of time;
- o 2 gives a slope to the left, one of three space dimensions;
- o 4 gives a vertical slope, a second of three space dimensions;
- o 16 gives a slope to the right, the third of three space dimensions;

[the grade-1 vectors 8, 32, 64, 128](#) (all giving all white)

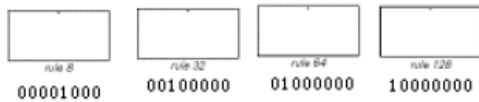

correspond to [the 4 dimensions of internal symmetry space;](#)

- rule 18 = 00010010 is the first rule to include both 16 = 00010000 with right slope and 2 = 00000010 with left slope and is the first rule with triangular self-similar fractal structure;
- rule 30 = 00011110 is the first rule to include 16, 8, 4, and 2 and is in the self-dual grade-4 and is the first rule with triangular chaotic behavior.

8 of the grade-2 bivectors,

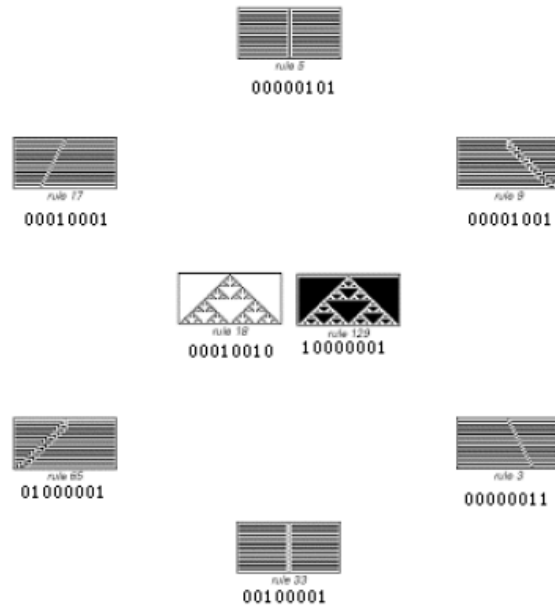

after [dimensional reduction to 4-dimensional physical spacetime](#), correspond to [the 8 generators of color force SU\(3\)](#), whose [root vector diagram](#) is illustrated above;

3 of the grade-2 bivectors,



after [dimensional reduction to 4-dimensional physical spacetime](#), correspond to [the 3 generators of weak force SU\(2\)](#);

1 of the grade-2 bivectors,



after [dimensional reduction to 4-dimensional physical spacetime](#), correspond to [the 1 generator of electromagnetic U\(1\)](#);

16 of the grade-2 bivectors,

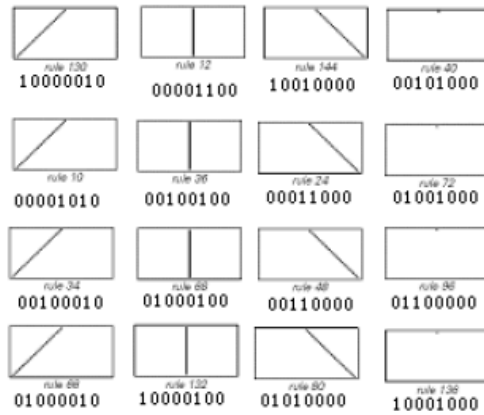

after [dimensional reduction to 4-dimensional physical spacetime](#), correspond to [the 16 generators of Gravity/Higgs/phase U\(2,2\)](#). One of them

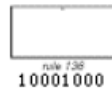

corresponds to the propagator phase U(1) while the other 15 correspond to the [Conformal Group SU\(2,2\) = Spin\(2,4\)](#) [whose root vector diagram](#)

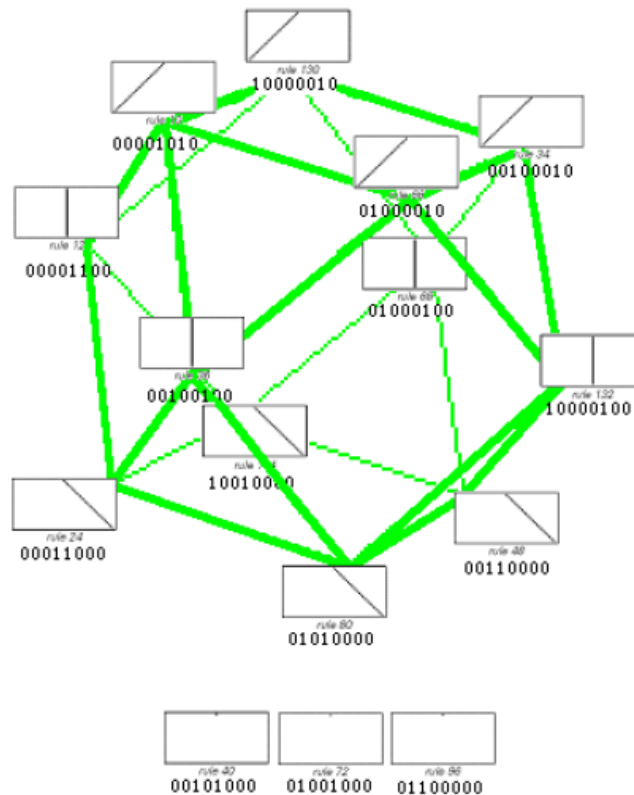

is a 12-vertex cuboctahedron (the other 3 bivectors corresponding to the 3 generators of the Cartan Subalgebra).

Appendix - Braids, E8, and E6 Conformal Penrose Tiling

Louis H. Kauffman in arxiv 1710.04650 said:

“... Let B_n denote the Artin braid group on n strands ... B_n is generated by elementary braids $\{s_1, \dots, s_{(n-1)}\}$ with relations

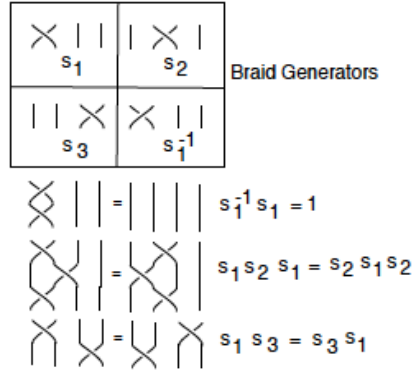

Figure 1: Braid Generators

1. $s_i s_j = s_j s_i$ for $|i - j| > 1$,
2. $s_i s_{i+1} s_i = s_{i+1} s_i s_{i+1}$ for $i = 1, \dots, n - 2$.

Braiding operators associated with Majorana operators are described as follows. Let $\{c_1, c_2, \dots, c_n\}$ denote a collection of Majorana operators such that $c_k^2 = 1$ for $k = 1, \dots, n$ and $c_i c_j + c_j c_i = 0$ when $i \neq j$. Take the indices $\{1, 2, \dots, n\}$ as a set of residues modulo n so that $n + 1 = 1$. Define operators

$$\sigma_k = (1 + c_{k+1} c_k) / \sqrt{2}$$

for $k = 1, \dots, n$ where it is understood that $c_{n+1} = c_1$ since $n + 1 = 1$ modulo n . Then one can verify that

$$\sigma_i \sigma_j = \sigma_j \sigma_i$$

when $|i - j| \geq 2$ and that

$$\sigma_i \sigma_{i+1} \sigma_i = \sigma_{i+1} \sigma_i \sigma_{i+1}$$

for all $i = 1, \dots, n$. Thus $\{\sigma_1, \dots, \sigma_{n-1}\}$ describes a representation of the n -strand Artin braid group B_n .

... the three braid generators of B_4 are shown, and ... the inverse of the first generator ...

Clifford Braiding Theorem. Let C be the Clifford algebra over the real numbers generated by linearly independent elements $\{c_1, c_2, \dots, c_n\}$ with $c_k^2 = 1$ for all k and $c_k c_l = -c_l c_k$ for $k \neq l$. Then the algebra elements $\tau_k = (1 + c_{k+1} c_k) / \sqrt{2}$, form a representation of the (circular) Artin braid group. That is, we have $\{\tau_1, \tau_2, \dots, \tau_{n-1}, \tau_n\}$ where $\tau_k = (1 + c_{k+1} c_k) / \sqrt{2}$ for $1 \leq k < n$ and $\tau_n = (1 + c_1 c_n) / \sqrt{2}$, and $\tau_k \tau_{k+1} \tau_k = \tau_{k+1} \tau_k \tau_{k+1}$ for all k and $\tau_i \tau_j = \tau_j \tau_i$ when $|i - j| > 2$. Note that each braiding generator τ_k has order 8.

Remark. It is worth noting that a triple of Majorana Fermions say x, y, z gives rise to a representation of the quaternion group.

...”

Therefore: **Braid Group B3 corresponds to the Clifford Algebra Cl(0,2) and to the Cayley-Dickson Quaternion Algebra H**

Tao Cheng, Hua-Lin Huang, and Yuping Yang in arxiv 1510.04408 said “...

Many interesting algebras appear as twisted group algebras. Here we recall some examples presented in [1, 2, 15]. Let \mathbb{R} denote the field of real numbers, $\mathbb{Z}_2 = \{0, 1\}$ the cyclic group of order 2, and \mathbb{Z}_2^n the direct product of n copies of \mathbb{Z}_2 . Elements of \mathbb{Z}_2^n are written as n -tuples of $\{0, 1\}$ and the group product is written as $+$. Define functions $f_m: \mathbb{Z}_2^n \times \mathbb{Z}_2^n \rightarrow \mathbb{Z}_2$ for all $1 \leq m \leq 3$ by

$$f_1(x, y) = \sum_i x_i y_i, \quad f_2(x, y) = \sum_{i < j} x_i y_j, \quad f_3(x, y) = \sum_{\substack{\text{distinct } i, j, k \\ i < j}} x_i x_j y_k.$$

1. Let $F_{\text{Cl}}: \mathbb{Z}_2^n \times \mathbb{Z}_2^n \rightarrow \mathbb{R}^*$ be a function defined by

$$F_{\text{Cl}}(x, y) = (-1)^{f_1(x, y) + f_2(x, y)}.$$

Then the associated twisted group algebra $\mathbb{R}_{F_{\text{Cl}}}[\mathbb{Z}_2^n]$ is the well-known real Clifford algebra $\text{Cl}_{0, n}$, see [2] for detail. This recovers the algebra of complex numbers \mathbb{C} when $n = 1$ and the algebra of quaternions \mathbb{H} when $n = 2$. Note that $\text{Cl}_{0, n}$ is associative in the usual sense since the function F_{Cl} is a 2-cocycle.

2. Assume $n \geq 3$. Define the function $F_{\mathbb{O}}: \mathbb{Z}_2^n \times \mathbb{Z}_2^n \rightarrow \mathbb{R}^*$ by

$$F_{\mathbb{O}}(x, y) = (-1)^{f_1(x, y) + f_2(x, y) + f_3(x, y)}.$$

Then the twisted group algebra $\mathbb{R}_{F_{\mathbb{O}}}[\mathbb{Z}_2^n]$ is the algebra of higher octonions \mathbb{O}_n introduced in [15] by generalizing the realization of octonions via twisted group algebras (i.e., $n = 3$)

...”

Note that \mathbb{Z}_2^n corresponds to Braid Group $B(n+1)$ so

$n = 1$ gives B_2 and $\text{Cl}(0,1)$ and Complex Numbers and Sphere $S^1 = U(1)$

Photons can be represented by B_2 Braids



$n = 2$ gives B_3 and $\text{Cl}(0,2)$ and Quaternions and Sphere $S^3 = SU(2)$

Sundance Bilson-Thompson in hep-ph/0503213 represents $SU(2)$ Bosons by B_3 Braids

($+$ and $-$ denote twists carrying Electric Charge)

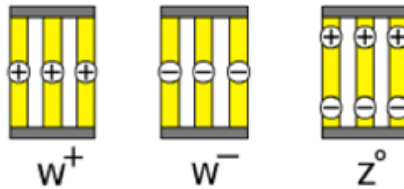

and

$n = 3$ gives **B4** and **Cl(0,3)** and **Octonions** and **Sphere S7**
 Octonions and Cl(0,3) both have 1 3 3 1 graded structure
SU(3) Color Force has **1+1 Neutral Gluons** and **3+3 Colored Gluons**
 (**R G B** denote twists carrying Color Charge)

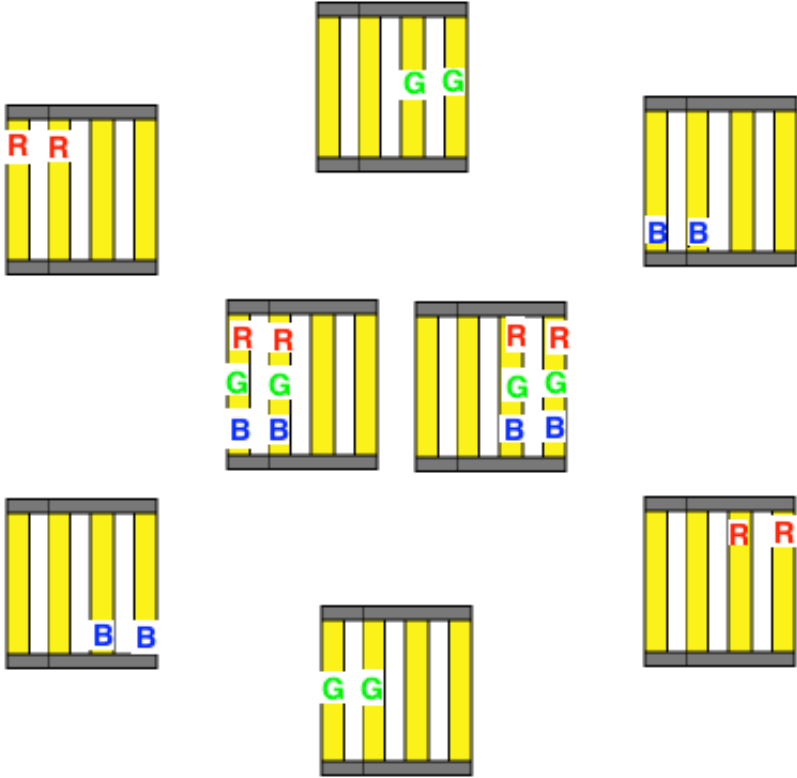

and

n = 4 gives B5 and Cl(0,4) and Sedenions and Sphere S15

Sedenions and Cl(0,4) both have 1 4 6 4 1 graded structure

SU(2,2) = Spin(2,4) Conformal Gravity + Dark Energy has 15 Graviton generators with similar 1 4 6 4 structure (U(2,2) has 1 4 6 4 1)

10 = 4 + 6 for Conformal Gravity + Dark Energy Universe Expansion (blue)
 4 Translations for Primordial Black Hole Dark Matter (green)
 1 Dilation for Higgs Mass of Ordinary Matter (red)

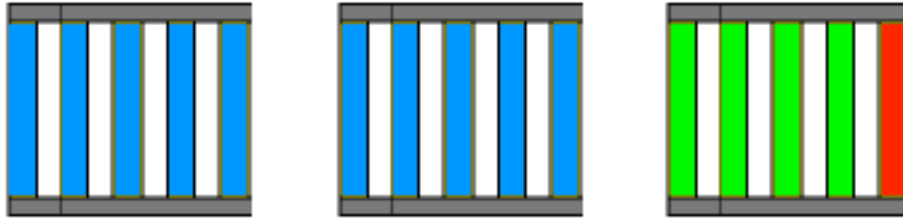

The basic **DE : DM : OM ratio** of 10 : 4 : 1 = 0.67 : 0.27 : 0.6 becomes, due to expansion process of Our Universe, **0.75 : 0.21 : 0.4 as of now**

Sedenions have Zero Divisors of the form Spin(7) / Spin(5) = G2 / Spin(3)

12 of the 15 generators form the A3 = D3 Root Vector Polytope of SU(2,2)
3 of the 15 generators form the A3 = D3 Cartan Subalgebra

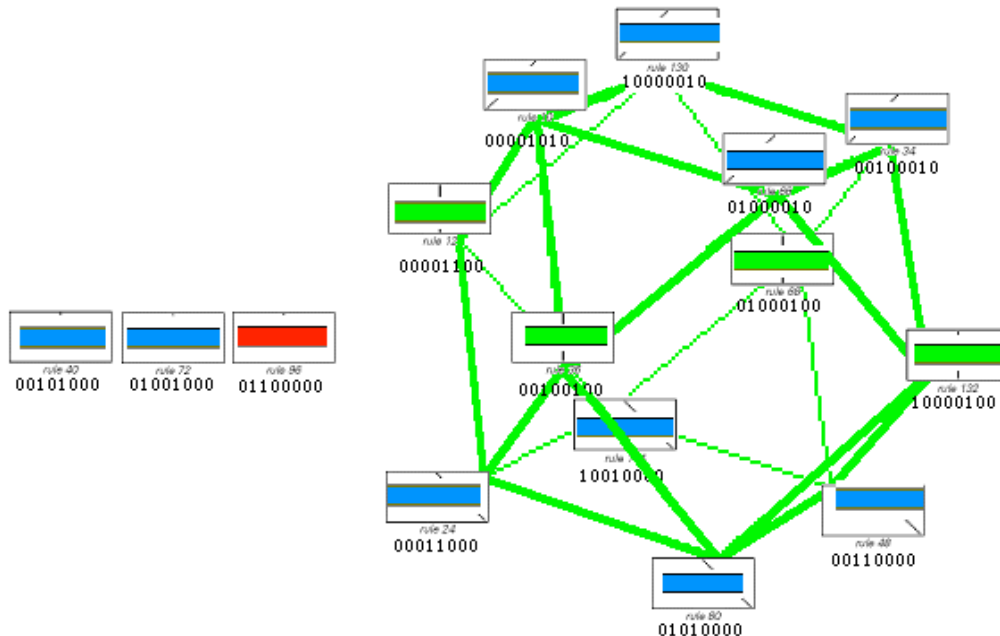

Also shown are the corresponding Elementary Cellular Automata

Here are how all 256 Elementary Cellular Automata correspond to all 256 elements of the $Cl(8)$ Real Clifford Algebra = 16x16 Real Matrices:

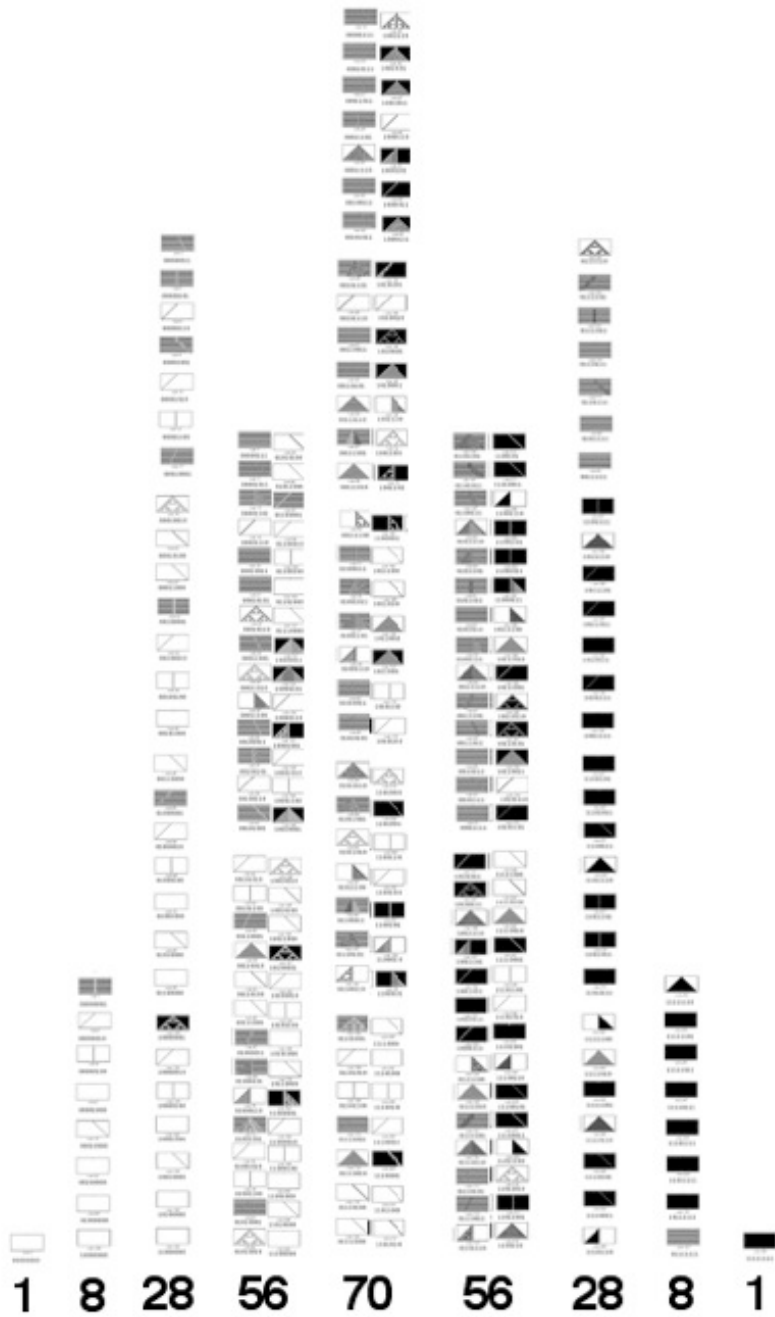

$n = 7$ gives B_8 and $Cl(0,7)$ and 21-dim $Spin(7)$ and $S^7 + Spin(7) = 28$ -dim D_4
and

Cayley-Dickson 128-ons = Geoffrey Dixon's 128D $T_2 = E_8 / D_8$

where 64D $T = RxCxHxO$

128D T_2 has Zero Divisors with structure related to Stiefel Manifold $V(63,2)$

The 8 Strands of B_8 represent 8 First-Generation Fermion Particles
(X denotes left-handed twist carrying no charge, but representing Octonion)
(right-handed massive electron and quarks emerge dynamically)

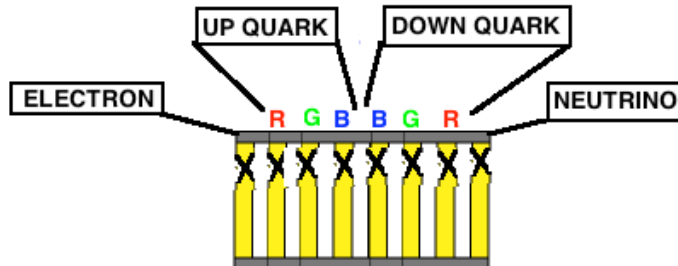

and by Triality 8 First-Generation Fermion Antiparticles
(X denotes right-handed twist carrying no charge, but representing Octonion)
(left-handed massive positron and antiquarks emerge dynamically)

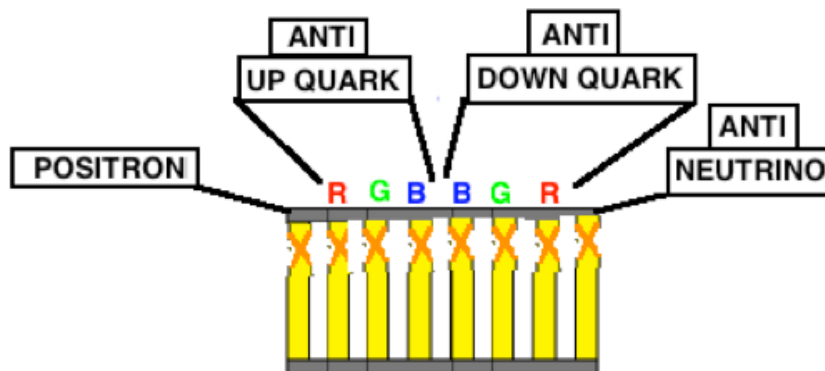

and also by Triality 8D Spacetime - $M_4 \times CP_2$ Kaluza-Klein

M_4 coordinates = $\{t, x, y, z\}$ CP_2 coordinates = $\{R, G, B, X\}$

(Spacetime Strands have no Twist)

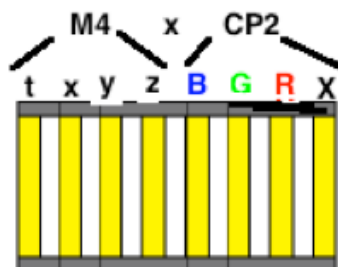

Fermions of Second and Third Generations have 2 or 3 Twists representing Pairs or Triples of Octonions

Second Generation:

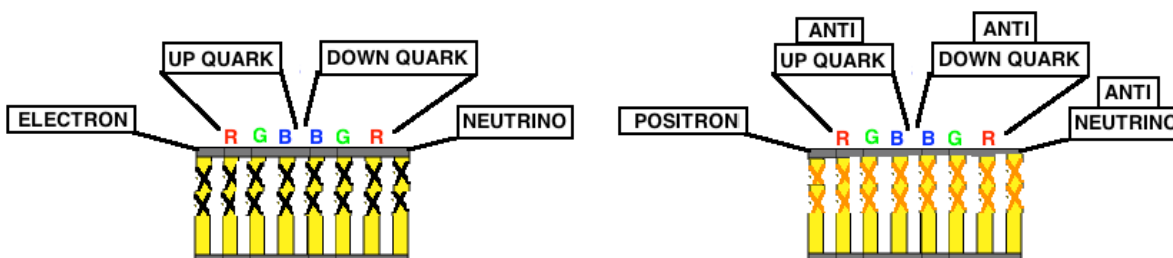

Third Generation:

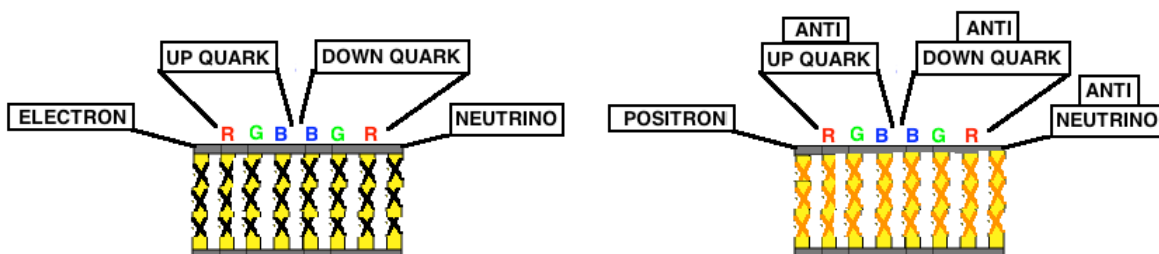

Further:

$$2 \text{ copies of } 28D \text{ D4} + 64D \text{ D8} / \text{D4xD4} + (64+64)D / e8 / \text{D8} = 248D \text{ E8}$$

that lives in $Cl(0,16) = \text{tensor product } Cl(0,8) \times Cl(0,8)$
for E8-Cl(16) Physics (see viXra 1602.0319)

Also:

Andre Joyal and Rose Street in Macquarie Mathematics Report NO.860081 Nov 1986 gave diagrams for Braid Groups B1 - B7 and structures in Braids B5-B7

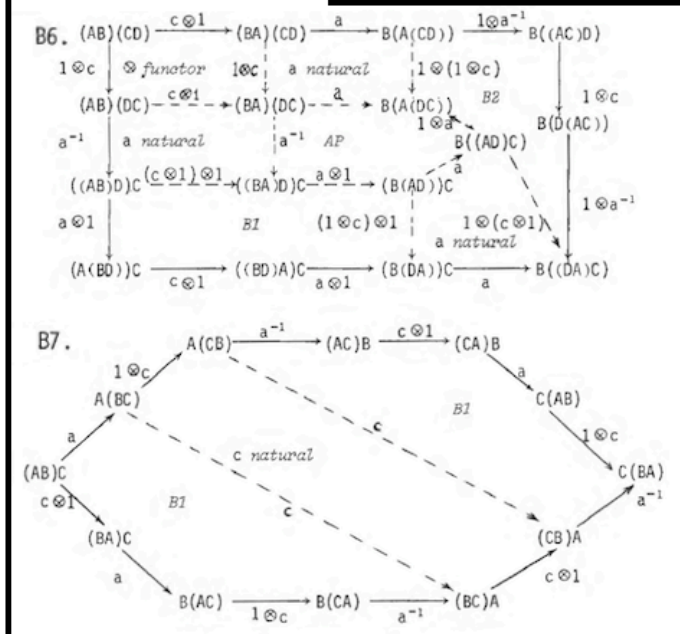
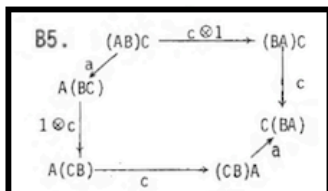
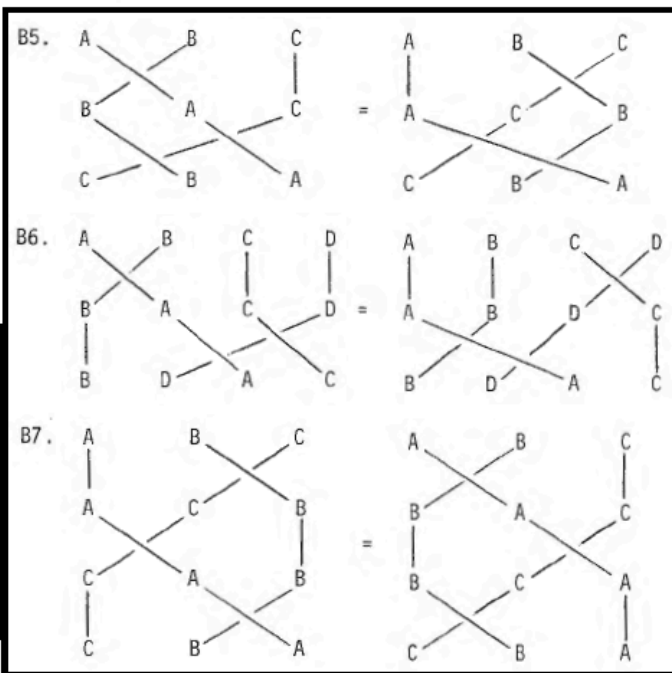
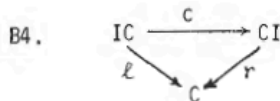
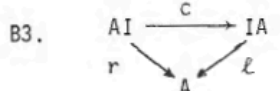
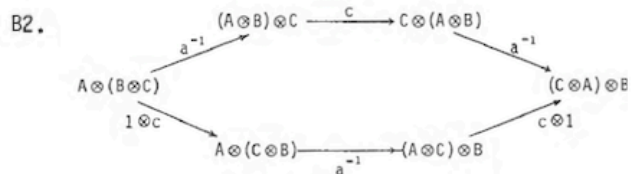
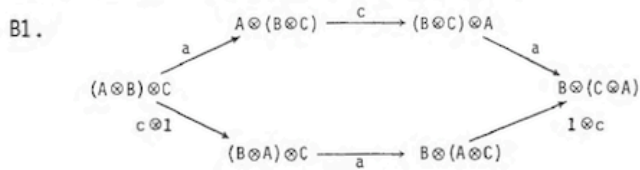

Here is how $Cl(16) = \text{tensor product } Cl(8) \times Cl(8)$ works and how it was known to the builders of the Giza Pyramids and how $Cl(16)$ information corresponds to information in 40 micron Microtubules:

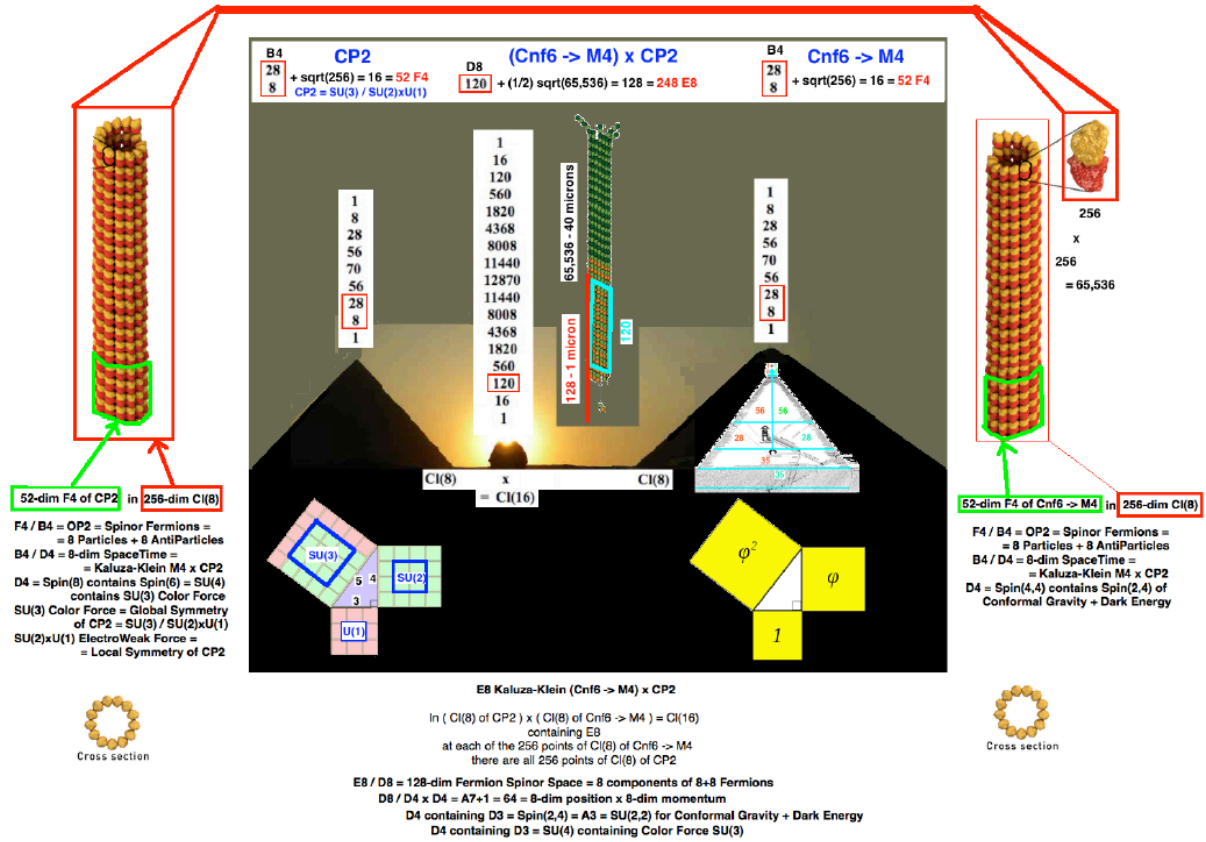

The builders of the Two Large Giza Pyramids designed their structures to show there are Two Fundamental Parts of Our Universe. They were rediscovered in the 20th Century as the Standard Model of Electromagnetism, the Weak Force, and the Color Force (left pyramid) and General Relativity of Gravity + Dark Energy (right pyramid). Now, in the 21st Century, we can see the Standard Model as described by 120 Root Vectors of a 4-dim 600-cell for the left Pyramid and Gravity + Dark Energy as described by 120 Root Vectors of another 4-dim 600-cell for the right Pyramid which when combined form the 240 Root Vectors of E_8 . Since E_8 240 contains both the Standard Model 120 and Gravity + Dark Energy 120 its structure shows how to build a realistic Lagrangian Theory of Everything that evolves with Our Universe to include the Higgs and Second and Third Generation Fermions. E_8 Physics predicts 3 mass states for Higgs and for Truth Quark (most people call it the Top Quark but I prefer to call it the Truth Quark) and in my opinion Fermilab and the LHC have already seen indications of all 3 states in their 2015-2016 Run2 data at 13 TeV (almost 5 Quadrillion events).

O. P. Shcherbak in Uspekhi Mat. Nauk 43:3 (1988) 125-160 said: "...

The non-standard representations of the groups H_2, H_3, H_4 are obtained if in the definition of the sets of generating mirrors the angle $\pi/5$ is replaced by the angle $2\pi/5$. The images of these representations are clearly reflection groups of the same name, the non-equivalence to the standard representation showing up by comparing the characters over (or under) the group H_2 .

The same applies to the groups $I_2(p), p \geq 7$, where the number of non-equivalent representations acting like $I_2(p)$ is equal to the number of values $i, 1 \leq i < p/2$, mutually prime to p .

$$\circ \xrightarrow{p} \circ I_2(p)$$

The main result of the present section is the establishment of a relation between the groups H_2, H_3, H_4 and the groups A_4, D_6, E_8 , respectively (Fig. 4). More precisely, the Coxeter groups H_2, H_3, H_4 are determined by the groups A_4, D_6, E_8 , the standard representations of the latter determining both the non-equivalent representations of the former.

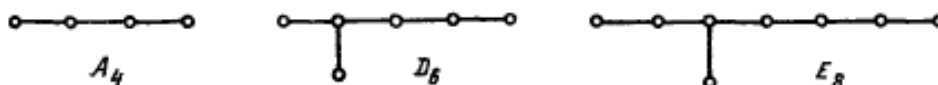

Fig. 4. The Coxeter graphs A_4, D_6, E_8

We draw the Coxeter graphs of the groups A_4, D_6, E_8 as shown in Fig. 5.

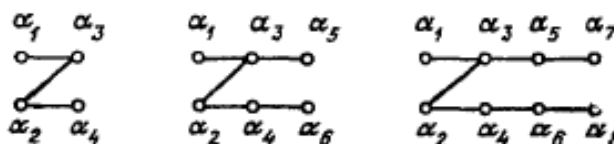

Fig. 5. Folding the graphs $A_4, D_6, E_8 \rightarrow H_2, H_3, H_4$

...

Latham Boyle and Paul J. Steinhardt in arXiv 1608.08215 said "... the Ammann pattern is a quasicrystal tiling in its own right, since the Ammann lines/planes/hyperplanes divide up space into a finite number of polytopes arranged quasiperiodically in a crystallographically forbidden pattern ... While a Penrose-like tiling has the simplifying property that all the edge lengths of all the tiles are the same, an Ammann pattern (regarded as a tiling) has the simplifying property that ... all the codimension-one tile "faces" join up to form infinite unbroken codimension-one affine spaces ... the Ammann pattern with orientational symmetry G is in many ways the simplest type of quasicrystal with orientational symmetry G . In particular, as far as we are aware, the Ammann pattern is the only type of quasicrystal (with orientational order G) that can be explicitly described by a closed-form analytic expression. The same is true for its diffraction pattern ...

quasicrystalline order with orientational symmetry \mathbf{G} ... may be built up from (or decomposed into) 1D quasiperiodic constituents ... all of the different Ammann patterns (regardless of their symmetry or dimension) are described by essentially the same formula, so that the higher-dimension or higher-symmetry cases are no more complicated than the original one ...

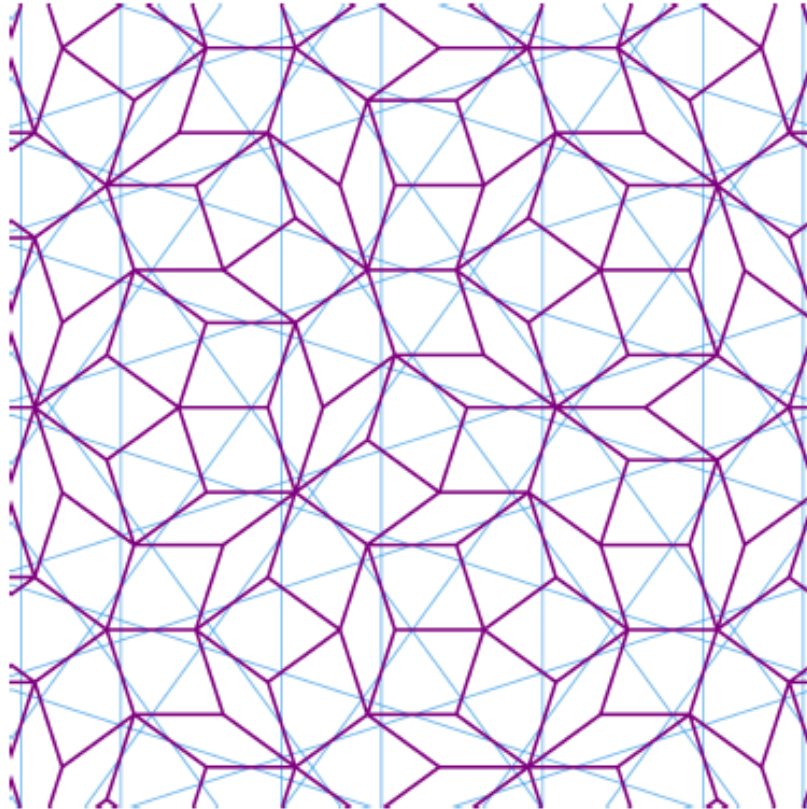

Figure 1: The thick purple lines show a portion of a Penrose tiling, while the thin blue lines show the corresponding Ammann pattern. Note that the Penrose tiling is built from two prototiles – a thin (36°) rhomb and a fat (72°) rhomb; and both prototiles are always decorated by the same characteristic pattern of Ammann lines.

the original Penrose tiling [Penrose STAR] ... in 2D, with 10-fold symmetry ...

[corresponds to]
the non-crystallographic root system I^5_2 [designated as H2 by Shcherbak] which is paired with the crystallographic root system A_4 ... [has] field extension ... $Q(\sqrt{5})$

...
a Penrose tiling [can] ... be obtained by dualizing an Ammann (penta-)grid ...

Consider an Ammann pattern in which the Ammann planes are arrayed along the J different directions ... These planes slice up d -dimensional Euclidean space into open d -dimensional regions ("cells"). To each cell, we assign a set of J integer coordinates ...

the cell lies between the hyperplanes labelled n_j and $n_j + 1$... The dualization procedure maps each cell in the Ammann pattern to a vertex in the corresponding Penrose tiling ...

non-crystallographic root system θ^{\parallel}	crystallographic partner θ	degree $N = d/d^{\parallel}$
I_2^p (p any prime ≥ 5)	A_{p-1}	$(p-1)/2$
$I_2^{2^m}$ (m any integer ≥ 3)	B_{2^m-1}/C_{2^m-1}	2^{m-2}
I_2^{12}	F_4	2
I_2^{30}	E_8	4
H_3	D_6	2
H_4	E_8	2

Table 2: The complete list of Coxeter pairs.

...

non-crystallographic root system θ_{\parallel}	crystallographic partner θ	field extension \mathbb{K}
I_2^5	A_4	$\mathbb{Q}(\sqrt{5})$
I_2^8	B_4/C_4	$\mathbb{Q}(\sqrt{2})$
I_2^{12}	F_4	$\mathbb{Q}(\sqrt{3})$
H_3	D_6	$\mathbb{Q}(\sqrt{5})$
H_4	E_8	$\mathbb{Q}(\sqrt{5})$

Table 3: Quadratic ($N = 2$) Coxeter pairs and their corresponding field extensions.

... ”

Latham Boyle and Paul J. Steinhardt in arXiv 1608.08220 said “...

The Penrose tiles also have [an]... important feature:

the two tiles can each be decorated with a certain pattern of line segments that join together in a perfect Penrose tiling to form five infinite sets of parallel lines oriented along the five edges of a pentagon. The lines are spaced according to a 1D quasiperiodic sequence of long and short intervals called a "Fibonacci quasilattice" ... The five sets of 1D quasilattices collectively form an Ammann pattern

...

a Penrose-like tiling should be regarded as the dual of a more fundamental object: an Ammann pattern;

and this Ammann pattern, in turn, can be derived from the relationship between two naturally-paired irreducible reflection groups (which we call a "Coxeter pair")

...

Our focus in this paper is the analysis of the 1D quasilattices that serve as the building blocks for the Ammann patterns in higher dimensions ...

Although our ultimate purpose is higher-dimensional quasicrystal tilings ... the 1D quasilattices studied here are important objects in their own right

...

"1D quasilattices of degree two" or "quadratic 1D quasilattices". These are 1D quasiperiodic lattices constructed from just two intervals or "tiles" (call them L and S, for "long" and "short"), with just two different separations between successive L's, and just two different separations between successive S's (the simplest possibility compatible with quasiperiodicity) ...

...
 In a generic (non-singular) self-similar quasilattice, the line ... does not intersect any of the points in the lattice ...

...
 we identify the subset of quadratic 1D quasilattices that are not only self-similar under some 2 x 2 transformation T, but are exactly s-fold self-same; that is, T^s maps the quasilattice x_n to a new quasilattice x'_n that is not merely locally-isomorphic, but actually identical to the original quasilattice (up to an overall rescaling)

...
 for ... the special quasi-lattice ... where the scaling factor is the "golden ratio" ...

Case	λ_{\pm}	τ	m_2^{\pm}/m_1^{\pm}	S'	L'
1	$\frac{1}{2}(1 \pm \sqrt{5})$	$\begin{pmatrix} 0 & 1 \\ 1 & 1 \end{pmatrix}$	$\frac{1}{2}(1 \pm \sqrt{5})$	$\frac{L}{2} \frac{L}{2}$	$\frac{L}{2} S \frac{L}{2}$

In this table, we use the convenient notation λ_{\pm} and m_i^{\pm} where here the superscript/subscript "+" stands for the former subscript/superscript "||", while the "-" stands for "⊥".

... which is the relevant case for ... systems with 5-fold or 10-fold [H2] order in 2D, some systems with icosahedral (H3) order in 3D, and systems with with "hyper-icosahedral" (H4) order in 4D ...
 we count the number of irreducible s-cycles ...

s	F_s^2	$\langle N_s \rangle / s$
1	1	0
2	1	1
3	2	1
4	3	1
5	5	2
6	8	2
7	13	4
8	21	5
9	34	8
10	55	11
11	89	18
12	144	25

Here we list tabulate the first 12 terms in the sequence F_s and the sequence $\langle N_s \rangle / s$, for $\phi = (1 + \sqrt{5})/2$ (columns 1 and 2)

... the sequences of numbers ... appear as entries in the Online Encyclopedia

of Integer Sequences (OEIS) ...

The first column is OEIS sequence A000045 ("Fibonacci numbers");
 the second column is A006206 ("Number of aperiodic binary necklaces of length n
 with no subsequence 00, excluding the necklace "0")

...

Case	S'	L'
1		

1D self-similar substitution rules relevant to constructing higher-dimensional Ammann patterns and Penrose-like tilings

the short (solid, purple) and long (dashed, turquoise) prototiles are on the bottom, with their corresponding self-similar decimations into smaller tiles directly above.

Open circles indicate the endpoints of tiles. Complete tiles have circles at both ends; half tiles have a circle at one end but none at the half-way point.

For example, Row 1 shows how

a short prototile S' (bottom left) is subdivided into two halves of a long prototile:

$$S' = (L/2)(L/2) \text{ (top left);}$$

and a long prototile L' (bottom right) is subdivided into $L' = (L/2)S(L/2)$ (top right).

... .

Latham Boyle and Paul J. Steinhardt in arXiv 1608.08215 said "...

a Coxeter pair ... a non-crystallographic reflection group (of lower rank)
 has a natural crystallographic partner (of higher rank) ...

The H4 (4D hyper-icosahedral) tiling

Here the relevant Coxeter pair is ... { H4 , E8 }. The E8 root system has 240 roots:

all 128 vectors of the form $(1=2)(+/-1 , +/-1 , +/-1 , +/-1 , +/-1 , +/-1 , +/-1 , +/-1)$
 (with an even number of minus signs),

along with all 112 vectors of the form $(+/-1 , +/-1 , 0 , 0 , 0 , 0 , 0 , 0)$

(including all sign combinations and permutations of the coordinates) ...

the 240 E8 roots project ... to yield two copies of the 120 H4 roots

(an inner copy and an outer copy that is longer by [the Golden Ratio]) ...

the minimal star ... is a 120-pointed star pointing towards the vertices of the 600-cell ...

the unique reflection quasilattice corresponding to H4 is the H4 root quasilattice
 (i.e. the set of all integer linear combinations of the H4 roots) ...

there is a unique 4D space group corresponding to (the unique irreducible non-crystallographic roots system) H4

[The Coxeter group of H4 is of order 14,400 and contains 60 reflections,
 according to James E. Humphreys in his book Reflection Groups and Coxeter Groups]

Root Vectors: 240 E8 = 120 H4 CP2 Internal + 120 H4 M4 External

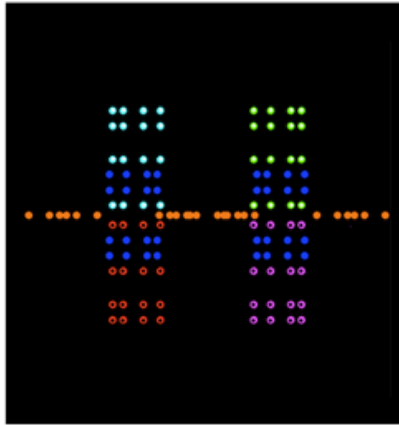

4-dim 120-vertices
H4 600-cell
for Standard Model
SU(3)xSU(2)xU(1)

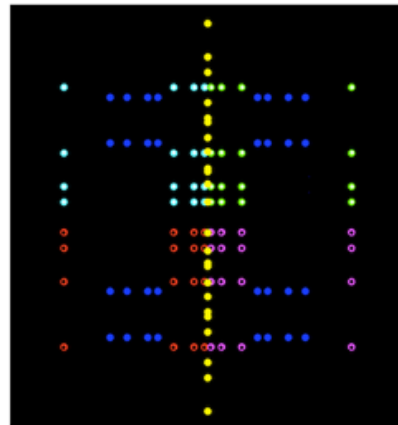

4-dim 120-vertices
H4 600-cell
for Conformal Gravity

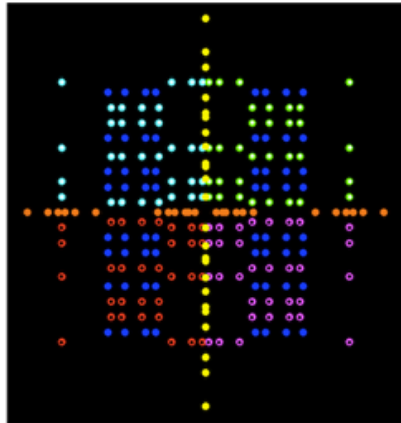

8-dim 240 vertices
E8
M4 x CP2 Unified TOE

E8 = 120 BiVectors + 128 half-Spinors of Cl(16) Clifford Algebra
with graded structure
1 16 120 560 1820 4368 8008 11440 12870 11440 8008 4368 1820 560 120 16 1
By 8-Periodicity of Real Clifford Algebras: Cl(16) = tensor product Cl(8) x Cl(8)
so with that product E8 = F4 x F4

H4 = 24 (vertices) + 96 (edges) = 120-vertex 600-cell tiling of 4-dim space
with Coxeter Group determined by E8

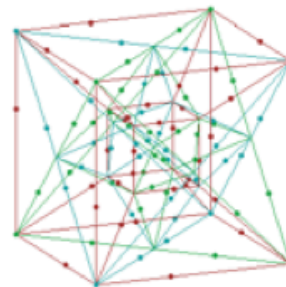
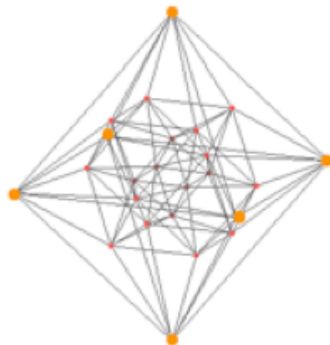

F4 = 24 cell + dual 24-cell tiling of 4-dim space

F4 = 8 Vectors + 28 BiVectors + 16 Spinors of Cl(8) Clifford Algebra
 with graded structure 1 8 28 56 70 56 28 8 1
 tile 4-dim space by 24-cells and their dual 24-cells

D4 24-cell tiling of 4-dim space

D4 = 28 BiVectors of Cl(8) Clifford Algebra with 24 root vectors
 with graded structure 1 8 28 56 70 56 28 8 1
 tile 4-dim space by 24-cells

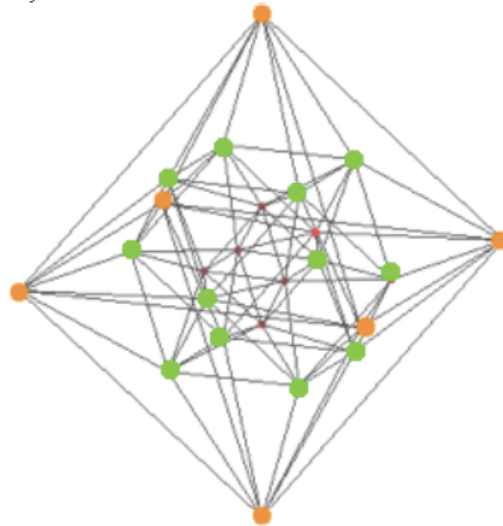

A3 = D3 = cuboctahedral tiling of 3-dim space

A3=D3 = 15 BiVectors of Cl(6) Clifford Algebra with 12 root vectors and
 with graded structure 1 6 15 20 15 6 1
 tile 3-dim space by cuboctahedra
 which can be seen as a central part of a 24-cell (green vertices above)

H3 = 12-Vertex Icosahedron as Jitterbug Transform of 12-Vertex Cuboctahedron
 with Coxeter Group determined by D6



...

The H3 (3D icosahedral) tilings ...

Here the relevant Coxeter pair is ... { H3 , D6 }. The D6 root system has 60 roots: all vectors obtained from (+/-1 , +/-1 , 0 , 0 , 0 , 0) by allowing all combinations of signs and all permutations of the coordinates ... the 60 D6 roots project to two copies of the 30 H3 roots (an inner copy and an outer copy that is longer by [the Golden Ratio] ... the 12 faces of the 6-cube in 6D ... are project[ed] ... to ... the 12 vertices of the icosahedron in 3D

...

[The Coxeter group of H3 is of order 120 and contains 15 reflections, according to James E. Humphreys in his book Reflection Groups and Coxeter Groups]

...

the minimal star ... is a 12-pointed star pointing towards the vertices of the icosahedron

...

[the] Ammann pattern and Penrose tiling with [Golden Ratio $(1/2)(1 + \sqrt{5})$] scaling ... is precisely the icosahedral tiling found by Socolar and Steinhardt in [1986]

...

H2 Penrose STAR tilings of 2-dim space

$H2 = I^5_2 =$ Penrose STAR tiling of 2-dim space

with Coxeter group determined by $A4$ which contains $A2$
and field extension $Q(\sqrt{5})$

The central part of the tiling has 5 pentagonal sectors

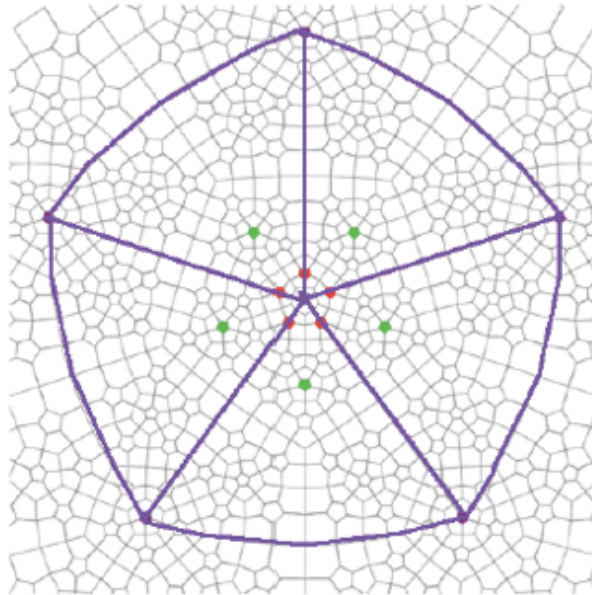

Each of the 5 pentagonal sectors of the tiling contains a 2-dim projected version of the 8-dim $E8$ Root Vector structure of $E8$ Physics corresponding to the Complex $E6$ subalgebra of Octonionic $E8$. The outer boundary of each sector is not a straight line but is curved with Conformal Symmetry and pentagonal sectors further out are conformally curved rather than straight-line pentagons.

Each pentagonal sector represents the Complex part of Octonionic $E8$ Physics whose 240 $E8$ Root Vectors project to the 72 Root Vectors of $E6$ subalgebra of $E8$ which 72 $E6$ Root Vectors have the following physical interpretation

16 = 2x8 of which represent Complex Fermion Particles
16 = 2x8 of which represent Complex Fermion AntiParticles
16 = 2x(4+4) of which represent Complex (4+4)-dim Kaluza-Klein SpaceTime
12 of which represent the Standard Model
12 of which represent Gravity + Dark Energy

The $I_2^5 [H_2]$ (2D 10-fold) tiling

Here the relevant Coxeter pair is ... $\{ I_2^5 [H_2], A_4 \}$. The A_4 root system has 20 roots: all vectors obtained from $(+1, -1, 0, 0)$ by allowing all permutations of the coordinates ...

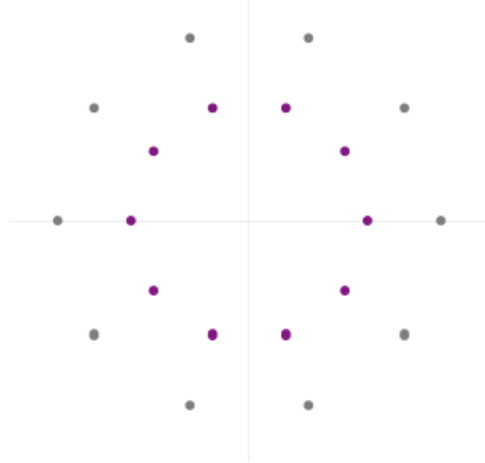

Figure 6: The 20 roots of A_4 , projected onto the Coxeter plane.

the underlying star ... points to the 5 vertices of a regular pentagon

...

this case ... precisely recovers the original 10-fold Penrose tiling, with its standard Ammann decoration and inflation rule ...”.

E8 Root Vectors and E6 in Conformal Penrose Tiling

E8 Physics (viXra 1602.0319) is based on the 240 Root Vectors of E8 which E8 is contained in $Cl(16)$ the completion of the union of all tensor products of which gives a generalized Hyperfinite II1 von Neumann factor AQFT with underlying Lagrangian structure given by the 240 Root Vectors of E8.

E6 subalgebra of E8 with 72 Root Vectors describes a Complex version of Octonionic E8 Physics which describes Physics of Conformal Penrose Tiling. Mapping of the 240 E8 Root Vectors to the 72 E6 Root Vectors

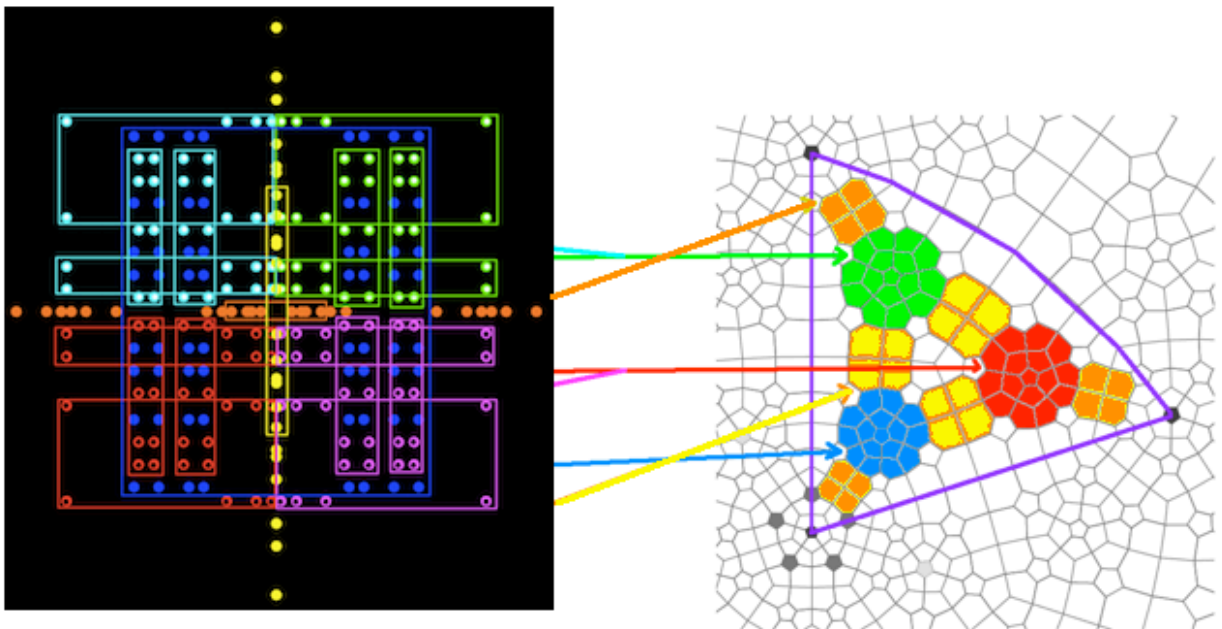

is 4 to 1 for $64 + 64 + 64$ of E8 to $16 + 16 + 16$ of E6
and 2 to 1 for $24 + 24$ of E8 to $12 + 12$ of E6

In arXiv 1303.2000 Maria Ramirez-Solano said:

“... The conformally regular pentagonal tiling of the plane ... The goal is to describe this tiling as a conformal substitution tiling, i.e. a tiling generated by a substitution rule with complex scaling factor > 1 and a finite number of prototiles, where each prototile is substituted with “extended-conformal” copies of the prototiles ...

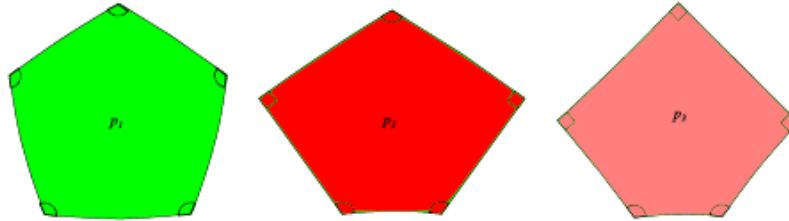
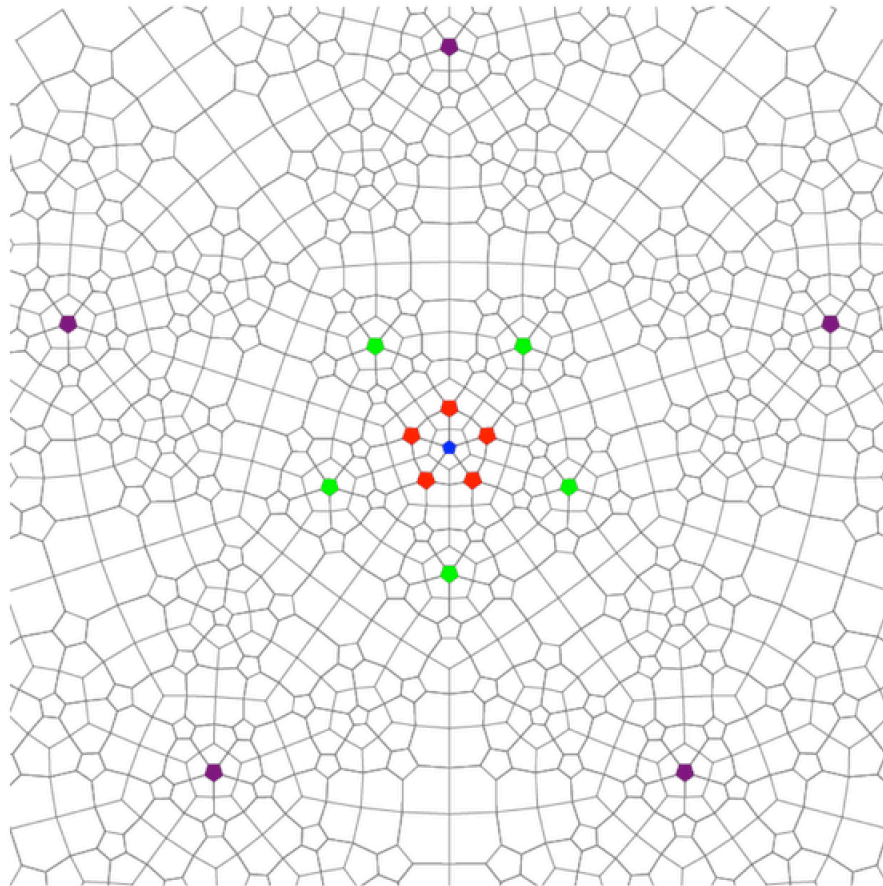

FIGURE 7. The prototiles of T . The interior angles are either $\pi/2$ or $2\pi/3$.

... We can construct a tiling ... where the tiles are ... conformally regular pentagons, and the tiling looks like



... The article “A regular pentagonal tiling of the plane” by Philip L. Bowers and Kenneth Stephenson in [22] gives a construction of this tiling using the theory of circle packings on the above combinatorics. They use circle packings to impose a natural geometry on the above combinatorics ...”.

The central part of the tiling has 5 pentagonal sectors

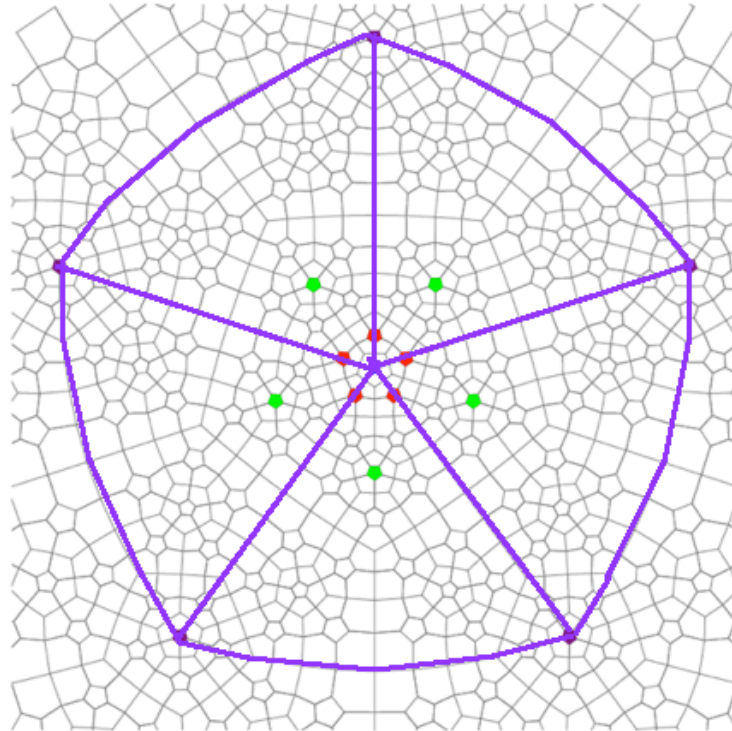

Each of the 5 pentagonal sectors of the tiling contains a 2-dim projected version of the 8-dim E8 Root Vector structure of E8 Physics corresponding to the Complex E6 subalgebra of Octonionic E8. The outer boundary of each sector is not a straight line but is curved with Conformal Symmetry and pentagonal sectors further out are conformally curved rather than straight-line pentagons.

Each pentagonal sector represents the Complex part of Octonionic E8 Physics whose 240 E8 Root Vectors project to the 72 Root Vectors of E6 subalgebra of E8 which 72 E6 Root Vectors have the following physical interpretation

16 = 2x8 of which represent Complex Fermion Particles
16 = 2x8 of which represent Complex Fermion AntiParticles
16 = 2x(4+4) of which represent Complex (4+4)-dim Kaluza-Klein SpaceTime
12 of which represent the Standard Model
12 of which represent Gravity + Dark Energy

as shown in the following image of one of the pentagonal sectors:

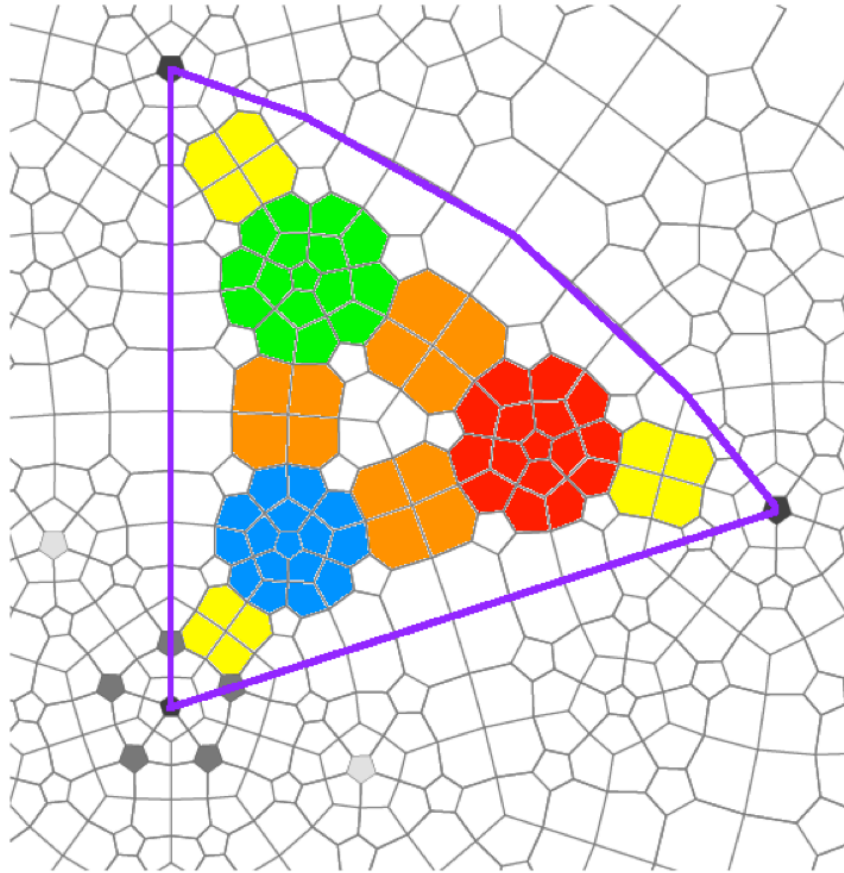

The 240 E8 Root Vectors correspond to the 72 E6 Root vectors
 by a 4 to 1 map for 64 + 64 + 64 of E8 to 16 + 16 + 16 of E6
 and a 2 to 1 map for 24 + 24 of E8 to 12 + 12 of E6

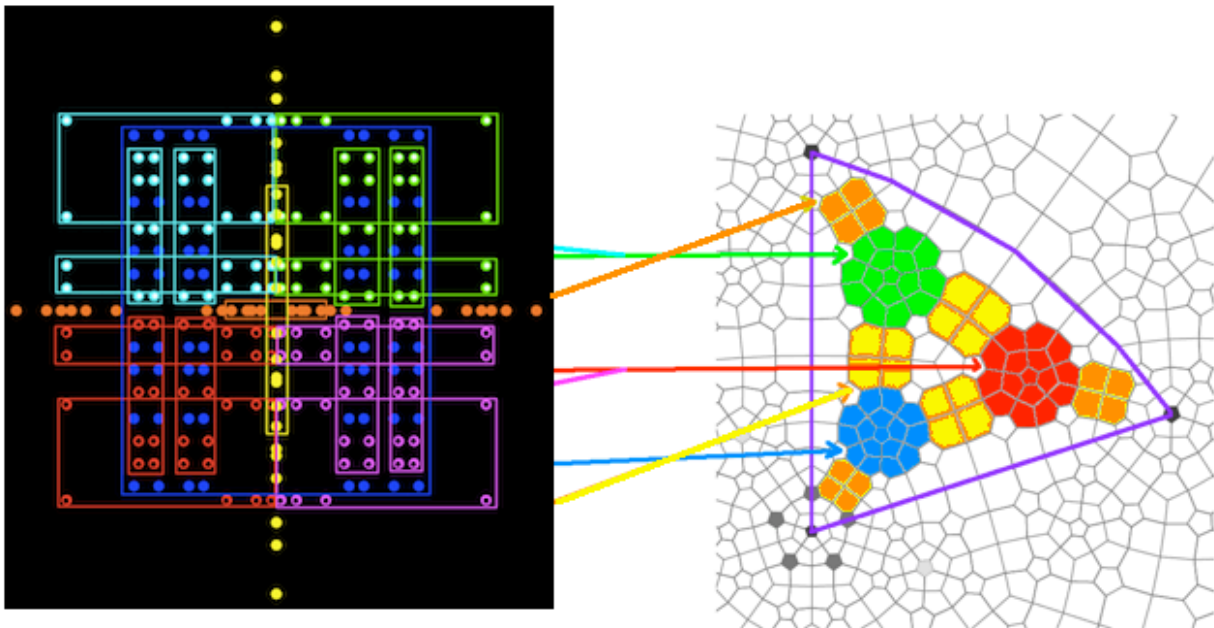

Here are more details of the E8 Root Vector Physical interpretations:

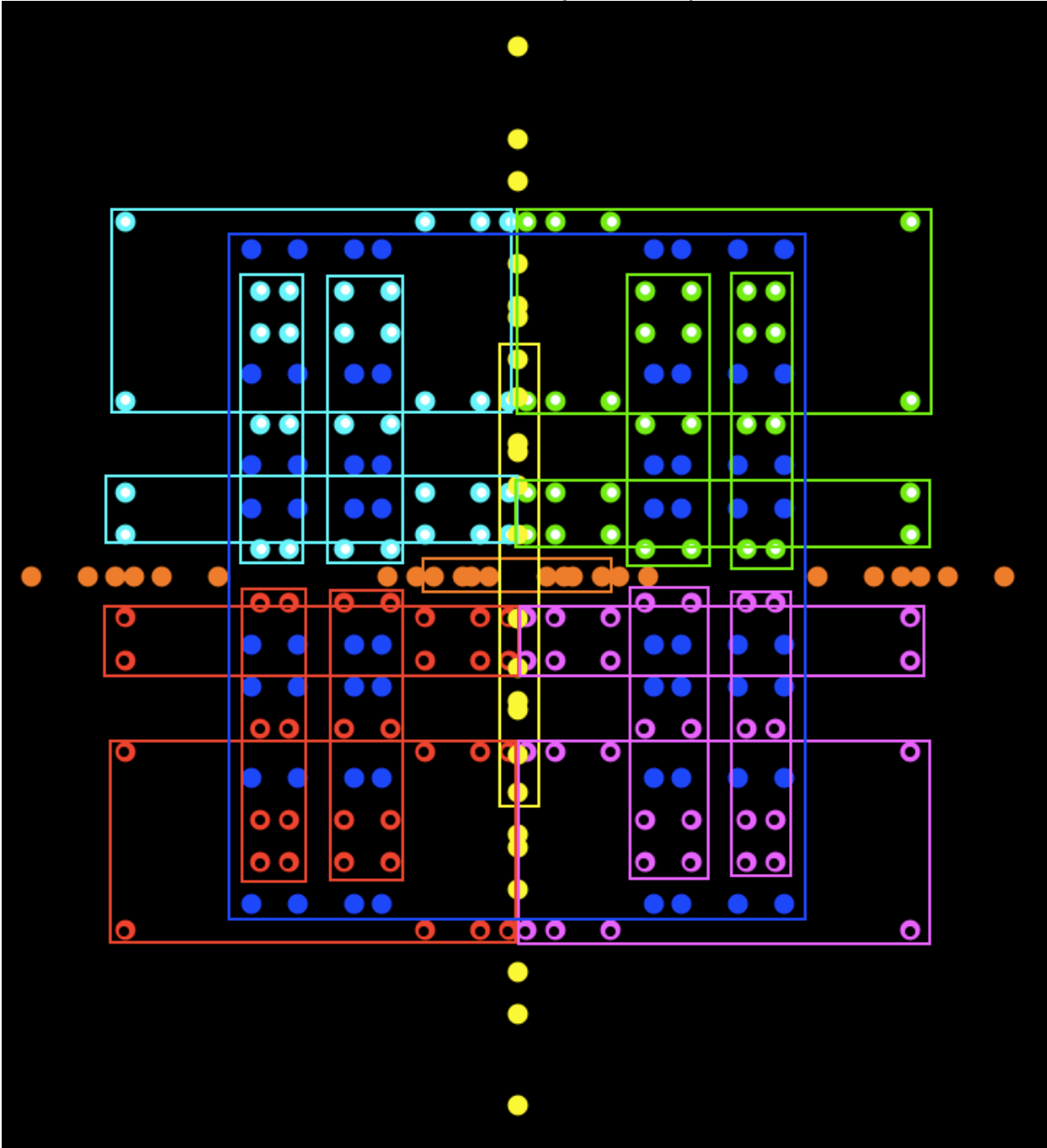

Connectors

In addition to the 72 E6 Root Vector tiles within a Pentagonal Sector there are 3 sets of 8 tiles (purple) that connect that Pentagonal Sector with an adjoining Pentagonal Sector. Those $3 \times 8 = 24$ tiles represent the Root Vectors of a $D_4 = \text{Spin}(8)$ Lie Group of rotations in the 8-dim space of the E8 Lattice that is projected into the plane of the Conformal Penrose Tiling, which give the directions of connections of the projected 240-vertex E8 Polytope with adjoining Polytopes of the E8 Lattice.

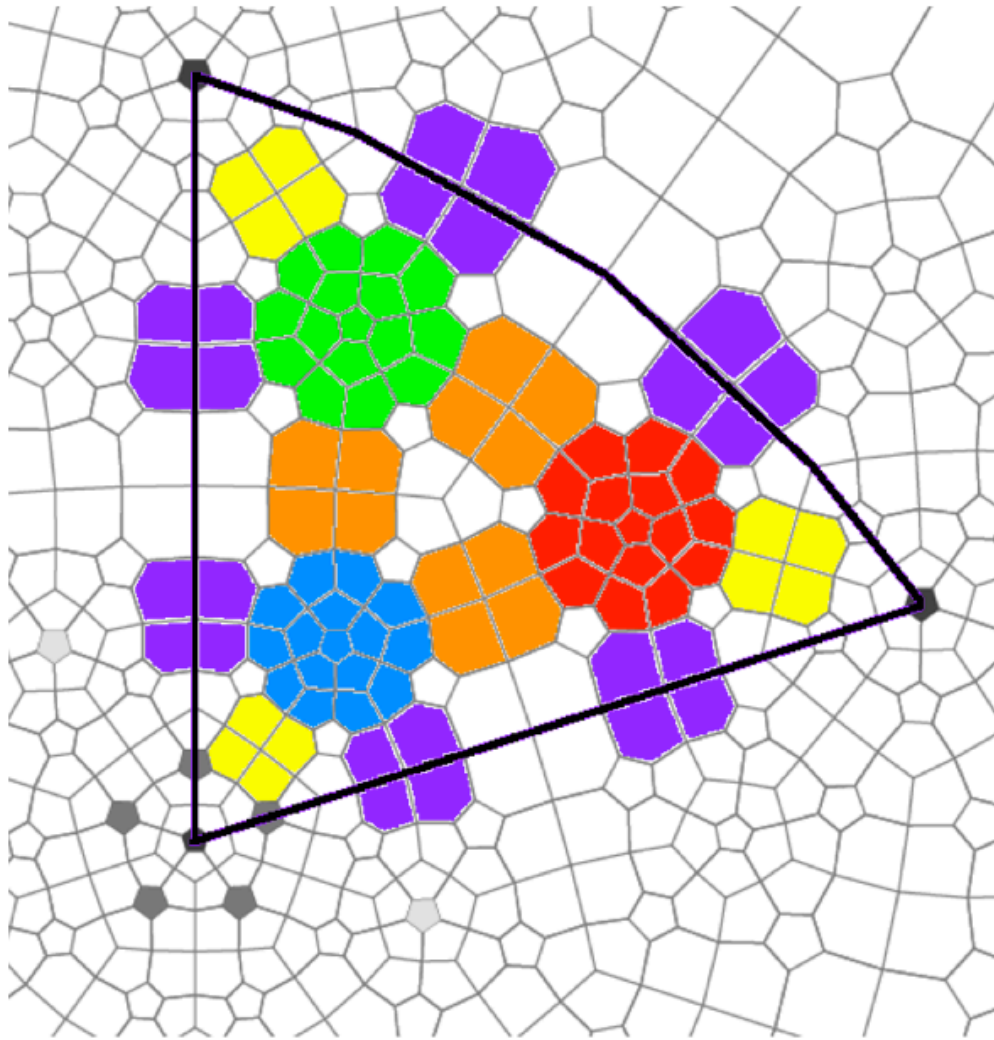

Each of the 3 vertices of the Pentagonal Sector is associated with
28 of the 72 E6 Root Vectors and 8 of the 24 Pentagonal Sector Connectors

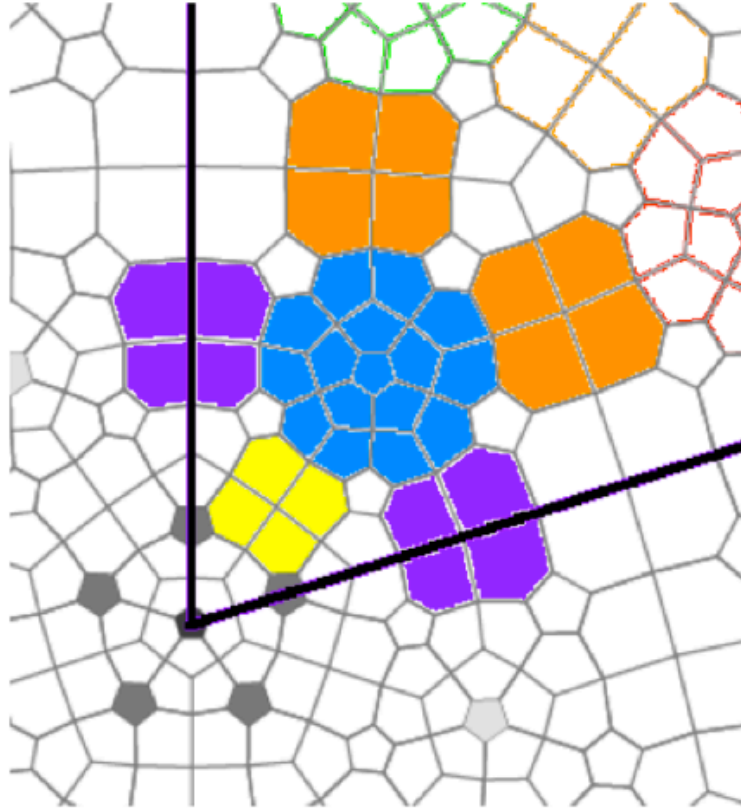

in a Pentagonal Sector Vertex Configuration.

Collared Tiles and Dynamical Systems

In arXiv 1303.2000 Maria Ramirez-Solano said:

“... A group action is a triple (X, G, P) composed of a topological space X , an Abelian group G , and an action map $P : X \times G \rightarrow X$ defined by $P_g : X \rightarrow X$, which is a homeomorphism for every $g \in G$, and $P_0 = \text{id}$ and $P_g \circ P_h = P_{g+h}$ for every $g, h \in G$.

A dynamical system is a group action $((X, d), G, P)$, where (X, d) is a compact metric space called the phase space, and the group action P is continuous. For short we write (X, G) instead of $((X, d), G, P)$. The study of the topological properties of dynamical systems is called topological dynamics, and the study of the statistical properties of dynamical systems is called ergodic theory. ...

The orbit set of a tiling T is defined by

$$O(T) := \{T + x \mid x \in \mathbb{R}^2\},$$

where $T + x := \{t + x \mid t \in T\}$. The group \mathbb{R}^2 acts on the orbit set $O(T)$ of a tiling T by translation, for if T' is in the orbit set, then so is $T' + x$ for all $x \in \mathbb{R}^2$.

The orbit set $O(T)$ is equipped with a metric $d : O(T) \times O(T) \rightarrow [0, \infty[$ defined by $d(T, T') < 1/r$ if there is $x, x' \in B_{1/r}(0)$ such that $(T - x) \cap B_r(0) = (T' - x') \cap B_r(0)$ i.e. if they agree on a ball of radius r centered at the origin up to a small wiggle ...

The continuous hull W_T of a tiling T is defined as

the completion of the metric space $(O(T), d)$

...

The same definition of d extends to W_T , and (W_T, d) is a metric space. The group \mathbb{R}^2 acts also on the hull by translation, for if T' is in W_T then so is $T' + x$ for any $x \in \mathbb{R}^2$ A patch P is a finite subset of a tiling T . A tiling satisfies the finite local complexity (FLC) if for any $r > 0$ there are finitely many patches of diameter less than r up to a group of motion G , usually translation. The finite local complexity (FLC) is also called finite pattern condition ... if a tiling T satisfies the FLC condition then the metric space (W_T, d) is compact.

Hence, if a tiling T satisfies the FLC condition, then (W_T, \mathbb{R}^2) is a topological dynamical system. The action $P : W_T \times \mathbb{R}^2 \rightarrow W_T$ given by $P_x(T') := T' + x$ is continuous by definition of the metric. ...”.

In arXiv 1304.2652 Maria Ramirez-Solano said:

“... For an aperiodic FLC Euclidean substitution tiling of the plane, there is a recipe for writing its continuous hull as an inverse limit ...

In [arXiv 1303.5676] we constructed a compact topological space for the combinatorics of “A regular pentagonal tiling of the plane”, which we call the continuous hull.

We also constructed a substitution map on the space which turns out to be a homeomorphism, and so the pair given by the continuous hull and the substitution map yields a dynamical system. In this paper we show how we can write this dynamical system as another dynamical system given by an inverse limit and a right shift map ...

If we can label the tiles of a tiling not only by their own type but by the pattern of their nearest neighbors, then we call such labels collared tiles ...

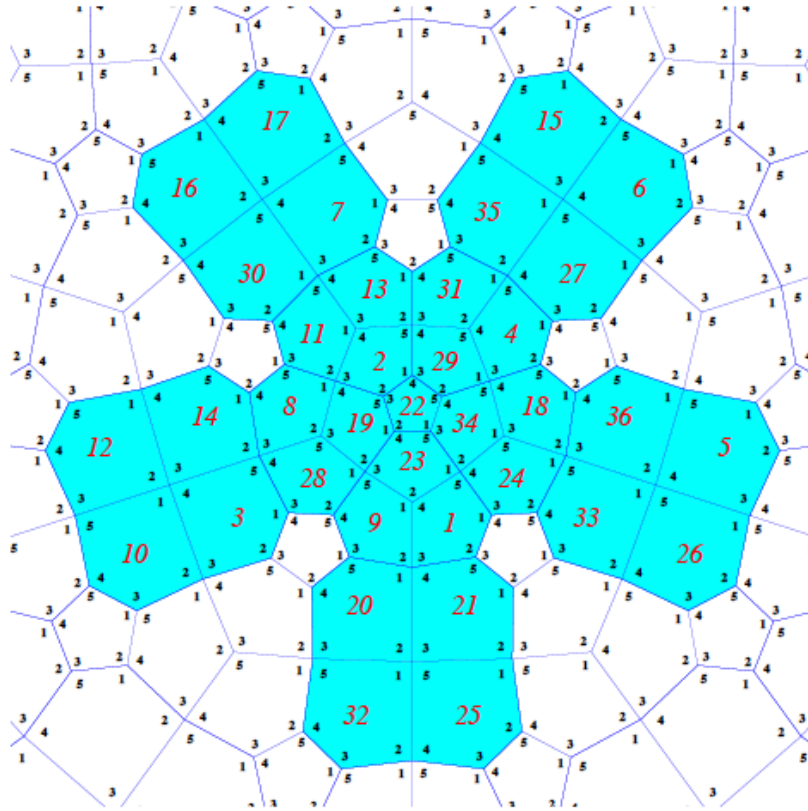

...”

The Pentagonal Sector Vertex Configurations are Collared Tiles:

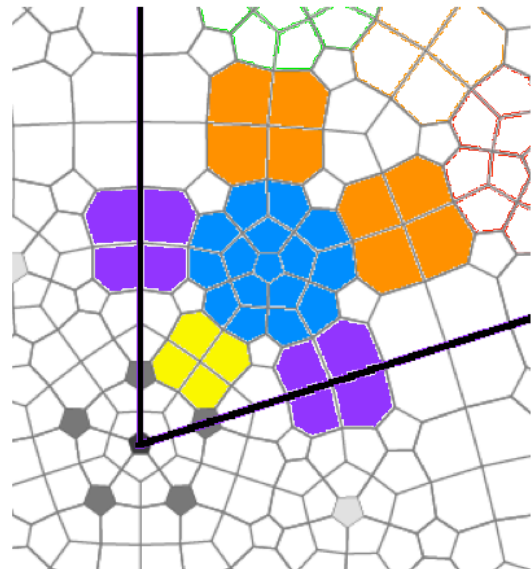
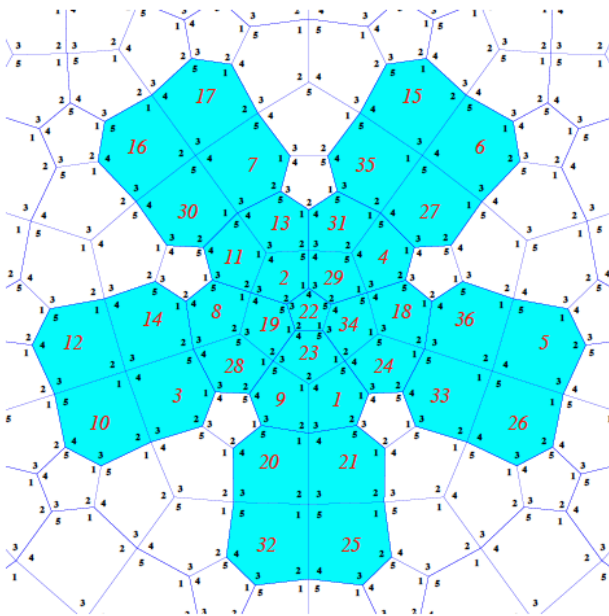

Outer Automorphisms Triality, Connectors, and Bohm Quantum Potential

Raymond Ascheim asked
about physical interpretation of the remaining Tiles in a Pentagonal Sector

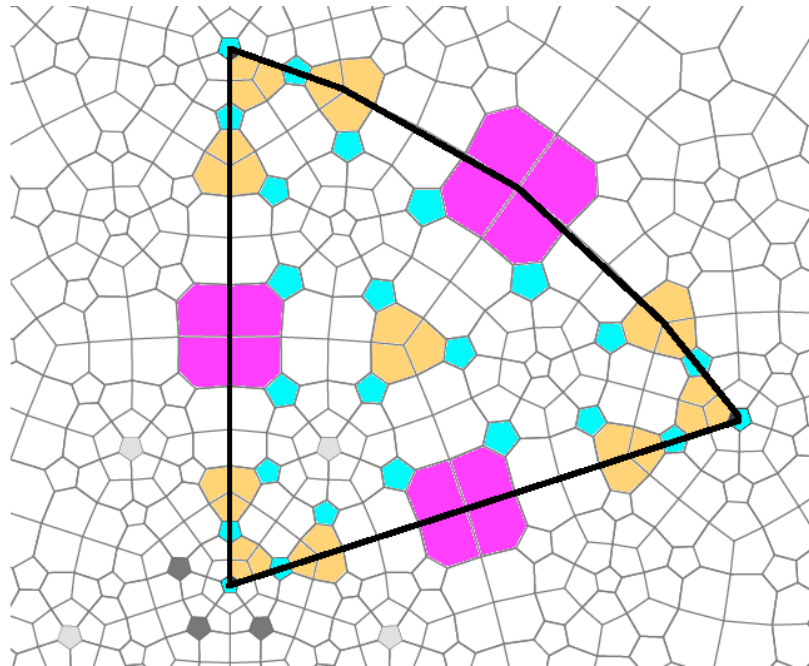

My view is that they are analogous to the Triality of $D_4 = Spin(8)$,
that is, that they represent Outer Automorphisms of the E_8 Physics Structure:

The yellow Tiles are in 3-fold configurations and are directly related to Triality
such as
the central 3 Tiles representing Triality among the 3 Pentagonal Sector Configurations.

The magenta Tiles represent
isomorphisms of pairs of Pentagonal Sector Configurations
and Connectors to pairs in adjoining Pentagonal Sectors.

The $15+9 = 24$ cyan Tiles represent the Bohm Quantum Potential in this way:
Joe Polchinski in “String Theory, Volume 1, An Introduction to the Bosonic String” said:
“... we find at $m^2 = -4/\alpha'$ the tachyon,
and at $m^2 = 0$ the 24×24 states of the graviton, dilaton, and antisymmetric tensor ...”.
In my view, the 24×24 states are represented by the 24 cyan tiles
as an Outer Automorphism - type symmetry of an E_8 Physics String Theory based on
Strings being physically interpreted as World-Lines of Particles -
see viXra 1602.0319 especially page 229 and following pages -
and the 24×24 traceless symmetric spin-2 particle that Polchinski calls “graviton”
is in reality the carrier of the Bohm Quantum Potential.

Here are some more details of how the Bohm Quantum Potential works:

In each Pentagonal Sector of the Conformal Penrose Tiling, the 72 dark gray E6 Root Vector tiles contain the projection of all 240 E8 Root Vectors (48 tiles get $4 \times 48 = 192$ E8 Root Vectors and 24 tiles get $2 \times 24 = 48$ E8 Root Vectors)

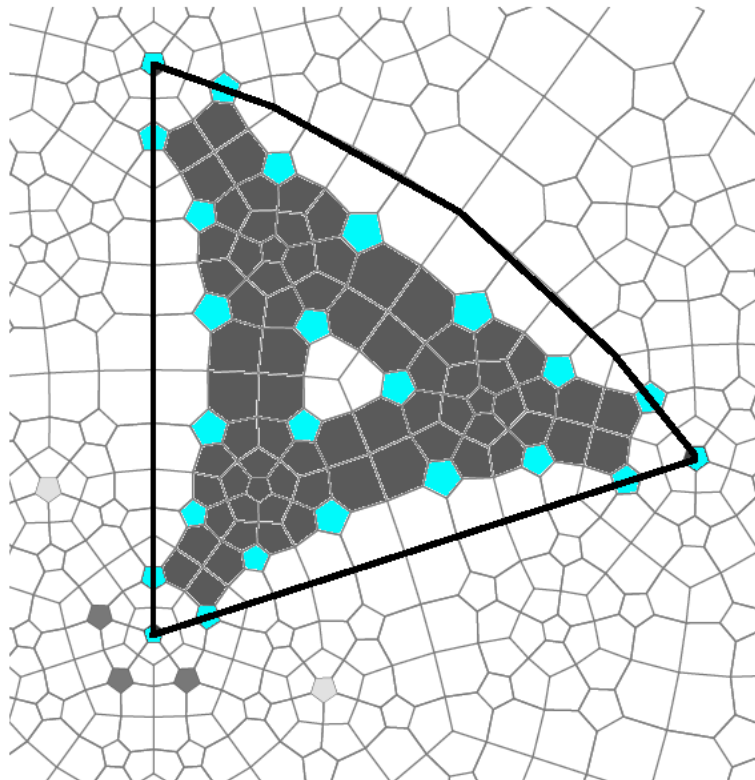

and the 24 cyan tiles represent the 24 dimensions of the Little Group subgroup of the Lorentz group of 26-dim Bosonic String Theory with Strings interpreted as World-Lines of the Particles of E8 Physics. Joe Polchinski in "String Theory, Volume 1, An Introduction to the Bosonic String" said: "... we find at $m^2 = -4 / \alpha'$ the tachyon, and at $m^2 = 0$ the 24 x 24 states of the graviton, dilaton, and antisymmetric tensor ..." with dilaton being 24x24 trace and graviton being 24x24 traceless symmetric matrices. My physical interpretation differs from Polchinski's, as I see the 24 x 24 traceless symmetric matrices as the carrier of Bohm Quantum Potential.

"... Bohm's Quantum Potential can be viewed as an internal energy of a quantum system ..." according to Dennis, de Gosson, and Hiley (arXiv 1412.5133) and Peter R. Holland says in "The Quantum Theory of Motion" (Cambridge 1993): "... the total force ... from the quantum potential ... does not ... fall off with distance ... because ... the quantum potential ... depends on the form of ...[the quantum state]... rather than ... its ... magnitude ...".

The Bohm Quantum Potential connects physical E8 Physics configurations

with each other using Resonance. Resonance is discussed by Carver Mead in "Collective Electrodynamics" (MIT 2000):

"... we can build ... a resonator from ... electric dipole ... configuration[s] ... [such as Tubulin Dimers] Any ... configuration ... couples to any other on its light cone, whether past or future. ... The total phase accumulation in a ... configuration ... is the sum of that due to its own current, and that due to currents in other ... configurations ... far away ...

The energy in a single resonator alternates between the kinetic energy of the electrons (inductance), and the potential energy of the electrons (capacitance). With the two resonators coupled, the energy shifts back and forth between the two resonators in such a way that the total energy is constant ... The conservation of energy holds despite an arbitrary separation between the resonators ... Instead of scaling linearly with the number of charges that take part in the motion, the momentum of a collective system scales as the square of the number of charges! ... it is clear that collective quantum systems do not have a classical correspondence limit. ...".

The Bohm Quantum Potential interacts between two Pentagonal Sectors by 24 Bohm Carrier Tiles of one Pentagonal Sector carrying E8 Configuration Information and comparing it with 24 Bohm Carrier Tiles of the Other Sector carrying E8 Configuration Information. If the resulting 24 x 24 Matrix shows that the two E8 Configurations are similar, then a Bohm Quantum Potential Resonant Connection is established.

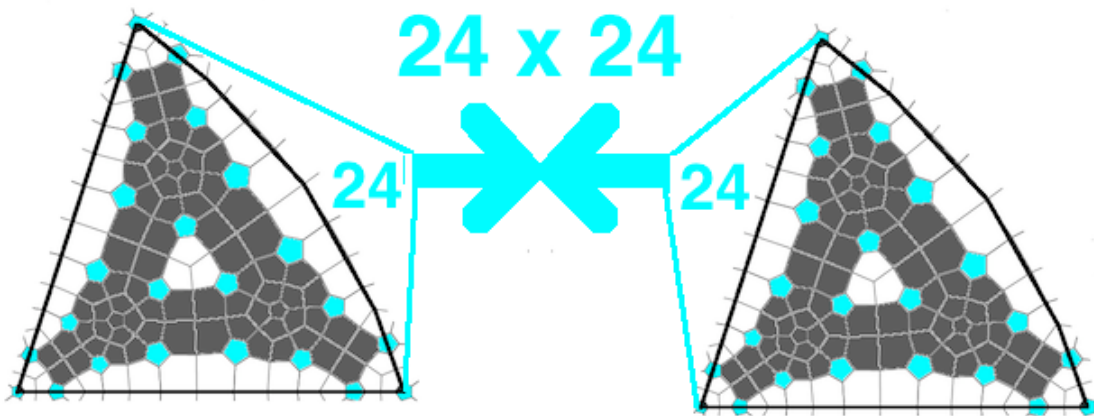

The Bohm Quantum Potential 24x24 Matrix is traceless because Configuration Resonance is sensitive to similarity rather than dilation scale and is symmetric because Configuration Resonance is symmetric between Sectors.

Hydrogen Atom

Klee Irwin (quantumgravityresearch.org) has the idea that Penrose Tiling can encode the Hydrogen Spectrum, such as the Lyman series, using the STAR Penrose Tiling

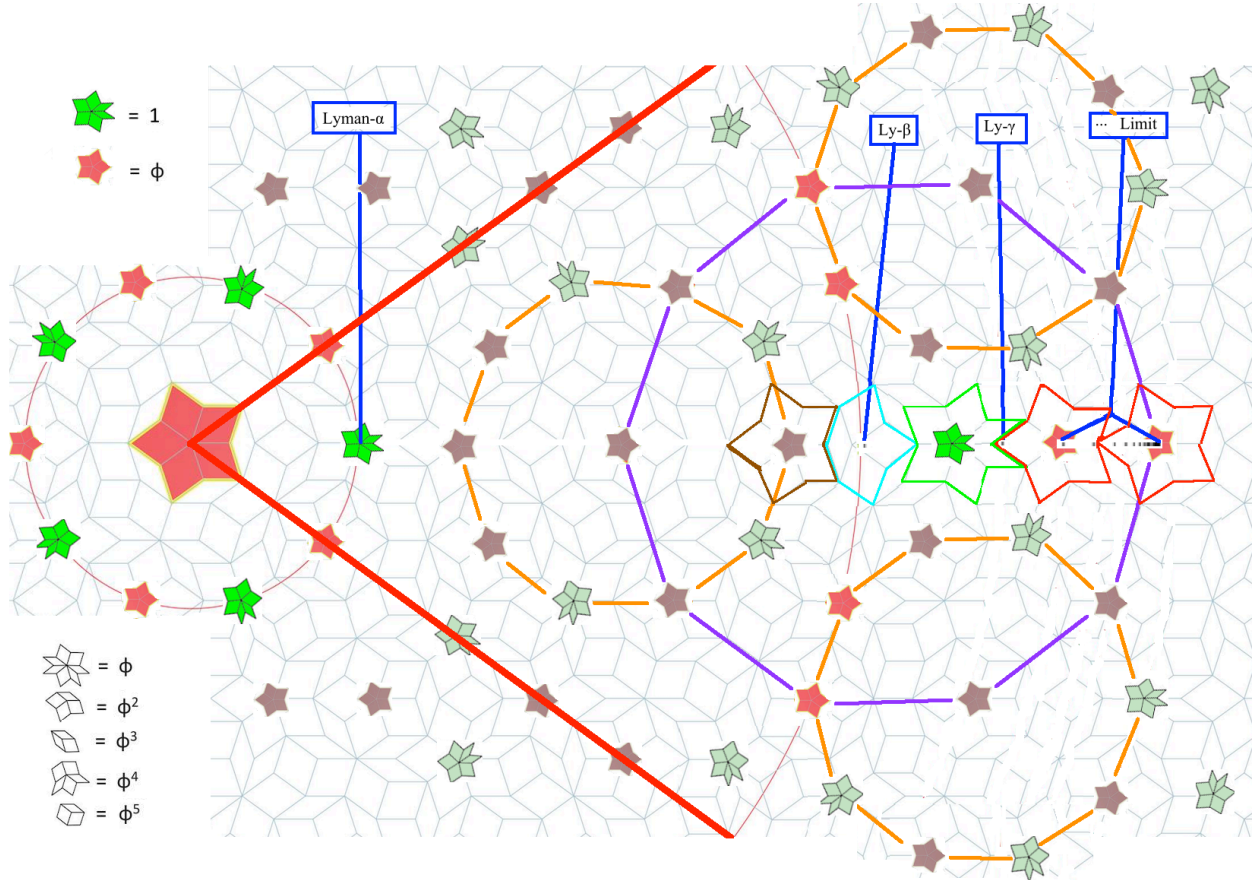

The relationship of the Hydrogen Lyman spectrum to the STAR Penrose Tiling may be explained by the facts that the pattern of the STAR Penrose Tiling is very similar to that of the Conformal Penrose Tiling

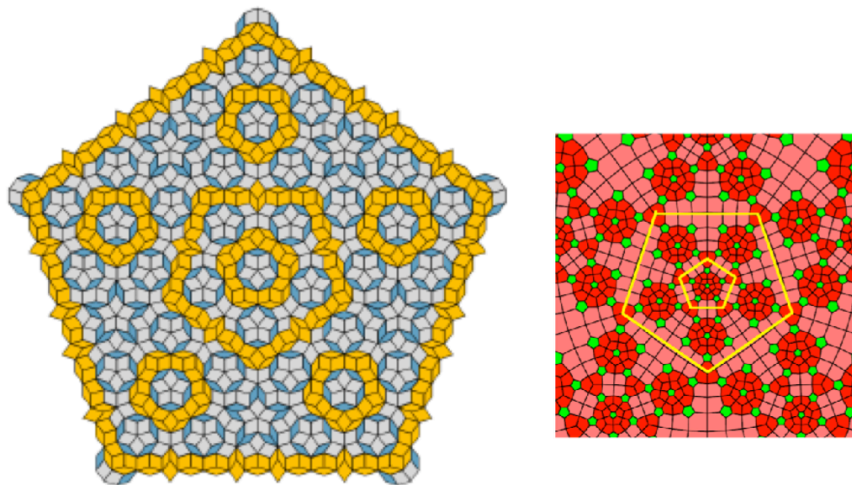

and that the Conformal Group is the symmetry group of the Hydrogen Atom.

Appendix - Tetrahedra and E8 Physics

The simplest polyhedron in 3-dim Flat Space is the Tetrahedron. You can combine Tetrahedra in 3-dim Flat Space but to avoid gaps in the combined structure you must curve 3-dim Space and effectively go to 4-dim Space to build 600-cell $\{3,3,5\}$ polytopes two of which can be combined to produce the 240-polytope that leads to the 8-dim Gossett polytope of the E8 Lie Algebra of $Cl(16)$ -E8 Physics whose AQFT therefore corresponds to a 4D Feynman Checkerboard Quantum Theory constructed with Tetrahedra-based structures.

If you do not curve the 3-dim space, there are two possibly useful structures:

Tetrahedral Clusters whose Periodicity corresponds to that of Real Clifford Algebras giving a correspondence with the AQFT of $Cl(16)$ -E8 Physics

QuasiCrystals and their Approximants whose phason disorder seems to be a measure of an information deficit, and failure of equivalence, with respect to $Cl(16)$ -E8 Physics.

The Wikipedia entry on the 600-cell says:

“... the 600-cell ... is the convex regular polytope ... $\{3,3,5\}$. Its boundary is composed of 600 tetrahedral cells with 20 meeting at each vertex ... they form 1200 triangular faces, 720 edges, and 120 vertices. The edges form 72 flat regular decagons. Each vertex of the 600-cell is a vertex of six such decagons. ... Its vertex figure is an icosahedron ... It has a dihedral angle of 164.48 degrees. ...

Each cell touches, in some manner, 56 other cells.

[$4+1 = 5$] One cell contacts each of the four faces;



[

$2 \times 6 + 5 = 17$] two cells contact each of the six edges, but not a face;



[

$10 \times 4 + 17 = 57$] and ten cells contact each of the four vertices, but not a face or edge.



[

] ...

This image shows the 600-cell in cell-first perspective projection into 3D. ...

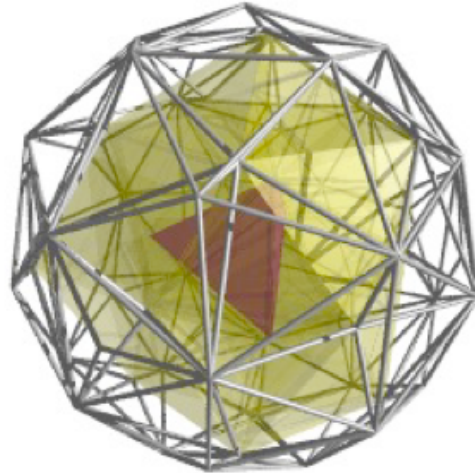

... The nearest cell to the 4d viewpoint is rendered in solid color, lying at the center of the projection image. The cells surrounding it (sharing at least 1 vertex) are rendered in transparent yellow. [They are a 57G Maximal Contact Grouping] The remaining cells are rendered in edge-outline. Cells facing away from the 4D viewpoint have been culled for clarity. ...”.

Sections of 600-cell

Sadoc and Mosseri in their book “Geometrical Frustration” (Cambridge 1999, 2006), say: “...

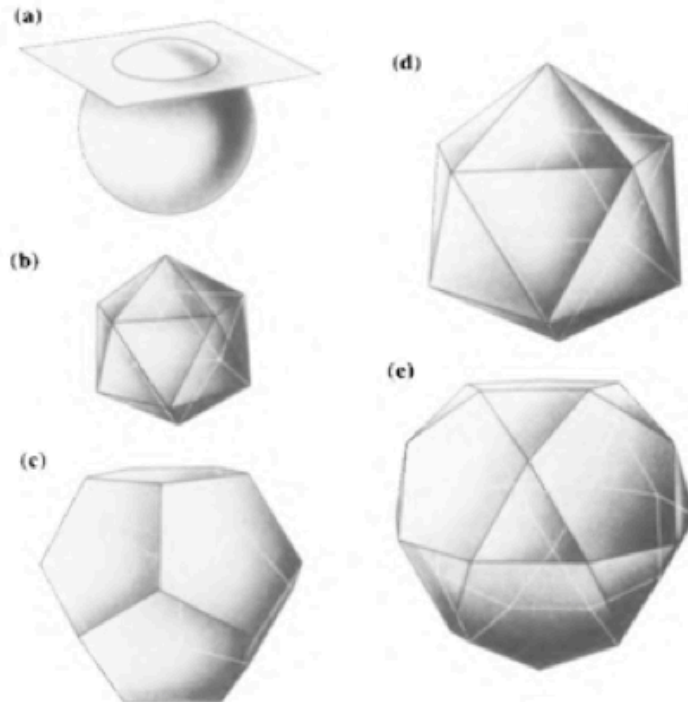

Fig. A5.1. The $\{3, 3, 5\}$ polytope. Different flat sections in S^3 (with one site on top) give the following successive shells; (a) an icosahedral shell formed by the first 12 neighbours, (b) a dodecahedral shell, (c) a second and larger icosahedral shell, (d) an icosidodecahedral shell on the equatorial sphere. Then other shells are symmetrically disposed in the second ‘south’ hemi-hypersphere, relative to the equatorial sphere (e).

- $\omega = \pi/2$: the 'equatorial' sphere is tiled by 30 vertices which form a regular icosidodecahedron. For larger values of ω , the situation is then symmetrical with respect to the equatorial sphere.
- $\omega = 3\pi/5$: an icosahedron.
- $\omega = 2\pi/3$: a dodecahedron.
- $\omega = 4\pi/5$: an icosahedron.
- $\omega = \pi$: one vertex at the south pole $x_0 = -R, x_1 = x_2 = x_3 = 0$.

Table A5.1. Sections of the {3, 3, 5} polytope (with an edge length equal to $2\tau^{-1}$) beginning with a vertex

Section	x_0	$(x_1, x_2, x_3)^{\dagger}$	Vertex number	Shape
0	2	(0, 0, 0)	1	point
1	τ	(1, 0, τ^{-1})	12	icosahedron
2	1	(1, 1, 1)	20	dodecahedron
		($\tau, \tau^{-1}, 0$)		
3	τ^{-1}	($\tau, 0, 1$)	12	icosahedron
4	0	(2, 0, 0)	30	icosidodecahedron
		($\tau, 1, \tau^{-1}$)		
5	$-\tau^{-1}$	($\tau, 0, 1$)	12	icosahedron
6	-1	(1, 1, 1)	20	dodecahedron
		($\tau, \tau^{-1}, 0$)		
7	$-\tau$	(1, 0, τ^{-1})	12	icosahedron
8	-2	(0, 0, 0)	1	point

[†]Cyclic permutation with all possible changes of signs. $\tau = (1 + \sqrt{5})/2$.

... Another ... description consists of fixing a polytope cell center at the north pole ...

Table A5.2. Section of the {3, 3, 5} polytope (edge length $2\tau^{-1}\sqrt{2}$) beginning with a cell

Section	x_0	(x_1, x_2, x_3)	Vertex number	Shape
0	τ^2	($\tau^{-1}, \tau - 1, \tau^{-1}$) [†]	4	tetrahedron
1	$\sqrt{5}$	(-1, 1, 1)	4	tetrahedron
2	2	(2, 0, 0)	6	octahedron
3	τ	(τ, τ, τ^{-2})	12	distorted
4	1	($\sqrt{5}, 1, 1$)	12	cubo-octahedron
5	τ^{-1}	($\tau^2, \tau^{-1}, \tau^{-1}$)	12	
6	τ^{-2}	(τ, τ, τ)	4	tetrahedron
7	0	(2, 2, 0)	12	cubo-octahedron
8	$-\tau^{-2}$	($-\tau, \tau, \tau$)	4	tetrahedron
—	—	—	—	—
14	$-\tau^2$	($-\tau^{-1}, \tau^{-1}, \tau^{-1}$)	4	tetrahedron

[†]Permutation with an even number of sign changes. $\tau = (1 + \sqrt{5})/2$. Distorted cubo-octahedra are such that their square faces are changed into golden rectangles.

...”

At the north pole and its antipodal south pole are Maximal Contact Groupings (57G) with 4+4+6+12 = 26 vertices.

Conformal Gravity 600-Cell with M4 Physical SpaceTime

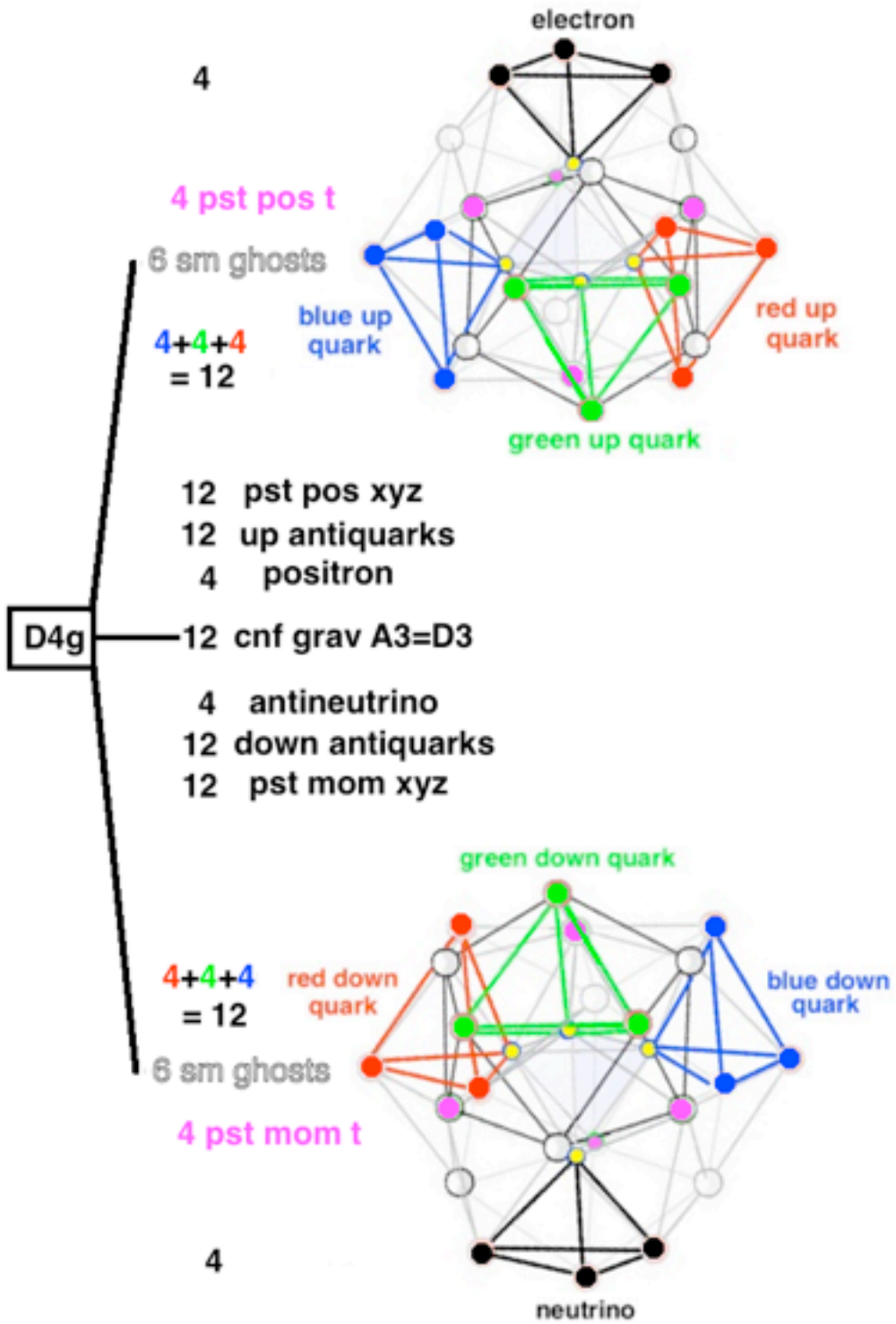

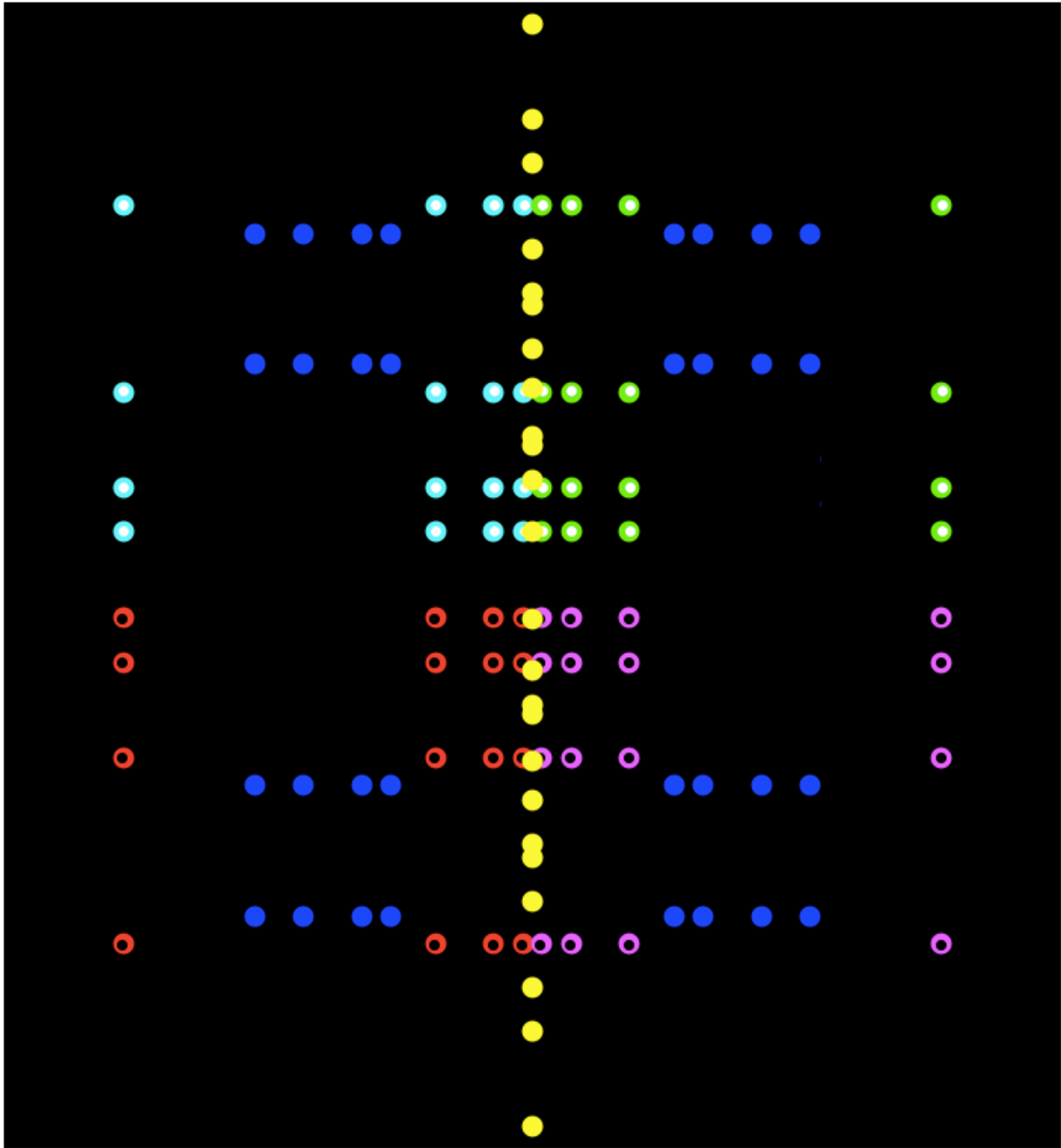

120 E8 Root Vectors of 600-cell for M4 and Gravity + Dark Energy

Standard Model 600-Cell with CP2 Internal Symmetry Space

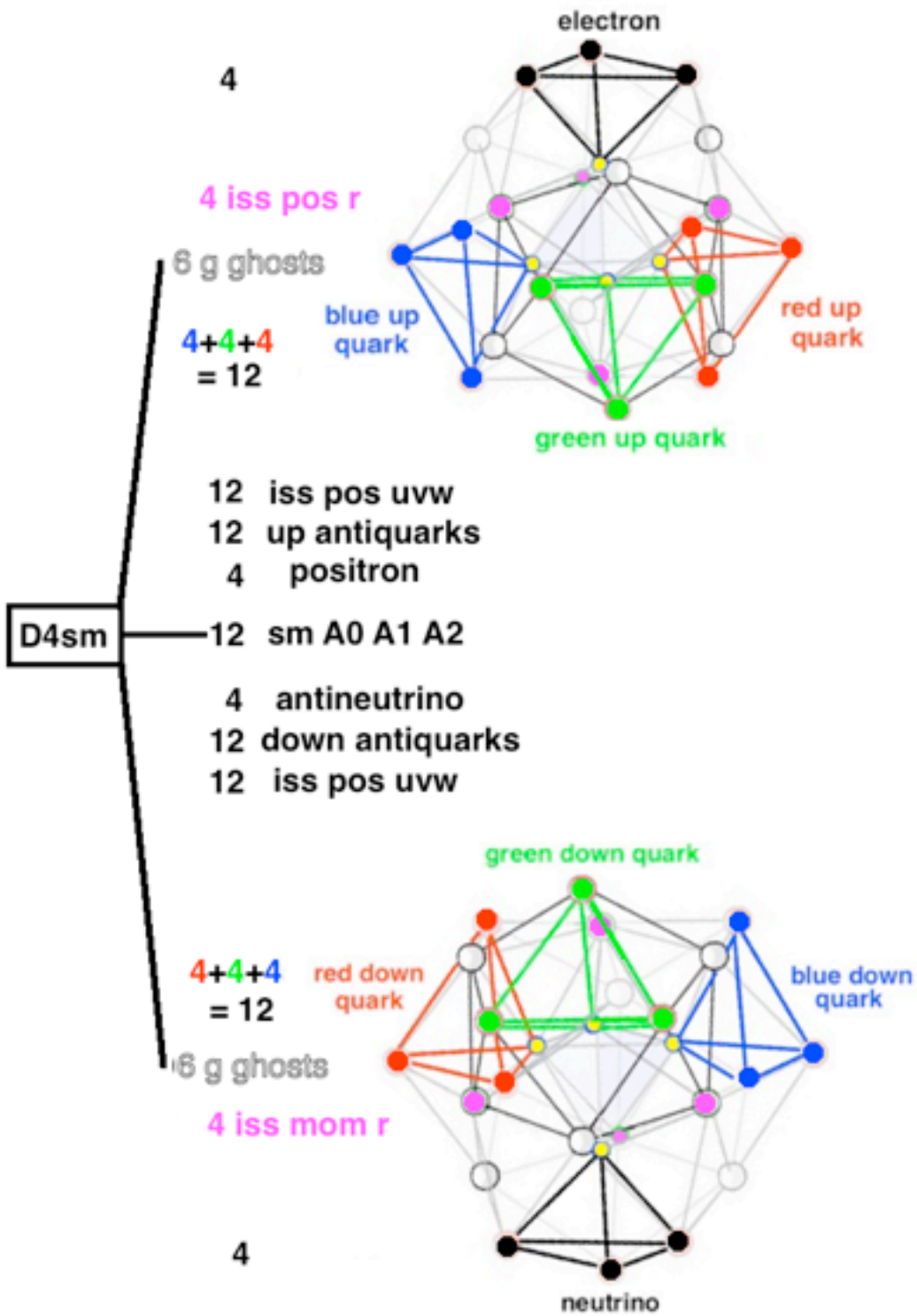

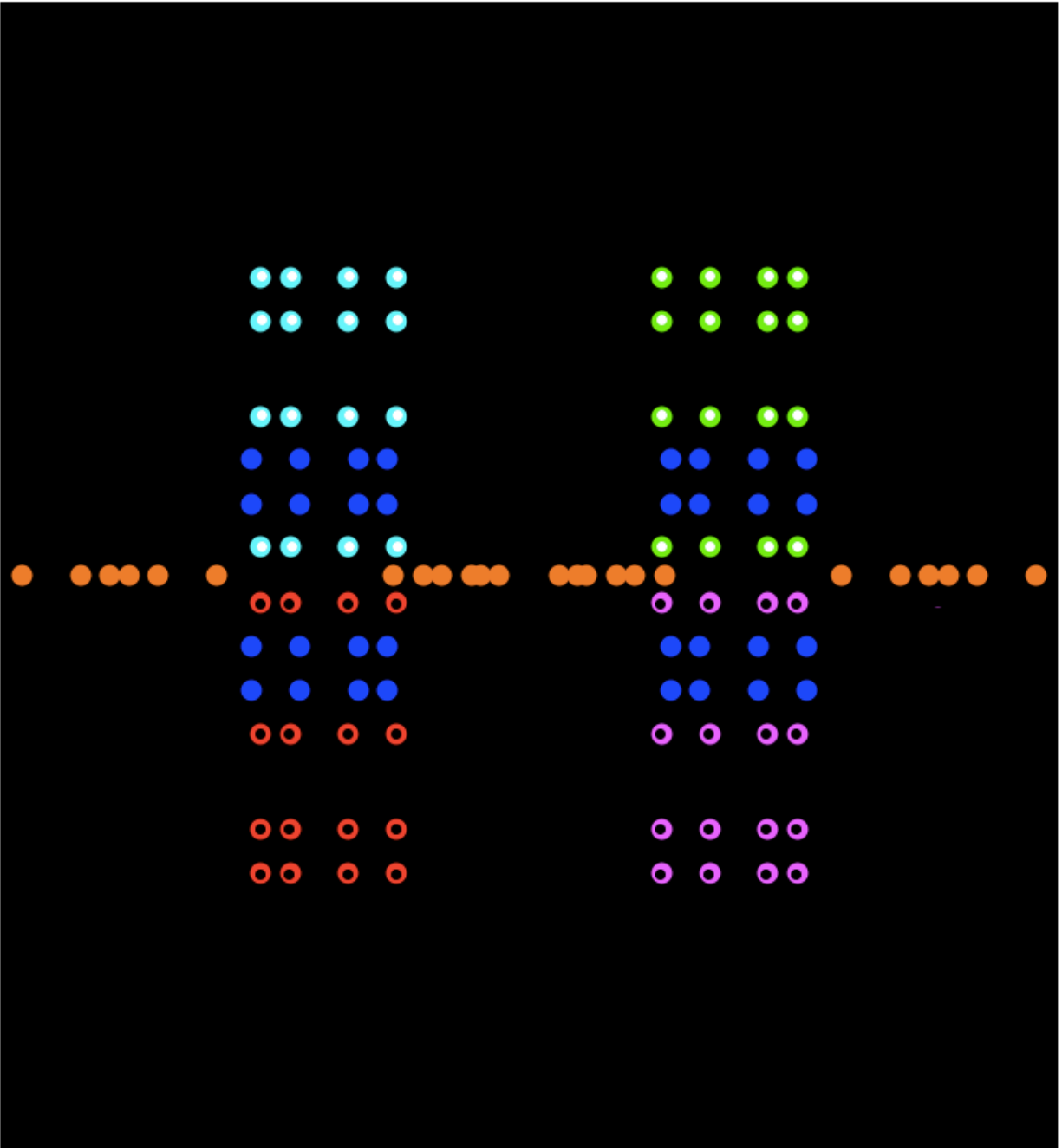

120 E8 Root Vectors of 600-cell for CP2 and Standard Model

The 57G - 600-cell - 240 E8 construction with tetrahedra requires the initial flat 3-dim space to be curved

What happens if you require the 3-dim space to remain flat ?

If you construct with (exactly regular) tetrahedra in 3-dim space that remains flat that is like making a tetrahedral dense packing of flat 3-dim space.

The densest such packing now known is described by Chen, Engel, and Glotzer in arXiv 1001.0586 :

“... We present the densest known packing of regular tetrahedra with density $\Phi = 4000 / 4671 = 0.856347 \dots$

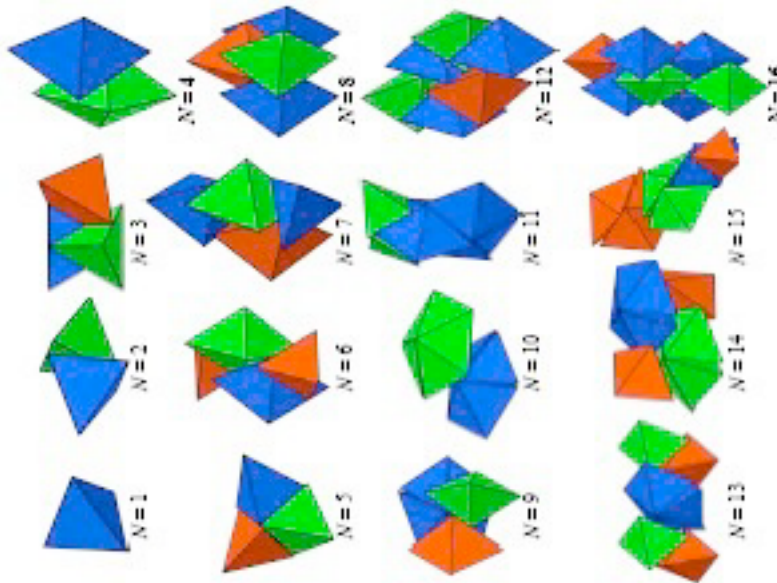

... The dimer structures are remarkable in the relative simplicity of the 4-tetrahedron unit cell as compared to the 82-tetrahedron unit cell of the quasicrystal approximant, whose density is only slightly less than that of the densest dimer packing.

The dodecagonal quasicrystal is the only ordered phase observed to form from random initial configurations of large collections of tetrahedra at moderate densities. It is thus interesting to note that for some certain values of N, when the small systems do not form the dimer lattice packing, they instead prefer clusters (motifs) present in the quasicrystal and its approximant, predominantly pentagonal dipyramids. This suggests that the two types of packings - the dimer crystal and the quasicrystal/ approximant - may compete, raising interesting questions about the relative stability of the two very different structures at finite pressure. ...”.

If you regard a Tetrahedron as a pair of Binary Dipoles



then the Chen - Engel - Glotzer high (0.85+) density configurations have the same 8-periodicity property as the Real Clifford Algebras:

#Binary Dipoles M	Maximum Density		Success Rate	Motifs, Structural Description
	Numerical, $\hat{\phi}$	Analytical, ϕ		
2	0.367346	18/49	100%	1 monomer [11]
4	0.719486	ϕ_2	100%	2 monomers, transitive [22]
6	0.666665	2/3	21%	3 monomers, three-fold symmetric
8	0.856347	4000/4671	80%	2 dimers (positive + negative)
10	0.748096	ϕ_5	22%	1 pentamer, asymmetric
12	0.764058	ϕ_6	11%	2 dimers + 2 monomers
14	0.749304	3500/4671	15%	2 x 2 dimers minus 1 monomer
16	0.856347	4000/4671	44%	2 x 2 dimers, identical to $N = 4$
18	0.766081		—	1 pentagonal dipyrmaid + 2 dimers
20	0.829282	ϕ_{10}	2%	2 pentagonal dipyrmaids
22	0.794604		—	1 nonamer + 2 monomers
24	0.856347	4000/4671	3%	3 x 2 dimers, identical to $N = 4$
26	0.788728		4%	1 pentagonal dipyrmaid + 4 dimers
28	0.816834		3%	2 pentagonal dipyrmaids + 2 dimers
30	0.788693		—	Disordered, non-optimal
32	0.856342	4000/4671	< 1%	4 x 2 dimers, identical to $N = 4$
⋮	⋮			⋮
164x8	0.850267			Quasicrystal approximant [21]

The Binary Pair of one Tetrahedron corresponds to the Cl(2) Real Clifford Algebra, isomorphic to the Quaternions, with graded structure 1+2+1.

The 4 Binary Pairs of 4 Tetrahedra (2 Dimers) correspond to Cl(2x4) = Cl(8).

The Large N Limit of 4N Tetra Clusters =

= Completion of Union of All 4N Tetra Clusters would correspond to the same generalized Hyperfinite II₁ von Neumann factor of Cl(16)-E8 Physics that gives a natural Algebraic Quantum Field Theory structure.

Geometrically $E_8 = Cl(16)$ half-spinors + $Cl(16)$ BiVectors

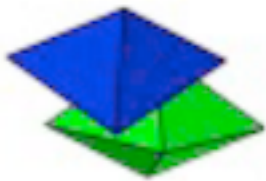

represents $Cl(8)$ Clifford Algebra Vectors and Half-Spinors



represents $Cl(16)$ Vectors

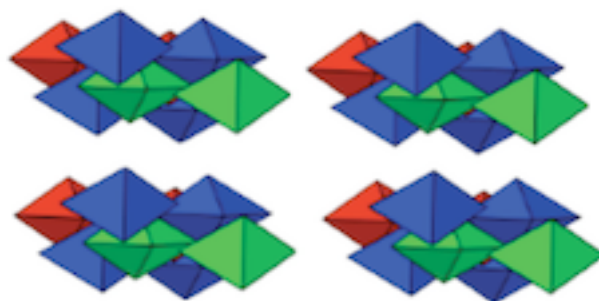

represents $Cl(16)$ half-spinors

What about the QuasiCrystal / approximant in flat 3-dim space ?

Haji-Akbari¹, Engel, Keys, Zheng, Petschek, Palffy-Muhoray, and Glotzer in arXiv 1012.5138 say: "... a fluid of hard tetrahedra undergoes a first-order phase transition to a dodecagonal quasicrystal, which can be compressed to a packing fraction of $\phi = 0.8324$. By compressing a crystalline approximant of the quasicrystal, the highest packing fraction we obtain is $\phi = 0.8503$.

...

To obtain dense packings of hard regular tetrahedra, we carry out Monte-Carlo (MC) simulations ... of a small system with 512 tetrahedra and a large system with 4096 tetrahedra. ... The large system undergoes a first order transition on compression of the fluid phase and forms a quasicrystal. ...

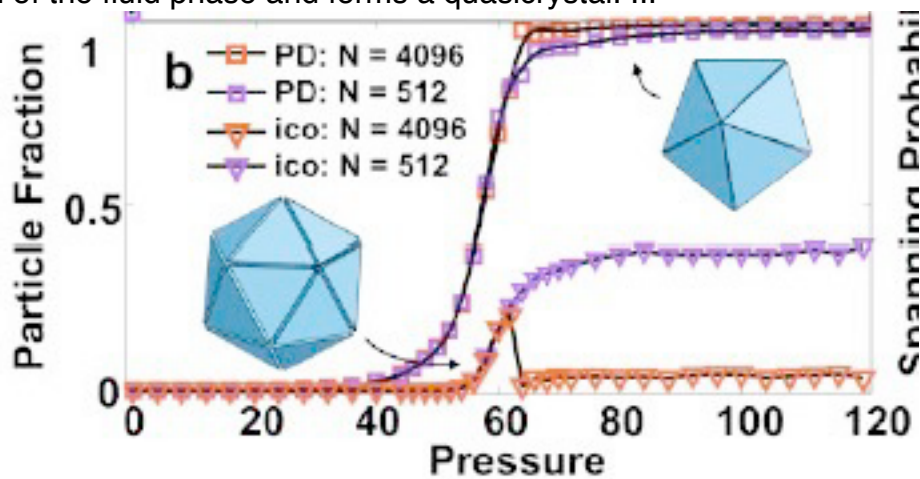

... the quasicrystal consists of a periodic stack of corrugated layers ... Recurring motifs are rings of twelve tetrahedra that are stacked periodically to form "logs"...

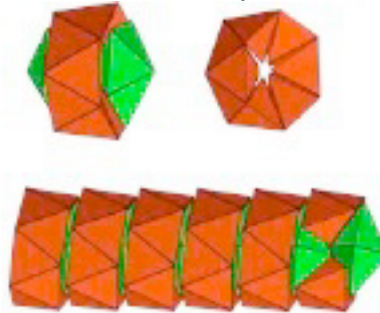

... Perfect quasicrystals are aperiodic while extending to infinity; they therefore cannot be realized in experiments or simulations, which are, by necessity, finite. ...

Quasicrystal approximants are periodic crystals with local tiling structure identical to that in the quasicrystal. Since they are closely related, and they are often observed in experiments, we consider them as candidates for dense packings.

The dodecagonal approximant with the smallest unit cell (space group) has 82 tetrahedra ...

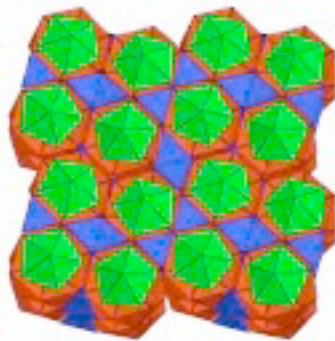

... At each vertex we see the logs of twelve-member rings (shown in red) capped by single PDs (green). The logs pack well into squares and triangles with additional, intermediary tetrahedra (blue). The vertex configuration of the tiling is ...

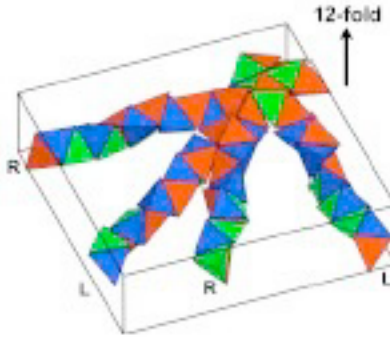

... ”

The QuasiCrystal approximant is not as dense as the 4N Tetra Cluster packing, so I do not think it is as useful for fundamental physics as the 4N Tetra packing.

The true QuasiCrystal is less dense than the QuasiCrystal approximant, so I regard it as being less useful for fundamental physics. However, as Sadoc and Mosseri say in their book “Geometrical Frustration” (Cambridge 2005) “... quasiperiodic structures [can be] derived from the eight-dimensional lattice E8. ... using the cut and project method, it is possible to generate a four-dimensional quasicrystal having the symmetry of the [600-cell] polytope {3,3,5} ... a shell-by-shell analysis ... recalls in some respects ... the Fibonacci chain ...

Table A9.1. *Number of vertices on shells surrounding the origin in the E8 lattice. The first shell is a Gosset polytope in eight dimensions*

N	Squared radius r^2	Vertices on E8 shell
1	1/2	240
2	1	2160
3	3/2	6720

...

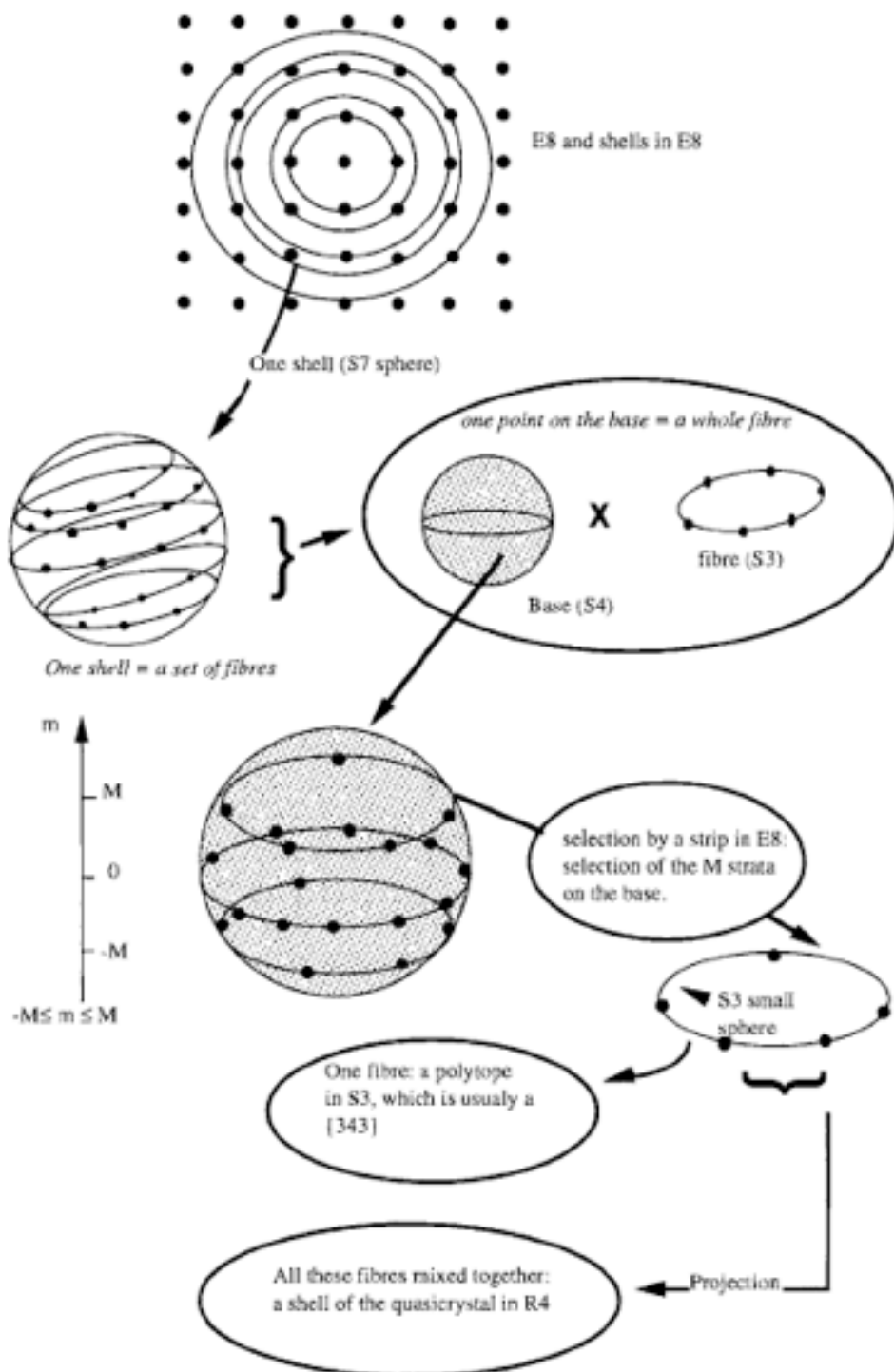

Fig. A9.1. Scheme summarizing the four-dimensional construction method: take an E_8 shell, considered as a discrete fibration of S^7 , select the fibres which map (H-map) onto a stratum M of the base of the fibration, and finally orthogonally map (O-map) the selected sites onto R^4 .

The relationship between QuasiCrystals and QuasiCrystal approximants is discussed by An Pang Tsai in an IOP review “Icosahedral clusters, icosahedral order and stability of quasicrystals - a view of metallurgy”:

“... we overview the stability of quasicrystals ... in relation to phason disorder ... the phonon variable leads to long wavelength and low energy distortion of crystals, the phason variable in quasicrystals leads to a ... type of distortion ...

Let a two-dimensional lattice points sit at the corners of squares in a grid.

... a strip with a slope of an irrational number ... golden mean ... is ... a Fibonacci sequence and is exactly a one-dimensional quasicrystal ...

... [if] the slope of the strip is ... a rational number ... [it]... is a periodic sequence ... [and]... is called an approximant ...

in the approximant where the sequence changes by a flip ... This flip is called phason flip ... a flipping of tiles in two-dimensions or three-dimensions ...

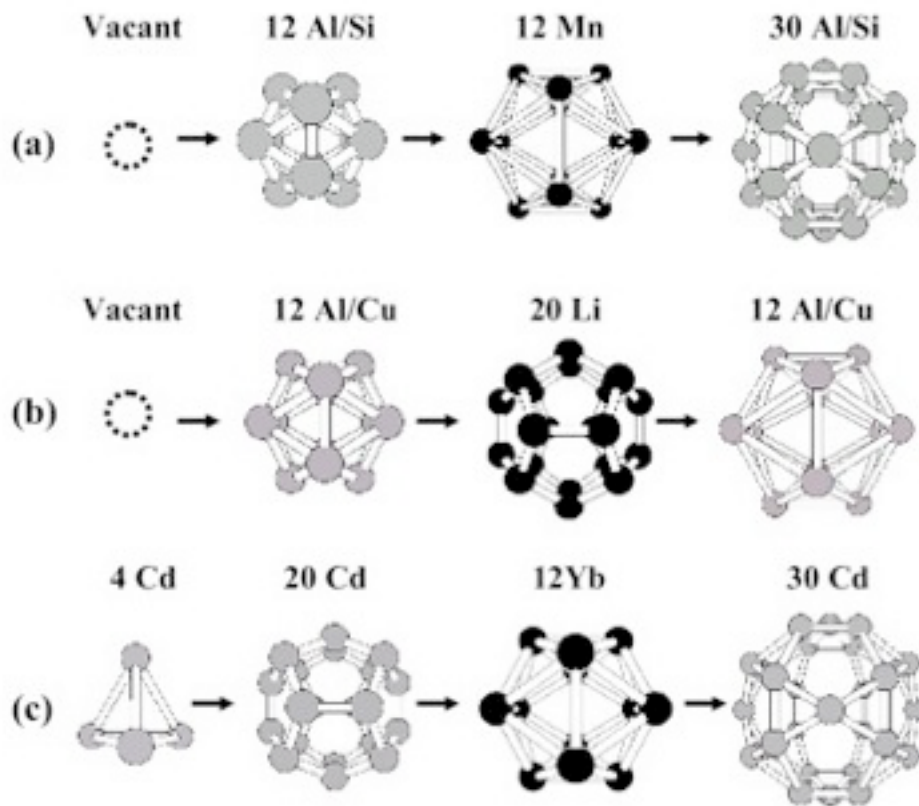

Figure 3. Concentric structures of three types of icosahedral clusters derived from three $1/1$ approximants of quasicrystals. (a) The Al-Mn-Si class or Mackay icosahedral cluster: the center is vacant, the 1st shell is an Al/Si icosahedron, the 2nd shell is a Mn icosahedron, and the 3rd shell is an Al/Si icosidodecahedron. (b) The Zn-Mg-Al class or Bergman cluster: an example is R_3Al_2Cu : the center is vacant, the 1st shell is an Al/Cu icosahedron, the 2nd shell is a Li dodecahedron, the 3rd shell is a larger Al/Cu icosahedron. (c) The Cd-Yb class: the center is a Cd tetrahedron, the 1st shell is a Cd dodecahedron, the 2nd shell is a Yb icosahedron, and the 3rd shell is a Cd icosidodecahedron.

... ‘phason strain’ ... is the characteristic disorder for quasicrystals but does not exist in crystals ...

a fully annealed stable iQc [icosahedral quasicrystal]...

is almost free of phason disorder ...”.

(* Content-type: application/vnd.wolfram.cdf.text *)

(*** Wolfram CDF File ***)

(* <http://www.wolfram.com/cdf> *)

(* CreatedBy='Mathematica 10.2' *)

```
(*****  
(*  
(* The Mathematica License under which this file was created prohibits *)  
(* restricting third parties in receipt of this file from republishing *)  
(* or redistributing it by any means, including but not limited to *)  
(* rights management or terms of use, without the express consent of *)  
(* Wolfram Research, Inc. For additional information concerning CDF *)  
(* licensing and redistribution see: *)  
(*  
(* www.wolfram.com/cdf/adopting-cdf/licensing-options.html *)  
(*  
(*****)
```

(*CacheID: 234*)

(* Internal cache information:

NotebookFileLineBreakTest

NotebookFileLineBreakTest

NotebookDataPosition[1064, 20]

NotebookDataLength[10024, 246]

NotebookOptionsPosition[10582, 241]

NotebookOutlinePosition[11028, 261]

CellTagsIndexPosition[10985, 258]

WindowFrame->Normal*)

(* Beginning of Notebook Content *)

Notebook[{

Cell[BoxData[

TagBox[

StyleBox[

DynamicModuleBox[{\$CellContext`pr\$\$ = "Eigen", \$CellContext`tr\$\$ = "Eigen",

Typeset`show\$\$ = True, Typeset`bookmarkList\$\$ = {},

Typeset`bookmarkMode\$\$ = "Menu", Typeset`animator\$\$, Typeset`animvar\$\$ =

1, Typeset`name\$\$ = "\"untitled\"", Typeset`specs\$\$ = {{{

Hold[\$CellContext`pr\$\$], "Eigen", "Projection:"}, {

"Eigen", "D8-8", "30"}}, {{

Hold[\$CellContext`tr\$\$], "Eigen", "Trit"}, {

"Eigen", "D8-8", "Garrett", "9D"}}, Typeset`size\$\$ = {

703., {435.134033203125, 440.865966796875}}, Typeset`update\$\$ = 0,

Typeset`initDone\$\$, Typeset`skipInitDone\$\$ =

```

False, $CellContext`pr$6796$$ = 0, $CellContext`tr$6797$$ = 0},
DynamicBox[Manipulate`ManipulateBoxes[
1, StandardForm,
"Variables" :> {$CellContext`pr$$ = "Eigen", $CellContext`tr$$ =
"Eigen"}, "ControllerVariables" :> {
Hold[$CellContext`pr$$, $CellContext`pr$6796$$, 0],
Hold[$CellContext`tr$$, $CellContext`tr$6797$$, 0]},
"OtherVariables" :> {
Typeset`show$$, Typeset`bookmarkList$$, Typeset`bookmarkMode$$,
Typeset`animator$$, Typeset`animvar$$, Typeset`name$$,
Typeset`specs$$, Typeset`size$$, Typeset`update$$, Typeset`initDone$$,
Typeset`skiplnitDone$$},
"Body" :> ($CellContext`vp =
If[$CellContext`pr$$ == "Eigen", {$CellContext`v1e, $CellContext`v2e},

If[$CellContext`pr$$ ==
"D8-8", {$CellContext`v1q, $CellContext`v2q},

If[$CellContext`pr$$ ==
"30", {$CellContext`v1q30, $CellContext`v2q30}, \
{$CellContext`v1q30, $CellContext`v2q30}]]]; $CellContext`vt =
If[$CellContext`tr$$ == "Eigen", {$CellContext`v1e, $CellContext`v2e},

If[$CellContext`tr$$ ==
"D8-8", {$CellContext`v1q, $CellContext`v2q},

If[$CellContext`tr$$ ==
"30", {$CellContext`v1q30, $CellContext`v2q30}, \
{$CellContext`v1q30, $CellContext`v2q30}]]]; $CellContext`pt[
Pattern[$CellContext`i,
Blank[]]] := {
Dot[
Part[$CellContext`gosset, $CellContext`i],
Part[$CellContext`vp, 1]],
Dot[
Part[$CellContext`gosset, $CellContext`i],
Part[$CellContext`vp, 2]]; $CellContext`ftrit[
Pattern[$CellContext`i$,
Blank[]]] := If[$CellContext`tr$$ == "9D",
$CellContext`trit9[$CellContext`i$],
If[
MemberQ[
Part[$CellContext`gosset, $CellContext`i$], 0], 0,
If[$CellContext`tr$$ == "Garrett",
If[
EvenQ[

```

```

Length[
  Select[
    Part[$CellContext`gosset, $CellContext`i$,
      Span[1, 4]], # < 0 & ]], 2, 1],
If[Dot[
  Part[$CellContext`vt, 2],
  Part[$CellContext`gosset, $CellContext`i$] < 0, 2, 1]]];
Column[{
  Dynamic[
    MouseAnnotation[],
    Graphics[{PointSize -> 0.02,
      Table[{
        $CellContext`color[$CellContext`i], PointSize -> 0.02,
        Annotation[
          Point[
            $CellContext`pt[$CellContext`i]],
            $CellContext`info[$CellContext`i], "Mouse"],

        If[$CellContext`ftrit[$CellContext`i] == 1, {
          PointSize -> 0.01, White,
          Point[{0.005, 0.005} + $CellContext`pt[$CellContext`i]]}],

        If[$CellContext`ftrit[$CellContext`i] == 2, {
          PointSize -> 0.01, Black,

          Point[-{0.005,
            0.005} + $CellContext`pt[$CellContext`i]]}], \
{$CellContext`i,
      Length[$CellContext`gosset]]], Background -> Black, ImageSize ->
700],
StringJoin[
  "{\!\(\^*OverscriptBox[\(x\), \
\(\[RightVector]\)\)\),\!\(\^*OverscriptBox[\(y\), \(\[RightVector]\)\)\)}= ",
  ToString[$CellContext`vp]], ItemSize -> {{50, 1}, {7, 10}}],
"Specifications" -> {{{$CellContext`pr$$, "Eigen", "Projection:"}, {
  "Eigen", "D8-8", "30"}}, {{$CellContext`tr$$, "Eigen", "Trit"}, {
  "Eigen", "D8-8", "Garrett", "9D"}}, "Options" -> {},
"DefaultOptions" -> {},
ImageSizeCache->{748., {491., 496.}},
SingleEvaluation->True],
Deinitialization:>None,
DynamicModuleValues:>{},
Initialization:>(($CellContext`gosset = Join[
  Map[# - (1/2) Table[1, 8]& ,
  Select[
    (IntegerDigits[#, 2, 8]& ) [

```

```

Range[256]], EvenQ[
Total[#]& ]],
Permutations[{1, 1, 0, 0, 0, 0, 0, 0}],
Permutations[{-1, 1, 0, 0, 0, 0, 0, 0}],
Permutations[{-1, -1, 0, 0, 0, 0, 0, 0}]; $CellContext`v1e = {
0, 0, 0, 0, 0.8270909152851995, 1.6180339887502173`,
1.3382612127178346`,
1.}; $CellContext`v2e = {-0.4158233816348866, -1.229296667789744, \
-1.9890437907365466`, -0.6728163647981475, 0, 0, 0, 0}; $CellContext`v1q =
Part[
Table[Cos[(2 $CellContext`k - 1) (Pi/16)]/2, {$CellContext`k, 8}], {
1, 3, 5, 7, 2, 4, 6, 8}]; $CellContext`v2q = Part[
Table[Sin[(2 $CellContext`k - 1) (Pi/16)]/2, {$CellContext`k, 8}], {
1, 3, 5, 7, 2, 4, 6, 8}]; $CellContext`v1q30 = {0.438217070641,
0.205187681291, 0.36459828198,
0.0124511903657, -0.0124511903657, -0.36459828198, -0.205187681291, \
-0.67645247517}; $CellContext`v2q30 = {-0.118465163028, 0.404927414852,
0.581970822973, 0.264896157496, 0.501826483552, 0.345040496917,
0.167997088796, 0.118465163028}; $CellContext`color[
Pattern[$CellContext`i,
Blank[[]]] :=
With[{$CellContext`xy = $CellContext`pt[$CellContext`i]},
If[Part[$CellContext`gosset, $CellContext`i,
Span[1, 4]] == {0, 0, 0, 0}, Orange,
If[Part[$CellContext`gosset, $CellContext`i,
Span[5, 8]] == {0, 0, 0, 0}, Yellow,
If[
MemberQ[
Part[$CellContext`gosset, $CellContext`i], 0], Blue,
If[
And[First[$CellContext`xy] > 0, Last[$CellContext`xy] > 0],
Green,
If[
And[First[$CellContext`xy] > 0, Last[$CellContext`xy] < 0],
Magenta,
If[
And[First[$CellContext`xy] < 0, Last[$CellContext`xy] > 0],
Cyan,
If[
And[First[$CellContext`xy] < 0, Last[$CellContext`xy] < 0],
Red, Gray]]]]]]]; $CellContext`omega = SparseArray[{{
Pattern[$CellContext`i,
Blank[[]], 9} -> 2, {9,
Pattern[$CellContext`i,
Blank[[]]} -> 2, {
Pattern[$CellContext`i,

```

```

Blank[],
Pattern[$CellContext`i,
  Blank[] -> 5}, {9, 9}, -1]; $CellContext`t8 =
SparseArray[{{8, 8} -> -1, {
  Pattern[$CellContext`i,
  Blank[],
  Pattern[$CellContext`i,
  Blank[] -> 1}, {9, 9}]; $CellContext`Tmrot = Transpose[
Normal[
  Dot[$CellContext`omega, $CellContext`t8]]; $CellContext`to9D[
Pattern[$CellContext`v,
  Blank[]] := Dot[
Append[$CellContext`v, 0], $CellContext`Tmrot]/6; $CellContext`to8D[

Pattern[$CellContext`v,
  Blank[]] := Most[Dot[$CellContext`v,
  Transpose[$CellContext`Tmrot]/9]; $CellContext`gtrit[
Pattern[$CellContext`i,
  Blank[]] := If[
MemberQ[
  Part[$CellContext`gosset, $CellContext`i], 0], 0,
If[
  EvenQ[
  Length[
  Select[
    Part[$CellContext`gosset, $CellContext`i,
    Span[1, 4], # < 0 & ]], 2, 1]]; $CellContext`trit9[
Pattern[$CellContext`i,
  Blank[]] := Mod[
  Part[3 $CellContext`to9D[
    Part[$CellContext`gosset, $CellContext`i], 1],
3]; $CellContext`crit8[
Pattern[$CellContext`i,
  Blank[]] :=
Part[{{Gray, White, Black}, $CellContext`gtrit[$CellContext`i] +
1]; $CellContext`crit9[
Pattern[$CellContext`i,
  Blank[]] :=
Part[{{Green, Red, Blue}, $CellContext`trit9[$CellContext`i] +
1]; $CellContext`info[
Pattern[$CellContext`i,
  Blank[]] := Row[{$CellContext`i,
$CellContext`crit8[$CellContext`i],
Part[$CellContext`gosset, $CellContext`i],
$CellContext`crit9[$CellContext`i],
$CellContext`to9D[

```

```

Part[{$CellContext`gosset, $CellContext`i}], Frame -> True,
FrameMargins -> 2, ImageSize -> {700, 40}; Null);
Typeset`initDone$$ = True),
SynchronousInitialization->True,
UndoTrackedVariables:>{Typeset`show$$, Typeset`bookmarkMode$$},
UnsavedVariables:>{Typeset`initDone$$},
UntrackedVariables:>{Typeset`size$$}, "Manipulate",
Deployed->True,
StripOnInput->False],
Manipulate`InterpretManipulate[1]], "Output"
},
WindowSize->{808, 655},
Visible->True,
ScrollingOptions->{"VerticalScrollRange"->Fit},
ShowCellBracket->Automatic,
CellContext->Notebook,
TrackCellChangeTimes->False,
FrontEndVersion->"10.2 for Mac OS X x86 (32-bit, 64-bit Kernel) (July 29, \
2015)",
StyleDefinitions->"Default.nb"
]
(* End of Notebook Content *)

(* Internal cache information *)
(*CellTagsOutline
CellTagsIndex->{}
*)
(*CellTagsIndex
CellTagsIndex->{}
*)
(*NotebookFileOutline
Notebook[{
Cell[1464, 33, 9114, 206, 1004, "Output"]
}
]
*)

(* End of internal cache information *)

(* NotebookSignature iu0ZQkt1MysE4AKOiVClquTb *)

```

Appendix - Feynman Checkerboard Quantum Theory

Conway and Sloane, in their book Sphere Packings, Lattices, and Groups (3rd edition, Springer, 1999), in chapter 4, section 7.3, pages 119-120) define a packing [where the glue vector [1] = (1/2, ... , 1/2)]

$$D+n = Dn \cup ([1] + Dn)$$

and say:

"... D+n is a lattice packing if and only if n is even.
 D+3 is the tetrahedral or diamond packing ... and
 D+4 = Z4.

When n = 8 this construction is especially important,
 the lattice **D+8 being known as E8** ...".

Therefore

$$\mathbf{E8 \text{ Lattice} = D8 \text{ Lattice} + ([1] + D8 \text{ Lattice})}$$

There are 7 independent E8 Integral Domain Lattices.

Physically, the D8 Lattice represents SpaceTime and Gauge Bosons while the ([1] + D8 Lattice) represents Fermions.

At high energies (for example, during Inflation) E8 Physics is Octonionic and there is only one generation of fermions, so the first generation is the only generation. Therefore, each charged Dirac fermion particle, and its antiparticle, correspond to one imaginary Octonion, to one associative triangle, and to one E8 lattice so each Fermion propagates in its own **E8 8D Feynman Checkerboard Lattice**:

red Down Quark red Up Quark .
green Down Quark Electron green Up Quark
blue Down Quark blue Up Quark

rD gD bD E rU gU bU

I J K E i j k

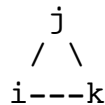

3E8 6E8 4E8 7E8 1E8 2E8 5E8

Since all the E8 lattices have in common the vertices $\{ \pm 1, \pm i, \pm j, \pm k, \pm e, \pm ie, \pm je, \pm ke \}$, all the charged Dirac fermions can interact with each other. Composite particles, such as Quark-AntiQuark mesons and 3-Quark hadrons, propagate on the common parts of the E8 lattices involved. The uncharged neutrino fermion, which corresponds to the Octonion real axis with basis $\{1\}$, propagates on the 8th Kirmse E8 Lattice that is not an independent Octonion Integral Domain.

If a preferred Quaternionic Structure is introduced into an Octonionic E8 Lattice then the Octonionic E8 Lattice is transformed into Quaternionic Lattice structure. The Quaternionic Integral Domain Lattice is the D4 Lattice.

D8 Lattice is transformed to $D4g + D4sm$

$([1] + D8 \text{ Lattice})$ is transformed to $([1] + D4g) + ([1] + D4sm)$

so

E8 is transformed to $\{ D4g + ([1] + D4g) \} + \{ D4 sm + ([1] + D4sm) \}$

$$\mathbf{E8 = D+4g + D+4sm}$$

D+4g corresponds to the 600-cell containing D4g

D+4sm corresponds to the 600-cell containing D4sm

Conway and Sloane (Sphere Packings, Lattices, and Groups - Springer) (Chapter 4, eq. 49)

give equations for the number of vertices $N(m)$ in the m -th layer

of the $D+4$ HyperDiamond lattice where d is a divisor (including 1 and m) of m :

for m odd: $N(m) = 8 \text{ SUM}(d|m) d$ for m even: $N(m) = 24 \text{ SUM}(d|m, d \text{ odd}) d$

Here are the numbers of vertices in some of the layers of the $D4+$ lattice.

The even-numbered layers correspond to the even $D4$ sublattice:

m =norm of layer	$N(m)$ =no. vert.
0	1
1	8 = 1 x 8
2	24 = 1 x 24
3	32 = (1 + 3) x 8
4	24 = 1 x 24
5	48 = (1 + 5) x 8
6	96 = (1 + 3) x 24
7	64 = (1 + 7) x 8
8	24 = 1 x 24
9	104 = (1 + 3 + 9) x 8
10	144 = (1 + 5) x 24
11	96 = (1 + 11) x 8
12	96 = (1 + 3) x 24
13	112 = (1 + 13) x 8
14	192 = (1 + 7) x 24
15	192 = (1 + 3 + 5 + 15) x 8
16	24 = 1 x 24
17	144 = (1 + 17) x 8

First Stage of 4D Feynman Checkerboard:

$D+4g$ vertices have HyperOctahedron 8 nearest-neighbors $\{+/-1, +/-i, +/-j, +/-k\}$

where 4-dim $1, i, j, k$ are descendants of 8-dim $1, i, j, k$

to be used as 4D Feynman Checkerboard Primary Links representing the 4-dim $M4$ Physical SpaceTime of the Kaluza-Klein of $E8$ Physics whose 4 basis elements are $\{1, i, j, k\}$ each of which has 8 momentum components with respect to 8-dim SpaceTime to represent $4 \times 8 = 32$ of 600-cell vertices.

$D+4g$ vertices have 24-cell 24 next-nearest neighbors representing the 12 Conformal Gravitons (Root Vectors of $U(2,2)$ and 12 Ghosts of Standard Model Gauge Bosons that live on the nearest-neighbor links and represent 24 of 600-cell vertices.

$D+4g$ vertices have 6-semi-HyperCube 32 next-next-nearest neighbors representing 4 $M4$ Physical SpaceTime components of 8 First-Generation Fermion Particles. Fermion AntiParticles are represented by Particles moving backward in Time for representation of $2 \times 32 = 64$ of 600-cell vertices.

$D+4g$ odd (1 and 3) layers correspond to Vectors and Fermion Spinors which are related by Triality.

$D+4g$ even (2) layers correspond to BiVectors.

From each vertex of the 4D Feynman Checkerboard the First Stage uses a Triad of Quantum Choice Vectors.

Second Stage of 4D Feynman Checkerboard:

D+4sm vertices have HyperOctahedron 8 nearest-neighbors $\{+/-1, +/-i, +/-j, +/-k\}$
where 4-dim $1, i, j, k$ are descendants of 8-dim E, I, J, K
to be used as 4D Feynman Checkerboard Secondary Links representing the
4-dim CP2 Internal Symmetry Space of the Kaluza-Klein of E8 Physics whose
4 basis elements are $\{1, i, j, k\}$ each of which has 8 momentum components
with respect to 8-dim SpaceTime to represent $4 \times 8 = 32$ of 600-cell vertices.

D+4sm vertices have 24-cell 24 next-nearest neighbors representing the
12 Standard Model Gauge Bosons and
12 Ghosts of Conformal Gravitons (Root Vectors of $U(2,2)$)
that live on the nearest-neighbor links and represent 24 of 600-cell vertices.

D+4sm vertices have 6-semi-HyperCube 32 next-next-nearest neighbors representing
4 CP2 Internal Symmetry Space components of 8 First-Generation Fermion Particles.
Fermion AntiParticles are represented by Particles moving backward in Time
for representation of $2 \times 32 = 64$ of 600-cell vertices.

D+4g odd (1 and 3) layers correspond to Vectors and Fermion Spinors which are related by Triality.
D+4g even (2) layers correspond to BiVectors.

**From each vertex of the 4D Feynman Checkerboard the Second Stage
uses a second Triad of Quantum Choice Vectors.**

**A significant consequence of using two Triads of Quantum Choice Vectors
is the emergence of Second and Third Generation Fermions.**

In my earlier paper (arXiv quant-ph/9503015) I used a **simpler version of 4D Feynman Checkerboard which is useful for showing consistency with the Dirac equation** using the following approach: The Feynman Checkerboard in 1+3 SpaceTime dimensions reproduces the Dirac equation, using work of Urs Schreiber and George Raetz. (See my paper at CERN-CDS-EXT-2004-030) A very nice feature of the George Raetz web site is its illustrations, which include an image of a vertex of a 1+1 dimensional Feynman Checkerboard

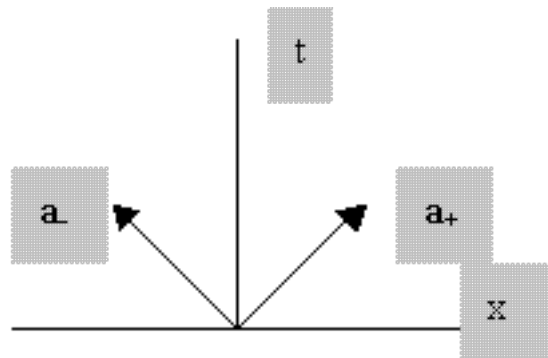

and an image of a projection into three dimensions of a vertex of a 1+3 dimensional Feynman Checkerboard

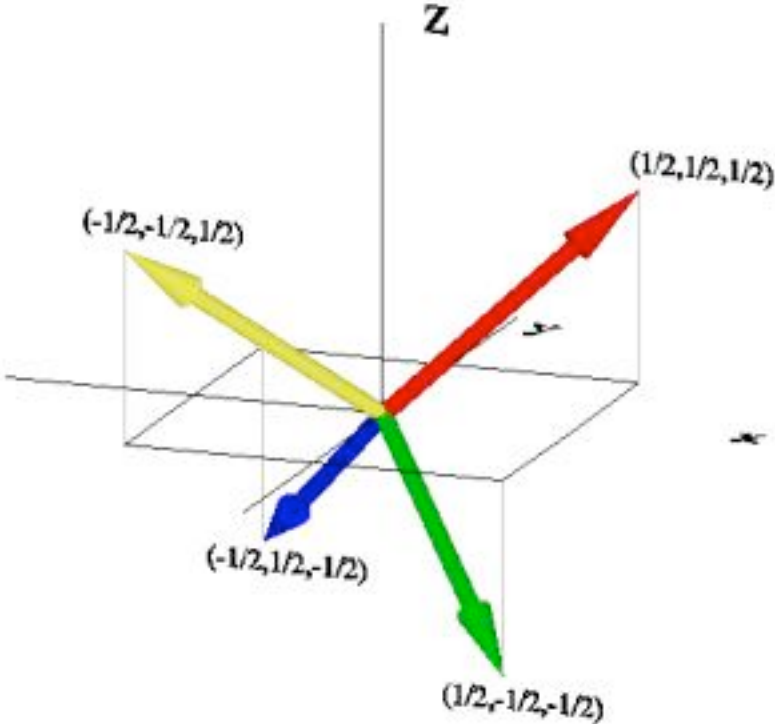

and an image of flow contributions to a vertex in a HyperDiamond Random Walk from the four nearest neighbors in its past

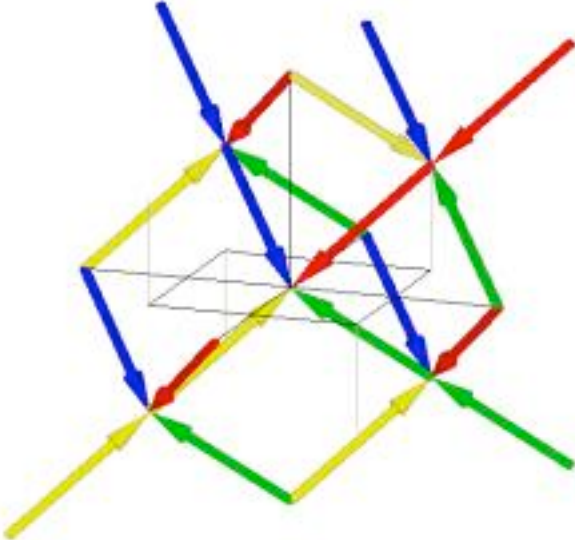

Urs Schreiber wrote on the subject:

Re: Physically understanding the Dirac equation and 4D

in the newsgroup sci.physics.research on 2002-04-03 19:44:31 PST (including an appended forwarded copy of an earlier post)
and again on 2002-04-10 19:03:09 PST as found on the web page
<http://www-stud.uni-essen.de/~sb0264/spinors-Dirac-checkerboard.html>

and the following are excerpts from those posts:

"... I know ... the ... lanl paper ...[<http://xxx.lanl.gov/abs/quant-ph/9503015>]...
and

I know that Tony Smith does give
a generalization of Feynman's summing prescription from 1+1 to 1+3 dimensions.

But I have to say that I fail to see that this generalization reproduces the Dirac propagator in 1+3 dimensions,
and that I did not find any proof that it does.

Actually, I seem to have convinced myself that it does not,
but
I may of course be quite wrong.

I therefore take this opportunity to state my understanding of these matters.

First, I very briefly summarize (my understanding of) Tony Smith's construction: The starting point is the observation that the left $|-\rangle$ and right $|+\rangle$ going states of the 1+1 dim checkerboard model can be labeled by complex numbers

$|-\rangle \rightarrow (1 + i)$
 $|+\rangle \rightarrow (1 - i)$

(up to a factor) so that multiplication by the negative imaginary unit swaps components:

$(-i) (1 + i)/2 = (1 - i)/2$
 $(-i) (1 - i)/2 = (1 + i)/2$.

Since the path-sum of the 1+1 dim model reads

$\phi = \sum \text{over all possible paths of } (-i \text{ eps } m)^{(\text{number of bends of path})} =$
 $= \sum \text{over all possible paths of product over all steps of one path of } -i \text{ eps } m$
(if change of direction after this step generated by i) 1 (otherwise)

this makes it look very natural to identify the imaginary unit appearing in the sum over paths with the "generator" of kinks in the path.

To generalize this to higher dimensions, more square roots of -1 are added, which gives the quaternion algebra in 1+3 dimensions.

The two states $|+\rangle$ and $|-\rangle$ from above, which were identified with complex numbers, are now generalized to four states identified with the following quaternions

(which can be identified with vectors in M^4 indicating the direction in which a given path is heading at one instant of time):

$(1 + i + j + k) (1 + i - j - k) (1 - i + j - k) (1 - i - j + k) ,$

which again constitute a (minimal) left ideal of the algebra

(meaning that applying i,j, or k from the left on any linear combination of these four states gives another linear combination of these four states).

Hence,

now i,j,k are considered as "generators" of kinks in three spatial dimensions and the above summing prescription naturally generalizes to

$\phi = \sum \text{over all possible paths of product over all steps of one path of}$

$-i \text{ eps } m$ (if change of direction after this step generated by i)

$-j \text{ eps } m$ (if change of direction after this step generated by j)

$-k \text{ eps } m$ (if change of direction after this step generated by k)

1 (otherwise)

The physical amplitude is taken to be

$A * e^{(i \text{ alpha})}$

where A is the norm of phi and alpha the angle it makes with the x_0 axis.

As I said, this is merely my paraphrase of Tony Smith's proposal as I understand it.

I fully appreciate that the above construction is a nice (very "natural") generalization of the summing prescription of the 1+1 dim checkerboard model.

But if it is to describe real fermions propagating in physical spacetime, this generalized path-sum has to reproduce the propagator obtained from the Dirac equation in 1+3 dimensions, which we know to correctly describe these fermions. Does it do that?

...

Hence I have taken a look at the material [that] ... George Raetz ... present[s] ... titled "The HyperDiamond Random Walk", found at

http://www.pcisys.net/~bestwork.1/QRW/the_flow_quaternions.htm ,

which is mostly new to me. ...

I am posting this in order to make a suggestion for a more radical modification

...

[The]... equation ... $DQ = (iE)Q$... is not covariant.

That is because of that quaternion E sitting on the left of the spinor Q

in the rhs of [the] equation

The Dirac operator D is covariant,

but the unit quaternion E on the rhs refers to a specific frame.

Under a Lorentz transformation L one finds

$L D Q = i E L Q = L E' Q \Leftrightarrow D Q = E' Q$ now with $E' = L^{-1} E L$ instead of E .

This problem disappears

when the unit quaternion E is brought to the *right* of the spinor Q .

What we would want is an equation of the form $DQ = Q(iE)$.

In fact, demanding that the spinor Q be an element of the minimal left ideal generated by the primitive projector $P = (1+y_0)(1+E)/4$,

so that $Q = Q' P$,

one sees that $DQ = Q(iE)$ almost looks like the the *Dirac-Lanczos equation*

(See hep-ph/0112317, equation (5) or ... equation (9.36) [of]... W. Baylis, Clifford (Geometric) Algebras, Birkhaeuser (1996) ...).

To be equivalent to the Dirac-Lanczos equation, and hence to be correct,

we need to require that $D = \gamma_0 @0 + \gamma_1 @1 + \gamma_2 @2 + \gamma_3 @3$

instead of ... = $e_0 @0 + e_1 @1 + e_2 @2 + e_3 @3$.

All this amounts to sorting out

in which particular representation we are actually working here.

In an attempt to address these issues, I now redo the steps presented on

http://www.pcisys.net/~bestwork.1/QRW/the_flow_quaternions.htm

with some suitable modifications to arrive at the correct Dirac-Lanczos equation

(this is supposed to be a suggestion subjected to discussion):

So consider a lattice in Minkowski space

generated by a unit cell spanned by the four (Clifford) vectors

$$\begin{aligned} r &= (y_0 + y_1 + y_2 + y_3)/2 & g &= (y_0 + y_1 - y_2 - y_3)/2 & b &= \\ & & & & &= (y_0 - y_1 + y_2 - y_3)/2 & y &= (y_0 - y_1 - y_2 + y_3)/2 . \end{aligned}$$

(y_i are the generators of the Dirac algebra $\{y_i, y_j\} = \text{diag}(+1, -1, -1, -1)_{ij}$.)

This is Tony Smith's "hyper diamond".

(Note that I use Clifford vectors instead of quaternions.)

Now consider a "Clifford algebra-weighted" random walk along the edges of this lattice,

which is described by four Clifford valued "amplitudes": K_r, K_g, K_b, K_y and

such that

@ r $K_r = k (K_g y_2 y_3 + K_b y_3 y_1 + K_y y_1 y_2)$

@ b $K_b = k (K_y y_2 y_3 + K_r y_3 y_1 + K_g y_1 y_2)$ @ g $K_g = k (K_r y_2 y_3 + K_y y_3 y_1 + K_b y_1 y_2)$

@ y $K_y = k (K_b y_2 y_3 + K_g y_3 y_1 + K_r y_1 y_2)$.

(This is geometrically motivated. The generators on the rhs are those that rotate the unit vectors corresponding to the amplitudes into each other. "k" is some constant.)

Note that I multiply the amplitudes from the *right* by the generators of rotation, instead of multiplying them from the left.

Next, assume that this coupled system of differential equations is solved by a spinor Q

$$Q = Q' (1+y_0)(1+iE)/4$$

$$E = (y_2 y_3 + y_3 y_1 + y_1 y_2)/\sqrt{3} \text{ with}$$

$$K_r = r Q \quad K_g = g Q \quad K_b = b Q \quad K_y = y Q .$$

This ansatz for solving the above system by means of a single spinor Q is, as I understand it, the central idea.

But note that I have here modified it on the technical side:

Q is explicitly an algebraic Clifford spinor in a definite minimal left ideal,

E squares to -1, not to +1,

and the K_i are obtained from Q by premultiplying with the Clifford basis vectors defined above.

Substituting this ansatz into the above coupled system of differential equations one can form one covariant expression by summing up all four equations:

$$(r @r + g @g + b @b + y @y) Q = k \sqrt{3} Q E$$

The left hand side is immediate.

To see that the right hand side comes out as indicated

simply note that $r + g + b + y = y_0$ and that $Q y_0 = Q$ by construction.

The above equation is the Dirac-Lanzos-Hestenes-Guersey equation, the algebraic version of the equation describing the free relativistic electron.

The left hand side is the flat Dirac operator $r @r + g @g + b @b + y @y = \gamma_m @m$ and

the right hand side, with $k = mc / (\hbar \sqrt{3})$,

is equal to the mass term $i mc / \hbar Q$.

As usual, there are a multitude of ways to rewrite this.

If one wants to emphasize biquaternions then

premultiplying everything with y_0 and

splitting off the projector P on the right of Q to express everything in terms of the,

then also biquaternionic, Q' (compare the definitions given above)

gives Lanzos' version (also used by Baylis and others).

I think this presentation improves a little on that given on George Raetz's web site:

The factor E on the right hand side of the equation is no longer a nuisance but a necessity.

Everything is manifestly covariant (if one recalls that algebraic spinors are manifestly covariant when nothing non-covariant stands on their *left* side). The role of the quaternionic structure is clarified, the construction itself does not depend on it.

Also, it is obvious how to generalize to arbitrary dimensions.

In fact, one may easily check that for 1+1 dimensions the above scheme reproduces the Feynman model.

While I enjoy this, there is still some scepticism in order as long as a central question remains to be clarified:

How much of the Ansatz $K(r,g,b,y) = (r,g,b,y) Q$ is wishful thinking?

For sure, every Q that solves the system of coupled differential equations that describe the amplitude of the random walk on the hyper diamond lattice also solves the Dirac equation.

But what about the other way round?

Does every Q that solves the Dirac equation also describe such a random walk. ...".

My proposal to answer the question raised by Urs Schreiber

Does every solution of the Dirac equation also describe a HyperDiamond Feynman Checkerboard random walk? uses symmetry.

The hyperdiamond random walk transformations include the transformations of the Conformal Group:

rotations and boosts (to the accuracy of lattice spacing);
translations (to the accuracy of lattice spacing);
scale dilatations (to the accuracy of lattice spacing): and
special conformal transformations (to the accuracy of lattice spacing).

Therefore, to the accuracy of lattice spacing, the hyperdiamond random walks give you all the conformal group Dirac solutions, and since the full symmetry group of the Dirac equation is the conformal group, the answer to the question is "Yes".

Thanks to the work of Urs Schreiber:

The HyperDiamond Feynman Checkerboard in 1+3 dimensions does reproduce the correct Dirac equation.

Here are some references to the **conformal symmetry of the Dirac equation**:

R. S. Krausshar and John Ryan in their paper Some Conformally Flat Spin Manifolds, Dirac Operators and Automorphic Forms at math.AP/022086 say:

"... In this paper we study Clifford and harmonic analysis on some conformal flat spin manifolds. ... manifolds treated here include $\mathbb{R}P^n$ and $S^1 \times S^{(n-1)}$.

Special kinds of Clifford-analytic automorphic forms associated to the different choices of are used to construct Cauchy kernels, Cauchy Integral formulas, Green's kernels and formulas together with Hardy spaces and Plemelj projection operators for L_p spaces of hypersurfaces lying in these manifolds. ...

Solutions to the Dirac equation are called Clifford holomorphic functions or monogenic functions.

Such functions are covariant under ... conformal or Mobius transformations acting over $\mathbb{R}^n \cup \{\infty\}$".

Barut and Raczka, in their book Theory of Group Representations and Applications (World 1986), say, in section 21.3.E, at pages 616-617:

"... E. The Dynamical Group Interpretation of Wave Equations.

... Example 1. Let $G = O(4,2)$.

Take U to be the 4-dimensional non-unitary representation in which the generators of G are given in terms of the 16 elements of the algebra of Dirac matrices as in exercise 13.6.4.1.

Because $(1/2)L_{56} = \gamma_0$ has eigenvalues $n = \pm 1$, taking the simplest mass relation $mn = K$, we can write

$(m \gamma_0 - K) \Psi(\dot{p}) = 0$, where K is a fixed constant.

Transforming this equation with the Lorentz transformation of parameter E

$\Psi(p) = \exp(i E N) \Psi(p)$

$N = (1/2) \gamma_0 \gamma_a$

gives

$(\gamma^u p_u - K) \Psi(p) = 0$

which is the Dirac equation ...".

P. A. M. Dirac, in his paper Wave Equations in Conformal Space, Ann. Math. 37 (1936) 429-442, reprinted in The Collected Works of P. A. M. Dirac: Volume 1: 1924-1948, by P. A. M. Dirac (author), Richard Henry Dalitz (editor), Cambridge University Press (1995), at pages 823-836, said:

"... by passing to a four-dimensional conformal space ...

a ... greater symmetry of ... equations of physics ... is shown up, and their invariance under a wider group is demonstrated. ...

The spin wave equation ... seems to be the only

simple conformally invariant wave equation involving the spin matrices. ... This equation is equivalent to the usual wave equation for the electron, except ... [that it is multiplied by]... the factor $(1 + \alpha_5)$,

which introduces a degeneracy. ...".

Here are some comments on **Lorentz Invariance based on D4 Lattice** properties:

The D4 lattice nearest neighbor vertex figure, the 24-cell, is the 4HD HyperDiamond lattice next-to-nearest neighbor vertex figure. Fermions move from vertex to vertex along links. Gauge bosons are on links between two vertices, and so can also be considered as moving from vertex to vertex along links. The only way a translation or rotation can be physically defined is by a series of movements of a particle along links. A TRANSLATION is defined as a series of movements of a particle along links, each of which is the CONTINUATION of the immediately preceding link IN THE SAME DIRECTION. An APPROXIMATE rotation, within an APPROXIMATION LEVEL D, is defined with respect to a given origin as a series of movements of a particle along links among vertices ALL of which are in the SET OF LAYERS LYING WITHIN D of norm (distance²) R from the origin, that is, the SET OF LAYERS LYING BETWEEN norm R-D and norm R+D from the origin. Conway and Sloane (Sphere Packings, Lattices, and Groups - Springer) pp. 118-119 and 108, is the reference that I have most used for studying lattices in detail. (Conway and Sloane define the norm of a vector x to be its squared length xx.) In the D4 lattice of integral quaternions, layer 2 has the same number of vertices as layer 1, $N(1) = N(2) = 24$. Also (this only holds for real, complex, quaternionic, or octonionic lattices), $K(m) = N(m)/24$ is multiplicative, meaning that, if p and q are relatively prime, $K(pq) = K(p)K(q)$. The multiplicative property implies that: $K(2^a) = K(2) = 1$ (for a greater than 0) and $K(p^a) = 1 + p + p^2 + \dots + p^a$ (for a greater than or equal to 0). So, for the D4 lattice, there is always an arbitrarily large layer (norm $xx = 2^a$, for some large a) with exactly 24 vertices, and there is always an arbitrarily large layer (norm $xx = P$, for some large prime P) with $24(P+1)$ vertices (note that Mersenne primes are adjacent to powers of 2), and given a prime number P whose layer is within D of the origin, which layer has N vertices, there is a layer kP with at least N vertices within D of any other given layer in D4. Some examples I have used are chosen so that the 2^a layer adjoins the prime $2^a \pm 1$ layer.

Notation in the following table is based on the minimal norm of the D4 Lattice being 1. This is the second definition (equation 90) of the D4 Lattice in Chapter 4 of Sphere Packings, Lattices, and Groups, 3rd ed., by Conway and Sloane (Springer 1999) who note that the Dn lattice is the checkerboard lattice in n dimensions.

m=norm of layer	N(m)=no. vert.	K(m)=N(m)/24
1	24	1
2	24	1
3	96	4
4	24	1
5	144	6
6	96	4
7	192	8
8	24	1
9	312	13
10	144	6
11	288	12
12	96	4
13	336	14
14	192	8
15	576	24
16	24	1
17	432	18
18	312	13
19	480	20
20	144	6
127	3,072	128
128	24	1
65,536=2 ¹⁶	24	1
65,537	1,572,912	65,538
2,147,483,647	51,539,607,552	2,147,483,648
2,147,483,648=2 ³¹	24	1

Appendix - Quaternion Hurwitz Shells - Primes and Powers of 2

Conway and Smith, in "On Quaternions and Octonions" said:

"... 5.1 The Hurwitz Integral Quaternions ... Hurwitz ... found a ... definition ... that $a+bi+cj+dk$ is a Hurwitz integer just if either all of a, b, c, d are in \mathbb{Z} or all are in $\mathbb{Z} + 1/2$... A prime Hurwitz integer P is one whose norm is a rational prime p .

Analogously to the fact that $p = p \times 1$ and $p = 1 \times p$ are the only ways p is the product of two rational primes, its only factorizations into two Hurwitz integers must have the form $P = P' \times U$ and $P = V \times P''$, where $N(P) = N(P'') = p$ and $N(U) = N(V) = 1$.

So, we must ... study the Hurwitz units ... the Hurwitz integers of norm 1.

Theorem 1. There are precisely 24 Hurwitz units, namely the eight Lipschitz units $+1, \pm i, \pm j, \pm k$, and the 16 others $\pm 1/2 \pm (1/2)i \pm (1/2)j \pm (1/2)k$

...

if P is a Hurwitz prime, then its only factorizations as a product of two Hurwitz integers are $P = P U^{(-1)} \times U$ and $P = V \times V^{(-1)} P$ as U and V run over the 24 Hurwitz units

... Theorem 3. Each rational prime p

admits at least one quaternionic factorization $p = P_0 P_0 \dots$ ".

**Hurwitz quaternions whose (square) norm is rational prime
are prime quaternions and there are no other prime quaternions.
In particular, over the quaternions, no rational primes are prime.**

The Hurwitz Integral Quaternions form the D_{4+} Lattice = Z_4 Lattice that contains as a sublattice the D_4 Lattice of the D_4 Lie Algebra.

**An integer N is a Power of 2
if and only if
the D_{4+} Lattice sphere of radius N contains 24 D_{4+} Lattice vertices.**

**An integer N is a Rational Prime
if and only if
the D_{4+} Lattice sphere of radius N contains $8(1+N)$ D_{4+} Lattice vertices.**

The number of vertices of a Lattice on a sphere of given radius is described by the theta series of that lattice.

Conway and Sloane, in “Sphere Packings, Lattices, and Groups” said:
 “...

2.3 Theta series and connections with number theory. A very old problem asks for the number of ways of writing an integer m as a sum of four squares, or in other words for the number of quadruples of integers (x_1, x_2, x_3, x_4) such that

$$x_1^2 + x_2^2 + x_3^2 + x_4^2 = m. \quad (29)$$

For example when $m = 2$ there are 24 solutions, consisting of all permutations of $(\pm 1, \pm 1, 0, 0)$. (We agree to count $2 = 1^2 + 1^2 + 0^2 + 0^2$, $2 = 1^2 + (-1)^2 + 0^2 + 0^2$, $2 = 1^2 + 0^2 + 1^2 + 0^2$ etc. as distinct solutions.)

There is a nice way to state this problem in terms of lattices. For any lattice Λ , let N_m be the number of vectors $x \in \Lambda$ of norm m , i.e. with $x \cdot x = m$. From (24), N_m is also the number of integral vectors ξ such that

$$\xi A \xi^t = m, \quad (30)$$

or in other words the number of times the quadratic form associated with Λ represents the number m . Eq. (30) is an example of a *Diophantine*

equation of degree 2 [Mor6]. Now $x_1^2 + x_2^2 + x_3^2 + x_4^2$ is the quadratic form associated with the four-dimensional cubic lattice \mathbf{Z}^4 . So the number of ways of writing m as a sum of four squares is equal to the number of vectors of norm m in the lattice \mathbf{Z}^4 .

The calculation of these numbers is facilitated by introducing the *theta series* of a lattice Λ , which is

$$\Theta_\Lambda(z) = \sum_{x \in \Lambda} q^{x \cdot x} \quad (31)$$

$$= \sum_{m=0}^{\infty} N_m q^m, \quad (32)$$

where $q = e^{\pi iz}$. For many purposes we can just think of Θ_Λ as a formal power series in an indeterminate q , although for deeper investigations we must take $q = e^{\pi iz}$, where z is a complex variable. In this case $\Theta_\Lambda(z)$ is easily seen to be a holomorphic function of z for $\text{Im}(z) \geq 0$ [Gun1, p. 71], [Ser1, p. 109].

... The lattice D_n ... is ... the checkerboard lattice ... Theta series ...

To obtain the theta series of the lattice D_n (which consists of the points of \mathbf{Z}^n whose coordinates sum to an even number, Chap. 4, §7.1) we introduce the theta function θ_4 . θ_3 and θ_2 may be regarded as assigning unit masses to the integer and half-integer points on the real line respectively. To get θ_4 we assign masses of +1 to the even integers and -1 to the odd integers, or formally

$$\theta_4(z) = \sum_{m=-\infty}^{\infty} (-q)^{m^2} = 1 - 2q + 2q^4 - 2q^9 + 2q^{16} - \dots \quad (36)$$

Then

$$\Theta_{D_n}(z) = \frac{1}{2} (\theta_3(z)^n + \theta_4(z)^n). \quad (37)$$

$$D_n : \frac{1}{2} (\theta_3(z)^n + \theta_4(z)^n) = \sum_{m=0}^{\infty} r_n(2m) q^{2m} \downarrow$$

...

... The four-dimensional lattice D_4 ... theta series ...

The first 50 coefficients of the theta series for D_4 (using the first definition, Eq. (86)) are shown in Table 4.8. These coefficients are given explicitly by $N(2m) = r_4(2m)$, using the second formula in Eq. (49). Also $N(2m)$ is the number of integral quaternions of norm m , and $(24)^{-1}N(2m)$ is a multiplicative function of m . In the notation of Schläfli and Coxeter, D_4 is the regular honeycomb $\{3, 3, 4, 3\}$ (see [Cox20, §7.8]).

Table 4.8. Theta series of 4-dimensional lattice D_4 . The table gives $N(m)$ for $m = 10r + s$.

$r \setminus s$	0	2	4	6	8	10	12	14	16	18
0	1	24	24	96	24	144	96	192	24	312
2	144	288	96	336	192	576	24	432	312	480
4	144	768	288	576	96	744	336	960	192	720
6	576	768	24	1152	432	1152	312	912	480	1344
8	144	1008	768	1056	288	1872	576	1152	96	1368
10	744	1728	336	1296	960	1728	192	1920	720	1440

... $[1] = (\frac{1}{2}, \frac{1}{2}, \dots, \frac{1}{2})$, norm $n/4$, ... we define $D_{n+} = D_n \cup ([1]+D_n)$... D_{n+} is a lattice packing if and only if n is even ... $D_{4+} = \mathbf{Z}^4$...

the theta series is $\frac{1}{2} (\theta_2(z)^n + \theta_3(z)^n + \theta_4(z)^n)$

since D_4^+ is congruent to \mathbf{Z}^4 ,

we have the identity $\frac{1}{2} (\theta_2(z)^4 + \theta_3(z)^4 + \theta_4(z)^4) = \theta_3(z)^4$, i.e.

$$\theta_3(z)^4 = \theta_2(z)^4 + \theta_4(z)^4.$$

...

5. The n -dimensional cubic lattice \mathbf{Z}^n

The set of integers $\dots, -2, -1, 0, 1, 2, 3, \dots$ is denoted by \mathbf{Z} , and

$$\mathbf{Z}^n = \{(x_1, \dots, x_n) : x_i \in \mathbf{Z}\}$$

is the n -dimensional *cubic* or *integer lattice*. (\mathbf{Z}^2 is better called the *square lattice*, as seen in ordinary graph paper.) As generator matrix M we may simply take the identity matrix. Then $\det = 1$, minimal norm = 1, kissing number $\tau = 2n$, and the minimal vectors are $(0, \dots, \pm 1, \dots, 0)$. The packing radius $\rho = 1/2$, the covering radius $R = \sqrt{n}/2 = \rho\sqrt{n}$, the density $\Delta = V_n 2^{-n}$ and the center density $\delta = 2^{-n}$. Thus \mathbf{Z} has density $\Delta = 1$, but the densities of \mathbf{Z}^2 , \mathbf{Z}^3 and \mathbf{Z}^4 are only $\pi/4 = 0.785\dots$, $\pi/6 = 0.524\dots$ and $\pi^2/32 = 0.308\dots$. A typical deep hole is $(\frac{1}{2}, \frac{1}{2}, \dots, \frac{1}{2})$, and the Voronoi cells are cubes. \mathbf{Z}^n is self-dual. Its automorphism group consists of all permutations and sign changes of the coordinates, and has order $2^n n!$. (This is the Weyl group of B_n .)

The theta series of \mathbf{Z}^n is $\theta_3(z)^n$, and the theta series of the translate $\mathbf{Z}^n + (0^a \frac{1}{2}^{n-a})$ is

$$\theta_2(z)^{n-a} \theta_3(z)^a \tag{44}$$

...

If we expand

$$\Theta_{\mathbf{Z}^n}(z) = \theta_3(z)^n = \sum_{m=0}^{\infty} r_n(m) q^m, \tag{47}$$

then the coefficient $r_n(m)$ is the number of ways of writing m as a sum of n squares. In particular for $m > 0$ we have

$$r_2(m) = 4\delta(m), \tag{48}$$

where $\delta(m)$ is the difference between the numbers of divisors of m of the two forms $4a + 1$, $4a + 3$,

$$r_4(m) = \begin{cases} 8 \sum_{d|m} d, & \text{if } m \text{ is odd,} \\ 24 \sum_{d|m, d \text{ odd}} d, & \text{if } m \text{ is even,} \end{cases} \tag{49}$$

$$r_8(m) = 16 \sum_{d|m} (-1)^{m-d} d^3. \tag{50}$$

...

If we define $r_4'(m) = r_4(m)/8$, then $r_4'(m)$ is *multiplicative*, i.e. satisfies

$$r_4'(\ell m) = r_4'(\ell)r_4'(m) \text{ whenever} \\ \ell \text{ and } m \text{ are relatively prime.} \quad (51)$$

This property simplifies the calculation of $r_4'(m)$, for now it is enough to know the values when $m = p^a$ is a power of a prime. These are

$$r_4'(2^a) = 3, \quad (a \geq 1), \\ r_4'(p^a) = 1 + p + p^2 + \cdots + p^a, \quad (a \geq 0),$$

where p is an odd prime. A similar multiplicative property holds for the theta functions of certain other lattices. Bateman [Gro2, p. 131] has shown that $r_n(m)/2n$ is multiplicative if and only if n is 1, 2, 4 or 8. (This reflects the fact that there are unique factorization theorems for suitable rings of integers in the real, complex, quaternionic, and Cayley numbers.)

...

2.5 Modular forms. Further connections between lattices and number theory arise because the theta series of an integral lattice is a *modular form*. We do not state the general theorem here; some important special cases will be found in Chap. 7, Theorems 7 and 17. There is a brief account of the general theory of the connections between quadratic forms and modular forms in Cassels [Cas3, p. 382], and numerous other references: [Gun1], [Har4], [Hec2], [Hec3], [Kit3], [Kno1], [Lan9], [Ogg1], [Pet4], [Ran6], [Sch6], [Sch7], [Vig1].

...".

**theta series of lattice $Z^4 = D4+ =$
= Number of ways of writing n as sum of 4 squares =
= Sloane OEIS A000118**

The **green 24** numbers correspond to powers of 2

(2, 4, 8, 16, 32)

The **red** numbers correspond to primes beyond 2

(3, 5, 7, 11, 13, 17, 19, 23, 29, 31, 37, 41, 43, 47, 53)

1, 8, **24**,
32, **24**,
48, 96, **64**, **24**,
104, 144, **96**, 96, **112**, 192, 192, **24**,
144, 312, **160**, 144, 256, 288, **192**, 96, 248, 336, 320, 192,
240, 576, **256**, **24**,
384, 432, 384, 312, **304**, 480, 448, 144, **336**, 768, **352**, 288,
624, 576, **384**, 96, 456, 744, 576, 336, **432**, 960, 576, 192

Pin plot of A000118(n)

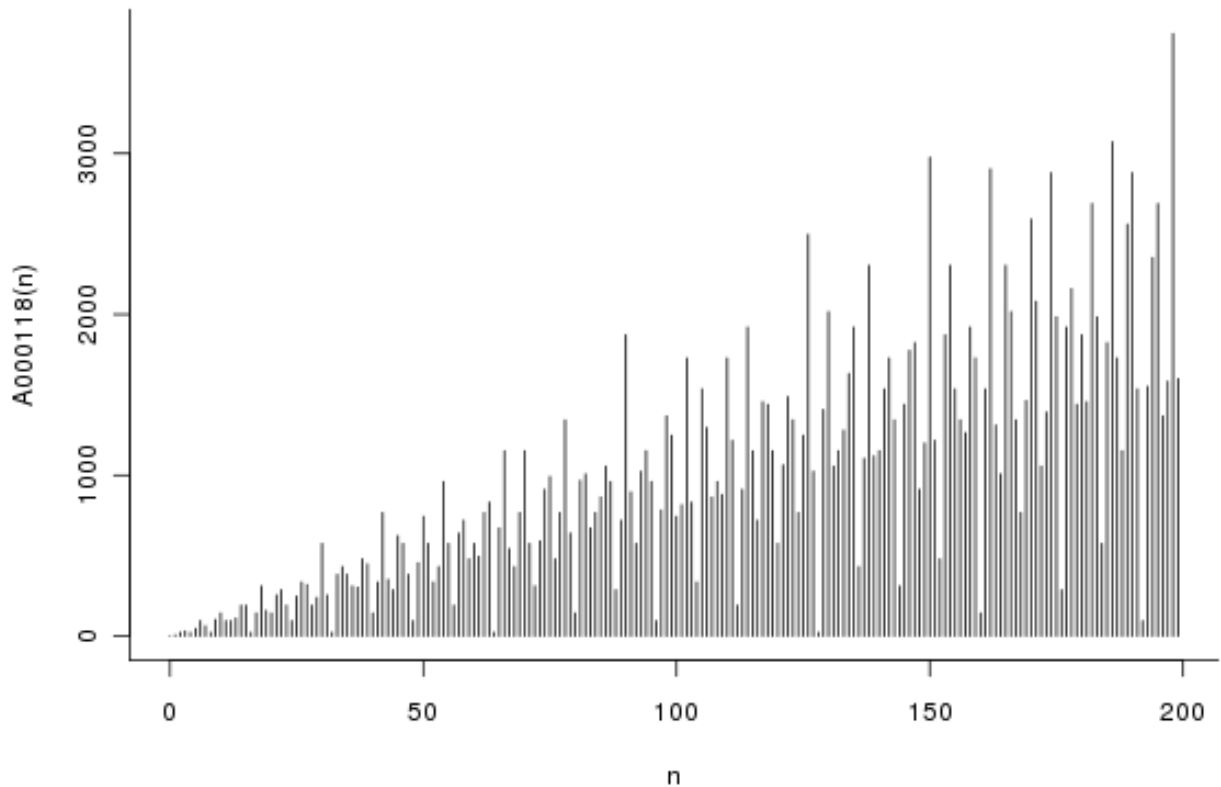

The D4+ Lattice lives in 4-dim Euclidean space and is made up of shells each of which is a set of vertices on a 3-sphere S3.

Two ways to subdivide the S3 are

(images from members.home.nl/fg.marcelis/24-cell.htm)

First, into 8 3-dim cube cells as a Tesseract Hypercube

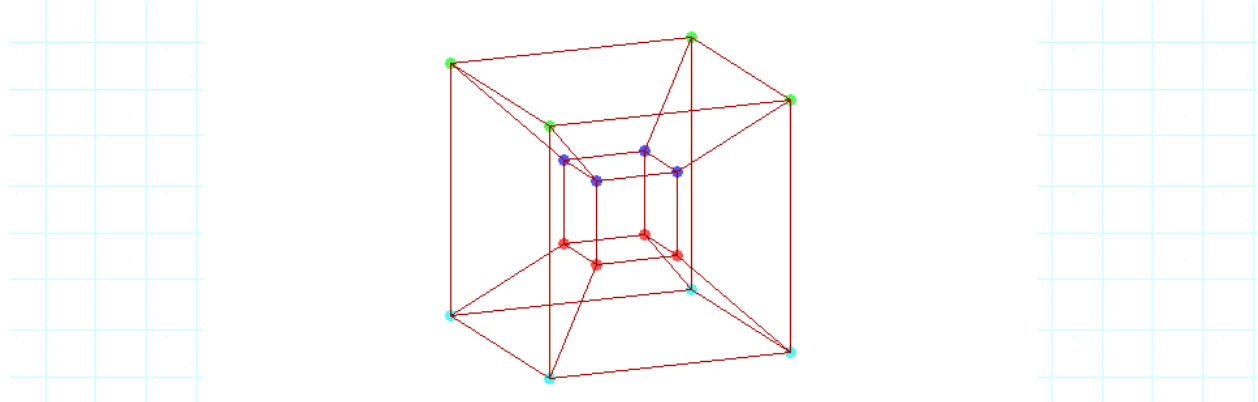

The D4+ Lattice shell of radius 3 has $(1 + 3) \times 8 = 32$ vertices. They can be considered to be the centers of each of the 8 cube cells plus, distributed around the center in each of the 8 cube cells, one new vertex for each of the 3 steps in the radius of the S3 of radius 3.

For all prime numbers p , and only for those numbers, the $D4+$ Lattice shell of radius p has $(1 + p) \times 8$ vertices. They can be considered to be the centers of each of the 8 cube cells plus, distributed around the center in each of the 8 cube cells, one new vertex for each of the p steps in the radius of the S^3 of radius p where p is a prime number. **This is a geometric characterization of prime numbers relating the radius of the 3-sphere S^3 with the number of vertices on the S^3 .** Second, into 24 3-dim octahedron cells as a 24-cell. A 24-cell can be constructed from a Tesseract hypercube with 8 additional vertices, one at the center of each cube cell, by connecting pairs of additional vertices to the 4 vertices of the common face squares of each cube cell, producing 24 octahedron cells and $8+16 = 24$ vertices of the 24-cell.

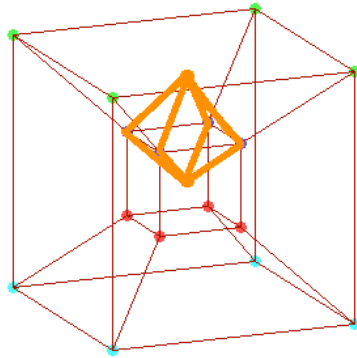

This produces a series of S^3 shells of radius $p \times 2^n$ (for prime p) each having $(1 + p) \times 24$ vertices. The $D4+$ Lattice shell of radius 2 has the 24 vertices of a 24-cell.

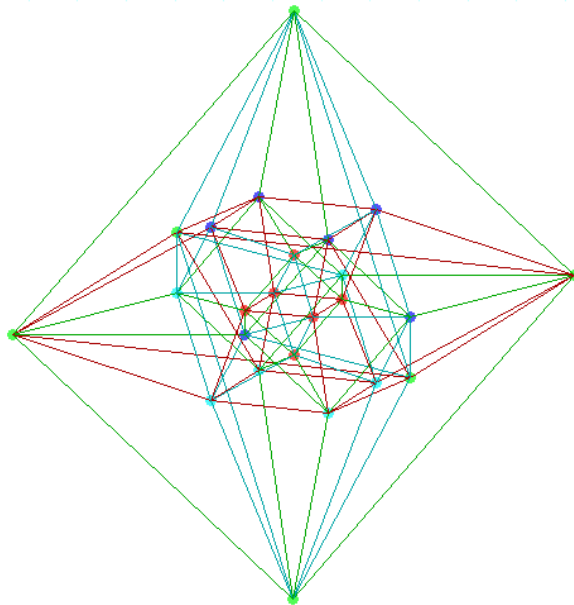

They can dually be considered to be the centers of each of the 24 octahedron cells. For all S^3 of radius 2^n for any n (i.e., for all radii that are powers of 2) the $D4+$ Lattice shell of radius 2^n has 24 vertices. **This is a geometric characterization of powers of 2 relating the radius of the 3-sphere S^3 with the number of vertices on the S^3 .**

Here are the numbers of vertices in the first 45 shells of the D4+ lattice.

Red S3 shells have prime radius. Green S3 shells have power-of-2 radius.

Purple S3 shells have prime x power-of-2 radius.

m = radius of shell	N(m) = no. vertices in shell of radius m
0	1
1	8 = 1 x 8
2	24 = (1 + 2) x 8 = 1 x 24
3	32 = (1 + 3) x 8
4	24 = 1 x 24
5	48 = (1 + 5) x 8
6	96 = (1 + 3) x 24
7	64 = (1 + 7) x 8
8	24 = 1 x 24
9	104 = (1 + 3 + 9) x 8
10	144 = (1 + 5) x 24
11	96 = (1 + 11) x 8
12	96 = (1 + 3) x 24
13	112 = (1 + 13) x 8
14	192 = (1 + 7) x 24
15	192 = (1 + 3 + 5 + 15) x 8
16	24 = 1 x 24
17	144 = (1 + 17) x 8
18	312 = (1 + 3 + 9) x 24
19	160 = (1 + 19) x 8
20	144 = (1 + 5) x 24
21	256 = (1 + 3 + 7 + 21) x 8
22	288 = (1 + 11) x 24
23	192 = (1 + 23) x 8
24	96 = (1 + 3) x 24
25	248 = (1 + 5 + 25) x 8
26	336 = (1 + 13) x 24
27	320 = (1 + 3 + 9 + 27) x 8
28	192 = (1 + 7) x 24
29	240 = (1 + 29) x 8
30	576 = (1 + 3 + 5 + 15) x 24
31	256 = (1 + 31) x 8
32	24 = 1 x 24
33	384 = (1 + 3 + 11 + 33) x 8
34	432 = (1 + 17) x 24
35	384 = (1 + 5 + 7 + 35) x 8
36	312 = (1 + 3 + 9) x 24
37	304 = (1 + 37) x 8
38	480 = (1 + 19) x 24
39	448 = (1 + 3 + 13 + 39) x 8
40	144 = (1 + 5) x 24
41	336 = (1 + 41) x 8
42	768 = (1 + 3 + 7 + 21) x 24
43	352 = (1 + 43) x 8
44	288 = (1 + 11) x 24
45	624 = (1 + 3 + 5 + 9 + 15 + 45) x 8

I think of numbers as being represented by Quaternions and their D_4+ lattice by the integer N being the set of points of that lattice on a sphere of square norm radius N .

In 4D there are 4 coordinate axes, with 8 radii (positive and negative axes).

Properties of N are determined by the pattern of D_4+ lattice points on the radius- N sphere in 4D.

For example, as Ray Aschheim has shown:

N is a power of 2 if and only if the radius- N sphere has 24 vertices
That is:
3 vertices for each of the 8 radii.

N is a prime if and only if the radius- N sphere has $8 \times (1+N)$ vertices
That is:
For each of the 8 radii of length N the sphere has $N + 1$ vertices -
one vertex for each of the N nested spheres intersected by the radius
plus one for the origin.

The number 2 is both a power of 2 and prime since $3 = 2+1$

Excerpt from “Toward the Unification of Physics and Number Theory” by Klee Irwin:

3.2 - Geometric Primality Test

We introduce a geometric analogue to the primality test that when p is prime, it divides,

$$\binom{p}{k} = \frac{p \cdot (p-1) \cdots (p-k+1)}{k \cdot (k-1) \cdots 1} \text{ for all } 0 < k < p. \quad (3)$$

Our geometric form provokes the *prime-simplex distribution hypothesis* that, if solved, leads to a proof of the Riemann hypothesis.

CLAIM: If and only if the quantity of vertices of an n -simplex is evenly divisible into each quantity of its sub-simplexes is that simplex a prime-simplex and associated with a prime A -lattice.

p is prime $\Leftrightarrow \forall k \in \mathbb{N}^*, k < p \Rightarrow p \mid \#\{S_k \subset S_{p-1}\}$

p is not prime $\Leftrightarrow (\exists k \in \mathbb{N}^*, k < p, (\#\{S_k \subset S_{p-1}\})[p] \neq 0)$

Note: $\#\{S_k \subset S_{p-1}\}$ is the binomial coefficient $\binom{p-1}{k}$

We want to prove that p is prime if and only if p divides into C , where C is given by equation (X). for any k between 2 and $p-1$.

C satisfies this equation: $p! = C k! (p-k)!$

First, we demonstrate that, if p is prime, p divides C .

Conjecture 1: (if p is prime, p divides C)

Proof : Because p divides $p!$,

p also divides one of the three factors on the right side: C or $k!$ or $(p-k)!$

$k < p$ and $k!$ is a product of numbers smaller than p . Therefore, p does not divide $k!$.

If k is greater than 1, $(p-k)!$ is a product of numbers smaller than p .

Therefore, p does not divide $(p-k)!$. So, necessarily, p divides C . QED.

Conjecture 2 : if p is composite, let $p=a b$, where $a \neq 1, b \neq 1$ then at least one of the coefficients is not divisible by p .

Next, we demonstrate that, if p is composite, let $p=a b$, where $a \neq 1, b \neq 1$ then at least one of the coefficients is not divisible by p .

$$k = a : C = \frac{(a b)!}{a!(a(b-1))!} \quad (4)$$

Take

We can rewrite as $C = b(a b - 1)(a b - 2) \dots (a b - a + 1)/(a-1)!$ (5)

C is not divisible by $a b$, because none of the factors $(a b - 1), (a b - 2) \dots$

$(a b - a + 1)$ is divisible by a , and b is not divisible by $a b$. QED

[Credit goes to Raymond Aschheim for assistance with the above equations.]

Instead of testing for prime using simplexes, I like to use Real Clifford Algebras:

Let the number N be represented by its Real Clifford Algebra $Cl(N)$ with graded structure

grade	0	1	2	3	(N-1)	N
dimension	1	N	$\binom{N}{2}$	$\binom{N}{3}$...	$\binom{N}{N-1}$ 1

where $\binom{N}{k}$ is binomial coefficient

Then N is prime if and only if the dimension of grades 1 through (N-1) of $Cl(N)$ is divisible by N

Note that the dimension of grades 0 and N are NOT divisible by N because they are both = 1.

These cases for the simplex are not discussed by you but they do exist and represent the empty set and the total set.

Examples:

7 is represented by $Cl(7)$

grade	0	1	2	3	4	5	6	7	
dimension	1	7	21	35	35	21	7	1	
dim / 7	NO	1	3	5	5	3	1	NO	so 7 is prime

6 is represented by $Cl(6)$

grade	0	1	2	3	4	5	6	
dimension	1	6	15	20	15	6	1	
dim / 6	NO	1	NO	NO	NO	1	NO	so 6 is not prime

SUMMARY:

**N is prime
if and only if**

The orders of ALL grades of $Cl(N)$ (other than 0 and N) contain a factor of N

$$Cl(N) \text{ graded structure} = 1 + N + aN + bN + \dots + bN + aN + N + 1$$

$$Cl(2) = 1 + 2 + 1 \text{ so 2 is prime}$$

$$Cl(3) = 1 + 3 + 3 + 1 \text{ so 3 is prime}$$

$$Cl(5) = 1 + 5 + 5x2 + 5x2 + 5 + 1 \text{ so 5 is prime}$$

$$Cl(7) = 1 + 7 + 7x3 + 7x5 + 7x5 + 7x3 + 7 + 1 \text{ so 7 is prime}$$

$$Cl(11) = 1 + 11 + 11x5 + 11x15 + 11x30 + 11x42 + 11x42 + 11x30 + 11x15 + 11x5 + 11 + 1 \text{ so 11 is prime}$$

$$Cl(13) = 1 + 13 + 13x6 + 13x22 + 13x55 + 13x99 + 13x132 + 13x132 + 13x99 + 13x55 + 13x22 + 13x6 + 13 + 1 \text{ so 13 is prime}$$

...

The above just shows that the Clifford Algebra test and the Simplex test give the same results when testing for primes but there is a way that the Clifford Algebra number structure is especially useful:

define infinite-simplex as
the completion of the limit as N goes to infinity of the N-simplex
and
see it in terms of Real Clifford Algebras
so that
8-Periodicity allows the formation of a consistent completion of the union of all tensor products of $Cl(16)$
as the
infinite Clifford Algebra Algebraic Quantum Field Theory
analogous to
the Hyperfinite II_1 von Neumann factor algebra Fock space of Complex Clifford Algebras.

$Cl(16)$ is important because it contains E_8 in a way that is easy to see whereas I am not sure how easy it is to see E_8 inside the 15-dim simplex for the number 16. Although it is easy to see that the 120-dim part of 248-dim $E_8 = (16!2)$ (binomial) = 120 faces (2-dim subspaces) of the simplex, it is not so easy to see the 128-dim part of E_8 because it is made up of half-spinors which are relatively complicated combinations of
(-1)-dim empty set
some of the 4-dim subspaces
some of the 8-dim subspaces
some of the 12-dim subspaces
the full 15-dim space spanned by the 16 points determined by 16 vectors.

Examples of using the Clifford Algebra point of view for $N = 16$ and $N = 17$ are:

16 is not prime but it is a power of 2
17 is prime and $Cl(17)$ contains $Cl(16)$

The graded structure for $Cl(16)$ is
1 16 120 560 1820 4368 8008 11440 12870 11440 8008 4368 1820 560 120 16 1

and for $Cl(17)$ is
1 17 136 680 2380 6188 12376 19448 24310 ... same numbers in reverse order

divided by 17

NO 1 8 40 140 364 728 1144 1430 ... same numbers in reverse order

Clifford Algebras have dimension Powers of 2.

The E8 Physics Creation Sequence begins with Spinor/Clifford Algebra Doubling

$$\text{Cl}(0,0) \rightarrow \text{Cl}(0,2) \rightarrow \text{Cl}(0,4) \rightarrow \text{Cl}(0,6) \rightarrow \text{Cl}(0,8) \rightarrow$$

that goes to $\text{Cl}(0,8)$ which has Vector - Half-Spinor Triality and is the Basic Building Block of 8-Periodicity of Real Clifford Algebras whereby the Creation Sequence continues by Tensor Product

$$\rightarrow \text{Cl}(0,8) \times \text{Cl}(0,8) = \text{Cl}(0,16) \rightarrow \text{Cl}(0,16) \times \text{Cl}(0,8) = \text{Cl}(0,24) \rightarrow$$

$\text{Cl}(0,16)$ contains the Maximal Exceptional E8 Lie Algebra

$\text{Cl}(0,24)$ contains the Vector Space of the 24-dim Leech Lattice Λ^{24} that is composed of 3 copies of E8 Lattices (2 being Integral Domains and 1 not Algebraically closed)

the Creation Sequence continues by constructing the Conformal Structure of 2x2 matrices with entries in $\text{Cl}(0,24) = M(2, \text{Cl}(0,24))$

$$\rightarrow M(2, \text{Cl}(0,24)) = \text{Cl}(1,25) \rightarrow$$

Since all the matrix entries are $\text{Cl}(0,24) =$ tensor product of 3 copies of $\text{Cl}(0,8)$ 8-Periodicity allows formation of the tensor products of copies of $\text{Cl}(1,25)$

\rightarrow Completion of Union of All Tensor Products of $\text{Cl}(1,25) =$ hyperfinite AQFT

The hyperfinite AQFT has Real / Octonionic structure inherited from $\text{Cl}(0,8)$ and

it also has Quaternionic structure due to

$\text{Cl}(1,25) = \text{Cl}(1,9) \times \text{Cl}(0,8) \times \text{Cl}(0,8)$ and $\text{Cl}(1,9) = \text{Cl}(1,5) \times \text{Cl}(0,4) = \text{Cl}(2,4) \times \text{Cl}(0,4)$ where

the vector space of $\text{Cl}(2,4)$ is 6-dim Conformal Spacetime

which contains 4-dim Minkowski Spacetime M_4 of $\text{Cl}(1,3)$

and

the vector space of $\text{Cl}(0,4)$ corresponds to $CP^2 = SU(3) / SU(2) \times U(1)$

so that

before breaking Octonionic symmetry non-unitarity of Octonion Quantum Processes allows particle creation during the Inflation Era

and

after breaking non-unitary Octonionic 8-dim Spacetime

to unitary Quaternionic Spacetime, thus ending the Inflation Era,

the Spacetime of the hyperfinite AQFT is (4+4)-dim $M_4 \times CP^2$ Kaluza-Klein

Through $Cl(0,16)$ the sequence is in Clifford Algebras whose Vectors are Powers of 2 so that the D_4 lattice spheres of Radius = Vector Dim contain 24 vertices
The 24-cell has 24 vertices

For the prime $p = 2$ the Broussous method gives

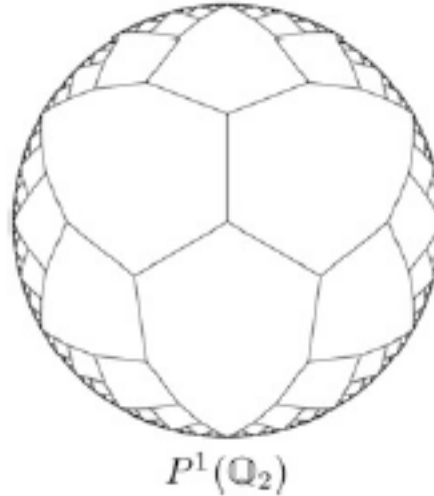

which as you can see has $p+1 = 2+1 = 3$ trees from the center with 2-fold branching to the edge of the circle (infinity in the hyperbolic Poincare Plane type projection).
The binary 2-fold branching is like the YiJing
and
the binary + and - charges of electromagnetism
and
the binary system of fermion particles and antiparticles
and
the geometry of hypercubes.

(image from Paul Broussous web page www-math.univ-poitiers.fr/%7Ebroussou/recherche.htm)

At $Cl(0,24)$, the Vectors have a Factor of 3
 so that
 the D_4 lattice sphere of Radius = Vector Dim = 24 contains $(1+3) \times 24 = 96$ vertices
 The 24-cell has 96 edges.

For the prime $p = 3$ the Broussous method gives

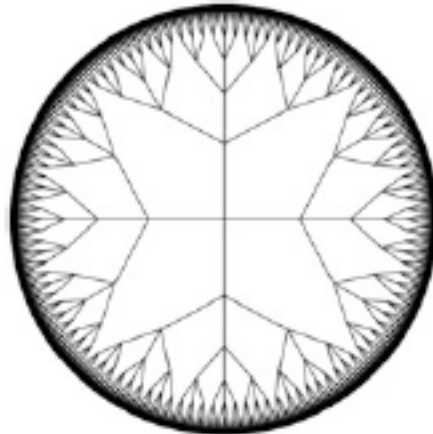

$P^1(Q_3)$

which has $p+1 = 3+1 = 4$ trees from the center
 with 3-fold branching to the edge of the circle (infinity in
 the hyperbolic Poincare Plane type projection).
 3-fold branching may correspond to such things as:
 the geometry of sub-hypercubes of a hypercube;
 and
 the Tai Hsuan Ching of $3 \times 3 \times 3 \times 3 = 81$ tetragrams of ternary lines

(image from Paul Broussous web page www-math.univ-poitiers.fr/~%7Ebroussou/recherche.htm)

At $Cl(1,25)$, the Vectors have a Factor of 13
 so that
 the D_4 lattice sphere of Radius = Vector Dim = 26 contains $(1+13) \times 24 = 336$ vertices

For the prime $p = 13$ the Broussous method gives

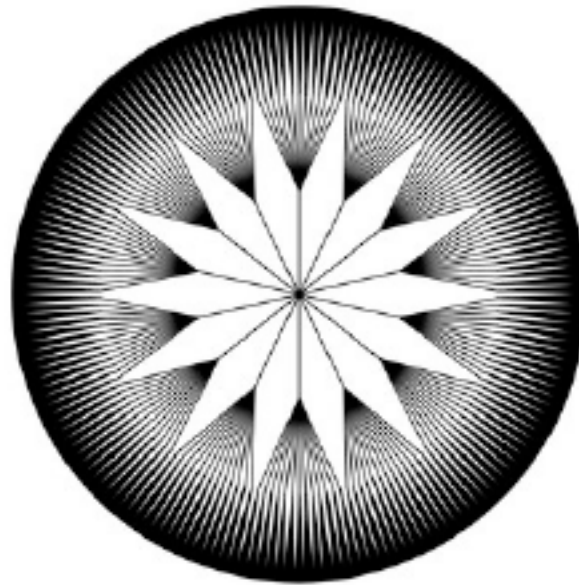

which has $p+1 = 13+1 = 14$ trees from the center
 with 13-fold branching to the edge of the circle (infinity in
 the hyperbolic Poincare Plane type projection).

(image from Paul Broussous web page www-math.univ-poitiers.fr/~Ebroussou/recherche.htm)

13 is the only number between 5 and 89 that is both Prime and Fibonacci.
 The 14 trees correspond to the 14 sections of the Klein Configuration.

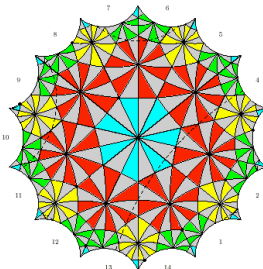

Klein Configuration represents group $SL(2,7)$ with 336 elements.
 $SL(2,7)$ is double cover of simple Klein Quartic symmetry group $PSL(2,7) = SL(3,2)$
 Klein Configuration has central 14-gon, and so 14 slices.
 Each slice has 24 triangles.

Prime Powers of 2 sequence = Sloane OEIS A036378

n=0: $2^1 = 2$ has 1 prime
2,

n=1: $2^2 = 4$ has 1 prime
3,

n=2: $2^3 = 8$ has 2 primes
5, 7,

n=3: $2^4 = 16$ has 2 primes
11, 13,

n=4: $2^5 = 32$ has 5 primes
17, 19, 23, 29, 31,

n=5: $2^6 = 64$ has 7 primes
37, 41, 43, 47, 53, 59, 61,

n=6: $2^7 = 128$ has 13 primes
67, 71, 73, 79, 83, 89, 97, 101, 103, 107, 109, 113, 127,

n=7: $2^8 = 256$ has 23 primes
131, 137, 139, 149, 151, 157, 163, 167, 173, 179, 181, 191, 193, 197, 199,
211, 223, 227, 229, 233, 239, 241, 251,

n=8: $2^9 = 512$ has 43 primes
257, 263, 269, 271, 277, 281, 283, 293, 307, 311, 313, 317, 331, 337, 347,
349, 353, 359, 367, 373, 379, 383, 389, 397, 401, 409, 419, 421, 431, 433,
439, 443, 449, 457, 461, 463, 467, 479, 487, 491, 499, 503, 509,

n=9: $2^{10} = 1024$ has 75 primes
521, 523, 541, 547, 557, 563, 569, 571, 577, 587, 593, 599, 601, 607, 613,
617, 619, 631, 641, 643, 647, 653, 659, 661, 673, 677, 683, 691, 701, 709,
719, 727, 733, 739, 743, 751, 757, 761, 769, 773, 787, 797, 809, 811, 821,
823, 827, 829, 839, 853, 857, 859, 863, 877, 881, 883, 887, 907, 911, 919,
929, 937, 941, 947, 953, 967, 971, 977, 983, 991, 997, 1009, 1013, 1019, 1021

n=10: $2^{11} = 2048$ has 137 primes

		1031	1033	1039	1049	1051	1061	1063	1069
1087	1091	1093	1097	1103	1109	1117	1123	1129	1151
1153	1163	1171	1181	1187	1193	1201	1213	1217	1223
1229	1231	1237	1249	1259	1277	1279	1283	1289	1291
1297	1301	1303	1307	1319	1321	1327	1361	1367	1373
1381	1399	1409	1423	1427	1429	1433	1439	1447	1451
1453	1459	1471	1481	1483	1487	1489	1493	1499	1511
1523	1531	1543	1549	1553	1559	1567	1571	1579	1583
1597	1601	1607	1609	1613	1619	1621	1627	1637	1657
1663	1667	1669	1693	1697	1699	1709	1721	1723	1733
1741	1747	1753	1759	1777	1783	1787	1789	1801	1811
1823	1831	1847	1861	1867	1871	1873	1877	1879	1889
1901	1907	1913	1931	1933	1949	1951	1973	1979	1987
1993	1997	1999	2003	2011	2017	2027	2029	2039	

Prime Powers of 2 sequence = Sloane OEIS A036378

Number of primes p between powers of 2, $2^n < p \leq 2^{(n+1)}$
is

1, 1, 2, 2, 5, 7, 13, 23, 43, 75, 137, 255, 464, 872, 1612,
3030, 5709, 10749, 20390, 38635, 73586, 140336, 268216, 513708,
985818, 1894120, 3645744, 7027290, 13561907, 26207278, 50697537,
98182656, 190335585, 369323305, 717267168, 1394192236 ...

..

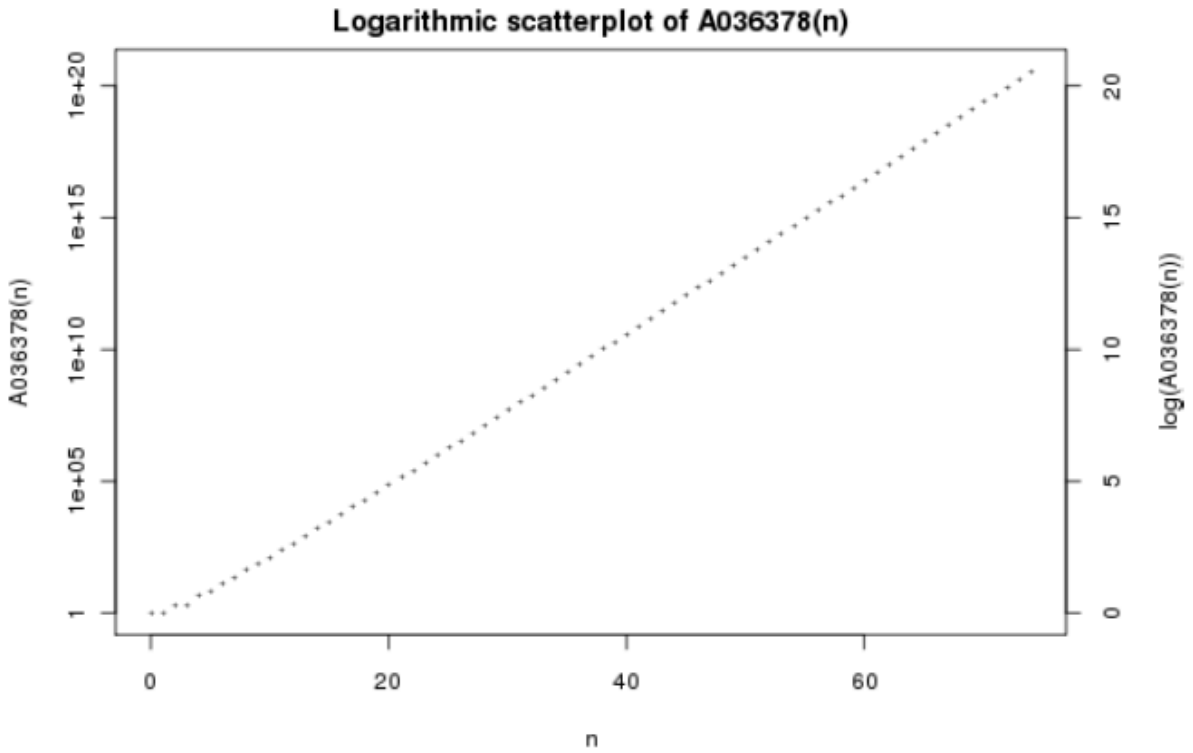

Conway and Smith, in "On Quaternions and Octonions" said:
 "... algebraists take "integer" to mean member of what's called a maximal order ...
 those octonions for which all the coordinates are ordinary integers ...
 we call ... the Gravesian octaves or integers.

... Theorem 1. The orders containing the Gravesian integers
 are precisely the 16 integer systems ...

an octonion whose coordinates are in $(1/2)Z$...[and]... are not also in Z
 form what we shall call the halving-set ... introduce the notation ...

$$i_{abcd} \text{ for } \frac{i_a + i_b + i_c + i_d}{2}, \quad i_{a\bar{b}c\bar{d}} \text{ for } \frac{i_a - i_b + i_c - i_d}{2}.$$

... We can specify one of the 16 systems by saying just which the halving-sets sets are.
 The multiplicative structure of the octonions already involves a distinguished family of
 quadruplets, namely those that correspond to quaternion subalgebras, together with
 their complements. These, ...[and]... the empty and full sets, we call the sixteen oo-sets:

$$\Omega = \begin{matrix} \emptyset & \infty 124 & \infty 235 & \infty 346 & \infty 450 & \infty 561 & \infty 602 & \infty 013 \\ \infty 0123456 & 0356 & 0146 & 0125 & 1236 & 0234 & 1345 & 2456. \end{matrix}$$

... An octonion whose halving-set is an oo-set we call an "oo-integer" ...

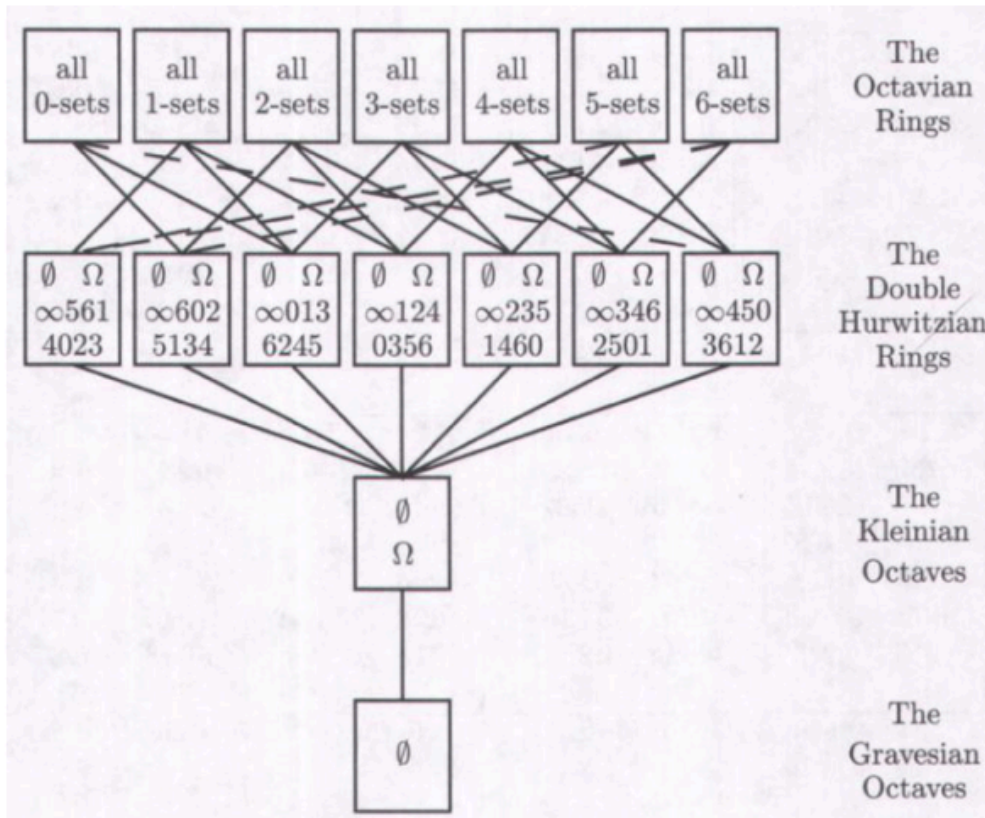

... or "Kirmse integer" ...[which]... are not multiplicatively closed. ...

define the n-sets and n-integers (n = by interchanging oo with n in the definition of oo-sets and oc-integers ... with outer n-sets in bold ...

$\infty 124$ 0356 $\infty 235$ 1460 $\infty 346$ 2501 $\infty 450$ 3612 $\infty 561$ 4023 $\infty 602$ 5134 $\infty 013$ 6245 \emptyset Ω	0124 $\infty 356$ 0235 146 ∞ 0346 25 $\infty 1$ $\infty 450$ 3612 0561 4 $\infty 23$ $\infty 602$ 5134 $\infty 013$ 6245 \emptyset Ω	$\infty 124$ 0356 1235 $\infty 460$ 1346 250 ∞ 1450 36 $\infty 2$ $\infty 561$ 4023 1602 5 $\infty 34$ $\infty 013$ 6245 \emptyset Ω	$\infty 124$ 0356 $\infty 235$ 1460 2346 $\infty 501$ 2450 361 ∞ 2561 40 $\infty 3$ $\infty 602$ 5134 2013 6 $\infty 45$ \emptyset Ω
∞ - sets	0 - sets	1 - sets	2 - sets
3124 0 $\infty 56$ $\infty 235$ 1460 $\infty 346$ 2501 3450 $\infty 612$ 3561 402 ∞ 3602 51 $\infty 4$ $\infty 013$ 6245 \emptyset Ω	$\infty 124$ 0356 4235 1 $\infty 60$ $\infty 346$ 2501 $\infty 450$ 3612 4561 $\infty 023$ 4602 513 ∞ 4013 62 $\infty 5$ \emptyset Ω	5124 03 $\infty 6$ $\infty 235$ 1460 5346 2 $\infty 01$ $\infty 450$ 3612 $\infty 561$ 4023 5602 $\infty 134$ 5013 624 ∞ \emptyset Ω	6124 035 ∞ 6235 14 $\infty 0$ $\infty 346$ 2501 6450 3 $\infty 12$ $\infty 561$ 4023 $\infty 602$ 5134 6013 $\infty 245$ \emptyset Ω
3 - sets	4 - sets	5 - sets	6 - sets

... The n-integers are multiplicatively closed for each n = 0,...,6. ...
The seven systems are ... isomorphic ...

the 0-integers ... halving-sets are

$$\emptyset \quad 0124 \quad 0235 \quad 0346 \quad \infty 450 \quad 0561 \quad \infty 602 \quad \infty 013$$

$$\Omega = \infty 0123456 \quad \infty 356 \quad \infty 146 \quad \infty 125 \quad 1236 \quad \infty 234 \quad 1345 \quad 2456.$$

...

The resulting systems are seven of the sixteen orders ... the seven maximal ones ...
The intersections of pairs of these, which are also the intersections of certain triples, yield the seven "double Hurwitzian" systems. (The halving-sets 0, S2, oc124, 0356 for the typical one of these show that it is obtained by Dickson doubling from a Hurwitzian ring of quaternions.) The intersection of all seven maximal systems, which is equally the intersection of any two of the double Hurwitzian systems, we call the Kleinian octaves, since they can be obtained from Graves's integer octaves by adjoining $(1/2) (1 + i0 + \dots + (1/2) (1 + \text{sqrt}(-7)), + i6)$, which ... is a "Kleinian" integer ...

...

the number of vectors in E8 of norm $2n > 0$
is 240 times the sum of the cubes of the divisors of n

...

a primitive octavian integer p of norm mn has precisely
 240 left-hand divisors of norm m
 and 240 right-hand divisors of norm n ,
 each set geometrically similar to the 240 units of O_8 ...

This result is analogous to the result ... for the Hurwitz integers, except that in O_8 ,
 the factorizations are not unique "up to unit-migration" in view of the lack of associativity
 ... the set of left-hand divisors of a given octavian integer is geometrically similar to the
 set of all octavian integers of a certain norm

...

Theorem 7. The number of factorizations of a primitive octavian,

$$\text{say } Q = ((P_1 P_2) (P_3 (P_4 \dots P_k))),$$

modelled on a given factorization of its norm is $240^{(k-1)}$.

Moreover, if all but P_i and P_j are fixed,

then the sets of values for P_i and P_j are geometrically similar to the set of 240 units. ...".

Appendix - Renormalization, NCG, and Tquark mass states

Truth Quark Mass from Renormalization to Planck Mass

Alvarez-Gaume, Polchinski, and Wise in Nuclear Physics B221 (1983) 495-523 said: "... there are Higgs boson self-energy graphs involving gravitons such as fig 1.

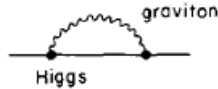

Fig. 1. Large gravitational loop contribution to the Higgs boson mass.

This graph ceases to make sense at some scale Λ where our understanding of gravity breaks down, but its contribution from momenta below Λ can be estimated as

$$\Lambda^4 / M_{\text{Planck}}^2 .$$

Unless Λ is far below the Planck scale (i.e. $\Lambda < 10^{(-9)} M_{\text{Planck}}$), this is much larger than the actual Higgs mass.

The contribution of fig. 1 must ... be canceled very precisely against a bare mass

...

The idea of driving $SU(2) \times U(1)$ symmetry breaking via a heavy quark Yukawa has been used in ... preprints by Ibanez and Ellis et al. discussing the need to include radiative corrections ... and observing that a large top quark Yukawa would drive $SU(2) \times U(1)$ breaking. Ibanez has also derived the same renormalization group equations which we give ...

The full renormalization group equations for the parameters in the lagrangian (25) are given in the appendix. They have been calculated using both component and superfield formalisms. We repeat here the equations of interest. In the running we neglect the contribution of gaugino masses, the Fayet-Iliopoulos D -term ξ , the Higgs self-coupling μ and all Yukawa couplings except g_U^{33} . For the masses, $m_{H'}^2$, $m_{U_3^c}^2$ and $m_{Q_3}^2$, we have

$$\mu \frac{\partial}{\partial \mu} \begin{bmatrix} m_{H'}^2 \\ m_{U_3^c}^2 \\ m_{Q_3}^2 \end{bmatrix} = \frac{(g_U^{33})^2}{8\pi^2} \begin{bmatrix} 3 & 3 & 3 \\ 2 & 2 & 2 \\ 1 & 1 & 1 \end{bmatrix} \begin{bmatrix} m_{H'}^2 \\ m_{U_3^c}^2 \\ m_{Q_3}^2 \end{bmatrix} + \frac{|A_U^{33}|^2 (g_U^{33})^2}{8\pi^2} \begin{bmatrix} 3 \\ 2 \\ 1 \end{bmatrix} m_g^2, \quad (45a)$$

and for the other masses

$$\mu \frac{\partial}{\partial \mu} m_i^2 = 0. \quad (45b)$$

Note that the gauge interactions make no contribution to (45), so all masses-squared would remain positive and equal to m_g^2 [cf. eq. (27)] in the absence of large Yukawa couplings*. The sign in (45) corresponds to decreasing masses-squared at low energy and the 3 : 2 : 1 weighting implies that $m_{H'}^2$ is driven negative for a sufficiently large Yukawa coupling. This is the source of $SU(2) \times U(1)$ breakdown.

...

Weak interaction breakdown occurs for top-quark masses between 100 and 195 GeV.

...

The renormalization group equation for g_U^{33}

$$\mu \frac{\partial}{\partial \mu} g_U^{33} = \frac{3}{8\pi^2} (g_U^{33})^3 - \frac{1}{8\pi^2} g_U^{33} \left(\frac{8}{3} e_3^2 + \frac{3}{2} e_2^2 + \frac{13}{18} e_1^2 \right), \quad (46)$$

tends to attract the top quark mass towards a fixed point of about 125 GeV.

...”

125 GeV is in the range of the 130 GeV Light Truth Quark of E8 Physics.

Rabindra Mohapatra in Unification and Supersymmetry Third Edition (Springer 2003, 1992, 1986) said:

“... Alvarez-Gaume, Polchinski, and Wise ... note that the effective potential ... has been defined at the Planck scale ... To study their behavior at lower energies the parameters must be extrapolated down to the TeV scale. Since the nature of the extrapolation is determined by radiative corrections, the various parameters ... will change from their values at the Planck scale ... If the process of extrapolation makes the $(\text{mass})^2$ of the Higgs ... negative, then ... it will give rise to electroweak symmetry breaking ...

It is ... possible to write the renormalization group equations for the various parameters in order to study their extrapolation from the Planck mass down to the TeV scale ... for only $SU(2)_L \times U(1)$ to occur ... m_t lies in the range $100 \text{ GeV} \leq m_t \leq 190 \text{ GeV}$

...

a ... scheme for dynamical electroweak symmetry breaking has been proposed, based on the idea ... [of] ... top-quark condensates ...

The question of the dynamical breaking of this symmetry by the formation of $\langle t_L, t_R \rangle$ condensate can be studied in a manner identical to that used by Nambu and Jona-Lasino in their classic paper on the application of the BCS model to particle physics. Working in the bubble approximation, one can convince oneself that, for $M^2 < N_c \Lambda^2 / 8 \pi^2$

... t \bar{t} condensate forms and electroweak symmetry is broken.

To get quantitative prediction from this we follow the procedure of Bardeen, Hill, and Lindner ... We see that the low-energy theory looks exactly like the standard model ... studies of the renormalization group evolution of coupling constants in the standard model ... have established that, regardless of what the numerical values of λ and h at $\mu = \Lambda$ are, they go to an almost fixed point at low energies ...

for the idea of the t \bar{t} condensates to be useful, the t -quark must be heavy.

In fact ... we must have $m_t > 95 \text{ GeV}$...

one can predict m_t and m_H , as a function of Λ . As Λ increases, m_t goes down; but if we keep $\Lambda \leq M_{Pl}$, we get $m_t \geq \sim 250 \text{ GeV}$ in the minimal model ...”.

250 GeV is in the range of the 250 GeV Heavy Truth Quark of E8 Physics.

NCG and 130 GeV Tquark Light Mass State

Connes has constructed a realistic physics model in 4-dim spacetime based on **NonCommutative Geometry (NCG) of $M \times F$** where **$M = 4\text{-dim spacetime}$ and $F = C \times H \times M3(C)$** and $C = \text{Complex Numbers}$, $H = \text{Quaternions}$, and $M3(C) = 3 \times 3 \text{ Complex Matrices}$.

E8 has been used as a basis for physics models such as those by Lisi (arXiv 1506.08073) and Smith (viXra 1508.0157) so the purpose of this paper is to show **a connection between Connes NCG Physics and E8**.

Connes NCG is described by van den Dungen and van Suijlekom in arXiv 1204.0328 where they say: "... this review article is to present the applications of Connes' noncommutative geometry to elementary particle physics.

...

the noncommutative description of the Standard Model does not require the introduction of extra spacetime dimensions, its construction is very much like the original Kaluza-Klein theories. In fact, **one starts with a product $M \times F$ of ordinary four-dimensional spacetime M with an internal space F** which is to describe the gauge content of the theory. Of course, spacetime itself still describes the gravitational part. The main difference with Kaluza-Klein theories is that the additional space is a discrete ... space whose structure is described by a ... noncommutative algebra ... This is very much like the description of spacetime M by its coordinate functions as usual in General Relativity, which form an algebra under pointwise multiplication:

$$(x^\mu x^\nu)(p) = x^\mu(p) x^\nu(p)$$

Such commutative relations are secretly used in any physics textbook. However, for a discrete space, ... propose to describe F by matrices ... yielding a much richer internal (algebraic) structure ... one can also describe a metric on F in terms of algebraic data, so that we can fully describe the geometrical structure of $M \times F$. This type of noncommutative manifolds are called almost-commutative (AC)

...

Given an AC manifold $M \times F$... the group of diffeomorphisms ... generalized to such noncommutative spaces combines ordinary diffeomorphisms of M with gauge symmetries ... we obtain a combination of general coordinate transformations on M with the respective groups ... $U(1) \times SU(2) \times SU(3)$...[whose]... finite space is ...

internal space F ...[=]... $C \times H \times M3(C)$

... to construct a Lagrangian from the geometry of $M \times F$. This is accomplished by ... a simple counting of the eigenvalues of a Dirac operator on $M \times F$ which are lower than a cutoff Λ ... we derive local formulas (integrals of Lagrangians) ... using heat kernel methods ...

The fermionic action is given as usual by an inner product. The Lagrangians that one obtains in this way ... are the right ones, and in addition minimally coupled to gravity.

This is unification with gravity of ... the full Standard Model. ...
We study conformal invariance ... with particular emphasis on the Higgs mechanism
coupled to the gravitational background

...
the Lagrangian derived ... from the relevant noncommutative space is not just the
Standard Model Lagrangian, but it implies that there are relations between some of the
Standard Model couplings and masses

...
If we would assume that the mass of the top quark is much larger than all other fermion
masses, we may neglect the other fermion masses. In that case ...

$$m_{\text{top}} \leq \sqrt{8/3} M_w [= \sqrt{8/3} 80 = 130 \text{ GeV}]$$

...
we shall evaluate the renormalization group equations (RGEs) for the Standard Model
from ordinary energies up to the ... GUT ... unification scale ...

The scale Λ_{12} ... is given by ... $1.03 \times 10^{13} \text{ GeV}$...

The [scale] Λ_{23} is given by ... $9.92 \times 10^{16} \text{ GeV}$...

we have ... included the simple case where we ignore the Yukawa coupling of the tau-
neutrino

[as is realistic with no neutrino see-saw mechanism] ... Numerical results [are]...

$$\Lambda_{\text{gut}} (10^{16} \text{ GeV}) \dots m_{\text{top}} (\text{GeV}) 186.0 \dots m_{\text{h}} (\text{GeV}) 188.1 \dots$$

$$\Lambda_{\text{gut}} (10^{13} \text{ GeV}) \dots m_{\text{top}} (\text{GeV}) 183.2 \dots m_{\text{h}} (\text{GeV}) 188.3 \dots".$$

If you do a naive extrapolation down to the Higgs $\text{VeV } 250 \text{ GeV}$ energy scale where the
compositeness of a Higgs as Tquark condensate system might become evident (the
Non-perturbativity Boundary)

$$\Lambda_{\text{comp}} (250 \text{ GeV}) \dots m_{\text{top}} (\text{GeV}) 173.2 \dots m_{\text{h}} (\text{GeV}) 189$$

so the naively extrapolated

**NCG masses for the Tquark-Higgs Middle Mass States are consistent
with those of the E8 model of Smith (viXra 1508.0157)**

Further,

**the Basic Ground State NCG Tquark mass of 130 GeV is consistent
with that of the E8 model of Smith (viXra 1508.0157)**

Here is a chart showing the 3 Mass States of the Smith E8 model (viXra 1508.0157): the green dot in the Stable region (green) has the 130 GeV Tquark mass state that is also calculated by NCG; the cyan dot on the Non-perturbativity Boundary has the 173 GeV Tquark and 189 GeV Higgs mass states that are also calculated by NCG; I have not seen where NCG may or may not calculate High-Mass (220 and 250 GeV) Tquark and Higgs mass states indicated by the magenta dot at the Critical Point.

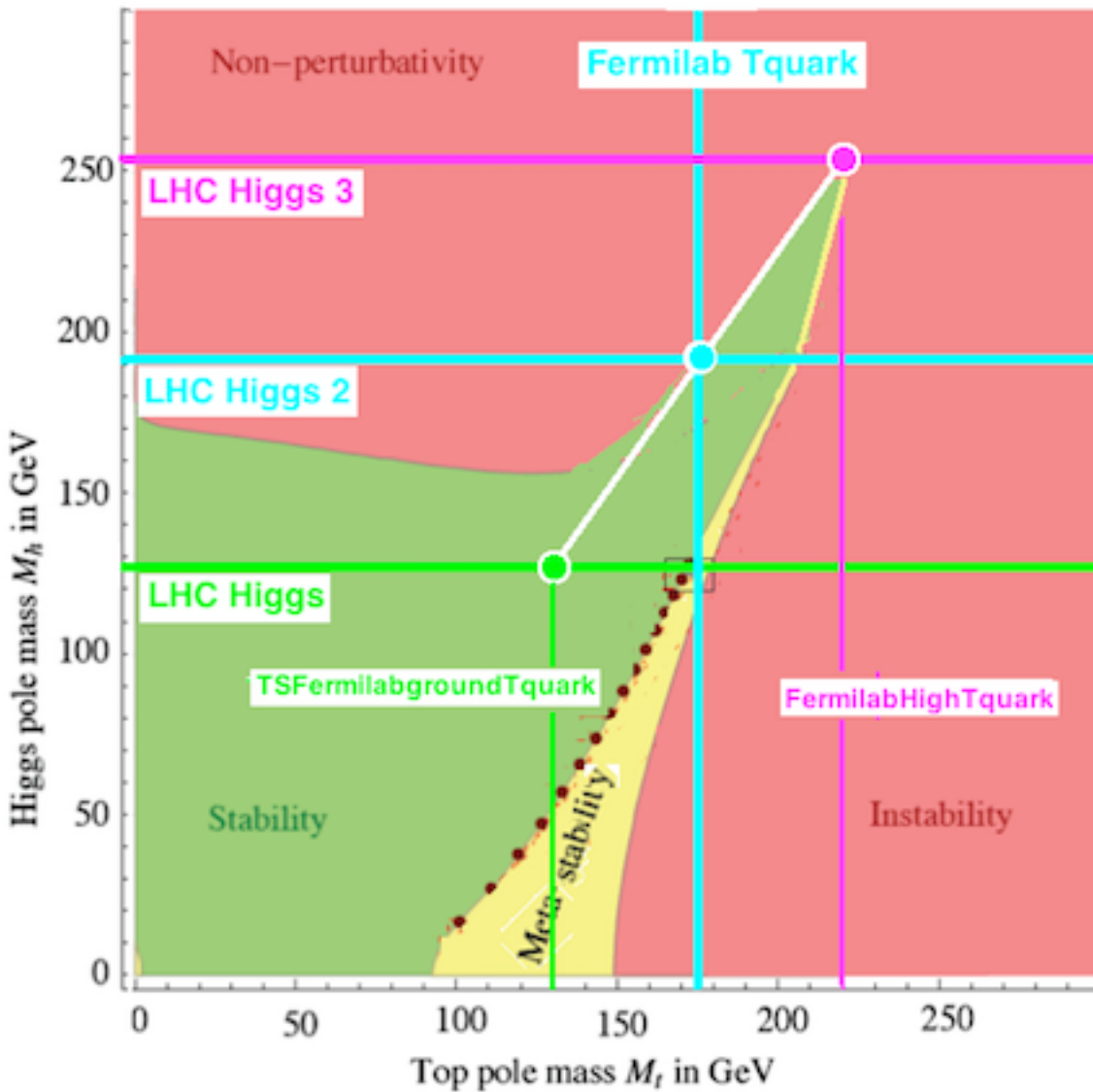

Structure of M and F of NCG

The **M of NCG** is 4-dim Spacetime, a discrete version of which is the Integral Domain of Integral Quaternions whose vertex figure (nearest neighbors to the origin) is the 24-cell Root Vector Polytope of the 28-dim D4 Lie Algebra which contains as a subalgebra the 15-dim D3 Lie Algebra of the Conformal Group $\text{Spin}(2,4) = \text{SU}(2,2)$ for MacDowell-Mansouri Gravity plus Conformal Dark Energy.

4-dim Riemannian Spacetime can be Wick Rotated to 4-dim Euclidean Space which can be compactified to the 4-sphere S^4 which can be discretized as the 600-cell

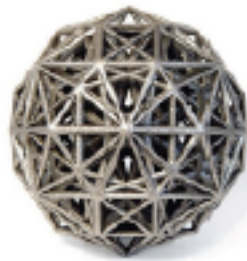

so the **M of NCG** can be locally represented as a 600-cell which has 120 vertices.

F of NCG is the 24-dim algebra $C + H + M_3(C)$.

Identify the 24 generators of F with the 24 elements of the Binary Tetrahedral Group and therefore **identify F with the Tetrahedron** of which it is the symmetry group. NCG, by using $M \times F$ as its basic structure, puts a copy of F at each point of M.

Consider a flat 2-dim subspace of M, and add to it F Tetrahedra following this construction recipe from a Don Davis 8 Sep 1999 sci math post:

“... build ... a hollow torus of 300 cells ... as follows:

lay out a 5x10 grid of unit edges. omit the lefthand and lower boundaries' edges, because we're going to roll this grid into a torus later.

thus, the grid contains 100 edges: 50 running N-S, and 50 running EW.

attach one tetrahedron to each edge from above the grid.

the opposite edges of these tetrahedra will form a new 5x10 grid, whose vertices overlie the centers of the squares in the lower grid.

thus, these 100 tetrahedra now form an egg-carton shape, with 50 squarepyramid cups on each side.

divide each cup into two non-unit tetrahedra,

by erecting a right-triangular wall across the cup, corner-to-corner.

make the upper cups' dividers run NE/SW,

and make the upside-down lower cups' dividers run NW/SE.

note that the egg-carton is now a solid flat layer, one tetrahedron deep, containing 100 unit tetra- hedra and 200 non-unit tetrahedra.

when we shrink the right-triangular dividing walls into equilateral triangles, we distort each egg-cup into a pair of unit-tetrahedra.

at the same time,
the opening of each egg-cup changes from a square to a bent rhombus.
as the square openings bend,
the flat sheet of 300 tetrahedra is forced to wrap around into a hollow torus with a one-unit- thick shell.

surprisingly,
this bends each 5x10 grid into a toroidal sheet of 100 equilateral triangles.
each grid's short edge is now a pentagon that threads through the donut hole.
the grid's long edge is now a decagon that wraps around both holes in its donut.
the two grids' long edges are now linked decagons.

this wrapping cannot occur in R3, but it works fine in R4.
I admit that this part of my presentation is not easy to visualize.
perhaps a localized visualization image will help:
as an upper egg-cup is squeezed in one direction,
the edge-tetrahedra around it rotate,
squeezing the nearby lower egg-cups in the other direction.
this forces the flat sheet into a saddle-shape.
in R4, when this saddle-bending happens across the whole egg-carton at once,
the carton's edges can meet to make the toroidal sheet.

...
build each solid torus[of]... two solid tori of 150 cells each ... as follows:
using 100 tetrahedra, assemble 5 solid icosahedra (this is possible in R4).
daisy-chain five such icosahedra pole-to-pole ... between every pair of adjacent
icosahedra, surround the common vertex with 10 tetrahedra.
each solid torus has a decagonal "axis" running through the centers
and poles of the icosahedra. each solid torus contains $5 \cdot 20 + 5 \cdot 10 = 150$
tetrahedra, and its surface is tiled with 100 equilateral triangles.
on this surface, six triangles meet at every vertex.

...

we will link these solid tori, like two links of a chain. with the hollow torus acting as a glue layer between them ...[

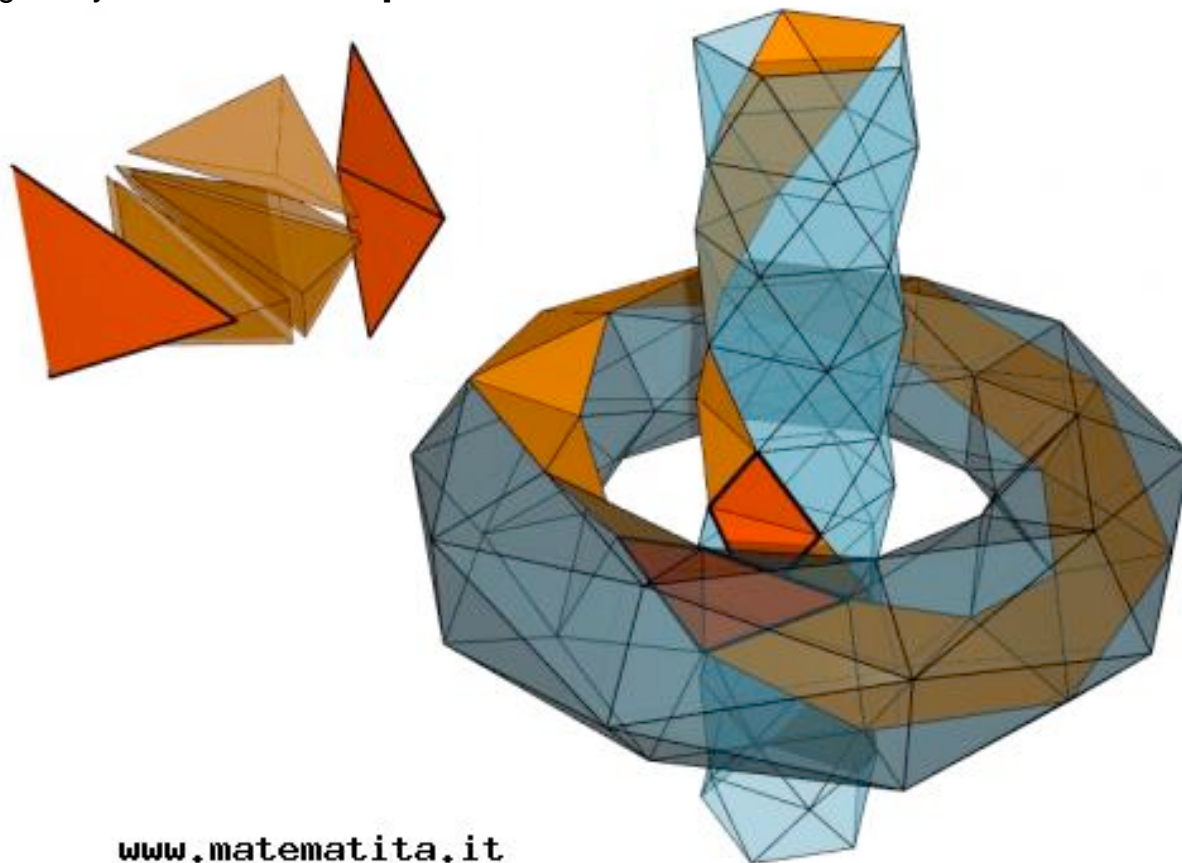

]...

finally,
put one solid torus inside the hollow toroidal sheet,
attaching the 100 triangular faces of the solid
to the 100 triangles of the sheet's inner surface.
this gives us a fat solid torus,
10 units around and 4 units thick, containing 450 tetrahedral cells.
nevertheless, its surface has only 100 triangular faces.
thread the second 150-cell solid torus through this fat torus,
and attach the two solids' triangular faces. **this is the 600-cell polytope ...**".

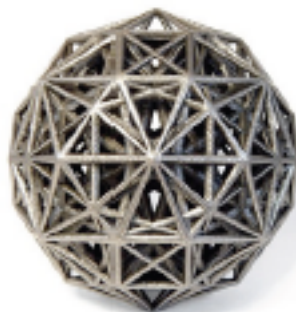

**Combine the M 600-cell (yellow)
with the F 600-cell expanded by the Golden Ratio (orange)**



**to get the $120+120 = 240$ -vertex 8-dim E8 polytope
which is the Root Vector Polytope of the Lie Algebra E8**

In this way the 8-dim space of E8 Root Vectors is seen as
being made up of two independent 4-dim spaces:
a Rational Number 4-dim space of yellow M dots
and
an Algebraic Extension by the Golden Ratio 4-dim space of orange F dots

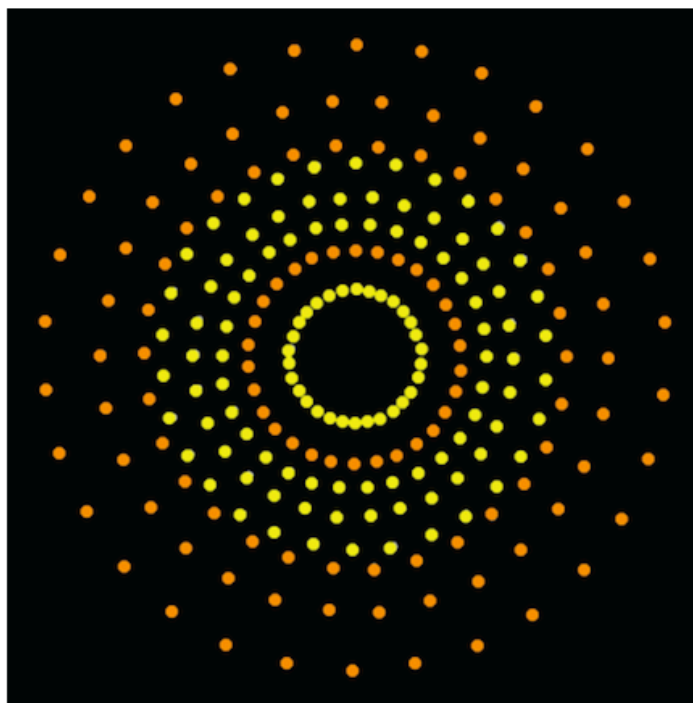

The Lie Algebra E8 lives in the Clifford Algebra $Cl(16) = Cl(8) \times Cl(8)$

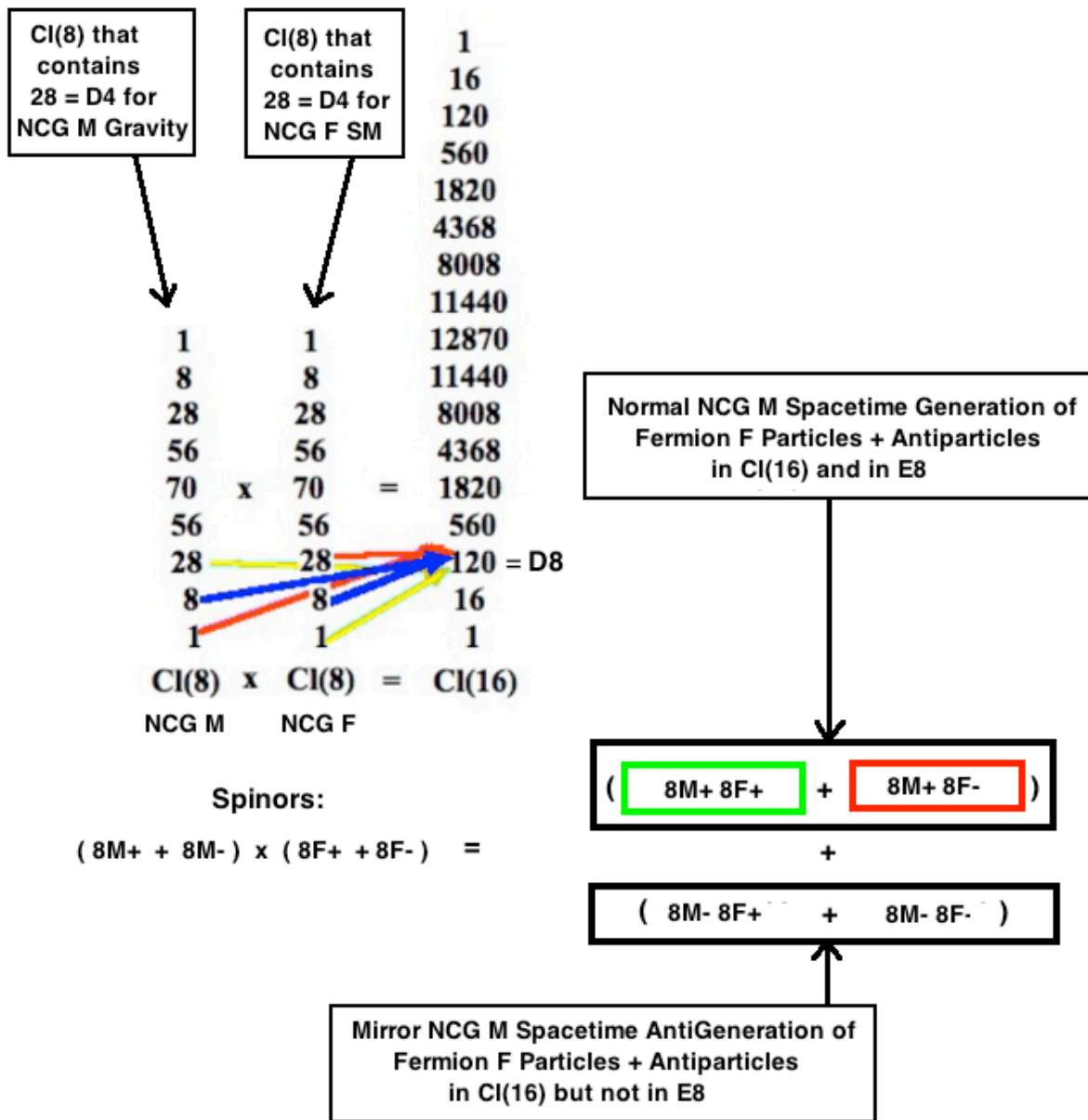

This is the basic structure of the Cl(1,25) E8 Physics Model

(see viXra 1508.0157)

Appendix - Mendel Sachs and Particle Masses

Mendel Sachs, in his books “General Relativity and Matter” (1982) and “Quantum Mechanics from General Relativity” (1986) calculated electron / muon and Proton / Tquark mass ratios substantially consistent with

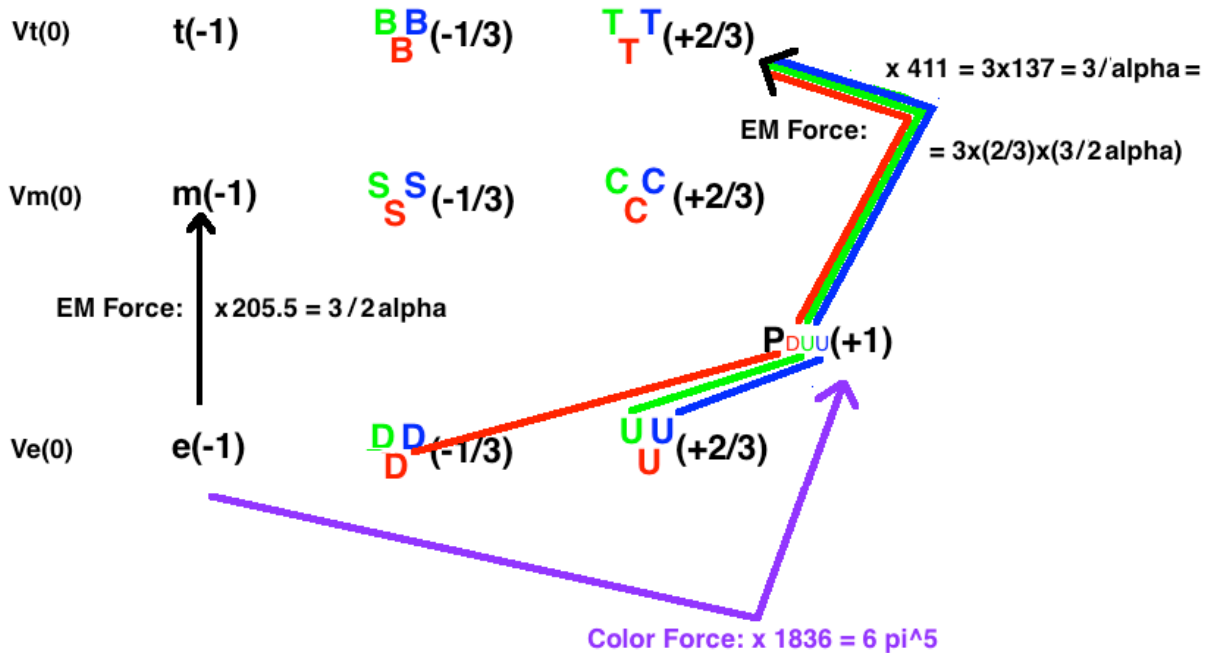

Cl(1,25) E8 Physics masses $e = 0.511$ MeV, $m = 106$ MeV, $P = 938$ MeV, $T = 128.5$ GeV saying (my comments set off by brackets [[]]):

“... the inertial mass of an elementary (spinor) particle [i]s determined by the curvature of space-time in its vicinity, representing the coupling of this particle to its environment of particle-antiparticle pairs ...

[[In Cl(1,25) E8 Physics the particle-antiparticle pairs form a Schwinger Source Kerr-Newman Black Hole]]

Because the coupling of the observed electron to the pairs ... is electromagnetic, the electron's mass is proportional to the fine structure constant ...

[[In Cl(1,25) E8 Physics the gauge symmetry of the force determines the geometry of the Schwinger Source and its Green's Function.]]

The electron mass is one member of a mass doublet, predicted by this theory.

The other member, the muon, arises because occasionally the observed electron can excite a pair of the background, which in turn changes the features of the geometry of space-time in the vicinity of the electron. ...

[[In Cl(1,25)E8 Physics the “excite” producing second and third generations is due to World-Lines traversing CP2 Internal Symmetry Space as well as M4 Physical Spacetime of M4xCP2 Kaluza-Klein]]
Because the excitation of the pair is due to an electromagnetic force, the new mass ... is $3/2 \alpha = 206$ times greater than the old mass. ...

This theory also predicts that the proton should have a sister member of a doublet ...

To compute the inertial mass of the electron, consider first the frame of reference whose spatial origin is at the site of the observed electron, with the pairs of the background in motion relative to this point

...

Using the method of Green's functions ... we see that the quaternion metrical field ... in the linear approximation, reduce to an integral equation with ... solutions ...[that]... are the linear approximation ... to the spin-affine connection field ... the solutions ... of the integral Equation ... lead directly to the (squared) mass eigenvalues ... the eigenvalues of the mass operator are the absolute values of the squares of the matrix elements above

...

The pairs interact with each other in a way that makes them appear to some 'observed' constituent electron as 'photons'. ... Nevertheless, the pairs do have 'inertia' by virtue of their bound electrons and positrons that are not, in fact, annihilated. ... From a distance greater than a 'first Bohr orbit' of one of the particle components of a pair, it appears, as a unit, to be an electrically neutral object. But as the (observed) electron comes sufficiently close to the pair so as to interact with its separate components, energy is used up in exciting the pair, thereby decreasing the relative speed between the pair and the observed electron.

If the primary excitation of a pair (as 'seen' by the observed electron) is quadrupolar, and if the ground state of the pair corresponds to $n = 1$; then the first excited Bohr orbital with a quadrupolar component is the state with $n' = 3$.

[[Quadrupolar implies 4+4 Kaluza-Klein of $Cl(1,25)$ E8 Physics]]

With these values ... it follows that the ratio of mass eigenvalues is ... $3 / 2 \alpha = 206$... The reason for this is that the curvature of space-time, in the vicinity of the observed electron, that gives rise to its inertia, is a consequence of the electromagnetic coupling between the matter components of the system. ...

Summing up, the inertial mass of an elementary (spinor) particle was determined by the curvature of space-time in its vicinity, representing the coupling of this particle to its environment of particle-antiparticle pairs.

[[Green's functions for each force imply geometric structure of Schwinger Sources]]

The significant domain of space populated by pairs that contributes to the electron mass is the order of $10^{(-15)}$ cm ,,,

[[Schwinger Source size in $Cl(1,25)$ E8 Physics is much smaller, about $10^{(-24)}$ cm]]

Because the coupling of the observed electron to the pairs - that gives it inertia - is electromagnetic, the electron's mass is proportional to the fine structure constant - which is a measure of the strength of this coupling. ...".

Appendix - Joy Christian Correlations

Bell's Theorem

on Quantum Correlations is based on the Hopf Fibration $RP^1 \rightarrow S^1 \rightarrow S^0 = \{-1, +1\}$.

Joy Christian has shown that it is more realistic

to base Quantum Correlations on the Hopf Fibrations

$S^1 \rightarrow S^3 \rightarrow S^2 = CP^1$ and $S^3 \rightarrow S^7 \rightarrow S^4 = QP^1$ and $S^7 \rightarrow S^{15} \rightarrow S^8 = OP^1$

where R, C, Q, and O are Real, Complex, Quaternion, and Octonion Division Algebras.

In his book "Disproof of Bell's Theorem" (BrownWalker Press, 2nd ed, 2014)

Joy Christian said:

"... Every quantum mechanical correlation can be understood as

a classical, local-realistic correlation among a set of points of a parallelized 7-sphere

...

physical space ... respects the symmetries and topologies of a parallelized 7-sphere

...

because 7-sphere ...[is]... homeomorphic to the ...[Octonion]... division algebra ...

it is the property of division that ...[is]... responsible for ... local causality in the world

...

To understand this reasoning better, recall that, just as a parallelized 3-sphere is a 2-sphere worth of 1-spheres but with a twist in the manifold $S^3 (= S^2 \times S^1)$,

a parallelized 7-sphere is a 4-sphere worth of 3-spheres

but with a twist in the manifold $S^7 (= S^4 \times S^3)$

... just as S^3 is

a nontrivial fiber bundle over S^2 with Clifford parallels S^1 as its linked fibers,

S^7 is also

a nontrivial fiber bundle ... over S^4 ... with ... spheres S^3 as its linked fibers.

...

it is the twist in the bundle S^3 that forces one

to forgo the commutativity of complex numbers (corresponding to the circles S^1)

in favor of the non-commutativity of quaternions.

In other words, a 3-sphere is not parallelizable by the commuting complex numbers but

only by the non-commuting quaternions. And it is this noncommutativity that gives rise

to the non-vanishing of the torsion in our physical space.

In a similar vein, the twist in the bundle $S^7 (= S^4 \times S^3)$ forces one to forgo the

associativity of quaternions (corresponding to the fibers) in favor of the non-associativity of octonions.

In other words, a 7-sphere is not parallelizable by the associative quaternions but

only by the non-associative octonions.

... it can be parallelized ... because its tangent bundle happens to be trivial:

Once parallelized by a set of unit octonions,

both the 7-sphere and each of its 3-spherical fibers remain closed under multiplication.

This, in turn, means that

the factorizability or locality condition of Bell is ... satisfied within a parallelized 7-sphere. The lack of associativity of octonions, however, entails that, unlike the unit 3-sphere [which is homeomorphic to the ... group $SU(2)$], a 7-sphere is not a group manifold ... the torsion within the 7-sphere ... varies from one point to another of the manifold. It is this variability of the parallelizing torsion within that is ultimately responsible for the diversity and non-linearity of the quantum correlations we observe in nature ...”.

The 7-sphere S^7 is the unit sphere in 8-dim space.
 S^7 is not a Lie algebra, but is a Malcev algebra
and is naturally embedded in the D4 Lie algebra $Spin(8)$ which
is topologically composed of (but \neq the simple product $S^7 \times S^7 \times G_2$)
2 copies of S^7 and 14-dim Lie Algebra G_2 of the Octonion Automorphism Group.

28-dim D4 Lie algebra $Spin(8)$ can be represented by 8x8 antisymmetric real matrices
It is a subalgebra of 63-dim A7 Lie Algebra $SL(8, \mathbb{R})$ of all 8x8 real matrices with $\det = 1$.

Unimodular $SL(8, \mathbb{R})$ is the non-compact Lie algebra corresponding to $SU(8)$.
 $SL(8, \mathbb{R})$ effectively describes the 8-dim SpaceTime of E8 Physics
as a generalized checkerboard of SpaceTime HyperVolume Elements.
Anderson and Finkelstein in Am . J. Phys. 39 (1971) 901-904 said:
"... Unimodular relativity ... expresses the existence of a fundamental element of
spacetime hypervolume at every point. ...".

From the Real Clifford Algebra $Cl(16)$ and 8-Periodicity
64-dim $R+SL(8, \mathbb{R})$ appears from factoring $Cl(16) = \text{tensor product } Cl(8) \times Cl(8)$
as the tensor product of the 8-dim vector spaces $8v$ of each of the $Cl(8)$ factors
so that $64\text{-dim } R+SL(8, \mathbb{R}) = 8v \times 8v$
If you regard the two $Cl(8)$ as Fourier duals then
one $8v$ describes 8-dim Spacetime Position and the other $8v$ describes its Momentum.

David Brown, in May 2012 comments on scottaaronson.com blog, said:
“... Where did Bell go wrong? Bell used quantum $SU(1)$ states
whereas Christian correctly uses quantum $SU(8)$ states ...[from]...
Christian’s parallelized 7-sphere model. ...
Every quantum mechanical Christian $SU(8)$ correlation can be understood
as a realistic, non-local Christian $SU(8)$ correlations among a set of points
of a parallelized 7-sphere ... More importantly, if Christian’s theory of local realism is true
then $SU(8)$ should be the gauge group for physical reality ...”.
 $SU(8)$ is the compact version of $SL(8, \mathbb{R})$, so it seems to me that it is David Brown’s idea,
possibly motivated by $SU(8)$ and $SL(8, \mathbb{R})$ in E7 of $D = 4$ $N = 8$ supergravity models, that
Joy Christian’s S^7 Quantum Correlations have fundamental $SL(8, \mathbb{R})$ structure.

Rutwig Campoamor-Stursberg in Acta Physica Polonica B 41 (2010) 53-77 ,
“Contractions of Exceptional Lie Algebras and SemiDirect Products” , showed that
SL(8,R) appears in the E8 Maximal Contraction = semi-direct product H92 x SL(8,R)
where

H92 is (8+28+56 +1+ 56+28+8)-dim Heisenberg Creation/Annihilation Algebra

so that H92 x SL(8,R) has 7-graded structure:

grade -3 = Creation of 1 fermion (tree-level massless neutrino)
with 8 SpaceTime Components for a total of 8 fermion component creators
(related to SpaceTime by Triality)

grade -2 = Creation of 8+3+1 = 12 Bosons for Standard Model
and 16 Conformal U(2,2) Bosons for MacDowell-Mansouri Gravity
for a total of 28 Boson creators

grade -1 = Creation of 7 massive Dirac fermion
each with 8 SpaceTime Components for a total of 56 fermion component creators

grade 0 = 1 + SL(8) = 1+63 = 64-dim
representing 8-dim SpaceTime of HyperVolume Elements

grade 1 = Annihilation of 7 massive Dirac fermions
each with 8 SpaceTime Components for a total of 56 fermion component annihilators

grade 2 = Annihilation of 8+3+1 = 12 Bosons for Standard Model
and 16 Conformal U(2,2) Bosons for MacDowell-Mansouri Gravity
for a total of 28 Boson annihilators

grade 3 = Annihilation of 1 fermion (tree-level massless neutrino)
with 8 SpaceTime Components for a total of 8 fermion component annihilators
(related to SpaceTime by Triality)

Here is how Physics Structures expand from Joy Christian’s S7 to E8 Physics:

7-dim S7 - Lie Algebra -> 28-dim Spin(8)

28-dim Spin(8) - Full 8x8 Matrix -> 63-dim SL(8,R)

63-dim SL(8,R) - Creation/Annihilation -> 248-dim H92xSL(8,R)

248-dim H92xSL(8,R) - Expansion -> 248-dim E8

The E8 expansion of $H_{92} \times SL(8, R)$ has physical interpretation leading to a Local Classical Lagrangian with Base Manifold Spacetime, Gravity + Standard Model Gauge Boson terms, and Fermion terms for 8-dim spacetime and First-Generation Fermions (with 4+4 dim Kaluza-Klein and Second and Third Fermion Generations emerging with Octonionic Symmetry being broken to Quaternionic) :

$$248\text{-dim } E_8 = 120\text{-dim } D_8 + 128\text{-dim half-spinors of } D_8$$

In Symmetric Space terms:

$E_8 / D_8 = (64+64)\text{-dim } (O \times O)P_2$ Octo-Octonionic Projective Plane

64 = 8 components of 8 fermion particles

64 = 8 components of 8 fermion antiparticles

$D_8 / D_4 \times D_4 = 64\text{-dim} = 8$ position coordinates \times 8 momentum coordinates

one $D_4 = 28 = 12$ Standard Model Ghosts + 16 Conformal Gravity Gauge Bosons (4 of the 16 are not in the 240 E_8 root vectors, but are in its 8-dim Cartan subalgebra)

other $D_4 = 28 = 16$ Conformal Gravity Ghosts + 12 Standard Model Gauge Bosons (4 of the 12 are not in the 240 E_8 root vectors, but are in its 8-dim Cartan subalgebra)

My E8 Physics model (viXra 1405.0030 vG) was initially inspired back in the 1980s by $D = 4, N = 8$ supergravity models.

Yoshiaki Tanii in his book "Introduction to Supergravity" (Springer 2014) said:

"... Poincare supergravity constructed in the highest spacetime dimension is $D = 11, N = 1$ theory ... the low energy effective theory of M theory ...

$D = 11$ supergravity has $AdS_4 \times S^7$ spacetime ...

This ... corresponds to the AdS_4 solution of $D = 4, N = 8$ gauged supergravity ...

$D = 4, N = 8$ gauged supergravity is ... related to

a compactification of $D = 11$ supergravity ... by a seven-dimensional sphere S^7 ...

$N = 8$ supergravity ... the maximal supergravity ...[has]... multiplets ...

$$1 \quad 8 \quad 28 \quad 56 \quad 70 \quad 56 \quad 28 \quad 8 \quad 1$$

... $D = 4, N = 8$ Supergravity ... has global $E_7(+7)$ and local $SU(8)$ symmetries. ...".

Supergravity itself did not quite work for me. In hindsight,

$D = 4, N = 8$ maximal global symmetry is only E_7 with maximal compact $SU(8)$

(noncompact version of $SU(8)$ is $SL(8, R)$ which is only part of the maximal contraction of E_8)

and the supergravity with maximal global symmetry E_8 with maximal compact D_8

is $D = 3, N = 8$ whose spacetime is only 3-dimensional. (Samtleben, arXiv 0808.4076).

The S^7 led me to work with $Spin(8)$ which is the bivector Lie algebra

of the Real Clifford Algebra $Cl(8)$ with graded structure $1 \quad 8 \quad 28 \quad 56 \quad 70 \quad 56 \quad 28 \quad 8 \quad 1$

When $Spin(8)$ seemed too small, I went to F_4 which contained

$Spin(8)$ for Gauge Bosons, $Spin(9) / Spin(8)$ for 8-dim SpaceTime,

and $F_4 / Spin(9)$ for 8 fermion particles + 8 fermion antiparticles.

When F_4 failed to have desired complex structure, I went to E_6 .

When E_6 failed to have all the necessary fermion components and gauge boson ghosts,

I went to E_8 and found the E_8 Physics model that as of now seems to be realistic.

**How does Bell-Christian-Brown SL(8,R) Quantum Theory
fit with the Bohm Quantum Potential of E8 Physics
(<http://vixra.org/pdf/1405.0030vG.pdf>) ?**

Comparison of Bohm's Quantum Potential hidden variable "lambdas" with Bell's "lambdas" and Joy Christian's (arxiv 0904.4259)"lambdas": Peter Holland, in his book "The Quantum Theory of Motion, an Account of the de Broglie - Bohm Causal Interpretation of Quantum Mechanics" (Cambridge 1993) said:

"... 11.5.1 Bell's Inequality ... In discussing the EPR spin experiment Bell supposed that the results of the two spin measurements are determined completely by a set of hidden variables λ and made two assumptions which he claimed should be satisfied by a local hidden-variables theory:

(i) The result A of measuring $\sigma_1 \cdot a$ on particle 1 is determined solely by a and λ , and the result B of measuring $\sigma_2 \cdot b$ on particle 2 is determined solely by b and λ , where a and b are unit vectors with $a \cdot b = \cos(\delta)$.

Thus $A = A(a, \lambda) = \pm 1$ and $B = B(b, \lambda) = \pm 1$

Possibilities such as $A = A(a, b, \lambda)$ and $B = B(a, b, \lambda)$ are excluded.

(ii) The normalized probability distribution of the hidden variables depends only on λ : $\rho = \rho(\lambda)$.

Possibilities such as $\rho = \rho(\lambda, a, b)$ are excluded.

...

We now consider to what extent assumptions (i) and (ii) are valid in the causal [Bohm Potential] interpretation ... The hidden variables are then the particle positions x_1, x_2 (the internal orientation spin vectors s_1, s_2 along the trajectories are determined by the positions and the wavefunction ...) ... the eventual results ... for each of s_{z1} and s_{z2} is determined by the initial positions of both particles and by δ , i.e., $A = A(x_1, x_2, a \cdot b)$, $B = B(x_1, x_2, a \cdot b)$ Thus assumption (i) is not valid ...

Neither is assumption (ii) satisfied. ...

In reproducing ... the quantum mechanical correlation function ...

$P_{\psi}(a, b) = \dots = -\cos(\delta)$... the causal [Bohm Potential] interpretation disobeys both of Bell's basic assumptions. ...".

So, Bell's "lambdas" obey (i) and (ii) and so obey Bell's inequality and

Bohm's "lambdas" violate (i) and (ii) and so violate Bell's Inequality but obey the quantum experimentally observed correlation function.

Joy Christian (see arxiv 0904.4259) explicitly violates (i) by replacing $A = A(a, \lambda) = \pm 1$ and $B = B(b, \lambda) = \pm 1$ with

$A = A(a, \lambda)$ in S_2 and $B = B(b, \lambda)$ in S_2 .

However, Joy does not violate (ii). Joy says: "... once the state λ is specified and the two particles have separated, measurements of A can depend only on λ and a , but not b , and likewise measurements of B can depend only on λ and b , but not a ... [compare the (ii)-violation by Bohm's λ s as stated above] ... Assuming ... that the distribution $\rho(\lambda)$ is normalized on the space Λ , we finally arrive at the inequalities ... exactly what is predicted by quantum mechanics ... we have been able to derive these results without specifying what the complete state λ is or the distribution $\rho(\lambda)$ is, and without employing any averaging procedure ... the correlations [for the examples of 0904.4259] ... are simply the local, realistic, and deterministic correlations among certain points of ... S_3 and S_7 ... This implies that the violations of Bell inequalities ... have nothing to do with quantum mechanics per se ...".

So, even though Joy's λ s do not violate (ii), when Joy "... derive[s] ... the exact quantum mechanical expectation value ... - $a \cdot b$ " Joy's result is consistent with that of Bohm's " λ s".

Joy's " λ s" are classical and local (in Joy's sense).

Bohm's " λ s" are quantum and, since Joy does not change Bell's (ii), nonlocal (in Joy's sense).

Joy's " λ s" and Bohm's " λ s" are consistent with each other with respect to their calculated quantum expectation values.

Could Joy's "lambdas" be considered as a Classical Limit of Bohm's "lambdas" ?

Consider again Peter Holland's book in which he says:

"... 6.9 Remarks on the path integral approach ... Feynman[s] ... route to quantum mechanics ... rests on the trajectory concept and so may be expected to have some connection with the causal [Bohm Potential] formulation. ... Feynman provides a technique for computing ... the transition amplitude (Green function or propagator) ... from the classical Lagrangian ... One considers all the paths ... and associates with each an amplitude ... These tracks are ... called 'classical paths' ... one sums (integrates) over all the paths ... the solution .. is given by ... Huygens' principle ... of all the paths ... one of them will be the actual trajectory pursued by the quantum particle according to the [Bohm Potential] guidance formula ... We shall refer to ... it ... as the 'quantum path' ... For an infinitesimal time interval ... the propagator is just the classical wavefunction ... a finite path may be decomposed into many such infinitesimal steps, the net propagator being obtained by successive applications of Huygens' construction ... We may view the Feynman procedure as a method of obtaining the quantum action from the set of all classical actions. ...".

If Joy Christian's classical "lambdas" are identified with Feynman path Lagrangian / Green function propagators, and if their Huygens' sums can be seen to produce the Bohm "lambdas", then Joy's work will show a nice smooth classical limit (as opposed to Bell's discordant classical limit) for the Bohm Quantum Potential.

If the Bohm Quantum Potential can then be used as a basis for a construction of a realistic AQFT (Algebraic Quantum Field Theory) then maybe Joy Christian's work will help show a useful connection (and philosophical reconciliation) between the Classical Lagrangian physics so useful in detailed understanding of the Standard Model and of AQFT along the lines of generalization of the Hyperfinite II₁ von Neumann factor algebra.

Appendix - History of Truth Quark and Higgs Observations

The Consensus view of the Physics Community is that the Standard Model has one Higgs mass state at 125 GeV and one Tquark mass state at 174 GeV.

E8 Physics (viXra 1602.0319, 1701.0495, 1701.0496) views Higgs as a Nambu-Jona-Lasinio (NJL) type Tquark-Tantiquark Condensate with 3 mass states for Higgs and Tquark:

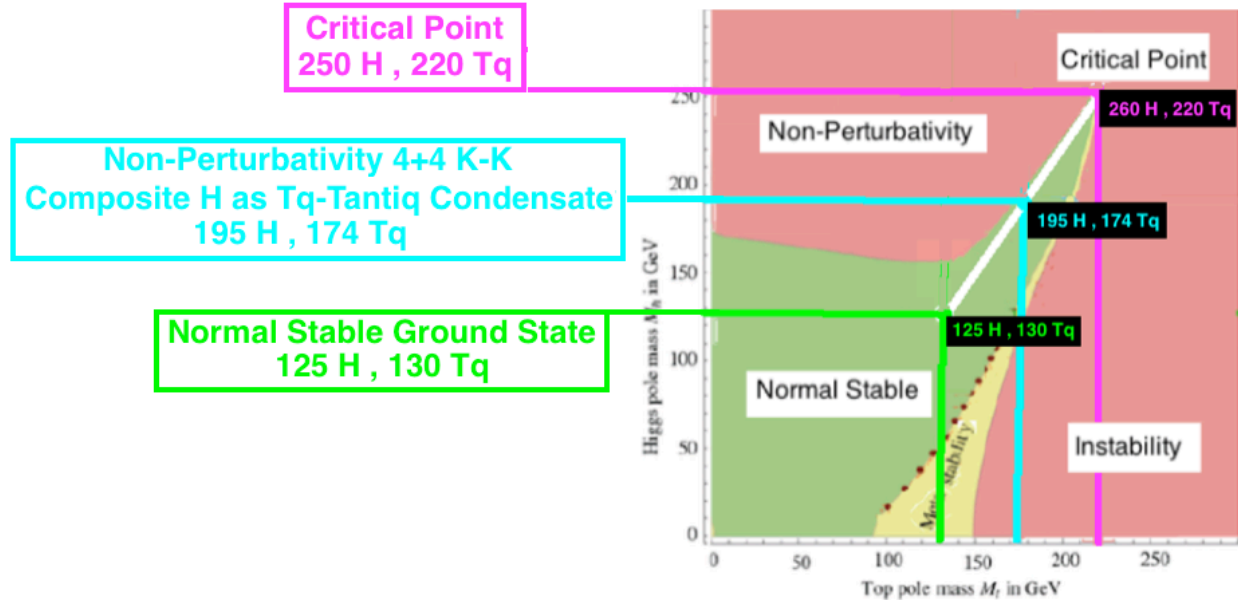

This paper describes observations of Higgs and Truth Quark mass states by experiments such as (descriptions from Wikipedia):

ARGUS - a particle physics experiment at the electron-positron collider DORIS II at DESY in Hamburg - commissioned in 1982 - operated until 1992.

HERA - DESY's largest synchrotron and storage ring for electrons and positrons - began operation in 1990 - started taking data in 1992 - closed in 2007 - detectors H1 and ZEUS

FERMILAB - site of Tevatron proton-antiproton collider at Batavia, Illinois - Tevatron was completed in 1983 and closed in 2011 - detectors CDF and D0

LEP - electron-positron collider at CERN in Geneva used from 1989 until 2000

LHC - proton-proton collider at CERN re-using the LEP tunnel - the largest single machine on Earth - built between 1998 and 2008 - detectors CMS and ATLAS - first research run at 7 to 8 TeV was from 2010 to 2013 - restarted at 13 TeV in 2015 - by the end of 2016 had 36 fb⁻¹ at 13 TeV - during 2017 had collected an additional 45 fb⁻¹ at 13 TeV for a total of 80 fb⁻¹ = 80 x 100 Trillion = 8 Quadrillion = 8 x 10¹⁵ events.

E8 model 3-state Higgs-Truth Quark NJL system

E8 Physics (viXra 1602.0319, 1701.0495, 1701.0496) views Higgs as a Nambu-Jona-Lasinio (NJL) type Truth Quark -Truth antiQuark Condensate with 3 mass states for Higgs and Truth Quark:

Low-mass - 125 GeV Higgs and 130 GeV Truth Quark
Middle-mass - 200 GeV Higgs and 174 GeV Truth Quark
High-mass - 250 GeV Higgs and 220 GeV Truth Quark

Those 3 sets of Higgs and Truth Quark mass states are, respectively:

in the Normal Stable region  with STABLE Universe

on the boundary line of non-perturbativity  at which Higgs compositeness and 8-dim Kaluza-Klein spacetime structure become manifest
(see hep-ph/0311165 by Hashimoto, Tanabashi, and Yamawaki)

at the critical point  beyond which Electroweak Symmetry is NOT broken and W and Z bosons stay massless

Fermilab has seen 3 Truth Quark mass states

and

LHC has seen 3 Higgs mass states:

1994 CDF observation of Truth Quark

26 April 1994 - FERMILAB-PUB-94/097E

A semileptonic histogram showed **three mass states of the Truth quark**

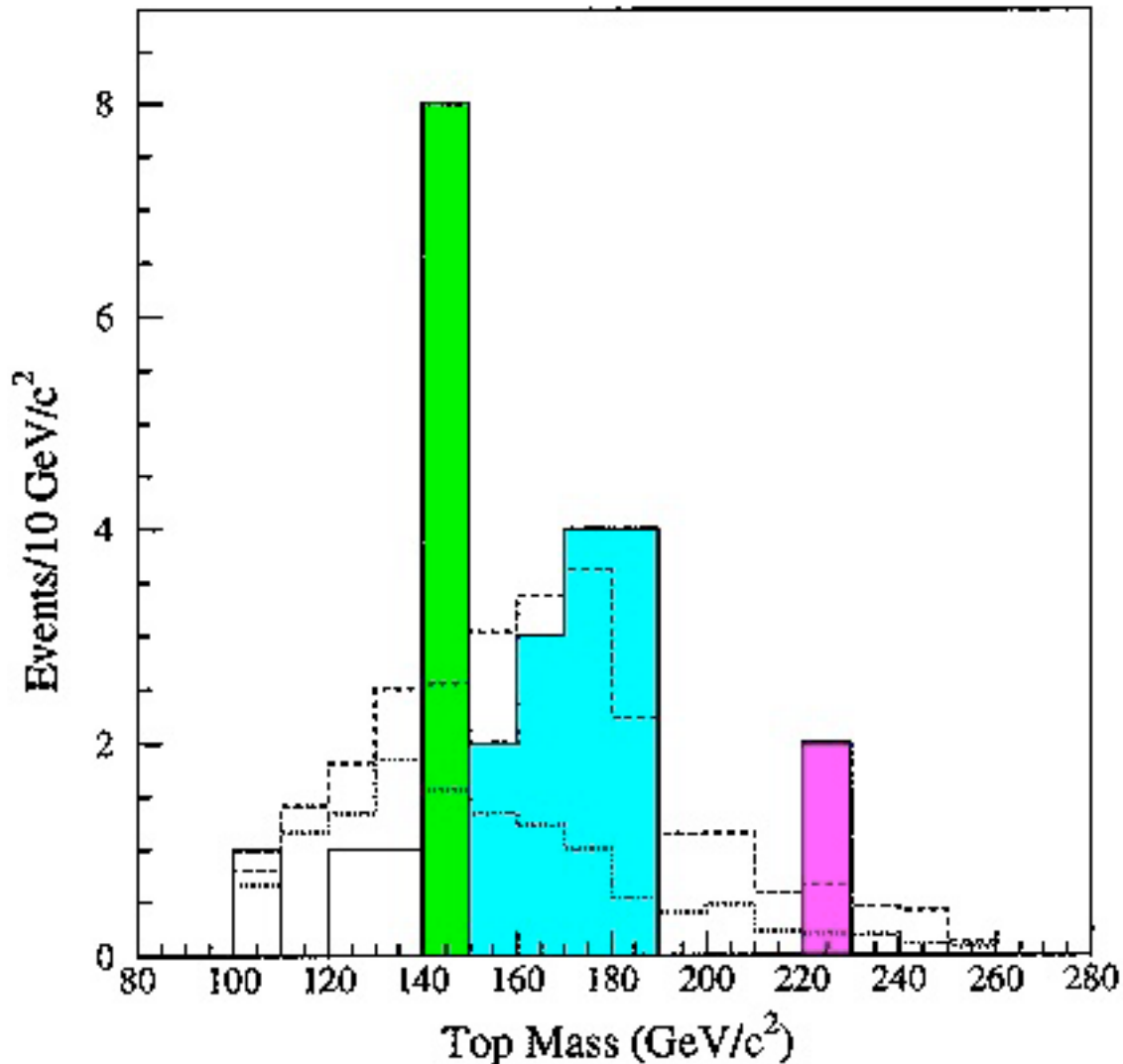

The **green** bar represents a bin in the **140-150 GeV** range consistent with the E8 Physics prediction of a Truth Quark Ground State around 130 GeV. This peak was rejected by CDF Fermilab on the (in my opinion spurious) grounds "... We assume the mass combinations in the 140 to 150 GeV/c² bin represent a statistical fluctuation since their width is narrower than expected for a top signal ...".

The **cyan** bar represents a broader peak in the **160-180 GeV** range consistent with the 174 GeV mass state of the Truth Quark that is accepted by the Consensus of the Physics Community as the one and only mass state of the Truth Quark.

The **magenta** bar represents a bin in the **220-230 GeV** range consistent with the NJL Higgs-Truth Quark system of E8 Physics and hep-ph 9603293 and 0311165. This peak was rejected by CDF Fermilab as too small (only 2 events) to be significant.

1997 D0 observation of Truth Quark

1997 - D0 hep-ex/9703008

A semileptonic histogram also showed **three states of the Truth Quark**

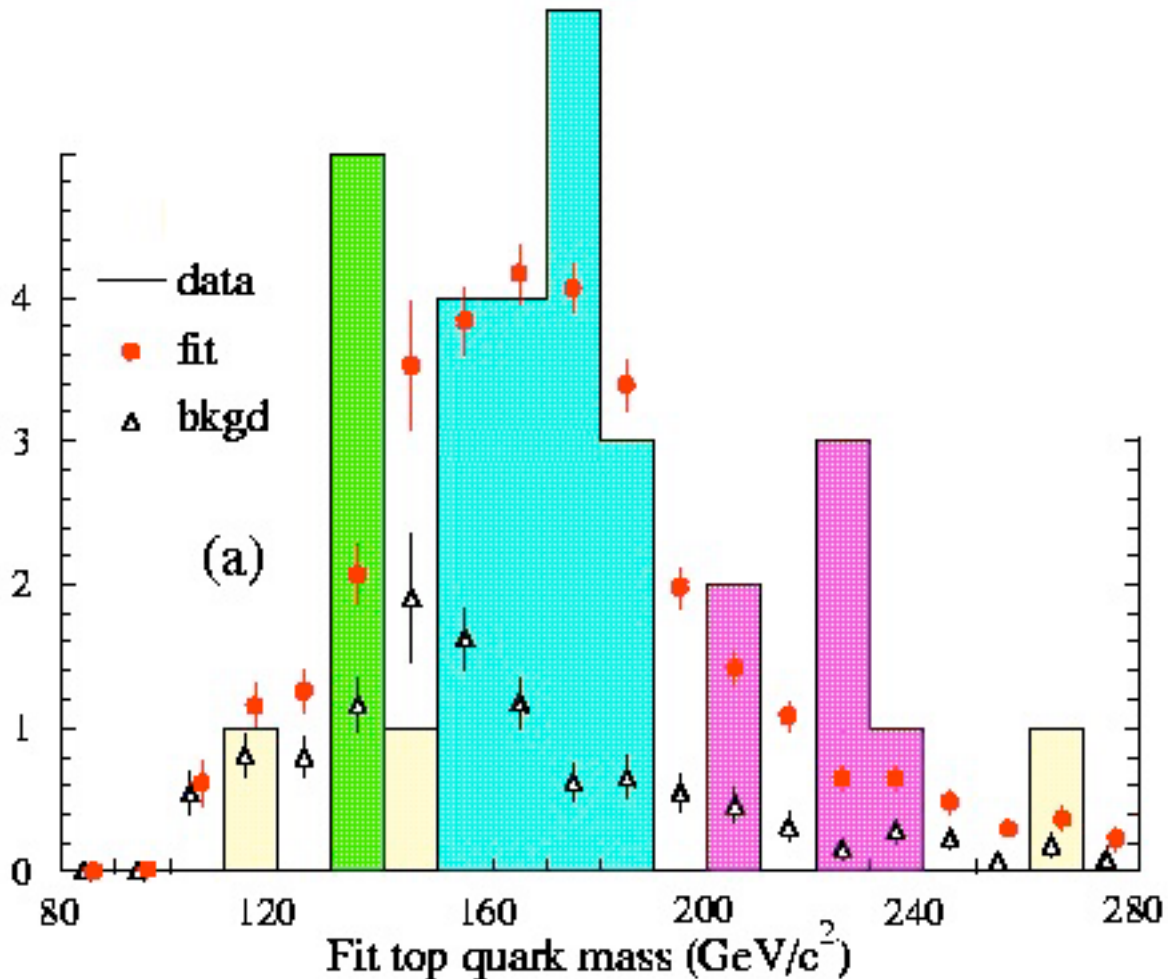

Despite confirmation of the Truth Quark Ground State around 130-140 GeV by D0 Fermilab continued (and continues to the present day) to refuse to accept it.

Fermilab happily accepted the confirmation of the Truth Quark state around 174 GeV.

Despite D0 having 6 events (not just 2) for Truth Quark in the 200-240 GeV range Fermilab continued (and continues to the present day) to refuse to accept it.

In Tommaso Dorigo's blog entry "Proofread my PASCOS 2006 proceedings" 5 Sep 2007 particularly comment 11 (by me) and comment 13 (Tommaso's reply to 11):
I asked: "... With respect to the CDF figure ...[and]... the D0 figure ... what are the odds of such large fluctuations [green peaks] showing up at the same energy level in two totally independent sets of data ? ...".

Tommaso replied: "... It is **of the order of 4-sigma**. ...".

2016-2017 LHC 13 TeV observation of Higgs

On 28 Feb 2017 the 133rd LHCC Meeting - OPEN Session - presented slides:
LHC Machine Status Report - Markus Zerlauth -

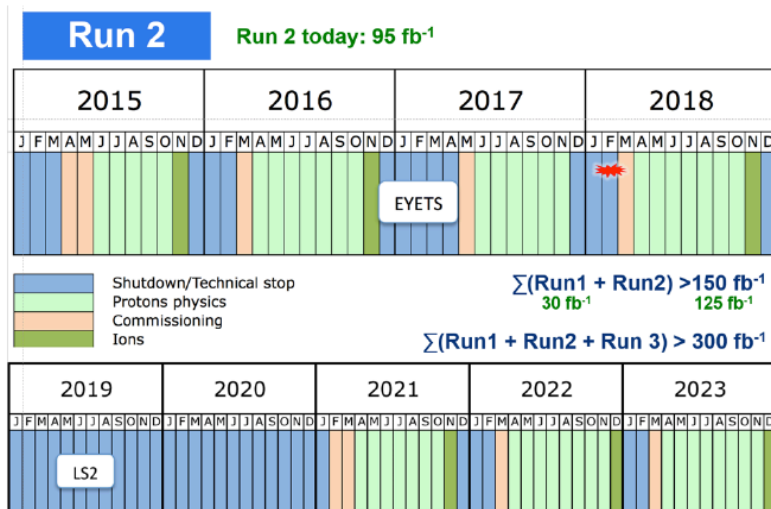
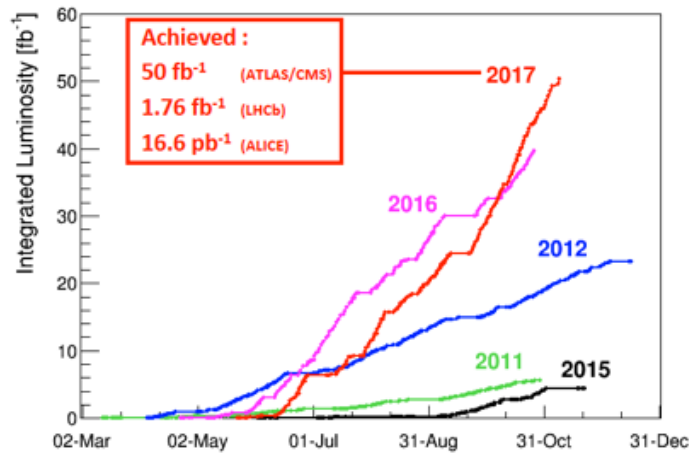

LHC schedule 2018
 A production year to complete Run 2

Goal ~55-60 fb⁻¹
 (131 days of p-p physics)
 BCMS 25ns, 13 TeV
 keeping the LHC availability close to 50% (stable beams)

As of now (March 2018) the LHC should have taken 2 independent sets of 13 TeV data each about 50 fb⁻¹:

2015-2016 Run2 (45 fb⁻¹) 2017 Run2 (50 fb⁻¹)

LHC and Fermilab Consensus View:

there is 1 Higgs at 125 GeV
there is 1 Truth Quark at 174 GeV

E8 Physics View: Higgs and Truth Quark = 3-Mass-State Nambu-Jona-Lasinio System:

Higgs at 125 GeV and Truth Quark at 130 GeV
Higgs at 200 GeV and Truth Quark at 174 GeV
Higgs at 250 GeV and Truth Quark at 220 GeV

Here are Higgs Mass - Truth Quark Mass Phase Diagrams with
Normal Stable Region in green
Non-Perturbative Region in upper part of red region
Vacuum Instability Region in right side of red region
Vacuum Metastable Region in yellow
Critical Point at Higgs Mass = Higgs VEV

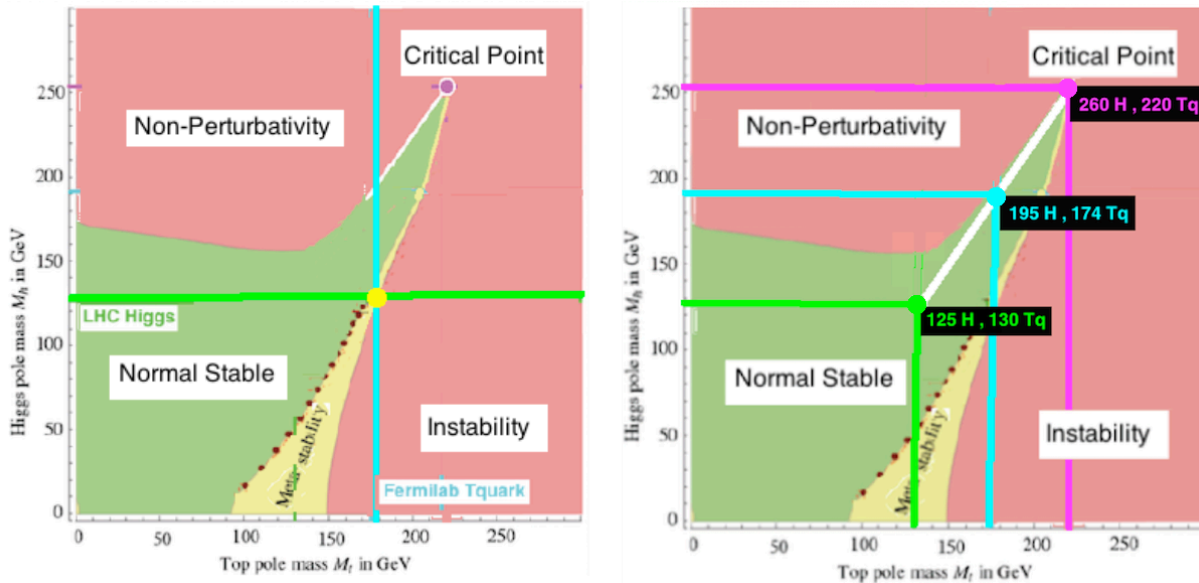

Phase Diagram on the left shows Consensus View with one Mass State
Higgs = 125 GeV and Truth Quark = 174 GeV predicting a Metastable Vacuum.

Phase Diagram on the right shows the E8 Physics View that the Higgs and Truth Quark form a 3-Mass-State Nambu-Jona-Lasinio System with

125 GeV Higgs and 130 GeV Truth Quark in the Normal Stable Region
200 GeV Higgs and 174 GeV Truth Quark on Boundary of NonPerturbative Region
250 GeV Higgs and 220 GeV Truth Quark at Critical Point

Has the LHC seen 3 Higgs Mass States of E8 Physics?

Has Fermilab seen 3 Truth Quark Mass States of E8 Physics?

As to the LHC and 3 Higgs Mass States of E8 Physics:

On 4 June 2018 at LHCP Bologna 2018 Roberto Carlin presented
 “Status and highlights from the CMS experiment”.

His Slide 14 referred to CMS-PAS-HIG-18-001 dated 3 June 2018 which says
 “... The $H \rightarrow ZZ \rightarrow 4l$ decay channel ($l = e, \mu$) has a large signal-to-background ratio
 due to the complete reconstruction of the final state decay products
 and excellent lepton momentum resolution ...

A data sample of proton-proton collisions at a center-of-mass energy of 13 TeV is used,
 corresponding to an integrated luminosity of **41.5 fb⁻¹ recorded in 2017** by the CMS
 detector at the LHC. ... Figure 2 ... Distribution of the four-lepton reconstructed
 invariant mass m_{4l} in the full mass range ...

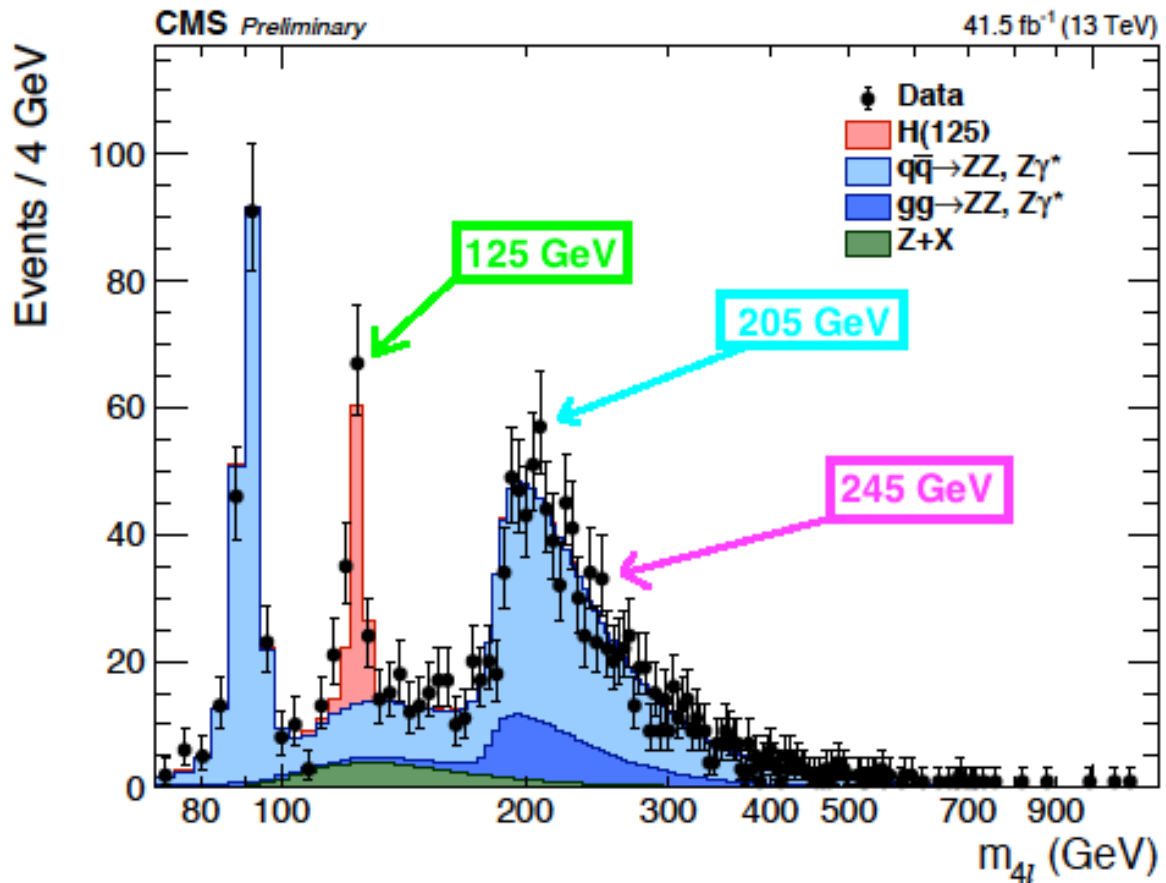

... ”

The 41.5 fb⁻¹ 2017 CMS histogram is very similar to its 35.9 fb⁻¹ 2016 counterpart

from CMS PAS HIG-17-012 (2017/12/08) Figure 2:

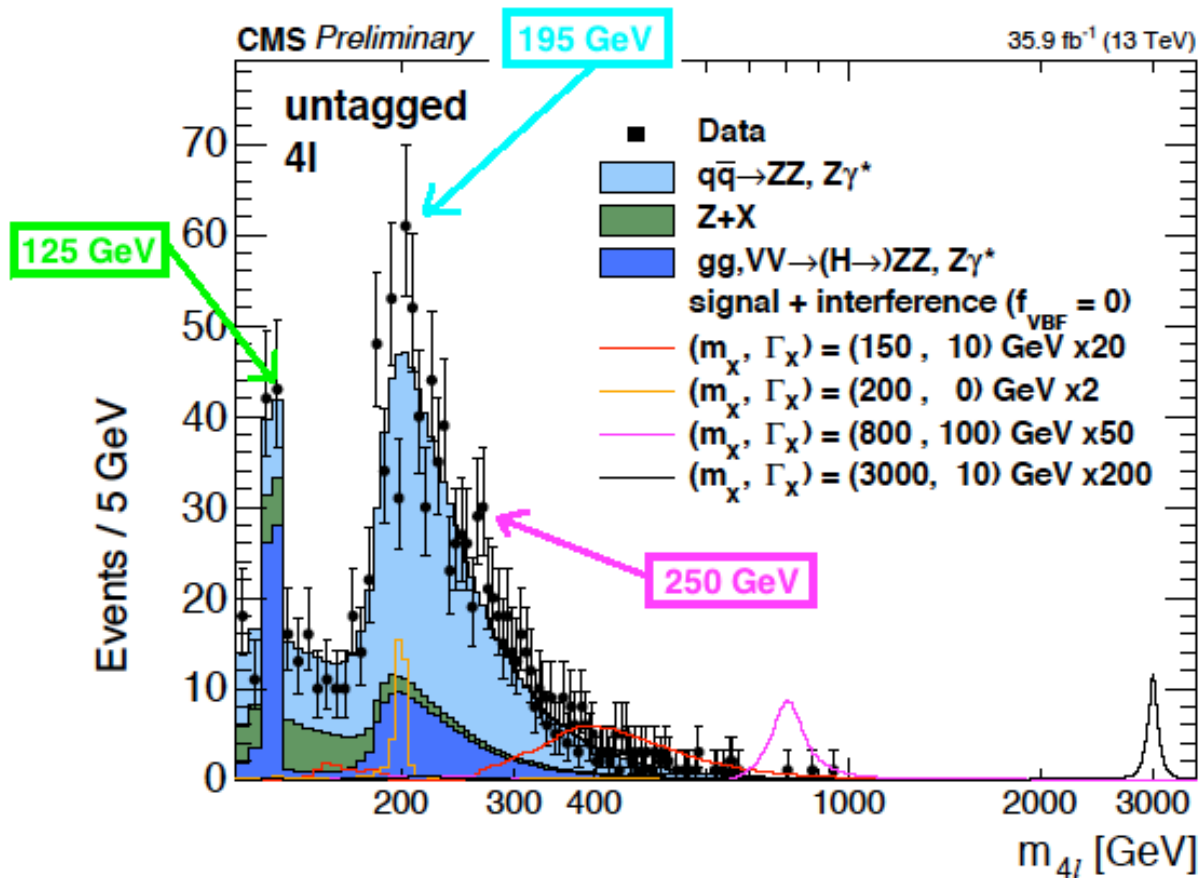

CMS PAS HIG-18-001 (2018/06/03) also says "... Combination [of 2017 data] with data recorded in 2016 by ... CMS ... 13 TeV corresponding to an integrated luminosity of 35.9 fb⁻¹ is reported ..." and is shown in the top image on the next page.

CMS used bin size 5 GeV for its 2016 data and 4 GeV for its 2017 data and for the combined 2016 + 2017 histogram (top image on next page). Tommaso Dorigo on 16 May 2011 put on his blog a post titled "Choose Bins Wisely" saying "... The only concern with too narrow bins is ...that random fluctuations might distract the user's attention from the important features of the distribution ... Let us see ... typical experimental cases ... [Case three]... Barely significant bump, small statistics ... Here I believe the narrowest binning is a bit extreme ...". Lubos Motl commented "... the main trade-off here is clear. If the bins are too wide, you lose the detailed information about the x-coordinate.

If the bins are too narrow, you lose the information about the y-coordinates - the number of events / objects in each bin becomes too fluctuating ...

It's always possible to merge bins into bigger ones ..."

In the CMS combined histogram it seems to me that there are some large fluctuations between adjacent bins so to smooth out that noise I **merged some adjacent 4 GeV bins to get 8 GeV bins** in the combined histogram

The results of **merging some 4 GeV Bins to 8 GeV Bins** are shown in the histogram at the bottom of the next page. Merged 8 GeV bins are colored **red** or **cyan** or **magenta**.

All three Higgs mass states show up more clearly using larger merged bins although the underlying data are the same.

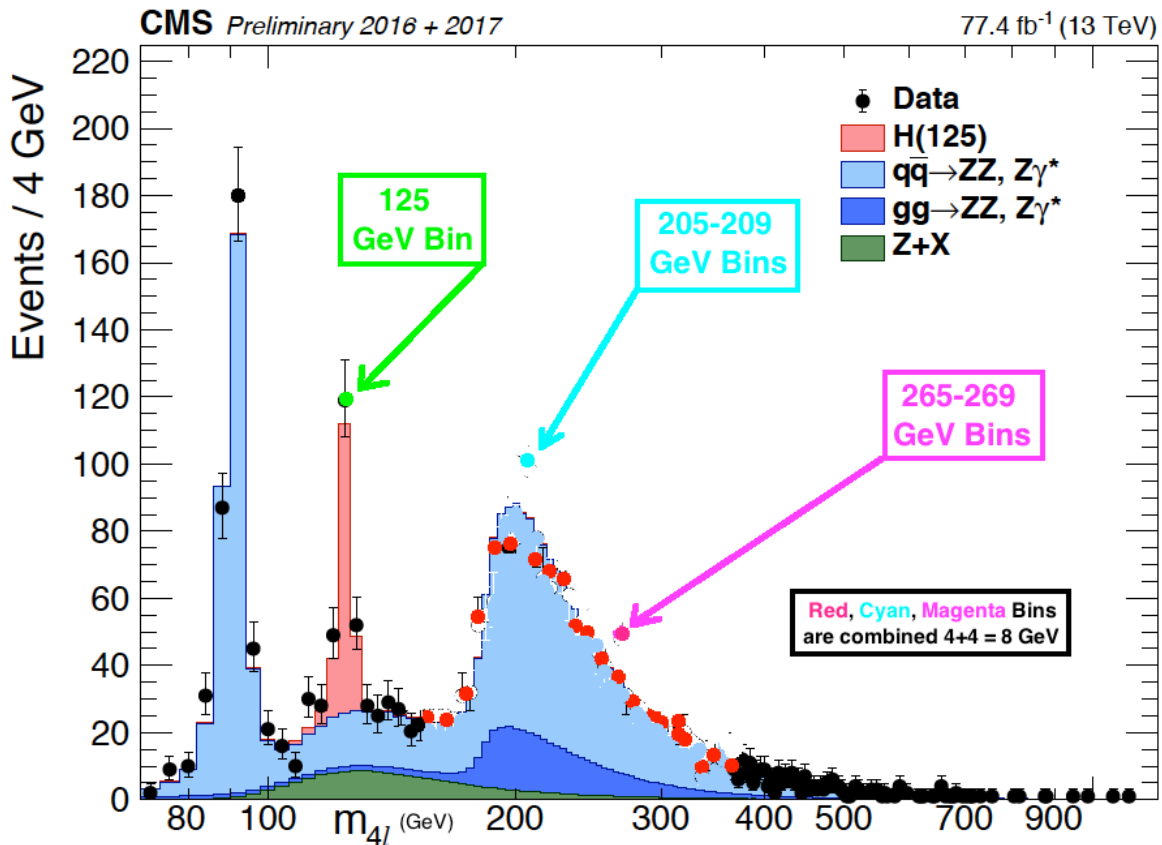
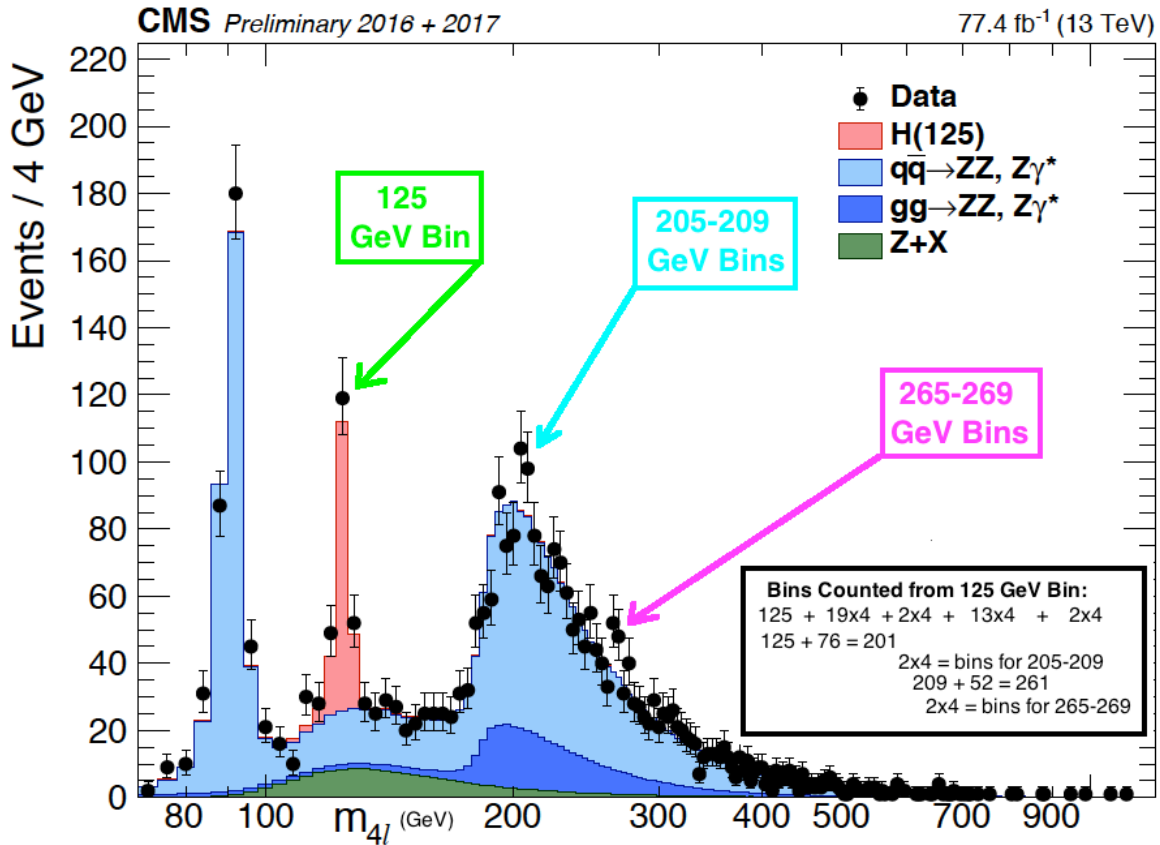

The LHC Bologna 2018 presentation “Searches for BSM Higgs Bosons ...” by Mariarosaria D’Alfonso did not contain anything relevant to Higgs \rightarrow ZZ \rightarrow 4l more recent than the histogram of Slide 14 based on 2016 data in arXiv 1804.01939

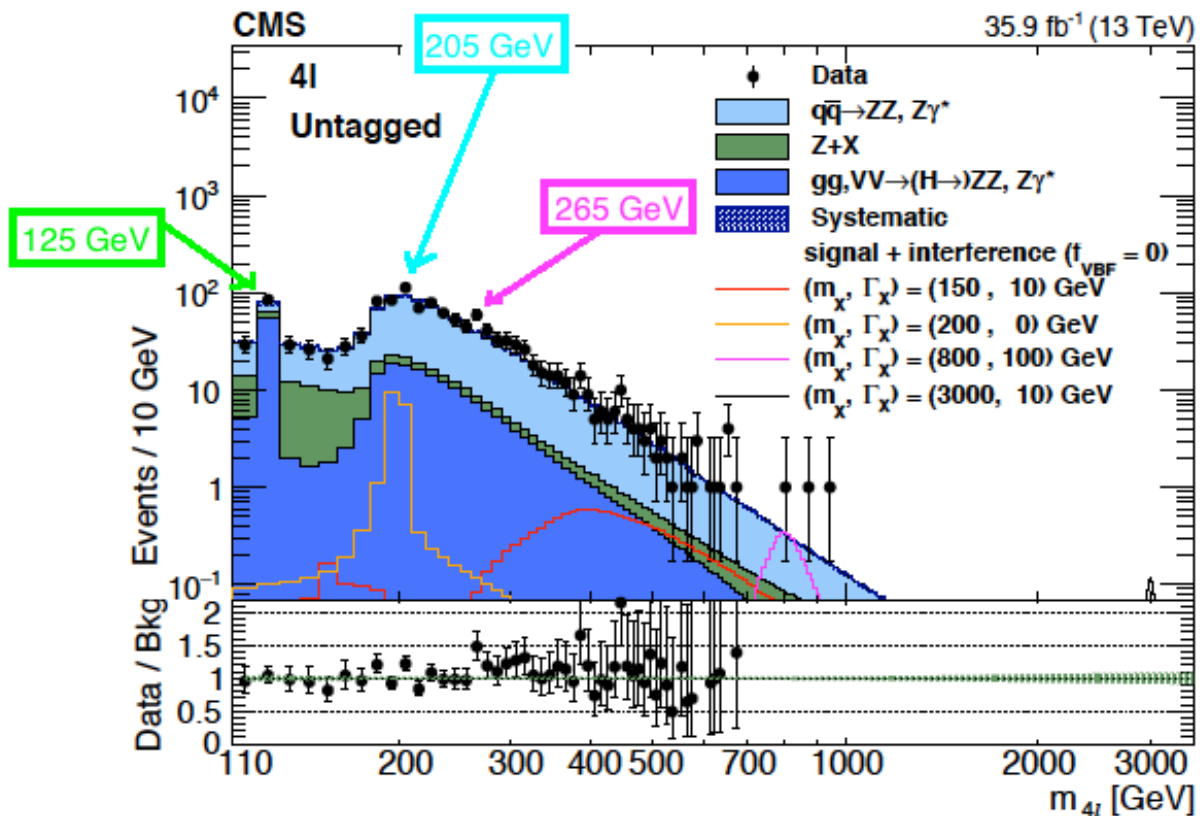

Although all three Higgs mass states are shown in the histogram, and its 10 GeV Bin width gives a smoother background than 4 GeV or 5 GeV Bin width, the use by CMS of a log scale for event number makes the states less obvious than they seem in histograms with a linear scale for event number.

Despite the clarity of the presence of all three Higgs mass states, Slide 26 says

“... BSM Higgs bosons are still hiding ...”

so the official LHC opinion is that the excess peaks around 200 GeV and 250 GeV are nothing but statistical fluctuations, which opinion may be at least in part based on using a LEE (Look Elsewhere Effect) for the histogram range 110 GeV to 3000 GeV. Since the Nambu - Jona-Lasinio 3-mass-state Higgs-as-TruthQuark-Condensate model predicts Higgs mass states around 200 GeV and 250 GeV

it is wrong apply a LEE to histogram data analysis evaluating the model.

Still further, Slide 4 says “... Full coverage of a broad m_X range is crucial to maximize the sensitivity to different ... theoretical models

(higgs SM sector + scalar, doublet, triplet ...) ...” but there is no mention ...

of the Nambu - Jona-Lasinio 3-mass-state Higgs-as-TruthQuark-Condensate model despite the fact that it is a straightforward extension of the higgs SM sector

that gives testable predictions of mass states that are observable in the Golden Channel Higgs \rightarrow ZZ \rightarrow 4l.

The ATLAS presentation at LHCP Bologna 2018 by Kunihiro Nagano shows on Slide 15 a histogram for $H \rightarrow ZZ \rightarrow 4l$ with 79.8 fb^{-1} but it is only for m_{4l} from 80 to 170 GeV so it is not relevant for excesses around 200 GeV or 250 GeV. Slide 15 referred to ATLAS-CONF-2018-018 which is dated 4 June 2018 and said “... The Higgs boson candidates within a mass window of $115 \text{ GeV} < 4l < 130 \text{ GeV}$ are selected ...” so it also is not relevant for excesses around 200 GeV or 250 GeV.

In Summary:

At LHCP Bologna 2018

CMS, despite indications in its combined 2016-2017 histogram of 3 Higgs mass states

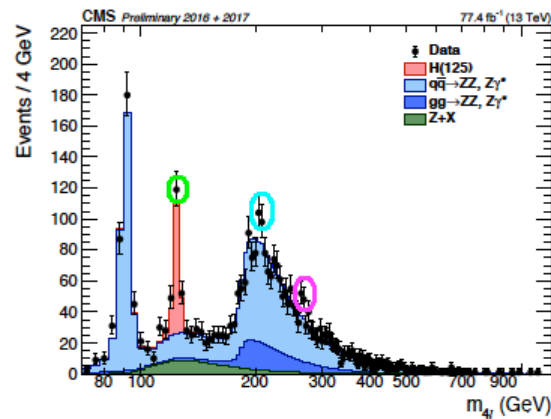

considered only the 125 GeV Higgs mass state (the SM Higgs boson), saying “... Results based on data collected in 2016 and 2017 are combined ... All results are consistent, within their uncertainties, with the expectations for the SM Higgs boson ...” and **ignoring indications of Higgs mass states around 200 GeV and 250 GeV.**

ATLAS, despite having reported in ATLAS-CONF-2017-058 for $H \rightarrow ZZ \rightarrow 4l$ channel that 2015-2016 13 TeV data showed “... **excess ... observed ... around 240 ... GeV ... with local significance 3.6 sigma ...**”, at Bologna and in ATLAS-CONF-2018-018 “selected ... Higgs boson candidates within a mass window of $115 \text{ GeV} < 4l < 130 \text{ GeV}$ ” thus also **ignoring indications of Higgs mass states around 200 GeV and 250 GeV.**

BALONEY in Bologna

CMS-ATLAS ignoring 200 and 250 GeV Higgs mass states at LHCP Bologna 2018 is, in one of Feynman's favorite words, BALONEY

Carl Sagan proposed a Baloney Detection Kit. Among its tools are:

**Encourage substantive debate on the evidence
by knowledgeable proponents of all points of view ...**

CMS and ATLAS refuse to discuss why they ignore the Nambu - Jona-Lasinio 3-mass-state-Higgs-as-TruthQuark-Condensate model and to debate it based on evidence from $H \rightarrow ZZ^* \rightarrow 4l$ channel observations

Arguments from authority carry little weight ...

CMS and ATLAS collaboration structure is based on Authority-enforced Consensus

Spin more than one hypothesis ...

CMS and ATLAS ignore the hypothesis that the 3-mass-state-Higgs might be true

Try not to get overly attached to a hypothesis just because it's yours.

CMS and ATLAS should compare their idea of 125 GeV as the only Higgs mass state with the alternatives including the Nambu - Jona-Lasinio 3-mass-state-Higgs

Quantify ...

Higgs mass event excesses in the $H \rightarrow ZZ^* \rightarrow 4l$ channel histograms are quantified numerical values that can and should be compared openly and objectively

Very similar acts of BALONEY were carried out by Fermilab (CDF and D0) with respect to the 3-mass-state -Truth Quark from the 1990s to the present day. Despite CDF and D0 semileptonic histograms clearly showing, not only the Consensus 174 GeV value for Truth Quark mass, but also a low mass 130-140 GeV state and even some indication of a high mass 220-240 GeV state, Fermilab

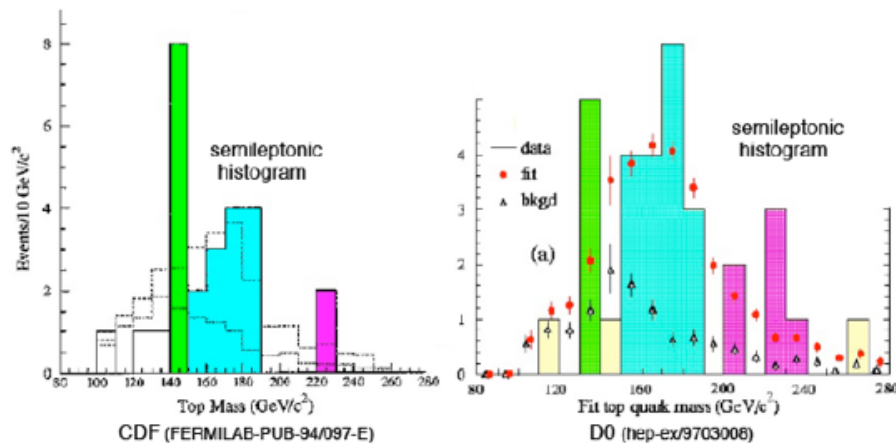

Encourage substantive debate on the evidence ...

refused to discuss or debate models showing states other than 174 GeV

Arguments from authority carry little weight ...

used their Consensus Authority to suppress ideas other than 174 GeV

Spin more than one hypothesis ...

ignored the hypothesis that the 3-mass-state-Truth Quark might be true

Try not to get overly attached to a hypothesis just because it's yours ...

was (and still is) totally attached to its 174 GeV Consensus value

Quantify ...

the Truth Quark event histograms are quantified values that could be compared openly and objectively

(For details about the Fermilab situation, go to pages 11 ff and 29 ff)

Consensus or E8 Physics View: What difference does it make ?

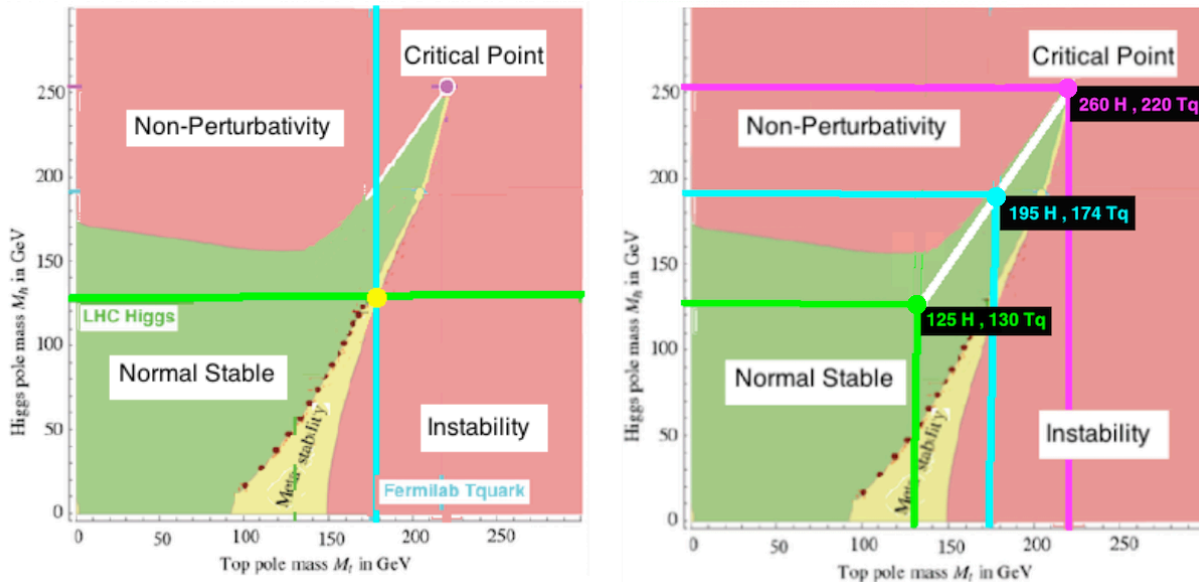

If the **Consensus View** is correct, then **Our Universe is Metastable**.

If the **Alternative View** is correct, then **we live in a Normal Stable Ground State** and there is a clear path to studying New Phenomena at Higher Energies: at the **Non-Perturbative Boundary** the **Compositeness of NJL Higgs** is manifest as is the structure of (4+4)-dim **Kaluza-Klein Spacetime $M_4 \times CP^2$** (M_4 is Minkowski and $CP^2 = SU(3) / SU(2) \times U(1)$ is Internal Symmetry Space) at and beyond the **Critical Point** the Higgs mechanism no longer gives mass to particles so we will enter a **Massless Realm** in which such things as the Kobayashi-Maskawa matrix will be radically changed, possibly becoming like the Democratic Mixing Matrix described by Marni Sheppeard.

How does the Nambu-Jona-Lasinio model of the Higgs-Tquark System work?

Start with the 8-dim Octonionic high-energy Lagrangian given by E8 Root Vectors:

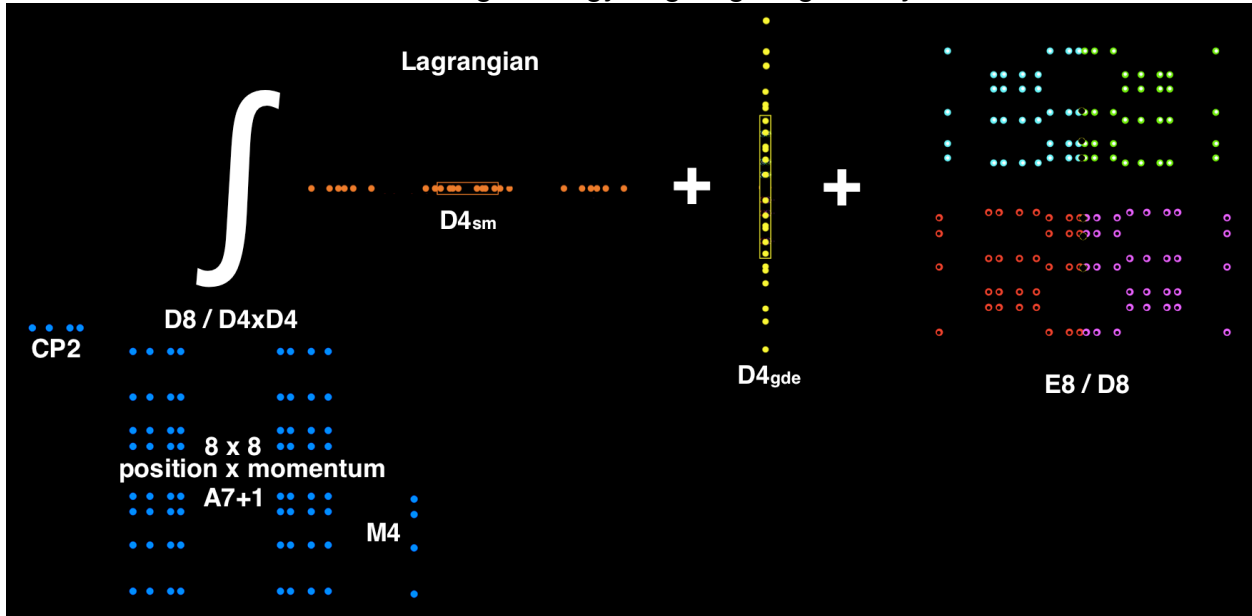

At lower energies Quaternionic structure emerges as M4 x CP2 Kaluza-Klein and integrating over the CP2 Internal Symmetry Space produces the Higgs by the Mayer-Trautman Mechanism and also produces 3 Generations of Fermions, including the Tquark.

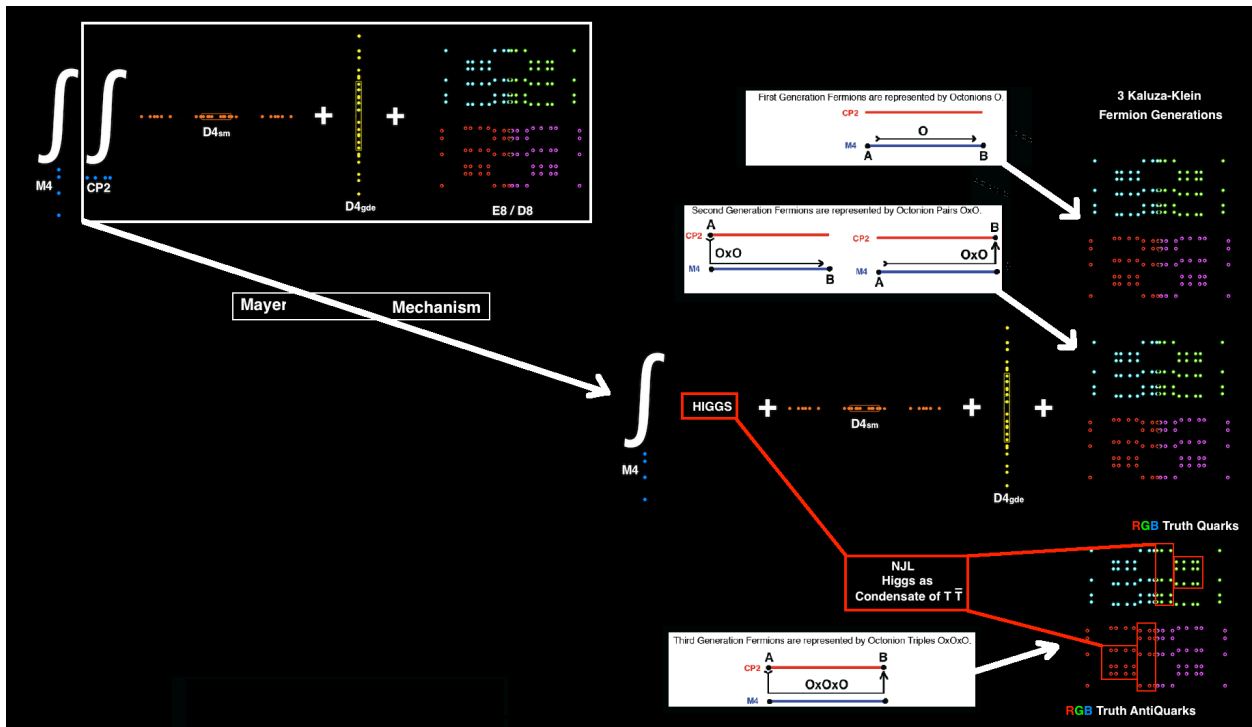

The Higgs and a Tquark-Tantiquark Nambu-Jona-Lasinio condensate

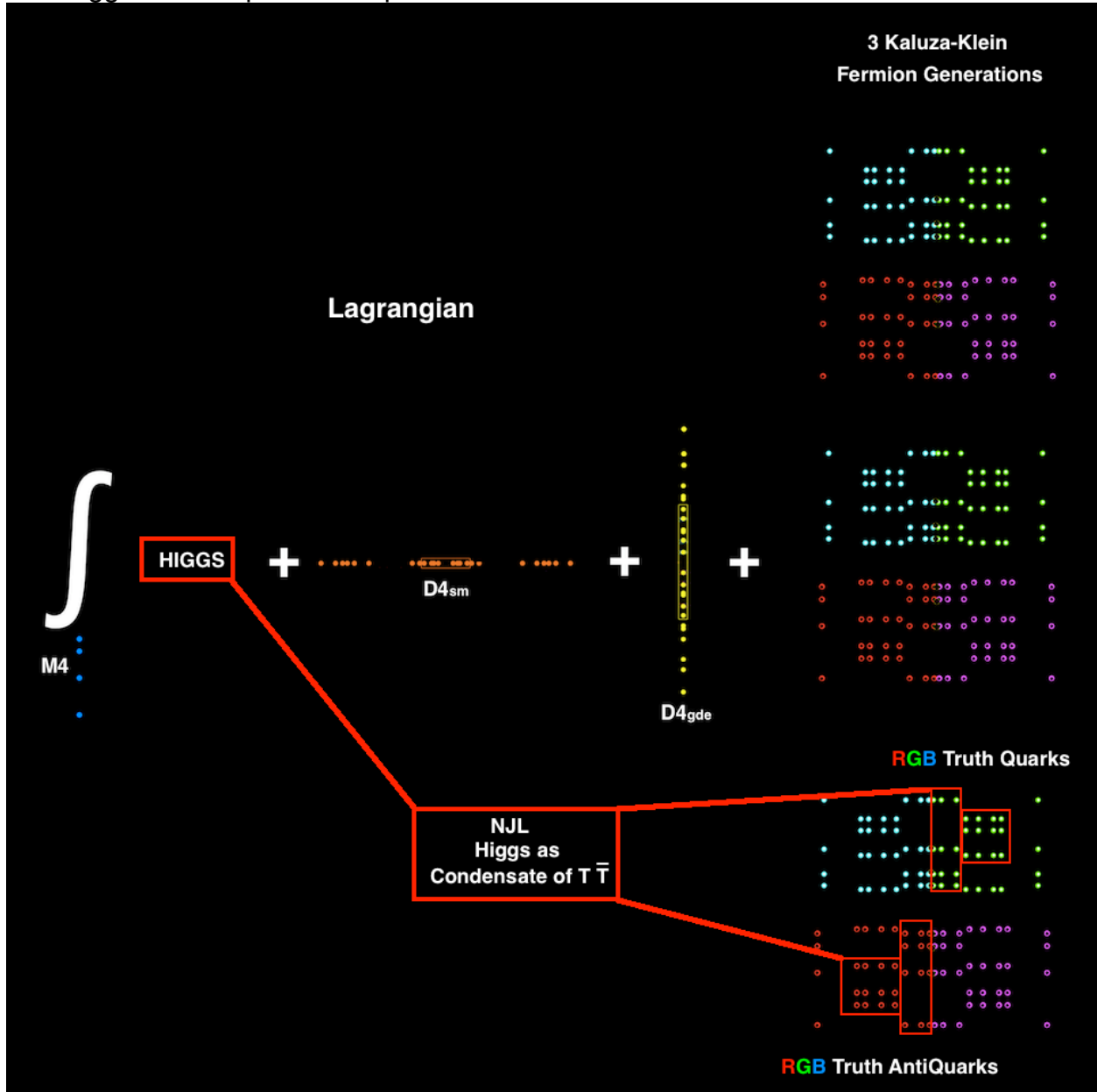

form a Higgs-Tquark NJL-type system with 3 Mass States

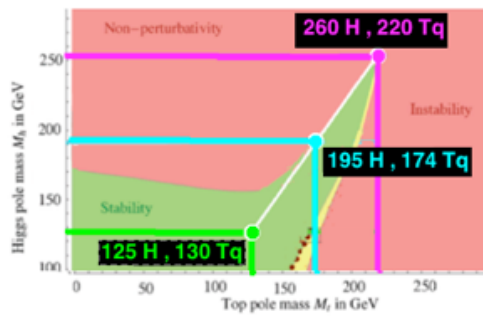

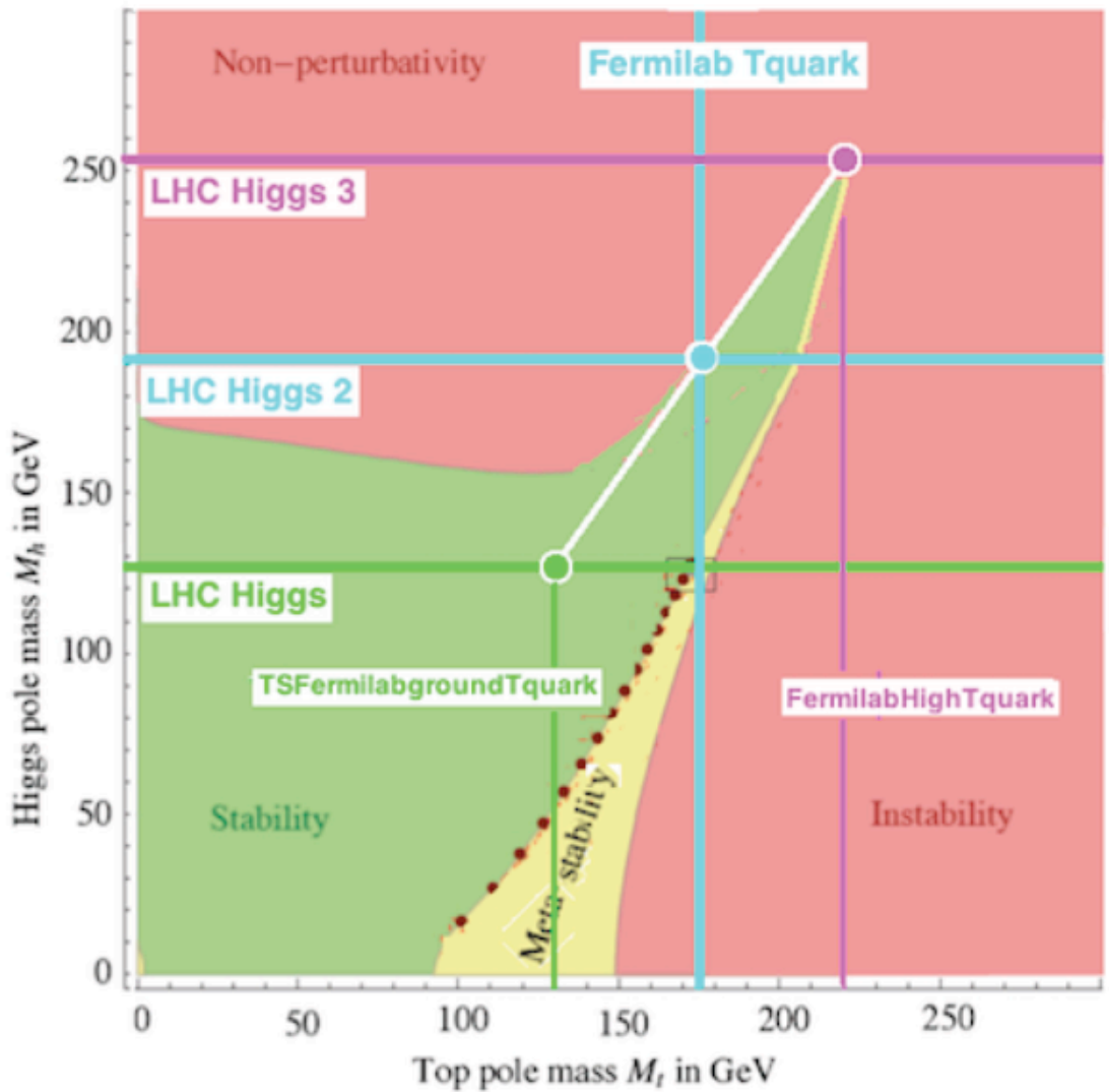

The Green Dot ● where the White Line originates in our Ordinary Phase is the **Low-mass state of a 130 GeV Truth Quark and a 125 GeV Higgs.**

The 130 GeV Tquark mass is also predicted by Connes's NCG (NonCommutative Geometry) by the formula $M_t = \sqrt{8/3} M_w$

The Cyan Dot  where the White Line hits the Triviality Boundary leaving the Ordinary Phase is the **Middle-mass state of a 174 GeV Truth Quark and Higgs around 200 GeV**. It corresponds to the Higgs mass calculated by Hashimoto, Tanabashi, and Yamawaki in hep-ph/0311165 where they say:

"... We perform the most attractive channel (MAC) analysis in the top mode standard model with TeV-scale extra dimensions, where the standard model gauge bosons and the third generation of quarks and leptons are put in $D(=6,8,10,\dots)$ dimensions. In such a model, bulk gauge couplings rapidly grow in the ultraviolet region. In order to make the scenario viable, only the attractive force of the top condensate should exceed the critical coupling, while other channels such as the bottom and tau condensates should not. We then find that the top condensate can be the MAC for $D=8$... We predict masses of the top (m_t) and the Higgs (m_H) ... based on the renormalization group for the top Yukawa and Higgs quartic couplings with the compositeness conditions at the scale where the bulk top condenses ... for ... [Kaluza-Klein type] ... dimension... $D=8$... $m_t = 172-175$ GeV and $m_H=176-188$ GeV ...".

As to composite Higgs and the Triviality boundary, Pierre Ramond says in his book *Journeys Beyond the Standard Model* (Perseus Books 1999) at pages 175-176: "... The Higgs quartic coupling has a complicated scale dependence. It evolves according to $d\lambda/dt = (1/16\pi^2)\beta_\lambda$ where the one loop contribution is given by $\beta_\lambda = 12\lambda^2 - \dots - 4H$... The value of λ at low energies is related [to] the physical value of the Higgs mass according to the tree level formula $m_H = v\sqrt{2\lambda}$ while the vacuum value is determined by the Fermi constant ... for a fixed vacuum value v , let us assume that the Higgs mass and therefore λ is large. In that case, β_λ is dominated by the λ^2 term, which drives the coupling towards its Landau pole at higher energies. Hence the higher the Higgs mass, the higher λ is and the closer [r] the Landau pole to experimentally accessible regions.

This means that for a given (large) Higgs mass, we expect the standard model to enter a strong coupling regime at relatively low energies, losing in the process our ability to calculate. This does not necessarily mean that the theory is incomplete, only that we can no longer handle it ... it is natural to think that this effect is caused by new strong interactions, and that the Higgs actually is a composite ...

The resulting bound on λ is sometimes called the triviality bound.

The reason for this unfortunate name (the theory is anything but trivial) stems from lattice studies where the coupling is assumed to be finite everywhere; in that case the coupling is driven to zero, yielding in fact a trivial theory.

In the standard model λ is certainly not zero. ...".

The Magenta Dot  at the end of the White Line is the **High-mass state of a 220 GeV Truth Quark and a 240 GeV Higgs**. It is at the critical point of the Higgs-Tquark System with respect to Vacuum Instability and Triviality. It corresponds to the description in hep-ph/9603293 by Koichi Yamawaki of the Bardeen-Hill-Lindner model: "... the BHL formulation of the top quark condensate ... start[s] with the SM Lagrangian which includes explicit Higgs field at the Lagrangian level ... BHL is crucially based on the perturbative picture ...[which]... breaks down at high energy near the compositeness scale Λ ... [10^{19} GeV]... there must be a certain matching scale $\Lambda_{\text{Matching}}$ such that the perturbative picture (BHL) is valid for $\mu < \Lambda_{\text{Matching}}$, while only the nonperturbative picture (MTY) becomes consistent for $\mu > \Lambda_{\text{Matching}}$... However, thanks to the presence of a quasi-infrared fixed point, BHL prediction is numerically quite stable against ambiguity at high energy region, namely, rather independent of whether this high energy region is replaced by MTY or something else. ... Then we expect $m_t = m_t(\text{BHL}) = \dots = 1/(\sqrt{2}) y_{\text{bar}} v$ within 1-2%, where y_{bar} is the quasi-infrared fixed point given by $\text{Beta}(y_{\text{bar}}) = 0$ in ... the one-loop RG equation ... The composite Higgs loop changes y_{bar}^2 by roughly the factor $N_c/(N_c + 3/2) = 2/3$ compared with the MTY value, i.e., 250 GeV \rightarrow 250 x $\sqrt{2/3} = 204$ GeV, while the electroweak gauge boson loop with opposite sign pulls it back a little bit to a higher value. The BHL value is then given by $m_t = 218 \pm 3$ GeV, at $\Lambda = 10^{19}$ GeV. The Higgs boson was predicted as a $t\bar{t}$ bound state with a mass $M_H = 2m_t$ based on the pure NJL model calculation. Its mass was also calculated by BHL through the full RG equation ... the result being ... $M_H / m_t = 1.1$) at $\Lambda = 10^{19}$ GeV the top quark condensate proposed by Miransky, Tanabashi and Yamawaki (MTY) and by Nambu independently ... entirely replaces the standard Higgs doublet by a composite one formed by a strongly coupled short range dynamics (four-fermion interaction) which triggers the top quark condensate. The Higgs boson emerges as a $t\bar{t}$ bound state and hence is deeply connected with the top quark itself. ... MTY introduced explicit four-fermion interactions responsible for the top quark condensate in addition to the standard gauge couplings. Based on the explicit solution of the ladder SD equation, MTY found that even if all the dimensionless four-fermion couplings are of $O(1)$, only the coupling larger than the critical coupling yields non-zero (large) mass ... The model was further formulated in an elegant fashion by Bardeen, Hill and Lindner (BHL) in the SM language, based on the RG equation and the compositeness condition. BHL essentially incorporates $1/N_c$ sub-leading effects such as those of the composite Higgs loops and ... gauge boson loops which were disregarded by the MTY formulation. We can explicitly see that BHL is in fact equivalent to MTY at $1/N_c$ -leading order. Such effects turned out to reduce the above MTY value 250 GeV down to 220 GeV ...".

Here is a History of Observations of the Higgs-Truth Quark NJL 3-State System:

1988 - Tquark - Nir, Nuclear Physics B306 (1988) 14 -

ARGUS B-Bbar experiments set limits on the Mass of the Truth Quark, showing it to be between 43 GeV and 180 GeV, and likely to be between **83 GeV and 180 GeV**.

1992 - Low-mass Tquark - Dalitz, Goldstein, Phys. Lett. B 287 (1992) 225-230) -

A simple idealized procedure is proposed for the analysis of individual top-antitop quark pair production and dilepton decay events, in terms of the top quark mass. This procedure is illustrated by its application to the CDF candidate event.

If this event really represents top-antitop production and decay, then the top quark mass would be **131 +22 -11 GeV**.

1993-Low-mass Tquark- Kondo, Chikamatsu, Kim J. Phys. Soc. Japan 62: 1177-82 - the dilepton candidate found during the Fermilab 1988-89 run can be interpreted as from the top antitop pair

1993 - Low-mass Tquark - Dalitz, Goldstein, hep-ph/9308345 -

Now that LEP experiments have measured with high accuracy many quantities related with the electroweak interactions, these measurements can be compared with the corrected theoretical predictions in order to draw some conclusions concerning the top quark and any other particles of high mass. ... With the LEP data updated to July 1992, Ellis et al. have given the value ... $m_t = 124(27)\text{GeV}$, (2.1) using $\alpha_S(M_Z^2) = 0.118(8)$.

...

One good ($\mu^- e^+$) candidate event has ... been published by the CDF collaboration ...

A second (μe) candidate was shown by the CDF collaboration in their report given at the November 1992 Chicago Meeting of the Division of Particles and Fields of the American Physical Society, although no measurement details were released.

It was well known at that meeting that the DO collaboration also had their first (μe) candidate. Although the integrated luminosities IL are not known to us precisely, a value of about 20 pb^{-1} for CDF (including $IL=4.7 \text{ pb}^{-1}$ from their 1989 paper) and 10 pb^{-1} for

DO would appear plausible estimates, at least of the right order of magnitude. ...

On the assumption that these three (μe) candidates do stem from top-antitop production, and that the integrated luminosity up to November 1992 was about 30 pb^{-1} ,

the probability distribution for m_t ... peak is at **120 GeV**, the one-deviation limits being **109 and 135 GeV**. ... the peak value thus determined for m_t is not strongly dependent on our estimate for IL , nor on the number of μe events. ...”.

1994 - Low-mass Tquark - 4 April - Abachi et al -

We have searched for evidence of top quark production in pp^- collisions at $\sqrt{s}=1.8$ TeV using the **D0** detector at the Fermilab Tevatron collider. ... We discuss the properties of an event for which expected backgrounds are small ... it is a dilepton e-mu event in a relatively low background region with a likelihood distribution that is maximized for a Tquark mass of about **145 GeV/c²**.

1994 - Low, Middle, High-mass Tquark - 26 April - FERMILAB-PUB-94/097-E -

A semileptonic histogram showed **all three states of the T-quark**:

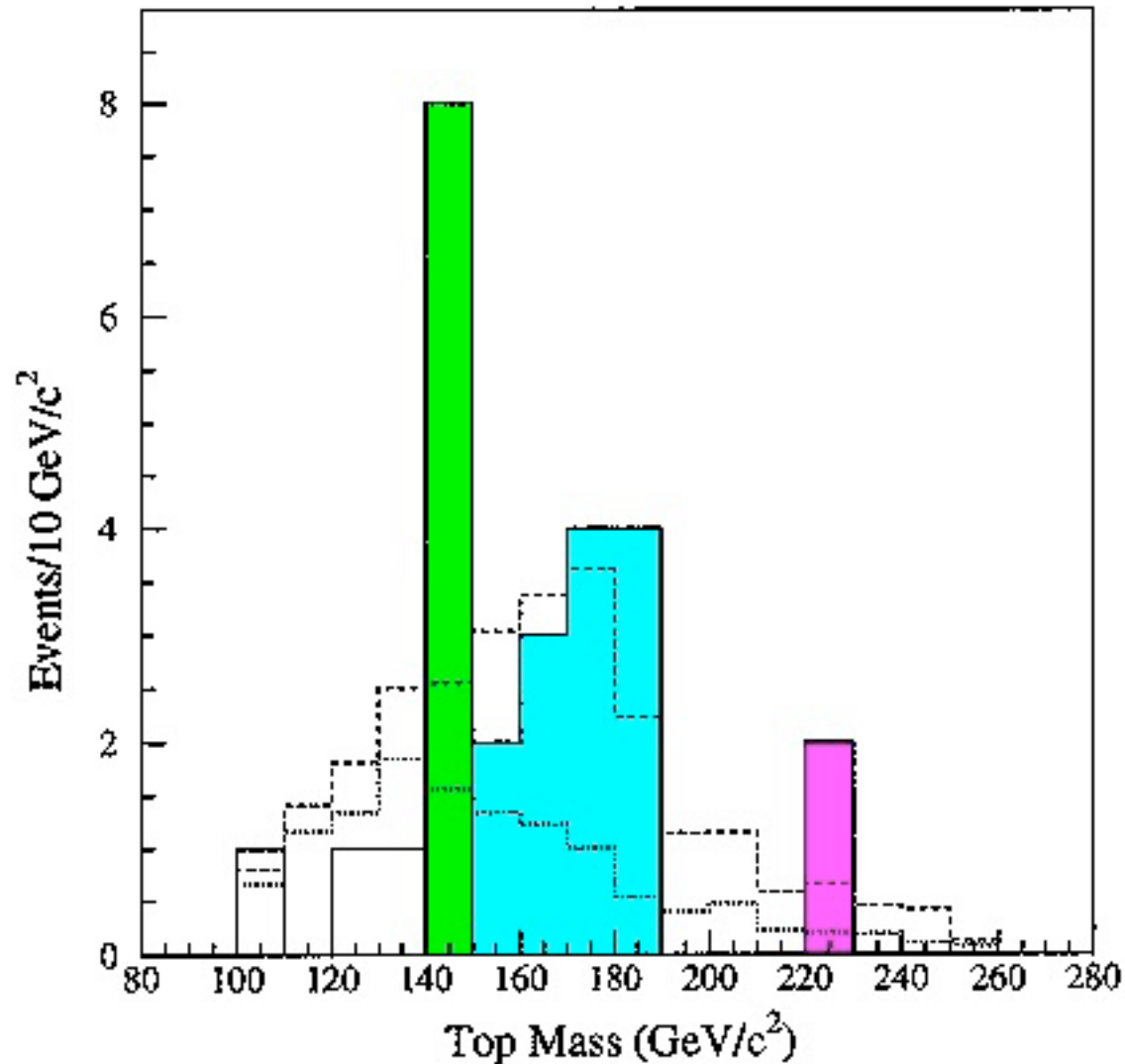

The **green** bar represents a bin in the **140-150 GeV** range containing Semileptonic events considered by me to represent the Truth Quark.

The **cyan** bar represents a broader peak in the **160-180 GeV** range that includes the 174 GeV Truth Quark at the Triviality Boundary of the H-Tq System.

The **magenta** bar represents a bin in the **220-230 GeV** range of the Truth Quark at the Critical Point of the Higgs - Truth Quark System.

1995 - Middle-mass Tquark - CDF hep-ex/9503002 -
analyzing about 50 pb⁻¹ of data, mostly Semileptonic events
gets a T-quark mass of about **176 GeV**

1995 - Middle-mass Tquark - D0 hep-ex/9503003 -
analyzing about 50 pb⁻¹ of data, mostly Semileptonic events
gets a T-quark mass of about **199 GeV**

1995 - Low, Middle-mass Tquark - Dalitz, Goldstein hep-ph/9506232 -
analyze the recent seven L(+/-)4jet events and, in accord with CDF,
get a mass estimate of about **175 GeV** for those events.
Their analysis of e(+/-)mu(+/-)2jet events gives
a somewhat lower peak t-quark mass (about **156 GeV**).
When they consider the CDF event 45047/104393 to
be a dilepton event with both leptons hard, and combining two jets into a single jet,
they get a good fit as a t-tbar event with t-quark mass **136 (+18 -14) GeV**.

1995 - Low-mass Tquark -Kondo Oral History Interview by K. Staley 10 October 1995 -
the dilepton candidate found during the Fermilab 1988-89 run could be reconstructed as
decay of a top-antitop pair with top mass of around **130 GeV/c²** with a very broad error.

1996 - Low-mass Tquark - Goldstein hep-ph/9611314 -
Top-antitop quark pairs produced at the Tevatron have a sizeable spin correlation. That
correlation feeds into the angular distribution of the decay products, particularly in the
dilepton channel. Including the expected correlation in an overall analysis of a handful of
actual dilepton events continues to favor a lower top mass (centered on **155 GeV**) than
the single lepton events.

1996 - Low, Middle-mass Tquark - Heinson hep-ex/9601006 -
results on top quark physics from the DZero collaboration since the discovery of the top
quark in March 1995 with about 50 pb⁻¹ of data from 1992 to 1995:
For Semi-Leptonic Lepton + Jets events: $M_t = 199 +24 -30 \text{ GeV}$;
For Dilepton events: $M_t = 145 \pm 32 \text{ GeV}$.

1996 - Low, Middle-mass Tquark - Campagnari, Franklin hep-ex/9608003 -
For Semi-Leptonic Lepton + Jets events:
CDF kinematic result: $M_t = 180 \pm 12(\text{stat}) (+19/-15)(\text{syst}) \text{ GeV}$;
CDF mass reconstruction result: $M_t = 176 \pm 9 \text{ GeV}$;
D0 mass reconstruction result: $M_t = 170 \pm 18 \text{ GeV}$.
For Dilepton events:
CDF kinematic result:
 $M_t = 159 (+24/-22)(\text{stat}) \pm 17(\text{syst}) \text{ GeV}$;
D0 mass reconstruction result:
 $M_t = 145 \pm 25(\text{stat}) \pm 20(\text{syst}) \text{ GeV}$.

1996 - Low-mass Tquark, Low-mass Higgs - Dittmaier, Schildknecht
 hep-ph/9609488 -

implications of 1996 electroweak data on the Higgs and T-quark masses -
 If the LEP value of the Weinberg angle $s_2w = 0.23200$ is used,
 and the SLD value $s_2w = 0.23165$ is excluded
 then, approximately, $M_t = 155 \text{ GeV}$ and $M_H = 100 \text{ GeV}$:

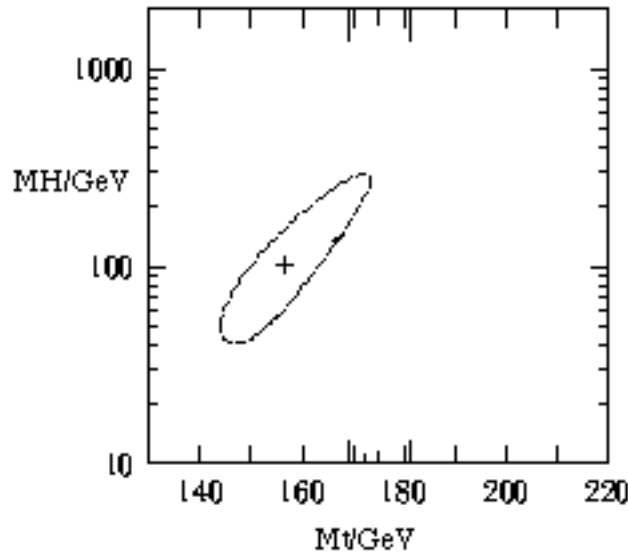

1997 - Middle-mass Tquark - HERA H1 hep-ex/9702012 -

The following histograms show that the HERA H1 events begin to appear with unusual frequency at the **150-200 GeV** and compare the HERA H1 observed data with the 1-sigma deviation line from the standard NC DIS expected data

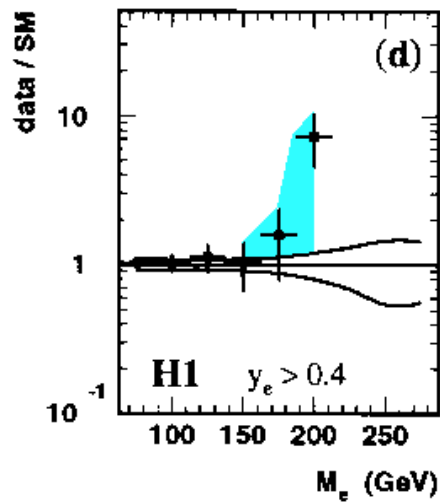
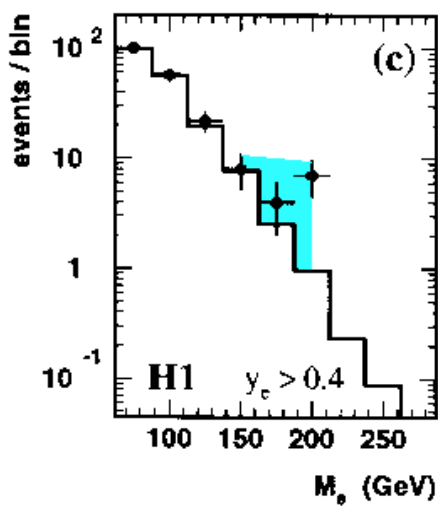

1997 - Low, Middle, High-mass Tquark - D0 hep-ex/9703008 -
 A semileptonic histogram showed **all three states of the T-quark**:

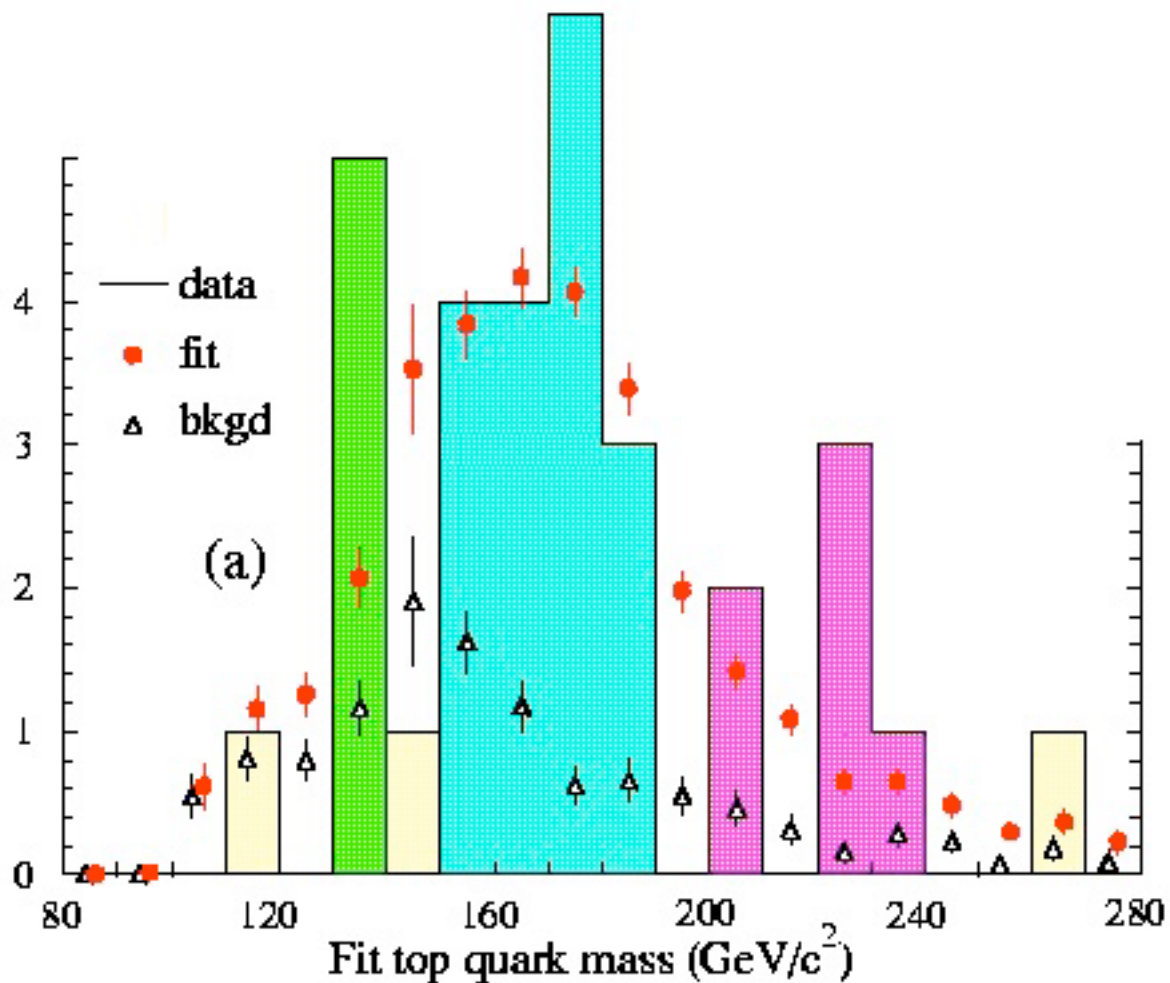

It was not only consistent with the 3 Truth Quark Mass States of E8 Physics but also with the CDF 1994 semileptonic histogram of **FERMILAB-PUB-94/097-E**

Although Fermilab Consensus then and now was and is that the green low-mass state does not exist and is only a statistical fluctuation, Tommaso Dorigo said that the odds of having both CDF and D0 seeing what they saw in those two histograms

are **4 -sigma**

1997 - Low, Middle, High-mass Tquark - Varnes U. C. Berkeley Ph.D. Thesis
FERMILAB-THESIS-1997-28

https://www-d0.fnal.gov/results/publications_talks/thesis/varnes/thesis.ps

In his 1997 Ph.D. thesis Erich Ward Varnes (page 159) said:

"... distributions for the dilepton candidates. For events with more than two jets, the dashed curves show the results of considering only the two highest ET jets in the reconstruction ...

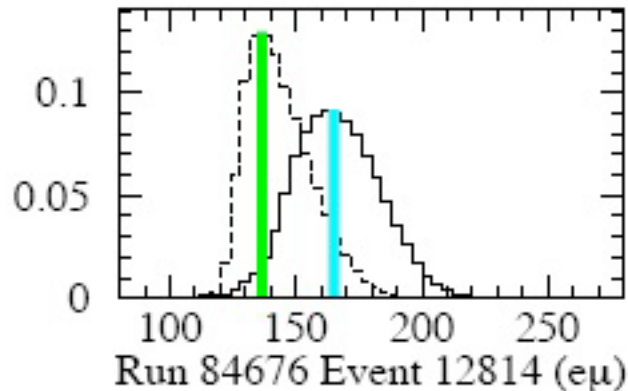

..." (colored bars added by me)

The event for all 3 jets (solid curve) seems to me to correspond to decay of a middle (cyan) T-quark state with one of the 3 jets corresponding to decay from the Triviality boundary to the Normal Stable Region (green) T-quark state, whose immediately subsequent decay corresponds to the 2-jet (dashed curve) event at the low (green) energy level.

In the Varnes thesis there is one dilepton event with 3 jets (solid curve)

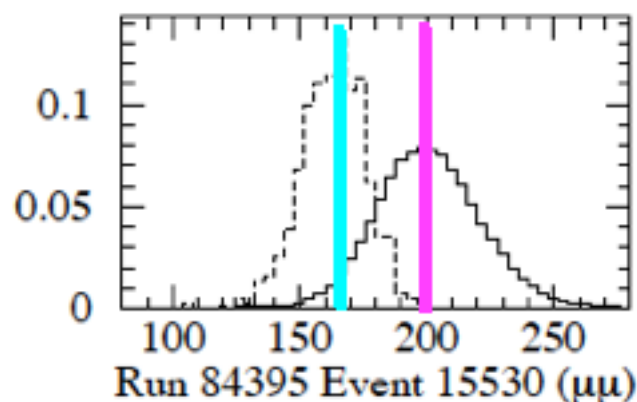

that seems to me to correspond to decay of a high (magenta) T-quark state with one of the 3 jets corresponding to decay from the Critical Point down to the Triviality Boundary (cyan) T-quark state, whose immediately subsequent decay corresponds to the 2-jet (dashed curve) event.

Dilepton data are described by Erich Ward Varnes in Chapter 8 of his 1997 UC Berkeley PhD thesis about D0 data at Fermilab:

"... there are six t-tbar candidate events in the dilepton final states ... Three of the events contain three jets, and in these cases the results of the fits using only the leading two jets and using all combinations of three jets are given ...".

There being only 6 dilepton events in Figure 8.1 of Varnes's PhD thesis

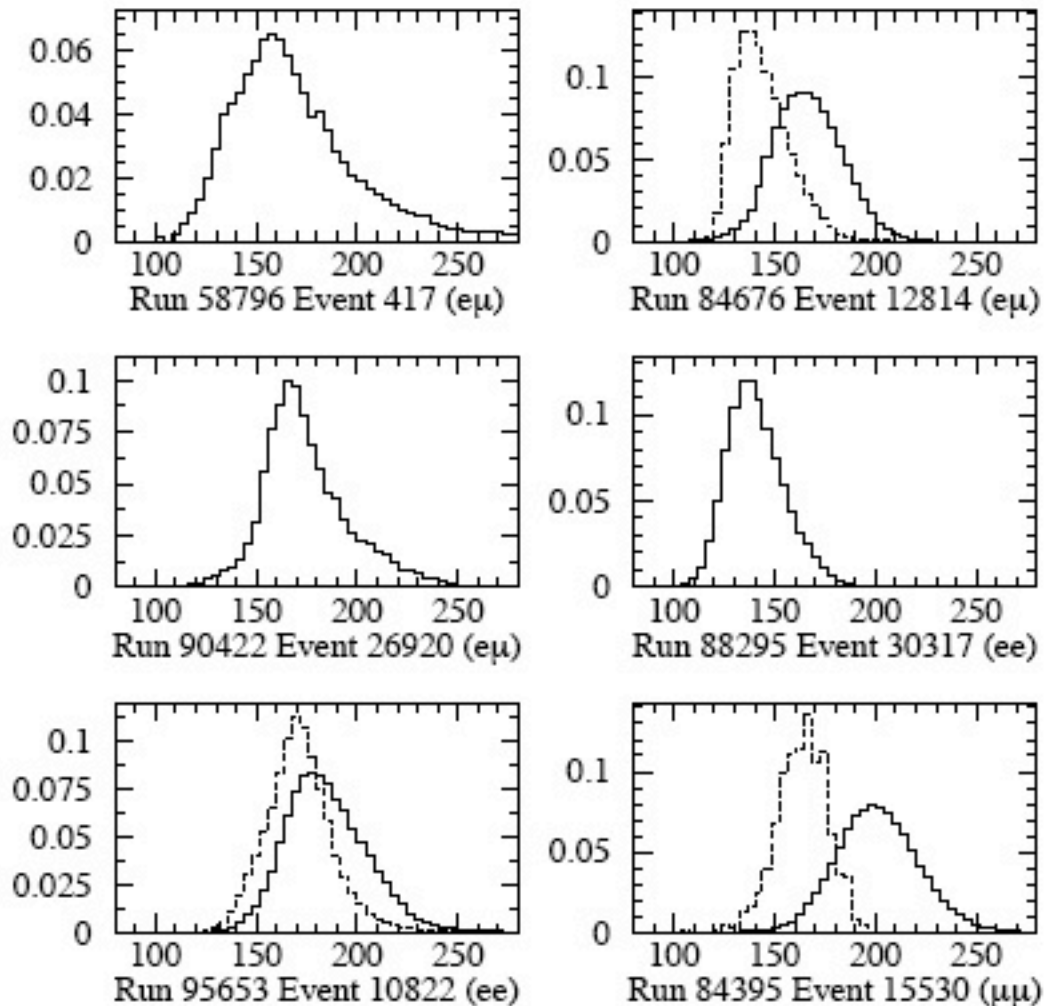

Figure 8.1: $\mathcal{W}(m_l)$ distributions for the dilepton candidates. For events with more than two jets, the dashed curves show the results of considering only the two highest E_T jets in the reconstruction.

it is reasonable to discuss each of them,
so (mass is roughly estimated by me looking at the histograms) here they are:

Run 58796 Event 417 (e mu) - 2 jets - **160 GeV**
 Run 90422 Event 26920 (e mu) - 2 jets - **170 GeV**
 Run 88295 Event 30317 (e e) - 2 jets - **135 GeV**

Run 84676 Event 12814 (e mu) - more than 2 jets - 165 GeV -
highest 2 jets - 135 GeV

Run 95653 Event 10822 (e e) - more than 2 jets - 180 GeV - highest 2 jets - 170 GeV

Run 84395 Event 15530 (mu mu) - more than 2 jets - 200 GeV -
highest 2 jets - 165 GeV

In terms of 3 Truth Quark mass states - High around 220 GeV or so -
Middle around 174 GeV or so - Low around 130-145 GeV or so - those look like:

Run 58796 Event 417 (e mu) - direct 2-jet decay of Middle

Run 90422 Event 26920 (e mu) - direct 2-jet decay of Middle

Run 88295 Event 30317 (e e) - direct 2-jet decay of Low

Run 84676 Event 12814 (e mu) - decay of Middle to Low then 2-jet decay of Low

Run 95653 Event 10822 (e e) - decay of High to Middle then 2-jet decay of Middle

Run 84395 Event 15530 (mu mu) - decay of High to Middle then 2-jet decay of Middle

The 1997 UC Berkeley PhD thesis of Erich Ward Varnes says:

“... the leptonic decays of the t tbar events are divided into two broad categories:
the lepton plus jets and dilepton channels.

The former has the advantage of a large branching ratio, accounting for about 30% of
all t tbar decays, with the disadvantage that electroweak processes or detector
misidentification of final-state particle can mimic the t tbar signal relatively frequently.

Conversely,

the dilepton channels have lower backgrounds, but account for only 5% of all decays.

...

The kinematic selection of dilepton events is summarized in Table 5.2 ...

	ee	$e\mu$	$\mu\mu$
Leptons	$E_T > 20 \text{ GeV}$ $ \eta < 2.5$	$E_T(e) > 15 \text{ GeV}, p_T(\mu) > 15 \text{ GeV}/c$ $ \eta(e) < 2.5$	$p_T(\mu) > 15 \text{ GeV}/c$
Jets	≥ 2 with $E_T > 20 \text{ GeV}$ and $ \eta < 2.5$		
\cancel{E}_T	$> 25 \text{ GeV}$	$\cancel{E}_T > 20 \text{ GeV}$ $\cancel{E}_T^{\text{cal}} > 10 \text{ GeV}$	N/A
H_T^c	$> 120 \text{ GeV}$	$> 120 \text{ GeV}$	$> 100 \text{ GeV}$

Table 5.2: Kinematic cuts for the dilepton event selection. The cut used in place of \cancel{E}_T to reject $Z \rightarrow \mu\mu$ events is described in the text, as is the H_T^c variable. Also, the muon η cut is run-dependent, as detailed in Chapter 4.

...

In the dilepton channels, one expects the final state to consist of two charged leptons, two neutrinos, and two b jets (see Fig. 6.1)

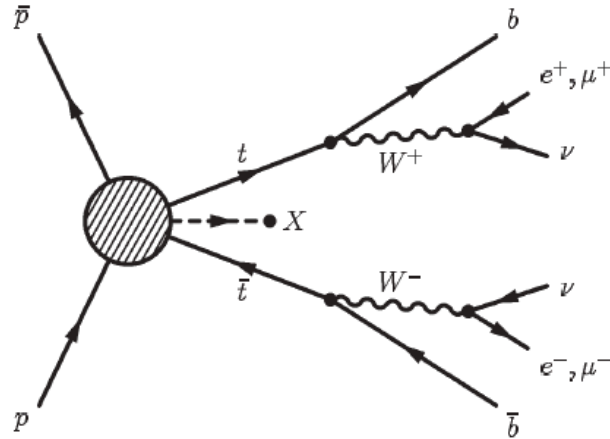

Figure 6.1: Schematic representation of $t\bar{t}$ production and decay in the dilepton channels.

so that the final state is completely specified by knowledge of the energy four-vectors of these six particles ... there are ... kinematic constraints:

The invariant mass of each lepton and neutrino pair is equal to the W mass.

The masses of the reconstructed t and tbar in the event are equal.

...

Figure 8.1: $W(m_t)$ distributions for the dilepton candidates. For events with more than two jets, the dashed curves show the results of considering only the two highest ET jets in the reconstruction ...

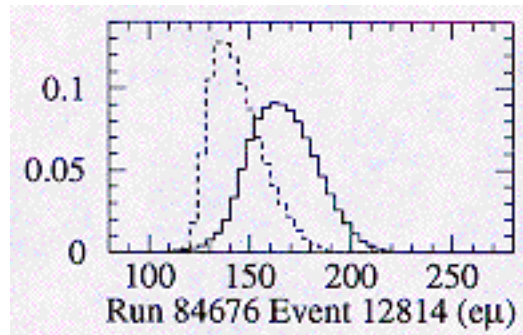

Run 84676 Event 12814					z vertex: -6.17 cm		
Object	E	E_x	E_y	E_z	E_T	η	ϕ
Electron	81.3	-75.4	-1.1	-30.2	74.5	-0.39	3.16
Muon	30.2	-25.2	10.6	-12.8	27.4	-0.45	2.75
\vec{E}_T	-	62.0	5.2	-	62.3	-	0.08
Jet 1	93.8	38.0	-83.7	-15.6	91.9	-0.17	5.14
	(95.9)	(38.9)	(-85.6)	(-16.0)	(94.0)		
Jet 2	37.8	13.9	32.3	-11.2	35.2	-0.31	1.17
	(38.8)	(14.2)	(33.1)	(-11.4)	(36.0)		
Jet 3	31.4	-1.6	28.6	11.6	28.7	0.39	1.63
	(32.2)	(-1.6)	(29.3)	(11.9)	(29.4)		

...

If the t and tbar are both in the 130 GeV mass state then the decay is simple with 2 jets:

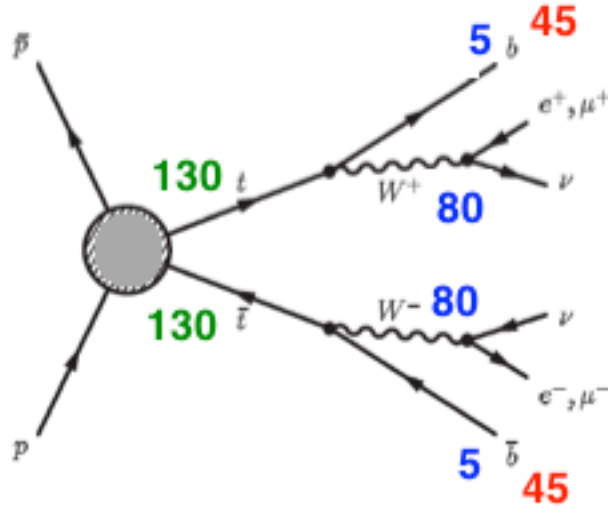

and both jets are highly constrained as being related to the W - b decay process so it is reasonable to expect that the 130 GeV decay events would fall in the narrow width of a single 10 GeV histogram bin.

(In these two diagrams I have indicated energies only approximately for t and tbar mass states (cyan and green) and W and b-quark (blue) and jets (red). Actual kinematic data may vary from the idealized numbers on the diagrams, but they should give similar physics results.)

If the t and tbar are both in the 173 GeV mass state (as, for example, in Run 84676 Event 12814 (e mu) described above) the decay has two stages and 3 jets:

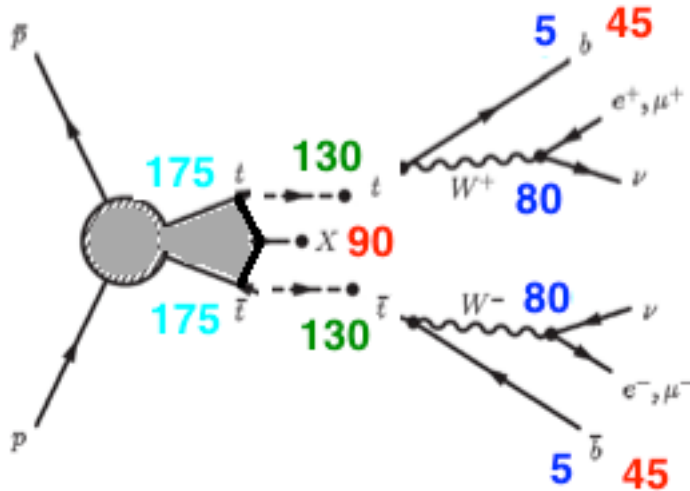

First, the 175 GeV t and tbar both decay to the 130 GeV state, emitting a jet. Then, the 130 GeV t and tbar decay by the simple 2-jet process. The first jet is a process of the Higgs - T-quark condensate system of E8 Physics and is not a W -b decay process so it is not so highly constrained and it is reasonable to expect that the 175 GeV decay events would appear to have a larger (on the order of 40 GeV) width.

As to t and $tbar$ being the high T -quark mass state (around 225 GeV) there would be a third stage for decay from 225 GeV to 175 GeV with a fourth jet carrying around 100 GeV of decay energy. In the Varnes thesis there is one dilepton event

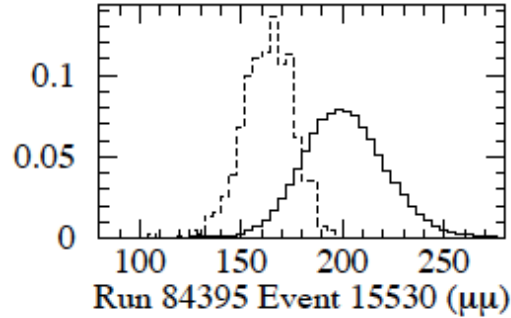

Run 84395 Event 15530					z vertex: 5.9 cm		
Object	E	E_x	E_y	E_z	E_T	η	ϕ
Muon 1	68.6	-63.9	12.7	-21.4	65.1	-0.32	2.94
Muon 2	34.9	-16.0	31.0	1.9	34.9	0.05	2.05
\cancel{E}_T	-	71.2	53.2	-	88.9	-	0.64
Jet 1	146.1 (153.5)	32.1 (33.8)	-98.2 (-103.1)	-102.4 (-107.6)	103.3 (108.5)	-0.88	5.03
Jet 2	35.1 (37.2)	-8.6 (-9.1)	21.4 (22.7)	26.2 (27.7)	23.1 (24.5)	0.97	1.95
Jet 3	47.1 (52.3)	-7.6 (-8.4)	-16.8 (-18.6)	43.0 (47.8)	18.4 (20.5)	1.58	4.29

that seems me to represent that third stage of decay from 225 GeV to 175 GeV. Since it is described as a 3-jet event and not a 4-jet event as I would have expected, my guess is that the third and fourth jets of my model were not distinguished by the experiment so that they appeared to be one third jet.

1998 - Low, Middle-mass Tquark - CDF hep-ex/9801014 -
 based on lepton + 4 jet events that were either SVX tagged, SVX double tagged, or untagged ... the top quark mass is **175.9 +/- 4.8(stat.) +/- 4.9(syst.) GeV/c²**
 14 SLT tagged events with no SVX tag ... give a Tquark Mass of **142 GeV (+33, -14)**

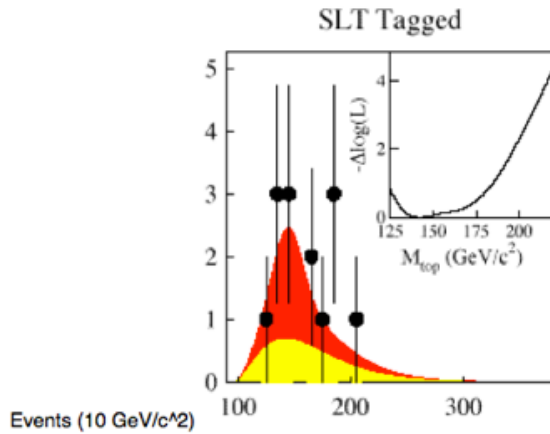

1998 - Low, Middle, High-mass Tquark - D0 hep-ex/9801025 -
 5 tagged lepton + jets give Tquark mass **130-150 GeV** for 3 of the events

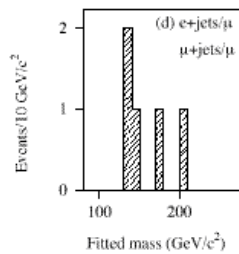

of the total of 91 candidate events, 31 survived Chi-squared less than 10 cut and also survived the Low Bias selection cut, **all three Tquark states** observed:

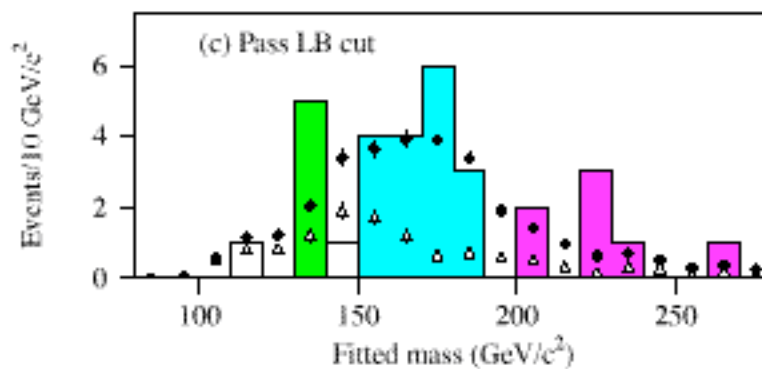

1998 - Low, Middle-mass Tquark - Dalitz, Goldstein hep-ph/9802249 -
 11 additional CDF dilepton events which have become available since the 1997
 Electron-Photon conference in Hamburg are **Low and Middle-mass Tquark states**:

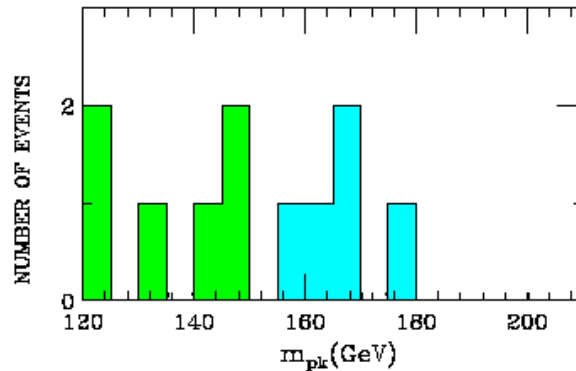

The distribution of $m_{p\ell}$ values determined from 11 CDF dilepton events available empirically.

1998 - Low, Middle-mass Tquark - CDF hep-ex/9810029 -
 CDF “present[s] a new measurement of the top quark mass ...
 [that] supersedes [CDF’s] previously reported result in the dilepton channel”
 which revision seems to me to be cutting the lowest 3 of the 11 original events

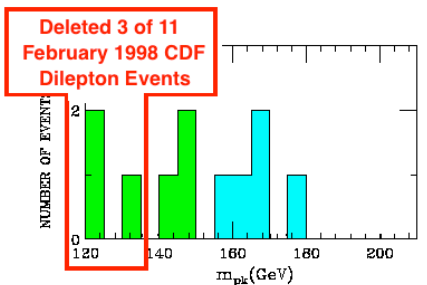

The distribution of $m_{p\ell}$ values determined from 11 CDF dilepton events available empirically.

1998 Revision of
 CDF Dilepton Criteria

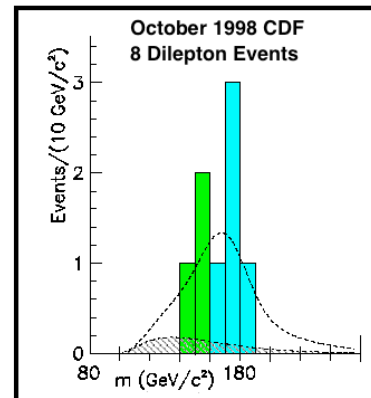

as part of a Fermilab policy of ignoring the Low-mass Tquark state.

1999 - Middle, High-mass Tquark - HERA H1, ZEUS hep-ex/9910012 -
 The excess in the H1 data is still present at $M_e = 200 \text{ GeV}$ but has not been corroborated by the 1997 data. Also ZEUS observes an excess at $M_{ej} > 200 \text{ GeV}$

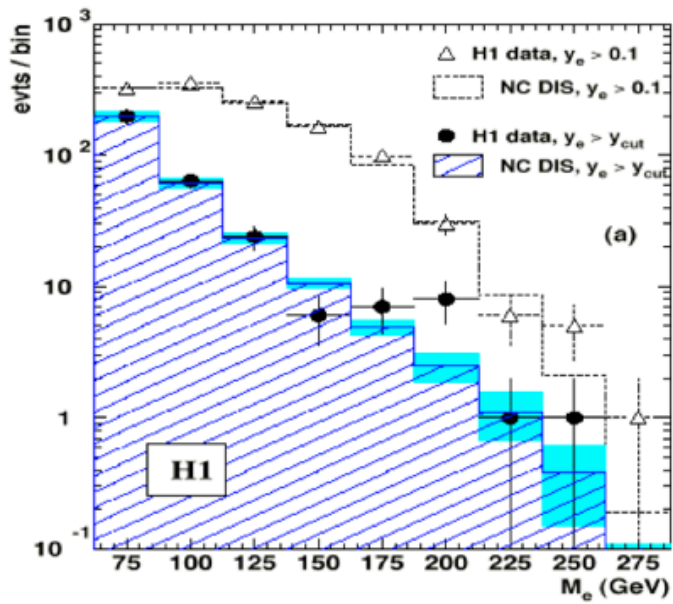

Why did Fermilab dismiss Low and High Mass States ?

The Truth Quark High Mass State peak in the 1994 CDF semileptonic histogram is low, only 2 events out of a total of 26, so they could be dismissed as insignificant, but the Truth Quark Low Mass State peak is not low (8 of 26 events) and should not be so easily dismissed by CDF. However, in 1994, CDF in FERMILAB-PUB-94/097-E did dismiss the Low Mass peak, saying merely "... We assume the mass combinations in the 140 to 150 GeV/c² bin represent a statistical fluctuation since their width is narrower than expected for a top signal. ...". I strongly disagree with CDF's "statistical fluctuation" interpretation. If it were merely a "statistical fluctuation" then it would have been highly improbable for the 1997 D0 semileptonic histogram to have shown a very similar Low Mass peak, but in fact a very similar Low Mass peak is what D0 did find in 1997:

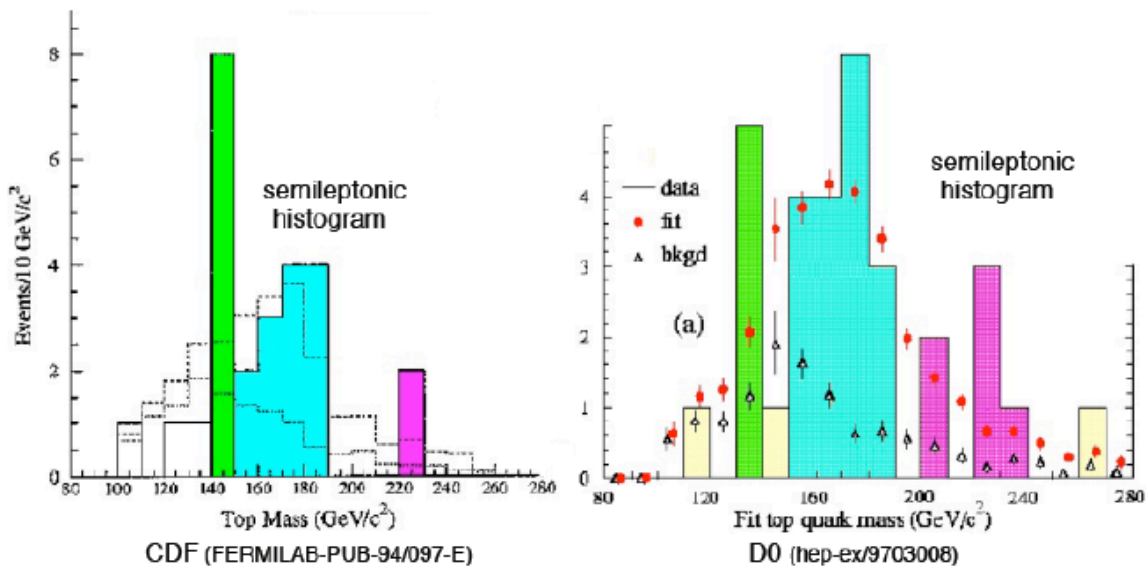

For more detailed analysis of how Fermilab data over many years has supported the reality of three mass states of the Truth Quark, see viXra 1602.0319 .

Fermilab's dismissal of the Low Mass Truth Quark peak around 130 GeV in its own data was not only a dismissal of my hep-ph/9301210 prediction but also a dismissal of other independent theoretical predictions of Truth Quark mass:

1982 - Inoue, Kakuto, Komatsu, and Takeshita in Aspects of Grand Unified Models with Softly Broken Supersymmetry (Prog. Theor. Phys. 68 (1982) 927) relate supersymmetry to electro-weak symmetry breaking by radiative corrections and renormalization group equations, and find that the renormalization group equations have a fixed point related to a T-quark mass of about 125 GeV.

1983 - Alvarez-Gaume, Polchinski, and Wise in Nuclear Physics B221 (1983) 495-523 : "... The renormalization group equation ... tends to attract the top quark mass towards a fixed point of about 125 GeV ...".

1984 - Ibanez and Lopez in Nuclear Physics B233 (1984) 511-544 did supergravity calculations similar to Alvarez-Gaume, Polchinski, and Wise.

1993 - Chamseddine and Frohlich in hep-ph/9307209 :

“... Connes ... non-commutative geometry [NCG] provides a geometrical interpretation of the Higgs field ... the only solutions ... occur in the narrow band ...

Higgs mass $117.3 < m_H < 142.6$ GeV ...

with ... corresponding top quark mass ... $146.2 < m_t < 147.4$ GeV ...”.

Later basic NCG calculation (see arXiv 1204.0328) indicated

Top quark mass upper bound of $\sqrt{8/3} m_W = 130$ GeV .

The Renormalization Group and NCG predictions have been confirmed by the LHC 2016 run which showed not only the 125 GeV Higgs Mass State but also 3 Higgs Mass States corresponding to 3 Truth Quark Mass States including the Low Mass Truth Quark State dismissed by Fermilab.

Why would Fermilab dismiss the Low Mass Truth Quark peak in its own data, even though it had theoretical support from Renormalization Group and NCG, not to mention my isolated unconventional theory ?

To understand the hostility of Fermilab to a Low Mass Truth Quark State, you must look at the details of the process whereby Fermilab sought to discover the Truth Quark after CDF's 1988-89 run which produced a dilepton candidate event.

Kent Staley in “The Evidence for the Top Quark” (Cambridge 2004) said:

“... CDF searched for the top [quark] ... in ... the “dilepton” mode ...

CDF stopped taking data at the end of May 1989 ...

Kumi Kondo's Dynamical Likelihood Method ... would give a kinematical reconstruction of events and then calculate the likelihood of that reconstruction using the dynamics of the hypothesized decay process ... **Kondo found that ... the lone dilepton candidate found during the 1988-9 run ... could be reconstructed with his method as the decay of a top-antitop pair, with a top mass of around 130 GeV/c² ...**

Goldstein, Sliwa, and Dalitz ... were trying to apply their method to the first CDF dilepton event, the same published e-mu event from the 1988-9 run that Kondo had analyzed ...

In February 1992 ... Goldstein and Sliwa were invited to present their method ... at a meeting of the heavy flavors group (the precursor to the top group) ... Sliwa showed ... a bump ... at a top-quark mass of about 120 GeV/c² ...

in May 1992 ... Goldstein, Sliwa, and Dalitz ... present[ed] ... analysis of data

from ... 1988-9 ... [saying]... “The plots show very clearly a well separated enhancement around $M_t = 135$ GeV in the accumulated probability distributions, as expected by the Monte Carlo studies” ...

The top mass estimates from the Dalitz-Goldstein-Sliwa analysis ... consistently fell into the 130-140 GeV/c² range ...

considerably lower than the later estimate of 174 GeV/c²

that appeared in CDF's paper claiming evidence for the top quark

...

Then, a very strange thing happened: ...

New Scientist, dated June 27, 1992 ... announced ... “A claim that the top quark has been found is being suppressed by scientists at the Fermilab particle physics centre ... If Dalitz turns out to be correct ... the main credit for finding the particle will go to Dalitz, a scientist outside Fermilab ...” ... Dalitz, Goldstein, and Sliwa appeared in the article as a “rival group”, the publication of whose paper CDF was “blocking”, and the author reported Goldstein saying that he was “quite confident’ that they have discovered the existence and the mass of the (Top) quark.”

...

An article ... in the July 24 issue of Science ... recounted how the results of the Sliwa-Goldstein-Dalitz analysis were presented to CDF ... Goldstein and Dalitz were subsequently excluded from CDF top group meetings ... CDF physicist... “Shochet says **CDF member Sliwa violated an unwritten code of ethics by sharing data with outsiders.**”

...

Sliwa denied that he had made substantive information about CDF’s unpublished data available to Dalitz and Goldstein

...

the unpleasant atmosphere generated by the controversy surrounding Sliwa’s work hampered progress on the Dalitz-Goldstein-Sliwa method ...

Krys really never got the time of day after [the appearance of the articles in New Scientist and Science]...[He] took it very personally, and responded very personally

...

he was “spurned by the rest of the collaboration: because he was acting singly, and not in a larger collaboration” ...”.

Tommaso Dorigo has written a book, “Anomaly”

(to be published by World on 5 Nov 2016),

that may give more details of the situation. He has blogged and commented on it over the past years (2006-2013), saying in part:

“... In **December 1988** a one-day workshop was organized in the Ramsey auditorium, the conference room at the basement floor of the Hirise, the main building of the Fermi National Accelerator Laboratory. The workshop was the first of a series of meetings that would take place in the course of the following few years, and it was specifically devoted to focused discussions on the top quark search, which was being performed independently by several groups of CDF physicists

...

one got the feeling that a well-defined strategy for the top search was missing. Indeed, back then it was not even clear to most CDF researchers that the main background to top production was constituted by events featuring a W boson together with hadronic jets produced by QCD radiation

...

Finally, the time came for the talk by Kuni Kondo. Prof. Kondo was a Japanese physicist who led a sizable group of researchers from the University of Tsukuba. In his late fifties, he was lean, not tall, with black hair combed straight above an incipient baldness; he usually dressed in black or grey suits. He was a charming and very polite person, who spoke with a soft tone of voice and smiled a lot. It looked like nothing could ever upset him.

Kondo had devised a very complex, deep method to discriminate top quark events from the background, based on an analysis approach he had dubbed "dynamical likelihood" which would become a sophisticated standard only a decade later, but which was taken with quite a bit of scepticism at the time; in private, quite a few of his American and Italian colleagues would even make silly jokes on it. The method consisted in constructing probability distributions for the observed kinematics of the events, which could then be used to derive the likelihood that the events were more signal-like or background-like.

It is ironic to think that nowadays all the most precise measurements of the mass of the top quark rely on the method called "matrix element", which is nothing but Kondo's original idea recast in the context of a measurement of the mass rather than the discrimination of a top signal. Kondo was way ahead of his time, and like most pioneers in science he did not have an easy life getting his work appreciated and accepted, in a situation dominated by a conservative mainstream.

It is by now four in the afternoon, and Kondo finally gives a full status report of his analysis. His presentation is thorough and yet almost unintelligible by a good half of his listeners; his analysis includes highly unorthodox and yet brilliant tricks, like taking a jet from one event and mixing it in with other jets in a different event to study the behaviour of some of his selection variables for background events. His colleagues listen in an atmosphere of disbelief mixed with awe. Despite the complexity of the material and the possibility to object on a hundred of details, no questions are asked. As **Kondo** reaches the end of his talk, he concludes with a tone of voice just a millidecibel higher than the rest of his speech:

"And therefore", a pause, and then "I think we have discovered the top quark".

The audience remains silent.

The convener is a tall, lean guy with a sharp nose and a penetrating stare; he looks like an English gentleman from a XIXth century novel, especially thanks to his considerable aplomb. He is not impressed, and that much does show.

"Thank you very much Kuni. Is there any question ?", one, two, three, four,

"...No questions. Okay, thanks again Kuni. The next speaker is..."

In retrospect the convener's attitude and lack of consideration toward an esteemed colleague and a visitor from another country, who had brought to the experiment lots of resources and had contributed significantly to the detector construction, sounds at least rude and unjustified.

Still, back then CDF was not a place where people would exchange courtesies and compliments (it never was, in truth): there everybody had to work hard and the only way to earn the respect of colleagues was through the good physics output of one's analysis results. If your analysis methods were not considered publishable or your results were thought fallacious, you would be considered a potential threat to the good name of the experiment, and you would suffer little short than boycott. But the way Kondo was treated was all flowers in comparison to what other physicists would experience, along the way to the top discovery

...

[1992] I had started working on CDF ... and I remember that one of the very first articles I read was the limit on top quark production where the famous dilepton $t\bar{t}$ candidate was mentioned. An event that is indeed most likely the first clear top-antitop decay detected in a particle physics experiment

...

Back then, Krzysztof Sliwa analyzed the $t\bar{t}$ candidate by CDF in the dileptonic final state with an analysis called "neutrino weighting technique" which has later become a standard, and worked with Dalitz and Goldstein on a paper which was not authorized by the CDF collaboration

...

CDF, as a collection of physicists, did feel betrayed by Chris Sliwa. I do not know how clear was the violation of internal rules of the experiment, but for sure that was the sentiment circulating those days in the corridors of the CDF trailers

...

there was this air of suspicion around in 1992

...

As if somebody had committed Heresy! ...".

Back in the 1990s, a very bad thing had happened:

Two issues had arisen:

1 - Physics Issue - Does the 130 GeV Truth Quark Low Mass State exist and did the Kondo and/or Sliwa-Goldstein-Dalitz Likelihood Method find it ?

2 - Bureaucratic Issue - Was Sliwa's sharing of CDF data with Goldstein and Dalitz a serious violation of an unwritten ethical code ?

Fermilab, as a large physics collaboration with power over jobs and funding, was in position to decide which of the issues should be pursued or suppressed.

It could have decided to pursue both issues, but it did not.

It decided to suppress the Physics Issue (and the Truth Quark Low Mass State) so that individual outsiders (and their ideas) would go away and only Fermilab consensus ideas would survive in the world of physics, and the Fermilab consensus was that the one and only Tquark Mass State, the 174 GeV Mass State, would be recognized in the world of physics.

It decided to pursue the Bureaucratic Issue because that allowed Fermilab to use its jobs-funding power to enforce its consensus view that the one and only Tquark Mass State was the 174 GeV Mass State.

So, instead of searching for Truth, Fermilab asserted its Power.

Regrettably, this is a common characteristic of Human Political Bureaucracies, as is exemplified by attacks on Snowden and Assange as criminals for sharing Truthful Information with the public thus deflecting attention from the True Facts to details of Criminal Prosecution and instilling fear in others who might think about telling the Truth.

BALONEY in Bologna (page 9) indicates that LHC - CMS - ATLAS are repeating in the 2110s the errors of Fermilab - CDF - D0 in the 1990s with the Higgs playing the role of the Truth Quark

The price of those errors is that the Consensus View (page 3) will be the Only View for the Future of Physics

and

**We will never Explore
3-Mass-State NJL Higgs-Truth Quark System Experiments
to see How Physics Works going Up the Energy Scale**

The Low-Mass States (Higgs 125 GeV, Tquark 130 GeV) are in the Normal Stable region of a Higgs Mass - Tquark Mass phase diagram.

Adding Energy moves the States up along the white line until it intersects the boundary of Normal Stability with Non-Perturbativity at which point are the Middle-Mass States (Higgs around 200 GeV, Tquark 174 GeV).

Experiments in this region should tell us a lot about
Non-Perturbativity of Compositeness and 8-dim Kaluza-Klein M4 x CP2 Structure.

Adding further Energy moves up along the white line to the Critical Point at the High-Mass States (Higgs around 250 GeV, Tquark 220 GeV).

Experiments in this region should tell us about the Critical Intersection
of Normal Stability, Non-Perturbativity of Compositeness
and 8-dim Kaluza-Klein M4 x CP2 Structure, and Vacuum Instability.

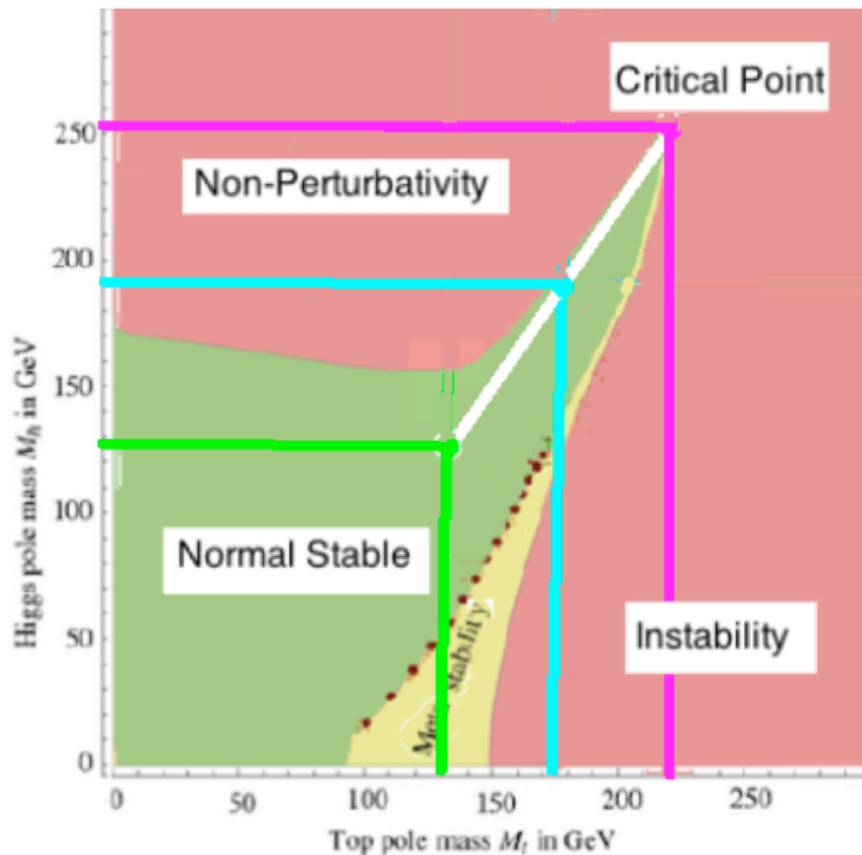

**Adding Energy beyond the Critical Point will go into
the Massless Realm of Unbroken Electroweak Symmetry
where the Higgs Mechanism no longer gives Mass to Particles.**