

# The Logic of Imaginary Time and Space

Philip J. Carter

Version 1.0  
1 January 2018

PO Box 56, Slocan BC  
Canada V0G 2C0  
philip (at) esotec (dot) org  
[www.esotec.org](http://www.esotec.org)

© Copyright P.J. Carter 2018

### Abstract

With scant regard for conventional paradigms we look squarely at the evidence and derive a space-time framework accounting for quantum non-locality and retro-causality. On this basis we gather insight into the origins of time, space and mass. We derive the mass-transformation formula according to Special Relativity and provide a context for the internal symmetries of the Standard Model. To provide a philosophical context we derive the central structure of the esoteric cosmological model from first principles while demonstrating its consistency with the framework. As a result of this unification, consciousness enters physics.

*Please note:*

While Part 1 requires some familiarity with the Foundations of Physics, the esoteric content of Part 2 should be generally accessible.

Non-mathematical readers take note: whenever the word *imaginary* appears in this document it refers not to the psychological phenomenon but to the mathematical notion of imaginary numbers, which are some real multiple of the imaginary unit, being the square root of minus one (which doesn't seem to exist in our world, yet it remains crucial to both mathematics and physics). Similarly, the mathematical term *complex* refers to some mix of real and imaginary numbers or dimensions.

### Dedication

To Imre

## Contents

### Part I: Physics

1.	Introduction to Part 1	4
2.	Time Symmetry	4
3.	The 4D Wave Function	6
4.	Minkowski 4-Space	7
5.	Non-Locality and Mass	8
6.	Causal Brane-Worlds	11
7.	Kaluza and Imaginary Space	12

### Part II: Esoterics

8.	Introduction to Part 2	16
9.	The Esoteric Planes of Being	16
10.	Cosmogenesis	18
11.	The Third Logos and the 5-Space	20
12.	Space and the Kabbalistic Tree of Life	22
13.	Conclusion	27

## Illustrations

1.	Time-Symmetric Quantum Mechanics	5
2.	The Wave Function (pure momentum state)	6
3.	Minkowski Spacetime and Minkowski 4-Space	7
4.	Null Surfaces in Minkowski 5-Space	9
5.	The Wave Function in Minkowski 5-Space	10
6.	The Domain of the Wave Function	12
7.	Cross Product of Imaginary Dimensions	13
8.	Imaginary Foundations of Real 3-Space	13
9.	Space and Symmetry	14
10.	The Seven Planes of Being	17
11.	The Law of Generation	18
12.	The Primary Manifestation	19
13.	Generation of the Planes of Being	19
14.	Descent of the Third Logos	20
15.	From Subjective to Objective	21
16.	Spatial Convergence of Physics and Esoterics	23

## Part I

# Physics

### 1. Introduction to Part I

Much of current research into quantum foundations is dedicated to collecting increasingly precise data, proving theorems, closing loopholes and finding new ones, regarding such fundamental questions as:

- a. Reality of the wave function. Is the wave function an objective entity (ontic), extended in space, or is it an abstract mathematical artifact providing knowledge of the system (epistemic)? The PBR Theorem [1] established the reality of the wave function given the mild assumption that quantum systems can be prepared independently, and related theorems have followed, though not without loopholes [2]. In 2017 a groundbreaking experiment by F. Piacentini et al. measured the quantum expectation value of a single photon, lending powerful support to the ontic view [3].
- b. Non-locality. Is quantum non-locality a fact of Nature and can it be explained in terms of 3+1 spacetime? At least two Bell tests in 2015 claim to have closed all “significant loopholes” [4]. Furthermore, experiments have established correlations between particles which never existed at the same time, suggesting nonlocal effects across time as well as across space [5]. While some continue to disagree, the experimental evidence overwhelmingly supports non-locality as a fact of Nature.
- c. Retro-causality. It has been amply demonstrated in the laboratory by various “delayed choice” experiments that the choice of observable can influence phenomena occurring in the past. For instance, V. Jacques et. al write [6]:

Our realization of Wheeler’s delayed-choice GendakenExperiment demonstrates beyond any doubt that the behavior of the photon in the interferometer depends on the choice of the observable which is measured, even when that choice is made at a position and a time such that it is separated from the entrance of the photon in the interferometer by a space-like interval. In Wheeler’s words, since no signal traveling at a velocity less than that of light can connect these two events, “we have a strange inversion of the normal order of time ...”.

The philosophical implications of these questions are so profound that adherents take an almost “religious” stand on one side or the other. In particular, the prospect of an ontic wave function raises the spectre of ontic imaginary (or complex) dimensions, which are generally considered off limits in canonical physics (“spooky”, I’ve heard it said).

Here I am not going to enter into these arguments but will take a rather different approach. Simply, what if these three fundamental phenomena are in fact “real”, occurring objectively in Nature? What are the logical consequences?

### 2. Time Symmetry

The demonstration of retro-causality and other quantum paradoxes has inspired various time-symmetric approaches to quantum mechanics, the two discussed here being Cramer’s Transactional Interpretation (TI) [7] and the Two-State Vector Formalism (TSVF), originally proposed by Aharonov, Bergmann and Lebowitz in 1964 [8].

Though their terminology and interpretations differ, TI and the TSVF share similar principles as illustrated by Figure 1. Both schemes rely on the wave function being time-symmetric under conjugation ( $i \rightarrow -i$ ), (whilst suggesting a connection between time and the imaginary axis of the wave function). In TI a quantum event is regarded as a “handshake” across time between an emitter and an absorber. The offer wave (forward-evolving) and confirmation wave (backward-evolving) can be considered standing waves extended in four dimensions – our three ordinary dimensions plus “pseudo-time”. Hence, the wave function is regarded as a holistic entity extended over time as well as over space.

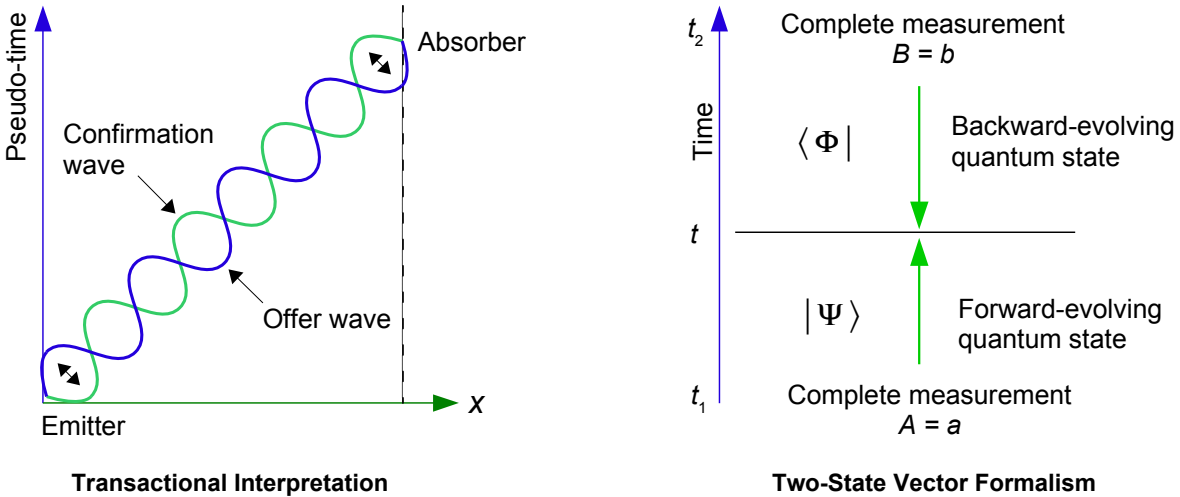

Figure 1: Time-Symmetric Quantum Mechanics

The TSVF also invokes quantum states moving forward and backward in time. Figure 1 (right) illustrates a quantum system that has been both pre- and post-selected, involving a complete (projective) measurement at times  $t_1$  and  $t_2$  while yielding eigenstates  $a$  and  $b$ . According to Aharonov and Vaidman [9] the forward- and backward-evolving quantum states together yield “maximal information about how this system can affect other systems (in particular, measuring devices) interacting with it at time  $t$ ” ( $t_1 < t < t_2$ ). They add:

The TSVF approach is time symmetric. There is no preference to [sic] the results of measurements in the past relative to the results of measurements in the future: both are taken into account. Then, there is more information about the system at time  $t$ .

Once again the implication is that the wave function is a holistic entity extended in time as well as in space. Why is this so important?

Let us back up for a moment. In our 3+1 spacetime we can only observe in the present moment (even light from stars is observed in the present). Or we could say that reality is always right now. We cannot say that the past, present and future of a physical object constitute a holistic entity – nowhere in 3+1 spacetime are the past or future to be found.

Not so for the wave function. Keep in mind that the horizontal axes in Figure 1 represent our three real spatial dimensions, whereas the vertical axis, while corresponding to time, is not time but a fourth spatial dimension. Hence each diagram represents a 4-space.

It follows that the wave function does not live in our 3+1 spacetime, but in a 4-space, which must necessarily be superimposed upon (interpenetrating) our 3-space. The 4-space and 3-space coincide, since the wave function in the 4-space always corresponds to its lower-dimensional cross-section in the 3-space.

Our 3-space could therefore be considered a cross-section (slice) of the 4 space at some coordinate of the fourth spatial dimension, which cannot be considered time but the *precursor* to time. Time in 3+1 spacetime originates in the motion of the 3-space relative to the fourth spatial dimension of the 4-space. It is the *relative spatial motion* that manifests as the phenomenon of time.

To help visualize this arrangement one might imagine the wave function living in a 4-brane which is superimposed upon (interpenetrating) our 3-brane. While anathema, it solves the logical crisis. In fact, it may be the only way to solve the logical crisis. We have arrived at two different worlds: the world we experience as our physical universe, 3+1 spacetime, and the higher-dimensional world of the wave function, a 4-space which is somehow superimposed upon our own. Since we don't observe this higher-dimensional world, we surmise that it constitutes a separate space, isolated from our own yet intimately related to it.

### 3. The 4D Wave Function

Since the wave function lives in a 4-dimensional space, it follows that the wave function itself must be extended in four dimensions. This is readily achieved by a simple reinterpretation of established facts.

Figure 2 illustrates the most regular of wave functions, a pure momentum state, originally due to Roger Penrose [10]. While the general wave function won't look like this, the dimensionality remains. That is, the wave function is a complex wave, extended in the three real spatial dimensions (represented by the  $x$  axis) and with complex phase, commonly understood as a total of five dimensions to represent the wave function.

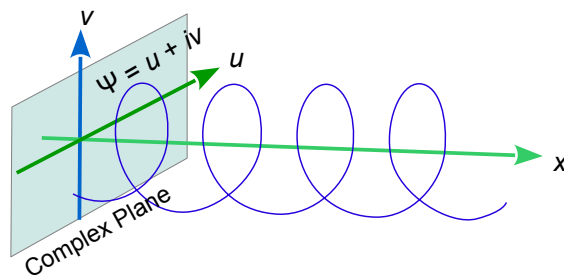

Figure 2: The Wave Function (pure momentum state)

If we admit imaginary dimensions, however, the wave function becomes 4-dimensional, with the real axis of the complex plane  $u$  corresponding to one of the three real dimensions (say  $y$ ). By this simple reinterpretation the wave function lives happily in the 4-space, with one caveat: the fourth dimension must be imaginary. Once again, this is simple, direct logic, but with profound consequences.

The fourth, imaginary axis of the wave function corresponds to the fourth dimension of the 4-space, which we have established is the precursor to time in our 3-space. It follows that the fourth dimension of the 4-space is imaginary and the imaginary axis of the wave function corresponds to time; hence time enters quantum mechanics as a dynamical variable rather than an input parameter as it is today.

Note that because the quantum formalism describes a system of  $N$  particles in terms of  $3N$  dimensions it is frequently claimed that the wave function lives in  $3N$  dimensions [11]. This proliferation of dimensions is required to represent four-dimensional objects (living in Minkowski 4-space, see below) in our 3+1 spacetime; when the wave function is formulated in four spatial dimensions and governed by the appropriate metric the technical need for these extra dimensions will disappear.

#### 4. Minkowski 4-Space

The idea of a space including three real dimensions and one imaginary dimension is not new. In fact it is commonly applied by researchers in both relativity and quantum theory. It is known as *Euclidean spacetime*, which is really a misnomer since it is in fact purely spatial. The term *Euclidean* refers to the resulting symmetric metric, being an extension of the Pythagorean theorem to four dimensions (although there is nothing Euclidean about imaginary dimensions). So, for present purposes we shall call it *Minkowski 4-space*.

Euclidean spacetime (Minkowski 4-space) is Minkowski (3+1) spacetime with the time coordinate rotated on the complex plane (Wick rotation), yielding “imaginary time”,  $\tau = it$ . (Note: for the sake of logical clarity all imaginary terms following will be **bolded**). Imaginary time has important applications in both general relativity and quantum field theory. Calculations in Feynman’s sum over histories formulation are in imaginary time. Under certain conditions the Green’s functions are periodic in imaginary time. In cosmology, the Hartle-Hawking no-boundary proposal depends upon imaginary time to remove singularities. Theorists apply Wick rotations on a daily basis without having a clear physical picture of what the transformation represents or why it works. But it does work, and very well it seems, which is to be expected when Minkowski 4-space is where the wave function finds its home.

Here we take the “Euclideanization” of spacetime a step further by considering the fourth (imaginary) dimension  $w$  to be spatial, where  $w = it$ . That is, the dimension  $w$  denotes not imaginary *time* but imaginary *space*. Since all four dimensions are spatial, the displacement  $s$  also represents a spatial distance, which may be real or imaginary. We do this for obvious reasons: Minkowski 4-space becomes a viable home for the wave function, offering the correct dimensionality while supporting retro-causality and non-locality, as we shall see.

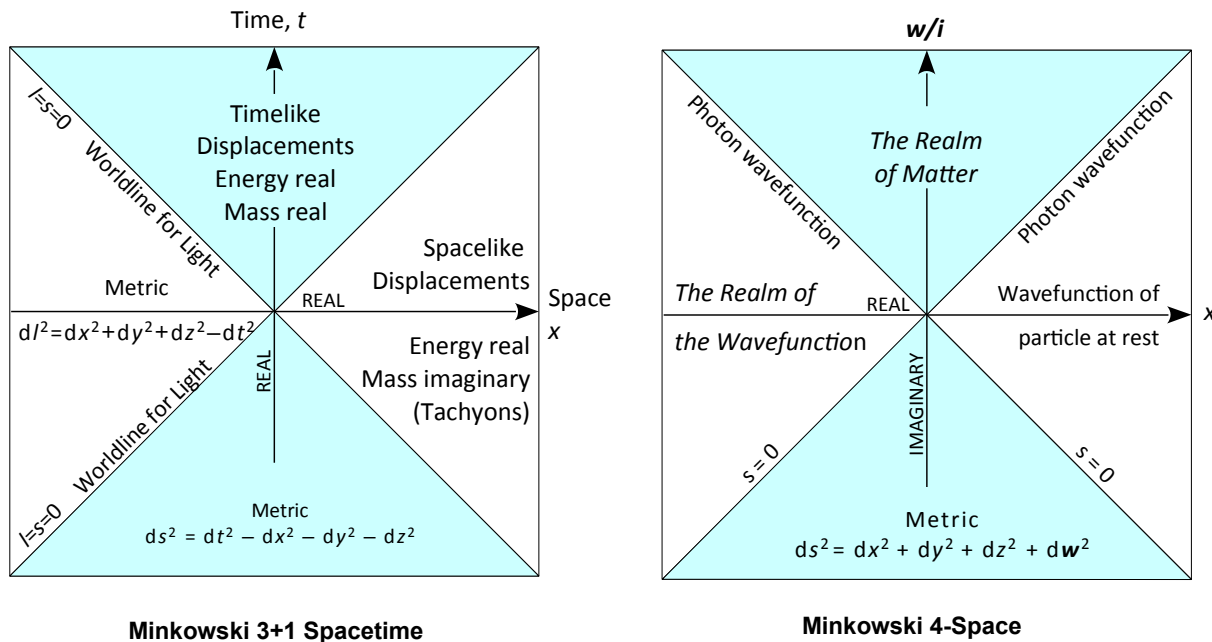

Figure 3: Minkowski Spacetime and Minkowski 4-Space

Figure 3 provides a static picture of Minkowski 4-space. A more realistic picture is the dynamic one: if we take the horizontal axis as the present moment, then the vertical ( $w$ ) axis is in a state of constant downward motion as our present moment moves into the future. It is this “motion” of the  $w$  dimension relative to the real dimensions in the 4-space (and hence in the 3-space) that underpins the flow of time in the 3-space.

It follows that the 4-space itself is evolving, meaning it too must have a time dimension. This cannot be physical time, since physical time is the *result* of this evolution of and in the 4-space. Rather, the 4-space itself must have a time dimension, yielding a 4+1 spacetime. To avoid confusion, time in the 3-space we denote  $t_3$  and 4-space time  $t_4$ .

We are now in a position to answer two very profound questions. First, what is the basis for Wick rotations; that is, how and why do they work? Second, if physical time results from motion of our real 3-space over an *imaginary* dimension in the 4-space, why do we experience physical time as real? Clocks measure real seconds after all. The answer to both these questions is the same. And so we offer the ultimate spoiler:

Time in the 4-space,  $t_4$ , is imaginary. Note that this is not the standard notion of “imaginary time”, which is essentially the motion of the imaginary  $w$  dimension relative to the real dimensions. Here we are saying that the time dimension in 4+1 spacetime is imaginary, which is something else entirely, at a deeper level.

Physical time therefore results from an imaginary dimension moving in imaginary time, so the resulting motion (time  $t_3$ ) is real. In a nutshell:

Physical time  $t_3 = dw/dt_4$

This identity implies that time is equivalent to spatial motion over a higher dimension, which is precisely the case. We shall go into more details about how this works later on.

## 5. Non-Locality and Mass

A key piece to this puzzle is the following well-known formula for the propagation of the wave function, originally due to de Broglie:

$$v_{ph} v_g = c^2 \quad (1)$$

where  $v_{ph}$  is the phase velocity (associated with the propagation of the wave function itself),  $v_g$  is the group velocity (generally associated with particle velocity, or more fundamentally the propagation of energy), and  $c$  is the speed of light.

A photon emitted at the origin of Minkowski spacetime will travel at speed  $c$  while adhering to the light cone, where the displacement  $s = 0$ . From the propagation formula (1) it follows that the wave function itself will also propagate at a phase velocity of  $c$ , and hence will also adhere to the light cone. Accordingly, in Minkowski 4-space the wave function will be oriented in space so as to adhere to the null cone, defined by  $dx^2 + dy^2 + dz^2 + d\omega^2 = 0$  ( $c = 1$ ). Since the wave function adheres to the null cone, there is no spatial distance between any parts of it. As unintuitive as it may seem from our perspective in 3+1 spacetime, technically the entire photon wave function is located at one “place” in Minkowski 4-space, defined by its null cone, which accounts for the three key characteristics of non-locality [12]:

- The quantum connection is unattenuated (over any distance).
- The quantum connection is discriminating (i.e. confined to specific null cones).
- The quantum connection is faster than light (instantaneous).

The basic idea is that wave functions always adhere to null geodesics, hence always remaining holistically connected across both space and time. As elegant as this principle is, the properties of Minkowski 4-space do not account for massive particles. According to the propagation formula (1) the wave function of a massive particle at rest will travel at infinite velocity, corresponding to zero extension on the  $w$  axis, which is definitely not on a null cone.



The solution is hidden in the fact that the 4-space itself has a time dimension, which implies the presence of a higher-dimensional spatial precursor to time  $t_4$ . Accordingly we introduce a fifth spatial dimension  $\nu$ , which is directly related to energy and mass. To accomplish this while retaining a Euclidean metric the fifth dimension is imaginary like the fourth, constituting *Minkowski 5-space*, where:

$$ds^2 = dx^2 + dy^2 + dz^2 + d\boldsymbol{w}^2 + d\nu^2$$

The structure of Minkowski 5-space is illustrated in Figure 4, wherein the green rectangle represents Minkowski 4-space. The hyperbolic 5-dimensional null surfaces intersect the 4-dimensional null cone and extend out over the “superluminal” quadrants only.

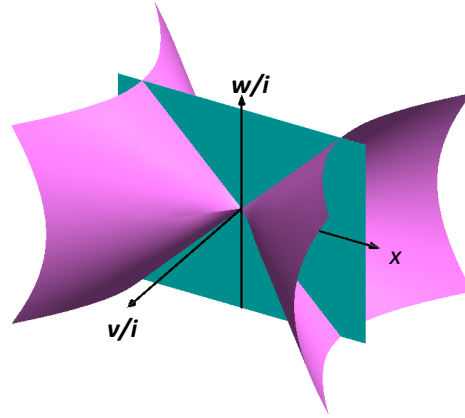

**Figure 4: Null Surfaces in Minkowski 5-Space**

Let us assume that the wave function will always adhere to a null geodesic – to a null cone in Minkowski 4-space for a massless particle, or a null surface in Minkowski 5-space for a massive particle. Figure 5 illustrates Minkowski 5-space from a similar perspective to Figure 4, but with the null surfaces removed for clarity. The shaded area represents inside the null cone in Minkowski 4-space, with the  $\nu$  dimension projecting out from the origin. Three wave functions are considered:

- A. The wave function of a massless particle, which is extended only in the  $x$  and  $\boldsymbol{w}$  dimensions, hence adhering to a null cone in Minkowski 4-space while propagating at velocity  $c$  in 3+1 spacetime.
- B. The wave function of a massive particle at rest. Since  $d\boldsymbol{w} = 0$ , the wave function adheres to a null surface in Minkowski 5-space.
- C. The wave function of a massive particle in motion (relative to this frame). Phase velocity becomes finite, so the wave function extends into the  $\boldsymbol{w}$  dimension;  $d\boldsymbol{w}$  is increased while  $d\nu$  is decreased to meet  $s = 0$  according to the Euclidean metric.
- D. The wave function C projected onto the  $\nu$  axis.

Consider a wave function with real spatial extension  $x$  ( $dy = dz = 0$ ), measuring from the origin, while adhering to the null Euclidean metric:

$$x^2 + \boldsymbol{w}^2 + \nu^2 = 0$$

Let  $\boldsymbol{w} = \mathbf{i}ct$ ,  $\nu = \mathbf{i}V$ . Therefore:

$$x^2 = (ct)^2 + V^2$$

$$\text{or, } V = \sqrt{x^2 - (ct)^2} \quad (2)$$

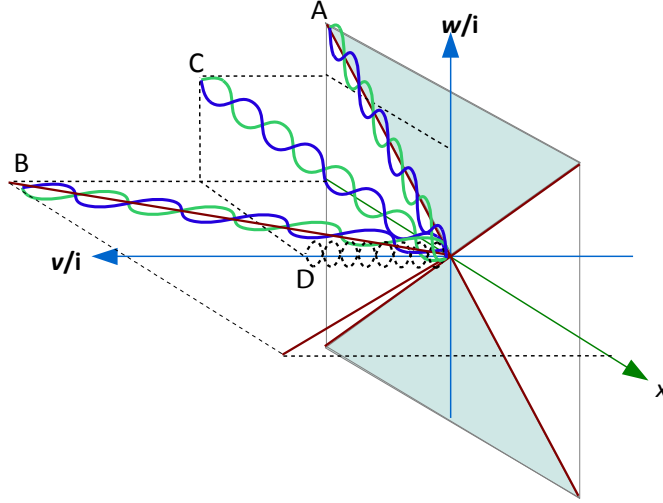

Figure 5: The Wave Function in Minkowski 5-Space

The wave function phase velocity will be observed in 3+1 spacetime as real distance over time:

$$v_{ph} = \frac{x}{t}$$

While phase velocity can also be expressed in terms of (1):

$$v_{ph} = \frac{c^2}{v_g}$$

Hence:

$$\frac{x}{t} = \frac{c^2}{v_g}$$

or,

$$t = \frac{x v_g}{c^2}$$

Substituting for  $t$  in (2):

$$\frac{V}{x} = \sqrt{1 - \left(\frac{v_g}{c}\right)^2}$$

From Figure 5 (D) it is clear that the frequency relative to the  $v$  dimension, hence energy and mass, is inversely proportional to  $dv$ , such that the mass  $m$  of an accelerated particle with rest mass  $m_0$  is given by  $m/m_0 = V_0/V$ .

Hence:

$$m = \frac{m_0}{\sqrt{1 - \left(\frac{v_g}{c}\right)^2}}$$

This of course is the transformation for mass according to Special Relativity, where the group velocity  $v_g$  is taken to be the velocity of the particle in 3+1 spacetime. This result derives logically from elementary principles of both relativity and quantum mechanics in the context of the current framework while bringing fresh insights to the foundations of relativity and quantum gravity.

Note that the  $\nu$  dimension is orthogonal to the 4-space, and hence to 3+1 spacetime, suggesting a geometrical mechanism by which the wave function of a massive particle “curves” spacetime. A change of velocity in 3+1 spacetime equates to changing location on the  $\nu$  dimension, which requires energy, this being the mechanism of inertia.

Note also that this understanding may well provide a resolution to Maudlin’s objection to the Transactional Interpretation [13]. In a nutshell, the energy required to move the absorber will displace it on the  $\nu$  dimension so as to remain on a null geodesic along with the emitter in Minkowski 5-space.

## 6. Causal Brane-Worlds

While theorists and philosophers grapple with the exponentially bifurcating worlds of the Many Worlds picture or the infinite abundance of the cosmological multiverse, our proposal is rather more modest: a “multiverse” of sorts, but with an important difference. The worlds are causally related, so in fact the system is not a “multiverse” at all but a single Universe consisting of superimposed discrete spaces. Just four such interpenetrating worlds can account for known physics.

Since these other worlds are right here, in and around us, why don’t we perceive them? The framework logically requires that the superimposed spaces confine matter while not confining the wave function – the wave function extends into whatever dimensions are available in each space. String theory comes to our assistance with the D-brane, which will confine matter fields while being transparent to gravity. It follows that from our perspective in the 3-brane we can never interact with the 4-brane or the 5-brane, though we share their gravity (which may conceivably be revealing itself as Dark Energy). The branes reside in a higher-dimensional “bulk” with each brane excluding those dimensions beyond its own particular dimensionality. That is, the branes coincide – each brane shares the same three real dimensions, but because the imaginary dimensions  $\omega$  and  $\nu$  are excluded from the 3-brane they remain in principle unobservable.

Since only gravity (the geometry of spacetime itself) can propagate freely through and between the branes, we are forced to surmise that the wave function is a gravitational wave. This bold idea finds support from various perspectives. Since the wave function is the universal precursor to matter, the wave function must precede matter – that is, the wave function itself is immaterial, incorporeal. Does it make sense to speak of an objective, extended, incorporeal entity? Moreover, the wave function is a complex wave, spiraling simultaneously through real and imaginary dimensions. We suggest that only one type of wave could accomplish such a feat, being oscillations of complex spacetime itself – higher-dimensional gravitational waves. Moreover, gravitational waves can be of any frequency and propagate in 3+1 spacetime at speed  $c$  while adhering to null geodesics. While low-frequency gravitational waves don’t interact with matter, high frequency gravitational waves could conceivably excite energetic fields exhibiting the appropriate harmonics.

Time is understood as translation (motion) over the imaginary dimensions  $\omega$  and  $\nu$ . Accordingly, at each moment of time  $t_3$  our physical universe reflects a slice of the 4-space at a particular coordinate  $\omega$ . Similarly, at each moment of time  $t_4$  the 4-space reflects a slice of the 5-space at some coordinate  $\nu$ . These “spatial motions” could perhaps be better understood in terms of Killing vectors or the propagation of energy. Whatever their underpinnings, the end result is that the present moment *appears* to move over these higher dimensions, providing the impression that these dimensions are in motion relative to the 3-space. Moreover, the term *motion* implies *energy*, bringing us to ponder the duality between time and energy.

For present purposes, let us assume that time in the 5-space,  $t_5$ , is real. Time in the 4-space thus derives from motion of the imaginary dimension  $\nu$  in real time  $t_5$ . Hence the flow of time  $t_4$  in the 4-space,  $d\nu/dt_5$ , is *imaginary*. Consequently everything in the 4-space evolves in imaginary time.

Similarly, time in our 3-space originates from motion of the imaginary dimension  $w$  in imaginary time  $t_4$ . Hence the flow of time  $t_3$  in the 3-space,  $dw/dt_4$ , is *real*. It follows that Wick rotations are nothing more than moving between 3+1 spacetime and the 4-space ( $t \rightarrow w \rightarrow t$ ). In short, physical time is real because the time dimension in 4+1 spacetime is imaginary.

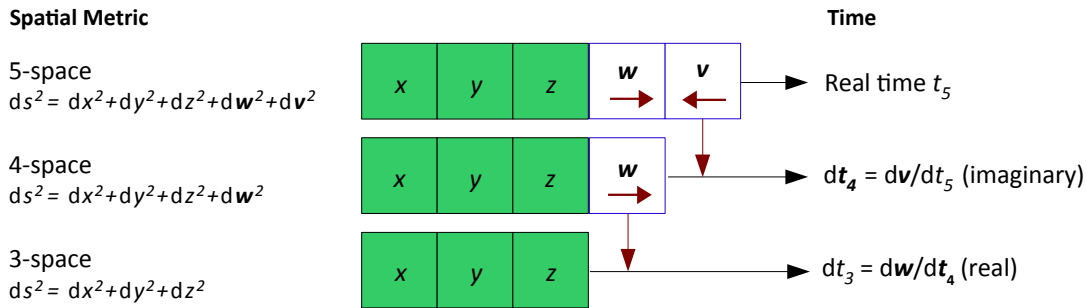

Figure 6: The Domain of the Wave Function

It goes without saying that the elegant logic of this framework is fully reliant upon the existence of imaginary dimensions, presenting a direct challenge to the so-called “assumption of physicality”. Nonetheless, we have already noted that the imaginary dimensions  $w$  and  $v$  cannot in principle be observed in our 3+1 spacetime, so their existence cannot be ruled out on logical or empirical grounds. Rather, we take the idea further: given the importance of imaginary dimensions in the structure of spacetime, what other roles might they play? Taken to its logical conclusion, could it be that space is fundamentally imaginary?

## 7. Kaluza and Imaginary Space

Kaluza’s 5-dimensional Einstein-Maxwell theory formally unites Einstein’s gravity and Maxwell’s electromagnetism in 4+1 real dimensions. While its power and elegance are undisputed, the theory has never found a satisfactory context in our 3+1 spacetime; where is the fourth spatial dimension? Despite efforts by Klein and others to curl up the extra dimension, along with efforts by the late Paul Wesson and the Space-Time-Matter Consortium to extend Kaluza’s work [14], a consistent context for the theory remains elusive.

Our immediate task, then, is to find the correct context for Kaluza’s 5-dimensional theory within the current framework, which at first glance does not look promising. While Kaluza’s theory is formulated in four real spatial dimensions, the extra dimensions of the 4-space and 5-space are imaginary. Having deduced that gravity is intimately related to the imaginary dimension  $v$ , Kaluza’s theory would consistently apply to the 5-space, if only the dimensions were to match.

The fact that Kaluza’s theory requires one extra real dimension, whereas the 5-space offers two extra imaginary dimensions, represents both a problem and a hint. What might Nature be telling us? We have two extra imaginary dimensions in the 5-space and we need one real dimension, so we ask: Might it be possible that the two imaginary dimensions  $w$  and  $v$  combine or interact, perhaps in some sense as a cross product, to project a mutually orthogonal real dimension?

I wish to argue that this not only can but will occur, on the basis of the following assumptions:

- a. The two imaginary dimensions constitute an imaginary 2-space (subspace) within the 5-space.
- b. Nature makes use of the cross product in imaginary space as it does in real space (e.g. electromagnetism).

Accordingly, the cross product of any two vectors in the imaginary 2-space will project a mutually orthogonal real vector. Generalizing to a dimensional level, we could say that the two imaginary dimensions project a mutually orthogonal real dimension (denoted  $l$  in accordance with Space-Time-Matter theory).

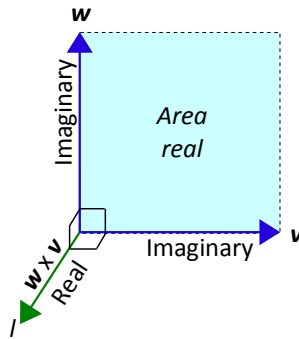
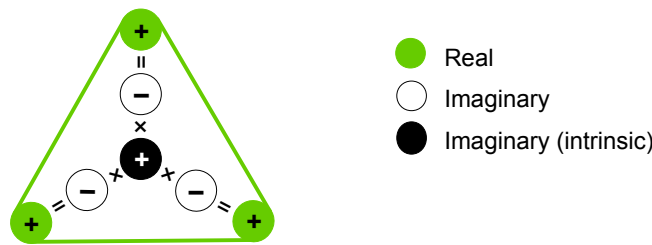

**Figure 7: Cross Product of Imaginary Dimensions**

According to the algebra of imaginary numbers, similar imaginary dimensions will project a real dimension of negative norm, raising the question of *polarity* or *handedness* in our descriptions. A “negative” real dimension could account for the fact that the fourth dimension is treated differently in Kaluza’s theory, having the “cylinder condition” imposed upon it, with the effect that it is not directly involved in the resulting physics.

Having established a logical mechanism by which real dimensions may emerge from imaginary dimensions, it is natural to ask whether our real 3-space itself might be fundamentally imaginary. It would seem extraordinary that Nature would employ two types of real dimensions: those that are real *a priori* and those projected from imaginary dimensions. *Occam’s Razor therefore demands that all dimensions be fundamentally imaginary.* It follows, of course, that Reality is fundamentally imaginary (which is not as big a deal as you might think – it simply means that consciousness precedes matter, as we shall see).

Under the cross product rule the most economical way to project three real dimensions from imaginary dimensions is illustrated schematically in Figure 8. The positive “intrinsic” dimension interacts with the three mutually orthogonal negative dimensions to project a real 3-manifold, represented by the triangular outline. (The polarities of the imaginary dimensions could be reversed, of course, to the same effect.)



**Figure 8: Imaginary Foundations of Real 3-Space**

While this proposal may appear fanciful (or perhaps a little spooky), it is logically consistent while delivering unforeseen technical and philosophical opportunities. For instance, it promises to answer one of the most perplexing questions in theoretical physics, that being the origin of the internal symmetries of the Standard Model. These may be listed as follows:

- $SU(2)$            Governs quantum spin phenomena.
- $SU(2) \times U(1)$    Governs the Electroweak interaction.
- $SU(3)$            Governs the Strong interaction.

The indices refer to complex variables:  $U(1)$  is the unitary group of one complex variable,  $SU(2)$  the special unitary group of two complex variables, and so on. The question is: Why these particular symmetry groups and not others? The gauge symmetries of the Standard Model are essentially *property spaces*, such as the three quark

colors, for instance, or the colors of the eight gluons (two of nine being overlapping). Why do these colors adhere to the particular transformations represented by the  $SU(3)$  symmetry group?

Figure 9 illustrates a possible answer to this question. The general principle is that the spatial dimensions comprising each space (brane) may present themselves in the following ways:

- a. Configured around an “objective” real 3-manifold.
- b. Configured for maximal symmetry while allowing complex dimensions.

For the 3-space and the 6-space these alternatives coincide. However, the five imaginary dimensions of the 4-space can present themselves either as a real 3-manifold plus one orthogonal imaginary dimension, or as two complex dimensions, reflecting the dimensionality of the  $SU(2)$  symmetry group. The 5-space can present itself as a real 3-manifold along with two imaginary dimensions, which together project a fourth (negative) real dimension  $l$ ; or it can present itself as three complex dimensions reflecting the dimensional configuration of the  $SU(2) \times U(1)$  symmetry group. (Note that the  $w$  and  $v$  dimensions are both taken to be of negative polarity, for reasons that will become clear in due course.)

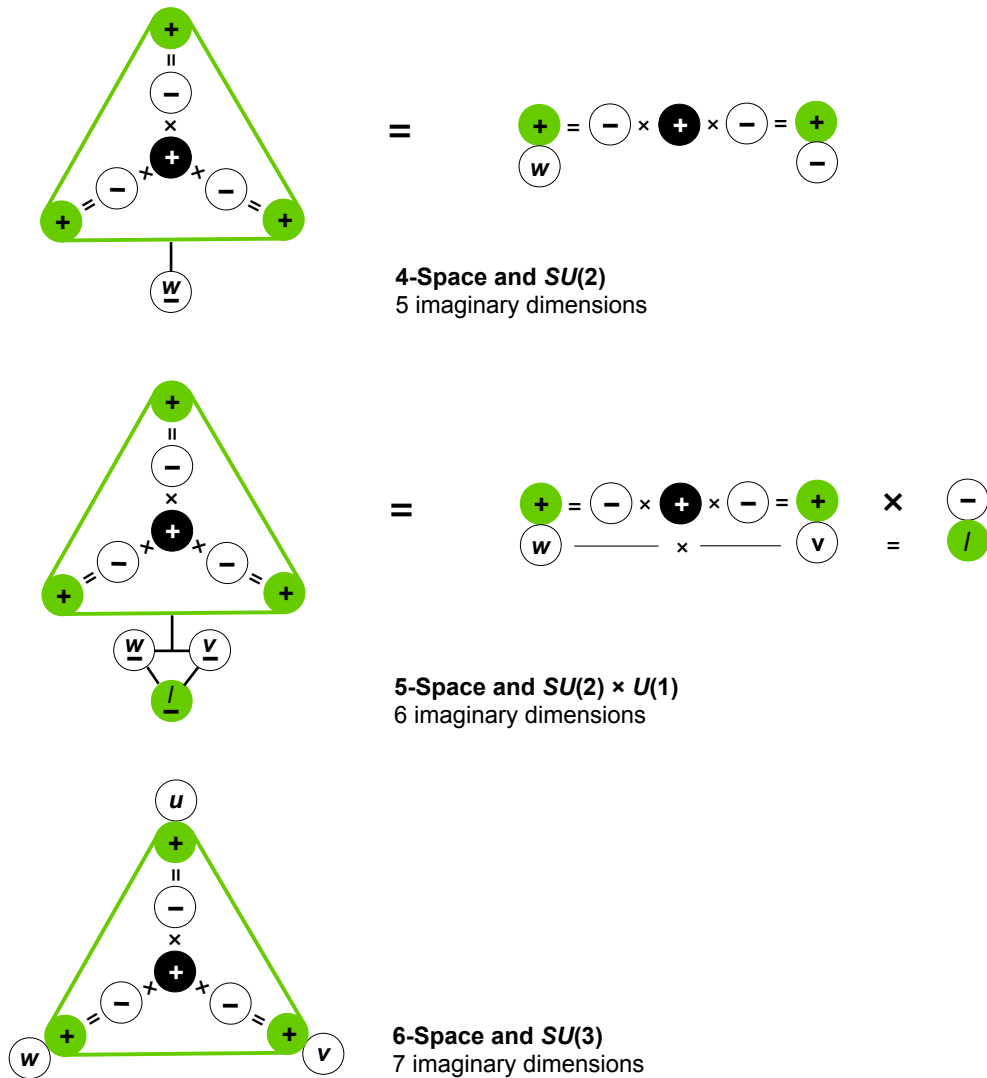

Figure 9: Space and Symmetry

Note that these schematic diagrams are intended to demonstrate the dimensional logic of the various spaces and certainly not their geometry. Lines represent orthogonality, while real and imaginary dimensions joined represent one *complex* (summed) dimension.

The  $SU(3)$  symmetry group suggests the presence of a 6-space (3 real and 3 imaginary), which is further required as a precursor to time  $t_5$  in the 5-space (the imaginary dimension  $\mathbf{u}$ ). For both technical and philosophical reasons (see Part 2) the dimension  $\mathbf{u}$  is considered to be static – that is, time (spatial motion) originates in the 5-space. The motion of the  $\mathbf{w}$  and  $\mathbf{v}$  dimensions relative to the  $\mathbf{u}$  dimension (all imaginary) yields *real* time  $t_5$  in the 5-space.

It should be noted that these correlations are entirely dependent upon the imaginary foundations of real 3-space, as described, the intent being to lend credence to the proposal while further substantiating the application of Kaluza's theory to the 5-space. Being locked up within real 3-space the imaginary dimensions remain unobservable, but their *effects* become apparent at the quantum level – when performing a spin measurement, for instance. Nevertheless, to establish theoretically the imaginary foundations of space would mean forever abandoning the assumption of physicality, which not all will be willing to do. After all, if imaginary dimensions are in principle unobservable, how are we supposed to think about them? Is this science? If they are not “real”, what exactly *are* imaginary dimensions? Do they really exist?

To address this question we turn to an unlikely source, the Wisdom of the Ancients – those who looked *into* the Universe rather than just at it, collectively known as the *Esoteric Tradition*. With their help we will find that we are more familiar with imaginary dimensions than we may realize.

## Part II

# Esoterics

### 8. Introduction to Part II

Esoteric philosophy has a somewhat deserved reputation for being irrational gobbledygook – deserved in the sense that the literature is too often veiled, opaque, turgid, confusing or just plain wrong, while terminology often conflicts with scientific usage, inevitably leading to gross misunderstandings. In this section I wish to remove the veils and show the reader that the esoteric model is indeed logically consistent, being erected on the most fundamental of premises while elucidating space, consciousness and matter. Moreover, I wish to demonstrate that the esoteric cosmological model is consistent with the current framework while adding substantial depth to it. While the current framework has been derived from the bottom up, so to speak (from physical and mathematical principles alone), we shall derive the esoteric model from the top down – that is, from first principles – while showing that they remain fully compatible.

While *esoteric* has come to mean “accessible to a specialized few” in the vernacular, the original Greek word *esoterikos* means “turning inwards” or “inner”. While the exoteric scientist investigates the outer world through his physical senses, the esoteric scientist explores the inner worlds – the higher branes or spaces – through his inner senses, or higher faculties of consciousness. Thus have the great Rishis and Adepts brought down a consistent teaching over the ages concerning the nature of Reality.

It is essential to note that this process is not the same as common psychism, channeling or shamanism, which the genuine esoteric scientist would consider primitive and unreliable. Down through the ages the Adepts have gathered information while in profound states of meditation, whereby they objectively explore the inner worlds (which essentially involves stilling the lower in order to apprehend the subtler). The universal consistency of their testimony, when correctly translated and understood, suggests that we should lend them an ear.

This does not mean that the reader is asked to accept what follows as revelation; rather, it is to be approached as a logical framework to be investigated on its own merits (though this writer cannot take credit for it).

### 9. The Esoteric Planes of Being

Let us begin by taking a quick look at what might be considered the central glyph of esoteric cosmology: the Seven Planes of Being, or Planes of Consciousness, or *Loka* in Sanskrit [15]. (Note that Sanskrit is used extensively in esoteric philosophy simply because it has the most detailed esoteric vocabulary of any language; hence the reader is asked to be patient with unfamiliar terminology.) In Figure 10 the seven planes are named according to both modern English and Sanskrit terminology (while keeping in mind that each plane has any number of names, according to the language, era and context). Notice that our physical universe is considered not the beginning but the end of the process – six planes precede it. This might help explain why physicists are having a challenging time trying to explain physical phenomena in the context of 3+1 spacetime alone (even with compactified extra dimensions).

Keep in mind that Figure 10 is a glyph, a schematic representation with inherent limitations. For a start, while laid out vertically, the planes should really be stacked on top of each other. That is, the seven planes are interpenetrating (superimposed) up to their particular dimensionality. They are all right here, right now, but as a matter of principle we cannot access the higher planes through our physical senses or instruments. The higher planes can be accessed by consciousness alone – when we “tune up” our consciousness to match the frequency of a particular plane.



## The Logic of Imaginary Time and Space

<b>1</b> 9-dimensional	Logoic Plane <i>Mahāparanirvāṇa</i>	The Logos	The Realm of Eternal Duration <i>No Time or Objective Forms</i>
<b>2</b> 8-dimensional	Monadic Plane <i>Paranirvāṇa</i>	The Saviour	
<b>3</b> 7-dimensional	Spiritual (Ātmic) Plane <i>Nirvāṇa</i>	The Adept	
<b>4</b> 6-dimensional	Intuitional Plane <i>Buddhi-Loka</i>	Pure Consciousness The Mystic, the Saint	
<b>5</b> 5-dimensional	Mental Plane <i>Manasa-Loka</i>	Higher Mind (abstract) ----- Lower Mind (rational)	The Realm of Time <i>Tripurā: the Three Worlds</i>
<b>6</b> 4-dimensional	Emotional (Astral) Plane <i>Kāma-Loka</i>	Subconscious Mind (dreams)	
<b>7</b> 3-dimensional space	Physical Plane <i>Prakṛiti</i>	Etheric-Physical ----- Dense Physical	

**Figure 10: The Seven Planes of Being**

Please note the following:

- Each plane corresponds to a certain quality, type or state of consciousness. An important clue is hidden here. The seven planes are each planes of *being*, having certain spatial and material characteristics, and also planes of *consciousness*. The clue is that space and consciousness are dual.
- Notice that each plane includes one more dimension than the plane below it, in accordance with the current framework. As one rises up the planes, consciousness increases and matter becomes more subtle.
- We are already in touch with the inner planes. Every time we think, we are operating on the Mental Plane. Every time we feel an emotion or a desire, we are operating on the Astral Plane. Every time we feel deep heart-felt love (meaning transpersonal, spiritual love), we are operating on the Intuitional (Buddhic) Plane. Few of us experience any higher than that. However, we are all quite familiar with the Astral Plane since that is the space in which we dream (and where we go when we die).
- The three lower planes are known in Sanskrit as *Tripurā*, the “Three Worlds”. The Three Worlds constitute the sum total of the natural human experience, wherein we circulate life after life – what in Buddhism is known as *Samsāra*. Take note that time exists only in the Three Worlds; in higher dimensions time is replaced by something called *Eternal Duration* where things exist in eternity but time does not flow.
- The Three Worlds are called “worlds” because they are exactly that; they each include a real 3-space, which permits objective experience on each of these planes. Beyond the Three Worlds there is no “objective” experience as we understand it, nor forms, nor time, but purely consciousness and energy (Light) in the here and now.

From the point of view of the scientist or logician, of course this is all very well – it all makes for a nice story, and rather arbitrary at that. After all, why seven planes, why not ten, or fifty? To satisfy this question we must return to fundamental principles.

## 10. Cosmogenesis

Esoteric cosmology is founded on the most basic of principles, so simple and universal that physical scientists likely never give it a passing thought. It may be called the *Law of Generation*, the *Law of Three*, or simply the *Triad*. It could also be called the *Law of Polarity*. It is essentially this:

- The interaction of a polarized pair will generate a third reality of a different order.

The Law of Generation occurs everywhere in Nature, even on the physical level. Here are a few examples:

- The nucleus (positive) and electrons (negative) of an atom combine to manifest an order of reality (matter) very different from that of the constituents.
- Sexual reproduction is an obvious example, with the “different order” being represented by the unique genetic code of the offspring.
- An electric cell is simply potential until its electrodes are connected, whereupon phenomena of a different order arise: currents, fields and so on.

The esoteric Adepts speak of the positive polarity as “masculine” and the negative polarity as “feminine”.

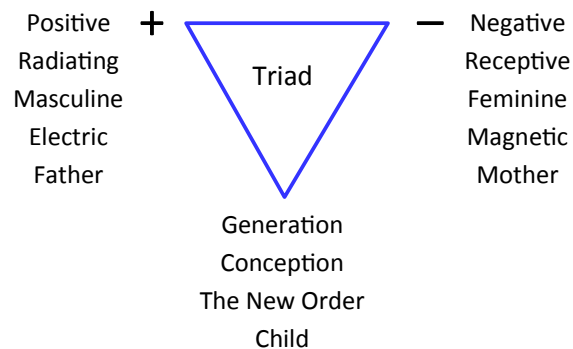

**Figure 11: The Law of Generation**

According to the Adepts, this simple principle applies not just to phenomena within our Universe but to the generation of the Universe itself. Logically, to explain Reality one must begin with a single thing or else there is complexity yet to be understood. So, quite typically, the esoteric Adepts do just that. H. P. Blavatsky, co-founder of the Theosophical Society, establishes this basis as follows [16]:

[We postulate that] there is one absolute Reality which antecedes all manifested, conditioned, being. This Infinite and Eternal Cause ... is the rootless root of “all that was, is, or ever shall be.” It is of course devoid of all attributes and is essentially without any relation to manifested, finite Being. It is “Be-ness” rather than Being ... and is beyond all thought or speculation. This “Be-ness” is symbolized in the Secret Doctrine under two aspects. On the one hand, absolute abstract Space, representing bare subjectivity, the one thing which no human mind can either exclude from any conception or conceive of by itself. On the other, absolute Abstract Motion representing Unconditioned Consciousness.

(Hint: Wherever in the esoteric literature you see terms such as “abstract space” or “abstract motion”, think “imaginary space” or “imaginary motion”.)

For some unknown and unknowable reason this one absolute Reality polarizes itself into positive and negative (male and female) qualities or attributes, thus generating a third factor of a different order according to the Law of Generation. The resulting phenomenon is known in esoteric philosophy as the *Primary Triad*, or in Sanskrit as *Trimūrti*, the “three-faced God”, or in Christianity as the *Trinity*. This teaching is universal down through the ages.

The Logic of Imaginary Time and Space

	<i>Sanskrit</i>	<i>Egyptian</i>	<i>Greek</i>	<i>Christian</i>
First Logos:	Shiva	Osiris	Logos	Father
Second Logos:	Vishnu	Horus	Monos	Son
Third Logos:	Brahmā	Isis	Pneuma	Holy Spirit

The Greek word *logos* literally means “speech, word, thought, reason”. The Gospel of John begins, “In the beginning was the Logos, and the Logos was with God, and the Logos was God.” The Logos may best be described as a Conscious-Creative Principle and is applied on a variety of levels. As a result of this process the one Logos becomes three Logoi, which together constitute what the Greek Adepts called the *Monad*.

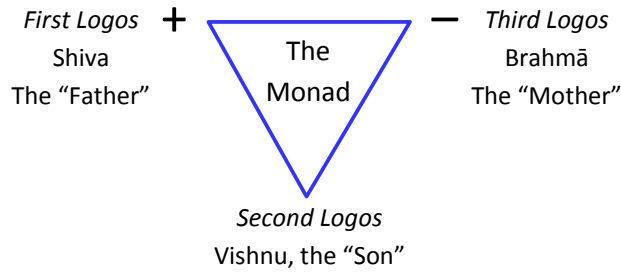

Figure 12: The Primary Manifestation

The Monad is the Primary Manifestation, the first step towards manifesting objective worlds and experience out of bare subjectivity. But we are not there yet; then the whole process must repeat itself. Just as an atom contains within itself the nucleus and electrons, in addition to being something else entirely (of a different order), so does the Monad (which is technically the Second Logos) contain all three Logoi within itself. So do the three Logoi constituting the Monad each project a Triad, on another turn of the spiral.

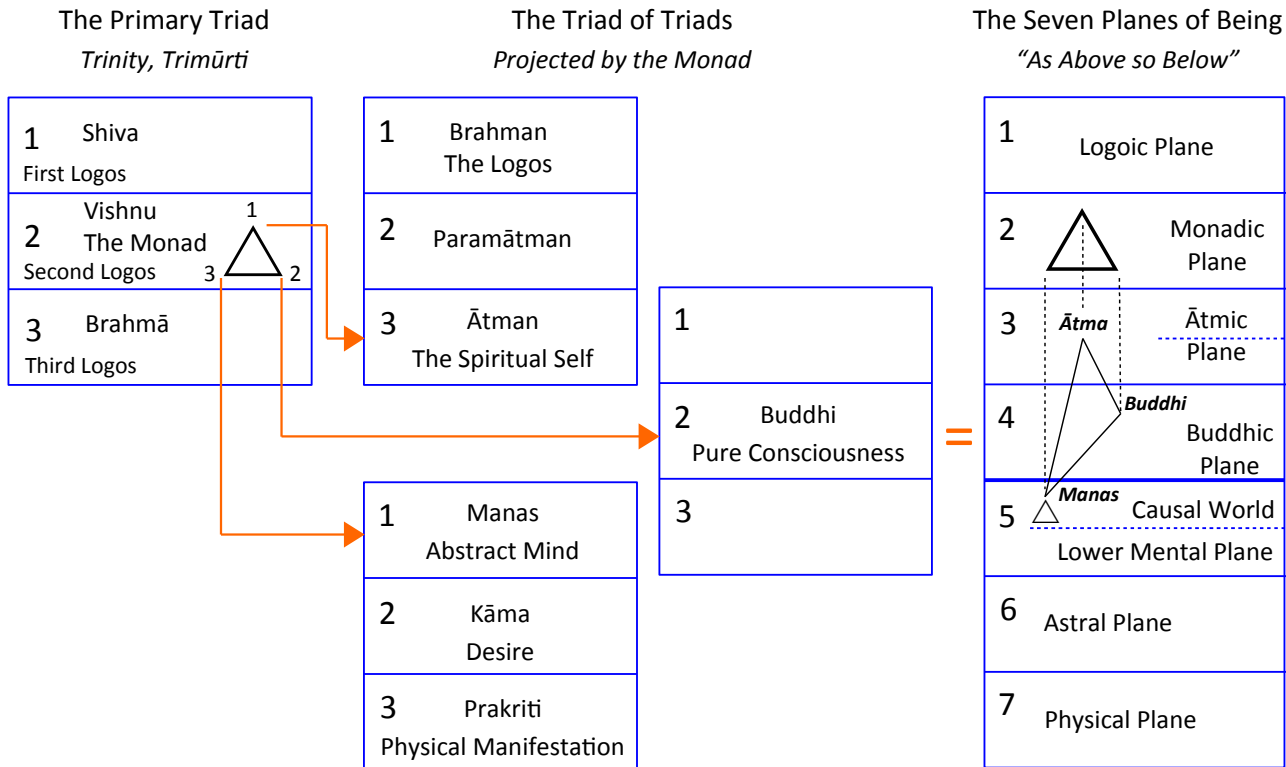

Figure 13: Generation of the Planes of Being

Here, in a nutshell, is the reason why there are seven Planes of Being and why there cannot be more or less. Quite simply, the Planes of Being are constituted from an overlapping Triad of Triads (*overlapping* in the sense that the lowest plane of a higher Triad coincides with the highest plane of the Triad below). This threefold inner structure of the Planes of Being is often missed by esoteric students but is vitally important for an understanding of the whole.

Note that Ātma (Ātman) is a reflection in lower dimensions of the First Logos; Buddhi is a reflection of the Second Logos; and Manas is a reflection of the Third Logos. These three principles, *Ātma-Buddhi-Manas*, known as the *Spiritual Triad*, constitute the inner nature of the human being, being reflections of cosmic (divine) attributes. As Above so Below.

From a technical perspective this understanding of the logical structure of the Planes of Being is key to an understanding of the Foundations of Physics, being the origin of time, energy and so on, as we will now explain.

### 11. The Third Logos and the 5-Space

- The First Logos (Spirit) remains always outside of objective manifestation.
- The Third Logos enters into objective manifestation and is in fact the energy, substance and motivating force underpinning all phenomena in the Three Worlds (Matter).
- The Second Logos is suspended between Spirit and Matter and is the Crucible of Consciousness.

It follows that investigations into the Foundations of Physics should focus on the nature of the Third Logos. As physicists we are not directly concerned with the First Logos, while the Second Logos we only need touch upon as the precursor or basis for the Three Worlds. To understand manifestation we must understand the Third Logos, what it is and how it operates. And here esoteric philosophy comes to our aid once more.

Notice there is a division between higher (abstract) and lower (objective) levels of the 5-space (Mental Plane), since the Second and Third Logoi are both present on that plane. The higher (abstract) levels are known as the *Causal World*, since herein lies the incipient cause of all objective manifestation. The Third Logos anchors herself in the Causal World and manifests objective Creation from there. But there is a twist: the Third Logos manifests on the abstract levels of the 5-space not as a singular entity but, you guessed it, as a Triad, as illustrated in Figure 14. So this is the third turn of the wheel [17]:

1. The Primary Triad.
2. The Triad of Triads.
3. The threefold manifestation of the Third Logos in the 5-space (Mental Plane).

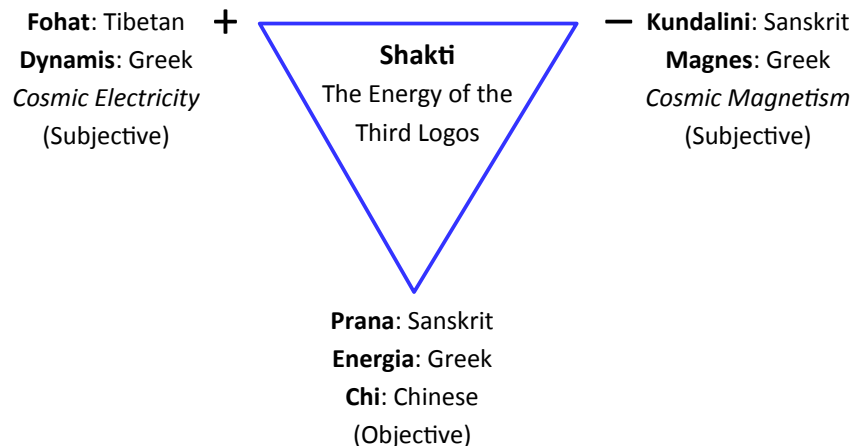

Figure 14: Descent of the Third Logos

[According to this model the 7-space (Ātmic or Nirvāṇic Plane) is divided as well, though this writer has never seen such a division mentioned in the literature. The reason is clear: the Adepts speak of “touching upon” Nirvāṇa and “entering into” Nirvāṇa, the difference being that “entering into” means you cross that divide and may not return to talk about it. “Enoch walked with God and he was not” (Genesis 5: 24).]

Kundalini, Fohat and Prana are collectively known as Third Logos Fire, with *fire* translating most directly as *energy* along with the attribute of *consciousness*. Kundalini and Fohat are both considered subjective – they are energies operating within consciousness itself – while Prana is an objective energy, meaning it can directly influence (and in fact becomes) objective matter.

The Third Logos Fire is known as *Pneuma-Hagion* in Greek, *Ruah-Ha-Qadosh* in Hebrew and *Spiritus Sanctus* in Latin, all meaning “Holy Spirit”. She has often been described in terms of a breath or a wind. In the Roman Mystery Schools she was known simply as *Motion*. For indeed, Kundalini and Fohat, manifesting as the  $w$  and  $v$  dimensions, are in subjective (imaginary) motion, which reduces to a movement of abstract consciousness. According to the logic, the Third Logos is “thinking” manifestation into existence.

Figure 15 represents schematically the engine room of manifestation, the very point where time and objectivity spring into existence. It also represents the convergence of our two lines of thought: in Part 1 we arrived at such a 5-space from the bottom up (that is, working from lower dimensions); here we arrive back at the same place working from the top down (from higher dimensions), while adding a bit more detail.

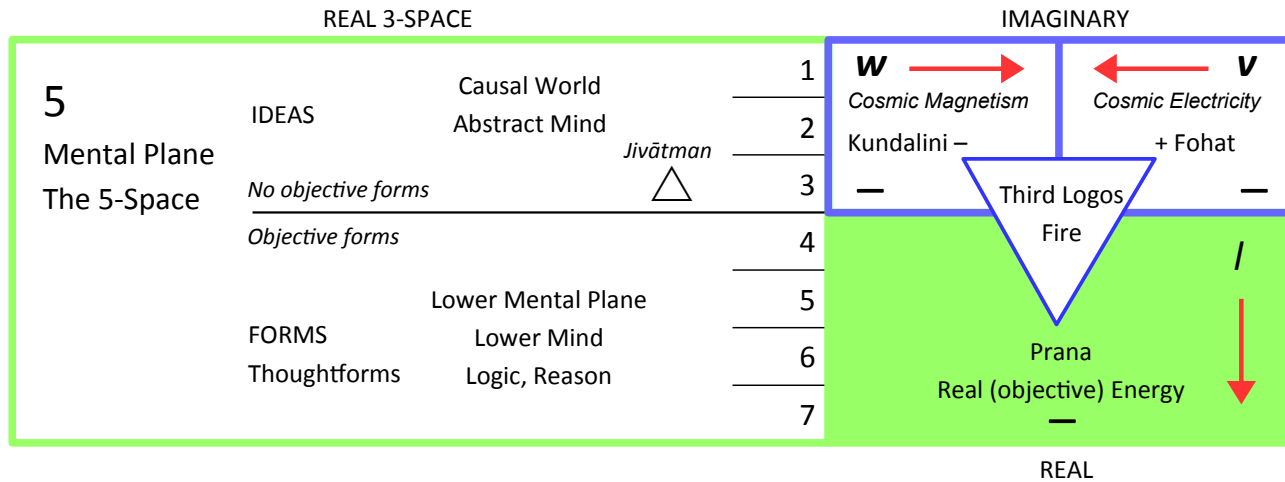

Figure 15: From Subjective to Objective

According to the Adepts each plane includes seven *subplanes*, much like a musical octave though perhaps better understood scientifically as *phases*. The three higher subplanes of the Mental Plane comprise the *Causal World*, which is considered formless and is the realm of the Abstract Mind (relating to genius or insight). *Jivātman*, the “living Self” or “living Soul”, embodies the Spiritual Triad, *Ātma-Buddhi-Manas*, on the third subplane. This is the human Soul, what Theosophists call the Reincarnating Ego, your sense of self which persists and evolves through life after life in the Three Worlds.

The Causal World is Plato’s realm of transcendental Ideas, while the lower Mental Plane is his world of Forms (thoughtforms). For indeed our thoughts exist objectively in this subtle space. Plato was an Initiate of the Greek Mystery School and clearly understood the 5-space from his own inner experience.

In the Causal World the  $w$  and  $v$  dimensions (Kundalini and Fohat) are “naked”, in their bare imaginary state, while on the lower Mental Plane they combine (mathematically as a cross product) to generate the (negative)

real dimension  $l$  (Prana). Since the  $w$  and  $v$  dimensions are in motion (that is, energetic), so the  $l$  dimension is energetic as well, but *real*. Moreover, because the fourth dimension  $l$  is orthogonal to the first three real dimensions this real energy (Prana) spontaneously manifests as an energized field throughout real 3-space.

Here we come full circle to Kaluza's Einstein-Maxwell theory, which sees an electromagnetic field generated in real 3-space as a result of the presence of the fourth real dimension. It follows that Kaluza's theory applies specifically to the lower Mental Plane. Nevertheless, proper application of the theory will likely require the  $w$  and  $v$  dimensions to be detailed in the metric.

Keep in mind that Figure 15 can be interpreted on both a cosmic level and a human level (as can the Planes of Being generally). As a cosmic picture it shows how the Third Logos manifests the Mental Plane along with the eternal Ideas and Forms within it. On a human level it shows your own Mental World. It is an esoteric maxim that *energy follows thought*: whenever we think a thought we are accessing or activating the dimension  $v$ , hence  $l$ , generating Prana which projects itself into the 3-space and molds the electromagnetic field into an objective thoughtform on the lower Mental Plane. While your thoughtforms appear around you on the Mental Plane, they are no distance from you, since they all exist on your null surface according to the Euclidean metric for Minkowski 5-space [18].

In the Causal World the imaginary dimensions  $w$  and  $v$  cannot in principle motivate the real electromagnetic field in the 3-space, simply because imaginary energies cannot directly influence real fields. This is why the Adepts speak of the Causal World as having the likeness of "semi-light, semi-matter"; abstract (imaginary) consciousness projected into real 3-space remains as ephemeral Ideas, subjectively present in space but objectively not. Nonetheless, being outside of any material representation the Ideas are of a perfection unattainable in the material realm. To cross this divide and apprehend these Ideas in the lower mind is thus the mark of genius and spiritual insight, the bridge being known in Sanskrit as *Antahkarana*, "inner cause".

## 12. Space and the Kabbalistic Tree of Life

While the Rishis of the East looked upon the Cosmos in terms of seven Planes of Being (*loka*), the Western Adepts of ancient Egypt, Chaldea and Israel employed a rather more sophisticated representation of Reality. The central glyph of Kabbalah is known as the *Tree of Life*, being an arrangement of centers known as *Sephiroth* (Splendours) along with connecting paths. Figure 16 correlates the Tree of Life with the Planes of Being [19] while indicating the spatial configurations for each plane according to the current framework. Much is hidden in these correlations, so we will begin with the Physical Plane (our 3+1 spacetime) and work up.

### Physical Plane (3-space, 4 imaginary)

The Physical Plane is called *Malkuth*, the Kingdom, in Hebrew. As explained in Part 1 our physical 3-space is projected from four imaginary dimensions. Since real 3-space is considered "objective" space, containing corporeal "objects" as we understand them (meaning 3-dimensional), the Kingdom is thus the final consummation of objectivity, the end result of a grand cosmic scheme originating out of bare subjectivity.

### Astral Plane (4-space, 5 imaginary)

The Astral Plane is called *Yesod*, the Foundation, since it quite literally is the foundation of our physical universe. Here again we have a real (objective) 3-space, as we know exists in our dreams. The presence of the fourth dimension  $w$ , however, dramatically changes the "physics" of this world.

The key is that the imaginary dimension  $w$  in the 4-space is *your subconscious mind*. It is your emotional-psyche-desire nature and it holds all your memories. In esoterics it is often called the *female mind* or *inner mind*. While awake in this world it is beneath the surface of our conscious awareness, but not so in our dreams.

# The Logic of Imaginary Time and Space

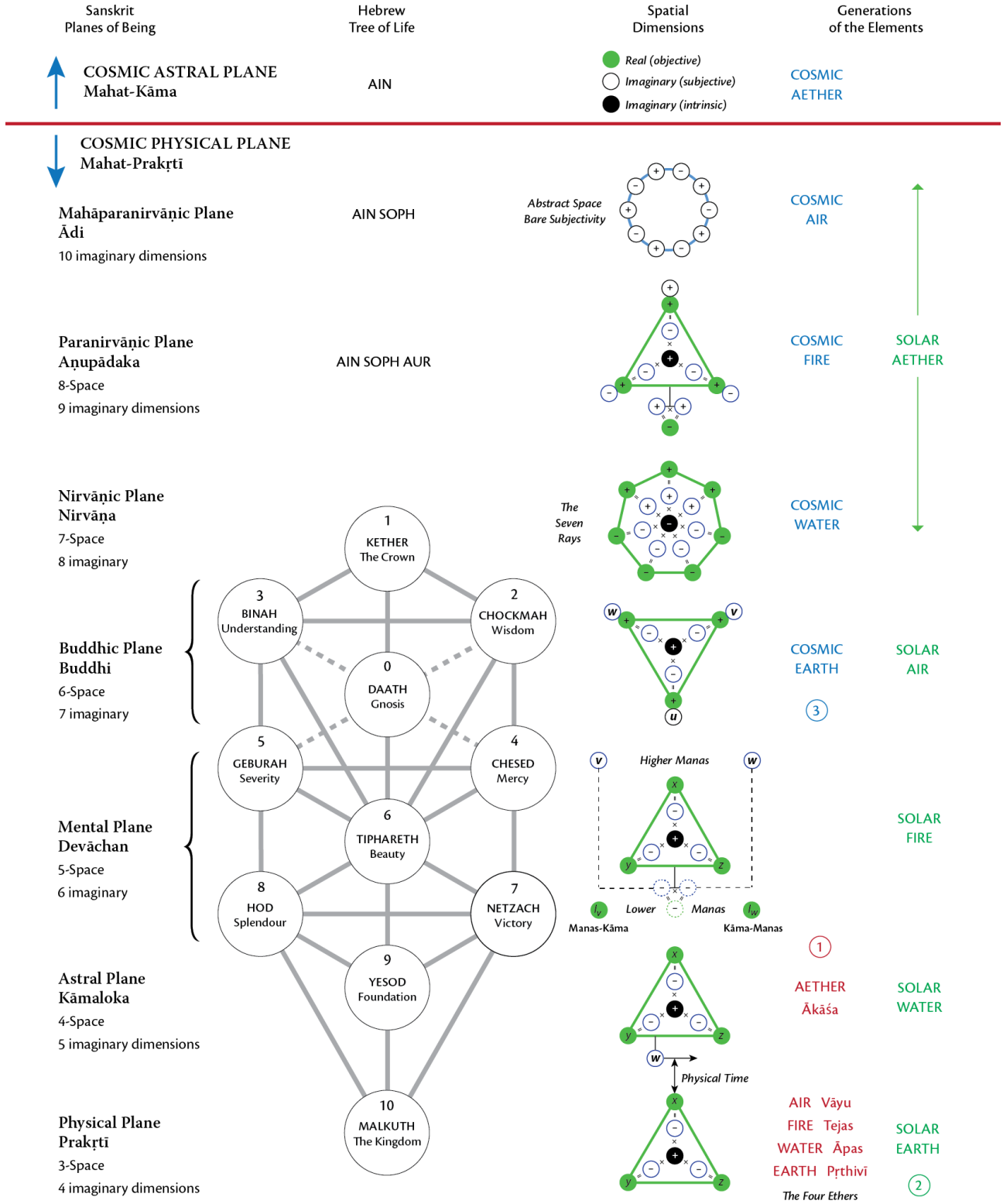

Figure 16: Spatial Convergence of Physics and Esoterics

In the Astral World the psychic current  $w$  is continually flowing relative to real space and cannot be stopped, explaining why in dreams even the environment is in a continual state of flux. Moreover, recall that time  $t_4$  in the 4-space is imaginary, with the following direct consequences:

- a. In our dreams we move through real space in imaginary time, so our motion (velocity) is *imaginary* ( $dx/dt_4$ ), meaning *subjective*. Moreover, according to the spatial metric for Minkowski 4-space, displacements within the null cone are imaginary ( $s^2$  is negative). That is, we don't move around with our legs but with our mind.
- b. Since the imaginary dimension  $w$  is moving in imaginary time  $t_4$ , the resulting motion and energy are real, projecting a *real* field into the 3-space similar to the electromagnetic field on the Mental Plane. This field is known as the *Astral Light*, an energetic, “plastic” light-substance that can assume any form in response to mind. Analogously, your own  $w$  dimension – your subconscious mind – is an imaginary dimension moving in imaginary time ( $dw/dt_4$ ); hence the motion and energy are real, with the result that (given sufficient energy on your part) your subjective state excites the Astral Light, thereby manifesting itself as objective forms and phenomena in real 3-space around you.

Motion in dreams can be further understood when one considers that displacements in Minkowski 4-space can be reduced to zero by suitable displacements on the  $w$  dimension – that is, by suitable feelings, desire or movement of the subconscious mind. Conversely, if feelings become frozen (as in a terrifying nightmare) one may not be able to move at all.

### **Mental Plane** (5-space, 6 imaginary)

The Mental Plane is the engine room of the objective Universe, the bridge between subjective and objective reality, and hence is the most complex of all the planes. A total of five Sephiroth depict the Mental Plane on the Tree of Life, representing five types, qualities or attributes of consciousness.

The Mental Plane includes a real 3-space – so it is indeed an objective world – in addition to the imaginary dimensions  $w$  and  $v$ , which combine to project the fourth real dimension  $l$ . Note that while the  $w$  and  $v$  dimensions are both negative (feminine), they (Kundalini and Fohat) are polarized relative to each other.

*Tiphareth*, Beauty, corresponds to the Sanskrit *Jivātman*, the “living Soul”. This is our sense of “I am”, the Watcher, the inner Observer of all conscious experience in the Three Worlds. On the Mental Plane our subjective state is projected onto a null surface with *Jivātman*, the Observer (You), at the origin, so our objective and subjective experience correlate [20].

*Hod* and *Netzach* correspond to the lower (rational) mind. While  $l$  is a singular dimension, the  $w$  and  $v$  dimensions are each contained within it, so the Kabbalists make the distinction that in *Hod* the  $v$  dimension dominates, while in *Netzach* the  $w$  dimension dominates. In Sanskrit these aspects of the lower mind are delineated in terms of *Kāma-Manas* (desire-mind) and *Manas-Kāma* (mind-desire).

*Geburah* and *Chesed* refer to the Abstract or Causal Mind, with *Geburah* reflecting the  $v$  dimension and *Chesed* the  $w$  dimension.

### **Buddhic Plane** (6-space, 7 imaginary)

The Buddhic Plane correlates with three Sephiroth on the Tree of Life – *Daath* (Gnosis), *Binah* and *Chockmah*, corresponding directly to the three complex dimensions of the 6-space. Being constituted as a complex 3-space there is no objective space in the Buddhic Plane and therefore no objective experience. It is experienced as Pure Consciousness, formless and timeless, which explains why the genuine mystics are at a loss for words and so poorly understood – one only has to imagine what the experience of a complex 3-space with no time dimension would be like.



Logically the  $u$  dimension correlates with the Gnosis centre. The Greek word *gnosis* means “knowledge”, but not in the ordinary mental or outer sense. It means direct inner knowledge. Consider that the  $u$  dimension, while itself static, is the precursor to time in the Three Worlds, so the Three Worlds pass over the  $u$  dimension with the passage of time. Therefore, the entire history of the Three Worlds, since the beginning of time, is written into the  $u$  dimension. This is indeed the genuine “Akashic Records”. While there is a lesser akashic record written into the  $w$  dimension on the Astral Plane, the Adepts tell us that the true and complete Akashic Records are found on the Buddhic Plane, in conformance with this framework [21].

### **Nirvāṇic (Ātmic) Plane** (7-space, 8 imaginary)

The Nirvāṇic plane is represented on the Tree of Life by *Kether*, the Crown. Here we have passed out of physics so we have only the advice of the Adepts along with logic and symmetry to guide us.

The most symmetrical configuration of eight imaginary dimensions is a real 7-space. Notice that the intrinsic dimension is negative rather than positive as on the other planes – a curious twist required to yield three positive real dimensions and four negative. These seven dimensions thus correspond to the *Seven Rays*, known esoterically as seven distinct rays of energy or consciousness, or the “Sevenfold Holy Spirit” [22]. The first three Rays are considered major Rays; the remaining four are the minor Rays.

The reader may understandably object that such a subtle, abstract space could be made up of real dimensions. There is only one other plane wherein space is entirely real, that being our physical universe. So consider the following advice from a contemporary esoteric Adept [23]:

From a certain point of view we can speak of two “Realities”: the plane of the physical universe and the plane of Nirvāṇa ... Both the physical universe and the plane of Nirvāṇa are *real*. One has a feeling of “reality” as one experiences them ... Between these two “real” universes are the illusory worlds; the various realms of the Astral Plane (the realms of the dead) and the Mental Plane (the heaven worlds) are “unreal” worlds. We say this only from a certain perspective. Understand it as such.

It follows that those planes which mix real and imaginary dimensions are “illusory”, mixing objective and subjective experience – meaning that when an object appears in your environment you might consider it “objectively real” when in fact you created it yourself, as is certainly the case on the Astral and Mental Planes.

The Nirvāṇic Plane is experienced as “real” not just because it includes just real dimensions – keep in mind that there are seven of them! Moreover, recall that this is where the Third Logos first establishes herself in Creation in her full higher-dimensional Glory. Put these facts together and we may begin to understand why the Kabbalists call Kether the *White Brilliance* and the *Supreme Crown*.

### **Monadic Plane** (8-space, 9 imaginary)

The Monadic Plane is represented in Kabbalah by the first great Realm above the Tree of Life, known as *Ain Soph Aur*, “Limitless Light”. Since there is no truly symmetrical configuration of nine imaginary dimensions we look for other clues.

Recall that the Third Logos Fire appears in the 5-space (Mental Plane) as a Triad functioning within a real 3-space. On the Monadic Plane we see the same pattern on a higher octave: the Monad appears on the Monadic Plane as a Triad within a *complex* 3-space. With the exception of certain polarities the spatial configurations are otherwise identical. In particular, the real 3-space hidden within the complex 3-space is identical to our real 3-space – in fact one could consider it the germinal prototype of our real 3-space.

This correlation between the Monadic and Mental Planes finds further support in an esoteric understanding of the *Classical Elements*, while introducing a further layer of structure to the esoteric model. To the right of Figure

16 three generations of the Elements are indicated, being the same cosmic principles repeating themselves on different levels according to a similar pattern. In each case the first Element, *Aether* or *Akasha* (*Quintessence* in Latin), is of a higher order while providing a context for the remaining four Elements. For present purposes it is sufficient to note that the Monadic Plane corresponds to *Cosmic Fire*, while the Mental Plane corresponds to *Solar Fire* (please note this has nothing to do with the physical Sun!). That is, the Monadic and Mental Planes are expressions of the same Element, representing a similar process on different levels or octaves.

The Elements turn out to play an important role in *quantum measurement* and the various *quantum fields* in Nature, while revealing fascinating correlations with String Theory [24]. Wheels within wheels indeed.

### **Logoic Plane** (10 imaginary dimensions)

The Logoic Plane corresponds to the second great Realm above the Tree of life, what the Kabbalists called *Ain Soph*, “the Boundless”. Here we return to the beginning, to “bare subjectivity”, ten naked imaginary dimensions, five positive (male) and five negative (female), held in perfect balance. Thus does the First Logos remain outside of Manifestation.

In esoteric philosophy the number 10 is known as the *Sign of Man*, or of the perfected human being. While various explanations have been offered [25], keep in mind that imaginary dimensions are fundamentally subjective principles, particular types, qualities or powers of consciousness (qualia). These operate on both a cosmic level and a human level. In terms of our inner consciousness, human beings are made up of ten imaginary dimensions, just as the Cosmos is made up of ten imaginary dimensions, so the awakening of those dimensions within our consciousness will indeed lead us to perfection.

In addition to being subjective principles the imaginary dimensions also have a spatial, geometric aspect. This is the mystery, the profound mechanism at the heart of Nature forming the bridge between subjective and objective experience. Space (consciousness) comes first. Matter is *utilized* by consciousness. In the words of the Tibetan Adept Djwal Khul [26]:

Space is included in the idea of consciousness, and its utilization of matter.

The total of 10 spatial dimensions has significant technical relevance as well. First of all, M-Theory requires 10 spatial dimensions. Furthermore, the many varieties of *charge* can be unified under the  $SO(10)$  symmetry group, yielding what Frank Wilczek calls the “charge account” [27]. But that’s another story.

### 13. Conclusion

We began our journey by looking squarely at demonstrated quantum phenomena, thus deriving a higher-dimensional space-time model supporting non-locality and retro-causality, while elucidating time, the Wick rotation and the origins of mass. Special Relativity is extended into the higher dimensions and a spatial context is provided for the internal symmetries of the Standard Model. We then derived the esoteric cosmological model from first principles while demonstrating that the two models are compatible, with each informing the other. We have, then, a logical conjoining of two of the greatest of all human endeavors: the physical and esoteric sciences. Profound if true.

As the title suggests, the framework endeavors to provide a rigorous logical structure built on the minimum of premises and demonstrated facts. It is hoped that this bare logical structure will be examined and enriched by those equipped to put mathematical flesh on its bones.

Imaginary dimensions are a new paradigm indeed, and like all new paradigms they take some getting used to. But consider that your entire subjective life is happening in imaginary dimensions, so they are nothing to be wary of, while being everything to celebrate and marvel at. In order to become familiar with imaginary dimensions, study your dreams and watch the metric at work in the 4-space, along with the duality of space and consciousness. In this field you are your own laboratory. Nature is richer and deeper than we (scientists) have realized. The fact that imaginary dimensions precede real dimensions simply means that consciousness precedes matter, and that is something this writer, for one, finds comforting.

Notes and References

1. Pusey et al. (2012).
2. Leifer (2014) presents a review of psi-ontology theorems.
3. Piacentini et al. (2017). Gao (2016) argues for psi-ontology on the basis of protective measurements..
4. See for instance Giustina et al. (2015) and Hensen et al. (2015). See Maudlin (2014) for a lucid presentation of the context and the consequences.
5. Megidish et al. (2011).
6. Jacques et al. (2006).
7. Cramer (1986)
8. Aharonov and Laidman (2007) provide a review of the TSVF.
9. Aharonov and Laidman (2007).
10. Penrose (2004), p. 509.
11. Most contributors to Ney and Albert (2013) argue that the wave function lives in 3N dimensions.
12. Maudlin (2011), pp. 21-23.
13. Maudlin (2011), pp. 180-184.
14. See for instance Wesson (2006). Literature at the Space-Time-Matter website: <http://5dstm.org>
15. See Vallyon (2007) vol. 1 and Bailey (1925) p. 117.
16. Blavatsky (1888), p. 14.
17. Vallyon (2007), p. 137.
18. See Carter (2013) for more details regarding perception in the 5-space.
19. See Vallyon (2007), p. 359.
20. See Carter (2013) for details regarding our conscious experience and the null surface in the 5-space.
21. Vallyon (2007), p. 241.
22. Vallyon (2007), p. 54.
23. Vallyon (2007), p. 97.
24. Carter (2012) explores quantum measurement and fields in the context of the current framework.
25. Bailey (1925), p. 4.
26. Bailey (1925), p. 281.
27. Wilczek, Frank (2008). p. 172. See Carter (2012) for more on charge and other quantum observables.

## Bibliography

- Aharonov, Yakir; Vaidman, Lev (2007). *The Two-State Vector Formalism: an Updated Review*. arXiv:quant-ph/0105101.
- Bailey, A.A. (1925). *A Treatise on Cosmic Fire*. Lucis Publishing Company, New York.
- Blavatsky HP. (1888). *The Secret Doctrine*, Volumes 1 & 2. Theosophical University Press, Pasadena CA.
- Carter, Philip J. (2012) *Imaginary Physics*. <http://vixra.org/abs/1210.0124>
- Carter, Philip J. (2013). *Quantum Spacetime and Consciousness*. <http://vixra.org/abs/1312.0208>
- Cramer, John G. (1986). *The transactional interpretation of quantum mechanics*. Reviews of Modern Physics, Vol. 58, No. 3, July 1986. The American Physical Society.
- Gao, Shan (2016). *Meaning of the wave function: In search of the ontology of quantum mechanics*. arXiv:1611.02738.
- Giustina, Marissa, et al. (2015). *Significant-loophole-free test of Bell's theorem with entangled photons*. arXiv:1511.03190.
- Hensen, B, et al. (2015). *Experimental loophole-free violation of a Bell inequality using entangled electron spins separated by 1.3 km*. arXiv:1508.05949.
- Jacques, V, et al. (2006). *Experimental realization of Wheeler's delayed-choice GedankenExperiment*. arXiv:quant-ph/0610241.
- Leifer, Matthew Saul (2014). *Is the Quantum State Real? An Extended Review of  $\Psi$ -ontology Theorems*. arXiv:1409.1570.
- Maudlin, Tim (2011). *Quantum non-locality and Relativity: Metaphysical Intimations of Modern Physics*. Wiley-Blackwell, West Sussex, UK.
- Maudlin, Tim (2014). *What Bell Did*. arXiv:1408.1826
- Megidish, E, et al. (2011). *Entanglement Between Photons that have Never Coexisted*. arXiv:1209.4191
- Ney, Alyssa; Albert, David Z (2013). *The wave function: Essays on the Metaphysics of Quantum Mechanics*. Oxford University Press.
- Penrose, Roger (2004). *The Road to Reality: A Complete Guide to the Laws of the Universe*. Jonathan Cape, London.
- Piacentini, F, et al. (2017). *Determining the Quantum Expectation Value by Measuring a Single Photon*. arXiv:1706.08918
- Pusey, Matthew F.; Barret, Jonathan; Rudolph, Terry (2012). *On the reality of the quantum state*. arXiv:1111.3328
- Vallyon, I. (2007). *Heavens and Hells of the Mind* (Volumes 1-4). Sounding-Light Publishing, Hamilton NZ.
- Wesson, Paul (2006). *Five-Dimensional Physics: Classical and Quantum Consequences of Kaluza-Klein Cosmology*. World Scientific Publishing Co.
- Wilczek, Frank (2008). *The Lightness of Being: mass, ether, and the unification of forces*. Basic Books, Philadelphia.