

What is Fundamental ? NOTHING is Fundamental !!!

Frank Dodd (Tony) Smith, Jr. - 2017

Fundamental = Starting Point of a Process Describing Realistic Physics
including **Lagrangian** and **Algebraic Quantum Field Theory (AQFT)**.
The Starting Point of Our Universe was a Fundamental Spinor Void
Void = NOTHING so NOTHING is Fundamental

This paper explores the Process,
which allows calculation of Standard Model Particle Masses and Force Strengths.

Page 2 is a Graphic Overview.

Pages 3-13 **What is Fundamental? NOTHING is Fundamental !!!**

Pages 14-64 are my 2018-2019 Calendar with Physics Graphics.

Pages 65-68 are about Leonardo DaVinci's Salvator Mundi and E8.

Void \rightarrow C(Void) \rightarrow C(0) \rightarrow C(1) \rightarrow C(2) \rightarrow C(4) \rightarrow C(16)

Kaluza-Klein Spacetime M4 x CP2	
C(8) that contains 28 = D4 for CP2	1, 16, 120, 560, 1820, 4368, 8008, 11440, 12870, 11440, 8008, 4368, 1820, 560, 120, 16, 1
C(8) that contains 28 = D4 for M4 Gravity	1, 8, 28, 56, 70, 56, 28, 8, 1

$C(8) \times C(8) = C(16)$
 Spinors: $(8s, 8s) + (8s, 8c)$
 $(8s+8c) \times (8s+8c) = (8c, 8s) + (8c, 8c)$

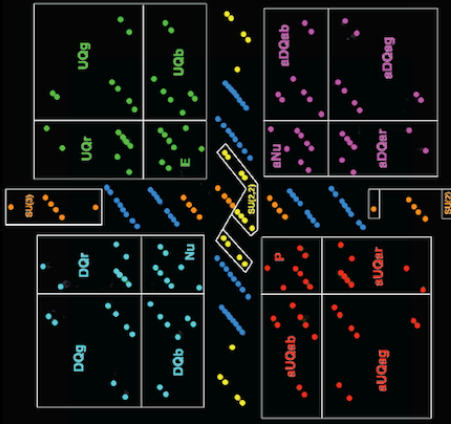

$C(0, 16) \times C(0, 8) = C(0, 24)$
 $M(2, C(0, 24)) = C(1, 25)$

Completion of Union of All Tensor Products of C(1,25) = AQFT

Quantum Resonant Connection

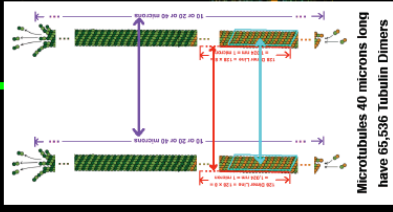

10¹⁹ E8 Lattice 240-vertex Polytope Cells in Universe at End of Inflation

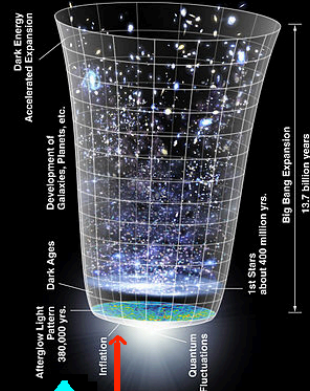

NuL Quantum Condensate

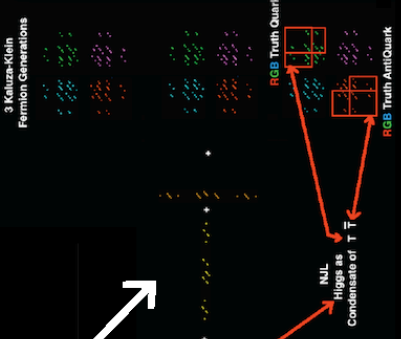
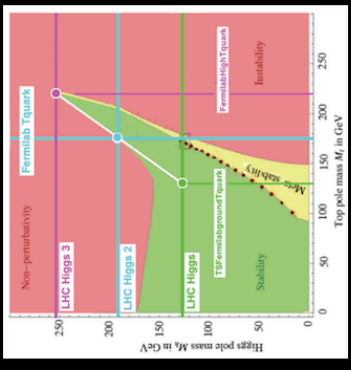

Penrose-Hameroff Quantum Condensate

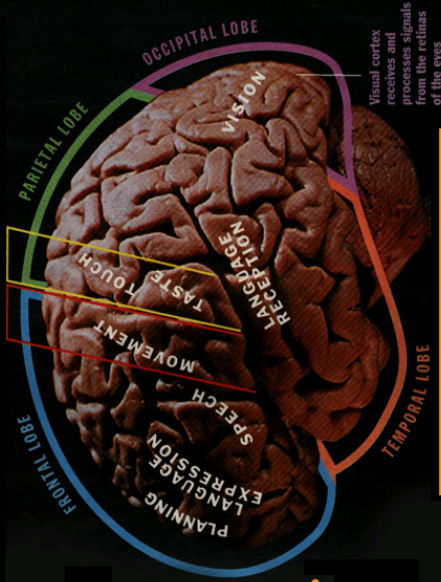

10¹⁹ Tubulin Dimers in a Human Brain

What is Fundamental ? NOTHING

Frank Dodd (Tony) Smith, Jr. - 2017

Fundamental = Starting Point of a Process Describing Realistic Physics

including Lagrangian and Algebraic Quantum Field Theory (AQFT).

This paper explores the Process through detailed worked examples.

(for further details and calculations see Smith references)

The Starting Point of Our Universe was a Fundamental Spinor Void

Void = NOTHING so NOTHING is Fundamental

Fundamental Spinor Void based on 0-dim Real Clifford Algebra Cl(Void)

from which emerged by Finkelstein's process of Iterating Clifford Algebra Formation

(Finkelstein, Int. J. Theor. Phys. 2017 56 : 2-39)

$$\text{Cl}(0) = 2^0 = 1\text{-dim}$$

$$\text{Cl}(1) = 2^1 = 2\text{-dim}$$

$$\text{Cl}(2) = 2^2 = 4\text{-dim with } 2^1 = 1+1 \text{ half-spinor fermions/antifermions}$$



and

$$\text{Cl}(4) = 2^4 = 16\text{-dim with } 2^2 = 2+2 \text{ half-spinor fermions/antifermions}$$



and

$$\text{Cl}(16) = 2^{16} = 65,536\text{-dim with } 2^8 = 128 + 128 \text{ half-spinor fermions/antifermions}$$

128-dim Cl(16) Half-Spinors = 2 copies of Geoffrey Dixon's 64-dim $RxCxHxO$

where R = Real, C = Complex, H = Quaternion, O = Octonion Division Algebras

(Dixon, Division Algebras (O, H, C, and R) and Windmill Tilting)

248-dim E8 = 128-dim Cl(16) Half-Spinors + 120-dim Cl(16) BiVectors

By 8-Periodicity of Real Clifford Algebras

$$\text{Cl}(8) \times \dots (\text{N times tensor product}) \dots \times \text{Cl}(8) = \text{Cl}(8N)$$

$$\text{Cl}(16) \text{ can be factored into the tensor product } \text{Cl}(8) \times \text{Cl}(8)$$

Each of the $\text{Cl}(8) = 2^8 = 256\text{-dim with } 2^4 = 8+8 \text{ Cl}(8) \text{ half-spinor fermions/antifermions}$



and



By Triality half-spinors (8 fermions and 8 antifermions) are isomorphic to each other and to 8 vectors

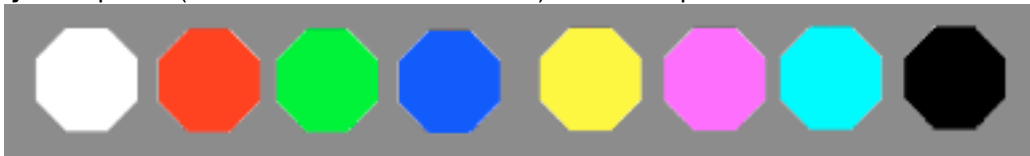

By 8-Periodicity Cl(8) and Cl(16) have basic structure underlying all Real Clifford Algebras.

The Iterated Clifford Algebra Creation Sequence begins with a Compact Quantum Fluctuation in a Parent Universe (Real Form E8(-248)) that Unfolds into an Octonionic Inflation of Our Universe (Real Form E8(8))

(Smith, viXra 1709.0265)

The Creation Sequence can also be seen in terms of Spinor/Clifford Algebra Doubling

$$\text{Cl}(0,0) \rightarrow \text{Cl}(0,2) \rightarrow \text{Cl}(0,4) \rightarrow \text{Cl}(0,6) \rightarrow \text{Cl}(0,8) \rightarrow$$

that goes to $\text{Cl}(0,8)$ which has Vector - Half-Spinor Triality and by 8-Periodicity is the Basic Building Block of Real Clifford Algebras. The Creation Sequence continues by Tensor Product

$$\rightarrow \text{Cl}(0,8) \times \text{Cl}(0,8) = \text{Cl}(0,16) \rightarrow \text{Cl}(0,16) \times \text{Cl}(0,8) = \text{Cl}(0,24) \rightarrow$$

$\text{Cl}(0,16)$ contains the Maximal Exceptional E8 Lie Algebra

$\text{Cl}(0,24)$ contains the Vector Space of the 24-dim Leech Lattice Λ_{24} that is composed of 3 copies of E8 Lattices (2 being Integral Domains and 1 not Algebraically closed)

The Creation Sequence continues by constructing the Conformal Structure of 2x2 matrices with entries in $\text{Cl}(0,24) = M(2, \text{Cl}(0,24))$

(Porteous, Clifford Algebras and the Classical Groups and Lounesto and Porteous, Lectures on Clifford (Geometric) Algebras and Applications)

$$\rightarrow M(2, \text{Cl}(0,24)) = \text{Cl}(1,25) \rightarrow$$

Since all the matrix entries are $\text{Cl}(0,24) =$ tensor product of 3 copies of $\text{Cl}(0,8)$ 8-Periodicity allows formation of the tensor products of copies of $\text{Cl}(1,25)$

\rightarrow Completion of Union of All Tensor Products of $\text{Cl}(1,25) =$ hyperfinite AQFT

The hyperfinite AQFT has Real / Octonionic structure inherited from $\text{Cl}(0,8)$ and it also has Quaternionic structure due to

$\text{Cl}(1,25) = \text{Cl}(1,9) \times \text{Cl}(0,8) \times \text{Cl}(0,8)$ and $\text{Cl}(1,9) = \text{Cl}(1,5) \times \text{Cl}(0,4) = \text{Cl}(2,4) \times \text{Cl}(0,4)$ where

the vector space of $\text{Cl}(2,4)$ is 6-dim Conformal Spacetime which contains 4-dim Minkowski Spacetime M_4 of $\text{Cl}(1,3)$ and

the vector space of $\text{Cl}(0,4)$ corresponds to $\text{CP}^2 = \text{SU}(3) / \text{SU}(2) \times \text{U}(1)$

so that **before breaking Octonionic symmetry non-unitarity of Octonion Quantum Processes allows particle creation during the Inflation Era**

(Adler, Quaternionic Quantum Mechanics and Quantum Fields, pages 50-52, 561)

and **after breaking non-unitary Octonionic 8-dim Spacetime**

to unitary Quaternionic Spacetime, thus ending the Inflation Era,

the Spacetime of the hyperfinite AQFT is (4+4)-dim $M_4 \times \text{CP}^2$ Kaluza-Klein (Real Form E8(-24))

**The E8 contained in Cl(0,16) is not a conventional Gauge Group
but
is a Recipe for a Realistic Physics Lagrangian:**

Fermion Terms:

E8 / D8 = 128-dim = 8-dim Spacetime Components of 8 Fermion Particles
+
8-dim Spacetime Components of 8 Fermion AntiParticles

Spacetime Base Manifold Terms:

D8 / D4 x D4 = 64-dim = 8-dim Spacetime Position x 8-dim Spacetime Momentum

Gauge Boson and Ghost Terms:

The two 28-dim D4 correspond to the M4 and CP2 of M4 x CP2 Kaluza-Klein

D4_M4 = 16-dim U(2,2) containing SU(2,2) = Spin(2,4) Conformal Gravity
and 12 Standard Model Ghosts

D4_CP2 = 8-dim SU(3) Color Force plus 4 Translation Gravity Ghosts
and 12 Conformal Gravity Ghosts

Electroweak SU(2) x U(1) come from Little Group of CP2 = SU(3) / SU(2) x U(1)
(Batakis, Class. Quantum Grav.3 (1986) L99-L105)

This E8 Structure can be seen in terms of its 240 Root Vectors

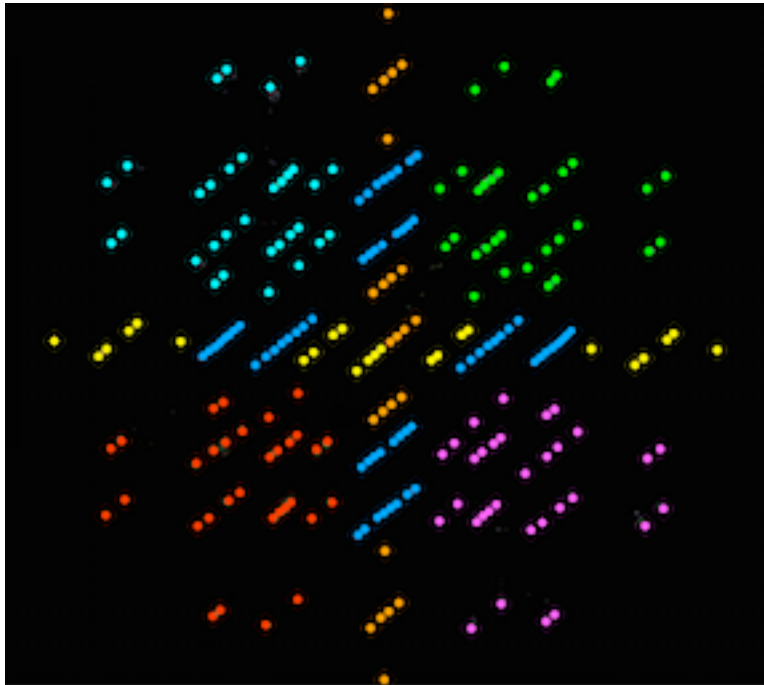

each of which has a realistic Physics Interpretation:

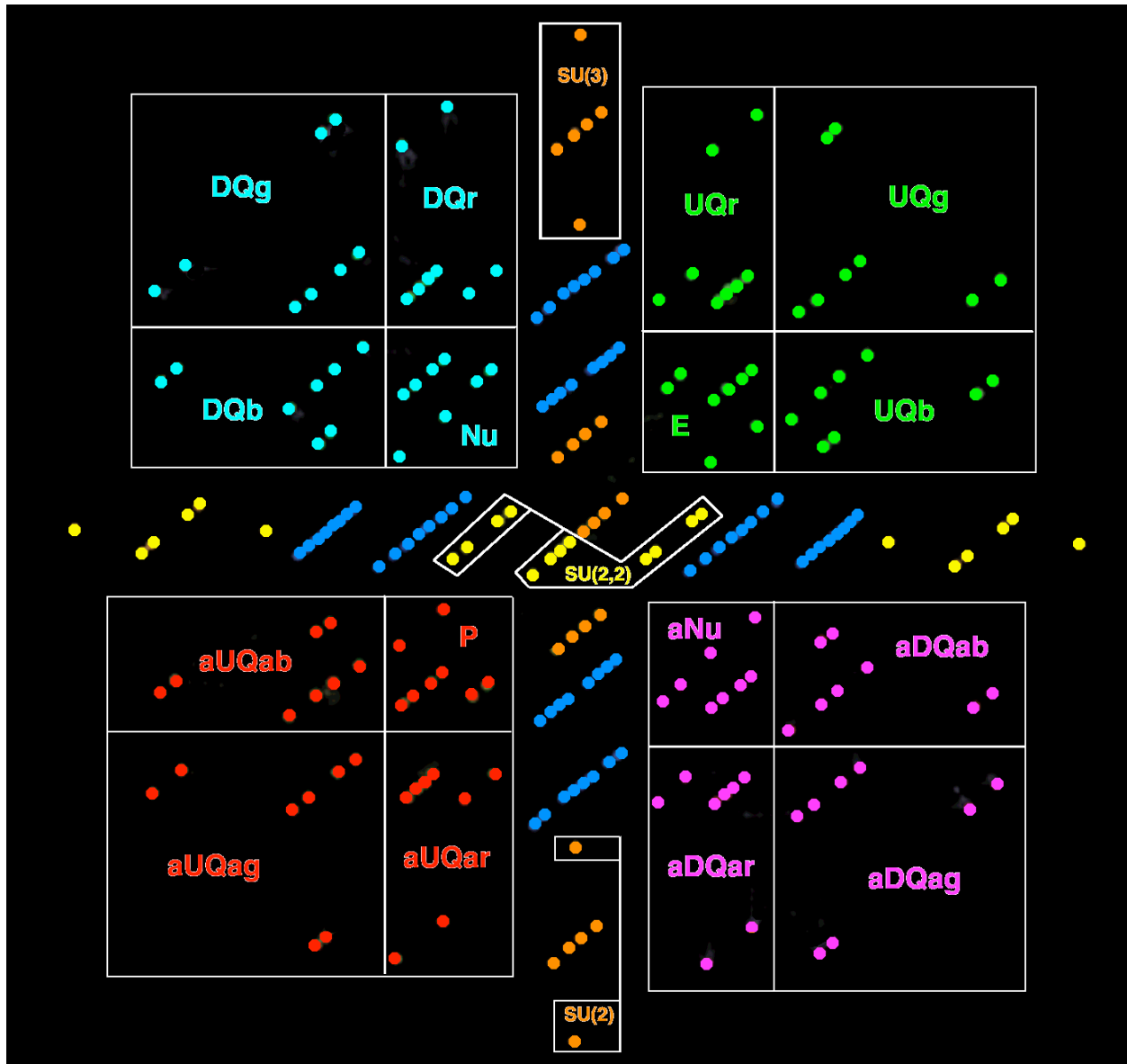

E = electron, UQr = red up quark, UQg = green up quark, UQb = blue up quark
 Nu = neutrino, DQr = red down quark, DQg = green down quark, DQb = blue down quark
 P = positron, aUQar = anti-red up antiquark,
 aUQag = anti-green up antiquark, aUQab = anti-blue up antiquark
 aNu = antineutrino, aDQar = anti-red down antiquark,
 aDQag = anti-green down antiquark, aDQab = anti-blue down antiquark

Each Lepton and Quark has 8 components with respect to 4+4 dim Kaluza-Klein
 6 orange SU(3) and 2 orange SU(2) represent Standard Model root vectors
 24-6-2 = 16 orange represent U(2,2) Conformal Gravity Ghosts
 12 yellow SU(2,2) represent Conformal Gravity SU(2,2) root vectors
 24-12 = 12 yellow represent Standard Model Ghosts
 32+32 = 64 blue represent 4+4 dim Kaluza-Klein M4 x CP2 Spacetime Base Manifold
 32 for M4 position x 8 momentum and 32 for CP2 position x 8 momentum

Higgs and Second and Third Generation Fermions emerge from breaking Octonionic Symmetry of the Inflation Era to Quaternionic Symmetry of Present Era.
(Mayer, Acta Physica Austriaca, Suppl. XXIII (1981))

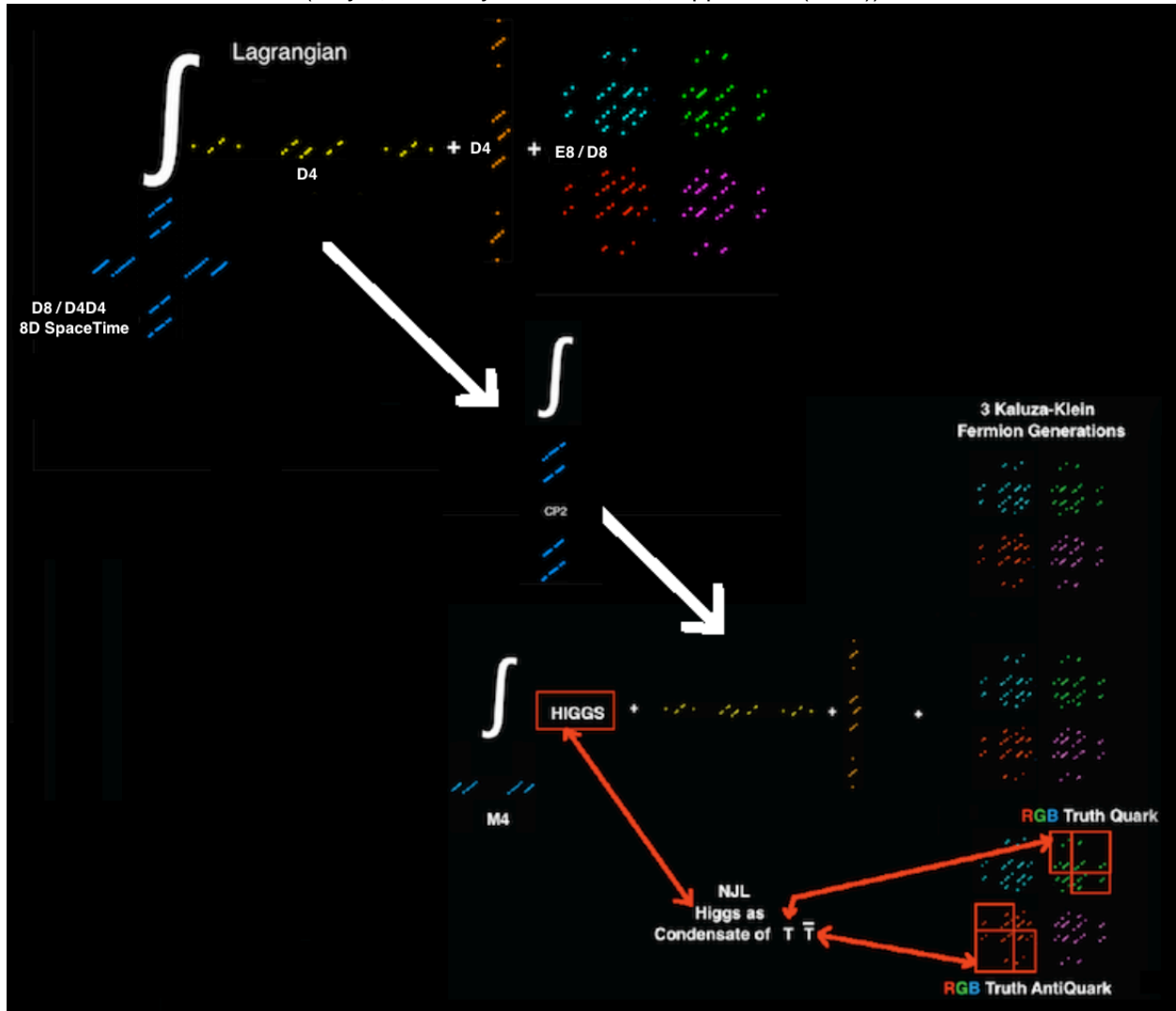

The Higgs is a Condensate of Tquark and TantiQuark resulting in
3 mass states for the Higgs and the Tquark
(Smith, viXra 1701.0496)

As to the unconventional mass states other than 125 GeV Higgs and 174 GeV Tquark:
ATLAS, for the Full 2016 36.1 fb-1 of 2016 data in the Higgs -> ZZ* -> 4l channel,
on 5 July 2017 released ATLAS-CONF-2017-058 saying:

“... A search for heavy resonances ...[in the Higgs -> ZZ* -> 4l channel]...
uses proton–proton collision data at a centre-of-mass energy of 13 TeV
corresponding to an integrated luminosity of 36.1 fb-1 collected with the ATLAS
detector during 2015 and 2016 at the Large Hadron Collider ...

**excess ...[is]... observed in the data for m4l around 240 ... GeV ...
with a local significance of 3.6 sigma ...”.**

**It will be interesting to see whether the 2017 ATLAS data of over 45 fb-1
will confirm or refute the excess at 240 GeV as a Higgs mass state.**

Here is a chart showing the 3 Mass States for Higgs and Tquark (viXra 1701.0496):
green dot in the Stable region (green) has 125 GeV Higgs and 130 GeV Tquark
cyan dot on the Non-perturbativity Boundary has 190 GeV Higgs and 174 GeV Tquark
magenta dot at the Critical Point has 250 GeV Higgs and 220 GeV Tquark

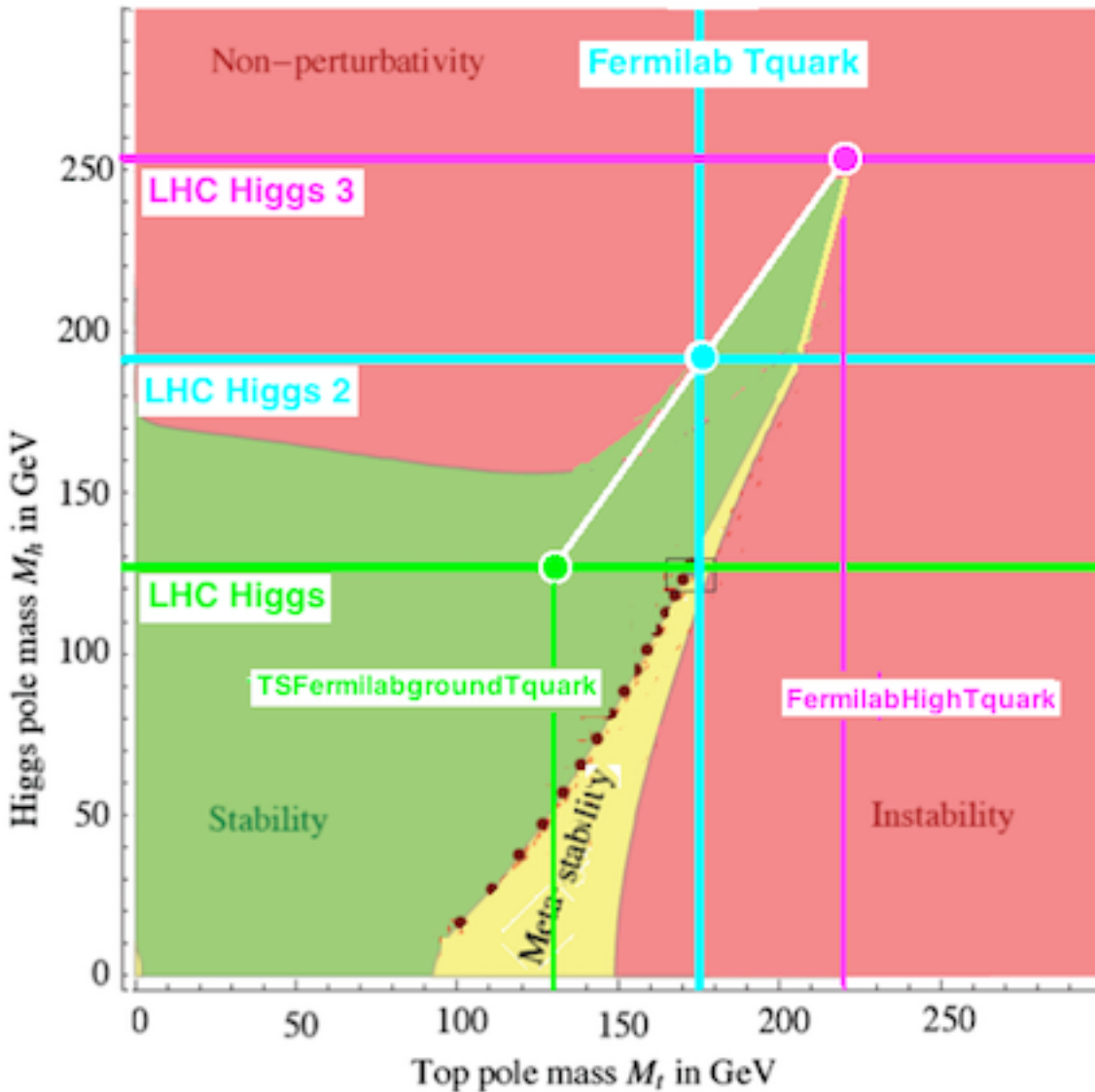

CMS, for their Full 35.9 fb⁻¹ of 2016 data in the Higgs -> ZZ* -> 4l channel,
in CMS-PAS-HIG-16-041 has bins of 4 GeV width and shows all 3 Higgs mass states:
low-mass Higgs state (green) with mass 125 GeV
middle-mass Higgs state (cyan) with mass 201 GeV (close to 190 GeV)
high-mass Higgs state (magenta) with mass 261 GeV (close to 240 and 250 GeV)

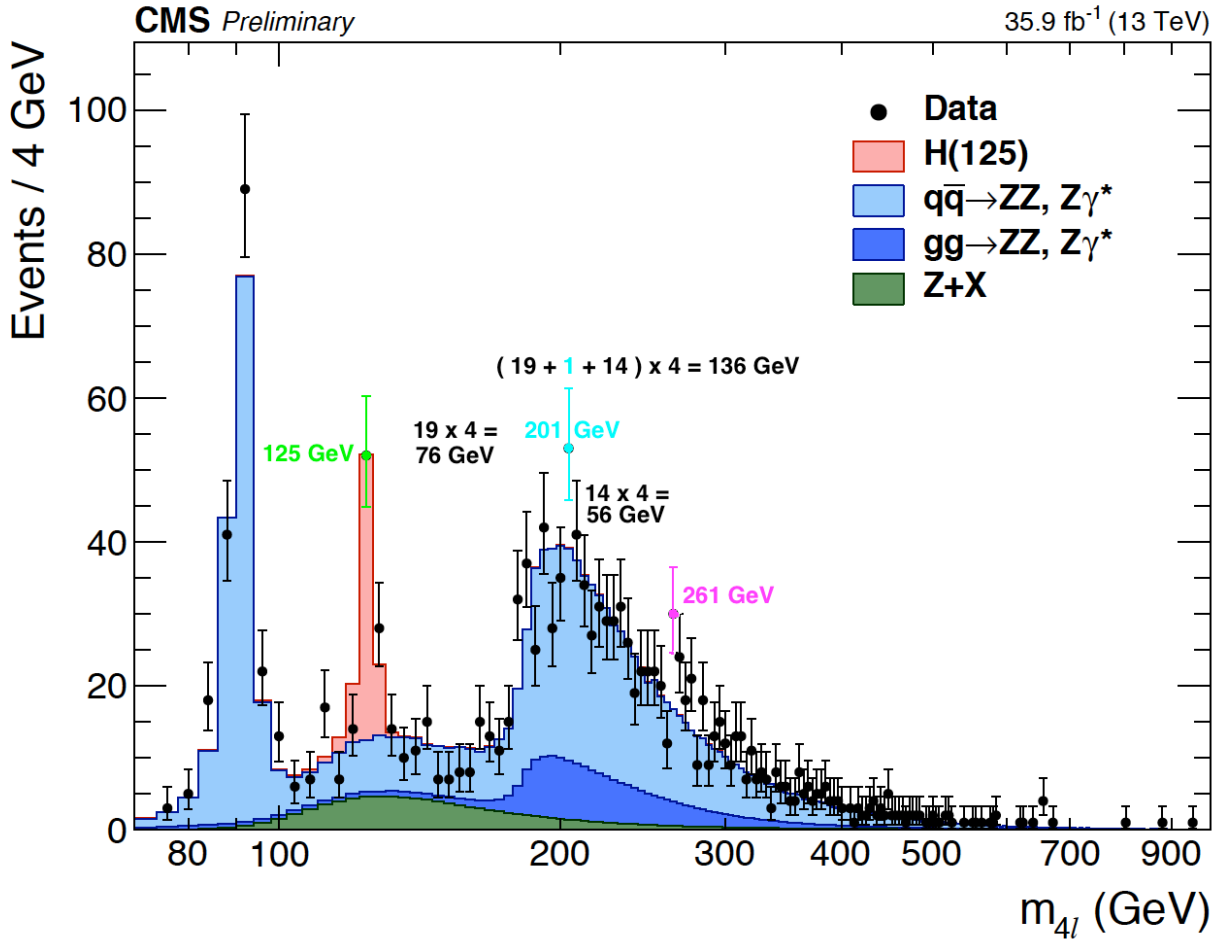

Semileptonic histograms of CDF and D0 show all 3 Truth Quark Mass States

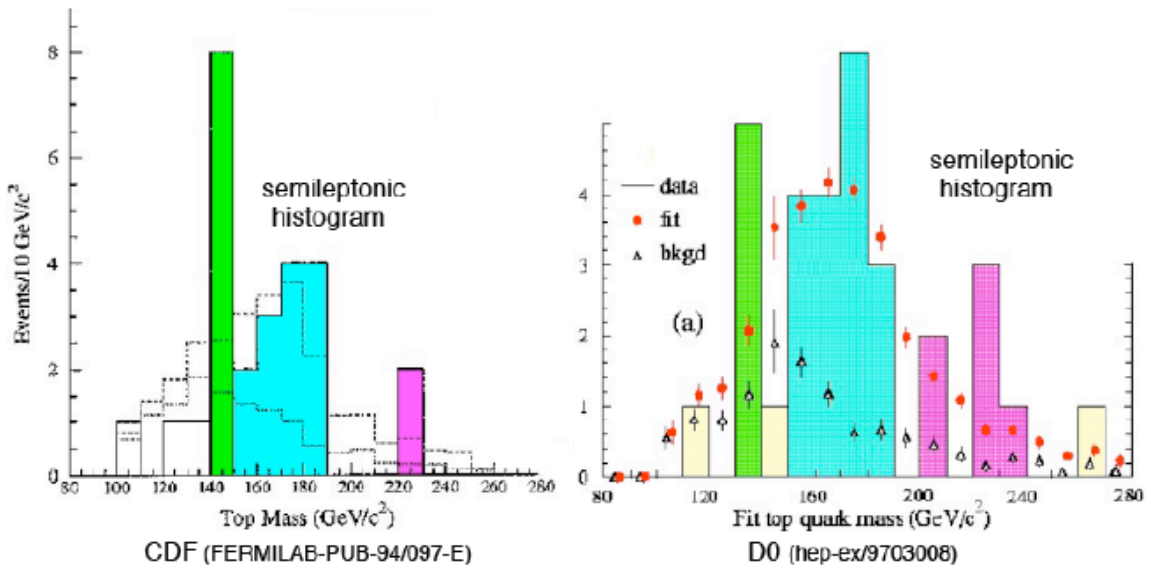

low-mass Tquark state (green) with mass 130 GeV
 middle-mass Tquark state (cyan) with mass 174 GeV
 high-mass Tquark state (magenta) with mass 220 GeV

The Completion of Union of All Tensor Products of $Cl(1,25)$ = hyperfinite AQFT

(Smith, viXra 1701.0495)

containing the Realistic Physics of the Lagrangian.

It also contains, due to its $Cl(1,25)$ components,
the structure of 26-dim String Theory

in which Strings are seen as Particle World-Lines,

the massless spin 2 state is the carrier of the Bohm Quantum Potential, and
the $SO(24)$ little group is related to the Monster automorphism group
that is the symmetry of each cell of Planck-scale local lattice structure.

(Green, Schwartz, and Witten, "Superstring Theory" vol. 1)

10-dim String Spacetime is Kaluza-Klein 6-dim Conformal x 4-dim CP^2 giving $M^4 \times CP^2$

8-dim K-K Classical Lagrangian Spacetime as an NJL condensate of Dixon's

64-dim Particle spinor $T = RxCxHxO$ and the 64-dim AntiParticle spinor $Tbar$

Each cell of E8 Classical Lagrangian Spacetime corresponds to 65,536-dim $Cl(16)$

which contains 248-dim $E_8 = 120$ -dim D8 bivectors +128-dim D8 half-spinors

Human Brain Microtubules 40 microns long have 65,536 Tubulin Dimers

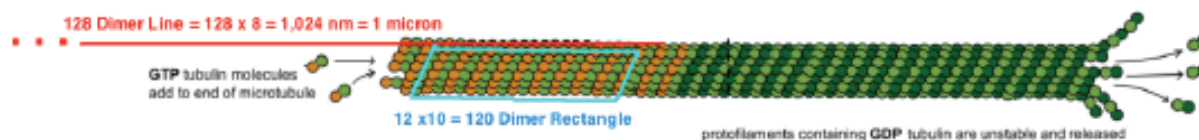

(image adapted from 12biophys.blogspot.com Lecture 11)

and so can have Bohm Quantum Resonance with $Cl(16)$ Spacetime cells

so that the State of Consciousness of a Human is in exact resonant

correspondence with a subset of the cells of E8 Classical Lagrangian Spacetime

Therefore E8 Classical Lagrangian Spacetime NJL Condensate is effectively the
Spirit World in which the Human States of Consciousness = Souls exist.

What happens to a Fundamental Fermion Particle whose World-Line string intersects a Single Cell ?

The Fundamental Fermion Particle does not remain a single Planck-scale entity.

Tachyons create clouds of particles/antiparticles.

(Schroer, hep-th/9908021)

The Fundamental Fermion Cloud looks like a Kerr-Newman Black Hole.

(Arcos and Pereira, hep-th/0210103)

What is the size of the Fundamental Fermion Kerr-Newman Cloud ?

The Cloud is one Planck-scale Fundamental Fermion Valence Particle plus
an effectively neutral cloud of particle/antiparticle pairs. The symmetry of the cloud
is governed by the 24-dimensional Leech lattice by which the Single Cell was formed.

According to the ATLAS at brauer.maths.qmul.ac.uk/Atlas/v3/spor/M/

the maximal subgroup of the Monster M involving Co_1 is $2^{24}.Co_1$ of order

$139511839126336328171520000 = 1.4 \times 10^{26}$ As $2.Co_1$ is the Automorphism group

of the Leech Lattice modulo to which the Single Cell was formed,

and as the 26-dim String Theory Leech Lattice is a superposition of 8 Leech Lattices,

$8 \times 2^{24}.Co_1$ describes the structure of the Cloud. Therefore,

the volume of the Cloud should be on the order of 10^{27} x Planck scale containing

10^{27} particle/antiparticle pairs with size $10^{(27/3)} \times 1.6 \times 10^{(-33)} \text{ cm} = 10^{(-24)} \text{ cm}$.

Fundamental Fermion Clouds are Schwinger Sources.

Sources require Linear Operators

“... represented by a definite integral [of a]... kernel ... function ...”.

(Fock, “Fundamental of Quantum Mechanics” (1931))

Kernel Functions for Complex Classical Domains were described by Hua.

(Hua, “Harmonic Analysis of Functions of Several Complex Variables in the Classical Domains” (1958))

Schwinger in 1951 “... introduced a description in terms of Green’s functions, what Feynman had called propagators ... The Green’s functions are vacuum expectation values of time-ordered Heisenberg operators, and the field theory can be defined non-perturbatively in terms of these functions ...[which]... gave deep structural insights into QFTs; in particular ... the structure of the Green's functions when their variables are analytically continued to complex values ...”.

(Schweber, PNAS 102, 7783-7788)

The Classical Domains (complete simply connected Riemannian symmetric spaces) representing 4-dim Spacetime with Quaternionic Structure are:

$S^1 \times S^1 \times S^1 \times S^1 = 4$ copies of $U(1)$

$S^2 \times S^2 = 2$ copies of $SU(2)$

$CP^2 = SU(3) / SU(2) \times U(1)$

$S^4 = Spin(5) / Spin(4) =$ Euclidean version of $Spin(2,3) / Spin(1,3)$

(Wolf, J. Math. Mech 14 (1965) 1033-1047)

Wyler showed how to use Green’s Functions = Kernel Functions of Classical Domain structures characterizing Sources = Leptons, Quarks, and Gauge Bosons, to calculate Particle Masses and Force Strengths

(Wyler, 1971 - C. R. Acad. Sc. Paris, t. 271, 186-188)

“... We introduce a quantitative description of the particle source in terms of a source function ... we do not have to claim that we can make the source arbitrarily small ... the experimenter... must detect the particles ...[by]... collision that annihilates the particle ... the source ... can be ... an abstraction of an annihilation collision, with the source acting negatively, as a sink ... The basic things are ... the source functions ... describing the intermediate propagation of the particle ...”

(Schwinger, 1969 - see physics/0610054)

Schwinger Sources can be described by continuous manifold structures of Bounded Complex Domains and their Shilov Boundaries

and

Wyler’s techniques allow calculation of Particle Masses and Force Strengths

(Smith, viXra 1602.0319)

Results of such calculations are shown in the Technical Endnotes:

Technical Endnotes:

Results of Calculations:

Quark masses are constituent masses. Most of the calculations are tree-level.

Fermions are Schwinger Sources with geometry of Complex Bounded Domains

and Kerr-Newman Black Hole structure size about $10^{(-24)}$ cm.

Since ratios are calculated, values for one particle mass and one force strength are assumed.

Particle/Force	Tree-Level	Higher-Order
e-neutrino	0	0 for nu_1
mu-neutrino	0	$9 \times 10^{(-3)}$ eV for nu_2
tau-neutrino	0	$5.4 \times 10^{(-2)}$ eV for nu_3
electron	0.5110 MeV	
down quark	312.8 MeV	charged pion = 139 MeV
up quark	312.8 MeV	proton = 938.25 MeV
		neutron - proton = 1.1 MeV
muon	104.8 MeV	106.2 MeV
strange quark	625 MeV	
charm quark	2090 MeV	
tauon	1.88 GeV	
beauty quark	5.63 GeV	
truth quark (low state)	130 GeV	(middle state) 174 GeV (high state) 218 GeV
W+	80.326 GeV	
W-	80.326 GeV	
W0	98.379 GeV	Z0 = 91.862 GeV
Mplanck 1.217×10^{19} GeV		
Higgs VEV (assumed)	252.5 GeV	
Higgs (low state)	126 GeV	(middle state) 182 GeV (high state) 239 GeV
Gravity Gg (assumed)	1	
(Gg)(Mproton ² / Mplanck ²)		$5 \times 10^{(-39)}$
EM fine structure	1/137.03608	
Weak Gw	0.2535	
Gw(Mproton ² / (Mw+ ² + Mw- ² + Mz0 ²))		$1.05 \times 10^{(-5)}$
Color Force at 0.245 GeV	0.6286	0.106 at 91 GeV

Kobayashi-Maskawa parameters for W+ and W- processes are:

	d	s	b
u	0.975	0.222	0.00249 -0.00388i
c	-0.222 -0.000161i	0.974 -0.0000365i	0.0423
t	0.00698 -0.00378i	-0.0418 -0.00086i	0.999

The phase angle d13 is taken to be 1 radian.

Dark Energy : Dark Matter : Ordinary Matter = 0.75 : 0.21 : 0.04

References:

Adler, Quaternionic Quantum Mechanics and Quantum Fields (1995), pages 50-52, 561

Arcos and Pereira, hep-th/0210103

Batakis, Class. Quantum Grav.3 (1986) L99-L105

Dixon, Division Algebras (O, H, C, and R) and Windmill Tilting

Finkelstein, Int. J. Theor. Phys. 2017 56 : 2-39

Fock, Fundamental of Quantum Mechanics

Green, Schwartz, and Witten, Superstring Theory vol. 1

Hua, Harmonic Analysis of Functions of Several Complex Variables
in the Classical Domains

Lounesto and Porteous, Lectures on Clifford (Geometric) Algebras and Applications

Mayer, Acta Physica Austriaca, Suppl. XXIII (1981)

Porteous, Clifford Algebras and the Classical Groups

Schroer, hep-th/9908021

Schweber, PNAS 102, 7783-7788

Schwinger, 1969 - see physics/0610054

Smith, viXra 1602.0319

Smith, viXra 1701.0495

Smith, viXra 1701.0496

Smith, viXra 1709.0265

Wolf, J. Math. Mech 14 (1965) 1033-1047

Wyler, 1971 - C. R. Acad. Sc. Paris, t. 271, 186-188

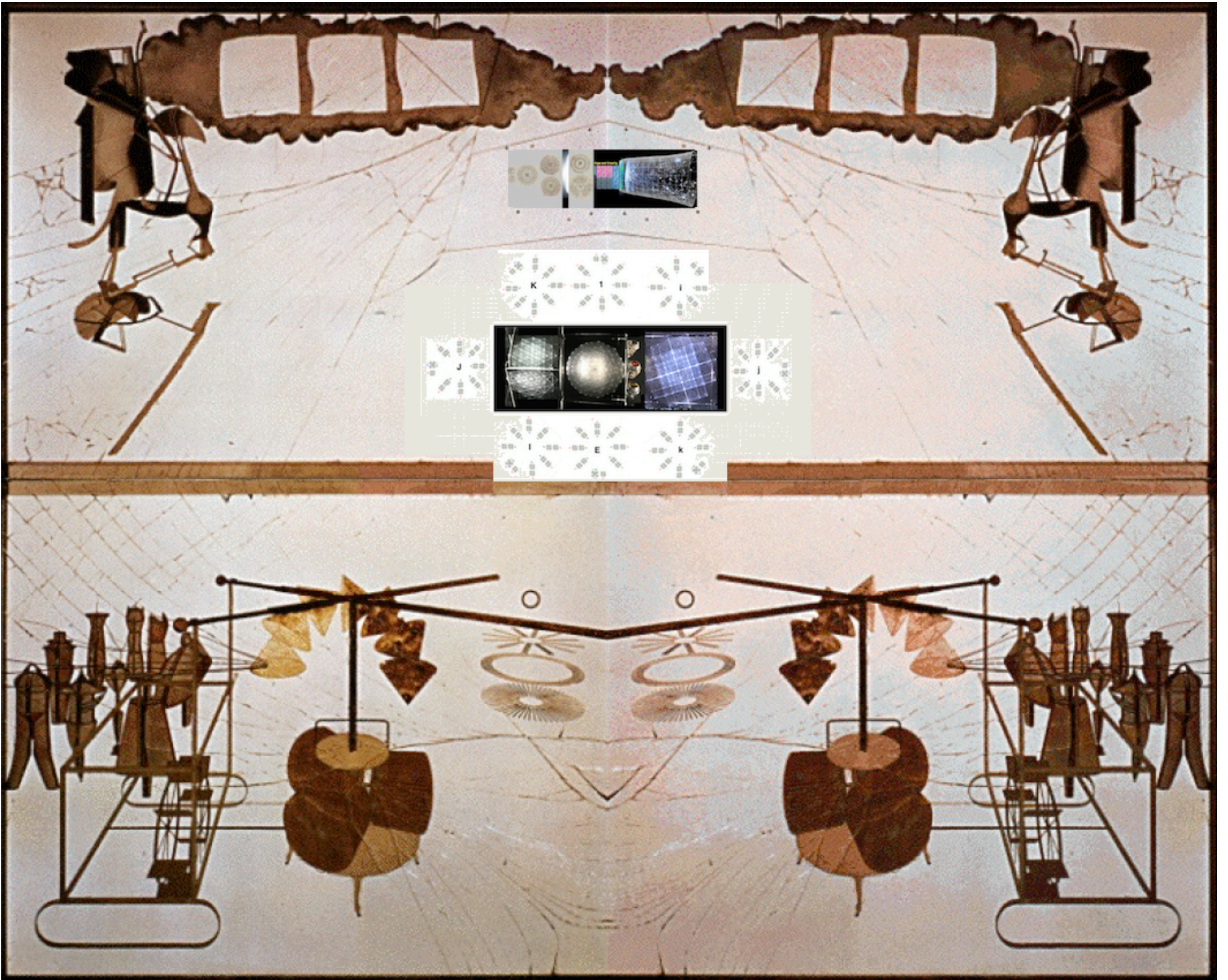

Dimension of Clifford Algebra						
0	$2^0=1$	$2^1=2$	$2^2=4$	$2^4=16$	$2^{16}=65536$	256×256

VOID \rightarrow CI(VOID) \rightarrow CI(0,0) \rightarrow CI(0,1) \rightarrow CI(0,2) \rightarrow CI(0,4) \rightarrow CI(0,16) = CI(0,8) x CI(0,8) \rightarrow CI(0,16) x CI(0,8) = CI(0,24) \rightarrow M(2, CI(0,24)) = CI(1,25) \rightarrow

\rightarrow Completion of Union of All Tensor Products of CI(1,25) = hyperfinite AQFT

CI(1,25) = CI(1,9) x CI(0,8) x CI(0,8) and CI(1,9) = CI(1,5) x CI(0,4) = CI(2,4) x CI(0,4)

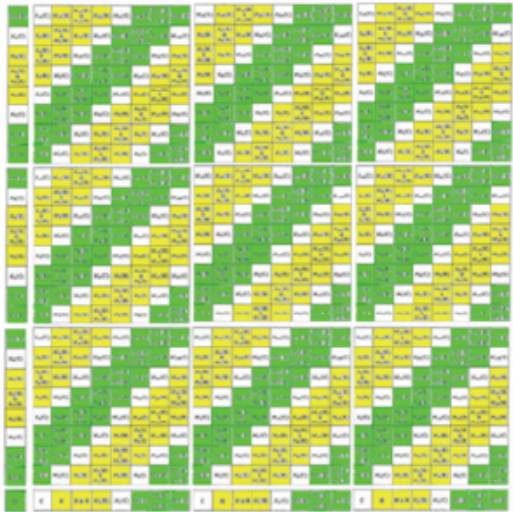
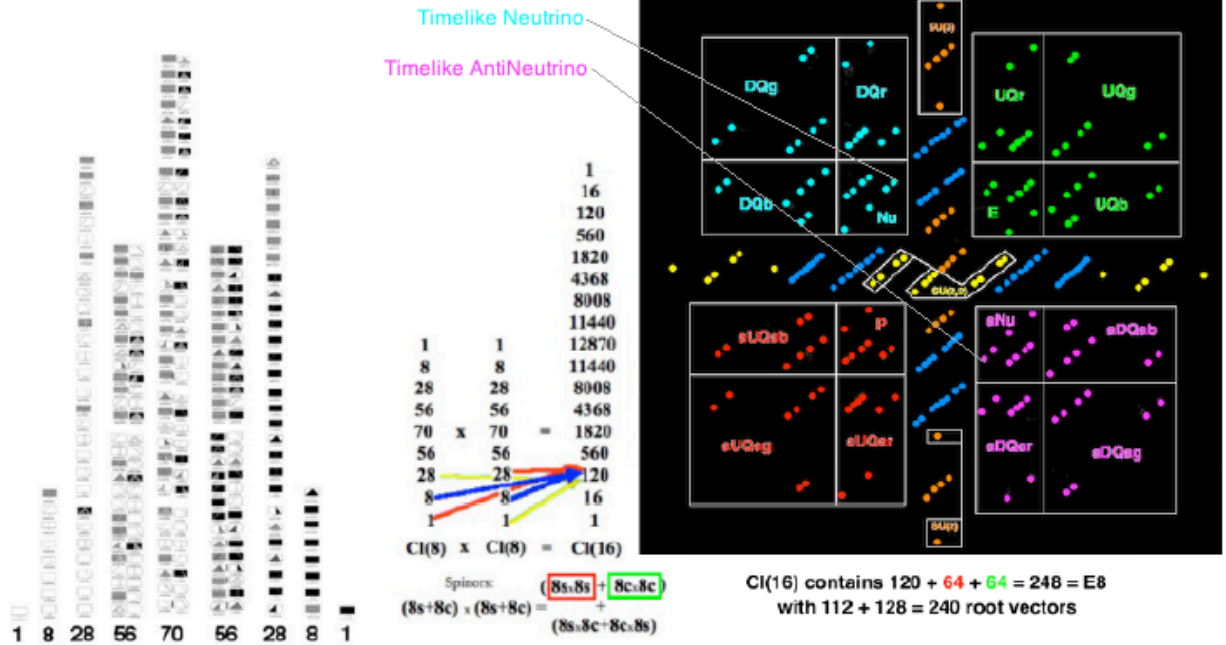
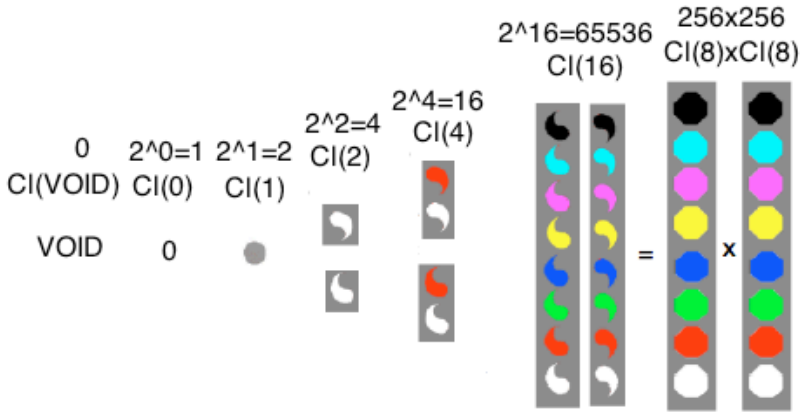

The completion of the union of all tensor products of CI(16) = CI(8) x CI(8) produces a generalized Hyperfinite III von Neumann factor that gives the CI(16)-E8 model a natural Algebraic Quantum Field Theory

The CI(16)-E8 AQFT inherits structure from the CI(16)-E8 Local Lagrangian

The Creation-Annihilation Operator structure of CI(16)-E8 AQFT is given by the Maximal Contraction of E8 = semidirect product A7 x h92 where h92 = 92+1+92 = 185-dim Heisenberg algebra and A7 = 63-dim SL(8)

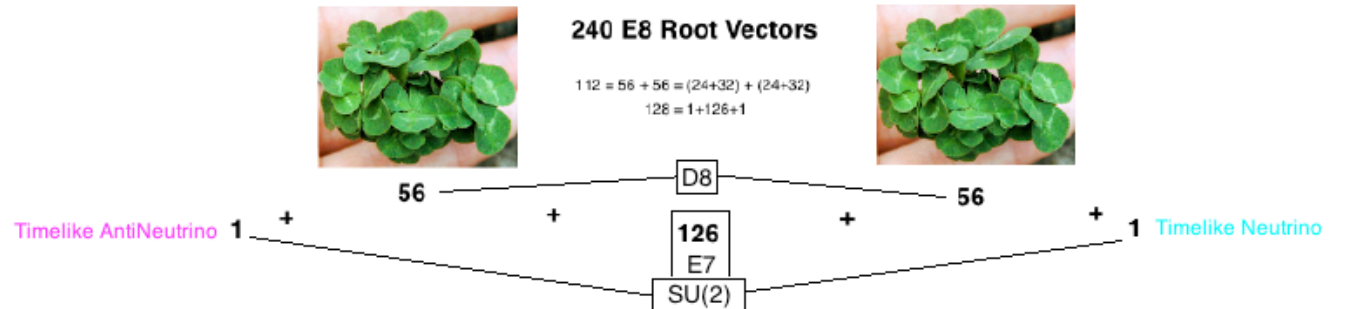

January 2018

Sunday	Monday	Tuesday	Wednesday	Thursday	Friday	Saturday
	1 <small>New Year's Day</small>	2	3	4	5	6
7	8	9	10	11	12	13
14	15 <small>Martin Luther King, Jr. Day</small>	16	17	18	19	20
21	22	23	24	25	26	27
28	29	30	31			

Lagrangian

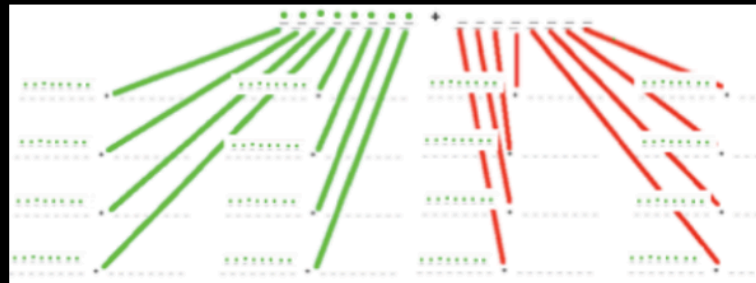
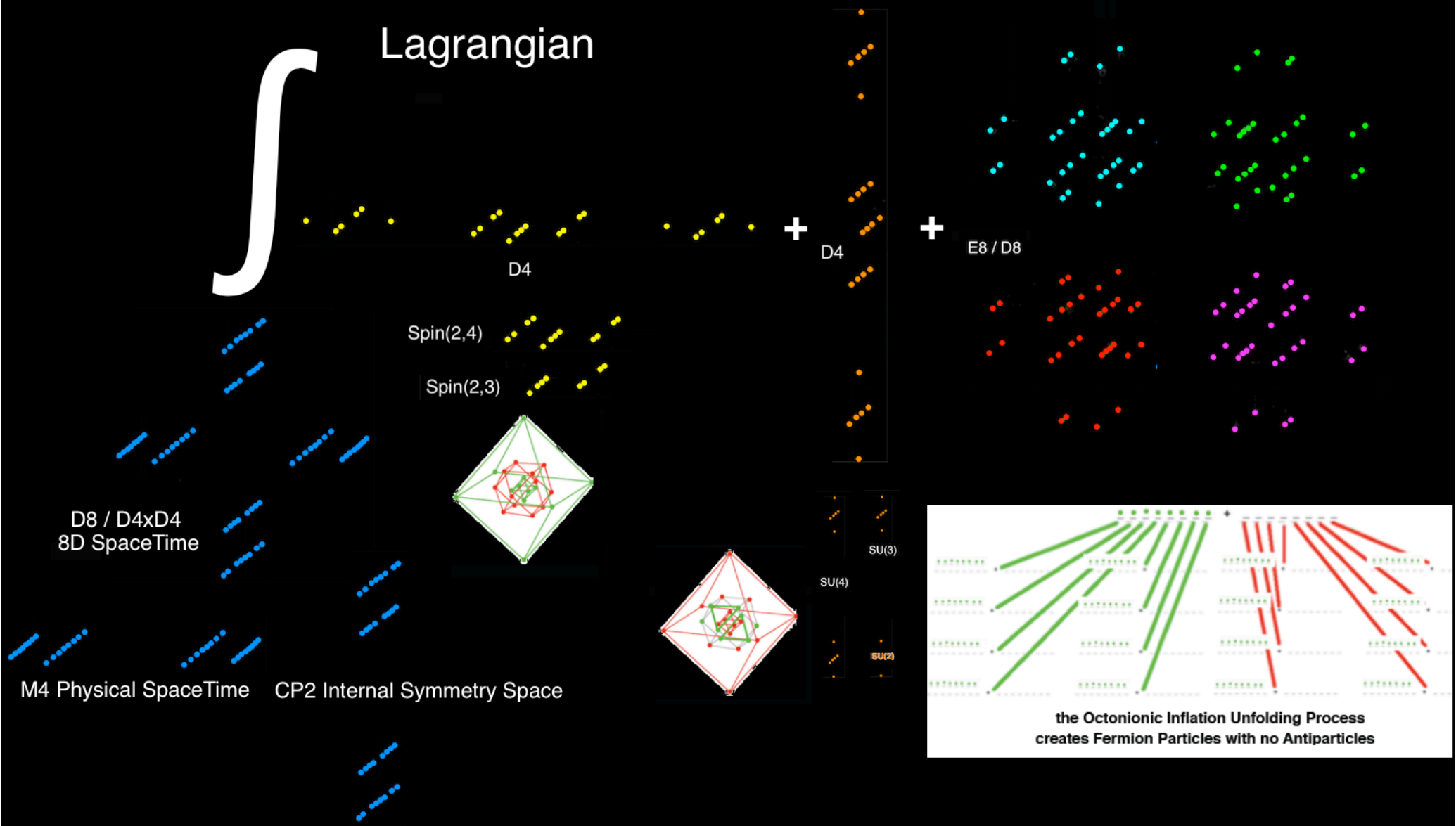
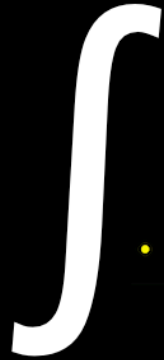

**the Octonionic Inflation Unfolding Process
creates Fermion Particles with no Antiparticles**

February 2018

Sunday	Monday	Tuesday	Wednesday	Thursday	Friday	Saturday
				1	2 Groundhog Day	3
4	5	6	7	8	9	10
11	12 Lincoln's Birthday	13	14 St. Valentine's Day Ash Wednesday	15	16 Chinese New Year	17
18	19 President's Day	20	21	22	23	24
25	26	27	28 Purim			

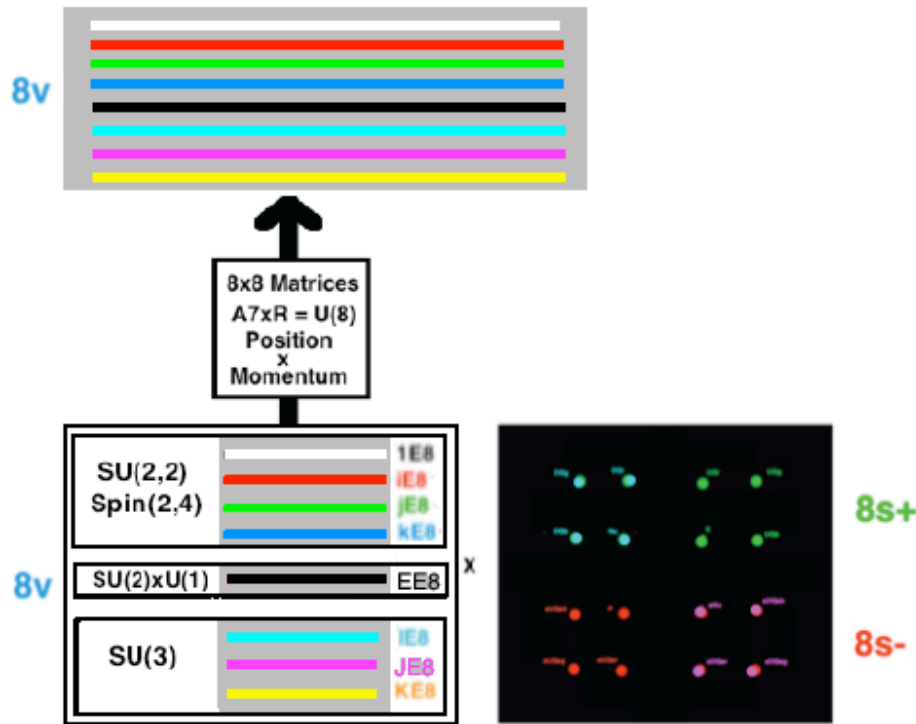

Indra's Net of Schwinger Sources - Bohm Quantum Blockchain

The $CI(16)$ -E8 AQFT inherits structure from the $CI(16)$ -E8 Local Lagrangian

$$\int \text{Standard Model Gauge Gravity} + \text{Fermion Particle-AntiParticle}$$

8-dim SpaceTime

the $CI(16)$ -E8 model at the Planck Scale has spacetime condensing out of Clifford structures forming a Leech lattice underlying 26-dim String Theory of World-Lines with $8 + 8 + 8 = 24$ -dim of fermion particles and antiparticles and of spacetime.

Slices of 8v SpaceTime are represented as D8 branes. Each D8 brane has Planck-Scale Lattice Structure superpositions of 8 types of E8 Lattice denoted by 1E8, iE8, jE8, kE8, EE8, IE8, JE8, KE8

Stack D8 branes to get SpaceTime with Strings = World-Lines

Let Oct16 = discrete multiplicative group $\{ +/1, +/-i, +/-j, +/-k, +/-E, +/-I, +/-J, +/-K \}$.

Orbifold by Oct16 the $8s+$ to get 8 Fermion Particle Types

Orbifold by Oct16 the $8s-$ to get 8 Fermion AntiParticle Types

Gauge Bosons from 1E8 and EE8 parts of a D8 give U(2) Electroweak Force

Gauge Bosons from IE8, JE8, and KE8 parts of a D8 give SU(3) Color Force

Gauge Bosons from 1E8, iE8, JE8, and kE8 parts of a D8 give U(2,2) Conformal Gravity

The 8x8 matrices for collective coordinates linking one D8 to the next D8 give Position x Momentum

The automorphism group of a single 26-dim String Theory cell modulo the Leech lattice is the Monster Group of order about 8×10^{53} .

When a fermion particle/antiparticle appears Tachyons create a cloud of particles/antiparticles. The cloud is one Planck-scale Fundamental Fermion Valence Particle plus an effectively neutral cloud of particle/antiparticle pairs forming a Kerr-Newman black hole. That cloud constitutes the Schwinger Source.

The Schwinger Sources are finite regions in a Complex Domain spacetime corresponding to Green's functions of particle creation / annihilation.

Its structure comes from the 24-dim Leech lattice part of the Monster Group which is $2^{24}(1+24)$ times the double cover of Co_1 , for a total order of about 10^{26} .

(Since a Leech lattice is based on copies of an E8 lattice and since there are 7 distinct E8 integral domain lattices there are 7 (or 8 if you include a non-integral domain E8 lattice) distinct Leech lattices. The physical Leech lattice is a superposition of them, effectively adding a factor of 8 to the order.)

The volume of the Kerr-Newman Cloud is on the order of 10^{27} x Planck scale, = roughly $10^{(-24)}$ cm.

March 2018

Sunday	Monday	Tuesday	Wednesday	Thursday	Friday	Saturday
				1	2	3
4	5	6	7	8	9	10
11 Daylight Savings Begins	12	13	14	15	16	17 St. Patrick's Day
18	19	20 Spring Begins	21	22	23	24
25 Palm Sunday	26	27	28	29	30 Passover	31

Big Bang E8(-248) : Spin(16) | Octonion Inflation E8(8) : SO(8,8) | Quaternion Conformal Evolution E8(-24) : SO*(16)

At the end of Non-Unitary Octonionic Inflation Our Universe had about $(1/2) 16^{64} = (1/2) (2^4)^{64} = 2^{255} = 6 \times 10^{76}$ Fermion Particles
 the size of our Universe was then about $10^{(-24)}$ cm
 which is about the size of a Fermion Schwinger Source Kerr-Newman Cloud

The End of Inflation time was at about $10^{(-34)}$ sec = 2^{64} Tplanck

The Zizzi Inflation phase of our universe ends with decoherence "collapse" of the 2^{64} Superposition Inflated Universe into Many Worlds of Quantum Theory,

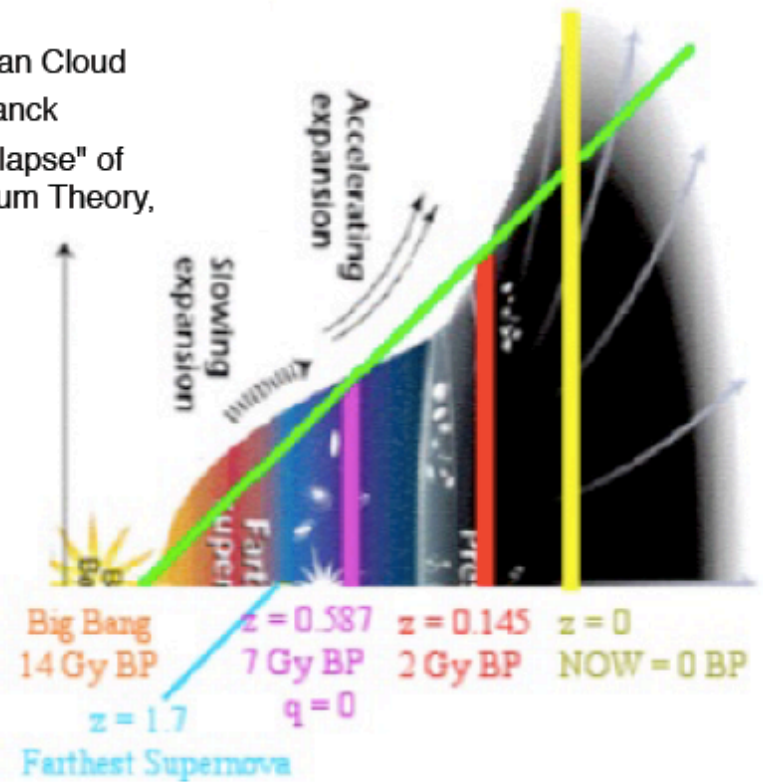
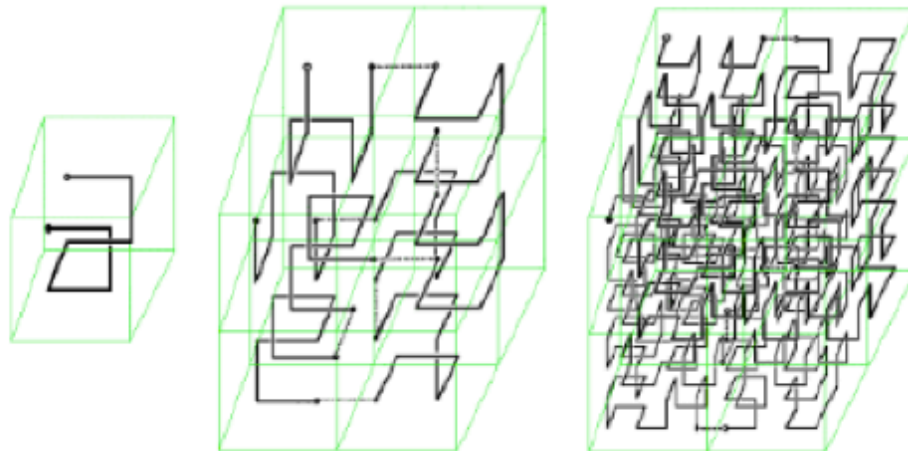
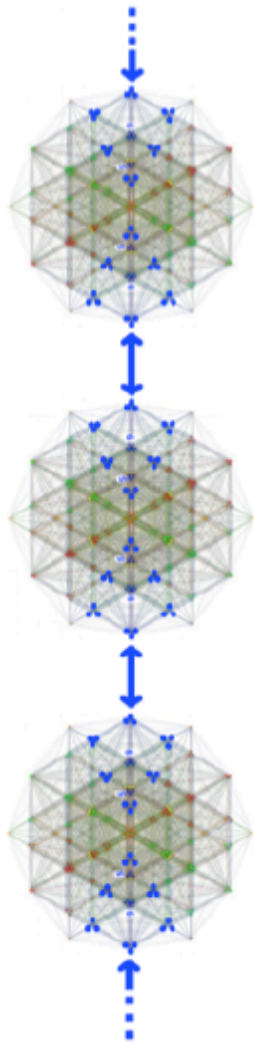

The ratio Dark Energy : Dark Matter : Ordinary Matter for our Universe at the present time is calculated to be:
 $0.75 : 0.21 : 0.04$

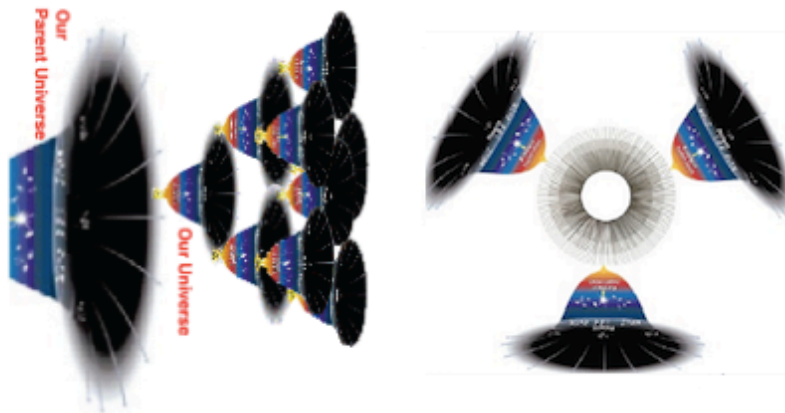

Paola Zizzi in gr-qc/0007006:

"... The self-reduction of the superposed quantum state ... corresponds to a superposed state of ... [$10^{19} = 2^{64}$ qubits] ... also the number of superposed tubulins-qubits in our brain ... leading to a conscious event. ..."

April 2018

Sunday	Monday	Tuesday	Wednesday	Thursday	Friday	Saturday
1 April Fool's Day Easter Sunday	2	3	4	5	6	7
8	9	10	11	12	13	14
15	16	17	18	19	20	21
22 Earth Day	23	24	25	26	27	28
29	30					

CONFORMAL KEPLER

MERCURY
 0.39 AU
 Octahedron
 1 : $\sqrt{3}$
 1 : 1.7321

VENUS
 0.72 AU
 Icosahedron
 1 : $\sqrt{15-6\sqrt{5}}$
 1 : 1.2584

EARTH
 1 AU
 Dodecahedron
 1 : 1.2584

MOON
 1 AU
 Dodecahedron
 1 : 1.2584

MARS
 1.52 AU
 Dodecahedron
 1 : 1.2584

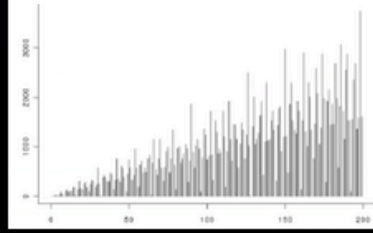

JUPITER
 5.20 AU
 Tetrahedron
 1 : 3
 SelfDual

SATURN
 9.54 AU
 Cube
 1 : $\sqrt{3}$
 1 : 1.7321

Neptune
 30.06 AU
 Rhombic Dodecahedron
 1 : $\sqrt{2}$
 1 : 1.4142
 (square face inscribed radius)

Uranus
 19.19 AU
 Cuboctahedron
 D₃ Root Vectors
 Conformal SU(2,2) = Spin(2,4)

Pioneer Anomaly
 20 AU
 Rhombic Dodecahedron
 1 : $\sqrt{2}$
 1 : 1.4142

Cuboctahedron and Rhombic Dodecahedron
 are 3-dim central figures of the 4-dim 24-cell



May 2018

Sunday	Monday	Tuesday	Wednesday	Thursday	Friday	Saturday
		1 May Day	2	3	4	5 Cinco de Mayo
6	7	8	9	10	11	12
13 Mother's Day	14	15	16	17	18	19 Shavuot Begins Sundown
20	21 Victoria Day	22	23	24	25	26
27	28 Memorial Day	29	30	31		

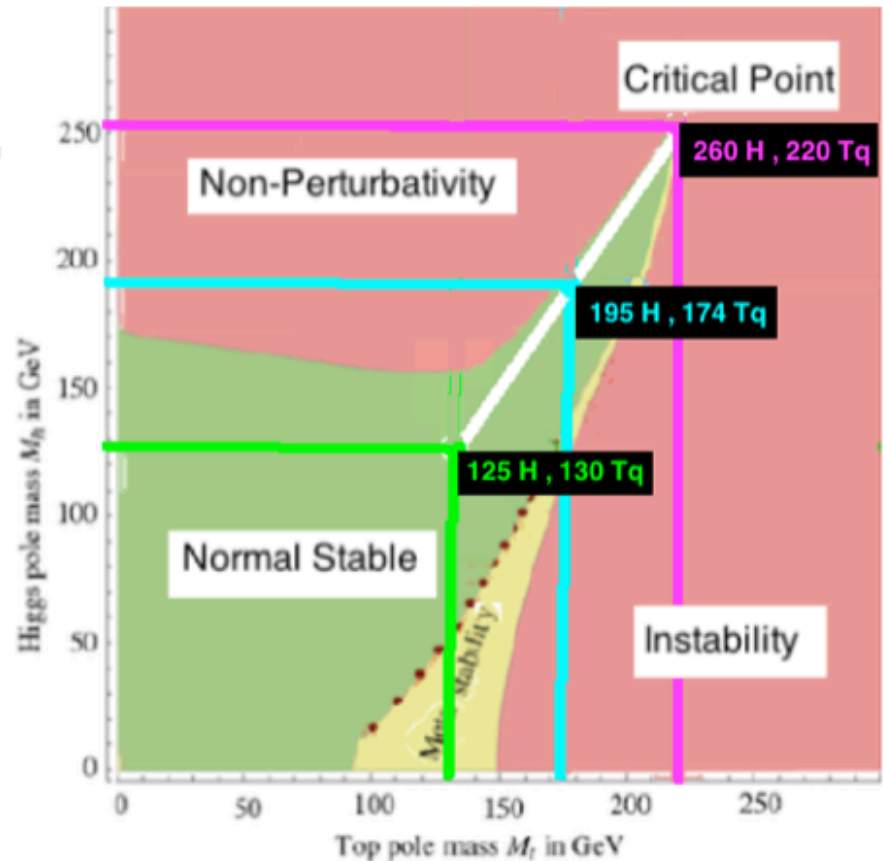
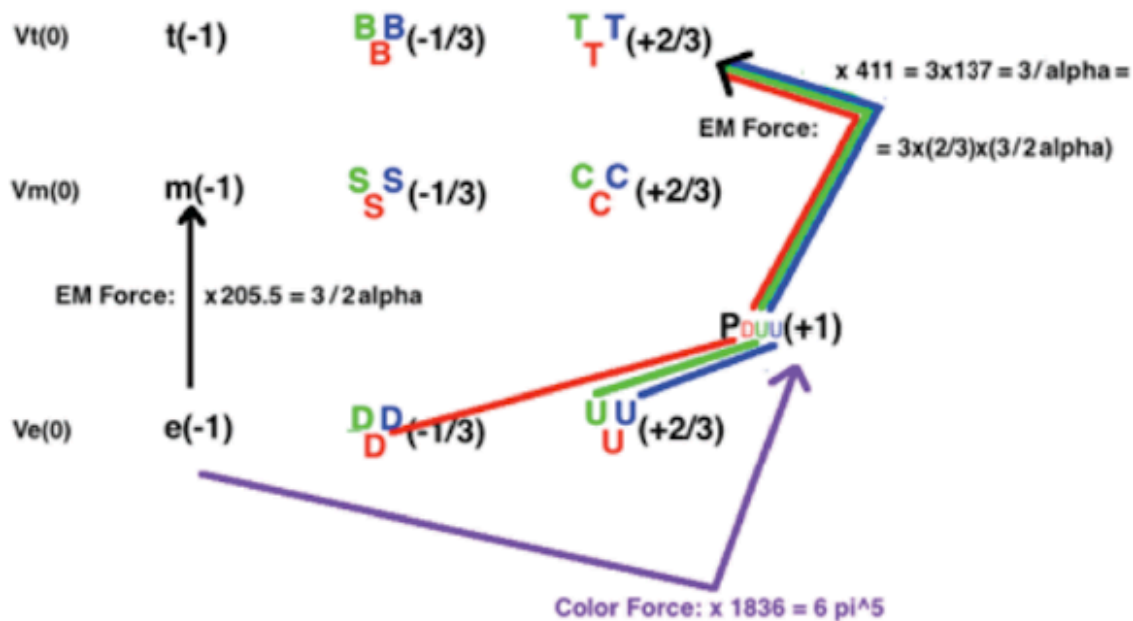

The Schwinger Sources are finite regions in a Complex Domain spacetime corresponding to Green's functions of particle creation / annihilation.

The force strength of a given force is

$$\left(\frac{1}{M_{\text{force}}^2} \right) \left(\text{Vol}(\text{MIS}_{\text{force}}) \right) \left(\frac{\text{Vol}(\text{Q}_{\text{force}})}{\text{Vol}(\text{D}_{\text{force}})} \right)^{\left(\frac{1}{m_{\text{force}}} \right)}$$

M_{force} represents the effective mass;

m_{force} is 4 for Gravity and Color force, 2 for Weak force 1 for Electromagnetism

$\frac{\text{Vol}(\text{D}_{\text{force}})}{\text{Vol}(\text{Q}_{\text{force}})} \left(\frac{1}{m_{\text{force}}} \right)$ is to reconcile

the dimensionality of the Internal Symmetry Space of the target vertex with the dimensionality of the link from the origin to the target vertex

Force	M	Vol(M)	Group	SymSpace	D	Vol(D)	Q	Vol(Q)
gravity	S^4	$8\pi^2/3$	Spin(5)	Spin(7) / Spin(5)xU(1)	IV5	$\pi^5/2^4 5!$	$RP^1 \times S^4$	$8\pi^3/3$
color	CP^2	$8\pi^2/3$	SU(3)	SU(4) / SU(3)xU(1)	$B^6(\text{ball})$	$\pi^3/6$	S^5	$4\pi^3$
Weak	$S^2 \times S^2$	$2 \times 4\pi$	SU(2)	Spin(5) / SU(2)xU(1)	IV3	$\pi^3/24$	$RP^1 \times S^2$	$4\pi^2$
e-mag	T^4	$4 \times 2\pi$	U(1)	-	-	-	-	-

June 2018

Sunday	Monday	Tuesday	Wednesday	Thursday	Friday	Saturday
					1	2
3	4	5	6	7	8	9
10	11	12	13	14 Flag Day	15	16
17 Father's Day	18	19	20	21 Summer Begins	22	23
24	25	26	27	28	29	30

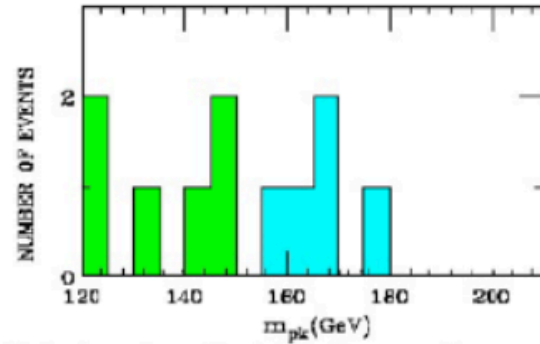
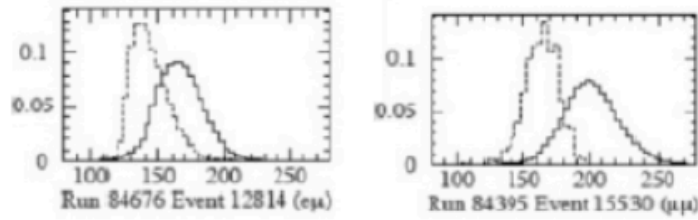
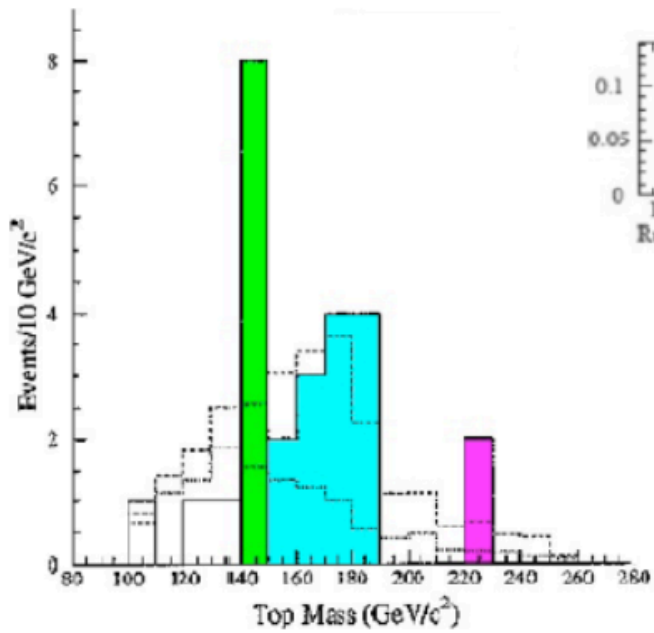

The distribution of $m_{\mu\mu}$ values determined from 11 CPD dilepton events

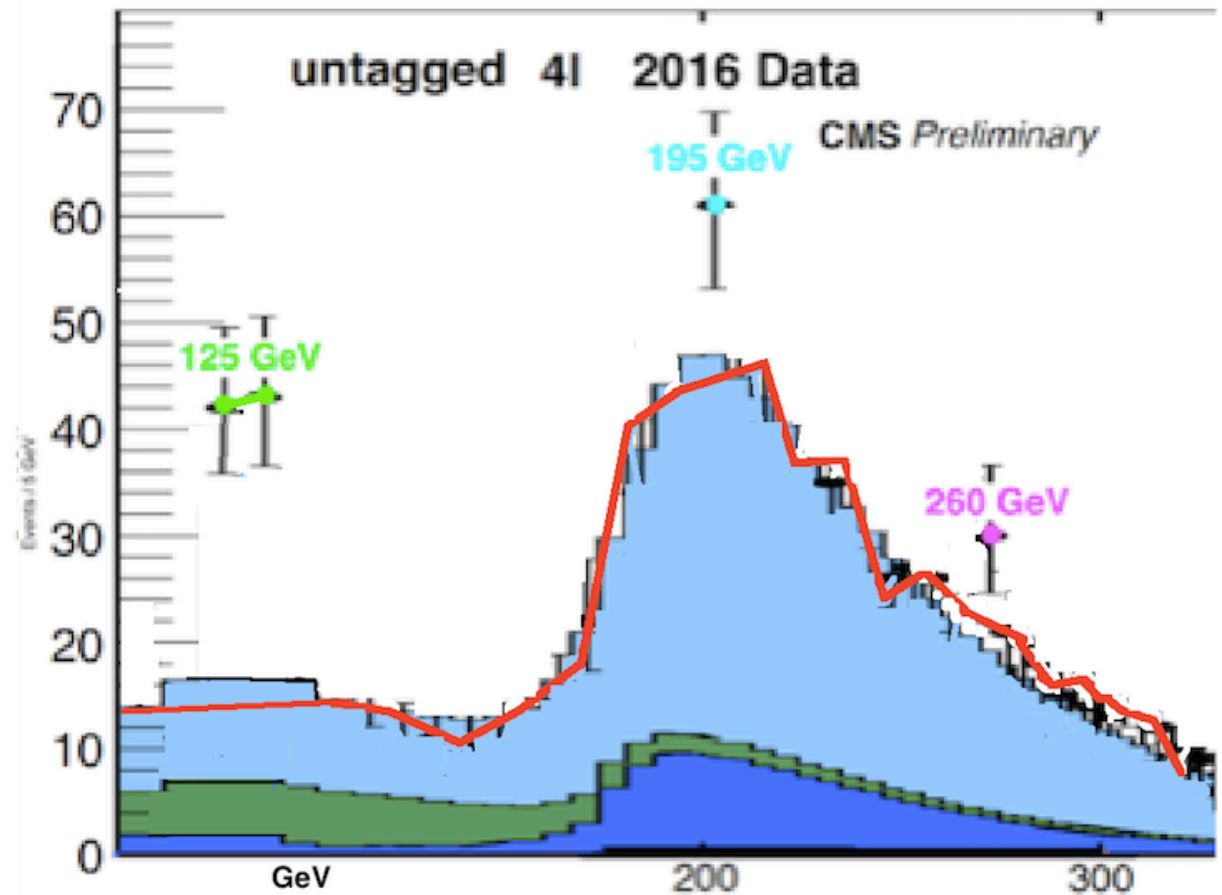
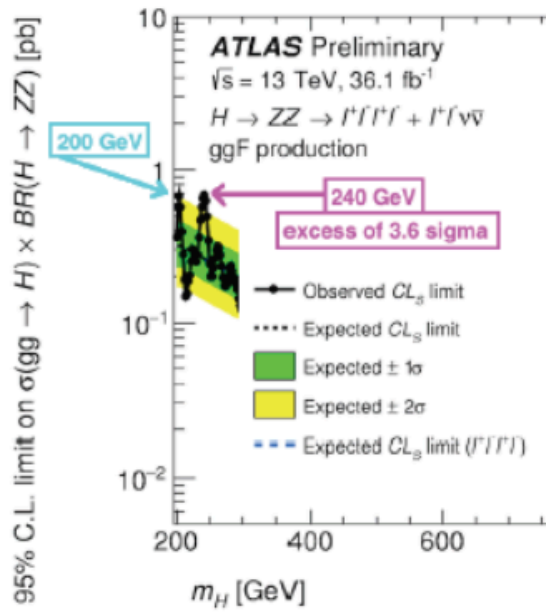
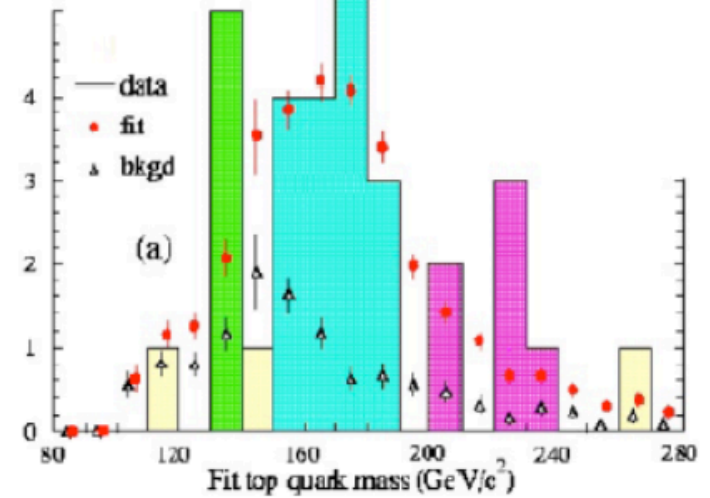

July 2018

Sunday	Monday	Tuesday	Wednesday	Thursday	Friday	Saturday
1 Canada Day	2	3	4 Independence Day	5	6	7
8	9	10	11	12	13	14
15	16	17	18	19	20	21
22	23	24	25	26	27	28
29	30	31				

Schwinger Pd-D Zeolite Quantum Fusion Process:

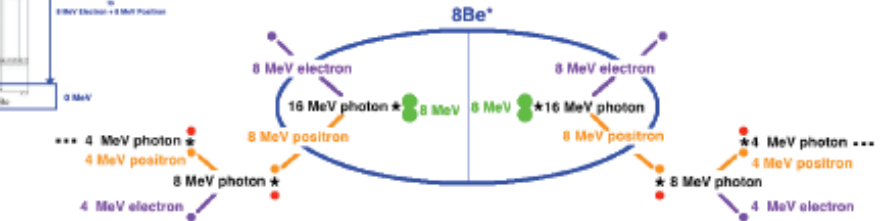
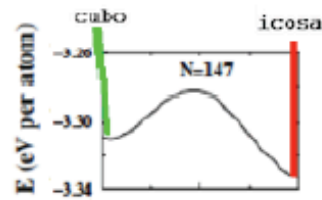
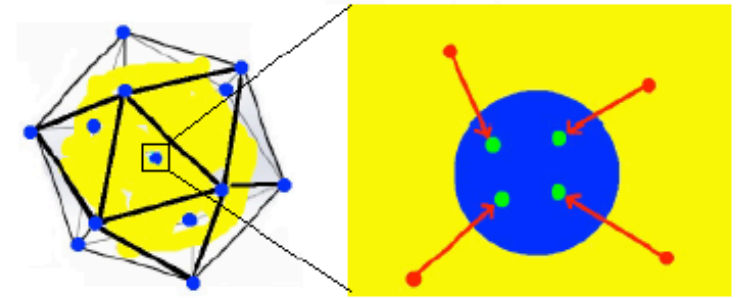
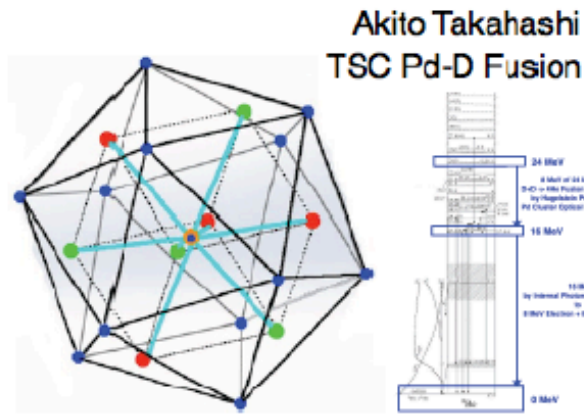
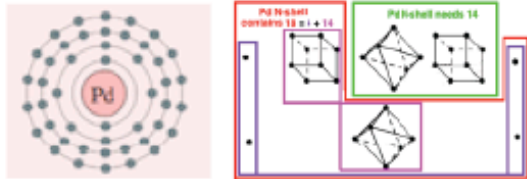

Sandia-UNM 147-atom Pd Clusters

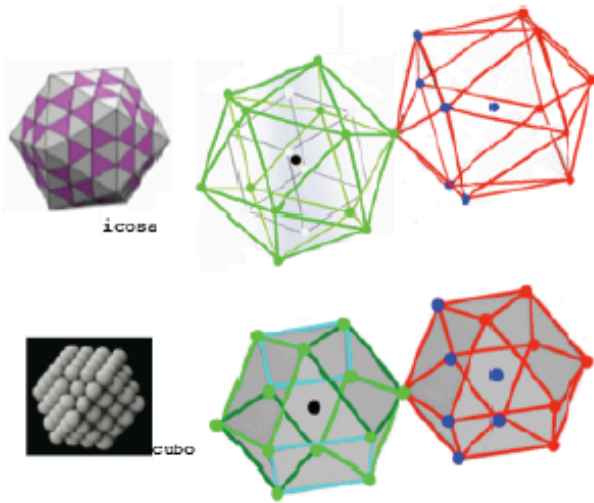

Peter Hagelstein Nuclear Energy to Pd Structure to Zeolite

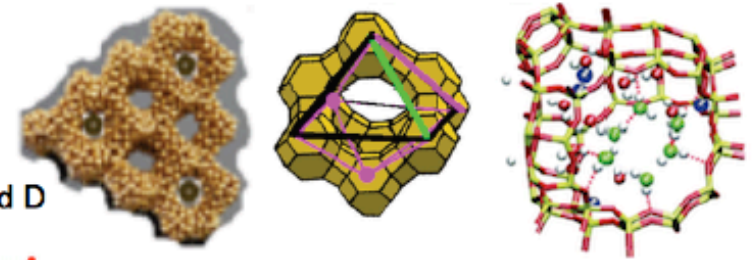

Klee Irwin Jitterbug Eject He and Reload D

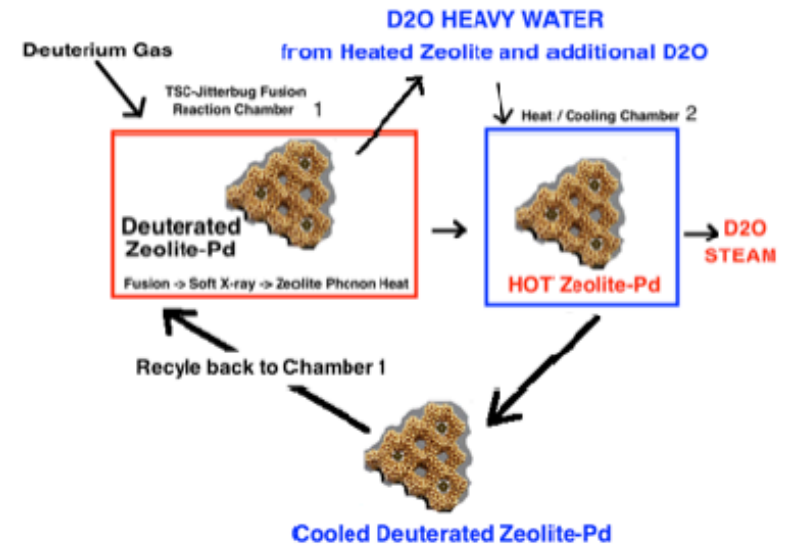
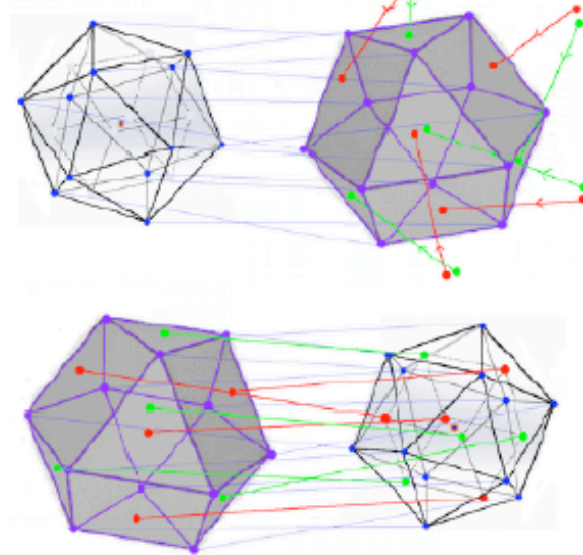

August 2018

Sunday	Monday	Tuesday	Wednesday	Thursday	Friday	Saturday
			1	2	3	4
5	6	7	8	9	10	11
12	13	14	15	16	17	18
19	20	21	22	23	24	25
26	27	28	29	30	31	

Each QRC State, analogous to a Possible Conscious Thought, is represented by a Chain of Local EB-CI(16) Multiverse Snapshots
 Each of the Local EB-CI(16) Multiverse Snapshot is described by an EB State. Since EB has 240 Root Vectors (and the 240 Root Vectors correspond to the 240-Polytope (see "Geometric Frustration" by Sadoc and Mosseri (Cambridge 2006) where they say "The polytope 240 ...[s]... not a regular polytope ... but ... an ordered structure on a hypersphere ... S3 ... which is chiral ... generated by adding two replicas of the (3,3,5), displaced along a screw axis of S3 ...")
 each Local EB-CI(10) Multiverse Snapshot is represented by a pair of (3,3,5) 000-cells.

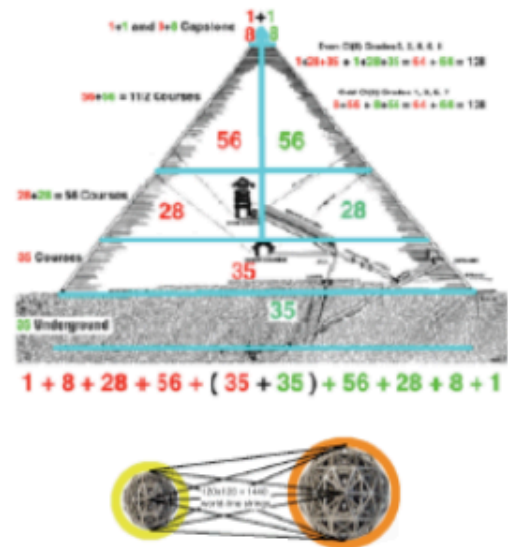
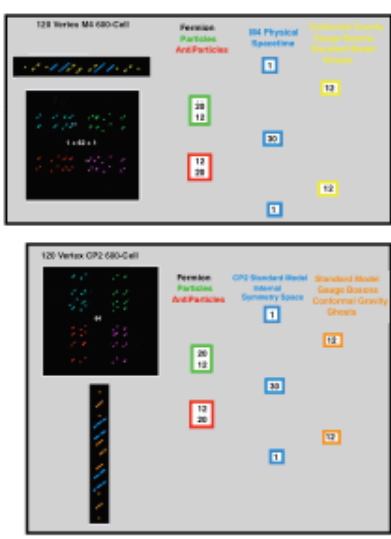
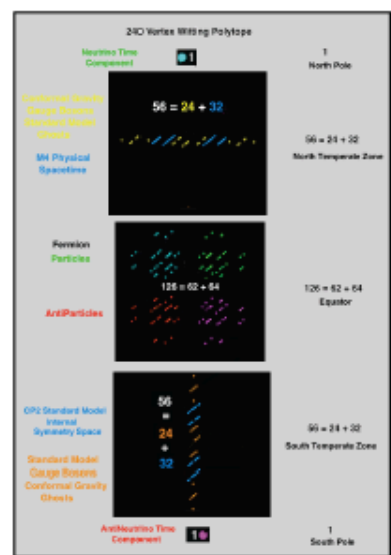
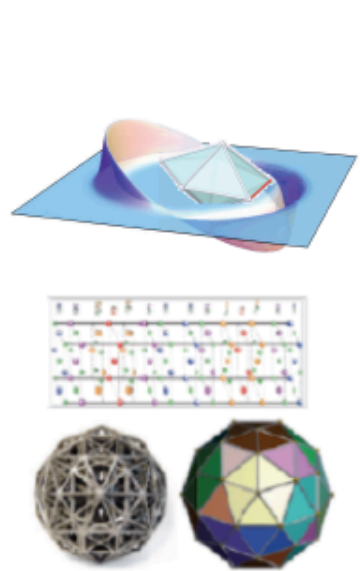

Green, Schwartz, and Witten say in their book "Superstring Theory" vol. 1 (Cambridge 1986) "... For the ... closed ... bosonic string ... The first excited level ... consists of ... the ground state ... tachyon ... and ... a scalar ... 'dilaton' ... and ... SO(24) ... little group of a ... [26-dim] ... massless particle ... and ... a ... massless ... spin two state ...".
 Closed string tachyons localized at orbifolds of fermions produce virtual clouds of particles / antiparticles that dress fermions.
 Dilatons are Goldstone bosons of spontaneously broken scale invariance that (analogous to Higgs) go from mediating a long-range scalar gravity-type force to the nonlocality of the Bohm-Sarfatti Quantum Potential.
 The SO(24) little group is related to the Monster automorphism group that is the symmetry of each coil of Planck scale local lattice structure.
 The massless spin two state is the carrier of the Bohm-Sarfatti Quantum Potential.
 Peter R. Holland says in his book "The Quantum Theory of Motion" (Cambridge 1993) "... the total force ... from the quantum potential ... does not ... fall off with distance ... because ... the quantum potential ... depends on the form of ... [the quantum state] ... rather than ... its ... magnitude ...".

First consider Superposition of States involving one tubulin with one electron of mass m and two different position states separated by a . The Superposition Separation Difference is the gravitational energy $E_{\text{electron}} = G m^2 / a$
 For any single given tubulin $a = 1$ nanometer = 10^{-7} cm so that for a single Electron $T = h / E_{\text{electron}} = (\text{Compton} / \text{Schwarzschild}) (a / c) = 10^{-26} \text{ sec} = 10^{-19} \text{ years}$
 Now consider the case of N Tubulin Electrons in Coherent Superposition Jack Sarfatti defines coherence length L by $L^3 = N a^3$ so that the Superposition Energy E_N of N superposed Conformation Electrons is $E_N = G M^2 / L = N^{5/3} E_{\text{electron}}$
 The decoherence time for the system of N Tubulin Electrons is $T_N = h / E_N = h / N^{5/3} E_{\text{electron}} = N^{-5/3} 10^{-26} \text{ sec}$
 Number of Involved Tubulin Dimers Time T_N
 $10^4(11+9) = 10^{20}$ $10^4(33 + 26) = 10^{(-7)}$ sec 10^{11} neurons x 10^9 TD / neuron
 10^{16} $10^4(27 + 26) = 10^{(-1)}$ sec 10 Hz - Human Alpha EEG is 8 to 13 Hz -
 Fundamental Schumann Resonance is 7.8 Hz -
 Time of Hamiltonian Circuit of 10^{16} TD separated from nearest neighbors by 10 nm is $10^{16} \times 10 \text{ nm} / c = (10^{16} \times 10^4(-6)) \text{ cm} / c = 10^{10} \text{ cm} / c = 0.3 \text{ sec}$

$\int \int \int$
 CI(2,4) CP2 OP2
 Conformal Vectors

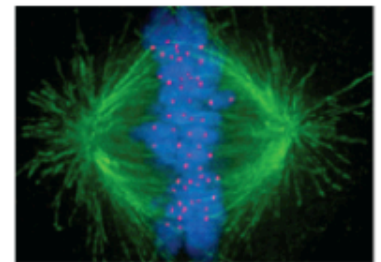
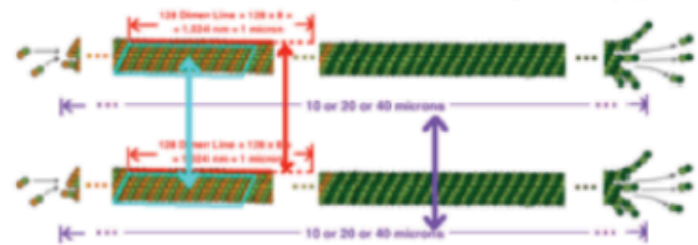
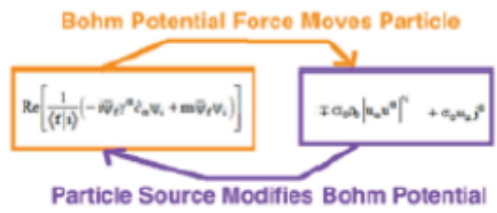

September 2018

Sunday	Monday	Tuesday	Wednesday	Thursday	Friday	Saturday
						1
2	3 Labor Day	4	5	6	7	8
9 Grandparents Day Rosh Hashanah	10	11	12	13	14	15
16	17	18 Yom Kippur	19	20	21	22 Autumn Begins
23	24	25	26	27	28	29
	30					

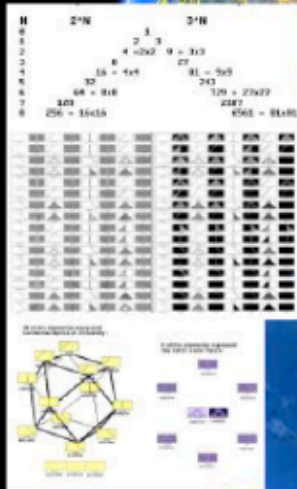
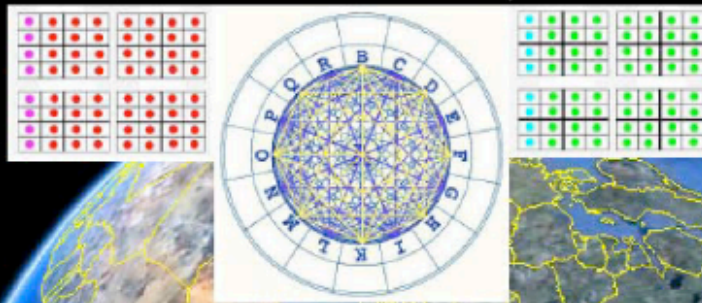

33. श्रीमद्वैदिक पुराणेति सुखस्य देवकीपुत्रजम् । सोमस्यै स्वसालेषुम्
 श्रीमः पूर्वोपश्रुतिपरोदसो नूननैरुत । य देवो एह वैश्रुति
 श्रीमसो श्रुतिमश्रुतमोपश्रुतं दिव्यैरेव । यशसो योयवेषुम्
 अष्टे य पुत्रमश्रुत विभक्तः शरिभूतसं । स प्रदेवेषु सचरति
 श्रीमद्वैदिक कविज्ञेयः सुखस्यैश्रुतस्यः । देवो देवेषु गेपम्
 पदम् सुखस्यै स्वस्यै श्रुते केशिपुत्रसि । तवेतत्कवमीश्रुतः
 उवं एवमेव दिव्यैरेव शेषेषुस्यस्यै सुखम् । नमो धरन्तु स्वस्यै
 राजनैवश्रुतस्यै गोपपुत्रस्यै वैश्रुतिम् । वर्षेषान् खे दवे
 स नः श्रुतेवं सुखस्यै सुखस्यै श्रुतं । श्रुतस्यै ना स्वस्यै

The first richa of the first sukt has 24 syllables plus 24 gaps.
 It is followed by 8 lines,
 each with 8+8 = 16 Sanskrit syllables left of the | line
 and 8 Sanskrit syllables right of the | line,
 for 24 Sanskrit syllables per line
 and 8x24 = 192 syllables for all 8 lines.
 The grand total is 24+24+192 = 240 = Root Vectors of E8.

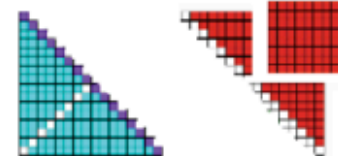
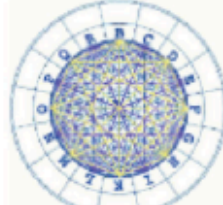
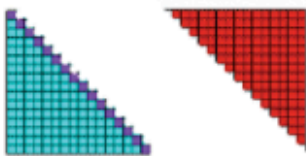
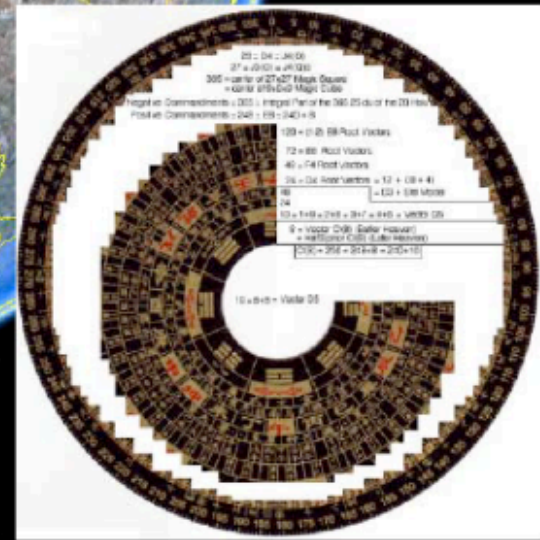

October 2018

Sunday	Monday	Tuesday	Wednesday	Thursday	Friday	Saturday
	1	2	3	4	5	6
7	8 Columbus Day	9	10	11	12	13
14	15	16	17	18	19	20
21	22	23	24	25	26	27
28	29	30	31 Halloween			

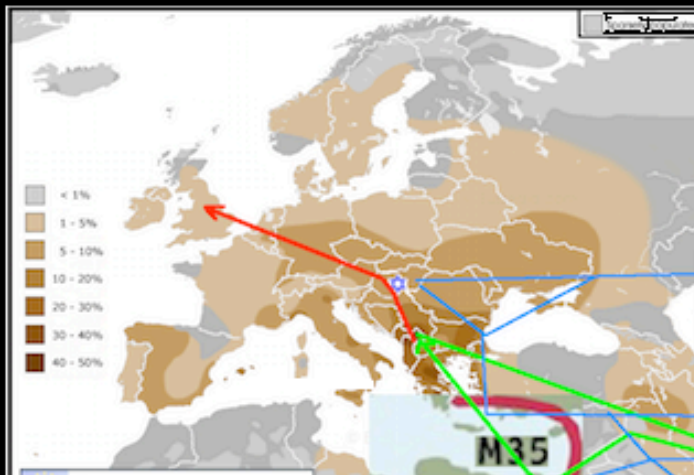

Eupedia map of Y-haplogroup E-V13

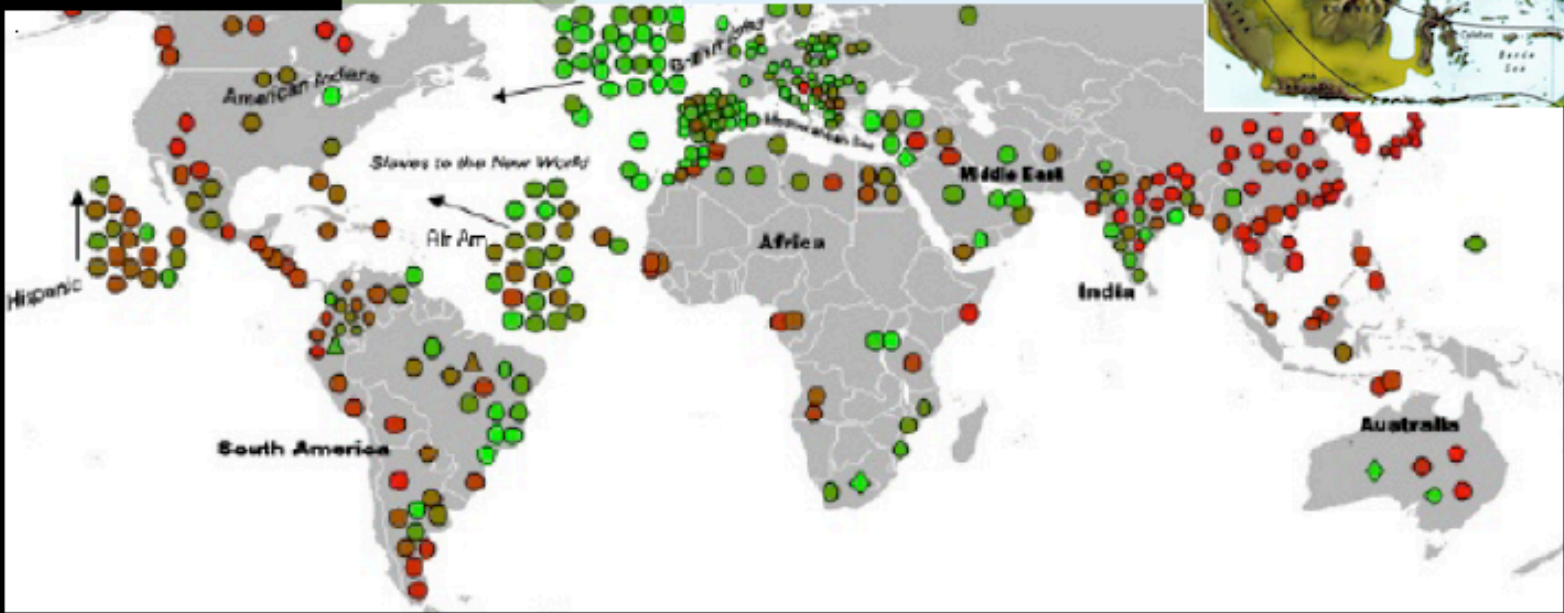

November 2018

Sunday	Monday	Tuesday	Wednesday	Thursday	Friday	Saturday
				1	2	3
4 Daylight Savings Ends	5	6	7	8	9	10
11 Veterans Day	12 Veterans Day (Observed)	13	14	15	16	17
18	19	20	21	22 Thanksgiving	23	24
25	26	27	28	29	30	

Cl(8) that contains 28 = D4 for NCG M Gravity	Cl(8) that contains 28 = D4 for NCG F SM	1
		16
		120
		560
		1820
		4368
		8008
		11440
1	1	12870
8	8	11440
28	28	8008
56	56	4368
70 x 70 =		1820 = D8
56	56	560
28	28	120 = D8
8	8	16
1	1	1
$Cl(8) \times Cl(8) = Cl(16)$		

NJL Quantum Condensate

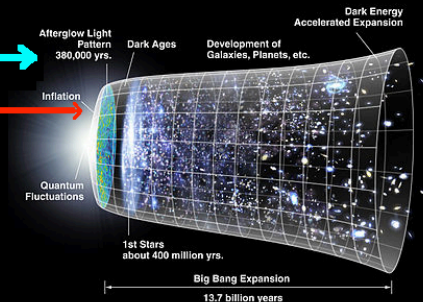

10¹⁹ E8 Lattice 240-vertex Polytope Cells in Universe at End of Inflation

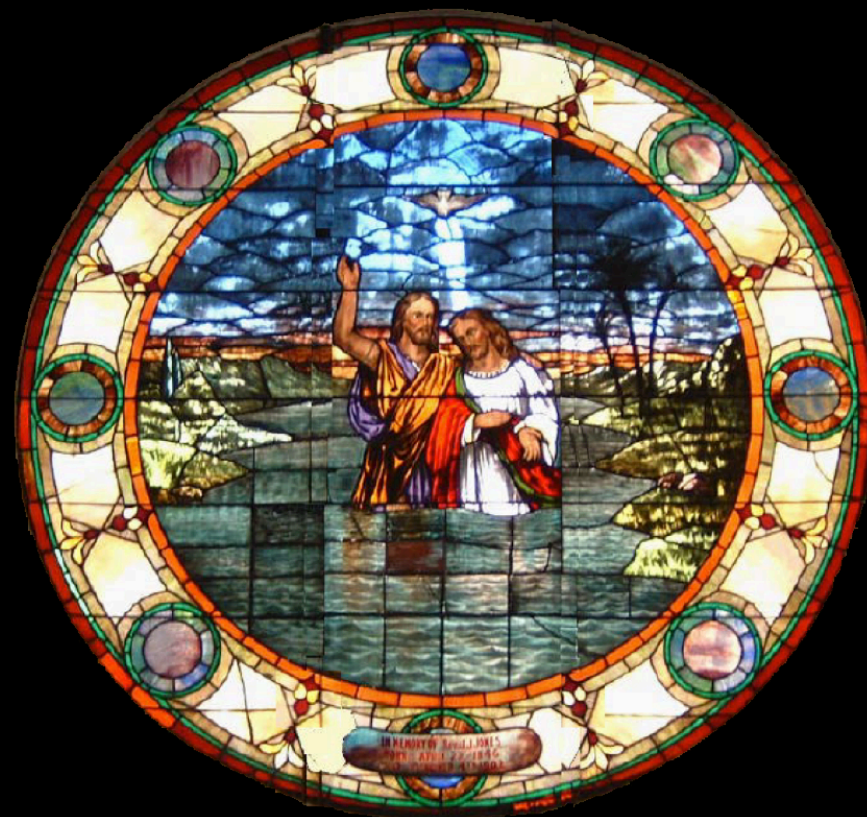

Quantum Resonant Connection

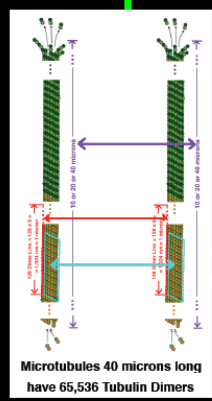

Penrose-Hameroff Quantum Condensate

10¹⁹ Tubulin Dimers in a Human Brain

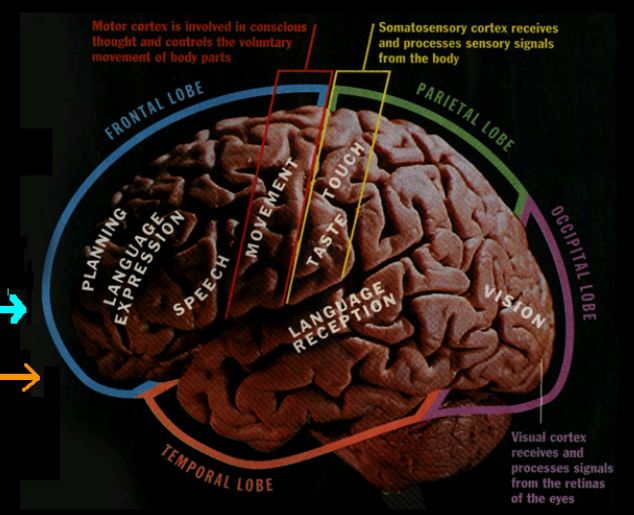

December 2018

Sunday	Monday	Tuesday	Wednesday	Thursday	Friday	Saturday
						1
2 Hanukkah	3	4	5	6	7	8
9	10	11	12	13	14	15
16	17	18	19	20	21 Winter Begins	22
23	24	25	26	27	28	29
30	31	Christmas Day	Kwanzaa			

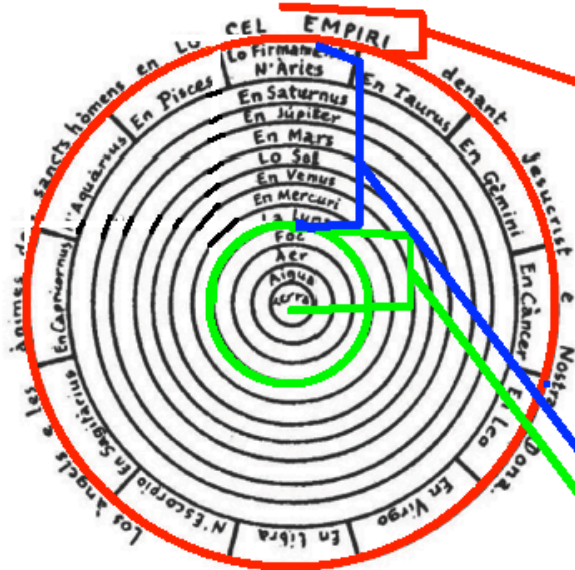
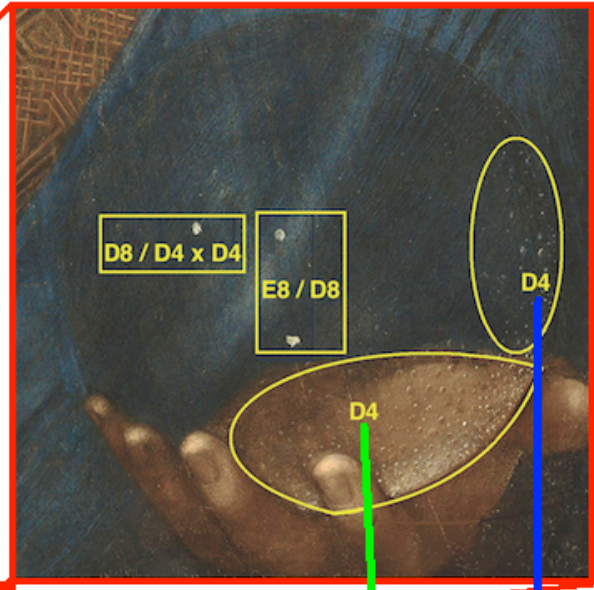
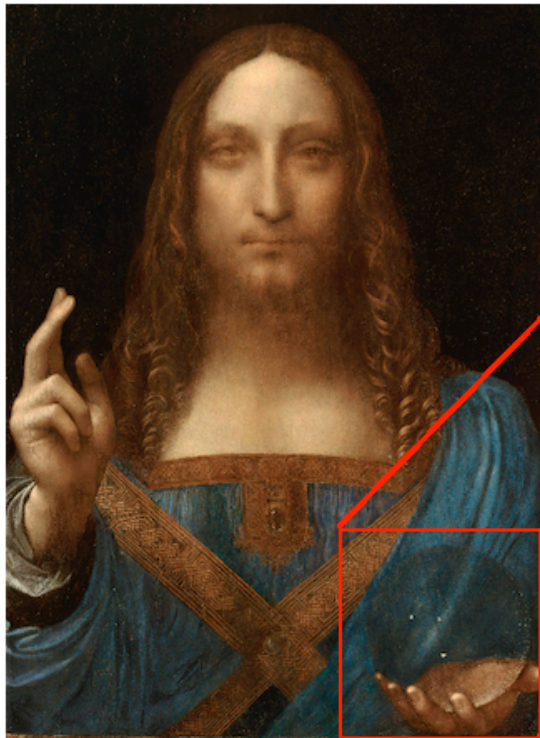

E8

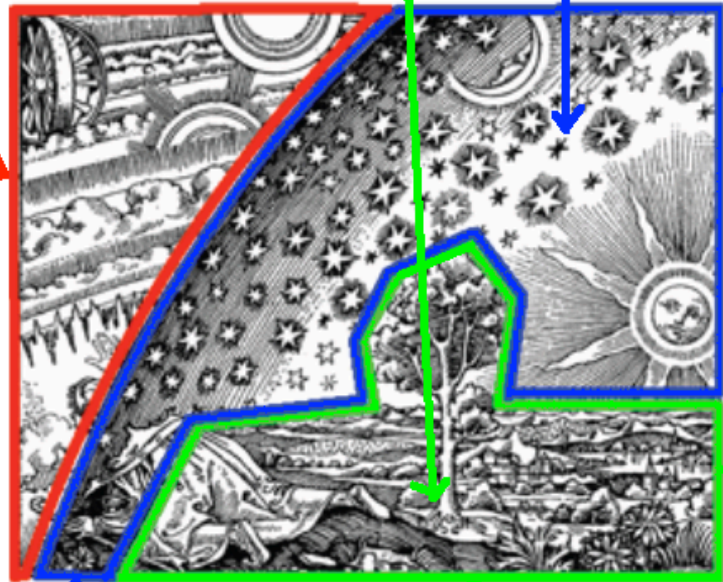

January 2019 (United States)

February 2019

S	M	T	W	T	F	S
					1	2
3	4	5	6	7	8	9
10	11	12	13	14	15	16
17	18	19	20	21	22	23
24	25	26	27	28		

Sun	Mon	Tue	Wed	Thu	Fri	Sat
30	31	1 New Year's Day	2	3	4	5 ● New Moon
6	7	8	9	10	11	12
13	14 ● 1st Quarter	15	16	17	18	19
20	21 Martin Luther King Jr. Day Tu Bishvat/Tu B'Shevat ○ Full Moon	22	23	24	25	26
27 ● 3rd Quarter	28	29	30	31	1	2

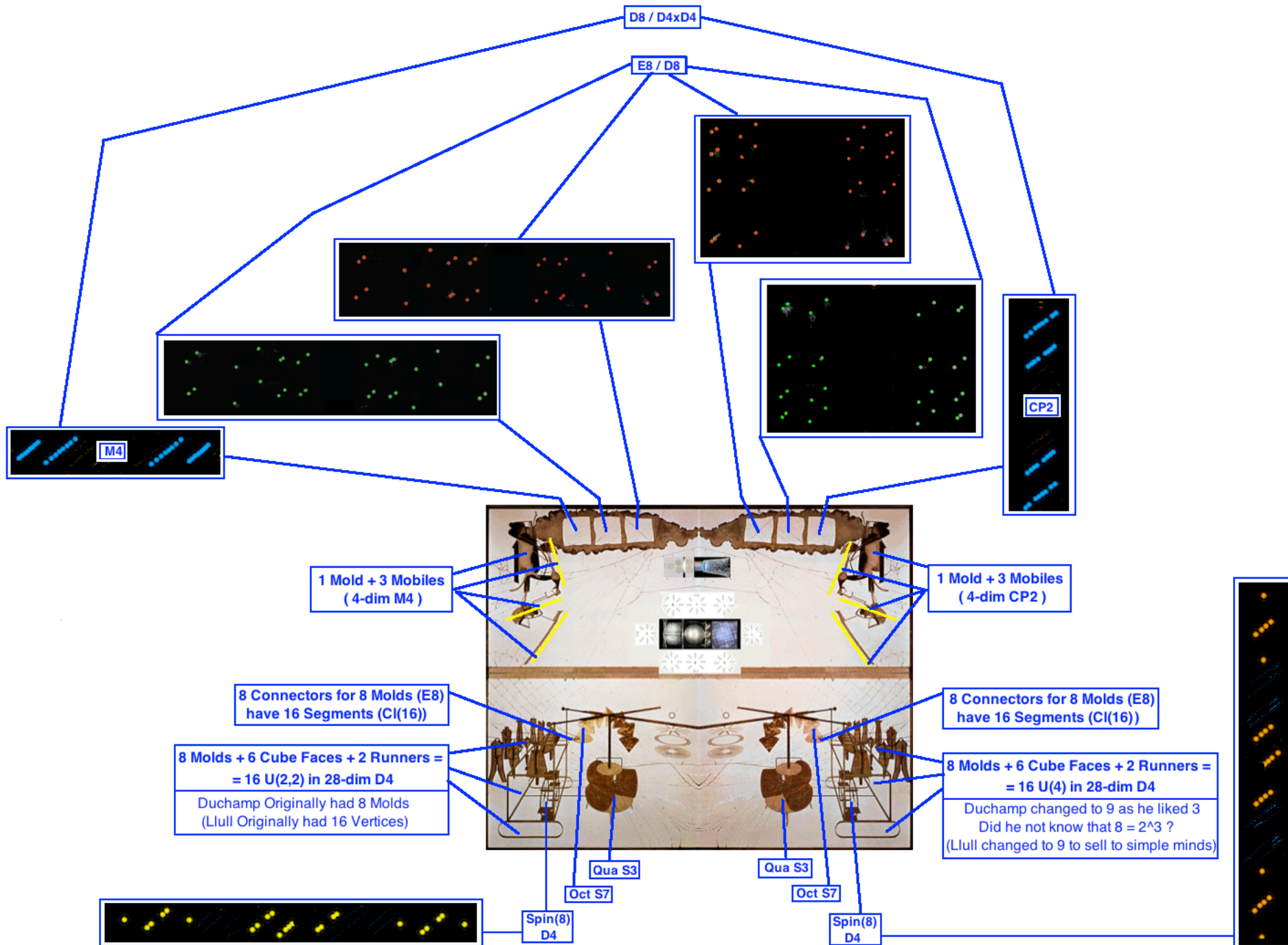

February 2019 (United States)

March 2019

S	M	T	W	T	F	S
					1	2
3	4	5	6	7	8	9
10	11	12	13	14	15	16
17	18	19	20	21	22	23
24	25	26	27	28	29	30
31						

Sun	Mon	Tue	Wed	Thu	Fri	Sat
27 ☾ 3rd Quarter	28	29	30	31	1	2
3	4 ● New Moon	5	6	7	8	9
10	11	12 ☽ 1st Quarter	13	14	15	16
17	18 🇺🇸 Presidents' Day	19 ☽ Full Moon	20	21	22	23
24	25	26 ☾ 3rd Quarter	27	28	1	2

Alien Mind

Big Bang - Inflation - - Conformal Evolution

E8 240 - 2160 - - 17520 = 240 + 8x2160

Alien Eyes
1
36
6
60





1+6 = 7 of S7
36x60 = 2160 = E8 Layer 2

Alien LGL+LGL Body

March 2019 (United States)

April 2019

S	M	T	W	T	F	S
	1	2	3	4	5	6
7	8	9	10	11	12	13
14	15	16	17	18	19	20
21	22	23	24	25	26	27
28	29	30				

Sun	Mon	Tue	Wed	Thu	Fri	Sat
24	25	26  3rd Quarter	27	28	1	2
3	4	5	6  New Moon	7	8	9
10	11	12	13	14  1st Quarter	15	16
17	18	19	20 <small>March equinox</small>  Full Moon	21 <small>Purim</small>	22	23
24	25	26	27	28  3rd Quarter	29	30
31	1	2	3 <small>Isra and Mi'raj</small>	4	5  New Moon	6

Vega = North Star:
 11600 BP - Vela X
 Manetho Rule of Mortal Humans
 37000 BP - Geminga
 Wisconsin Glaciation
 Manetho Rule of Gods

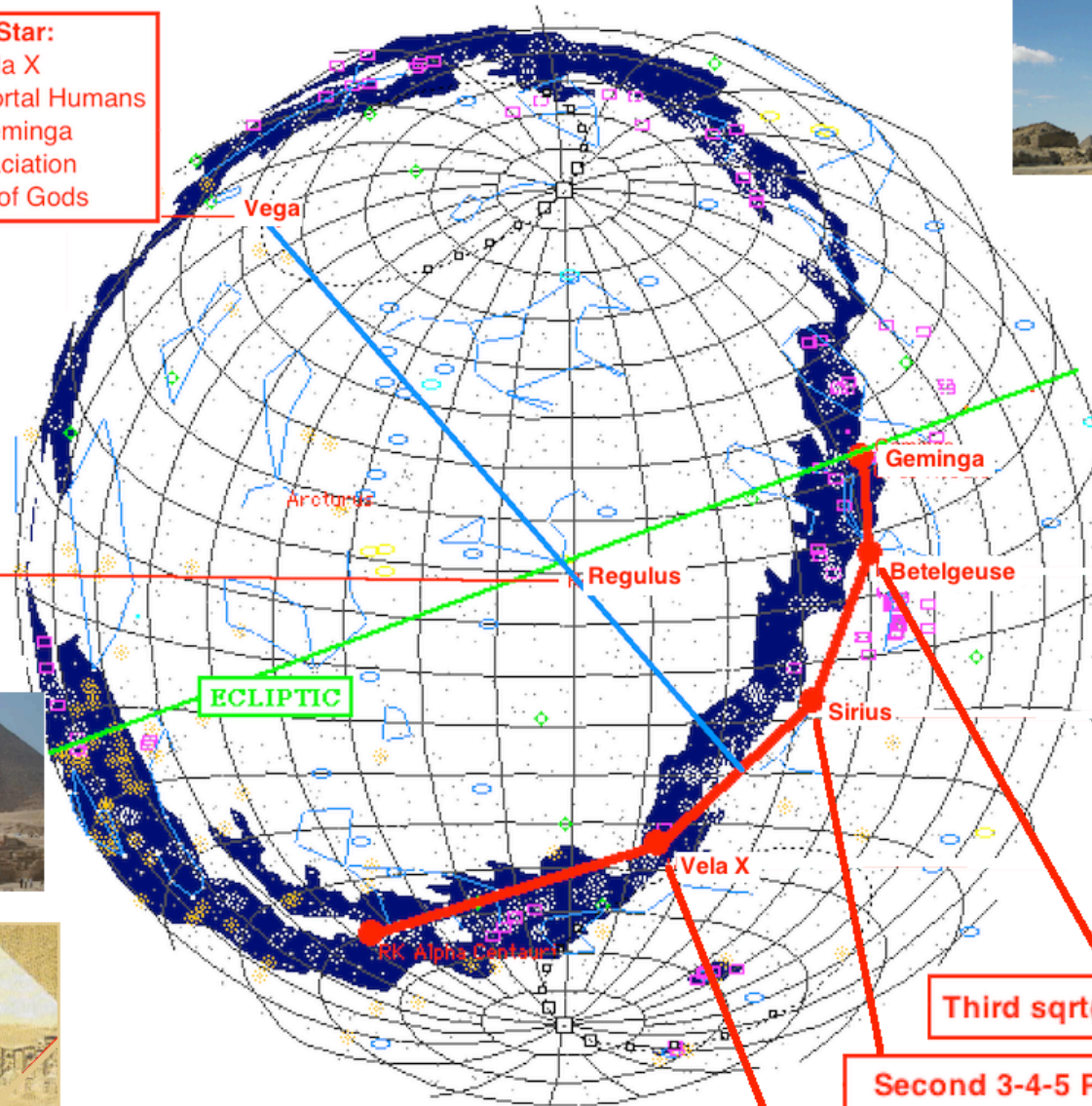
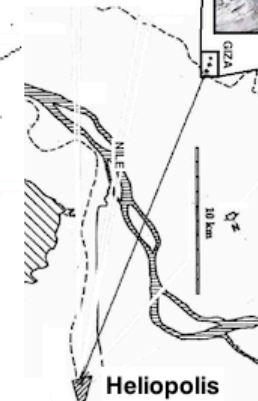
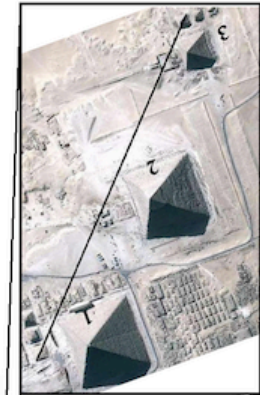

Third $\sqrt{2} \times 10/9$ Pyramid

Second 3-4-5 Pyramid

Great Golden CI(8) Pyramid

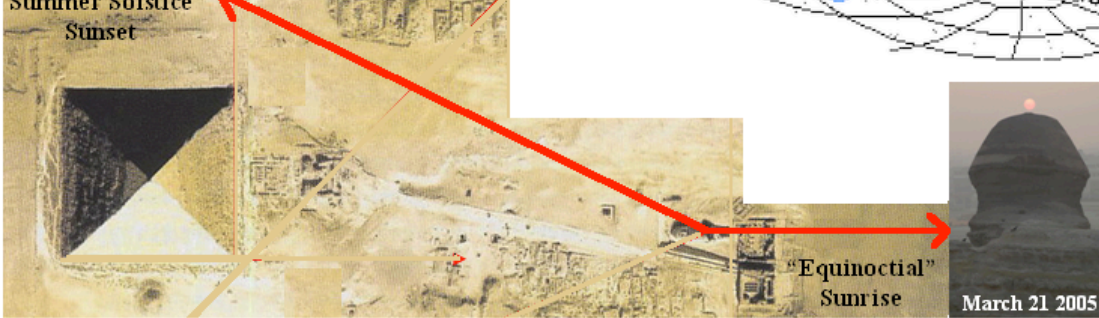

April 2019 (United States)

May 2019

S	M	T	W	T	F	S
			1	2	3	4
5	6	7	8	9	10	11
12	13	14	15	16	17	18
19	20	21	22	23	24	25
26	27	28	29	30	31	

Sun	Mon	Tue	Wed	Thu	Fri	Sat
31	1	2	3 <small>Isra and Mi'raj</small>	4	5 <small>● New Moon</small>	6
7	8	9	10	11	12 <small>☾ 1st Quarter</small>	13
14	15	16	17	18	19 <small>Good Friday (Many regions) ○ Full Moon</small>	20 <small>Passover (first day)</small>
21 <small>Easter Sunday</small>	22 <small>Easter Monday</small>	23	24	25	26 <small>☾ 3rd Quarter</small>	27 <small>Last Day of Passover</small>
28	29	30	1 <small>Yom HaShoah</small>	2	3	4 <small>● New Moon</small>

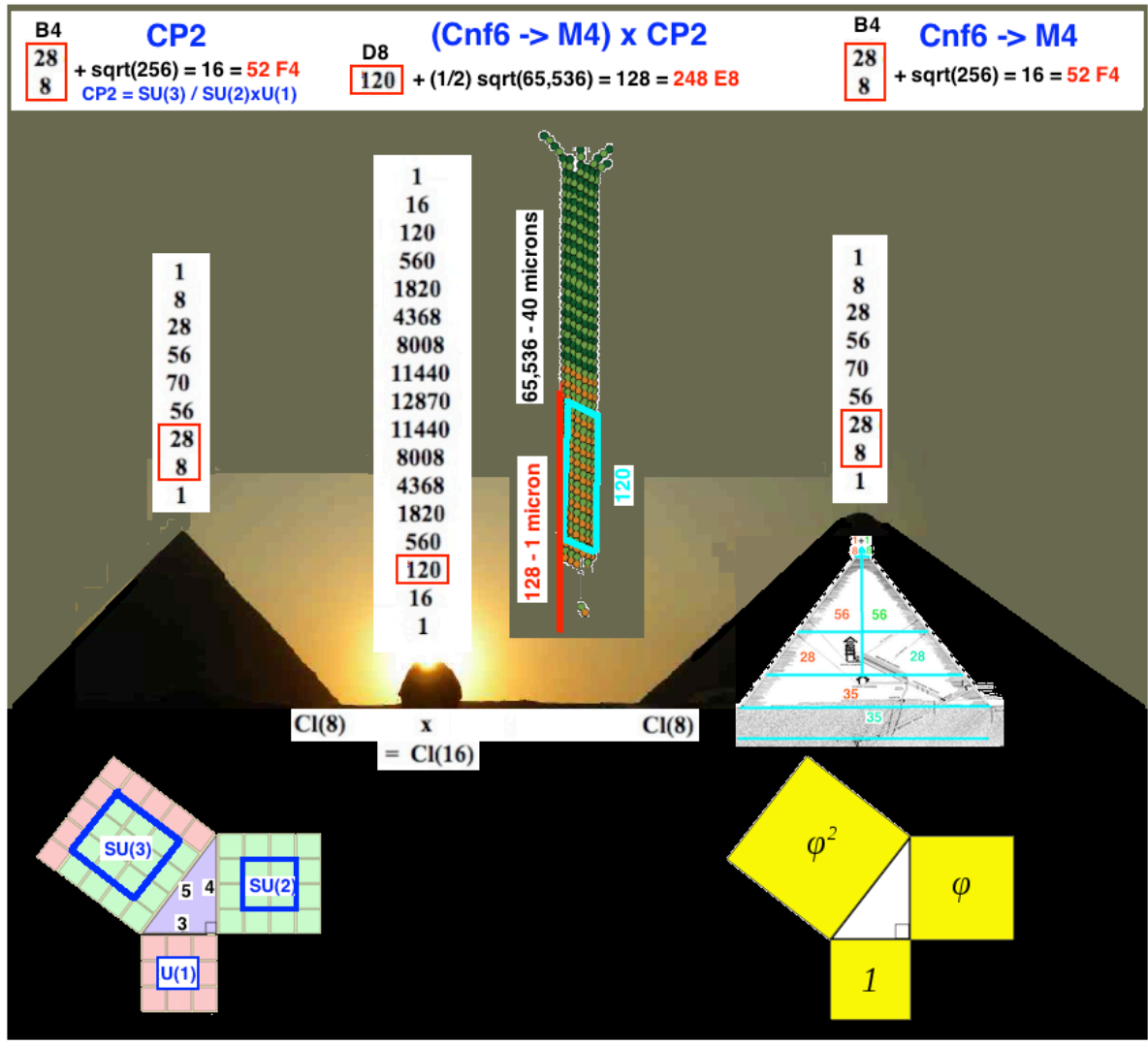

52-dim F4 of CP2 in 256-dim CI(8)

F4 / B4 = OP2 = Spinor Fermions = 8 Particles + 8 AntiParticles
 B4 / D4 = 8-dim SpaceTime = Kaluza-Klein M4 x CP2
 D4 = Spin(8) contains Spin(6) = SU(4) contains SU(3) Color Force
 SU(3) Color Force = Global Symmetry of CP2 = SU(3) / SU(2)xU(1)
 SU(2)xU(1) ElectroWeak Force = Local Symmetry of CP2

52-dim F4 of Cnf6 -> M4 in 256-dim CI(8)

F4 / B4 = OP2 = Spinor Fermions = 8 Particles + 8 AntiParticles
 B4 / D4 = 8-dim SpaceTime = Kaluza-Klein M4 x CP2
 D4 = Spin(4,4) contains Spin(2,4) of Conformal Gravity + Dark Energy



E8 Kaluza-Klein (Cnf6 -> M4) x CP2

In (CI(8) of CP2) x (CI(8) of Cnf6 -> M4) = CI(16) containing E8
 at each of the 256 points of CI(8) of Cnf6 -> M4 there are all 256 points of CI(8) of CP2

E8 / D8 = 128-dim Fermion Spinor Space = 8 components of 8+8 Fermions
 D8 / D4 x D4 = A7+1 = 64 = 8-dim position x 8-dim momentum
 D4 containing D3 = Spin(2,4) = A3 = SU(2,2) for Conformal Gravity + Dark Energy
 D4 containing D3 = SU(4) containing Color Force SU(3)

256
x
256
= 65,536

May 2019 (United States)

June 2019

S	M	T	W	T	F	S
						1
2	3	4	5	6	7	8
9	10	11	12	13	14	15
16	17	18	19	20	21	22
23	24	25	26	27	28	29
30						

Sun	Mon	Tue	Wed	Thu	Fri	Sat
28	29	30	1 Yom HaShoah	2	3	4 ● New Moon
5	6 Ramadan starts	7	8	9 Yom Ha'atzmaut	10	11 ● 1st Quarter
12	13	14	15	16	17	18 ○ Full Moon
19	20	21	22	23 Lag BaOmer	24	25
26 ● 3rd Quarter	27 Memorial Day	28	29	30	31 Lailat al-Qadr	1

24-Cell D4 to Pyramid F4 to E6 Tarot to 240-Polytope E8 Giza

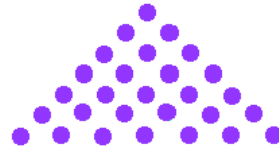
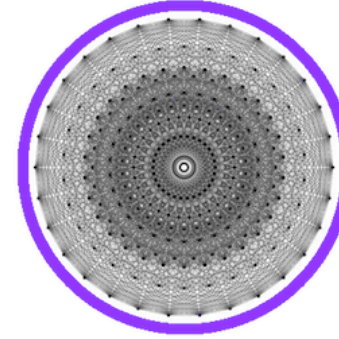
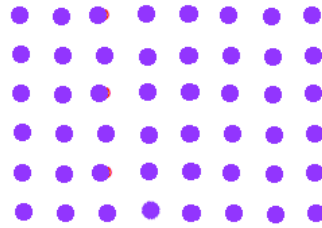
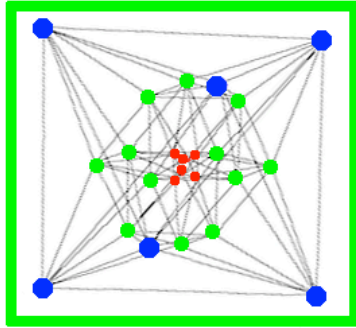

78-dim E6 = 52-dim F4 + 26-dim J(3,O)0



2 Complex Structure Elements

of 78-dim E6 are absorbed into 48+48+48+28 = 144 of 248-dim E8

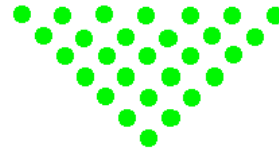

28-dim D4

52-dim F4

78-dim E6

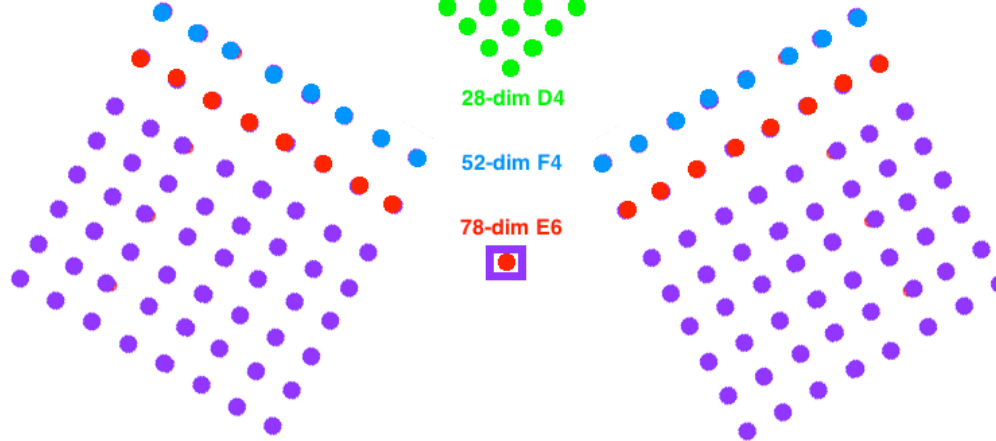

$E6 / (D5 \times U(1)) = 32$ -Real-dim Symmetric Space of Type EIII = $(C \times O)P2$
 16-Complex-dim NonCompact Dual = Type V Bounded Domain in subspace of $J(3, C \times O)$
 Shilov Boundary = Not Tube Type = 8-Complex-dim =
 = bundle with fiber $S^1 \times S^7$ and base space S^9 with fibration $S^1 \rightarrow S^9 \rightarrow CP^4$
 each fiber $S^1 \times S^7$ = Shilov Boundary for $D5 / (D4 \times U(1)) =$ Lie Sphere $RP^1 \times S^7$

Force	Hermitian symmetric space		M	Vol(M)	D	Vol(D)		Qforce	Vol(Q)	
gravity	Spin(5)	Spin(7) / Spin(5) x U(1)	S^4	$8\pi^2/3$	IV5	$\pi^5/2^4$	5!	4	$RP^1 \times S^4$	$8\pi^3/3$
color	SU(3)	SU(4) / SU(3) x U(1)	CP^2	$8\pi^2/3$	B^6(ball)	$\pi^3/6$		4	S^5	$4\pi^3$
Weak	SU(2)	Spin(5) / SU(2) x U(1)	$S^2 \times S^2$	$2 \times 4\pi$	IV3	$\pi^3/24$		2	$RP^1 \times S^2$	$4\pi^2$
e-mag	U(1)	-	T^4	$4 \times 2\pi$	-	-		1	-	-

June 2019 (United States)

July 2019

S	M	T	W	T	F	S
	1	2	3	4	5	6
7	8	9	10	11	12	13
14	15	16	17	18	19	20
21	22	23	24	25	26	27
28	29	30	31			

Sun	Mon	Tue	Wed	Thu	Fri	Sat
26 🌑 3rd Quarter	27 Memorial Day	28	29	30	31 Lailat al-Qadr	1
2	3 🌑 New Moon	4	5 Eid al-Fitr	6	7	8
9 Shavuot	10 🌒 1st Quarter	11	12	13	14	15
16	17 🌕 Full Moon	18	19	20	21 June Solstice	22
23	24	25 🌑 3rd Quarter	26	27	28	29
30	1	2 🌑 New Moon	3	4 Independence Day	5	6

Ramon Llull Wheels:

Tensor Product $RxCxHxO = T = 64\text{-dim} =$

The Figures of the One				The Figures of the Incident			
One	Two	Three	Four	One	Two	Three	Four
Two	Three	Four	Five	Two	Three	Four	Five
Three	Four	Five	Six	Three	Four	Five	Six
Four	Five	Six	Seven	Four	Five	Six	Seven
Five	Six	Seven	Eight	Five	Six	Seven	Eight
Six	Seven	Eight	Nine	Six	Seven	Eight	Nine
Seven	Eight	Nine	Ten	Seven	Eight	Nine	Ten
Eight	Nine	Ten	Eleven	Eight	Nine	Ten	Eleven
Nine	Ten	Eleven	Twelve	Nine	Ten	Eleven	Twelve
Twelve	Thirteen	Fourteen	Fifteen	Twelve	Thirteen	Fourteen	Fifteen
Thirteen	Fourteen	Fifteen	Sixteen	Thirteen	Fourteen	Fifteen	Sixteen
Fourteen	Fifteen	Sixteen	Seventeen	Fourteen	Fifteen	Sixteen	Seventeen
Fifteen	Sixteen	Seventeen	Eighteen	Fifteen	Sixteen	Seventeen	Eighteen
Sixteen	Seventeen	Eighteen	Nineteen	Sixteen	Seventeen	Eighteen	Nineteen
Seventeen	Eighteen	Nineteen	Twenty	Seventeen	Eighteen	Nineteen	Twenty
Eighteen	Nineteen	Twenty	Twenty-one	Eighteen	Nineteen	Twenty	Twenty-one
Nineteen	Twenty	Twenty-one	Twenty-two	Nineteen	Twenty	Twenty-one	Twenty-two
Twenty	Twenty-one	Twenty-two	Twenty-three	Twenty	Twenty-one	Twenty-two	Twenty-three
Twenty-one	Twenty-two	Twenty-three	Twenty-four	Twenty-one	Twenty-two	Twenty-three	Twenty-four
Twenty-two	Twenty-three	Twenty-four	Twenty-five	Twenty-two	Twenty-three	Twenty-four	Twenty-five
Twenty-three	Twenty-four	Twenty-five	Twenty-six	Twenty-three	Twenty-four	Twenty-five	Twenty-six
Twenty-four	Twenty-five	Twenty-six	Twenty-seven	Twenty-four	Twenty-five	Twenty-six	Twenty-seven
Twenty-five	Twenty-six	Twenty-seven	Twenty-eight	Twenty-five	Twenty-six	Twenty-seven	Twenty-eight
Twenty-six	Twenty-seven	Twenty-eight	Twenty-nine	Twenty-six	Twenty-seven	Twenty-eight	Twenty-nine
Twenty-seven	Twenty-eight	Twenty-nine	Thirty	Twenty-seven	Twenty-eight	Twenty-nine	Thirty
Twenty-eight	Twenty-nine	Thirty	Thirty-one	Twenty-eight	Twenty-nine	Thirty	Thirty-one
Twenty-nine	Thirty	Thirty-one	Thirty-two	Twenty-nine	Thirty	Thirty-one	Thirty-two
Thirty	Thirty-one	Thirty-two	Thirty-three	Thirty	Thirty-one	Thirty-two	Thirty-three
Thirty-one	Thirty-two	Thirty-three	Thirty-four	Thirty-one	Thirty-two	Thirty-three	Thirty-four
Thirty-two	Thirty-three	Thirty-four	Thirty-five	Thirty-two	Thirty-three	Thirty-four	Thirty-five
Thirty-three	Thirty-four	Thirty-five	Thirty-six	Thirty-three	Thirty-four	Thirty-five	Thirty-six
Thirty-four	Thirty-five	Thirty-six	Thirty-seven	Thirty-four	Thirty-five	Thirty-six	Thirty-seven
Thirty-five	Thirty-six	Thirty-seven	Thirty-eight	Thirty-five	Thirty-six	Thirty-seven	Thirty-eight
Thirty-six	Thirty-seven	Thirty-eight	Thirty-nine	Thirty-six	Thirty-seven	Thirty-eight	Thirty-nine
Thirty-seven	Thirty-eight	Thirty-nine	Forty	Thirty-seven	Thirty-eight	Thirty-nine	Forty
Thirty-eight	Thirty-nine	Forty	Forty-one	Thirty-eight	Thirty-nine	Forty	Forty-one
Thirty-nine	Forty	Forty-one	Forty-two	Thirty-nine	Forty	Forty-one	Forty-two
Forty	Forty-one	Forty-two	Forty-three	Forty	Forty-one	Forty-two	Forty-three
Forty-one	Forty-two	Forty-three	Forty-four	Forty-one	Forty-two	Forty-three	Forty-four
Forty-two	Forty-three	Forty-four	Forty-five	Forty-two	Forty-three	Forty-four	Forty-five
Forty-three	Forty-four	Forty-five	Forty-six	Forty-three	Forty-four	Forty-five	Forty-six
Forty-four	Forty-five	Forty-six	Forty-seven	Forty-four	Forty-five	Forty-six	Forty-seven
Forty-five	Forty-six	Forty-seven	Forty-eight	Forty-five	Forty-six	Forty-seven	Forty-eight
Forty-six	Forty-seven	Forty-eight	Forty-nine	Forty-six	Forty-seven	Forty-eight	Forty-nine
Forty-seven	Forty-eight	Forty-nine	Fifty	Forty-seven	Forty-eight	Forty-nine	Fifty
Forty-eight	Forty-nine	Fifty	Fifty-one	Forty-eight	Forty-nine	Fifty	Fifty-one
Forty-nine	Fifty	Fifty-one	Fifty-two	Forty-nine	Fifty	Fifty-one	Fifty-two
Fifty	Fifty-one	Fifty-two	Fifty-three	Fifty	Fifty-one	Fifty-two	Fifty-three
Fifty-one	Fifty-two	Fifty-three	Fifty-four	Fifty-one	Fifty-two	Fifty-three	Fifty-four
Fifty-two	Fifty-three	Fifty-four	Fifty-five	Fifty-two	Fifty-three	Fifty-four	Fifty-five
Fifty-three	Fifty-four	Fifty-five	Fifty-six	Fifty-three	Fifty-four	Fifty-five	Fifty-six
Fifty-four	Fifty-five	Fifty-six	Fifty-seven	Fifty-four	Fifty-five	Fifty-six	Fifty-seven
Fifty-five	Fifty-six	Fifty-seven	Fifty-eight	Fifty-five	Fifty-six	Fifty-seven	Fifty-eight
Fifty-six	Fifty-seven	Fifty-eight	Fifty-nine	Fifty-six	Fifty-seven	Fifty-eight	Fifty-nine
Fifty-seven	Fifty-eight	Fifty-nine	Sixty	Fifty-seven	Fifty-eight	Fifty-nine	Sixty
Fifty-eight	Fifty-nine	Sixty	Sixty-one	Fifty-eight	Fifty-nine	Sixty	Sixty-one
Fifty-nine	Sixty	Sixty-one	Sixty-two	Fifty-nine	Sixty	Sixty-one	Sixty-two
Sixty	Sixty-one	Sixty-two	Sixty-three	Sixty	Sixty-one	Sixty-two	Sixty-three
Sixty-one	Sixty-two	Sixty-three	Sixty-four	Sixty-one	Sixty-two	Sixty-three	Sixty-four
Sixty-two	Sixty-three	Sixty-four	Sixty-five	Sixty-two	Sixty-three	Sixty-four	Sixty-five
Sixty-three	Sixty-four	Sixty-five	Sixty-six	Sixty-three	Sixty-four	Sixty-five	Sixty-six
Sixty-four	Sixty-five	Sixty-six	Sixty-seven	Sixty-four	Sixty-five	Sixty-six	Sixty-seven
Sixty-five	Sixty-six	Sixty-seven	Sixty-eight	Sixty-five	Sixty-six	Sixty-seven	Sixty-eight
Sixty-six	Sixty-seven	Sixty-eight	Sixty-nine	Sixty-six	Sixty-seven	Sixty-eight	Sixty-nine
Sixty-seven	Sixty-eight	Sixty-nine	Seventy	Sixty-seven	Sixty-eight	Sixty-nine	Seventy
Sixty-eight	Sixty-nine	Seventy	Seventy-one	Sixty-eight	Sixty-nine	Seventy	Seventy-one
Sixty-nine	Seventy	Seventy-one	Seventy-two	Sixty-nine	Seventy	Seventy-one	Seventy-two
Seventy	Seventy-one	Seventy-two	Seventy-three	Seventy	Seventy-one	Seventy-two	Seventy-three
Seventy-one	Seventy-two	Seventy-three	Seventy-four	Seventy-one	Seventy-two	Seventy-three	Seventy-four
Seventy-two	Seventy-three	Seventy-four	Seventy-five	Seventy-two	Seventy-three	Seventy-four	Seventy-five
Seventy-three	Seventy-four	Seventy-five	Seventy-six	Seventy-three	Seventy-four	Seventy-five	Seventy-six
Seventy-four	Seventy-five	Seventy-six	Seventy-seven	Seventy-four	Seventy-five	Seventy-six	Seventy-seven
Seventy-five	Seventy-six	Seventy-seven	Seventy-eight	Seventy-five	Seventy-six	Seventy-seven	Seventy-eight
Seventy-six	Seventy-seven	Seventy-eight	Seventy-nine	Seventy-six	Seventy-seven	Seventy-eight	Seventy-nine
Seventy-seven	Seventy-eight	Seventy-nine	Eighty	Seventy-seven	Seventy-eight	Seventy-nine	Eighty
Seventy-eight	Seventy-nine	Eighty	Eighty-one	Seventy-eight	Seventy-nine	Eighty	Eighty-one
Seventy-nine	Eighty	Eighty-one	Eighty-two	Seventy-nine	Eighty	Eighty-one	Eighty-two
Eighty	Eighty-one	Eighty-two	Eighty-three	Eighty	Eighty-one	Eighty-two	Eighty-three
Eighty-one	Eighty-two	Eighty-three	Eighty-four	Eighty-one	Eighty-two	Eighty-three	Eighty-four
Eighty-two	Eighty-three	Eighty-four	Eighty-five	Eighty-two	Eighty-three	Eighty-four	Eighty-five
Eighty-three	Eighty-four	Eighty-five	Eighty-six	Eighty-three	Eighty-four	Eighty-five	Eighty-six
Eighty-four	Eighty-five	Eighty-six	Eighty-seven	Eighty-four	Eighty-five	Eighty-six	Eighty-seven
Eighty-five	Eighty-six	Eighty-seven	Eighty-eight	Eighty-five	Eighty-six	Eighty-seven	Eighty-eight
Eighty-six	Eighty-seven	Eighty-eight	Eighty-nine	Eighty-six	Eighty-seven	Eighty-eight	Eighty-nine
Eighty-seven	Eighty-eight	Eighty-nine	Ninety	Eighty-seven	Eighty-eight	Eighty-nine	Ninety
Eighty-eight	Eighty-nine	Ninety	Ninety-one	Eighty-eight	Eighty-nine	Ninety	Ninety-one
Eighty-nine	Ninety	Ninety-one	Ninety-two	Eighty-nine	Ninety	Ninety-one	Ninety-two
Ninety	Ninety-one	Ninety-two	Ninety-three	Ninety	Ninety-one	Ninety-two	Ninety-three
Ninety-one	Ninety-two	Ninety-three	Ninety-four	Ninety-one	Ninety-two	Ninety-three	Ninety-four
Ninety-two	Ninety-three	Ninety-four	Ninety-five	Ninety-two	Ninety-three	Ninety-four	Ninety-five
Ninety-three	Ninety-four	Ninety-five	Ninety-six	Ninety-three	Ninety-four	Ninety-five	Ninety-six
Ninety-four	Ninety-five	Ninety-six	Ninety-seven	Ninety-four	Ninety-five	Ninety-six	Ninety-seven
Ninety-five	Ninety-six	Ninety-seven	Ninety-eight	Ninety-five	Ninety-six	Ninety-seven	Ninety-eight
Ninety-six	Ninety-seven	Ninety-eight	Ninety-nine	Ninety-six	Ninety-seven	Ninety-eight	Ninety-nine
Ninety-seven	Ninety-eight	Ninety-nine	One hundred	Ninety-seven	Ninety-eight	Ninety-nine	One hundred

$T + T = 128\text{-dim} = E8 / D8$

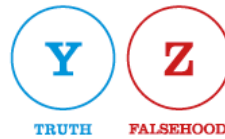

Binary Real Clifford Algebras of tensor product $Cl(8) \times Cl(8) = Cl(16)$

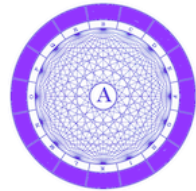

120-dim D8 and $E8 / D8 = (OxO)P2$

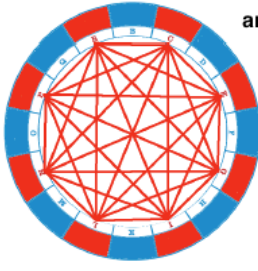

28-dim D4

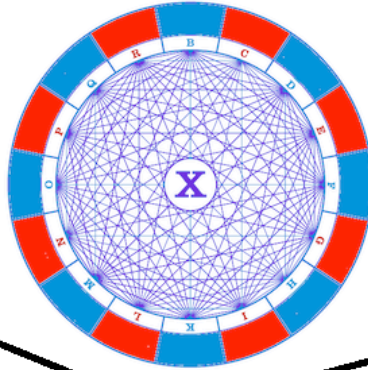

120-dim D8

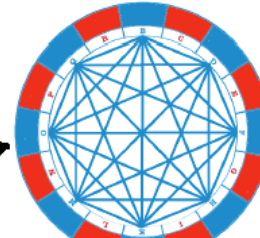

28-dim D4

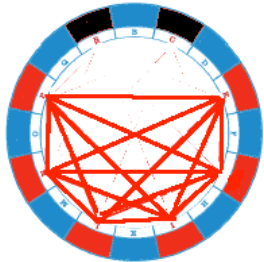

15-dim Spin(2,4)

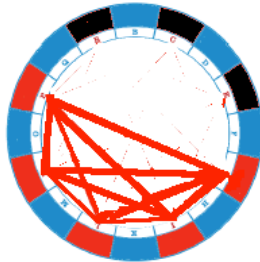

10-dim Spin(2,3)

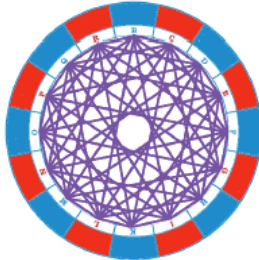

64-dim A7+R

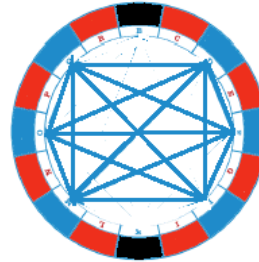

15-dim SU(4)

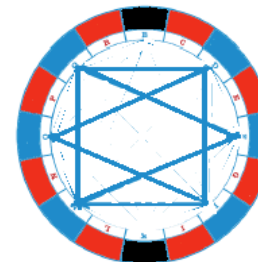

8-dim SU(3)

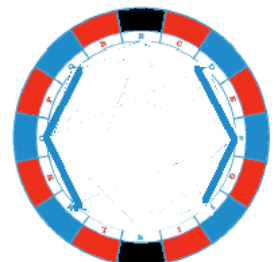

4-dim SU(2)xU(1)

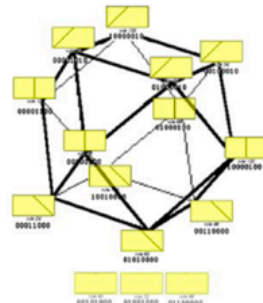
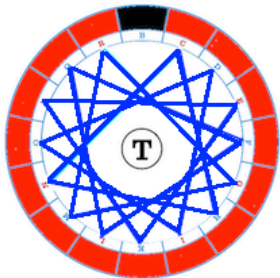

3 = Cartan Subalgebra $D3 = A3$

4 x 3 = Cuboctahedron Vertices $D3 = A3$

$D3 = A3$ acts Conformally on $M4$ of $M4 \times CP2$ Kaluza-Klein

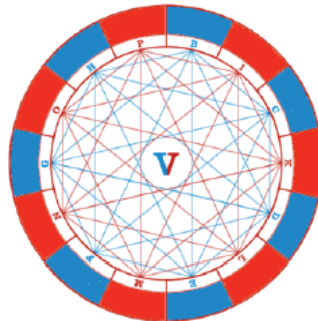

42 Assessors = 21-dim Spin(7) + 21-dim Spin(7)
Zero Divisors of Sedenions

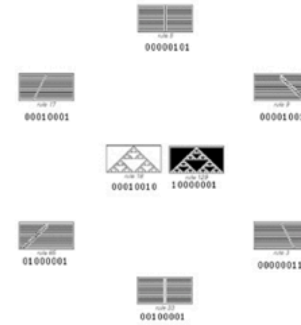

4 + 4 = Cube Vertices = $A2 = SU(3)$ of $CP2 = SU(3) / SU(2)xU(1)$

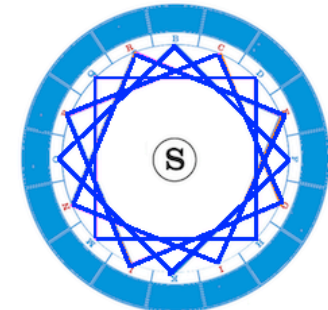

4 = $CP2$ of $M4 \times CP2$ Kaluza-Klein
4 = $SU(2)xU(1)$ of $CP2 = SU(3) / SU(2)xU(1)$

July 2019 (United States)

August 2019

S	M	T	W	T	F	S
				1	2	3
4	5	6	7	8	9	10
11	12	13	14	15	16	17
18	19	20	21	22	23	24
25	26	27	28	29	30	31

Sun	Mon	Tue	Wed	Thu	Fri	Sat
30	1	2 ● New Moon	3	4 Independence Day	5	6
7	8	9 ● 1st Quarter	10	11	12	13
14	15	16 ○ Full Moon	17	18	19	20
21	22	23	24 ● 3rd Quarter	25	26	27
28	29	30	31 ● New Moon	1	2	3

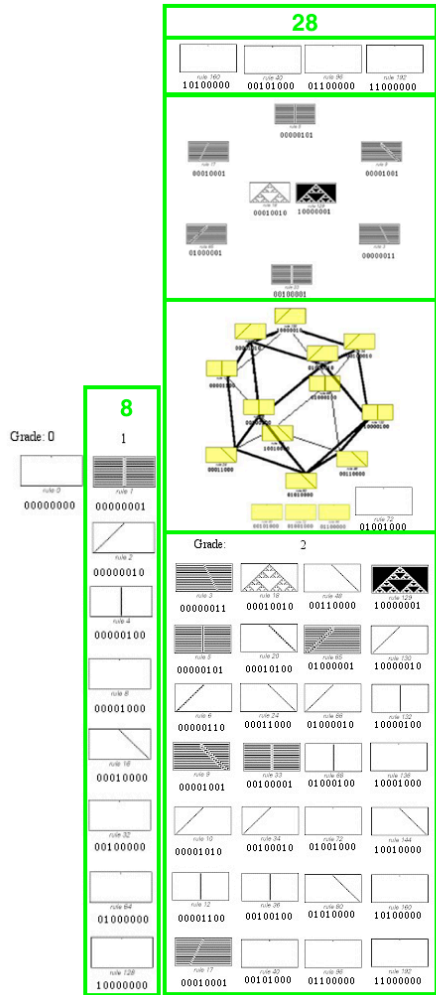

$$8+28+16 = 52 \text{ F4}$$

256-dim Cl(8) as Cellular Automata

16

Cl(8) Primitive Idempotent has 16 Terms

$$I = (1/2)(1 + e_{1248}) (1/2)(1 + e_{2358}) (1/2)(1 + e_{3468}) (1/2)(1 + e_{4578}) =$$

$$= (1/16)(1 + e_{1248} + e_{2358} + e_{3468} + e_{4578} + e_{5618} + e_{6728} + e_{7138} - e_{3567} - e_{4671} - e_{5712} - e_{6123} - e_{7234} - e_{1345} - e_{2456} + e_J)$$

corresponding to 16 of the 256 Cellular Automata

- + e_{12345678} 11111111
- + e_{6728} + e_{3468} + e_{4578} to 11100010 10101100 11012008
- + e_{2358} + e_{1248} + e_{5618} + e_{7138} 10010110 10031011 10117001 11000101
- + 1 to 00000000
- - e_{5712} - e_{1345} - e_{6123} 01010011 00011101 00100011
- - e_{4671} - e_{7234} - e_{2456} - e_{3567} 01101001 01001110 00111010 01110100

Tensor Product Cl(8) x Cl(8) = Cl(16)

$$(F4 \text{ in } Cl(8)) \times (F4 \text{ in } Cl(8)) =$$

$$= 8 \times 8 + 28 \times 1 + 1 \times 28 + 16 \times 16 =$$

$$= 120 \text{ Cl(16) BiVectors} + (128 + 128) \text{ Cl(16) Spinors}$$

$$120 \text{ Cl(16) BiVectors} + 128 \text{ Cl(16) Half-Spinors} = E8$$

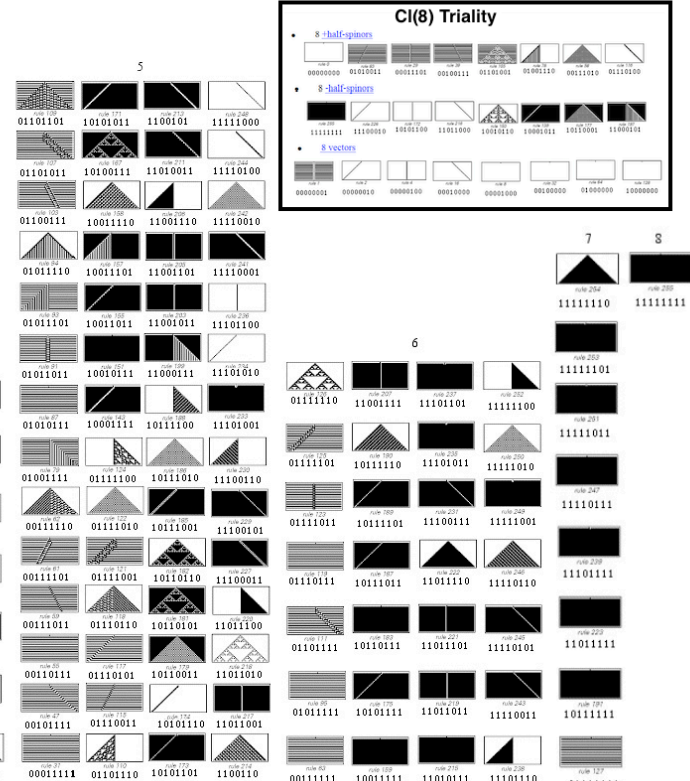
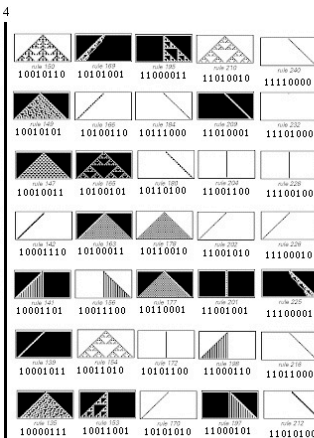
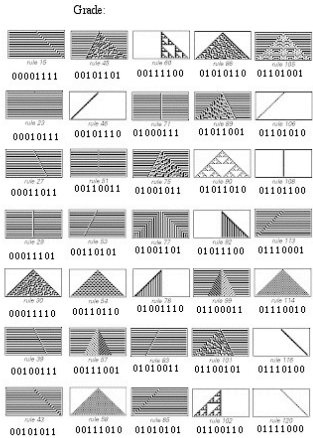
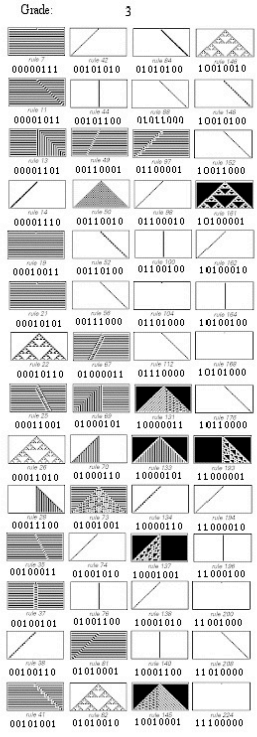

Guillermo Moreno (arXiv/math/0512517) has shown that $V(7,2) = \text{Spin}(7) / \text{Spin}(5)$ can be identified with the **Zero Divisors of Sedenions** which have $7+28 = 35$ Associative Triples and for which Zero Divisors are given by the fibration $V(7,2) \rightarrow G_2 \rightarrow S^3$ [3-sphere] and which have 4-2=2 ZD Irreducible Components and 10-dim Lie Sphere $\text{Spin}(7) / \text{Spin}(5) \times U(1)$ whose 10D correspond to $Cl(1,9) = Cl(2,8)$ Conformal over $Cl(1,7)$ that $V(15,2) = \text{Spin}(15) / \text{Spin}(13)$ is related to, but not identified with, the **Zero Divisors of 32-ons** which have $35 + 120 = 155$ Associative Triples and which have 8-2=6 ZD Irreducible Components and 26-dim Lie Sphere $\text{Spin}(15) / \text{Spin}(13) \times U(1)$ whose 26D correspond to **26D String Theory and to 26-dim traceless $J(3,0)_0$** that $V(127,2) = \text{Spin}(127) / \text{Spin}(125)$ is related to, but not identified with, the **Zero Divisors of Voudon 256-ons** corresponding to $Cl(8)$ which have $1+6+28+120+496+2016+8128=10795$ Associative Triples and which have 64-2=62 ZD Irreducible Components and 250-dim Lie Sphere $\text{Spin}(127) / \text{Spin}(125) \times U(1)$

Robert de Marrais said "... 256 ... 2^8 ions Voudons ... Moreno ... determines that the automorphism group of the ZD's of all 2^n-ions ... obey a simple pattern: for $n \geq 4$ this group has the form $G_2 \times (n-3) \times S_3$ (... order-6 permutation group on 3 elements) ... This says the automorphism group of the Sedenions' ZD's has order $14 \times 1 \times 6 = 84$... based on 7 octahedral lattices ("Box-Kites") ...

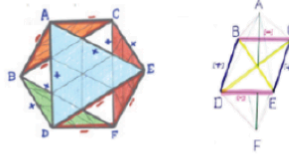

"... Harmonics of Box-Kites, called here "Kite-Chain Middens," ... extend indefinitely into higher forms of 2^n-ions. All non-Midden-collected ZD diagonals in the ... 32-ons ... belong ... to a set of 15 "emanation tables," ... they house 168 ... PSL(2,7) ... cells ... 8 ... 32-ons ... ET's ... from S = 8 to 15 ...

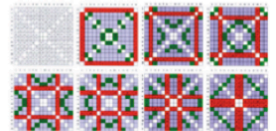

[here are] ... Emanation Tables ... ET's for S = 15, N = 5,6,7 ... and fractal limit ...



August 2019 (United States)

September 2019

S	M	T	W	T	F	S
1	2	3	4	5	6	7
8	9	10	11	12	13	14
15	16	17	18	19	20	21
22	23	24	25	26	27	28
29	30					

Sun	Mon	Tue	Wed	Thu	Fri	Sat
28	29	30	31 ● New Moon	1	2	3
4	5	6	7 ● 1st Quarter	8	9	10
11 Tisha B'Av	12 Eid al-Adha	13	14	15 ○ Full Moon	16	17
18	19	20	21	22	23 ● 3rd Quarter	24
25	26	27	28	29	30 ● New Moon	31

Julian Schwinger describes Elementary Particles  as volumes of space - Sources - whose properties are determined by Green's Functions characteristic of the volumes.

In E8 Physics any Elementary Particle is immediately surrounded by a cloud of virtual particle-antiparticle pairs similar to a Kerr-Newman Black Hole with Symmetric Space - Bounded Complex Domain - Shilov Boundary structure corresponding to its Gauge Group properties.
The Poisson Kernel - Bergman Kernel defines the Green's Function.

The initial Valence Particle is Planck scale. The number of Virtual Particles is determined by the Planck scale geometry of spacetime. The E8 model at the Planck Scale has spacetime condensing out of Clifford structures forming a Lorentz Leech lattice underlying 26-dim String Theory of World-Lines with $8 + 8 + 8 = 24$ -dim of fermion particles and antiparticles and of spacetime.
The automorphism group of one 26-dim String Theory cell modulo the Leech lattice is the Monster Group of order about 8×10^{53} . The Cloud structure comes from the 24-dim Leech lattice part of the Monster Group which is 2^{24} times the double cover of Co_1 , for an order of about 10^{26} . Due to superpositions of algebraically independent E8 Lattices the total number of Virtual particle/antiparticle pairs is about 10^{27} so the volume of the Kerr-Newman Cloud is on the order of 10^{27} x Planck scale, and its size should be about $10^{(27/3)} \times 1.6 \times 10^{(-33)} \text{ cm} = \text{roughly } 10^{(-24)} \text{ cm}$.

Each Schwinger Source particle-antiparticle pair should see (with Bohm Quantum Potential and Sarfatti Back-Reaction) the rest of our Universe in the perspective of 8×10^{53} Monster Symmetry so a Schwinger Source acting as a Jewel of Indra's Net of Schwinger Source Bohm Quantum Blockchain Physics can see $10^{27} \times 8 \times 10^{53} = 8 \times 10^{80}$ Other Sources of an Indra's Net.

To fit inside the initial Schwinger Source the Information Elements of all the Other Schwinger Sources of Our Universe (10^{77} or so) should be distributed as a Fractal Julia Set. There are 2^n stage-n cells in a Binary Decomposition of Julia Sets, so a stage-256 Julia level set based on Binary Decomposition has $2^{256} = \text{about } 10^{77}$ cells so Full Indra Net information can be seen / reflected by each Schwinger Source Indra Jewel.

Each Schwinger Source contains 10^{27} Virtual pairs of particles each of which can see along a connecting Line an Other Indra's Net Source which Line sees Other Sources through Monster Group Lens elements so that the Other Source appears to the Original Source to be a Julia Set.

Each Schwinger Source has a Mandelbrot Set that tells its Source what each of the many Indra's Net Source Julia set looks like by correlating Monster Group Lens Elements with Types of Julia Set. Self-Perception is always the $c = 0$ Circle Julia Set.

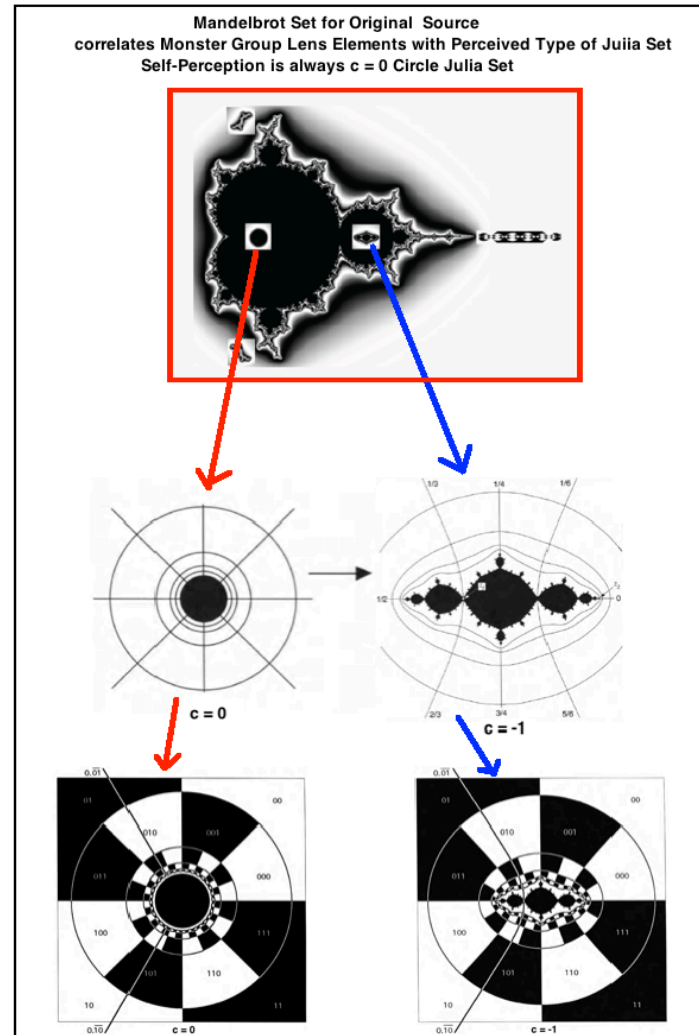
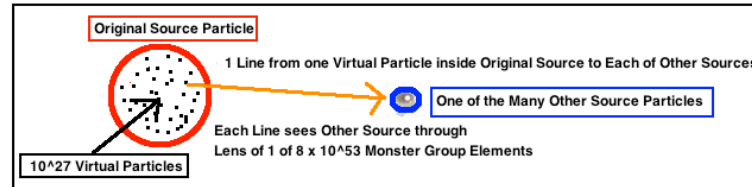
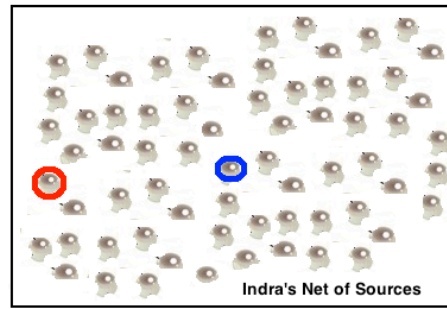

September 2019 (United States)

October 2019

S	M	T	W	T	F	S
		1	2	3	4	5
6	7	8	9	10	11	12
13	14	15	16	17	18	19
20	21	22	23	24	25	26
27	28	29	30	31		

Sun	Mon	Tue	Wed	Thu	Fri	Sat
1 Muharram	2 Labor Day	3	4	5 ☾ 1st Quarter	6	7
8	9	10	11	12	13	14 ☽ Full Moon
15	16	17	18	19	20	21 ☾ 3rd Quarter
22	23 September equinox	24	25	26	27	28 ● New Moon
29	30 Rosh Hashana	1	2	3	4	5 ☾ 1st Quarter

$$\begin{array}{cccc}
\mathbf{S0} & \mathbf{S1} & \mathbf{S3} & \mathbf{S7} \\
\mathbf{U} & \mathbf{U} & \mathbf{U} & \mathbf{U} \\
\mathbf{T} = \mathbf{R} \times \mathbf{C} \times \mathbf{H} \times \mathbf{O} \\
\mathbf{Z2} & \mathbf{U(1)} & \mathbf{SU(2)} & \mathbf{Spin(8)}
\end{array}$$

Division Algebras, Lattices, Physics, Windmill Tilting
Geoffrey Dixon

As to \mathbf{T} , resolve its identity into four orthogonal *idempotents*

$$\Delta_0 = \frac{1}{4}(1 + i\vec{x})(1 + ie_7) = \left(\frac{1}{2}(1 + i\vec{x})\right)\left(\frac{1}{2}(1 + ie_7)\right)$$

$$\Delta_1 = \frac{1}{4}(1 - i\vec{x})(1 + ie_7) = \left(\frac{1}{2}(1 - i\vec{x})\right)\left(\frac{1}{2}(1 + ie_7)\right)$$

$$\Delta_2 = \frac{1}{4}(1 + i\vec{y})(1 - ie_7) = \left(\frac{1}{2}(1 + i\vec{y})\right)\left(\frac{1}{2}(1 - ie_7)\right)$$

$$\Delta_3 = \frac{1}{4}(1 - i\vec{y})(1 - ie_7) = \left(\frac{1}{2}(1 - i\vec{y})\right)\left(\frac{1}{2}(1 - ie_7)\right)$$

In the Pauli algebra case, we got Dirac spinors by doubling \mathbf{P} to \mathbf{P}^2
we double up and use \mathbf{T}^2 as our spinor space. Let Ψ be a \mathbf{T}^2 spinor
the following identifications fall out of the mathematics

$\rho_+ \Psi$: matter
 $\rho_- \Psi$: antimatter

8 Fermion First-Generation Particles
each with 8 Spacetime Components

$\rho_+ \Psi \Delta_0$: matter - neutrino - $SU(3)$ singlet
 $\rho_+ \Psi \Delta_1$: matter - electron - $SU(3)$ singlet
 $\rho_+ \Psi \Delta_2$: matter - up quark - $SU(3)$ triplet
 $\rho_+ \Psi \Delta_3$: matter - down quark - $SU(3)$ triplet

+

8 Fermion First-Generation AntiParticles
each with 8 Spacetime Components

$\rho_- \Psi \Delta_3$: antimatter - antineutrino - $SU(3)$ antisinglet
 $\rho_- \Psi \Delta_2$: antimatter - positron - $SU(3)$ antisinglet
 $\rho_- \Psi \Delta_1$: antimatter - anti-up antiquark - $SU(3)$ antitriplet
 $\rho_- \Psi \Delta_0$: antimatter - anti-down antiquark - $SU(3)$ antitriplet

$$= 8 \times 8 + 8 \times 8 = 64 + 64 = \mathbf{T} + \mathbf{T} = 128 = \mathbf{T}^2 =$$

$$= \mathbf{E8} / \mathbf{D8} = (\mathbf{OxO})\mathbf{P2} = \text{HalfSpinors of } \mathbf{Cl(16)}$$

Geoffrey Dixon wrote a 1995 paper in which he represented
the Leech lattice over \mathbf{O}^3 .
the final result breaks up the inner shell of Λ_{24} ,
which is of order $K_{24} = 196560$,
into three subsets with orders $3 \times 240 = 720$,
 $3 \times 240 \times 16 = 11520$, and $3 \times 240 \times 16 \times 16 = 184320$,
the sum of all three orders being 196560.

Here is a summary of E8 Physics model calculation results. Since ratios are calculated,
values for one particle mass and one force strength are assumed.
Quark masses are constituent masses. Most of the calculations are tree-level,
so more detailed calculations might be even closer to observations.

Dark Energy : Dark Matter : Ordinary Matter = 0.75 : 0.21 : 0.04

Fermions as Schwinger Sources have geometry of Complex Bounded Domains
with Kerr-Newman Black Hole structure size about $10^{(-24)}$ cm.

Particle/Force	Tree-Level	Higher-Order
e-neutrino	0	0 for nu_1
mu-neutrino	0	$9 \times 10^{(-3)}$ eV for nu_2
tau-neutrino	0	$5.4 \times 10^{(-2)}$ eV for nu_3
electron	0.5110 MeV	
down quark	312.8 MeV	charged pion = 139 MeV
up quark	312.8 MeV	proton = 938.25 MeV
		neutron - proton = 1.1 MeV
muon	104.8 MeV	106.2 MeV
strange quark	625 MeV	
charm quark	2090 MeV	
tauon	1.88 GeV	
beauty quark	5.63 GeV	
truth quark (low state)	130 GeV	(middle state) 174 GeV (high state) 218 GeV
W+	80.326 GeV	
W-	80.326 GeV	
W0	98.379 GeV	Z0 = 91.862 GeV
Mplanck	1.217×10^{19} GeV	
Higgs VEV (assumed)	252.5 GeV	
Higgs (low state)	126 GeV	(middle state) 182 GeV (high state) 239 GeV
Gravity Gg (assumed)	1	
(Gg)(Mproton ² / Mplanck ²)		$5 \times 10^{(-39)}$
EM fine structure	1/137.03608	
Weak Gw	0.2535	
Gw(Mproton ² / (Mw+ ² + Mw- ² + Mz0 ²))		$1.05 \times 10^{(-5)}$
Color Force at 0.245 GeV	0.6286	0.106 at 91 GeV

Kobayashi-Maskawa parameters for W+ and W- processes are:

	d	s	b
u	0.975	0.222	0.00249 -0.00388i
c	-0.222 -0.000161i	0.974 -0.0000365i	0.0423
t	0.00698 -0.00378i	-0.0418 -0.00086i	0.999

The phase angle d13 is taken to be 1 radian.

October 2019 (United States)

November 2019

S	M	T	W	T	F	S
					1	2
3	4	5	6	7	8	9
10	11	12	13	14	15	16
17	18	19	20	21	22	23
24	25	26	27	28	29	30

Sun	Mon	Tue	Wed	Thu	Fri	Sat
29	30 Rosh Hashana	1	2	3	4	5 🌑 1st Quarter
6	7	8	9 Yom Kippur	10	11	12
13 ☾ Full Moon	14 Columbus Day (Most regions) First Day of Sukkot	15	16	17	18	19
20 Last Day of Sukkot	21 Shmini Atzeret 🌑 3rd Quarter	22 Simchat Torah	23	24	25	26
27 🌑 New Moon	28	29	30	31	1	2

Void -> CI(Void) -> CI(0) -> CI(1) -> CI(2) -> CI(4) -> CI(16)

Kaluza-Klein Spacetime
M4 x CP2

1	16
120	120
560	560
1820	1820
4368	4368
8008	8008
11440	11440
12870	12870
11440	11440
8008	8008
4368	4368
1820	1820
560	560
120	120
16	16
1	1

CI(8) that contains 28 = D4 for M4 Gravity

CI(8) that contains 28 = D4 for CP2 Std Model

Spinors: $(8s+8c) \times (8s+8c) = (8c \cdot 8s + 8c \cdot 8c)$

NJL Quantum Condensate

10¹⁹ E8 Lattice 240-vertex Polytope Cells in Universe at End of Inflation

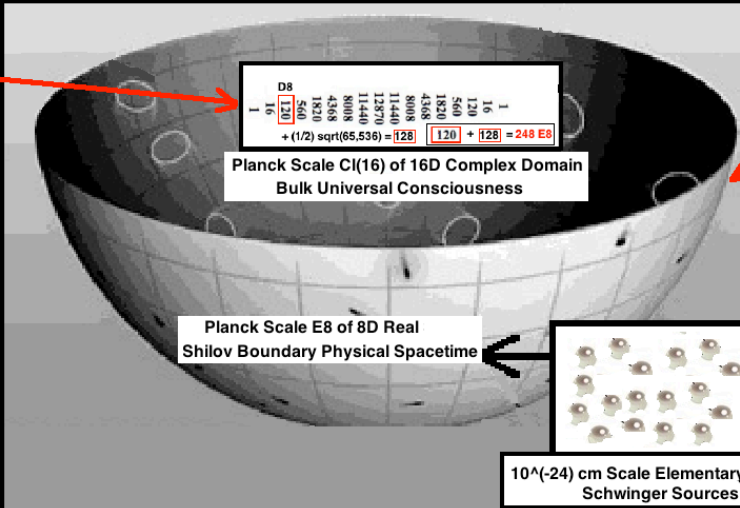
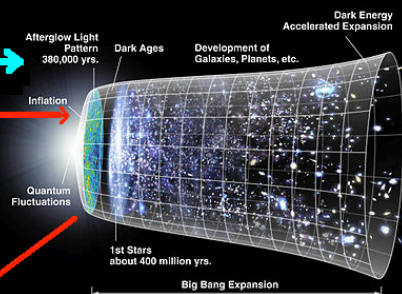

D8	16
120	120
560	560
1820	1820
4368	4368
8008	8008
11440	11440
12870	12870
11440	11440
8008	8008
4368	4368
1820	1820
560	560
120	120
16	16
1	1

+ (1/2) sqrt(65,536) = 128

120 + 128 = 248 E8

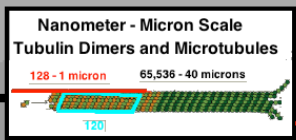

Quantum Resonant Connection

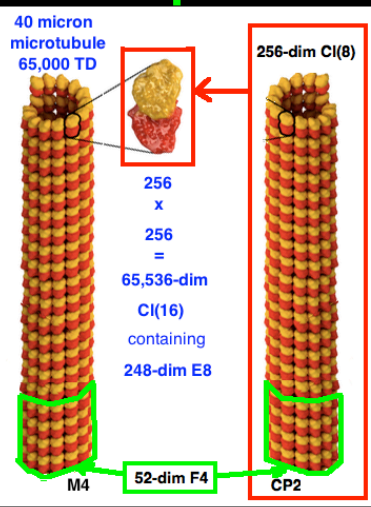

Penrose-Hameroff Quantum Condensate

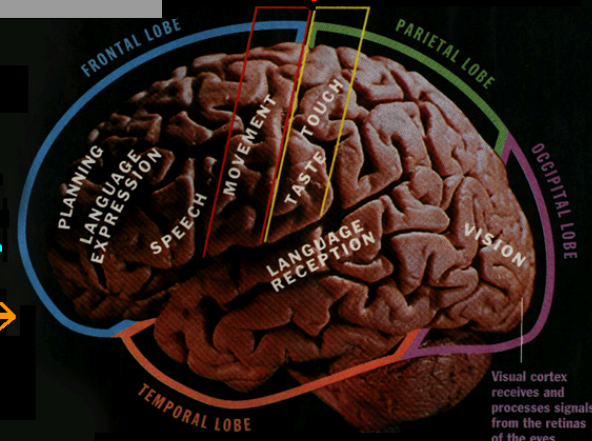

10¹⁹ Tubulin Dimers in a Human Brain

November 2019 (United States)

December 2019

S	M	T	W	T	F	S
1	2	3	4	5	6	7
8	9	10	11	12	13	14
15	16	17	18	19	20	21
22	23	24	25	26	27	28
29	30	31				

Sun	Mon	Tue	Wed	Thu	Fri	Sat
27 ● New Moon	28	29	30	31	1	2
3	4 ● 1st Quarter	5	6	7	8	9
10 The Prophet's Birthday	11 Veterans Day	12 ○ Full Moon	13	14	15	16
17	18	19 ● 3rd Quarter	20	21	22	23
24	25	26 ● New Moon	27	28 Thanksgiving Day	29	30

Void -> CI(Void) -> CI(0) -> CI(1) -> CI(2) -> CI(4) -> CI(16)

Kaluza-Klein Spacetime
M4 x CP2

CI(8) that contains 28 = D4 for M4 Gravity	CI(8) that contains 28 = D4 for CP2 Std Model	16
		120
		560
		1820
		4368
		8008
		11440
		12870
		11440
		8008
		4368
		560
		120
		16
		1

Spinors: $(8s+8c) \times (8s+8c) = (8c \cdot 8s + 8s \cdot 8c)$

10^19 E8 Lattice 240-vertex Polytope Cells in Universe at End of Inflation

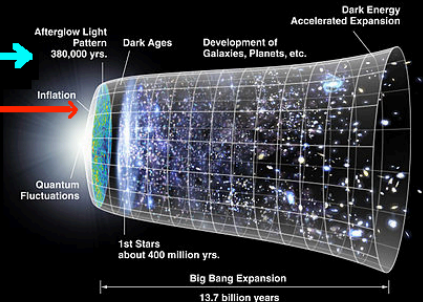

NJL Quantum Condensate

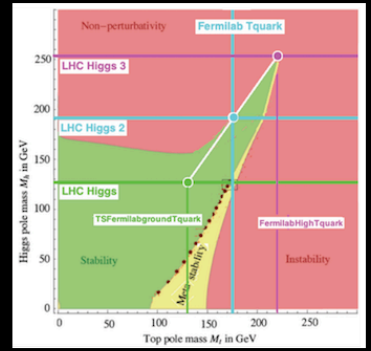
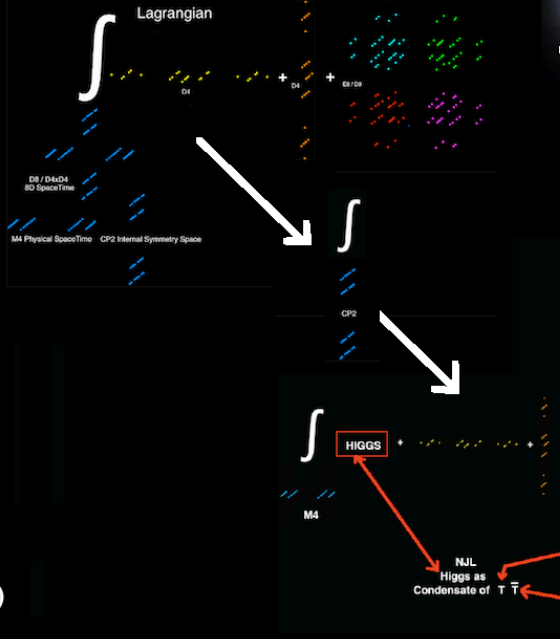
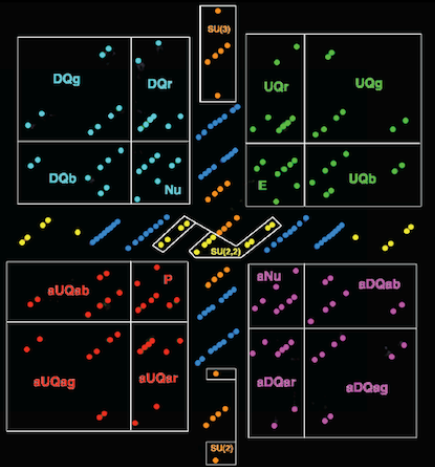

Quantum Resonant Connection

$CI(0,16) \times CI(0,8) = CI(0,24)$
 $M(2, CI(0,24)) = CI(1,25)$
 Completion of Union of All Tensor Products of $CI(1,25) = AQFT$

Penrose-Hameroff Quantum Condensate

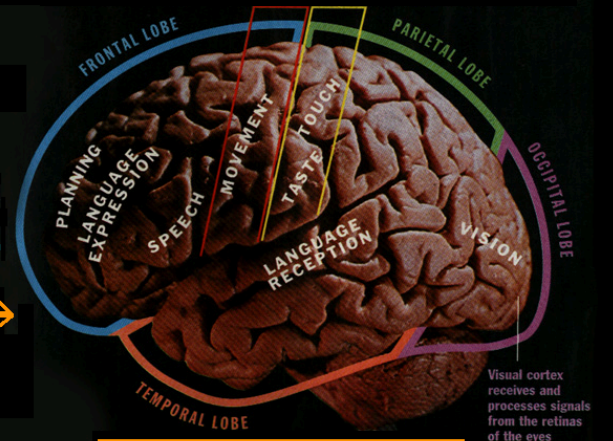
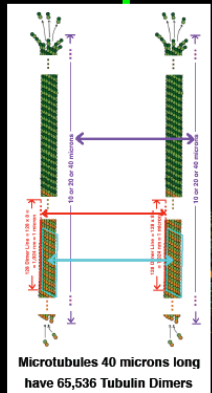

10^19 Tubulin Dimers in a Human Brain



December 2019 (United States)

January 2020

S	M	T	W	T	F	S
			1	2	3	4
5	6	7	8	9	10	11
12	13	14	15	16	17	18
19	20	21	22	23	24	25
26	27	28	29	30	31	

Sun	Mon	Tue	Wed	Thu	Fri	Sat
1	2	3	4 ☾ 1st Quarter	5	6	7
8	9	10	11	12 ☽ Full Moon	13	14
15	16	17	18 ☾ 3rd Quarter	19	20	21 December Solstice
22	23 Chanukah/Hanukkah (first day)	24 Christmas Eve	25 Christmas Day	26 ● New Moon	27	28
29	30 Last Day of Chanukah	31	1 New Year's Day	2 ☾ 1st Quarter	3	4

Tensor Product $Cl(0,8) \times Cl(p,q) = M(R,16) \times Cl(p,q) = Cl(p,q+8)$

Real Clifford Algebras $Cl(p,q)$

H = Quaternion

C = Complex

R = Real

8	$M_{16}(R)$	$M_{16}(C)$	$M_{16}(H)$	$M_{16}(H) \oplus M_{16}(H)$	$M_{32}(H)$	$M_{64}(C)$	$M_{128}(R)$	$M_{128}(R) \oplus M_{128}(R)$	$M_{256}(R)$										
7	$M_8(C)$	$M_8(H)$	$M_8(H) \oplus M_8(H)$	$M_{16}(H)$	$M_{32}(C)$	$M_{64}(R)$	$M_{64}(R) \oplus M_{64}(R)$	$M_{128}(R)$	$M_{128}(C)$	$M_{128}(H)$									
6	$M_4(H)$	$M_4(H) \oplus M_4(H)$	$M_8(H)$	$M_{16}(C)$	$M_{32}(R)$	$M_{32}(R) \oplus M_{32}(R)$	$M_{64}(R)$	$M_{64}(C)$	$M_{64}(H)$	$M_{64}(H) \oplus M_{64}(H)$	$M_{128}(H)$								
5	$M_2(H) \oplus M_2(H)$	$M_4(H)$	$M_8(C)$	$M_{16}(R)$	$M_{16}(R) \oplus M_{16}(R)$	$M_{32}(R)$	$M_{32}(C)$	$M_{32}(H)$	$M_{32}(H) \oplus M_{32}(H)$	$M_{64}(H)$	$M_{128}(C)$	$M_{256}(R)$							
4	$M_2(H)$	$M_4(C)$	$M_8(R)$	$M_8(R) \oplus M_8(R)$	$M_{16}(R)$	$M_{16}(C)$	$M_{16}(H)$	$M_{16}(H) \oplus M_{16}(H)$	$M_{32}(H)$	$M_{64}(C)$	$M_{128}(R)$	$M_{128}(R) \oplus M_{128}(R)$	$M_{256}(R)$						
3	$M_2(C)$	$M_4(R)$	$M_4(R) \oplus M_4(R)$	$M_8(R)$	$M_8(C)$	$M_8(H)$	$M_8(H) \oplus M_8(H)$	$M_{16}(H)$	$M_{32}(C)$	$M_{64}(R)$	$M_{64}(R) \oplus M_{64}(R)$	$M_{128}(R)$	$M_{128}(C)$	$M_{128}(H)$					
2	$M_2(R)$	$M_2(R) \oplus M_2(R)$	$M_4(R)$	$M_4(C)$	$M_4(H)$	$M_4(H) \oplus M_4(H)$	$M_8(H)$	$M_{16}(C)$	$M_{32}(R)$	$M_{32}(R) \oplus M_{32}(R)$	$M_{64}(R)$	$M_{64}(C)$	$M_{64}(H)$	$M_{64}(H) \oplus M_{64}(H)$	$M_{128}(H)$				
1	$R \oplus R$	$M_2(R)$	$M_2(C)$	$M_2(H)$	$M_2(H) \oplus M_2(H)$	$M_4(H)$	$M_8(C)$	$M_{16}(R)$	$M_{16}(R) \oplus M_{16}(R)$	$M_{32}(R)$	$M_{32}(C)$	$M_{32}(H)$	$M_{32}(H) \oplus M_{32}(H)$	$M_{64}(H)$	$M_{128}(C)$	$M_{256}(R)$			
0	R	C	H	$H \oplus H$	$M_2(H)$	$M_4(C)$	$M_8(R)$	$M_8(R) \oplus M_8(R)$	$M_{16}(R)$	$M_{16}(C)$	$M_{16}(H)$	$M_{16}(H) \oplus M_{16}(H)$	$M_{32}(H)$	$M_{64}(C)$	$M_{128}(R)$	$M_{128}(R) \oplus M_{128}(R)$	$M_{256}(R)$		
	0	1	2	3	4	5	6	7	8	9	10	11	12	13	14	15	16		

q -->

p ^

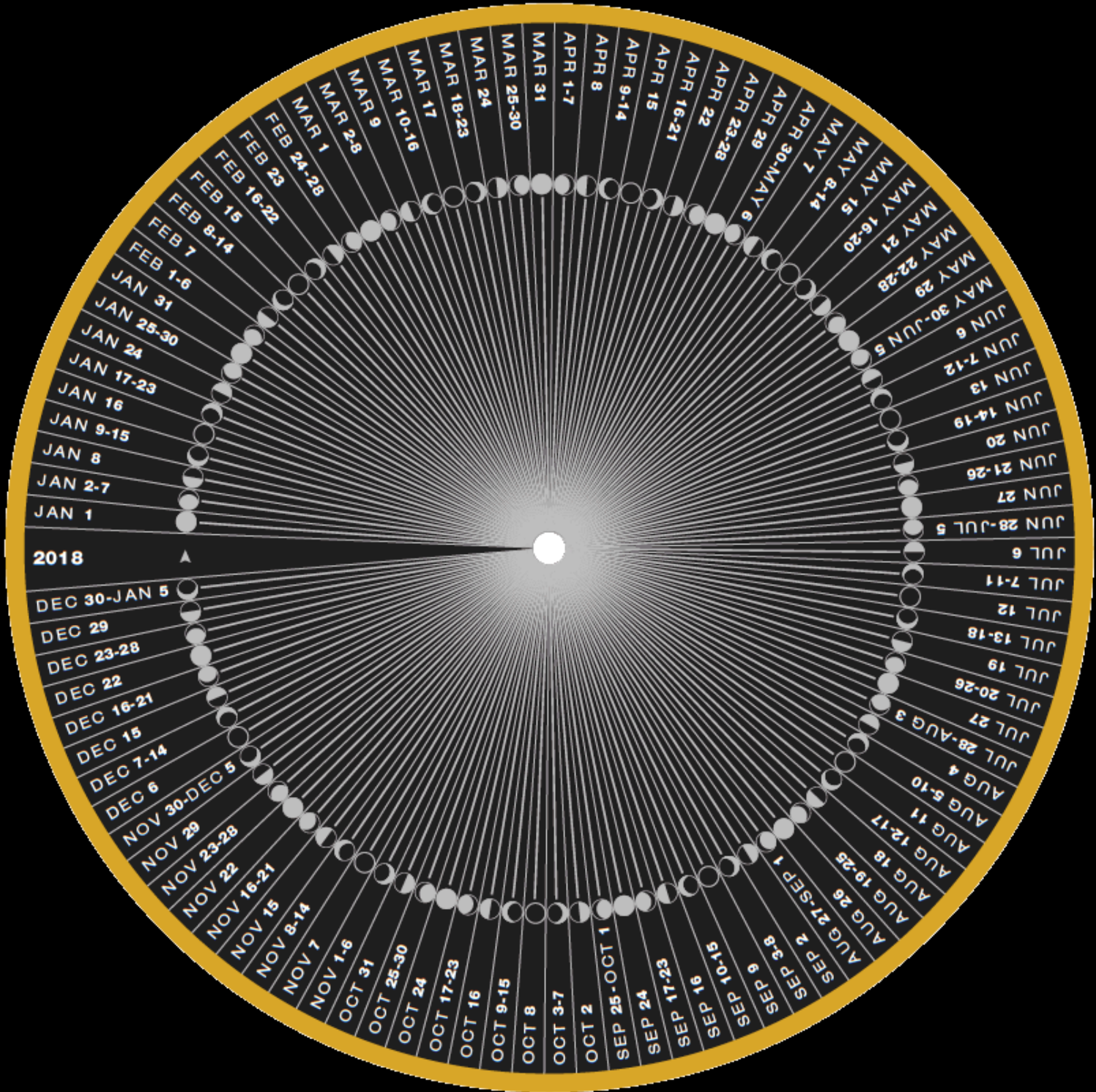

Leonardo da Vinci E8

Frank Dodd (Tony) Smith, Jr. - 2017

Wikipedia: "... Christ as Salvator Mundi (Saviour of The World) ... is a painting ... from c. 1500 ... by Leonardo da Vinci ... The painting shows Christ, in Renaissance dress, giving a benediction with his raised right hand and crossed fingers while holding a crystal sphere in his left hand ...



... It was ... possibly painted for Louis XII of France and his consort, Anne of Brittany ... shortly after the conquests of Milan and Genoa around 1500 [and] subsequently owned by Charles I of England and recorded in his art collection in 1649 ... Leonardo painted the orb as if it were a hollow glass bubble that does not refract or distort the light passing through it ... [instead of] ... paint[ing] the distortion that would occur when looking through a solid clear orb ...”.

Since Leonardo’s orb is a hollow sphere instead of a solid ball Leonardo’s markings are all on the surface of the 2-dim sphere boundary of the ball in 3-dim space.

E8-CI(16) Physics (viXra 1602.0319) is based on the 240 Root Vectors of E8 which are points on the 7-dim sphere boundary of the ball in 8-dim space.

$$\begin{aligned} 248\text{-dim E8} &= 120\text{-dim D8} + 128\text{-dim D8} + \text{half-spinor} = \\ &= \text{D4xD4} + \text{8x8} + 128\text{-dim D8} + \text{half-spinor D8+s} \end{aligned}$$

The structure of E8 was depicted by Flammarion (wood engraving on page 163 of his 1888 book "L'Atmosphere Meteorologie Populaire") on a Celestial Sphere beyond our Earthly Plane and its Star-Sun-Moon-Planets Sphere (viXra 1304.0071):

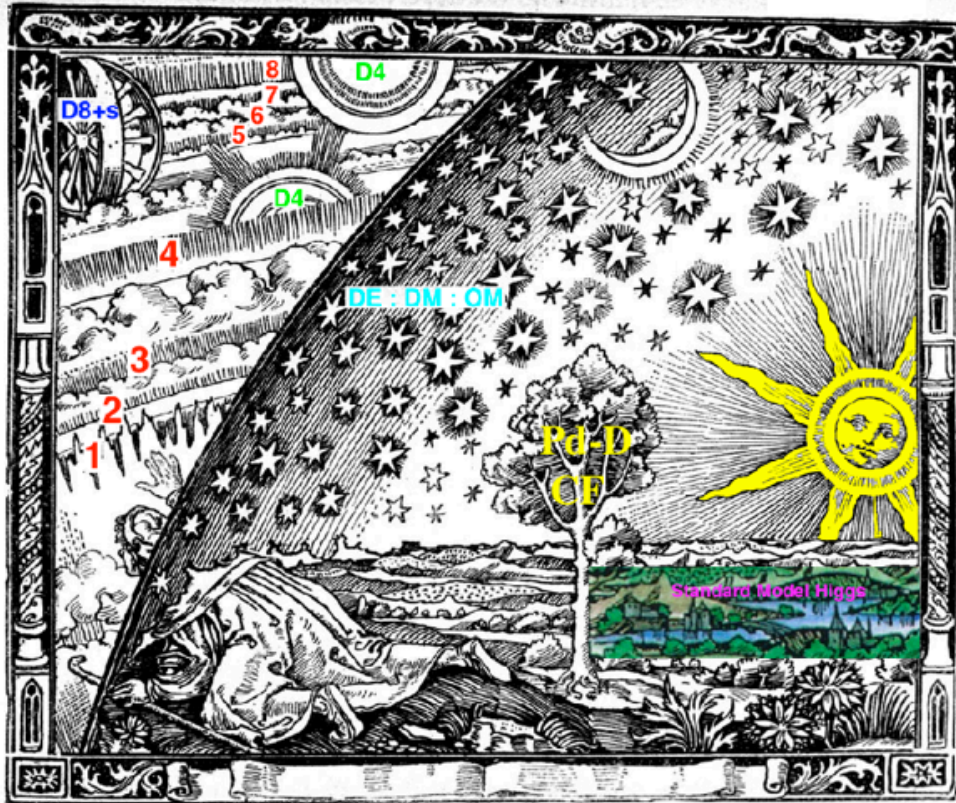

Flammarion's 1888 engraving was much later than Leonardo's 1500 painting so it did not directly influence Leonardo, but its basic components were well known from at least the time of Ramon Llull (1232-1315)

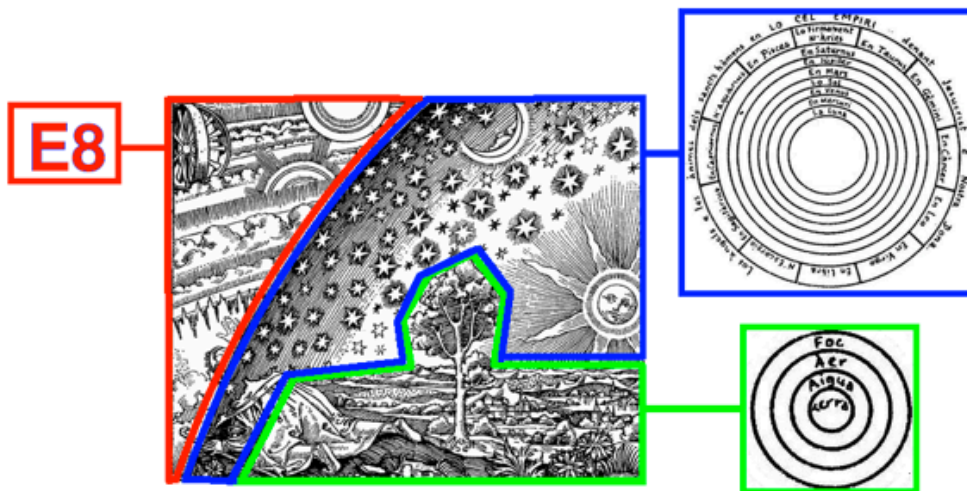

who, according to R. Pring-Mill, *Studies on Ramon Llull*, Barcelona, PAM-Curial, 1991, p. 62, produced a "Scheme of the simplified aristotelian cosmos" as a circle centered by 4 layers Earth, Water, Air, and Fire and then by 7 layers Moon, Mercury, Venus, Sun, Mars, Jupiter, and Saturn and an 8th layer for the fixed Stars described by the Zodiac

and the 13th layer of Angels, Saints, and the Heavenly Empire of Jesus and G-d which I interpret as E8 Physics by which G-d governs Our Universe. that is beyond the outer $4+7+1 = 12$ layers of Earth, Sun, Moon, Planets, Stars:



The Flammarion Celestial Sphere representation of E8 corresponds to Leonardo's Sphere with markings also representing E8.

Flammarion's Celestial Sphere has two copies of D4 each with 24 Root Vectors and 128 Root Vectors from +half-spinors D8+s of D8 and 8 levels of 8 Spacetime dimensions for position x momentum = $8 \times 8 = 64$ Root Vectors thus giving $24 + 24 + 128 + 64 = 240$ Root Vectors of E8.

Flammarion's Earthly Plane and Stars-Sun-Moon-Panets Sphere corresponding to

Gravity , Dark Energy ratio DE:DM:OM , Higgs , Solar Fusion , and Pd-D Cold Fusion is not shown explicitly by Leonardo, but is represented by Leonardo as

Earthly Plane = Brown Hand and Stars-Sun-Moon-Panets Sphere = Blue Garment.

Leonardo's Celestial Sphere represents E8 in this way:

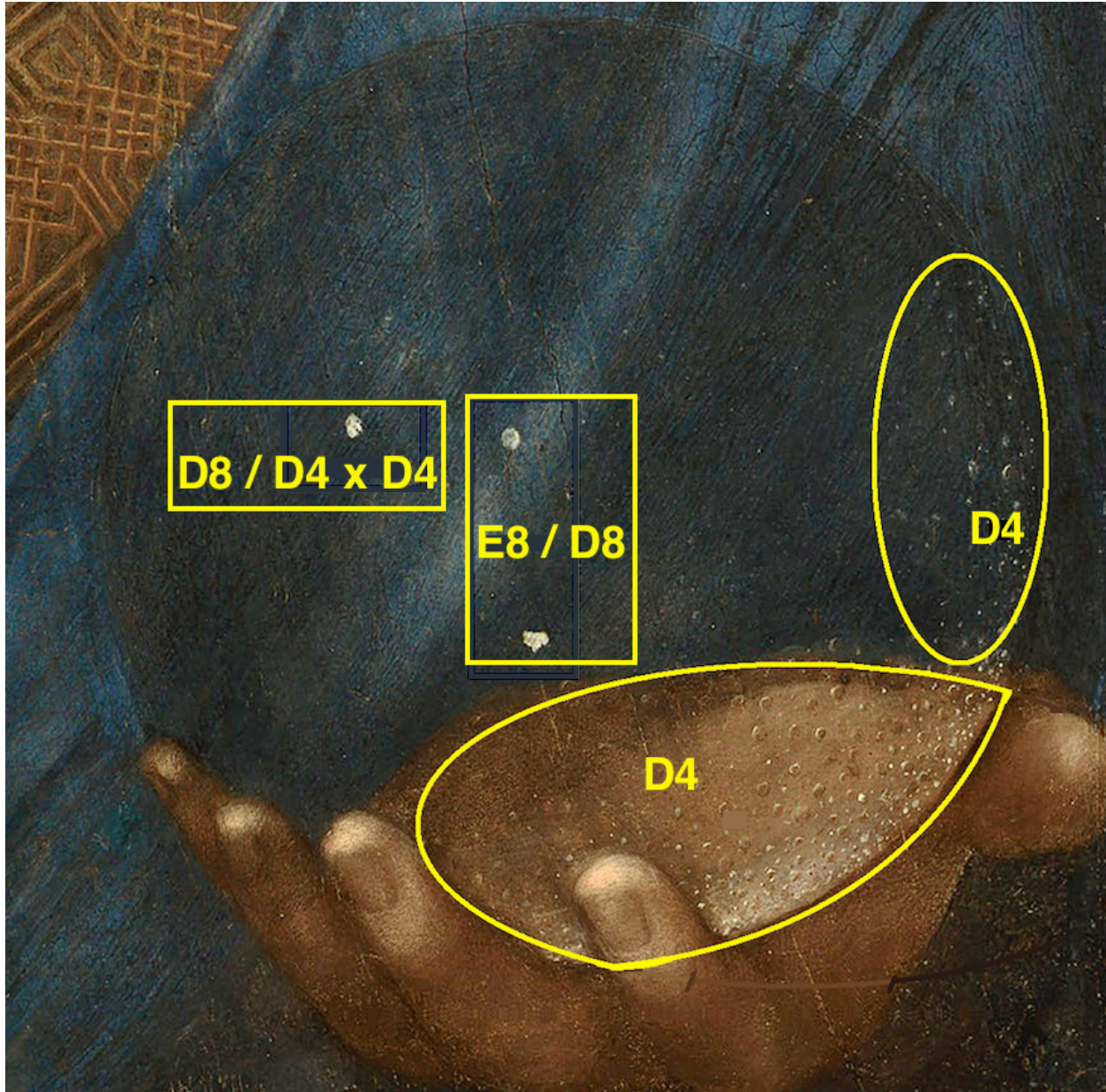

Two markings correspond to $64+64 = 128$ -dim E8 / D8
 (8x8 Fermion and 8x8 AntiFermion components)

The third marking corresponds to 64-dim D8 / D4 x D4
 (8-dim Spacetime 8x8 Position x Momentum)

One of the D4 groups of markings corresponds to
 the Standard Model and Gravity-Dark Energy Ghosts.

The other D4 group of markings corresponds to
 Gravity-Dark Energy and Standard Model Ghosts.

24 of each D4 group of markings are D4 Root Vectors,
 the others are composite structures such as
 Gauge-Boson-bound (mesons, baryons, atoms) and Gravity-bound (black holes, planets, stars, galaxies).

E8-CI(16) Physics Calculations of Particle Masses and Force Strengths
 from Green's Functions = Kernel Functions of Schwinger Sources
 make use of Shilov Boundaries of Complex Domains whose structure
 is inherited from the geometry of E8.