

New Theories of Gravitation and Particle Model

Chongxi Yu

Techfields Inc.

1679 S Dupont HYW, Dover, Delaware, USA

Abstract

Every matter is moving in very high speed because the Milky Way's speed relative to CMB rest frame is 552km/s, 0.18% of light speed. When matter moves, there may be the lag of gluons, photons, mesons, protons, and neutrons, in exact words, the lag of c-particles, A particle and their anti particles, which makes bonding of nucleons weaker and exposes more nuclear forces, and results in stronger residual forces of bonding forces between particles. Gravitation, then, may be the residual force of the bonding force between particles. Three color particles and a A particle and their antiparticles (total 8 particles) make all current "elementary particles". Surprisingly, we can draw photons, gluons, electrons, quarks, mesons, bosons and any current "elementary particles" from these particles just like drawing chemical structures. These structures can show how an electron and a positron annihilate to photons, how proton absorb electron to form neutron, and how fission and fusion happen. It can explain almost every question around elementary particles. According to this model, there may be only one force which comes from c-particles orbit A particle and anti c-particles orbit anti A particle and a side product, the electromagnetic force, due to the asymmetry of c-particles and anti c-particles.

Keywords: Elementary particles; Neutron; Neutrinos; Gravitation; electromagnetic fields .

PACS Nos: 95.30.Cg; 28.20. Fc; 14.60. st; 95.30. sf; 03.50. De 41.20.-q.

Introduction

Gravitation is a natural phenomenon and all things are brought toward one another by gravitation. Modern work on gravitational theory began with the work of Galileo Galilei in the late 16th. In 1687, Isaac Newton published Newton's law of universal gravitation, which postulates that gravity is a force where two bodies of mass are directly attracted to one another according to a mathematical relationship, $F=Gm_1m_2/r^2$, Where F is the force, m_1 and m_2 are the masses of the objects interacting, r is the distance between the centers of the masses and G is the gravitational constant¹. In Albert Einstein's general theory of relativity, gravitation is ascribed to spacetime curvature instead of a force. However, there are many anomalies and discrepancies around gravitation that are not answered by current theories. All current theories of gravitation cannot explain the motion of galaxies and the expansion of the universe without the help of dark matter³

and dark energy⁴, both of them are never found. All current theories of gravitation cannot explain flyby anomaly⁵, anomalous increase of the astronomical unit, extra energetic photons, and extra massive hydrogen clouds⁶. Although the standard model has demonstrated successes in providing experimental predictions, it does leave many phenomena unexplained and falls short of being a complete theory of fundamental interactions, especially for gravitation⁷. This model does not contain any viable dark matter particle. Elementary particles must be the particles whose substructures are unknown. Today we say that photons, electrons, leptons, antileptons, quarks, and antiquarks⁸ are elementary particles. However, annihilation of one electron and one positron results in the creation of 2 photons⁹. A top quark can decay to a bottom quark and a W^+ Boson, a bottom quark can decay to a charm quark and a W^- Boson, a charm quark can decay to a strange quark and a W^+ Boson, and a strange quark can decay to a up quark and a W^- Boson^{10,11}. If they are elementary particles, they should not be exchangeable. These facts mean top quarks, bottom quarks, strange quarks, and charm quarks have substructures and are not elementary particles. The standard model does not say how one kind of quark decay to another quark. Here, we are trying to develop new theories of gravitation and elementary particles that can explain all these anomalies and discrepancies around gravitation and standard model.

Discussion

First, let us look at some natural phenomena:

1. A comet is an icy small solar system body that has a comet nucleus which is solid and composed of an amalgamation of rock, dust, water ice, and frozen gases, a coma which is the nebulous envelope around the nucleus and made of ice and dust, and a type II tail (curved) which is made of the streams of dust and gas from the vaporization of the nucleus and is left behind in the comet's orbit and a type I tail which is made of gases and points directly away from the Sun. Due to the weak bonding of gases to the nucleus, when the nucleus moves forward, the gases lag behind and form the tails of the comet.
2. There are many more rainstorms and snowstorms on Eastern coasts than Western coasts. The reason for this is the lag of water vapors behind the Earth's rotation from west to east. The lagging of water vapor above the sea moves the wet air to the land of the Eastern coast to cause more rain and snow and also moves the wet air above the sea far away from the land of western coast to cause dry weather.
3. The London dispersion force¹² is a weak intermolecular force that is frequently described as the formation of instantaneous dipoles that attract each other.

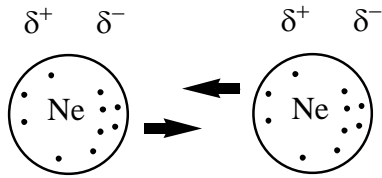

Figure 1. Attraction of Instantaneous Dipoles of Neon
 This process is at random and has equal chances to be:

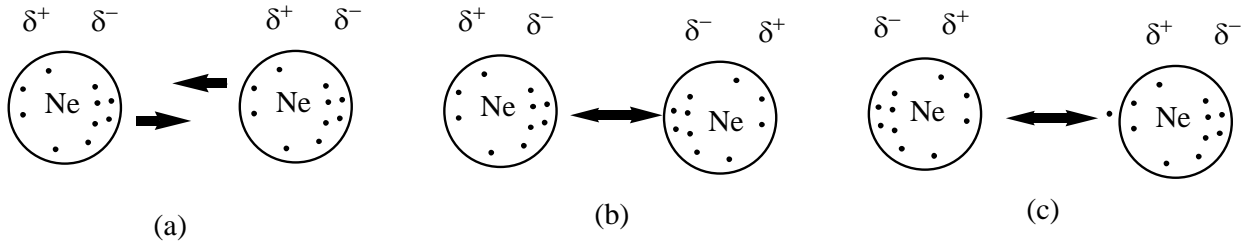

Figure 2. Distribution at Random of Instantaneous Dipoles of Neon: (a) attraction between partial negative and partial positive dipoles; (b) repulsion between partial negative and partial negative dipoles; (c) repulsion between partial positive and partial positive dipoles

Thus, there should be no net force to attract each other. London dispersion forces become stronger as the atom in question becomes larger: e.g. fluorine and chlorine are gases, bromine is liquid, and iodine is a solid; however, at random, an atom with only one electron always has an asymmetric distribution and will have instantaneous dipoles all time, however atoms with a larger amount of electrons are much less likely to have an asymmetric distribution. If there is a lag of electron movement when chemicals move with the Earth, then the non-polar molecules will produce small permanent dipoles in one direction along with the Earth orbit due to the movement of the Earth. The movement of everything on Earth is up to 0.185% of light speed that can break the bonding between almost every particle (the Earth's orbital speed is about 29.78 km/s, about 0.01% of light speed, the Solar System's orbital speed is much faster, at about 220km/s orbit around the center of the milky way and 370km/s relative to CMB rest frame, about 0.073% and 0.123% of light speed, and milky way's orbital speed relative to CMB rest frame is about 552km/s, 0.185% of light speed):

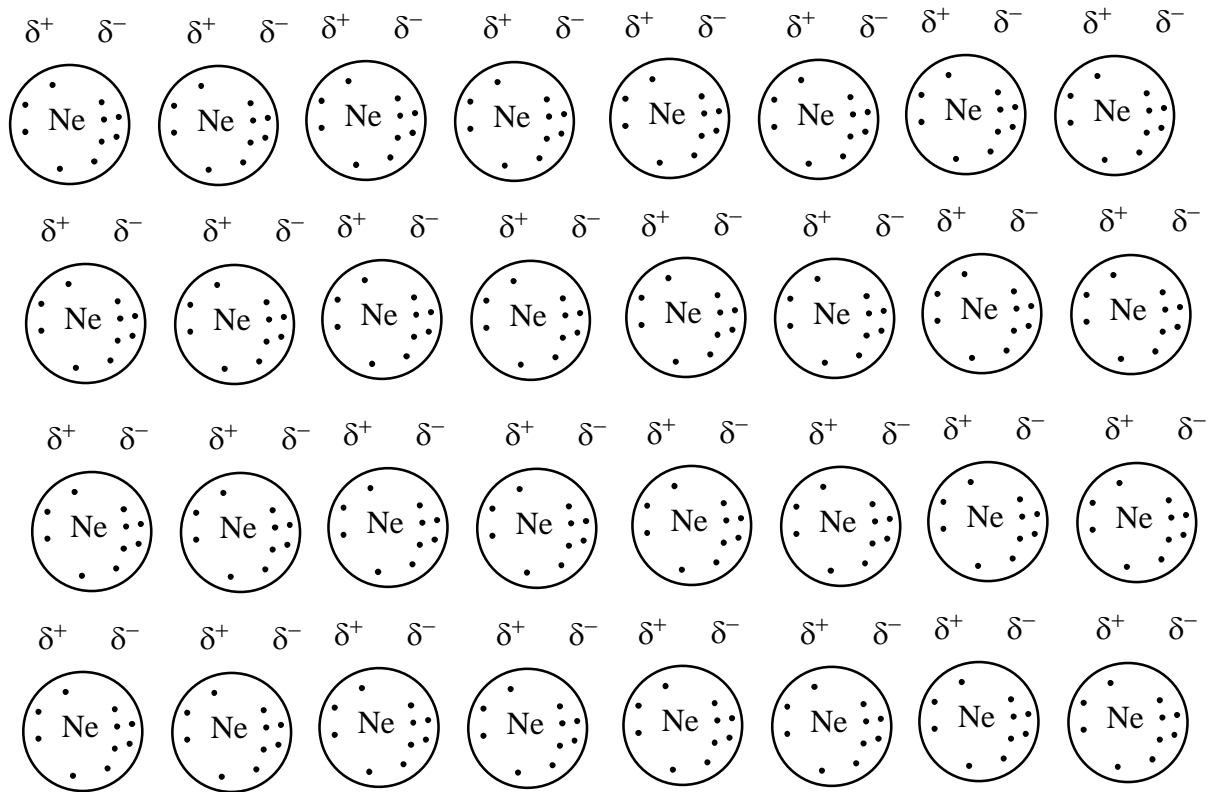

Figure 3. Attraction between the Small Permanent Dipoles of Neon produced by the movement of the Earth

The dipoles become larger as the atoms in question become larger due to the lagging of more electrons. London dispersion forces do not come from the random instantaneous dipoles, but from the small “permanent dipoles that are produced by the lag of electrons due to the Earth’s movement.

When the Earth rotates from west to east, the lag of electron movement will produce a magnetic field that points south (electric current directs from east to west) according to the right hand rule. This may be the source of the Earth’s magnetic field. Mercury (3.03 m/s) rotates much slower than the Earth (465 m/s) and has a very weak magnetic field (1.1% the strength of Earth’s). We may think Mercury has much less mass (only 5.5 % of Earth’s), however, Venus has similar mass as Earth (86.15% of Earth’s), rotates very slowly (1.81 m/s) in the opposite direction, and does not have an intrinsic magnetic field at all. If the planetary magnetic fields come from the rotation of planets, then everything is very clear. Jupiter and Saturn are gas planets and convection currents of gas will interface with their planetary magnetic fields. Uranus and Neptune are icy planets and have a water–ammonia ocean with very high electrical conductivity which will interface with their planetary magnetic fields. Mars is a terrestrial planet as Earth and rotates at half the speed of Earth (241.17 m/s), but does not have a planetary magnetic field. The reason may be that the surface of Mars is deeply covered by finely grained iron (III) oxide dust, which is ferromagnetic and will cancel out any planetary magnetic field. Indeed, the movement

of electrons might produce all magnetic fields and magnetic monopoles may not exist ("magnetic charges" may come from "electron charges"). A permanent magnet, or lodestone, exists because the crystal structure of magnetite (Fe_3O_4) may favor one direction of electron movement.

The North and South magnetic poles of Earth wander widely, the Earth's field can reverse and the North and South Magnetic Poles relatively abruptly switch places. We did not know the reason for the changes yet. If the Earth's magnetic field is produced by the lag of electron movement, at the same time, the Earth orbits the Sun, the Solar System orbits the center of the Milky Way, and the Milky Way orbits the CMB rest frame and all these movements are always changing in direction and all these movements will affect the strength and direction of the Earth's magnetic field.

The nuclear force is the force between protons and neutrons. Neutrons and protons are affected by the nuclear force almost identically. According to the quark model, the nuclear force results from the exchange of mesons between neighboring nucleons and is a residual effect of the strong force. The bonding between protons and neutrons is similar to the bonding between atoms in molecules, which results from the exchange of electrons between neighboring atoms. Similarly, there may be a lagging of mesons when matter moves and makes residual forces of the nuclear force stronger. The nuclear force is a residual force of the strong force which bonds quarks together to form protons and neutrons, so the nuclear force is similar to van der Waals forces and the residual force of the nuclear force is similar to London dispersion forces.

However, if gravitation originates only from the lag of mesons, protons, and neutrons, then quarks and other "elementary particles" must be massless because elementary particles cannot be divided and do not have the lag of particles when they move, and so the gravitation force must be not be caused only by the lag of mesons, protons, and neutrons, but also rather by the lag of some unknown elementary particles and some universal bonding force, such as the strong force. The other best candidates are the lag of some unknown elementary particles, gluons and photons with zero rest mass. From this point of view, only photons, gluons, and some unknown particles with zero rest mass are elementary particles; if gluons and photons are not massless, they cannot be true elementary particles. When matter moves, there may be a lag of unknown elementary particles, gluons, photons, mesons, protons and neutrons, which makes bonding of nucleons weaker and exposes more nuclear forces and consequently produces gravitation. Under this view, gravitation is hence the residual force of the strong force.

We make the following hypotheses: All composite particles (include photons, gluons and other current "elementary particles") may be made from some unknown elementary particles. If one of the elementary particles A (A-particle) is tetrahedral, like the carbon atom in diamond and three other elementary particles are color particles (c-particle) with color charges, they can be assigned as red (r), green (g), and blue (b). They bond together to form the structure 1, each r, g, and b

has $1/3$ negative charge, structure 1 has charge -1 and spin $1/2$ and three r, g, and b color charges (it will be colorless). Structure 1 is like a carbon free radical, they cannot bond to each other due to the repulsion of the negative charge, but they can bond to their antiparticle structure 2 which has charge $+1$ and spin $1/2$ and three anti colors, \bar{r} , \bar{g} , and \bar{b} to form structure 3, the photon, by the strong force and electromagnetic force. The photon is colorless and has spin 1 (it is symmetrical), and the bonding forces are so strong that it is very difficult to produce particle lag, so it like “massless”, but it should have some negligible mass (it can bend to the Sun). It has all three color charges, so it is colorless. The negative charge and positive charge are cancelled out almost completely and it is chargeless, but it becomes very reasonable that it has electromagnetic properties due to the c-particles and anti c-particles. From the structure of photon, photon’s antiparticle is itself. In photons, elementary particle A and its antiparticle \bar{A} bond with 4 elementary particles and are “saturated” such that like the molecule, ethane, it is very stable. However, “saturated” does not mean the photon cannot bond to other particles, in fact, they are like sticky balls coated with glue and when they hit anything, they will stick to anything, but free photons will not stick each other because they are moving at light speed and the bonding between photons will be broken at light speed, so photons in light are always free. Everything except photons, c-particles and A particle and their antiparticles cannot move in light speed or faster, in other words, everything will be broken down to photons c-particles and A particle and their antiparticles in light speed. Photons exhibit wave-particle duality because photons are real particles and they vibrate due to their bonding to orbiting particles.

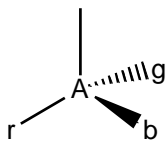

Structure 1. Elementary Particles

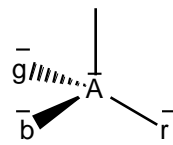

Structure 2. Anti Elementary Particles

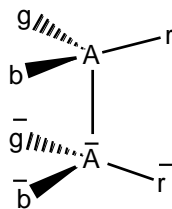

Structure 3. The Structure of Photon

Elementary particle A and color particles r, g, and b and their antiparticles can form 9 gluons.

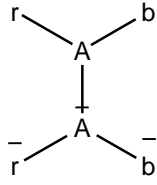

(a)

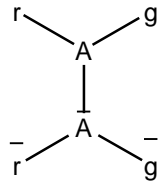

(b)

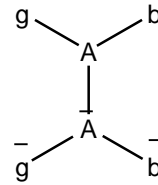

(c)

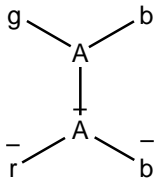

(d)

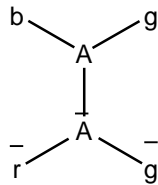

(e)

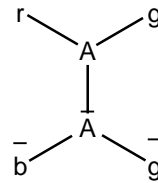

(f)

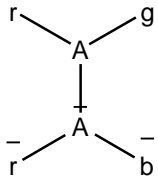

(g)

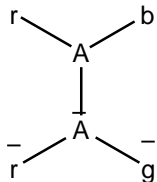

(h)

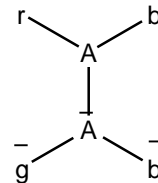

(i)

Structure 4. The Structures of Gluons: (a), (b), (c), (d), (e), (f), (g), (h), and (i) are gluons with a different color charge

In gluons, elementary particle A and its antiparticle \bar{A} bonds with only 3 elementary particles and are “unsaturated” that like the molecule, ethylene, so it is unstable and they are 2 valence gluons. Each gluon can glue 2 quarks together like double-sided tape. Gluons have spin 1. From structure 4, they are chargeless (the charge is cancelled out) and have color charges. They may have some negligible mass like photons. From our hypothesis, mass is related to the lag of particles, so all the number of particles, symmetry and the bond strength will affect the mass, symmetry and the bond strength may be more important than the number of particles. The bonding in photons is much stronger than the bonding in gluons, so gluons will be much more massive than photons if they have mass (but it is not important).

What is the bonding force? We believe the bonding forces come from c-particles orbit A-particle, may not one to one, but just like electrons orbit a mixture of protons and neutrons, but c-particles may or may not orbit the mixture of A-particles and \bar{A} -particles, c-particles may orbit only A-particles and anti c-particles may only orbit \bar{A} -particles, that means c-particles cannot mix with anti c-particles, A-particles pair with \bar{A} -particles in one to one. They may move at a speed faster than light speed. C-particles are fermions with spin $\frac{1}{2}$. The composite particles orbit each other to produce a bonding force due to the lag of elementary particles, gluons, photons, mesons,

protons, and neutrons. The first orbiting forces may come from the kinetic energy of c and A particles and their anti particles. The bonding force will be stronger and the orbiting speed will be faster if the orbit radius is smaller. The force that bonds elementary particles together to form quarks is much stronger than the strong force that bonds quarks to protons and neutrons. The force between electrons and the nucleus will be more than 10 orders of magnitude weaker than this force that bonds quarks to protons and neutrons, due to the fact that the size of an atom is more than 5 orders of magnitude larger than the size of protons and neutrons. As the force is inversely proportional to the square of the distance, r , then the electronic force will overshadow the strong force.

Photons bond to three color particles or anticolor particles to form electrons and positrons in the following structures.

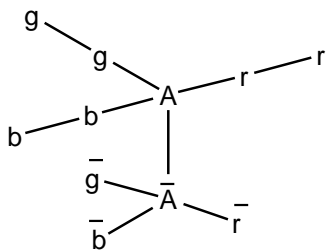

Structure 5. The Structure of Electron

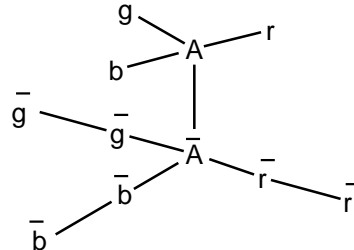

Structure 6. The Structure of Positron

From structure 5, the electron has charge -1 and is colorless. From structure 6, the positron has charge +1 and is colorless. Both have spin $\frac{1}{2}$ due to the asymmetry of their structures. When the electron or positron spins, the charges will produce a magnetic field and point to the direction according to right hand rule which makes the system unbalanced and less stable. If 2 of the same particle, either two electrons or two positrons with the same direction of spin enter the same orbit, it will cause the system to be more unbalanced and much less stable. If the direction of spin is different, it will make the system balanced and more stable. Photon and gluons have no charge and are symmetrical, so they have spin 1. Only 2 c-particles can pair together (follow Pauli Exclusion Principle).

The 4 elementary particles and their antiparticles can form up quark which may have three isomers as the following, but they are just like only one and may not be discriminated:

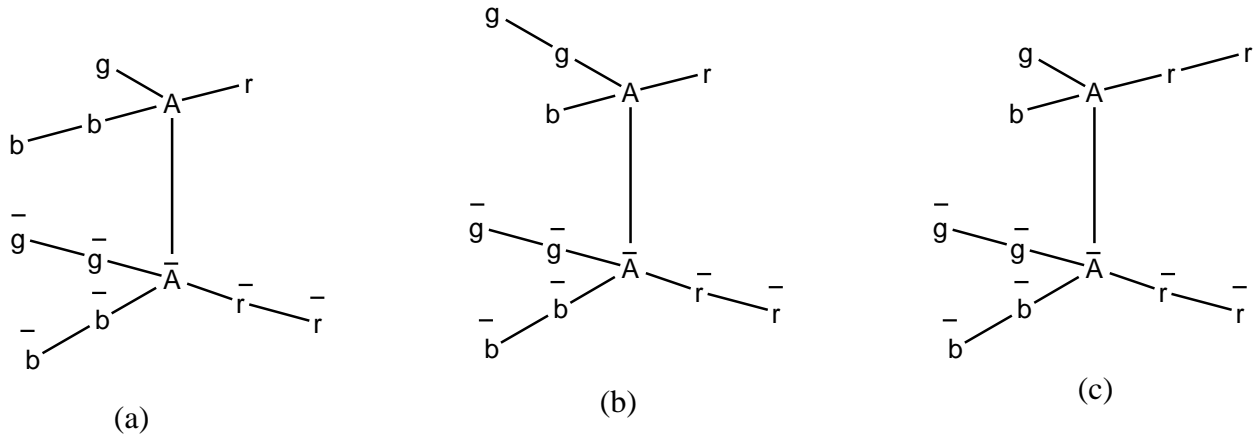

Structure 7. Structures of Up Quarks: (a); (b); and (c) are quarks with different color charges

From structure 7, up quarks have color charge, $+2/3$ charge and spin $1/2$. The followings are their antiparticles.

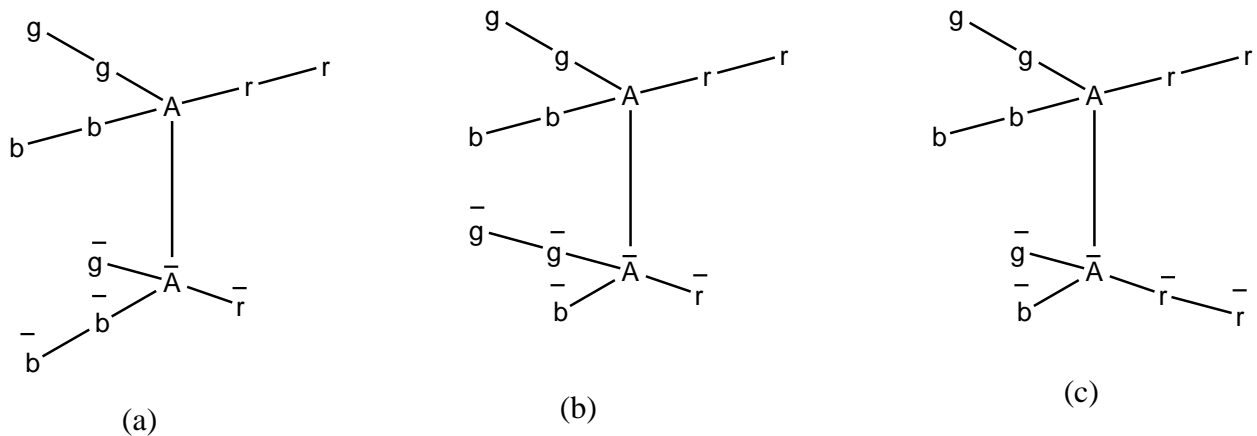

Structure 8. Structures of Up Antiquarks: (a); (b); and (c) are antiquarks with different color charges

From structure 8, up antiquarks have color charge, $-2/3$ charge and spin $1/2$.

The 4 elementary particles and their antiparticles can form down quarks which may have three isomers as the following, but they are just like one and may not be discriminated:

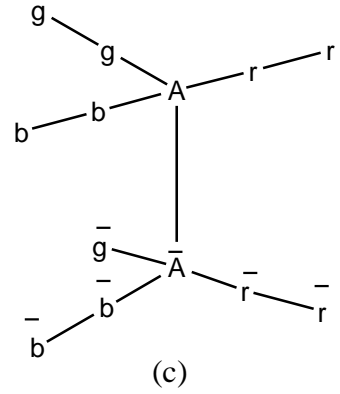
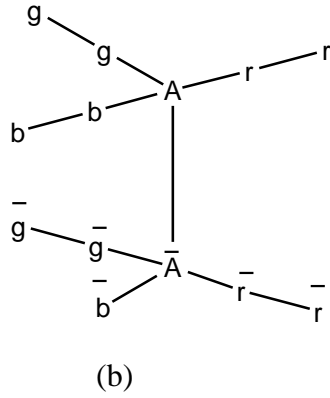
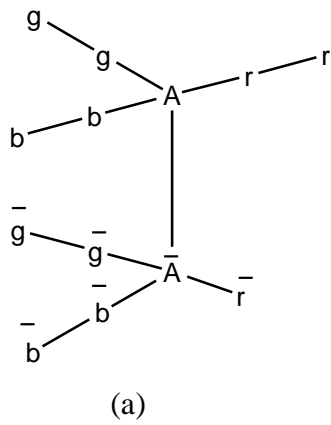

Structure 9. Structures of Down Quarks: (a); (b); and (c) are down quarks with different color charges

From structure 9, down quarks have color charge, $-1/3$ charge and spin $1/2$. The followings are their antiparticles.

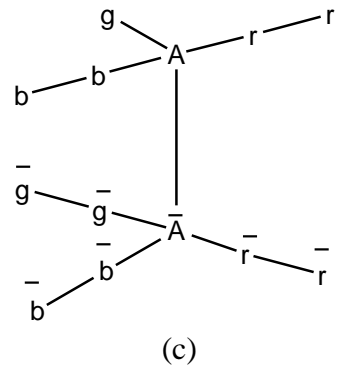
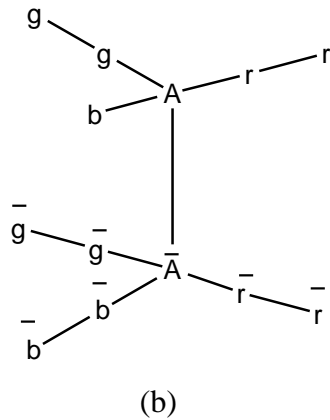
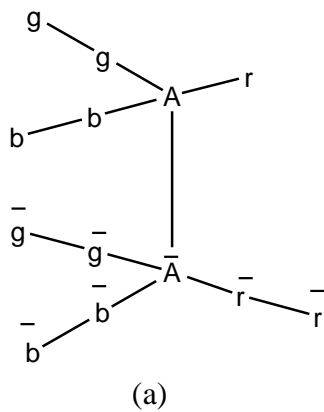

Structure 10. Structures of Down Antiquarks: (a); (b); and (c) are down antiquarks with different color charges

From structure 10, down antiquarks have color charge, $+1/3$ charge and spin $1/2$.

2 Up quarks and 1 down quark are glued by 5 gluons to form a proton.

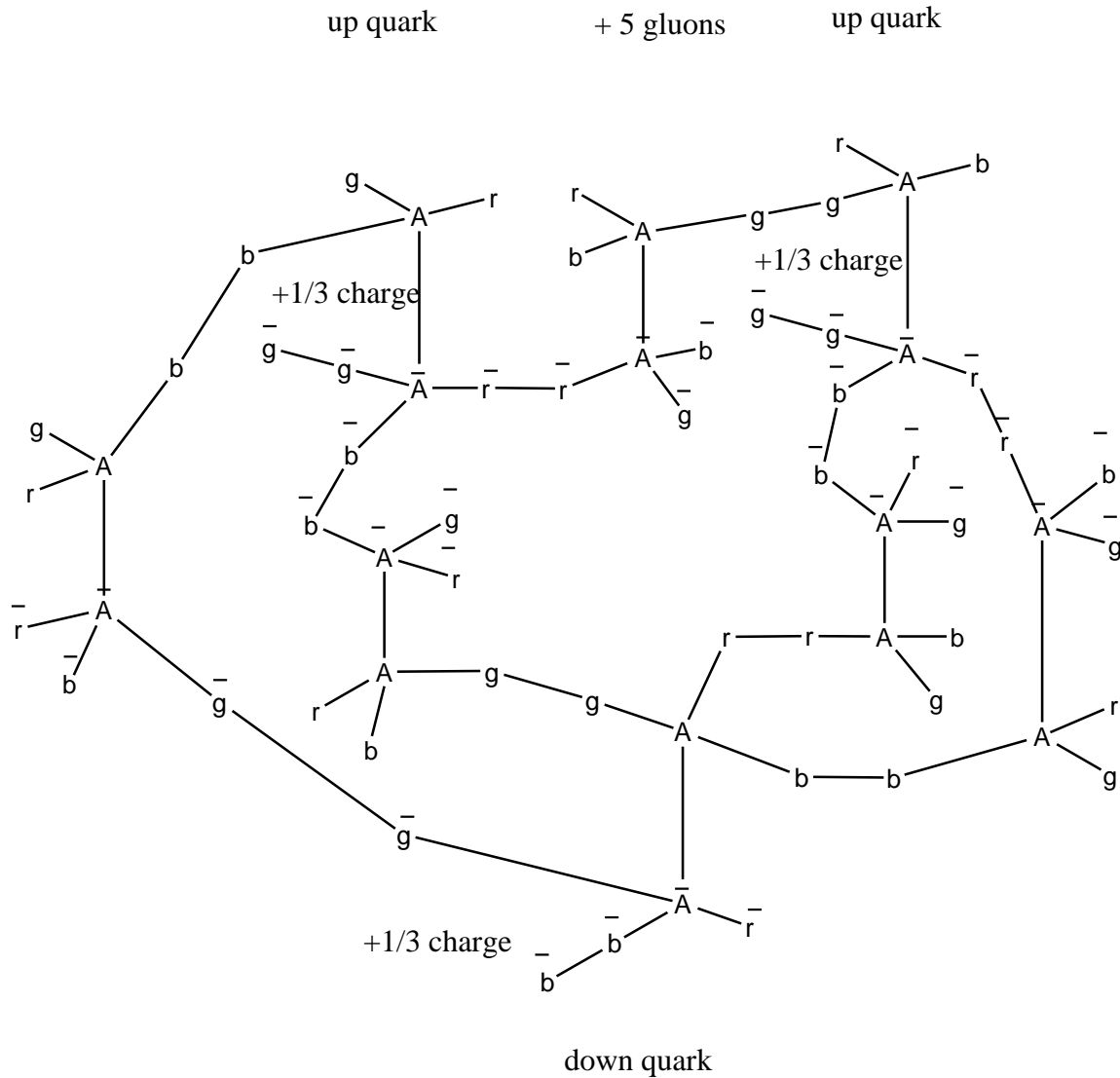

Structure 11. Structure of Proton(charge +1, spin 1/2)

From structure 11, the proton has charge +1 and spin 1/2. 2 up antiquarks and 1 down antiquark are glued by 5 gluons to form the antiproton, the structure of which is not shown.

1 Up quark and 2 down quarks are glued by 6 gluons to form a neutron.

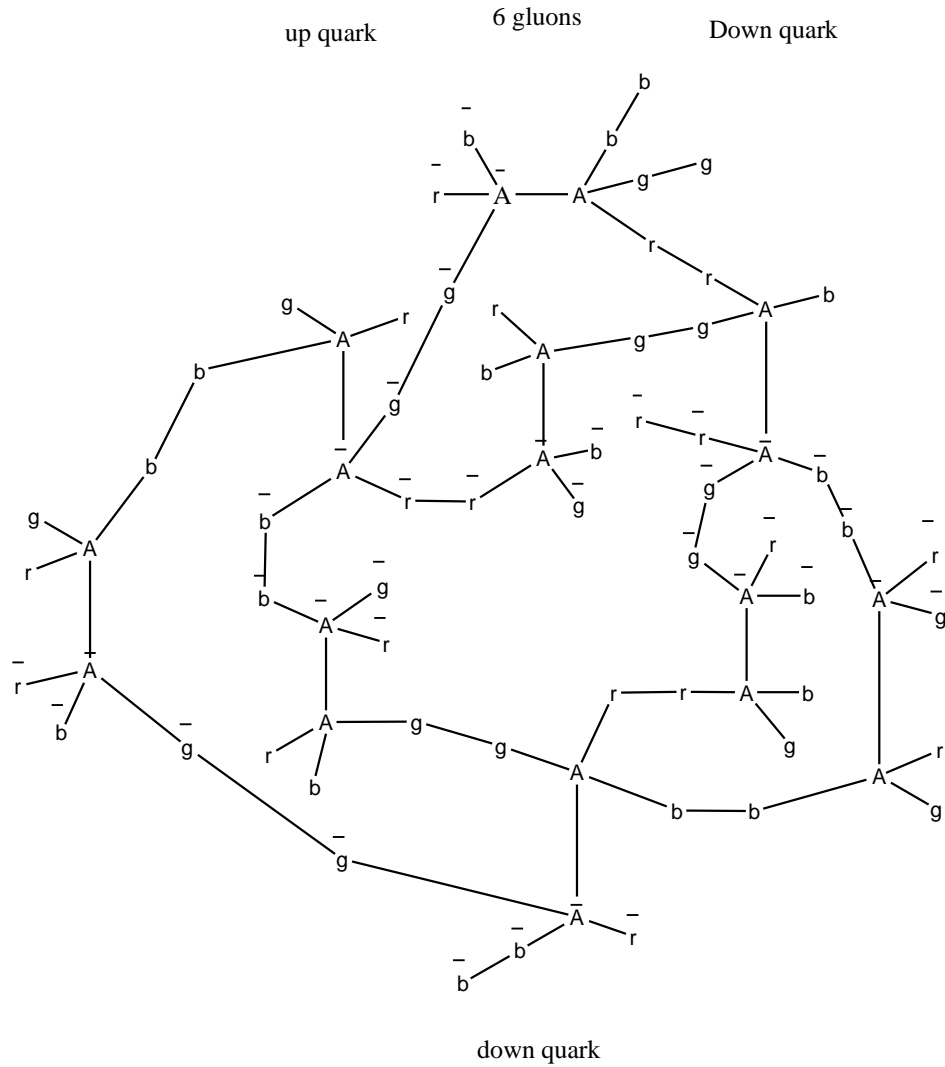

Structure 12. Structure of Neutron

From structure 12, neutron has charge 0 and it has spin $\frac{1}{2}$. 1 up antiquark and 2 down antiquark are glued by 6 gluons to form an antineutron, the structure of which is not shown.

Proton can be transformed to neutron and electron neutrino by capture of electron as shown as the following scheme 1.

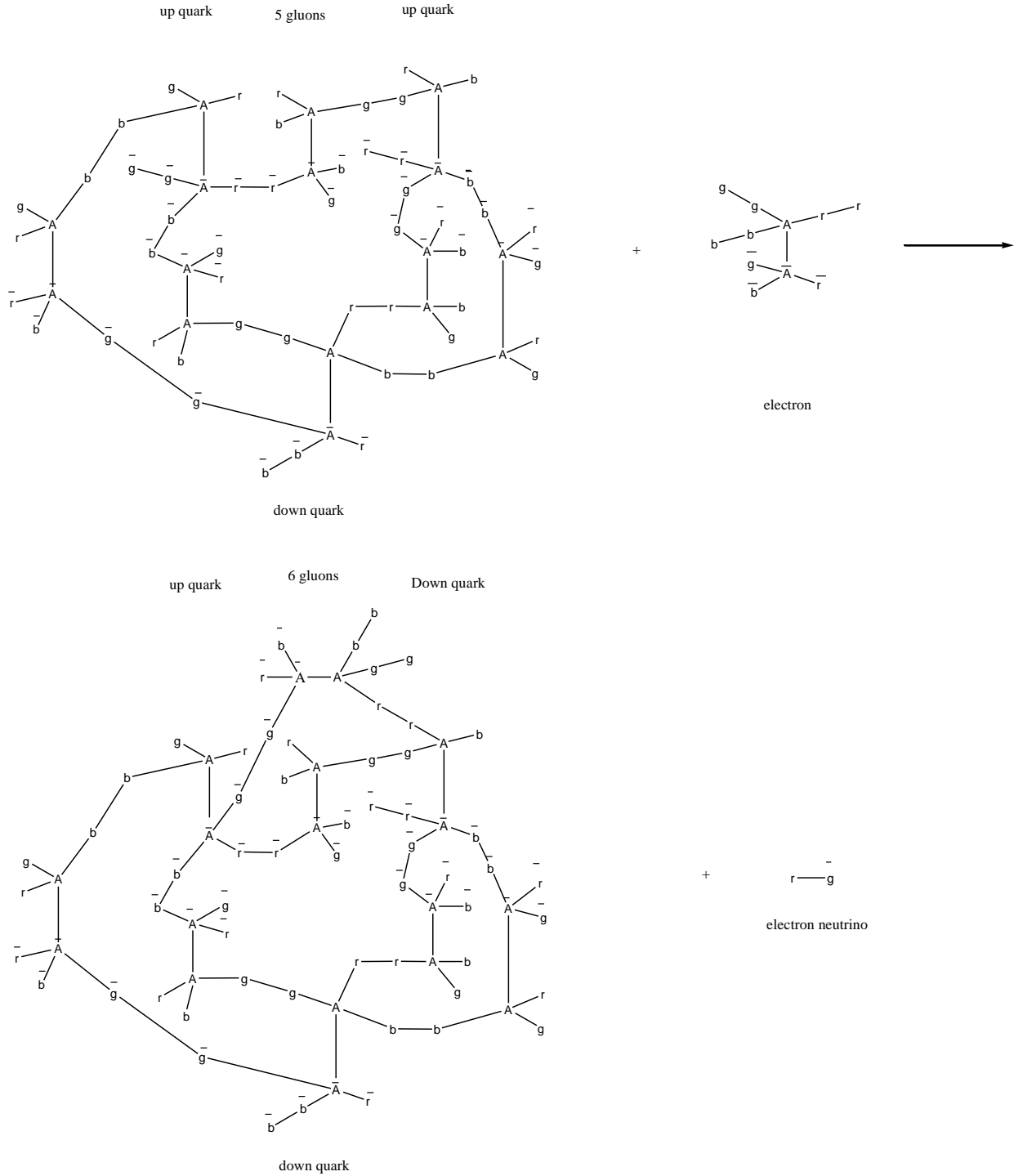

Scheme 1. Proton and Neutron Transform

From this transform scheme 1, the electron neutrino is $r-\bar{g}$, other neutrinos and antineutrinos may be: $b-\bar{g}$, $g-\bar{r}$, $b-\bar{r}$, $g-\bar{b}$, and $r-\bar{b}$. They may not bond together, but just stick together weakly, so they may have some mass. Another possibility is that they can bond in most strong

bonding, but they move at a speed higher than light speed, so the bonding is weakened. At light speed, photons will be free from any bonding, but neutrinos may still bond together weakly due to the fact that they are small and because the strong force is stronger for smaller particles. This hypothesis matches all neutrino properties: they are tiny, no charges, only flavors, spin 1/2 and anti neutrino antiparticles may be the same as neutrino particles.

There are 4 other quarks (exactly, any currently known “elementary particles” can be drawn from above basic structures and all other quarks are the combination of up quark, down quark, gluon and c-particles). Their structures and their main decay^{10,11} are shown in the following schemes 2-5:

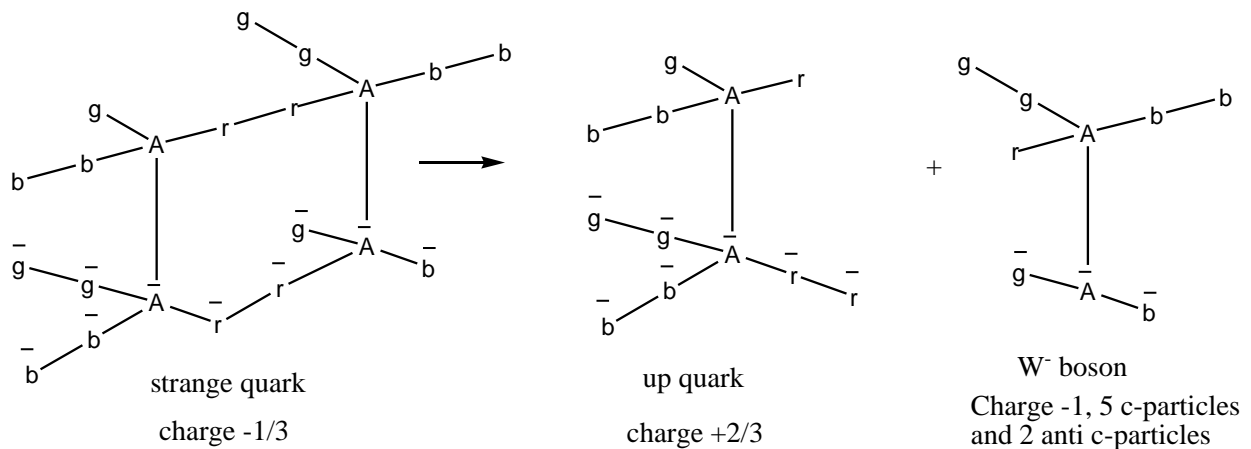

Scheme 2. Structure and Decay of Strange Quark

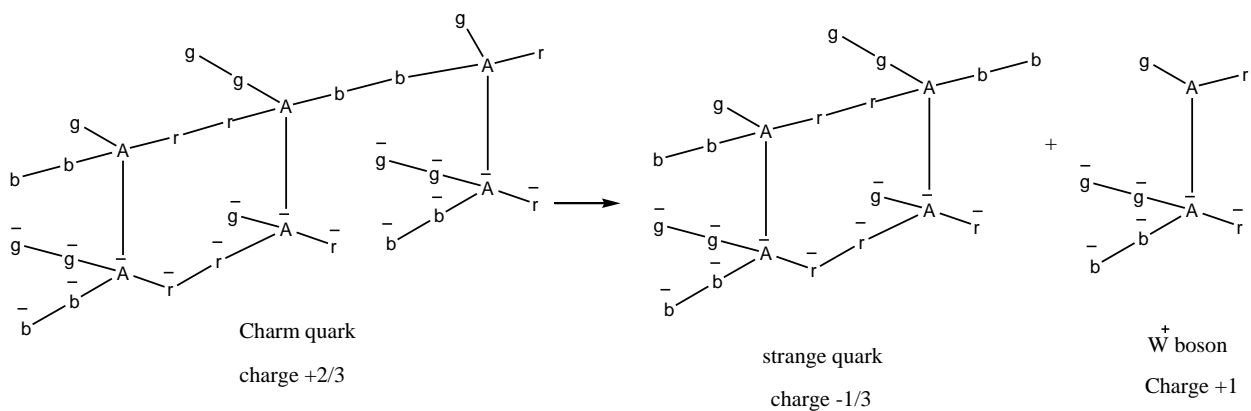

Scheme 3. Structure and Decay of Charm Quark

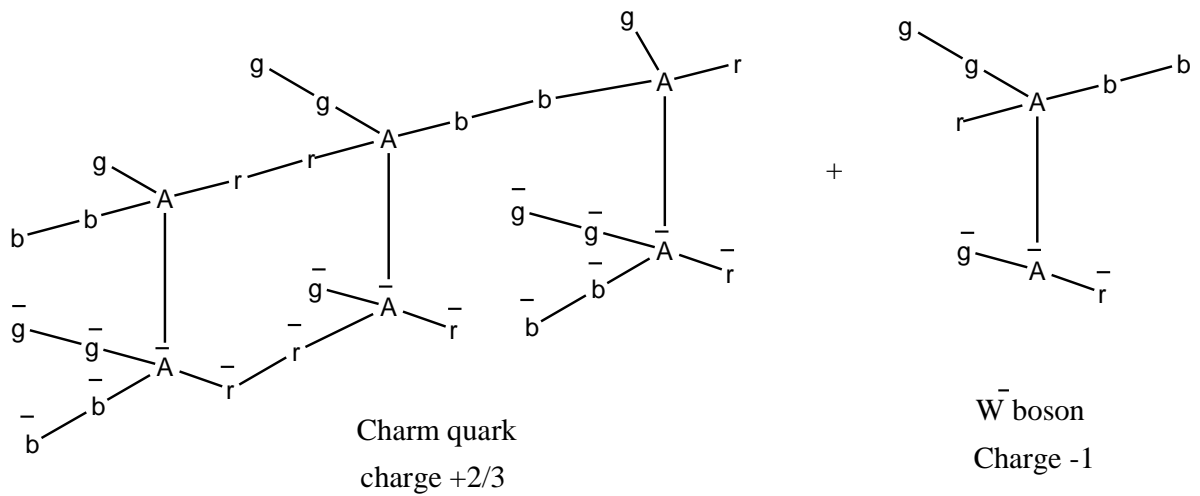
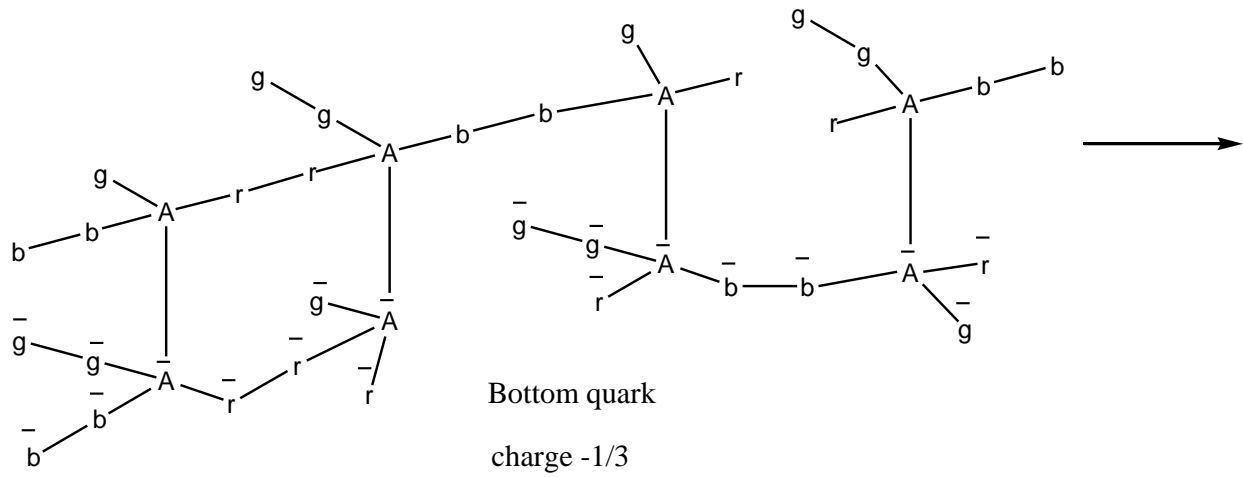

Scheme 4. Structure and Decay of Bottom Quark

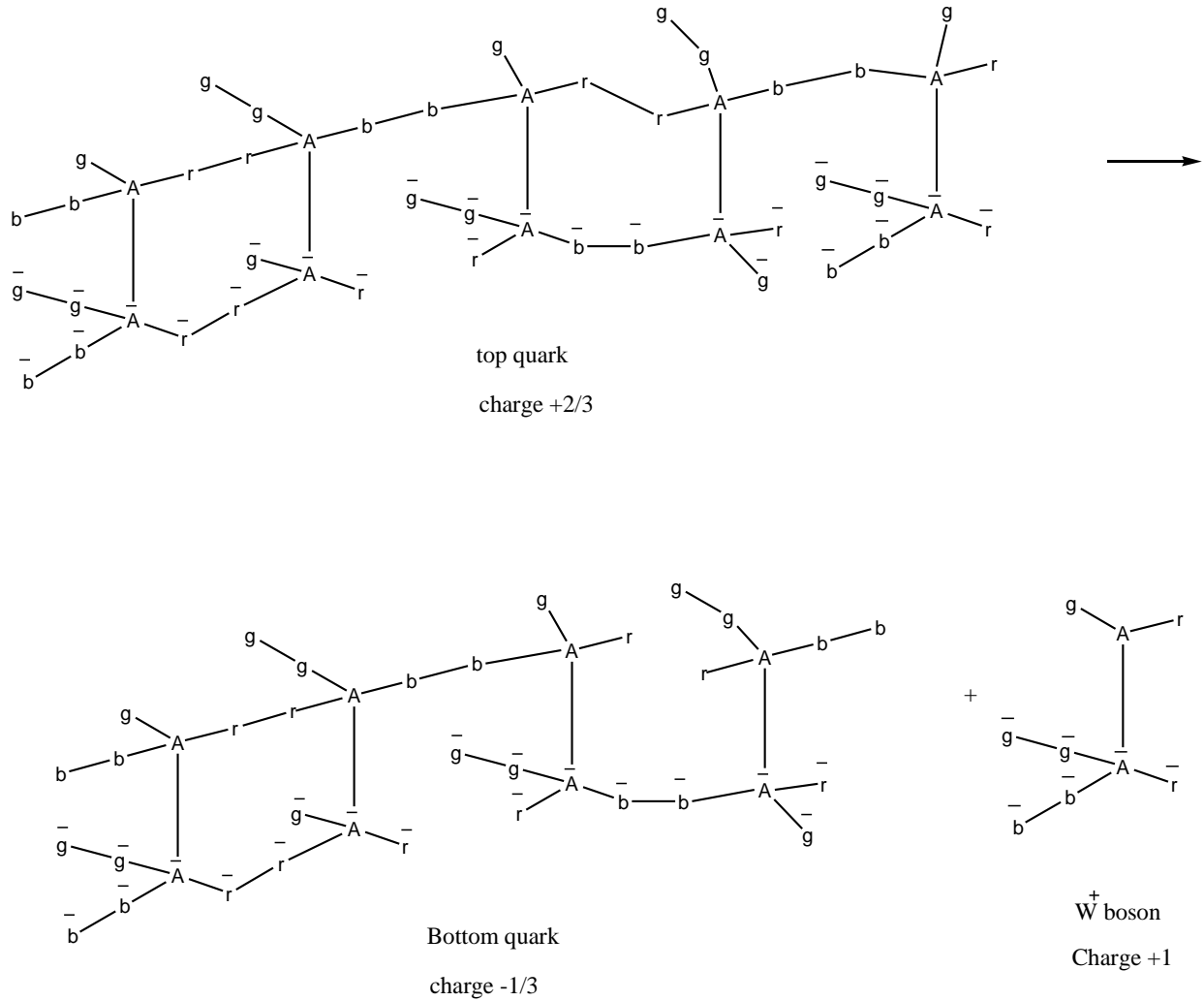

Scheme 5. Structure and Decay of Top Quark

Here, we have W^- and W^+ bosons structures that match the properties of W^- and W^+ bosons, -1 or +1 charge, which are very unstable and have short lives¹³. They are part of quarks with a half gluon structure.

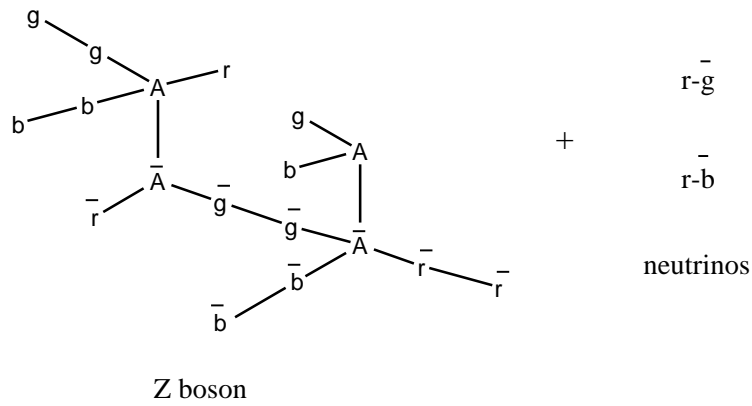
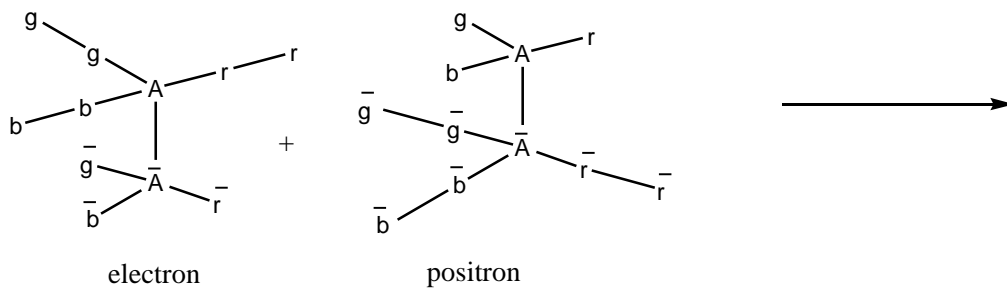
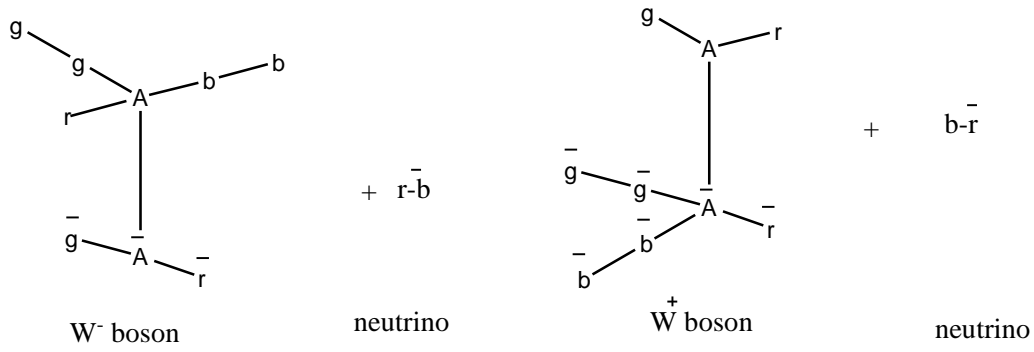
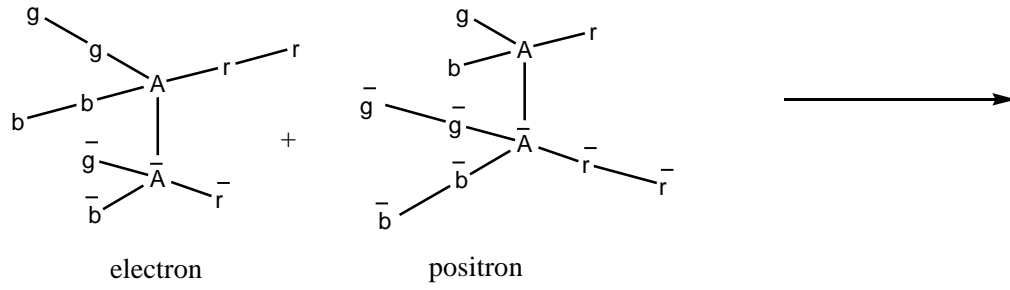

Scheme 6. High Energy Electron and Positron Annihilation

At high energy, electron and positron annihilation can produce one W^+ boson and one W^- boson and 2 neutrinos or produce only 1 Z boson and 2 neutrinos. This shows that the Z boson is a combination of one W^+ boson and one W^- boson.

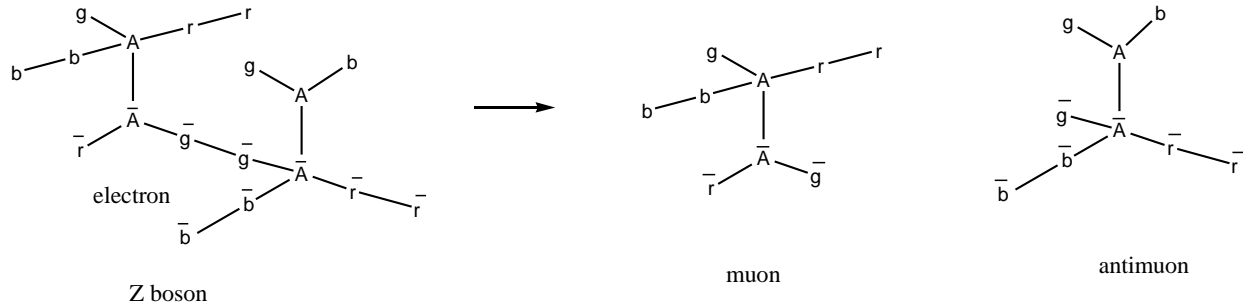

Scheme 7. Structure and Decay of Z Boson

From scheme 7, we have muon and antimuon structures. The muon has the same charge and spin $\frac{1}{2}$ as electron, but it has 200 times greater mass ($105.7 \text{ MeV}/C^2$ to $0.5 \text{ MeV}/C^2$) and is very unstable. Here, the symmetry and the bonding force play very important role to the mass of particles. From the annihilation of electron and positron to form Z boson and Z boson decay to muon and antimuon, but the mass of muon or antimuon is 200 times more than electron or positron, that is unthinkable, however, from the above structures, all these properties become very reasonable, anti A particle or its antiparticle is not saturated, the bonding between A particle and its anti particle is weak and they are more asymmetrical.

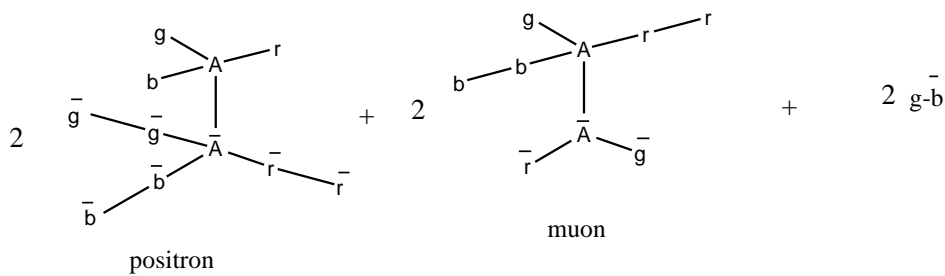
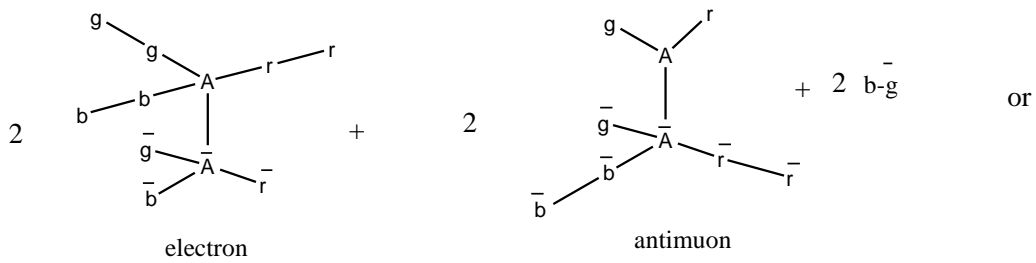
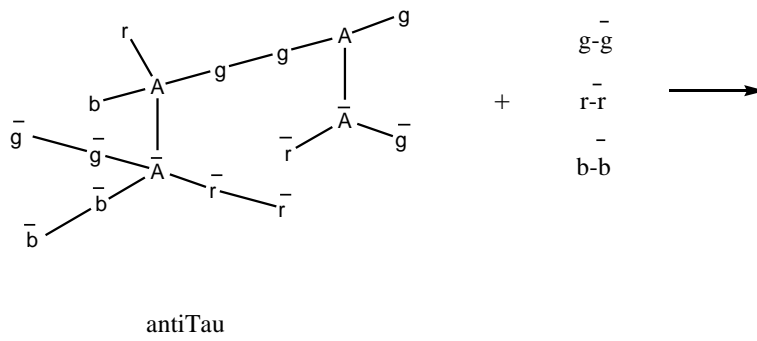
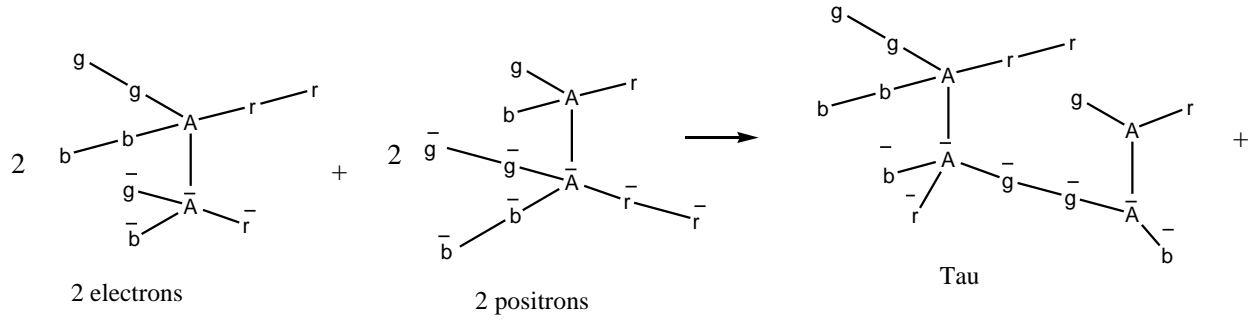

Scheme 8. Tau and anti-Tau Formation during Electron and Positron Annihilation.

Tau is very similar to a muon plus a gluon, so it is very unstable and decay to other particles immediately.

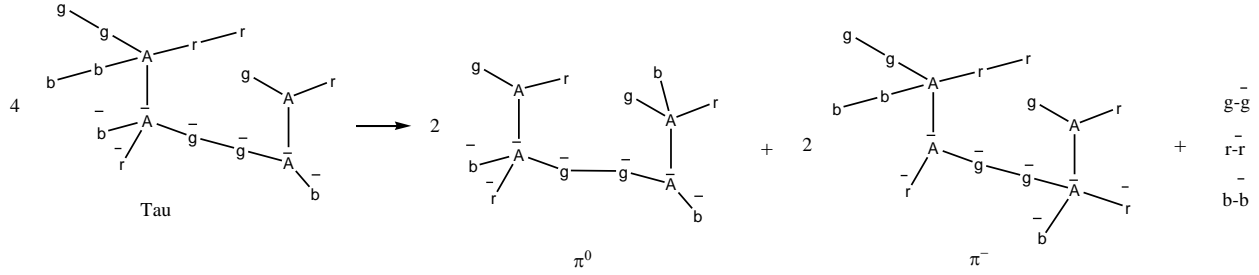

Scheme 9. Tau Decay

At low energy, the annihilation of electron and positron annihilation form 2 photons and some unknown particles⁹.

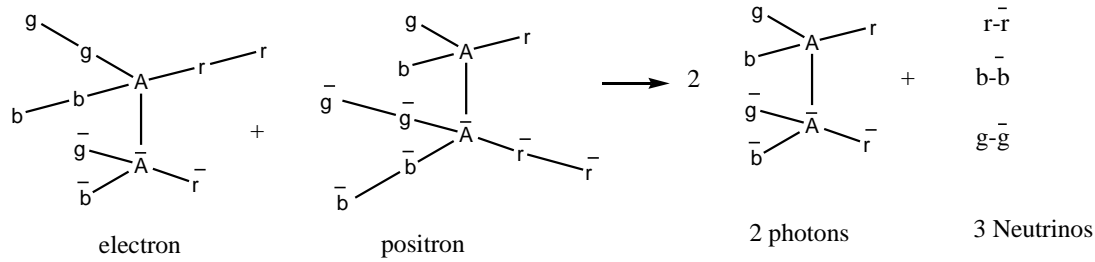

Scheme 10. Low Energy Electron and Positron Annihilation

There is one problem. We have said there are 6 neutrinos, which are $r-\bar{g}$, $b-\bar{g}$, $g-\bar{r}$, $b-\bar{r}$, $g-\bar{b}$, and $r-\bar{b}$, but from scheme 9 and 10, we see three more neutrinos: $g-\bar{g}$, $r-\bar{r}$, and $b-\bar{b}$. They are of the same color c-particles and anti c-particles, so they should be chargeless, colorless and flavorless and very difficult to be detected, there are total 9 neutrinos, but only six of them have been detected.

Why are these small bosons with only 6-7 c-particles and anti c-particles and A and its anti particle so heavy? The reason is they are very asymmetrical and the bonding between A and anti A is very weak. The importance of bonding force and symmetry surpasses the number of particles! W bosons are best known as mediators of neutrino absorption and emission, where their charge is associated with electron or positron emission or absorption. These properties can be explained clearly by the following scheme:

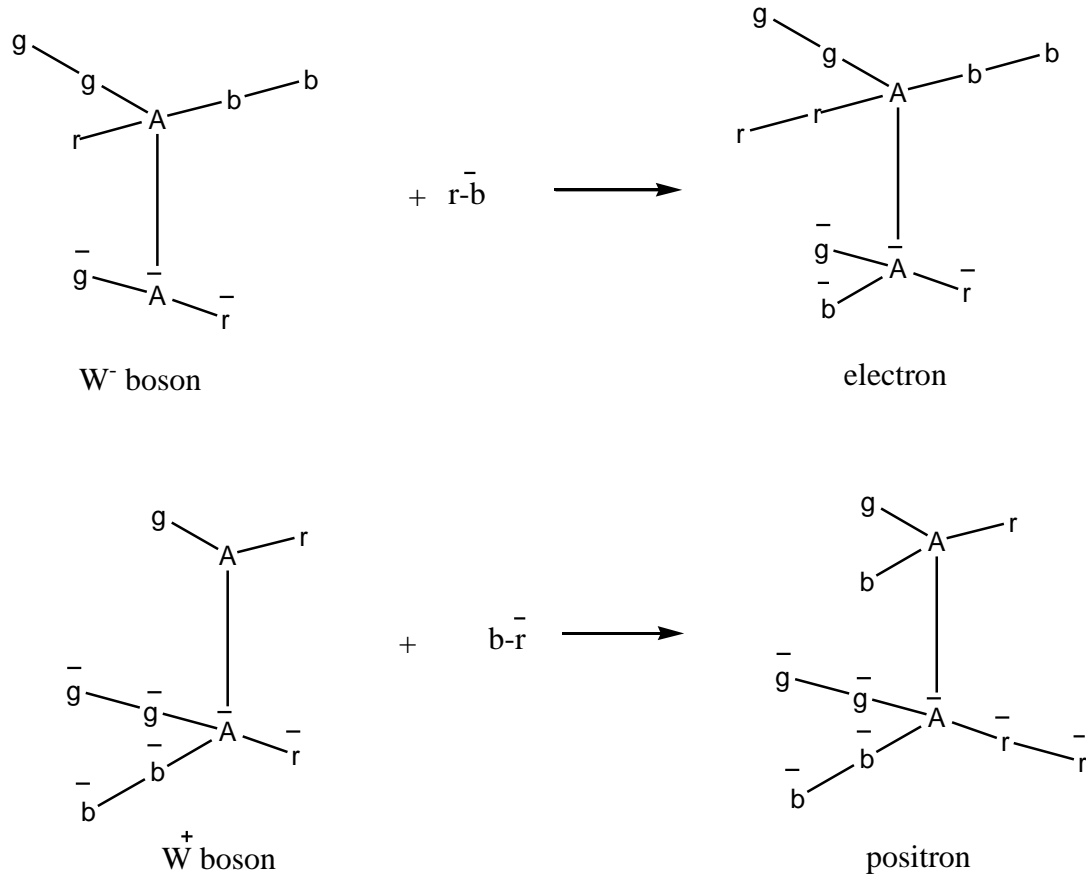

How about Higgs boson? If there is a Higgs boson, is it $A-\bar{A}$? It matches its properties: no spin, no charges, no color charges because it lost all its c-particles. It is its own antiparticle and is CP-even¹⁴. It has mass because all particles with mass come from it and anything to measure it with will interact with it. What causes the possibility of a black hole? Are all c-particles and anti c-particles broken off under the heat and the speed of movement of a black hole and only Higgs bosons ultimately left? If this is true, photon will be absorbed and broken off, so no photons will come out. Only c-particles and anti c-particles will come out, we may see black holes by detecting c-particles and anti c-particles or their combination, neutrinos. Do we throw away the old “aether theory” too easy? If yes, is aether made from c-particles and anti c-particles, or their combination? Everything have c-particles and anti c-particles and will absorb and emit c-particles and anti c-particles, so they will be in anywhere including vacuum tube because the tube wall can absorb and emit c-particles and anti c-particles. May everything interact with other things by exchange of c-particles and anti c-particles, or their combination? Is c-particles and anti c-particles, or their combination the force carriers of all force fields including gravitational fields? If it is true, c-particles and anti c-particles, or their combination pass everything by exchanges of c-particles and anti c-particles between matters, not by penetrating matters.

Proton and neutron are bonded together by mesons, what is the mesons structure? They should be similar to gluons. Mesons are composed of one quark and one antiquark with charges or without charges. Mesons are unstable and decay to form electrons and neutrinos (charged) or photons (uncharged). They may have the following structures. Only mesons made by up quark and down quark and their decay are shown. Other mesons are similar to them and can be drawn according to their properties, formation, and decay.

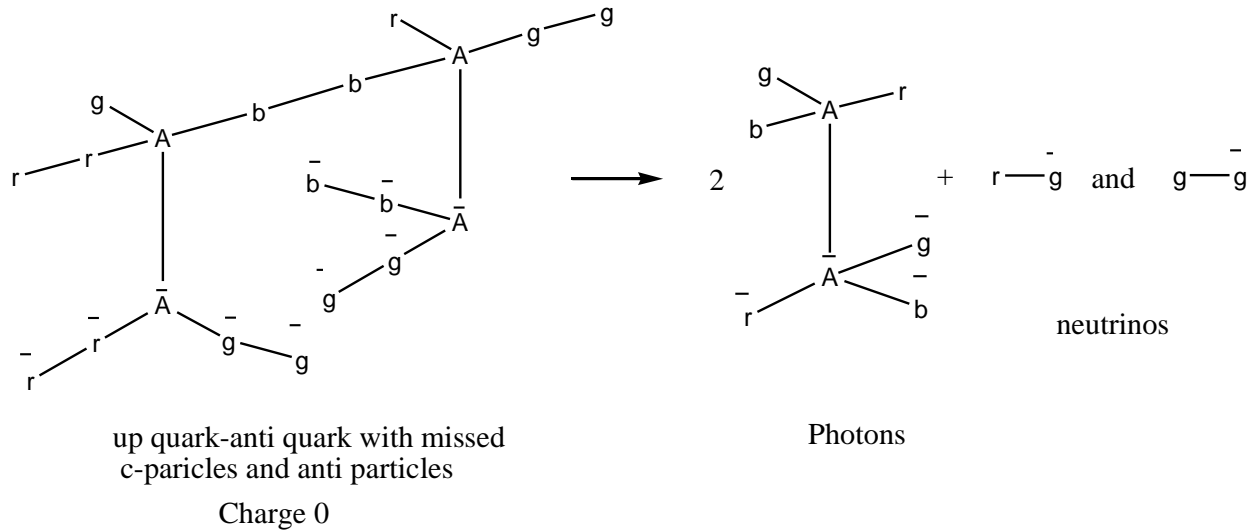

Scheme 12. Mesons without Charge Made from Up Quark and Up Antiquark with Missed c-particles and Anti Particles and Decay

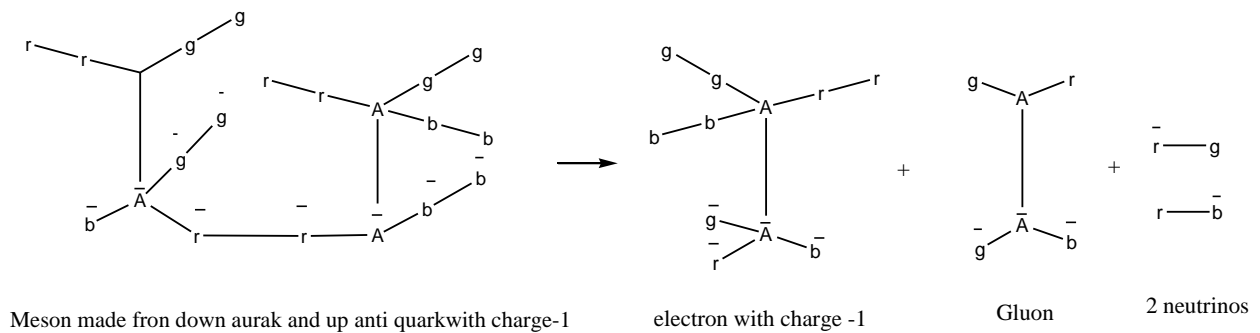

Scheme 13. Mesons with Charge Made from Down Quark and Anti Quark with Missed c-particles and Anti Particles and Decay.

The mesons are similar to gluons with 2 unsaturated bonding sites and the bosons have a gluon structures too. Here we have the blueprint of all particles which may need some modification. The heavy atoms have a many proton and neutron bonded by many mesons (protons and neutrons are not free particles in nuclei), so they are easy to decay due to the repulsion between same charge and color particles and loss parts of mesons to release bosons and they are radioactive. Quarks, gluons, protons, neutrons, and mesons are not elementary particles and they are broken pieces of nuclei. Can we design nuclear fusion and fission by these formulas just like

the design of chemical reactions by chemical formulas? Scheme 14 shows that the fusion of one deuterium nuclei to 1 helium nucleus needs 3 or more mesons, so we should supply some material which can produce 3 or more mesons (for simple, not every bonding is shown, the first proton can bond with the last neutron and there may be more bonding between protons and neutron). When every large atom splits to 2 smaller atoms, many mesons (the more protons and neutrons involved, the more mesons will be produced) will be produced. In a chamber where large atoms (not necessarily radioactive) and deuterium in a ratio close to 1:1 mesons are mixed, some high energy particles, such as neutrons are produced and hit the large atoms to induce fission to produce mesons, or laser is produced and hits the large atoms to induce fission to produce mesons. The mesons produced will bond 2 deuterium nuclei to 1 helium nucleus, and both fission and fusion will produce huge amounts of energy. Thus, a well controlled, very safe and environmentally friendly source of nuclear power is possible. Radioactive large atoms can produce mesons automatically and easy to use, but radioactive material is more difficult to produce and deal with. If heavy atoms, such as lead, and light atom, such as deuterium, are mixed in correct ratio, much lower temperature may need to induce both fission and fusion reaction and magnetic confinement fusion method may be a good choice.

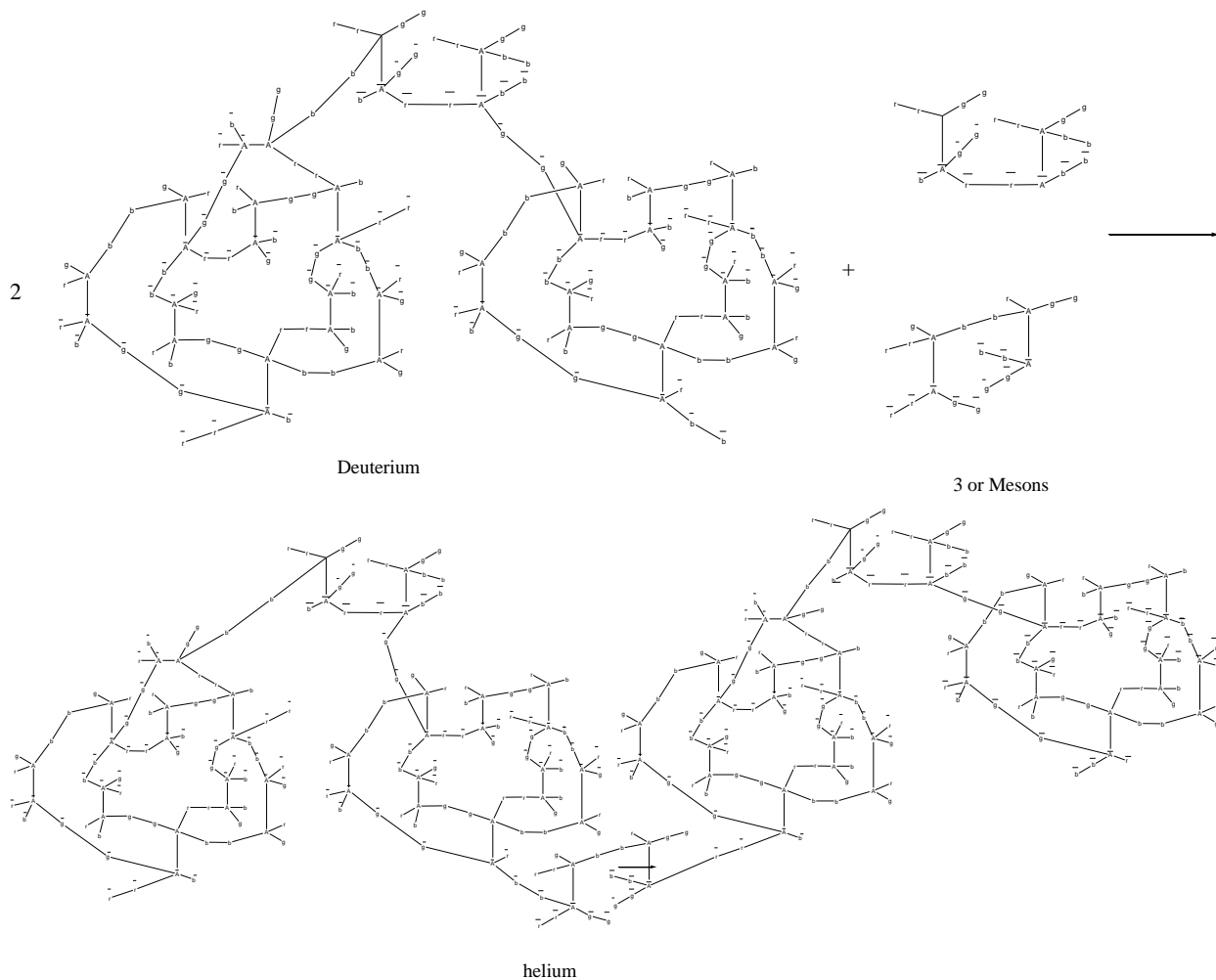

Scheme 14. Fusion of Deuterium to Helium

Can $^{200}\text{Hg} + \text{deuterium} + 3 \text{ mesons} = ^{197}\text{Au} + \text{helium}$ occur in reasonable conditions? Will the dream to change mercury atoms to gold atoms come true?

Gravitation comes from the lag of gluons, photons, mesons, protons, and neutrons, in exact words, the lag of c-particles and anti c-particles, which makes bonding of nucleons weaker and exposes more nuclear forces, and results in stronger residual forces of bonding forces between particles. Unlike the lag of electrons, it does not produce “dipoles”, so it is directionless. Everything is made from unknown elementary particles, A particle, c-particles, and their anti particles, and the force is not affected by electromagnetic fields, so the force is universal, directionless, and additive.

This hypothesis can answer many questions, anomalies and discrepancies.

The principle of invariant light speed includes 2 postulates, a definite velocity c and c is independent of the state of motion of the emitting body.

The first question is why the speed of light has a fixed value? A photon is like a sticky ball and can stick to almost every particle through c-particles and anti c-particles. When composite particles move at light speed, the bonding between photons and particles will be broken and photons will take off from the orbiting particles. Because of the structure of a photon, when there is only one photon, it bonds to particles in the same way and with the same strength, and free photons are almost massless and will not orbit to other particles, and so they will travel straight at the same speed. They may be attracted to huge gravitational bodies, such as sun due to the negligible mass. If black holes exist and the description of black holes is correct, photons are absorbed by black holes completely. Another possibility is that the black holes are very hot and move at very high speed, and so all particles will be broken down into c and A particles and their anti particles, and consequently no photon will exit in black holes, but we may detect c-particles and anti c-particles.

The second question is why that the speed of light in a vacuum is the same for all observers, regardless of the motion of the light source? If the light source is at rest, the photons bonding with electrons will take off from electrons when the moving speed of electrons reaches light speed c . If the light source is moving at the same direction of the light propagation and at half of light speed, $\frac{1}{2}c$, then the photons will take off when the moving speed of electrons reaches half of light speed, $\frac{1}{2}c$, $\frac{1}{2}c + \frac{1}{2}c = c$. At a fixed temperature, if the moving speed of electrons is 90% of light speed c , when the moving speed of the light source reaches 10% of light speed c , the photons will take off from the light source, so we have a fixed light speed regardless of the motion of the light source.

C-particles and anti c-particles may travel individually, or they travel in pair, such as neutrinos.

If they paired in $g-\bar{g}$, $r-\bar{r}$, and $b-\bar{b}$, they will be chargeless, colorless and flavorless and very difficult to detect. The movement of matter will produce lag of particles such as mesons,

neutrons, protons, electrons, and photons. The bonding between c-particles and A particles and their antiparticles will be weakened and a few of c-particles and anti c-particles will fly out and hit other matters, and other matters will emit the same number particles back to keep balance of c-particles and produce a gravitational field between them. If the number of c-particles is balanced, the number of c-particles a matter absorbed and emitted should be same. All forces may come from the orbiting c-particles to A particle and anti c-particles to anti A particle and exchanging of c- and anti c-particles between particles and matters. In other words, when the matters are at rest, c-particles and anti c-particles still move at very high speed, and the movement of matters will cause the lag of particles and push out some c-particles and anti c-particles that will hit other matters and are absorbed by other matters, for the balance of c-particles and c-particles, other matters must emit same number c-particles and anti c-particles. C-particles and anti c-particles, or their combination may be the force carriers of all forces including gravitational force. There may be only one force which comes from the interaction of A and c-particles and their anti particles and a side product, the electromagnetic force, due to the asymmetry and unbalanced numbers of c-particles and anti c-particles. C-particles and anti c-particles, or their combination pass everything by exchanges of c-particles and anti c-particles between matters, not by penetrating matters and they may be the aether in the old “aether theory”.

In photon and gluons, the c-particles and anti c-particles are connected to A and anti A particles directly, the orbit radius, r , is shortest, the force will be strongest. Between the particles, the bonding forces may come from exchanging of c- and anti c-particles, the distance, r , is shorter, the exchanging is more often, the bonding forces are stronger, like the strong force between quarks and the nuclear forces (weaker than strong forces) between protons and neutrons. Between the Sun and the Earth, the distance is long and the exchanging of c-particles will be less often and the force (gravitation) bond them will be weaker. A body moves faster, more c-particles and anti c-particles will be push out and needs to absorb more c-particles and anti c-particles to keep balance, and resulted in more exchanging of c-particles and anti c-particles and stronger gravitational force.

The energy of a photon is dependent on the orbiting radius of the particles they are bonded to: if the radius is smaller, the orbiting speed of the particles will be faster and the force will be stronger. According to Newton’s laws of motion, everything will continue moving straight, and if the force produced by orbiting causes a particle to circle, this will cause the particle to vibrate. If radius of the orbiter is smaller, the particles with bonded photons will orbit faster, the force will be stronger, and the vibration will be faster. The vibration is not in the same direction as the orbiting, so it does not change the bonding force in the orbiting direction, so any low and high energy photons eject from composite particles at the same speed: light speed. When the photons leave the particle, they will continue vibrating like waves. Higher energy photons vibrate faster and have short wavelengths. Photons of different wavelengths travel at same speed only in the

direction of propagation of the wave, but the true path they travel is different, and photons with shorter wavelengths (higher energy) travel longer real distances because they are vibrating faster.

When photons hit matter, photons will stick to that matter, and the mass of that matter will be increased not by the mass of photon, but by the increase of asymmetry and lagging, as energy will be changed to mass, when photons are broken off from a matter, the mass of that matter will be decreased not by the mass of photon, but by the decrease of asymmetry and lagging, as mass will be changed to energy, Mass–energy equivalence¹⁵, $E = mc^2$, where m is mass and v is the moving speed of a matter, the relationship between mass and energy becomes a natural answer. A photon is a composite particle (matter) with negligible mass and high kinetic energy, not a pure energy, there is only mass-energy equivalence, but not a matter-energy equivalence. The entropy increase of matter due to the photon bonding will be small, but the environmental entropy decrease is large due to free photons with very high entropy. This process may be the automatic reverse of the second law of thermodynamics.

To make Mass–energy equivalence, $E = mc^2$, reasonable, we need the help of the Lorentz factor, γ . We must change mass–energy equivalence, $E = mc^2$ to $E = \gamma mc^2$, where m and v is same as above and γ is the Lorentz factor. However we do not know what the Lorentz factor, γ is and why the γ factor approaches infinity as v approaches c , and it would take an infinite amount of energy to accelerate an object with mass to the speed of light. According to our theory of gravitation, when matter moves, there may be the lag of particles, which makes bonding of nucleons weaker and exposes more nuclear forces, and results in stronger residual forces of bonding forces between particles and greater gravitation which make it impossible for any particles with heavier mass than photons to travel in light speed before they are broken down to photons and other particles with less mass, a answer to the upper limit on speeds.

The A particle, c-particles, their anti particles are bonded to form quarks, gluons, protons, neutrons, mesons and photons that are bonded together to form matters. These particles orbit each other to produce a bonding force that becomes stronger as the matter in question moves faster. If this hypothesis is true, then no dark matter is required to explain the motion of galaxies. It may explain why everything continues moving in circle because when one composite particle moves, it will induce another composite particle to move. It may be that this is the cause of the expansion of the universe, and therefore “dark energy” is not necessary.

The movement (rotational or orbital) of matter (such as the sun) may induce more lag of the movement of elementary particles, gluons, photons, mesons, protons, and neutrons in other matter (such as the Earth), which causes the residual force of the bonding force between composite particles to become stronger and accelerates the rotation or orbit of other matters. It can explain Kepler’s laws of planetary motion¹⁶, a line segment joining a planet, and the Sun sweeping out equal areas during equal intervals of time, as a planet moves faster when it is closer to Sun. If this is true, gravitation between a planet and the sun becomes stronger and the planet

will move faster as the temperature of the planet is higher (if temperature is higher, the energy of the system will be higher and the bonding between particles will be weaker and the lag of particles will be larger). When a planet is close to the sun, therefore, the increased heating of the planet by the sun will accelerate the planet orbiting the sun and the sun will pull it closer. When the planet is leaving the sun, and its temperature becomes lower, it has a weaker gravitation, moves farther, and has a more eccentric orbit. For example, the sun much more quickly heats small planets, such as Mercury and Mars, when they are close to the Sun, and Mercury has the most eccentric orbit of all the planets and Mars has the second most eccentric orbit. For very small comets, this effect will be even bigger. Their tail will shrink when they are leaving the sun, and the shrinking gas provides extra force to push them farther, so that their orbit around the Sun is highly elliptical.

The flyby anomaly is an unexpected energy increase during Earth-flybys of spacecraft and not only the flyby anomaly itself, but also the unpredictable amount of the flyby anomaly challenge scientists to give an explanation. If the hypothesis is true, then the speed and trajectory inclination to equator of spacecraft will affect the amount of the flyby anomaly and flyby anomaly will be solved.

Quantum entanglement is an unsolved problem. If the c-particles and anti c-particles are true and are massless, they should move at a much higher speed than the light speed. Everything has c-particles and/or anti c-particles and any measurement will involve c-particles and anti c-particles. If this is true, the entangled particles may “communicate” and control each other by c-particles and anti c-particles traveling or just exchanging.

From all the above structures, we can see the result: elementary particles and their anti particles are equal in total. There is far more matter than antimatter than chance would dictate, and more c-particles form electrons and more anti c-particles form protons.

In fluid dynamics, turbulence is a flow regime characterized by chaotic property changes. This includes low momentum diffusion, high momentum convection, and rapid variation of pressure and flow velocity in space and time. All matter on Earth moves at very high speeds, as the Earth’s orbital speed is about 29.78km/s, 0.01% of light speed. The solar system’s orbital speed is much faster, at about 220km/s, 0.07% of light speed, and the Milky Way’s speed relative to CMB rest frame is 552km/s, 0.18% of light speed. These movements are always changing in direction and the Earth vibrates when it orbits the sun. All these forces will affect liquid and gas movement and create turbulence. If we can include all these forces in fluid dynamics, we may get much better solutions than we do now, though still never perfect solutions.

If the big bang theory is true, why are the compositions of planets in the same Solar System different? Does the size of astronomical objects decide their compositions? After the big bang, there are only A and c-particles and their anti particles, the universe cooled sufficiently to allow the formation of subatomic particles that were glued by gluons to form protons, then to different size nearly perfect spherical ball of hot plasma. The small one will cool down faster and to form different elements (heavier atoms) to become Mercury, Venus, Earth and Mar, the big ones are cooling very slowly or not cooling due to the heat from radiation, friction of the moving particles, and other interaction to form Sun, Jupiter and Saturn, Uranus and Neptune (ice giants) are between terrestrial planets and gas giants.

Superconductivity is a phenomenon of exactly zero electrical resistance and expulsion of magnetic fields occurring in certain materials when cooled below a characteristic critical temperature. At lower temperature, photons stick to electrons and protons tightly. When photons bond with electrons (photons can bond each other through c-particles or A to anti A particle), 2 electrons in same orbit may be bonded together to form Cooper pairs¹⁷. The electron pairs will behave as boson-like particles with spin 1 due to the increase of symmetry, many electron pairs can stay in a same energy level. Photons can also bond with the nuclei to shade the positive charges of proton and weaken the bonding force between these electron pairs and protons, the photon-bonded electrons can move like free electron without resistance if the nuclei of atoms are fixed and vibrate very slowly.

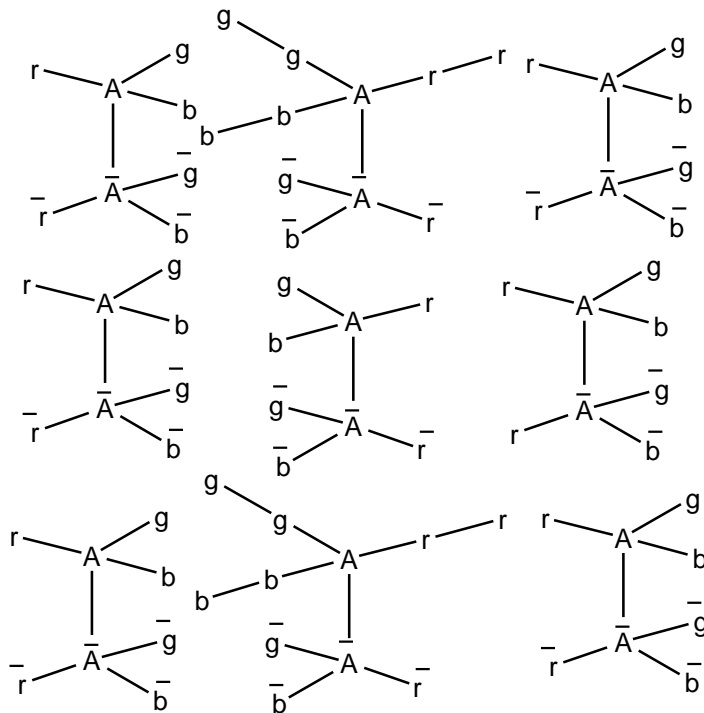

Figure 4. Structure of Cooper Pairs(electron)

Photoelectric effect is the observation that many metals emit electrons when light shines upon them. If the photon energy is too low, photons will stick to electrons, but the electron is unable to escape the material. If the photon energy is very high, photons will stick to electrons and transfer more energy than the work function of the metals and the electron will escape the material, some of the energy liberates the electron from the atom, and the rest contributes to the electron's kinetic energy as a free particle.

A laser is a device that emits light through a process of optical amplification based on the stimulated emission of electromagnetic radiation. Electrons in same energy levels absorb light (photons), the photon-bonded electrons are similar to Cooper pairs, so large number of photon-bonded electrons can stay in same energy levels and the electron's kinetic energy will be unified due to the transfer of energy between them to form excited electrons with almost same energy level. When electrons in the excited state decay to a lower energy state, then the photons with same energy are emitted in high temporal coherence.

Large number of photons may fill the space between the electrons and the nucleus of an atom to stabilize the atom, just like the water molecules stabilize the cells. When a matter is getting hotter, the bonding between photons and electrons, and nuclei will be weakened and some photons will emitted off from the matter, this may be the reason that everything is a light source at high temperature. When matters absorb more low energy photons, the incoming photons will transfer kinetic energy to other photons and particles in matters and make them move faster to produce heat, but not enough to release photons. Thermal conduction may involve photons exchanges. The biologically hazardous of X-ray and gamma ray may not only from the direct ionizing (limited to the surface tissues), but also from disturbing the photons, electrons, and nuclei bonding (can reach the deep tissues).

Conclusion

Every matter is moving in very high speed because the Milky Way's speed relative to CMB rest frame is 552km/s, 0.18% of light speed. When matter moves, there may be the lag of gluons, photons, mesons, protons, and neutrons, in exact words, the lag of c-particles, A particle and their anti particles, which makes bonding of nucleons weaker and exposes more nuclear forces, and results in stronger residual forces of bonding forces between particles. Gravitation, then, may be the residual force of the bonding force between particles. Unlike the lag of electrons, it does not produce "dipoles", so it is directionless. Everything is made from unknown elementary particles, A particle, c-particles, and their anti particles, and the force is not affected by electromagnetic fields, so the force is universal, directionless, and additive. This all matches the properties of gravitation. The bonding forces come from c-particles orbit A-particle and anti c-particles orbit anti A particle, they may not be one to one, but just like electrons orbit a mixture

of protons and neutrons, but c-particles may or may not orbit the mixture of A-particles and \bar{A} -particles, c-particles may orbit only A-particles and anti c-particles may only orbit \bar{A} -particles, that means c-particles cannot mix with anti c-particles, A-particles pair with \bar{A} -particles in one to one. C-particles and anti c-particles may move at a speed faster than light speed. C-particles are fermions with spin $\frac{1}{2}$. The composite particles orbit each other to produce a bonding force due to the lag of elementary particles. The first orbiting forces are from the kinetic energy of c and A particles and their anti particles. The bonding force will be stronger and the orbiting speed will be faster if the orbit radius is smaller. The force that bonds elementary particles together to form quarks is much stronger than the strong force that bonds quarks to protons and neutrons. The force between electrons and the nucleus will be more than 10 orders of magnitude weaker than this force that bonds quarks to protons and neutrons, due to the fact that the size of an atom is more than 5 orders of magnitude larger than the size of protons and neutrons. As the force is inversely proportional to the square of the distance, r, then the electronic force will overshadow the strong force at the atom levels. According to this model, there may be only one force which comes from c-particles orbit A particle and anti c-particles orbit anti A particle and a side product, the electromagnetic force, due to the asymmetry of c-particles and anti c-particles.

References

1. I Newton *Principia(General Scholium, Andrew Motte's English translation)*, Book 3, Vol 2 p 392(1729).
2. A Einstein *Annalen der Physik* **354** (7): 769(1916)
3. H Babcock, *Lick Observatory bulletin*; no. 498(1939)
4. P J E Peebles and B Ratra *Reviews of Modern Physics* **75** (2): 559(2003)
5. J.D Anderson, J K Campbell, and M M Nieto *New Astronomy* **12** (5): 383(2007).
6. M Chown *New Scientist* March 16, 2009
7. S Carroll, *Dark Matter, Dark Energy: The Dark Side of the Universe, Guidebook Part 2* (The Teaching Company) p 59 (2007)
8. S Braibant, G Giacomelli, and M Spurio *Particles and Fundamental Interactions: An Introduction to Particle Physics (2nd ed.)(Springer)* p 1(2012).
9. L Sodickson, W Bowman, J Stephenson, and R Weinstein *Physical Review* **124**: 1851(1970).
10. A Quadt (2006) *European Physical Journal C* **48** (3): 835(2006).
11. J. Beringer et al. "PDGLive Particle Summary 'Quarks (u, d, s, c, b, t, b', t', Free)'"(Particle Data Group), PR D86, 010001 (2012)
12. F London *Transactions of the Faraday Society* **33**: p 8(1937).

13. J Beringer *et al.* *Physical Review D* **86**: p 1(2012).
14. S.S.M. Wong *Introductory Nuclear Physics (2nd ed.)* (New York: John Wiley & Sons) p. 21(1998).
15. A Einstein *Annalen der Physik* **18**: 639(1905)
16. C Wilson “Kepler’s Laws, So-Called”, *The Newsletter of the Historical Astronomy Division of the American Astronomical Society*, May 1994, Number 31.
17. L N Cooper *Physical Review* 104(4): 1189(1956).