

# Higgs-Higgs Interaction. The One-Loop Amplitude in the Standard Model \*

Valeriy V. Dvoeglazov  
Universidad de Zacatecas  
A.P. 636, Suc. 3 Cruces, Zacatecas 98068 Zac. México  
E-mail: [valeri@fisica.uaz.edu.mx](mailto:valeri@fisica.uaz.edu.mx)

Received on: August 20, 2015

## Abstract

The amplitude of Higgs-Higgs interaction is calculated in the Standard Model in the framework of the Sirlin's renormalization scheme in the unitary gauge. The one-loop corrections for  $\lambda$ , the constant of  $4\chi$  interaction are compared with the previous results of L. Durand *et al.* obtained on using the technique of the equivalence theorem, and in the different gauges.

---

\*The talk presented at the *Meeting of the DPF of the APS, May 24-28, 2002, The College W&M, Williamsburg, VA, USA*, May 26, 2002. Originally, it was on the website [http://www.dpf2002.org/abstract\\_display.cfm?abstractid=26](http://www.dpf2002.org/abstract_display.cfm?abstractid=26), which was promised to be permanently active.

# 1 Introduction.

The Higgs sector of the electroweak theory attracts much attention because of its connection with the cornerstones of the theory. The search for Higgs scalars is included in most of the experimental programs of the newcoming and acting accelerators [1]. The Higgs particles are suggested to be found in the decays of different particles ( $Z^0$  bosons, heavy quarkoniums etc.) as well as in photon-photon interactions and gluon-gluon fusion. In connection with that, let us mention non-so-long-ago attempts to explain anomalous events seen at  $SpS$  as the manifestation of the bound state of two Higgs bosons, i. e. of Higgsonium [2]-[4] or that of the bound state of vector boson [5] in accordance with the Veltman paper, Ref. [6]. Nowadays, even after clarifying the experimental situation with these anomalous events, the interest in Higgsonium has still the rights for existence at least from the viewpoint of preparedness to new unexpected news from the experiment. The previous investigations of the problem of existence of two-Higgs bound states were based on the Born approximation of their interaction amplitude [2]-[4]. In the present paper we present the results of our calculation of the amplitude of Higgs-Higgs interaction up to the fourth order in the framework of the Standard Model (SM) of Weinberg, Salam and Glashow with one Higgs doublet. This problem is also of present interest since there is some relations with the idea that gauge vector bosons could originate from a strong interacting scalar sector of the electroweak theory [7]. The amplitude obtained in this paper could also be useful for the consideration of the problem of the unitarity limit (e. g., [8]). Moreover, information on the behaviour of the Higgs coupling constants at mass scale  $M$  would be also of interest.

These are the reasons why we start a more complete study of the problem of Higgs-Higgs interaction. To reduce the volume of the article we shall use the standard notation used in [9], dimensional regularization and the renormalization scheme on the mass shell, which is analogous to that suggested in [9, 10]. We also choose the unitary gauge ( $\xi \rightarrow \infty$ , to avoid ghosts) and the parameters recommended by the Trieste conference [11], namely  $(e_0, M_{W_0}, M_{Z_0}, M_{H_0}, m_{f_0})$ .

The Higgs sector of the Lagrangian of the SM with one Higgs field has

the following form, e. g. [12]:<sup>1</sup>

$$\begin{aligned}
\mathcal{L} = & -\frac{1}{2}(\partial_\mu\chi)^2 - \frac{1}{2}M_\chi^2\chi^2 - \frac{e}{2M_W(1-R)^{1/2}}\sum_f m_f\bar{f}f\chi - \\
& - \frac{eM_W}{(1-R)^{1/2}}W_\mu^+W_\mu^-\chi - \frac{eM_Z}{2R^{1/2}(1-R)^{1/2}}Z_\mu^2\chi - \frac{e^2}{4(1-R)}W_\mu^+W_\mu^-\chi^2 - \\
& - \frac{e^2}{8R(1-R)}Z_\mu^2\chi^2 - \frac{eM_\chi^2}{4M_W(1-R)^{1/2}}\chi^3 - \frac{e^2M_\chi^2}{32M_W^2(1-R)}\chi^4, \quad (1.1)
\end{aligned}$$

where  $e$  is the electron charge,  $M_\chi$  is the Higgs mass,  $M_W$  and  $M_Z$  are the masses of the vector bosons,  $m_f$  are the fermion masses,  $R = M_W^2/M_Z^2$ .

The paper is organized as follows. In Section 2 we present the expressions for the self-energy and vertex parts (see also calculations in details in [13]). The results of the calculation of the total Higgs-Higgs amplitude will be presented in Section 3. The Appendix contains the definitions of some integrals met in calculations. Their connections with the integrals calculated in [14, 15] is given.

---

<sup>1</sup>It is possible to add the pseudoscalar fermionic interaction,  $\sim (1 + b_i\gamma_5)$ .

Table I. Coupling constants in the case of the Standard Model.

$f^W$	$-\frac{1}{2\sqrt{2}}g$	$f^{WWZA}$	$ig^2\sqrt{R(1-R)}$
$f^Z$	$-\frac{1}{4}\frac{gM_Z}{M_W}$	$f^{W\chi}$	$-igM_W$
$f^A$	$eQ_i$	$f^{Z\chi}$	$-i\frac{gM_Z^2}{M_W}$
$f^{WWZ}$	$-\frac{gM_W}{M_Z}$	$f^{2W2\chi}$	$-i\frac{g^2}{2}$
$f^{WWA}$	$e$	$f^{2Z2\chi}$	$-i\frac{g^2M_Z^2}{2M_W^2}$
$f^{2W2Z}$	$-i\frac{g^2M_W^2}{M_Z^2}$	$f^\chi$	$-i\frac{gm_i}{2M_W}$
$f^{4W}$	$ig^2$	$f^{3\chi}$	$-i\frac{3gM_\chi^2}{2M_W}$
$f^{2W2A}$	$-ie^2$	$f^{4\chi}$	$-i\frac{3g^2M_\chi^2}{4M_W^2}$

The Kobayashi-Maskawa  $K_{ij}$  matrix,  $g = e/\sin\theta_W$  are used in the full Lagrangian of the SM,  $2P = -\frac{1}{\epsilon} + \gamma + \ln(M_W^2/4\pi\mu^2)$  are used in the dimensional regularization,  $\gamma$  is the Euler constant.

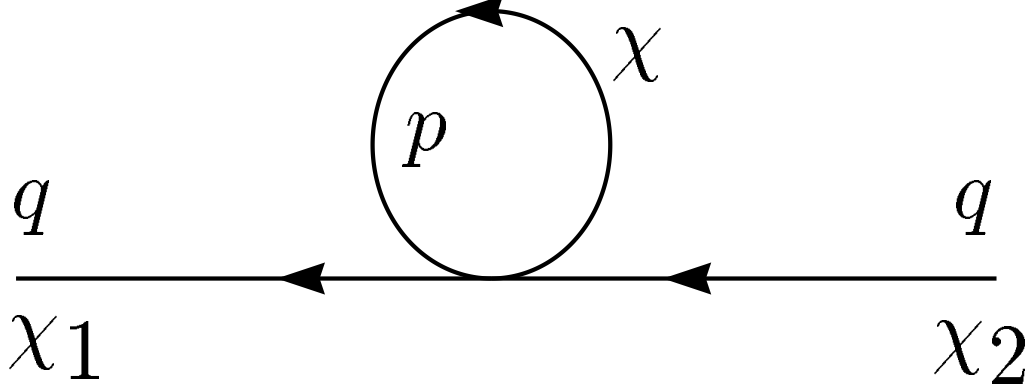

Figure 1:

## 2 Self-energy, vertex and box diagrams for the scalar boson.

### 2.1 Self-energy diagrams.

Here they are:

$$\Pi = \frac{if^{4\chi}}{16\pi^2} M_\chi^2 \left[ 2P - 1 + \log \frac{M_\chi^2}{M_W^2} \right]. \quad (2.2)$$

$$\Pi = \frac{if^{2V2\chi}}{16\pi^2} M_V^2 \left[ 6P - 1 + 3 \log \frac{M_V^2}{M_W^2} \right]. \quad (2.3)$$

$$\Pi(q^2) = \frac{if_1^{3\chi} f_2^{3\chi}}{16\pi^2} \left[ -2P - I_0(q^2, M_\chi^2, M_{\chi'}^2) \right]. \quad (2.4)$$

$$\begin{aligned} \Pi(q^2) = & \frac{if_1^\chi f_2^\chi}{4\pi^2} \left\{ [(1 - b_1 b_2) (q^2 + 2m_1^2 + 2m_2^2) + (1 + b_1 b_2) 2m_1 m_2] P + \right. \\ & \left. + \left[ \frac{1}{2} (1 - b_1 b_2) (q^2 + m_1^2 + m_2^2) + (1 + b_1 b_2) m_1 m_2 \right] I_0(q^2, m_1^2, m_2^2) \right\} + \end{aligned} \quad (2.5)$$

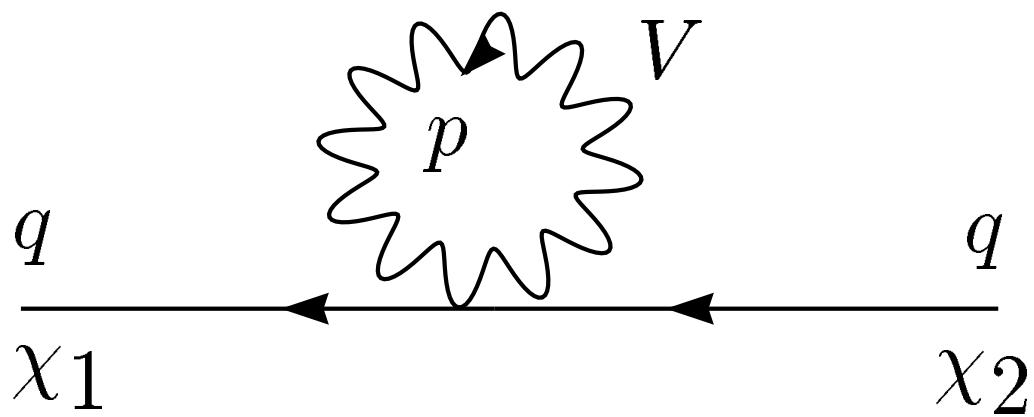

Figure 2:

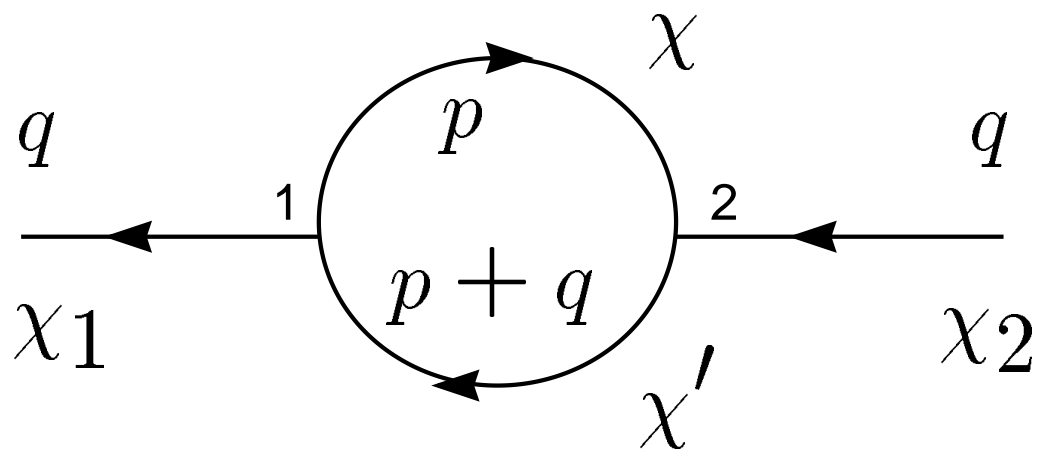

Figure 3:

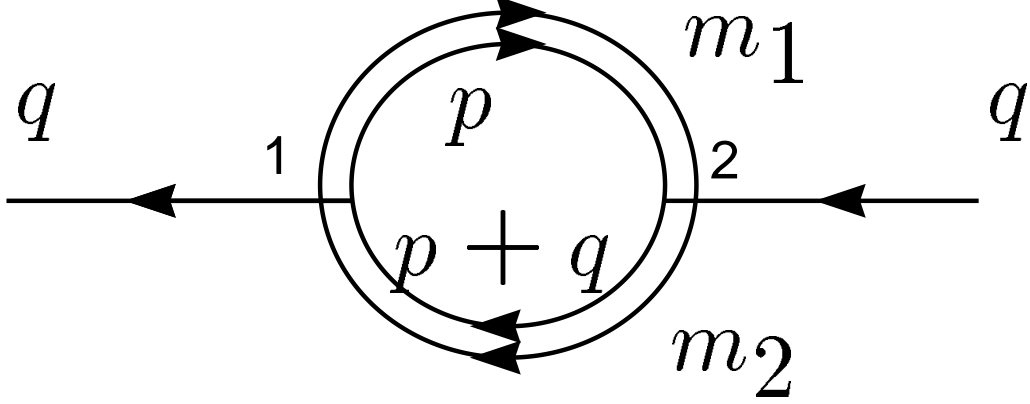

Figure 4:

$$+ \frac{1}{2}(1 - b_1 b_2) \left( m_1^2 \log \frac{m_1^2}{M_W^2} + m_2^2 \log \frac{m_2^2}{M_W^2} + \frac{q^2}{2} \right) + \frac{1}{2}(1 + b_1 b_2) m_1 m_2 \Big\}.$$

$$\begin{aligned} \Pi(q^2) = & \frac{i f_1^{V\chi} f_2^{V\chi}}{16\pi^2} \left\{ \left[ -\frac{q^4}{2M_V^4} - 3\frac{q^2}{M_V^2} - 6 \right] P - \right. \\ & \left. - \left( \frac{q^4}{4M_V^4} + \frac{q^2}{M_V^2} + 3 \right) I_0(q^2, M_V^2, M_V^2) - \frac{q^2}{2M_V^2} \log \frac{M_V^2}{M_W^2} + \frac{q^2}{2M_V^2} - 2 \right\}. \end{aligned} \quad (2.6)$$

In the framework of the SM with one Higgs doublet only we obtain

$$\begin{aligned} \Pi^\chi(q^2) = & \frac{ig^2}{16\pi^2} M_\chi^2 \left\{ \left[ -\frac{3}{4} \frac{q^4}{M_W^2 M_\chi^2} - 3\frac{q^2}{M_\chi^2} - \frac{3}{2R} \frac{q^2}{M_\chi^2} + \frac{q^2}{M_W^2 M_\chi^2} \text{Tr } m_i^2 - \right. \right. \\ & \left. - 3r_W - 9r_W^{-1} - \frac{9}{2R} r_Z^{-1} + \frac{6}{M_W^2 M_\chi^2} \text{Tr } m_i^4 \right] P + \text{tadpoles} + \frac{3q^4}{4M_W^2 M_\chi^2} + \\ & + \left( \frac{5}{2} + \frac{5}{4R} \right) \frac{q^2}{M_\chi^2} + \frac{21}{8} r_W + \frac{9}{2} r_W^{-1} + \frac{9}{4R} r_Z^{-1} - \frac{3}{2} r_W \log r_W + \left( \frac{q^4}{8M_W^4} + \right. \\ & \left. + \frac{3}{4R} \frac{q^2}{M_W^2} + \frac{9}{4R^2} \right) r_W^{-1} \log R - \frac{3q^2}{4M_W^2 M_\chi^2} \text{Tr } m_i^2 + \end{aligned}$$

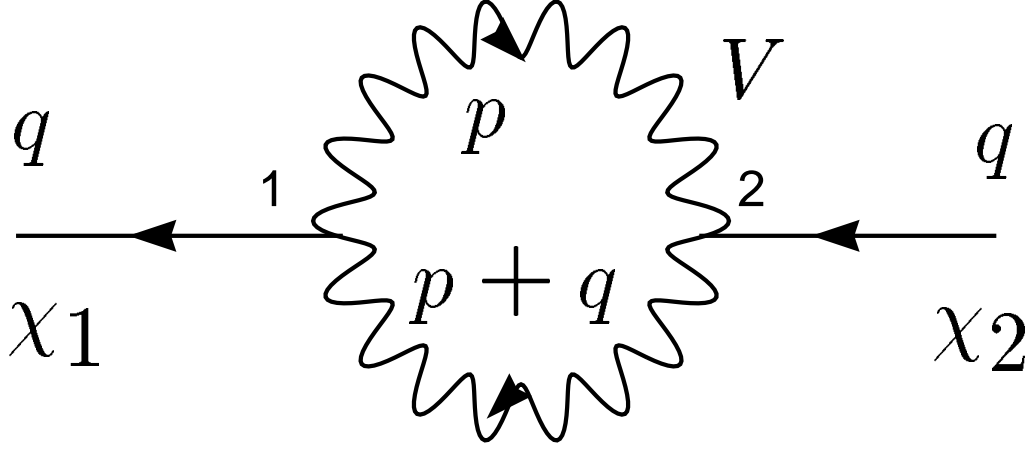

Figure 5:

$$\begin{aligned}
& + \frac{q^2}{2M_W^2 M_\chi^2} \text{Tr } m_i^2 \log \frac{m_i^2}{M_W^2} - \frac{7}{2M_W^2 M_\chi^2} \text{Tr } m_i^4 + \frac{3}{M_W^2 M_\chi^2} \text{Tr } m_i^4 \log \frac{m_i^2}{M_W^2} - \\
& - \left( \frac{q^2}{8M_W^2} + \frac{1}{2} + \frac{3M_W^2}{2q^2} \right) \frac{1}{M_\chi^2} L(q^2, M_W^2, M_W^2) - \\
& - \left( \frac{q^2}{16M_Z^2} + \frac{1}{4} + \frac{3M_Z^2}{4q^2} \right) \frac{1}{R} \frac{1}{M_\chi^2} L(q^2, M_Z^2, M_Z^2) - \\
& - \frac{9}{16} r_W \frac{1}{q^2} L(q^2, M_\chi^2, M_\chi^2) - \frac{1}{4M_W^2 M_\chi^2} \text{Tr } m_i^2 L(q^2, m_i^2, m_i^2) + \\
& + \left. \frac{1}{M_W^2 M_\chi^2} \frac{1}{q^2} \text{Tr } m_i^4 L(q^2, m_i^2, m_i^2) \right\}. \tag{2.7}
\end{aligned}$$

The corresponding counterterms are

$$\begin{aligned}
\frac{\delta M_\chi^2}{M_\chi^2} = Z_{M_\chi} - Z_\chi = & \frac{ig^2}{16\pi^2} \left\{ \left[ 3 + \frac{3}{2R} - \frac{15}{4} r_W - 9r_W^{-1} - \frac{9}{2R} r_Z^{-1} - \frac{1}{M_W^2} \text{Tr } m_i^2 + \right. \right. \\
& + \left. \frac{6}{M_W^2 M_\chi^2} \text{Tr } m_i^4 \right] P + \frac{\Pi^\chi(\text{tadpoles})}{M_\chi^2} - \frac{5}{2} - \frac{5}{4R} + \frac{27}{8} r_W + \frac{9}{2} r_W^{-1} + \frac{9}{4R} r_Z^{-1} - \\
& - \frac{3}{2} r_W \log r_W + \left( \frac{1}{8} r_W - \frac{3}{4R} + \frac{9}{4R} r_Z^{-1} \right) \log R + \frac{3}{4M_W^2} \text{Tr } m_i^2 -
\end{aligned}$$



$$\begin{aligned}
& - \frac{1}{2M_W^2} Tr m_i^2 \log \frac{m_i^2}{M_W^2} - \frac{7}{2M_W^2 M_\chi^2} Tr m_i^4 + \frac{3}{M_W^2 M_\chi^2} Tr m_i^4 \log \frac{m_i^2}{M_W^2} + \\
& + \left( \frac{r_W}{8} - \frac{1}{2} + \frac{3}{2} r_W^{-1} \right) \frac{1}{M_\chi^2} L(-M_\chi^2, M_W^2, M_W^2) + \\
& + \left( \frac{r_Z}{16} - \frac{1}{4} + \frac{3}{4} r_Z^{-1} \right) \frac{1}{R} \frac{1}{M_\chi^2} L(-M_\chi^2, M_Z^2, M_Z^2) + \\
& + \frac{9}{16M_W^2} L(-M_\chi^2, M_\chi^2, M_\chi^2) + \\
& + \left. \frac{1}{4M_W^2 M_\chi^2} Tr m_i^2 L(-M_\chi^2, m_i^2, m_i^2) - \frac{1}{M_W^2 M_\chi^4} Tr m_i^4 L(-M_\chi^2, m_i^2, m_i^2) \right\} \tag{2.8}
\end{aligned}$$

and

$$\begin{aligned}
Z_\chi - 1 &= \frac{ig^2}{16\pi^2} \left\{ \left[ -3 - \frac{3}{2R} + \frac{3}{2} r_W + \frac{1}{M_W^2} Tr m_i^2 \right] P + \frac{3}{2} + \frac{3}{4R} + 3r_W^{-1} + \right. \\
& + \frac{3}{2R} r_Z^{-1} + \left( \frac{3}{4R} - \frac{1}{4} r_W \right) \log R - \frac{1}{4M_W^2} Tr m_i^2 + \frac{1}{2M_W^2} Tr m_i^2 \log \frac{m_i^2}{M_W^2} - \\
& - \frac{2}{M_W^2 M_\chi^2} Tr m_i^4 + \left( \frac{1}{4} - \frac{1}{4} r_W - \frac{3}{r_W(r_W - 4)} \right) \frac{1}{M_\chi^2} L(-M_\chi^2, M_W^2, M_W^2) + \\
& + \left( \frac{1}{8} - \frac{1}{8} r_Z - \frac{3}{2r_Z(r_Z - 4)} \right) \frac{1}{R} \frac{1}{M_\chi^2} L(-M_\chi^2, M_Z^2, M_Z^2) + \\
& + \frac{3}{8} \frac{1}{M_W^2} L(-M_\chi^2, M_\chi^2, M_\chi^2) - \\
& \left. - \frac{1}{4M_W^2 M_\chi^2} Tr m_i^2 L(-M_\chi^2, m_i^2, m_i^2) - \frac{1}{2M_W^2 M_\chi^4} Tr m_i^4 L(-M_\chi^2, m_i^2, m_i^2) \right\} \tag{2.9}
\end{aligned}$$

Consequently,

$$\begin{aligned}
\Pi^{ren}(q^2) &= \Pi^\chi(q^2) - \delta M_\chi^2 - (Z_\chi - 1)(q^2 + M_\chi^2) = \frac{ig^2}{16\pi^2} M_\chi^2 \times \\
& \times \left\{ \left[ -\frac{3}{4} \frac{q^4}{M_W^2 M_\chi^2} - \frac{3}{4} r_W - \frac{3}{2} \frac{q^2}{M_W^2} \right] P + \frac{3q^4}{4M_W^2 M_\chi^2} + \frac{q^4}{8M_W^2 M_\chi^2} \log R + \right. \\
& + \frac{q^2}{M_\chi^2} \left( 1 + \frac{1}{2R} - 3r_W^{-1} - \frac{3}{2R} r_Z^{-1} \right) + \frac{q^2}{4M_W^2} \log R + \frac{1}{8} r_W \log R +
\end{aligned}$$

$$\begin{aligned}
& + 1 + \frac{1}{2R} - \frac{3}{4}r_W - 3r_W^{-1} - \frac{3}{2R}r_Z^{-1} - \left(\frac{q^2}{M_\chi^2} + 1\right) \frac{1}{2M_W^2} \text{Tr } m_i^2 + \\
& + \left(\frac{q^2}{M_\chi^2} + 1\right) \frac{2}{M_W^2 M_\chi^2} \text{Tr } m_i^4 - \left(\frac{q^2}{8M_W^2} + \frac{1}{2} + \frac{3M_W^2}{2q^2}\right) \times \\
& \times \frac{1}{M_\chi^2} L(q^2, M_W^2, M_W^2) - \left(\frac{q^2}{16M_Z^2} + \frac{1}{4} + \frac{3M_Z^2}{4q^2}\right) \frac{1}{R} \frac{1}{M_\chi^2} L(q^2, M_Z^2, M_Z^2) - \\
& - \frac{9}{16q^2} r_W L(q^2, M_\chi^2, M_\chi^2) + \frac{1}{4M_W^2 M_\chi^2} \text{Tr } m_i^2 L(q^2, m_i^2, m_i^2) + \\
& + \frac{1}{M_W^2 M_\chi^2} \frac{1}{q^2} \text{Tr } m_i^4 L(q^2, m_i^2, m_i^2) + \left(-\frac{q^2}{4M_\chi^2} + \frac{q^2}{4M_W^2} - \frac{3q^2}{M_\chi^2 r_W (r_W - 4)} + \right. \\
& + \left. \frac{1}{4} + \frac{1}{8}r_W - \frac{3}{2}r_W^{-1} + \frac{3}{r_W (r_W - 4)}\right) \frac{1}{M_\chi^2} L(-M_\chi^2, M_W^2, M_W^2) + \\
& + \left(-\frac{q^2}{8M_\chi^2} + \frac{q^2}{8M_Z^2} + \frac{3q^2}{M_\chi^2 r_Z (r_Z - 4)} + \frac{1}{8} + \frac{1}{16}r_Z - \frac{3}{4}r_Z^{-1} + \right. \\
& + \left. \frac{3}{2r_Z (r_Z - 4)}\right) \frac{1}{R} \frac{1}{M_\chi^2} L(-M_\chi^2, M_Z^2, M_Z^2) - \\
& - \left(\frac{3q^2}{8M_W^2} + \frac{15}{16}r_W\right) \frac{1}{M_\chi^2} L(-M_\chi^2, M_\chi^2, M_\chi^2) + \\
& + \frac{q^2}{4M_W^2 M_\chi^4} \text{Tr } m_i^2 L(-M_\chi^2, m_i^2, m_i^2) + \frac{1}{2M_W^2 M_\chi^4} \left(3 + \frac{q^2}{M_\chi^2}\right) \times \\
& \times \left. \text{Tr } m_i^4 L(-M_\chi^2, m_i^2, m_i^2)\right\} \tag{2.10}
\end{aligned}$$

In this Section and in what follows  $r_W = M_\chi^2/M_W^2$ ,  $r_Z = M_\chi^2/M_Z^2$ ,  $b_{1,2}$  are constants defined by the strength of the Higgs -fermion pseudoscalar interaction. <sup>2</sup> The form of the integral  $I_0(q^2, M_1^2, M_2^2)$  is given in *Appendix A*.

---

<sup>2</sup>In the Standard Model they are equal to zero.

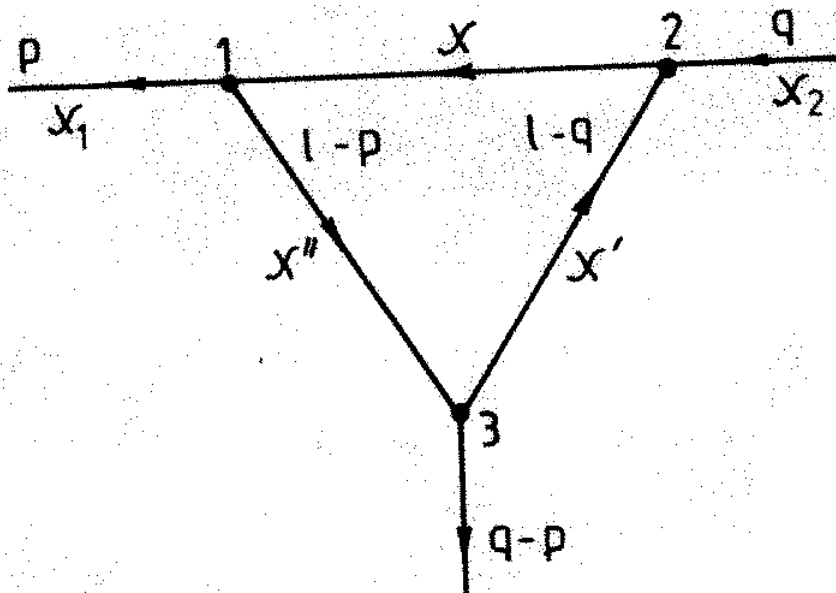

Figure 6:

## 2.2 Vertex diagrams.

The technique of the calculation of the diagrams shown below is very much alike to that suggested in paper [15].

$$\Gamma(p^2, q^2, (p-q)^2) = \frac{if_1^{3\chi} f_2^{3\chi} f_3^{3\chi}}{16\pi^2} I_1(q^2, (p-q)^2, p^2, M_\chi^2, M_{\chi'}^2, M_{\chi''}^2). \quad (2.11)$$

and a similar diagram with the opposite lepton current direction give

$$\begin{aligned} \Gamma(p^2, q^2, (p-q)^2) &= \frac{if_1^\chi f_2^\chi f_3^\chi}{4\pi^2} \{ [-2m_1 B_1 - 2m_2 B_2 - 2m_3 B_3] P - \\ &- \frac{m_1 B_1 + m_2 B_2 + m_3 B_3}{2} - \frac{m_1 B_1 + m_2 B_2}{2} I_0(q^2, m_1^2, m_2^2) - \\ &- \frac{m_1 B_1 + m_3 B_3}{2} I_0(p^2, m_1^2, m_3^2) - \frac{m_2 B_2 + m_3 B_3}{2} I_0((p-q)^2, m_2^2, m_3^2) - \\ &- \frac{1}{2} [(m_1(p-q)^2 + m_1 m_2^2 + m_1 m_3^2) B_1 + \\ &+ (m_2 p^2 + m_2 m_1^2 + m_2 m_3^2) B_2 + (m_3 q^2 + m_3 m_1^2 + m_3 m_2^2) B_3 + \\ &+ 2m_1 m_2 m_3 B_4] I_1(q^2, (p-q)^2, p^2, m_1^2, m_2^2, m_3^2) \}. \end{aligned}$$

where

$$\begin{aligned} B_1 &= 1 + b_1 b_2 - b_1 b_3 - b_2 b_3, \\ B_2 &= 1 - b_1 b_2 - b_1 b_3 + b_2 b_3, \\ B_3 &= 1 - b_1 b_2 + b_1 b_3 - b_2 b_3, \\ B_4 &= 1 + b_1 b_2 + b_1 b_3 + b_2 b_3. \end{aligned} \quad (2.12)$$

and a similar diagram with the opposite loop current direction

$$\begin{aligned} \Gamma(p^2, q^2, (p-q)^2) &= \frac{if_1^{V\chi} f_2^{V\chi} f_3^{V\chi}}{16\pi^2} \left\{ \left[ -\frac{3p^2 + q^2 + (p-q)^2}{4 M_V^4} - \right. \right. \\ &- \left. \frac{1}{8} \frac{(p^2 + q^2 + (p-q)^2)^2}{M_V^6} \right] P + \frac{p^2 + q^2 + (p-q)^2}{4M_V^4} \left( 1 - \log \frac{M_V^2}{M_W^2} \right) - \\ &- \left. \left[ \frac{1}{4M_V^4} \left( \frac{p^2 + q^2 - (p-q)^2}{2} + p^2 - q^2 \right) + \frac{p^2(p^2 + q^2 + (p-q)^2)}{16M_V^6} \right] \times \right\} \end{aligned}$$

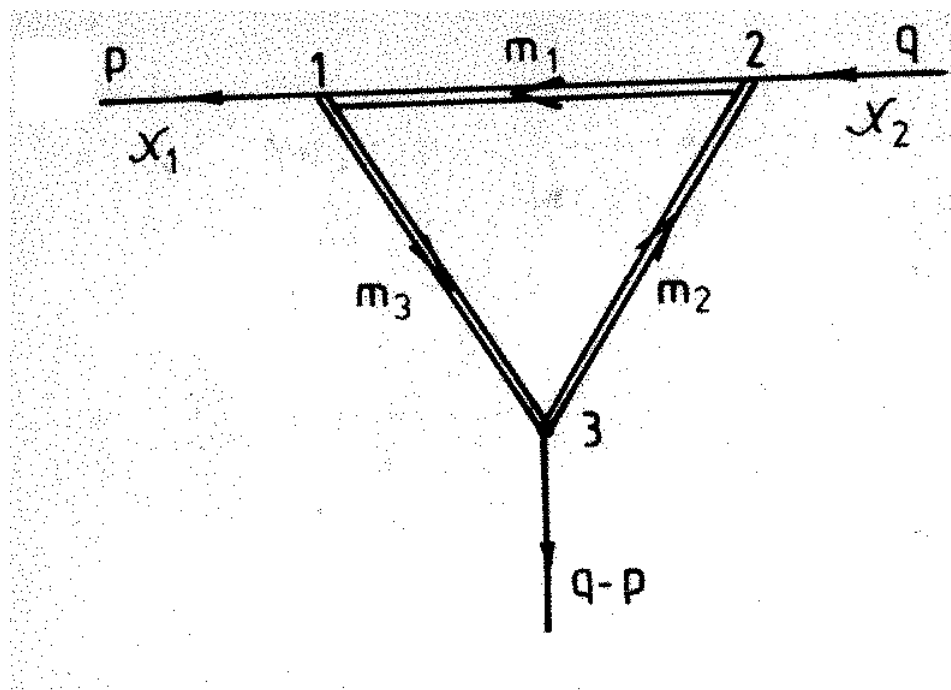

Figure 7:

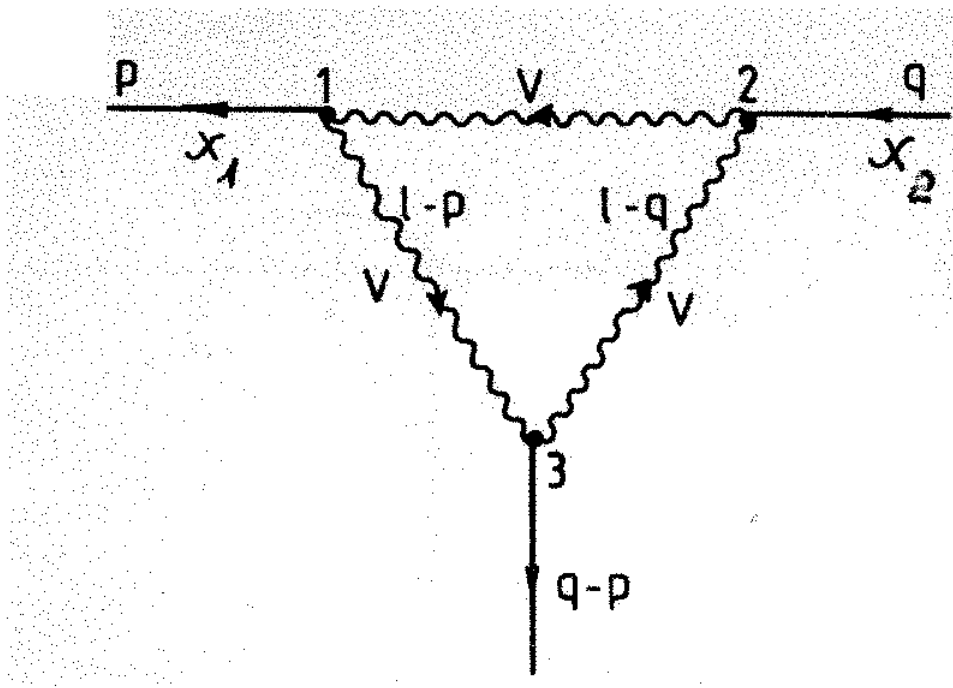

Figure 8:

$$\begin{aligned}
& \times I_0(p^2, M_V^2, M_V^2) - \left[ \frac{1}{4M_V^4} \left( \frac{p^2 + q^2 - (p-q)^2}{2} + q^2 - p^2 \right) + \right. \\
& + \left. \frac{q^2(p^2 + q^2 + (p-q)^2)}{16M_V^6} \right] I_0(q^2, M_V^2, M_V^2) + \left[ \frac{1}{4M_V^4} \left( \frac{p^2 + q^2 - (p-q)^2}{2} - \right. \right. \\
& - \left. \left. (p-q)^2 \right) - \frac{(p-q)^2(p^2 + q^2 + (p-q)^2)}{16M_V^6} \right] I_0((p-q)^2, M_V^2, M_V^2) + \\
& + \left[ 3 + \frac{p^2 + q^2 + (p-q)^2}{2M_V^2} + \right. \\
& + \left. \frac{p^4 + q^4 - p^2q^2 + (p-q)^4 - p^2(p-q)^2 - q^2(p-q)^2}{4M_V^4} - \right. \\
& - \left. \frac{p^2q^2(p-q)^2}{8M_V^6} \right] I_1(q^2, (p-q)^2, p^2, M_V^2, M_V^2, M_V^2) \Big\}. \tag{2.13}
\end{aligned}$$

The form of the integral  $I_1$  is also given in *Appendix A*.

The diagrams can be easily derived from the self-energy diagrams (see preceding Subsection). As a sum, we get

$$\begin{aligned}
\Gamma(p^2, q^2, (p-q)^2) &= \frac{ig^3}{16\pi^2} \frac{M_\chi^2}{M_W} \left\{ \left[ \frac{3p^2q^2 + p^2(p-q)^2 + q^2(p-q)^2}{4M_W^2M_\chi^2} - \frac{27}{8}r_W - \right. \right. \\
& - \left. 9r_W^{-1} - \frac{9}{2R}r_Z^{-1} + \frac{6}{M_W^2M_\chi^2}Tr m_i^6 \right] P + \Gamma^{3\chi}(tadpoles) - \frac{p^2 + q^2 + (p-q)^2}{4M_\chi^2} + \\
& + \frac{p^2 + q^2 + (p-q)^2}{8M_\chi^2} \frac{1}{R} - \frac{3p^2q^2 + p^2(p-q)^2 + q^2(p-q)^2}{4M_W^2M_\chi^2} - \\
& - \frac{p^2q^2 + p^2(p-q)^2 + q^2(p-q)^2}{8M_W^2M_\chi^2} \log R + \frac{27}{8}r_W - \frac{27}{16}r_W \log r_W + 6r_W^{-1} + \\
& + 3\frac{1}{R}r_Z^{-1} + \frac{9}{4}r_Z^{-1} \frac{1}{R} \log R - \frac{9}{2M_W^2M_\chi^2}Tr m_i^4 + \frac{3}{M_W^2M_\chi^2}Tr m_i^4 \log \frac{m_i^2}{M_W^2} - \\
& + \left[ -\frac{3}{2}r_W^{-1} - \frac{q^2 + (p-q)^2 - p^2}{4M_\chi^2} + \frac{p^2(q^2 + (p-q)^2)}{8M_W^2M_\chi^2} \right] \times \\
& \times \frac{1}{2p^2} L(p^2, M_W^2, M_W^2) + \left[ -\frac{3}{2}r_W^{-1} - \frac{p^2 + (p-q)^2 - q^2}{4M_\chi^2} + \frac{q^2(p^2 + (p-q)^2)}{8M_W^2M_\chi^2} \right] \times
\end{aligned}$$

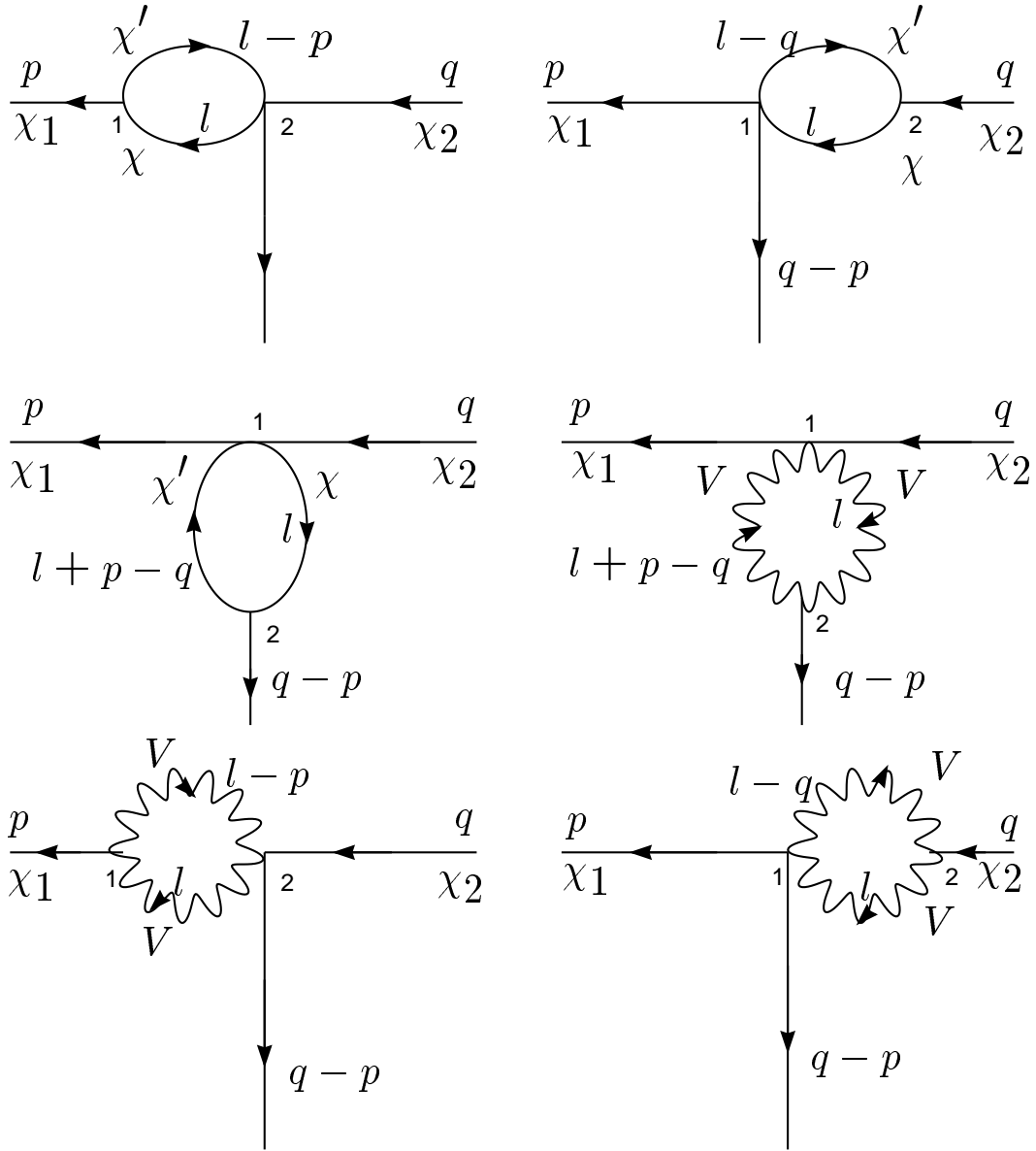

Figure 9:



$$\begin{aligned}
& \times \frac{1}{2q^2} L(q^2, M_W^2, M_W^2) + \left[ -\frac{3}{2} r_W^{-1} - \frac{p^2 + q^2 - (p-q)^2 - p^2}{4M_\chi^2} + \right. \\
& + \left. \frac{(p-q)^2(p^2 + q^2)}{8M_W^2 M_\chi^2} \right] \frac{1}{(p-q)^2} L((p-q)^2, M_W^2, M_W^2) + \\
& + \left[ -\frac{3}{4R} r_Z^{-1} - \frac{q^2 + (p-q)^2 - p^2}{8M_\chi^2} \frac{1}{R} + \frac{p^2(q^2 + (p-q)^2)}{16M_W^2 M_\chi^2} \right] \frac{1}{2p^2} L(p^2, M_Z^2, M_Z^2) + \\
& + \left[ -\frac{3}{4R} r_Z^{-1} - \frac{p^2 + (p-q)^2 - q^2}{8M_\chi^2} \frac{1}{R} + \frac{q^2(p^2 + (p-q)^2)}{16M_W^2 M_\chi^2} \right] \frac{1}{2q^2} L(q^2, M_Z^2, M_Z^2) + \\
& + \left[ -\frac{3}{4R} r_Z^{-1} - \frac{p^2 + q^2 - (p-q)^2 - p^2}{8M_\chi^2} \frac{1}{R} + \right. \\
& + \left. \frac{(p-q)^2(p^2 + q^2)}{16M_W^2 M_\chi^2} \right] \frac{1}{2(p-q)^2} L((p-q)^2, M_Z^2, M_Z^2) - \\
& - \frac{9}{16} r_W \left[ \frac{1}{2p^2} L(p^2, M_\chi^2, M_\chi^2) + \frac{1}{2q^2} L(q^2, M_\chi^2, M_\chi^2) + \right. \\
& + \left. \frac{1}{2(p-q)^2} L((p-q)^2, M_\chi^2, M_\chi^2) \right] + \\
& + \frac{1}{M_W^2 M_\chi^2} Tr m_i^4 \left[ \frac{1}{2p^2} L(p^2, M_\chi^2, M_\chi^2) + \frac{1}{2q^2} L(q^2, M_\chi^2, M_\chi^2) + \right. \\
& + \left. \frac{1}{(p-q)^2} L((p-q)^2, M_\chi^2, M_\chi^2) \right] - \frac{27}{8} r_W M_\chi^2 I_1(q^2, (p-q)^2, p^2, M_\chi^2, M_\chi^2, M_\chi^2) - \\
& - \left[ 6r_W^{-1} M_W^2 + (p^2 + q^2 + (p-q)^2) r_W^{-1} + \right. \\
& + \left. \frac{p^4 + q^4 + (p-q)^4 - p^2 q^2 - p^2(p-q)^2 - q^2(p-q)^2}{2M_\chi^2} - \right. \\
& - \left. \frac{p^2 q^2 (p-q)^2}{4M_W^2 M_\chi^2} \right] I_1(q^2, (p-q)^2, p^2, M_W^2, M_W^2, M_W^2) - \\
& - \left[ \frac{3}{R} r_Z^{-1} M_Z^2 + \frac{p^2 + q^2 + (p-q)^2}{2R} r_Z^{-1} + \right. \\
& + \left. \frac{p^4 + q^4 + (p-q)^4 - p^2 q^2 - p^2(p-q)^2 - q^2(p-q)^2}{4R M_\chi^2} - \right.
\end{aligned}$$

$$\begin{aligned}
& - \frac{p^2 q^2 (p-q)^2}{8M_W^2 M_\chi^2} \left] I_1(q^2, (p-q)^2, p^2, M_Z^2, M_Z^2, M_Z^2) + \right. \\
& + \frac{p^2 + q^2 + (p-q)^2}{2M_W^2 M_\chi^2} Tr m_i^4 I_1(q^2, (p-q)^2, p^2, m_i^2, m_i^2, m_i^2) + \\
& \left. + \frac{4}{M_W^2 M_\chi^2} Tr m_i^6 I_1(q^2, (p-q)^2, p^2, m_i^2, m_i^2, m_i^2) \right\}. \tag{2.14}
\end{aligned}$$

The appropriate counterterm is

$$\Gamma^{c.t.} = -\frac{3gM_\chi^2}{2M_W} \left[ \frac{3}{2}(Z_\chi - 1) + \frac{\delta g}{g} + \frac{\delta M_\chi^2}{M_\chi^2} - \frac{\delta M_W^2}{2M_W^2} \right]. \tag{2.15}$$

As found in [9]

$$\frac{\delta g}{g} = Z_A^{-1/2} \left( 1 - \frac{\delta R}{1-R} \right)^{-1/2} - 1 \simeq \frac{1}{2} \left[ \frac{\delta R}{1-R} - (Z_A - 1) \right], \tag{2.16}$$

$$\frac{\delta R}{R} = \frac{Z_{M_W} Z_W^{-1}}{Z_{M_Z} Z_Z^{-1}} - 1 \simeq \frac{\delta M_W^2}{M_W^2} - \frac{\delta M_Z^2}{M_Z^2}, \tag{2.17}$$

where

$$\begin{aligned}
\frac{\delta M_W^2}{M_W^2} = Z_{M_W} - Z_W = & \frac{ig^2}{16\pi^2} \left\{ \left[ \frac{34}{3} - \frac{3}{2R} - \frac{1}{3}N_f + \frac{1}{M_W^2} Tr m_i^2 \right] P - 19 + \frac{14}{9} + \right. \\
& + \frac{23}{12R} + \frac{1}{12R^2} - \frac{1}{2}r_W + \frac{1}{12}r_W^2 + \left( -\frac{7}{2} + \frac{7}{12R} + \frac{1}{24R^2} \right) \frac{1}{R} \log R + \\
& + \left( -\frac{3}{4} + \frac{1}{4}r_W - \frac{1}{24}r_W^2 \right) r_W \log r_W + \frac{7}{36}N_f - \frac{1}{12M_W^2} Tr m_i^2 - \frac{1}{6M_W^4} Tr m_i^4 + \\
& + \sum_{i,j}^{N_f/2} \left[ \frac{m_i^2 m_j^2}{3M_W^4} - \left( \frac{1}{3} - \frac{m_i^2 + m_j^2}{2M_W^2} \right) \times \log m_i m_j M_W^2 + \frac{(m_i^2 - m_j^2)^3}{12M_W^6} \log m_i^2 m_j^2 - \right. \\
& - \left. \left( \frac{1}{6} - \frac{m_i^2 + m_j^2}{12M_W^2} - \frac{m_i^2 - m_j^2}{12M_W^4} \right) \frac{1}{M_W^2} L(-M_W^2, m_i^2, m_j^2) \right] K_{ij} K_{ij}^+ + \\
& - \left( \frac{1}{2} - \frac{r_W}{6} + \frac{r_W^2}{24} \right) \frac{1}{M_W^2} L(-M_W^2, M_W^2, M_\chi^2) + \left( -\frac{17}{6} - 2R + \frac{2}{3R} + \frac{1}{24R^2} \right) \times \\
& \left. \times \frac{1}{M_W^2} L(-M_W^2, M_W^2, M_Z^2) \right\}, \tag{2.18}
\end{aligned}$$

and

$$\begin{aligned}
\frac{\delta M_Z^2}{M_Z^2} = & Z_{M_Z} - Z_Z = \frac{ig^2}{16\pi^2} \left\{ \left[ -\frac{7}{3} + 14R - \frac{11}{6R} - \right. \right. \\
& - \frac{1}{3} \left( 2 - \frac{1}{3} \right) N_f - \frac{8(1-R)^2}{3R} \text{Tr} Q_i^2 + \frac{1}{M_W^2} \text{Tr} m_i^2 \left. \right] P + \\
& + \frac{35}{18} - \frac{34}{3} R - 8R^2 + \\
& - \frac{35}{18R} - \frac{1}{2} r_W + \frac{1}{12} r_W r_Z + \frac{5}{6R} \log R + \left( -\frac{3}{4} + \frac{1}{4} r_Z - \frac{1}{24} r_Z^2 \right) r_W \log r_Z + \\
& + \left( \frac{7}{36} N_f - \frac{14}{9} \text{Tr} Q_i^2 \right) \left( 2 - \frac{1}{R} \right) + \frac{14}{9} R \text{Tr} Q_i^2 + \\
& + \frac{1}{M_W^2} \text{Tr} \left[ \left( -\frac{1}{12} - \frac{8}{3} |Q_i| + \frac{16}{3} Q_i^2 \right) m_i^2 + \left( \frac{8}{3} |Q_i| - \frac{32}{3} Q_i^2 \right) R m_i^2 + \right. \\
& + \left. \frac{16}{3} Q_i^2 R^2 m_i^2 \right] + \frac{1}{M_W^2} \text{Tr} \left[ \frac{1}{2} m_i^2 - \frac{1}{3} M_Z^2 \left( \frac{1}{2} - 2|Q_i| + 4Q_i^2 \right) - \right. \\
& - \left. \frac{1}{3} M_W^2 \left( 2|Q_i| - 8Q_i^2 \right) - \frac{4M_W^2}{3M_Z^2} Q_i^2 \right] \log \frac{m_i^2}{M_W^2} + \\
& + \left( \frac{1}{24} + \frac{2}{3} R - \frac{17}{6} R^2 - 2R^3 \right) \frac{1}{M_W^2} L(-M_Z^2, M_W^2, M_W^2) + \\
& + \left( \frac{1}{2} - \frac{1}{6} r_Z + \frac{1}{24} r_Z^2 \right) \frac{1}{M_W^2} L(-M_Z^2, M_Z^2, M_W^2) + \\
& + \text{Tr} \left[ \left( \frac{1}{12} - \frac{1}{3} |Q_i| + \frac{2}{3} Q_i^2 \right) + \left( \frac{1}{3} |Q_i| - \frac{4}{3} Q_i^2 \right) R + \frac{2}{3} Q_i^2 R^2 - \right. \\
& - \left. \left( \frac{1}{12} + \frac{2}{3} |Q_i| - \frac{4}{3} Q_i^2 \right) \frac{m_i^2}{M_Z^2} + \left( \frac{2}{3} |Q_i| - \frac{8}{3} Q_i^2 \right) R \frac{m_i^2}{M_Z^2} + \right. \\
& + \left. \left. \frac{4}{3} Q_i^2 R^2 \frac{m_i^2}{M_Z^2} \right] \frac{1}{M_W^2} L(-M_Z^2, m_i^2, m_i^2) \right\} \tag{2.19}
\end{aligned}$$

Finally,<sup>3</sup>

$$Z_A - 1 = \frac{ie^2}{16\pi^2} \left\{ \left[ -14 + \frac{8}{3} \text{Tr} Q_i^2 \right] P + \frac{2}{3} (1 + \text{Tr} Q_i^2) + \frac{4}{3} \text{Tr} Q_i^2 \log \frac{m_i^2}{m_W^2} \right\}. \quad (2.20)$$

Thus,

$$\begin{aligned} \frac{\delta g}{g} = \frac{ig^2}{16\pi^2} & \left\{ \left[ \frac{43}{6} - \frac{1}{6} N_f \right] P - \frac{1}{3} (1 - R) (1 + \text{Tr} Q_i^2) + \right. \\ & \left. + 2 \text{Tr} Q_i^2 \log \frac{m_i^2}{M_W^2} \right\} + \frac{1}{2} \frac{R}{1 - R} [W(-1) - Z(-1)], \quad (2.21) \end{aligned}$$

where  $W(-1)$  and  $Z(-1)$  are the finite parts of the counterterms  $\delta M_W^2/M_W^2$  and  $\delta M_Z^2/M_Z^2$ , respectively. Then,

$$\begin{aligned} \Gamma^{c.t.}(p^2, q^2, (p-q)^2) &= -\frac{ig^3}{16\pi^2} \frac{3M_\chi^2}{2M_W} \left\{ \left[ -\frac{3}{2} r_W - 9r_W^{-1} - \right. \right. \\ & - \left. \frac{9}{2R} r_Z^{-1} + \frac{6}{M_W^2 M_\chi^2} \text{Tr} m_i^4 \right] P + \\ & + \frac{1}{2} \left( \frac{R}{1-R} - 1 \right) W(-1) - \frac{1}{2} \frac{R}{1-R} Z(-1) + \\ & + \chi(-1) + \frac{3}{2} \chi^F(-1) - 2\Gamma^{3\chi}(\text{tadpoles}) - \\ & \left. - \frac{1}{3} (1-R) \left( 1 + \text{Tr} Q_i^2 + 2 \text{Tr} Q_i^2 \log \frac{m_i^2}{M_W^2} \right) \right\} = \\ & = -\frac{ig^3}{16\pi^2} \frac{3M_\chi^2}{2M_W} \left\{ \left[ -\frac{3}{2} r_W - 9r_W^{-1} - \frac{9}{2R} r_Z^{-1} + \frac{6}{M_W^2 M_\chi^2} \text{Tr} m_i^4 \right] P + \right. \\ & + \frac{49}{6} - \frac{28}{3} R - 4R^2 - \frac{25}{24R} - \frac{1}{24R^2} - \\ & \left. - \left( \frac{10}{9} - \frac{10}{9} R \right) \text{Tr} Q_i^2 + \frac{29}{8} r_W - \frac{1}{4} r_W^2 + \frac{1}{4} r_W r_Z + 9r_W^{-1} + \frac{9}{2R} r_Z^{-1} + \right. \end{aligned}$$

---

<sup>3</sup>Some difference of the renormalization constants from those given in [9] appears firstly due to the approximation  $s, t, u, M_V^2, M_\chi^2 \gg m_f^2$  done there (and not used in our consideration) and, secondly, due to the different definition of the  $f(d)$  function (used in the trace calculations, see *Appendix A*), that is known to not have influence the physical quantities.

$$\begin{aligned}
& + \left( -\frac{9}{8} + \frac{1}{8}r_Z - \frac{1}{8}r_W + \frac{1}{48}r_W^2 - \frac{1}{48}r_W r_Z - \frac{1}{48}r_Z^2 \right) r_W \log r_W + \\
& + \left( -\frac{47}{12} + \frac{7}{3R} - \frac{1}{4R^2} - \frac{1}{48R^3} + \frac{3}{8}r_Z - \frac{1}{8}r_Z^2 + \frac{1}{48}r_Z^3 \right) \frac{1}{1-R} \log R + \\
& + \left( -\frac{1}{4}r_W + \frac{3}{8R} + \frac{9}{4R}r_Z^{-1} \right) \log R + \\
& + \frac{1}{M_W^2} \text{Tr} \left[ \frac{5}{12}m_i^2 + \left( \frac{4}{3}|Q_i| - \frac{8}{3}Q_i^2 \right) Rm_i^2 + \frac{8}{3}Q_i^2 R^2 m_i^2 \right] + \\
& + \frac{1}{M_W^4} \text{Tr} \left[ \frac{1}{12}m_i^4 - \frac{1}{12} \frac{R}{1-R} m_i^4 - \frac{13}{2}r_W^{-1}m_i^4 \right] + \\
& + \text{Tr} \left[ \frac{m_i^2}{4M_W^2} \left( 1 - \frac{R}{1-R} \right) + \frac{1}{12} \frac{1}{1-R} - \frac{1}{3}|Q_i| + 3 \frac{m_i^4}{M_W^2 M_\chi^2} \right] \log \frac{m_i^2}{M_W^2} + \\
& + \frac{R}{1-R} \left( -\frac{1}{48} - \frac{1}{3}R + \frac{17}{12}R^2 + R^3 \right) \frac{1}{M_W^2} L(-M_Z^2, M_W^2, M_W^2) + \\
& + \frac{R}{1-R} \left( -\frac{1}{4} + \frac{1}{12}r_Z - \frac{1}{48}r_Z^2 \right) \frac{1}{M_W^2} L(-M_Z^2, M_Z^2, M_\chi^2) + \frac{1}{1-R} \left( -\frac{1}{4} + \frac{1}{2}R \right. \\
& + \left. \frac{1}{12}r_W - \frac{1}{6}r_Z + \frac{1}{24}r_W r_Z - \frac{1}{48}r_W^2 \right) \frac{1}{M_W^2} L(-M_W^2, M_W^2, M_\chi^2) + \\
& + \frac{1}{1-R} \left( \frac{25}{12} - \frac{11}{6}R - 2R^2 - \frac{7}{24R} - \frac{1}{48R^2} \right) \frac{1}{M_W^2} L(-M_W^2, M_W^2, M_Z^2) + \\
& + \left( -\frac{1}{4} - \frac{1}{8}r_W^{-1} + \frac{3}{2}r_W^{-2} - \frac{9}{2r_W^2(r_W - 4)} \right) \frac{1}{M_W^2} L(-M_\chi^2, M_W^2, M_W^2) + \\
& + \left( -\frac{1}{8} - \frac{1}{16}r_Z^{-1} + \frac{3}{4}r_Z^{-2} - \frac{9}{4r_Z^2(r_Z - 4)} \right) \frac{1}{M_W^2} L(-M_\chi^2, M_Z^2, M_Z^2) + \\
& + \frac{9}{8M_W^2} L(-M_\chi^2, M_\chi^2, M_\chi^2) - \frac{1}{M_W^2} \text{Tr} \left[ \frac{1}{24} \frac{R}{1-R} - \right. \\
& - \left. \left( \frac{1}{6}|Q_i| - \frac{1}{3}Q_i^2 \right) R - \frac{1}{3}Q_i^2 R^2 - \right. \\
& - \left. \frac{1}{24} \frac{R}{1-R} \frac{m_i^2}{M_Z^2} - \left( \frac{1}{3}|Q_i| - \frac{2}{3}Q_i^2 \right) \frac{m_i^2}{M_Z^2} R - \frac{2}{3}Q_i^2 R^2 \frac{m_i^2}{M_Z^2} \right] L(-M_Z^2, m_i^2, m_i^2) - \\
& - \frac{1}{M_W^2} \text{Tr} \left[ \frac{m_i^2}{8M_\chi^2} + \frac{7m_i^4}{8M_\chi^4} \right] L(-M_\chi^2, m_i^2, m_i^2) + \frac{1}{2} \left( \frac{R}{1-R} - 1 \right) \times
\end{aligned}$$

$$\begin{aligned}
& \times \sum_{ij}^{N_f/2} \left[ \frac{m_i^2 m_j^2}{3M_W^4} - \left( \frac{1}{3} - \frac{m_i^2 + m_j^2}{2M_W^2} \right) \log \frac{m_i m_j}{M_W^2} + \right. \\
& + \frac{(m_i^2 - m_j^2)^3}{12M_W^6} \log \frac{m_i^2}{m_j^2} + \left( \frac{1}{6} - \frac{1}{12} \frac{m_i^2 + m_j^2}{M_W^2} - \right. \\
& \left. \left. - \frac{1}{12} \frac{(m_i^2 - m_j^2)^2}{M_W^4} \right) \frac{1}{M_W^2} L(-M_W^2, m_i^2, m_j^2) \right] K_{ij} K_{ij}^+ \left. \right\} - 2\Gamma^{3x}(\text{tadpoles}). \tag{2.22}
\end{aligned}$$

It is easy to check that the contribution of the tadpole diagrams is the following one

$$\begin{aligned}
\frac{\delta M_\chi^2}{M_\chi^2}(\text{tadpoles}) &= \frac{ig^2}{16\pi^2} \left\{ \left[ \frac{9}{4} r_W + 9r_W^{-1} + \frac{9}{2R} r_Z^{-1} - \frac{6}{M_W^2 M_\chi^2} \text{Tr} m_i^4 \right] P - \right. \\
& - \frac{9}{8} r_W + \frac{9}{8} r_W \log r_W - \frac{3}{2} r_W^{-1} - \frac{3}{4R} r_Z^{-1} - \frac{9}{4R} r_Z^{-1} \log R + \frac{3}{2M_W^2 M_\chi^2} \text{Tr} m_i^4 - \\
& \left. - \frac{3}{M_W^2 M_\chi^2} \text{Tr} m_i^4 \log \frac{m_i^2}{M_W^2} \right\}. \tag{2.23}
\end{aligned}$$

Using the coupling constants values from the Table I we obtain

$$\frac{\delta M_W^2}{M_W^2}(\text{tadpoles}) = \frac{2}{3} \frac{\delta M_\chi^2}{M_\chi^2}(\text{tadpoles}) \tag{2.24}$$

$$\frac{\delta M_Z^2}{M_Z^2}(\text{tadpoles}) = \frac{2}{3} \frac{\delta M_\chi^2}{M_\chi^2}(\text{tadpoles}) \tag{2.25}$$

and

$$\Gamma^{3x}(\text{tadpoles}) = \frac{g}{2M_W} \Pi^x(\text{tadpoles}). \tag{2.26}$$

Thus, one has the following additional terms in the expression for the counterterm  $\Gamma^{c.t.}$  in the unitary gauge:

$$\begin{aligned}
\Gamma^{c.t.}(\text{tadpoles}) &= -\frac{3g}{2} \frac{M_\chi^2}{M_W} \times \frac{2}{3} \frac{\delta M_\chi^2}{M_\chi^2}(\text{tadpoles}) = \\
&= -\frac{3g}{2} \frac{M_\chi^2}{M_W} \times \frac{2}{3} \frac{2M_W}{gM_\chi^2} \Gamma^{3x}(\text{tadpoles}) = -2\Gamma^{3x}. \tag{2.27}
\end{aligned}$$

For the counterterm  $\mathcal{M}$  one has

$$\begin{aligned}\mathcal{M}^{c.t.}(tadpoles) &= -\frac{3g^2}{4} \frac{M_\chi^2}{M_W^2} \times \frac{1}{3} \frac{\delta M_\chi^2}{M_\chi^2}(tadpoles) = \\ &= -\frac{3g^2}{4} \frac{M_\chi^2}{M_W^2} \times \frac{1}{3} \frac{2M_W}{g} \frac{\Gamma^{3\chi}(tadpoles)}{M_\chi^2} = -\frac{g}{2M_W} \Gamma^{3\chi}. \quad (2.28)\end{aligned}$$

As a result, the renormalized vertex is

$$\begin{aligned}\Gamma^{ren}(p^2, q^2, (p-q)^2) &= \frac{ig^3}{16\pi^2} \frac{M_\chi^2}{M_W} \left\{ \left[ \frac{3p^2q^2 + p^2(p-q)^2 + q^2(p-q)^2}{4M_W^2M_\chi^2} - \frac{9}{4}r_W \right] P + \right. \\ &+ \frac{1}{4} \frac{p^2 + q^2 + (p-q)^2}{M_\chi^2} \left( 1 + \frac{1}{2R} \right) - \\ &- \frac{1}{4} \frac{p^2q^2 + p^2(p-q)^2 + q^2(p-q)^2}{M_W^2M_\chi^2} \left( 3 + \frac{1}{2} \log R \right) - \\ &- \frac{49}{4} + 14R + 6R^2 + \frac{25}{16R} + \frac{1}{16R^2} - \frac{3}{2}r_W - \frac{27}{4}r_W^{-1} - \frac{27}{8R}r_Z^{-1} + \\ &+ \frac{3}{8}r_W^2 - \frac{3}{8}r_Wr_Z + \frac{5}{3}(1-R)Tr Q_i^2 - \frac{1}{M_W^2}Tr \left[ \frac{5}{8}m_i^2 + (2|Q_i| - 4Q_i^2) Rm_i^2 \right. \\ &+ \left. 4Q_i^2R^2m_i^2 \right] - \frac{1}{M_W^4}Tr \left[ \frac{1}{8}m_i^4 - \frac{1}{8} \frac{R}{1-R} m_i^4 - \frac{9}{2}r_W^{-1}m_i^4 \right] + \\ &+ \left( \frac{3}{8}r_W - \frac{9}{16R} \right) \log R - \frac{1}{1-R} \left( -\frac{47}{8} + \frac{7}{2R} - \frac{3}{8R^2} - \frac{1}{32R^3} + \right. \\ &+ \frac{R}{1-R} \left( -\frac{1}{48} - \frac{1}{3}R + \frac{17}{12}R^2 + R^3 \right) \frac{1}{M_W^2}L(-M_Z^2, M_W^2, M_W^2) + \\ &+ \frac{R}{1-R} \left( -\frac{1}{4} + \frac{1}{12}r_Z - \frac{1}{48}r_Z^2 \right) \frac{1}{M_W^2}L(-M_Z^2, M_Z^2, M_\chi^2) + \\ &+ \frac{1}{1-R} \left( -\frac{1}{4} + \frac{1}{2}R + \right. \\ &+ \left. \frac{1}{12}r_W - \frac{1}{6}r_Z + \frac{1}{24}r_Wr_Z - \frac{1}{48}r_W^2 \right) \frac{1}{M_W^2}L(-M_W^2, M_W^2, M_\chi^2) + \\ &+ \frac{1}{1-R} \left( \frac{25}{12} - \frac{11}{6}R - 2R^2 - \frac{7}{24R} - \frac{1}{48R^2} \right) \frac{1}{M_W^2}L(-M_W^2, M_W^2, M_Z^2) + \\ &+ \left. \left( -\frac{1}{4} - \frac{1}{8}r_W^{-1} + \frac{3}{2}r_W^{-2} - \frac{9}{2} \frac{1}{r_W^2(r_W - 4)} \right) \frac{1}{M_W^2}L(-M_\chi^2, M_W^2, M_W^2) + \right.\end{aligned}$$

$$\begin{aligned}
& + \left( -\frac{1}{8} - \frac{1}{16}r_Z^{-1} + \frac{3}{4}r_Z^{-2} - \frac{9}{4r_Z^2}(r_Z - 4) \right) \frac{1}{M_W^2} L(-M_\chi^2, M_Z^2, M_Z^2) + \\
& + \frac{9}{16}r_Z - \frac{3}{16}r_Z^2 + \frac{1}{32}r_Z^3 \log R + \\
& + \left( -\frac{9}{16} + \frac{3}{16}r_W - \frac{3}{16}r_Z - \frac{1}{32}r_W^2 + \frac{1}{32}r_W r_Z + \frac{1}{32}r_Z^2 \right) \times \\
& \times r_W \log r_W - \frac{9}{8M_W^2} L(-M_\chi^2, M_\chi^2, M_\chi^2) - \\
& - \frac{1}{M_W^2} \text{Tr} \left[ \frac{1}{24} \frac{R}{1-R} - \left( \frac{1}{6}|Q_i| - \frac{1}{3}Q_i^2 \right) R - \frac{1}{3}Q_i^2 R^2 - \right. \\
& - \left. \text{Tr} \left[ \frac{3}{8} \left( 1 - \frac{R}{1-R} \right) \frac{m_i^2}{M_W^2} + \frac{1}{8} \frac{1}{1-R} - \frac{1}{2}|Q_i| - \frac{3m_i^4}{M_W^2 M_\chi^2} \right] \log \frac{m_i^2}{M_W^2} + \right. \\
& + \left. \left[ -\frac{3}{2}r_W^{-1} - \frac{q^2 + (p-q)^2 - p^2}{4M_\chi^2} + \frac{p^2(q^2 + (p-q)^2)}{8M_W^2 M_\chi^2} \right] \frac{1}{2p^2} L(p^2, M_W^2, M_W^2) + \right. \\
& + \left. \left[ -\frac{3}{2}r_W^{-1} - \frac{p^2 + (p-q)^2 - q^2}{4M_\chi^2} + \frac{q^2(p^2 + (p-q)^2)}{8M_W^2 M_\chi^2} \right] \frac{1}{2q^2} L(q^2, M_W^2, M_W^2) + \right. \\
& + \left. \left[ -\frac{3}{2}r_W^{-1} - \frac{p^2 + q^2 - (p-q)^2}{4M_\chi^2} + \frac{(p-q)^2(p^2 + q^2)}{8M_W^2 M_\chi^2} \right] \times \right. \\
& \times \frac{1}{2(p-q)^2} L((p-q)^2, M_W^2, M_W^2) + \\
& + \left[ -\frac{3}{4R}r_Z^{-1} - \frac{1}{8R} \frac{q^2 + (p-q)^2 - p^2}{M_\chi^2} + \frac{p^2(q^2 + (p-q)^2)}{16M_W^2 M_\chi^2} \right] \times \\
& \times \frac{1}{2p^2} L(p^2, M_Z^2, M_Z^2) + \\
& + \left[ -\frac{3}{4R}r_Z^{-1} - \frac{1}{8R} \frac{p^2 + (p-q)^2 - q^2}{M_\chi^2} + \frac{q^2(p^2 + (p-q)^2)}{16M_W^2 M_\chi^2} \right] \times \\
& \times \frac{1}{2q^2} L(q^2, M_Z^2, M_Z^2) + \\
& + \left[ -\frac{3}{4R}r_Z^{-1} - \frac{1}{8R} \frac{p^2 + q^2 - (p-q)^2}{M_\chi^2} + \frac{(p-q)^2(p^2 + q^2)}{16M_W^2 M_\chi^2} \right] \times \\
& \times \frac{1}{2(p-q)^2} L((p-q)^2, M_Z^2, M_Z^2) -
\end{aligned}$$



$$\begin{aligned}
& - \frac{9}{16} r_W \left[ \frac{1}{2p^2} L(p^2, M_\chi^2, M_\chi^2) + \frac{1}{2q^2} L(q^2, M_\chi^2, M_\chi^2) + \right. \\
& + \left. \frac{1}{2(p-q)^2} L((p-q)^2, M_\chi^2, M_\chi^2) \right] + \\
& + \frac{1}{M_W^2} \text{Tr} \left[ \frac{1}{16} \frac{R}{1-R} - \left( \frac{1}{4} |Q_i| - \frac{1}{2} Q_i^2 \right) R - \frac{1}{2} Q_i^2 R^2 - \frac{1}{16} \frac{R}{1-R} \frac{m_i^2}{M_Z^2} - \right. \\
& - \left. \frac{1}{2} \left( |Q_i| - 2Q_i^2 \right) \frac{m_i^2}{M_Z^2} R - Q_i^2 R^2 \frac{m_i^2}{M_Z^2} \right] L(-M_Z^2, m_i^2, m_i^2) + \\
& + \frac{1}{M_W^2} \text{Tr} \left[ \frac{3m_i^2}{16M_\chi^2} + \frac{21m_i^4}{16M_\chi^4} \right] L(-M_\chi^2, m_i^2, m_i^2) + \\
& + \frac{1}{M_W^2 M_\chi^2} \text{Tr} m_i^4 \left[ \frac{1}{2p^2} L(p^2, m_i^2, m_i^2) + \right. \\
& + \left. \frac{1}{2q^2} L(q^2, m_i^2, m_i^2) + \frac{1}{2(p-q)^2} L((p-q)^2, m_i^2, m_i^2) \right] - \\
& - \frac{3}{4} \left( \frac{R}{1-R} - 1 \right) \sum_{ij}^{N_f/2} \left[ \frac{m_i m_j}{3M_W^2} - \left( \frac{1}{3} - \frac{m_i^2 + m_j^2}{2M_W^2} \right) \log \frac{m_i m_j}{M_W^2} + \right. \\
& + \left. \frac{(m_i^2 - m_j^2)^3}{12M_W^6} \log \frac{m_i^2}{m_j^2} + \right. \\
& + \left. \left( \frac{1}{6} - \frac{m_i^2 + m_j^2}{12M_W^6} - \frac{(m_i^2 - m_j^2)^3}{12M_W^4} \right) \frac{1}{M_W^2} L(-M_W^2, m_i^2, m_j^2) \right] K_{ij} K_{ij}^+ - \\
& - \frac{27}{8} r_W M_\chi^2 I_1(q^2, (p-q)^2, p^2, M_\chi^2, M_\chi^2, M_\chi^2) - \\
& - \left[ 6r_W^{-1} M_W^2 + (p^2 + q^2 + (p-q)^2) r_W^{-1} + \right. \\
& + \left. \frac{p^4 + q^4 + (p-q)^4 - p^2 q^2 - p^2 (p-q)^2 - q^2 (p-q)^2}{2M_\chi^2} - \frac{p^2 q^2 (p-q)^2}{4M_W^2 M_\chi^2} \right] \times \\
& \times I_1(q^2, (p-q)^2, p^2, M_W^2, M_W^2, M_W^2) - \\
& - \left[ \frac{3}{R} M_Z^2 r_Z^{-1} + \frac{1}{2R} (p^2 + q^2 + (p-q)^2) r_Z^{-1} + \right. \\
& + \left. \frac{1}{4R} \frac{p^4 + q^4 + (p-q)^4 - p^2 q^2 - p^2 (p-q)^2 - q^2 (p-q)^2}{M_\chi^2} - \frac{p^2 q^2 (p-q)^2}{8M_W^2 M_\chi^2} \right] \times \\
& \times I_1(q^2, (p-q)^2, p^2, M_Z^2, M_Z^2, M_Z^2) +
\end{aligned}$$

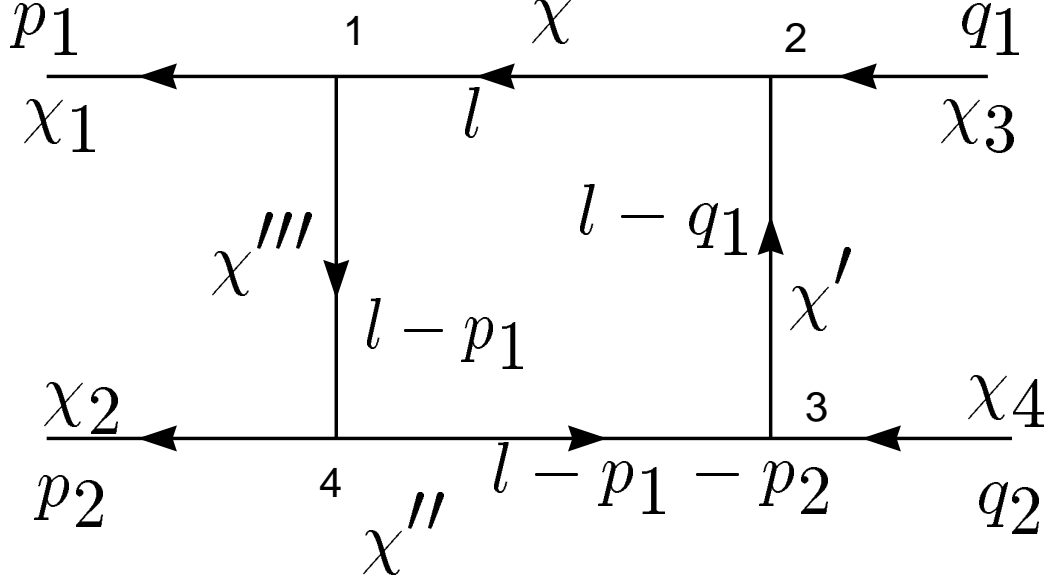

Figure 10:

$$\begin{aligned}
& + \frac{1}{M_W^2 M_\chi^2} \text{Tr} m_i^4 \left( 4m_i^2 + \frac{1}{2}(p^2 + q^2 + (p-q)^2) \right) \times \\
& \times I_1(q^2, (p-q)^2, p^2, m_i^2, m_i^2, m_i^2) \}. \tag{2.29}
\end{aligned}$$

### 2.3 Box diagrams.

$$i\mathcal{M}(p_1^2, p_2^2, q_1^2, q_2^2, s, t) = \frac{if_1^{3\chi} f_2^{3\chi} f_3^{3\chi} f_4^{3\chi}}{16\pi^2} I_2(q_1^2, q_2^2, p_2^2, p_1^2, s, t; M_\chi^2, M_{\chi'}^2, M_{\chi''}^2, M_{\chi'''}^2), \tag{2.30}$$

$$i\mathcal{M}(p_1^2, p_2^2, q_1^2, q_2^2, s, t) = \frac{if_1^{3\chi} f_2^{3\chi} f_3^{3\chi} f_4^{3\chi}}{16\pi^2} I_2(q_1^2, p_2^2, q_2^2, p_1^2, u, t; M_\chi^2, M_{\chi'}^2, M_{\chi''}^2, M_{\chi'''}^2). \tag{2.31}$$

The analytical result of the diagram (Fig. 12) and the similar diagram

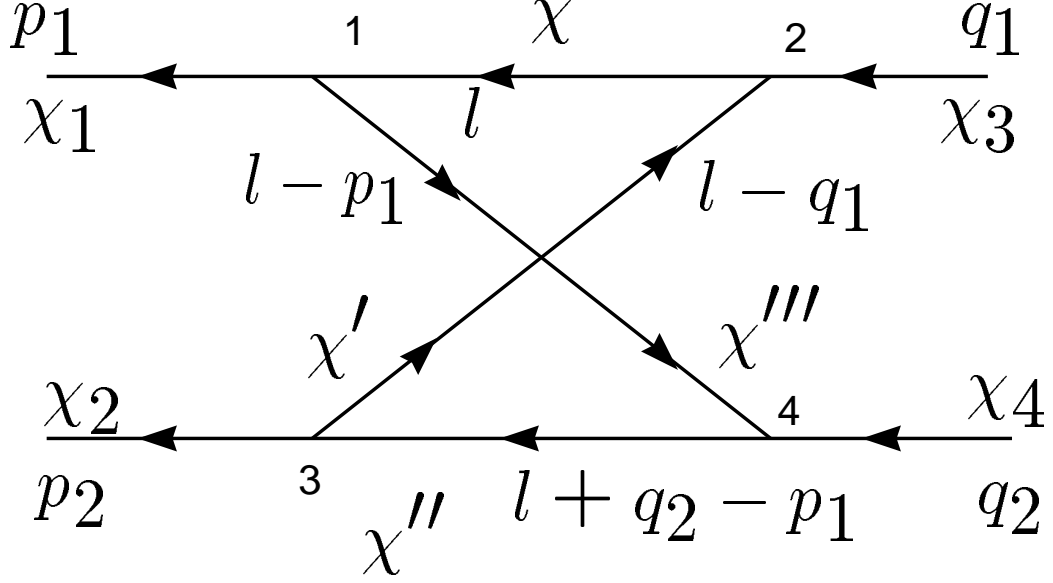

Figure 11:

with the opposite lepton current direction is

$$\begin{aligned}
i\mathcal{M}(p_1^2, p_2^2, q_1^2, q_2^2, s, t) = & -\frac{if_1^\chi f_2^\chi f_3^\chi f_4^\chi}{4\pi^2} \left\{ -2B_5 P - \frac{B_5}{2} - \frac{B_5}{2} I_0(s, m_1^2, m_3^2) - \right. \\
& - \frac{B_5}{2} I_0(t, m_2^2, m_4^2) + \frac{1}{2} [B_5 (q_1 q_2 - m_2^2) - B_6 m_1 m_2 - B_7 m_1 m_3 - B_9 m_2 m_3] \times \\
& \times I_1(q_1^2, q_2^2, s, m_1^2, m_2^2, m_3^2) + \\
& - \frac{1}{2} [B_5 (q_1 p_1 + m_1^2) - B_6 m_1 m_2 - B_8 m_1 m_4 - B_{10} m_2 m_4] I_1(q_1^2, t, p_1^2, m_1^2, m_2^2, m_4^2) + \\
& + \frac{1}{2} [B_5 (p_1 p_2 - m_4^2) - B_7 m_1 m_3 - B_8 m_1 m_4 - B_{11} m_3 m_4] I_1(s, p_2^2, p_1^2, m_1^2, m_3^2, m_4^2) + \\
& - \frac{1}{2} [B_5 (q_2 p_2 - m_3^2) - B_9 m_2 m_3 - B_{10} m_2 m_4 - B_{11} m_3 m_4] I_1(q_2^2, p_2^2, t, m_2^2, m_3^2, m_4^2) + \\
& + \frac{1}{4} [B_5 ((q_1^2 + m_1^2 + m_2^2)(p_2^2 + m_3^2 + m_4^2) - (s + m_1^2 + m_3^2)(t + m_2^2 + m_4^2) + \\
& + (p_1^2 + m_1^2 + m_4^2)(q_2^2 + m_2^2 + m_3^2) + 2B_6 m_1 m_2 (p_2^2 + m_3^2 + m_4^2) + \\
& + 2B_7 m_1 m_3 (t + m_2^2 + m_4^2) +
\end{aligned}$$

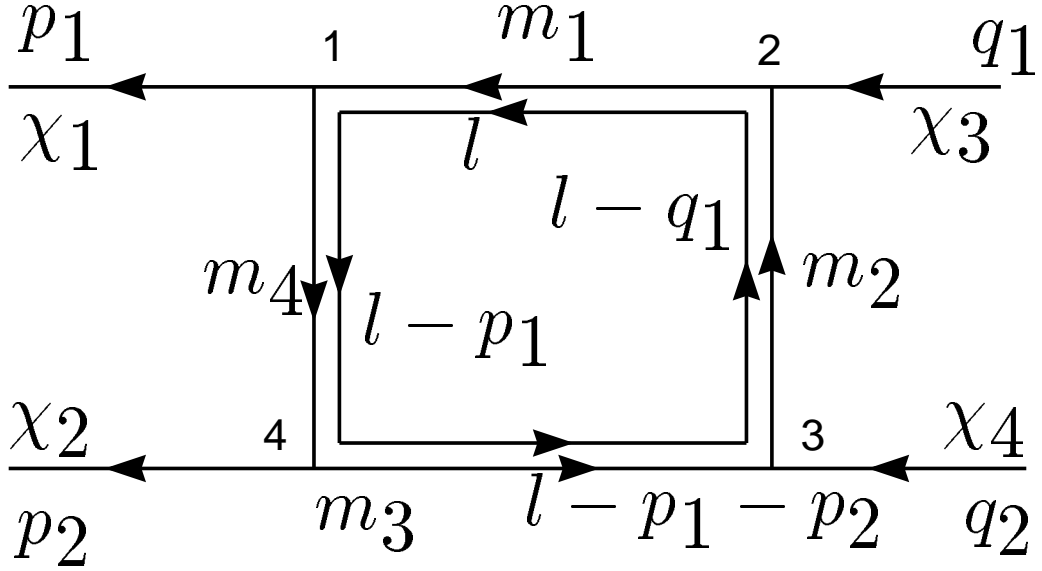

Figure 12:

$$\begin{aligned}
& + 2B_8 m_1 m_4 (q_2^2 + m_2^2 + m_3^2) + 2B_9 m_2 m_3 (p_1^2 + m_1^2 + m_4^2) + \\
& + 2B_{10} m_2 m_4 (s + m_1^2 + m_3^2) + \\
& + 2B_{11} m_3 m_4 (q_1^2 + m_1^2 + m_2^2) + \\
& + 4B_{12} m_1 m_2 m_3 m_4 \left[ I_2(q_1^2, q_2^2, p_2^2, p_1^2, s, t; m_1^2, m_2^2, m_3^2, m_4^2) \right],
\end{aligned} \tag{2.32}$$

where

$$\begin{aligned}
B_5 & = 1 - b_1 b_2 + b_1 b_3 - b_1 b_4 - b_2 b_3 + b_2 b_4 - b_3 b_4 + b_1 b_2 b_3 b_4, \\
B_6 & = 1 + b_1 b_2 + b_1 b_3 - b_1 b_4 + b_2 b_3 - b_2 b_4 - b_3 b_4 - b_1 b_2 b_3 b_4, \\
B_7 & = 1 + b_1 b_2 - b_1 b_3 - b_1 b_4 - b_2 b_3 - b_2 b_4 + b_3 b_4 + b_1 b_2 b_3 b_4, \\
B_8 & = 1 + b_1 b_2 - b_1 b_3 + b_1 b_4 - b_2 b_3 + b_2 b_4 - b_3 b_4 - b_1 b_2 b_3 b_4, \\
B_9 & = 1 - b_1 b_2 - b_1 b_3 - b_1 b_4 + b_2 b_3 + b_2 b_4 + b_3 b_4 - b_1 b_2 b_3 b_4, \\
B_{10} & = 1 - b_1 b_2 - b_1 b_3 + b_1 b_4 + b_2 b_3 - b_2 b_4 - b_3 b_4 + b_1 b_2 b_3 b_4, \\
B_{11} & = 1 - b_1 b_2 + b_1 b_3 + b_1 b_4 - b_2 b_3 - b_2 b_4 + b_3 b_4 - b_1 b_2 b_3 b_4, \\
B_{12} & = 1 + b_1 b_2 + b_1 b_3 + b_1 b_4 + b_2 b_3 + b_2 b_4 + b_3 b_4 + b_1 b_2 b_3 b_4,
\end{aligned} \tag{2.33}$$

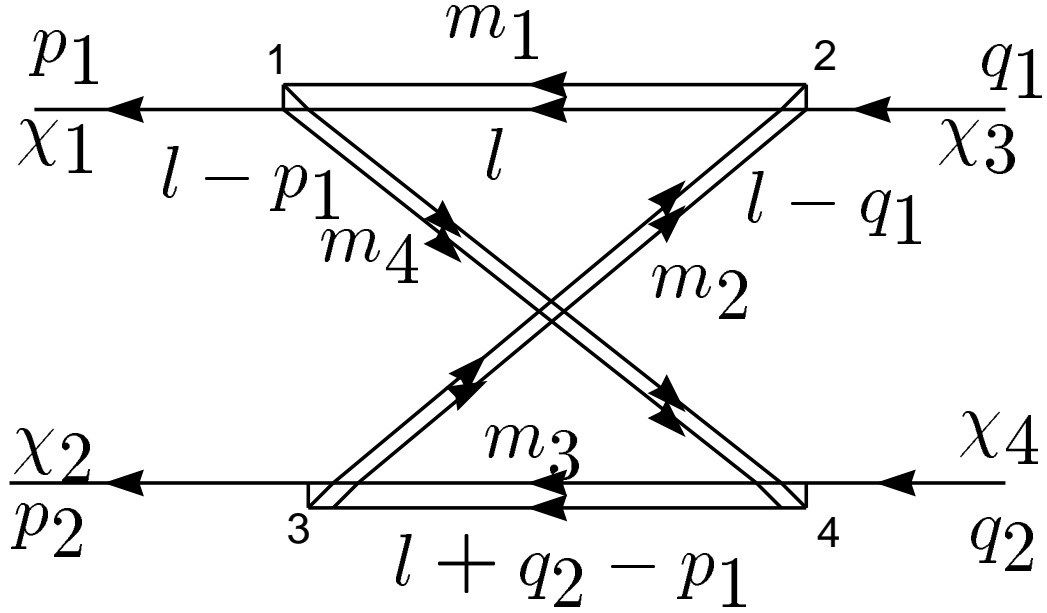

Figure 13:

The diagram (Fig. 13) and the analogous diagram with the opposite lepton current direction are described by the above expression but with the substitution  $p_2 \Leftrightarrow -q_2$ .

The diagram (Fig. 14) and the similar diagram with the opposite vector boson current direction are described by

$$\begin{aligned}
i\mathcal{M}(p_1^2, p_2^2, q_1^2, q_2^2, s, t) &= \frac{if_1^{V\chi} f_2^{V\chi} f_3^{V\chi} f_4^{V\chi}}{16\pi^2} \left\{ \left[ \frac{3}{2M_V^6} (s + t - p_1^2 - p_2^2 - q_1^2 - q_2^2) - \right. \right. \\
&- \frac{1}{8M_V^8} \left( (p_1^2 + p_2^2 + q_1^2 + q_2^2)(p_1^2 + p_2^2 + q_1^2 + q_2^2 - \frac{s+t}{6}) + p_1^2 q_2^2 + p_2^2 q_1^2 - \right. \\
&- \left. \left. \frac{(k_2^2 - k_1^2)(p_2^2 - p_1^2)}{3} - \frac{(k_2^2 - p_1^2)(k_2^2 - p_2^2)}{3} - \frac{s^2 + t^2 - st}{3} \right) \right] P_+ \\
&+ \left[ 3 + \frac{1}{2M_V^2} (p_1^2 + p_2^2 + q_1^2 + q_2^2) + \frac{1}{4M_V^4} (p_1^4 + p_2^4 + q_1^4 + q_2^4 + \right. \\
&+ \left. s^2 + t^2 - (s+t)(p_1^2 + p_2^2 + q_1^2 + q_2^2) + p_1^2 q_2^2 + p_2^2 q_1^2 \right) +
\end{aligned}$$

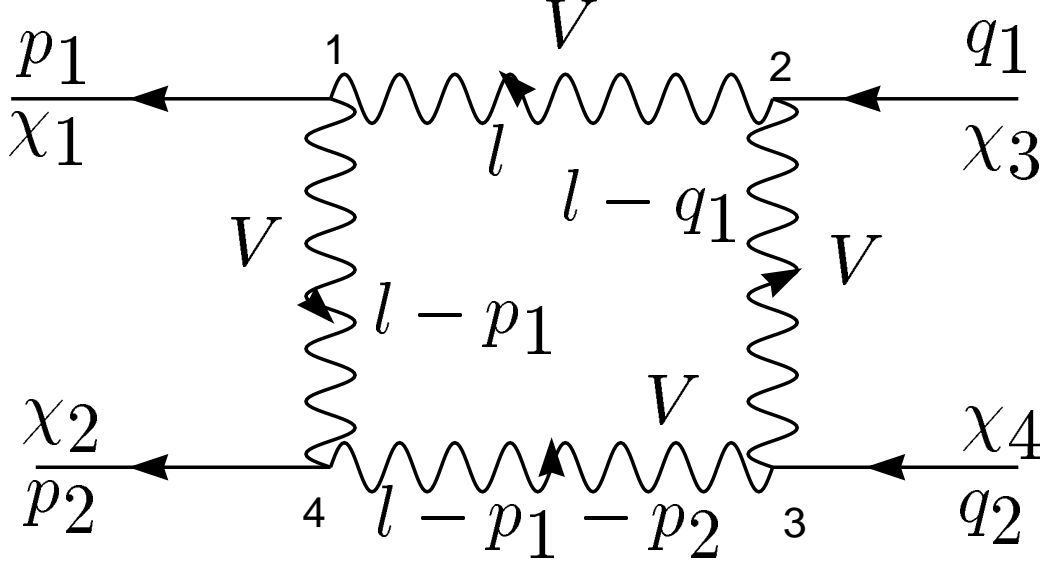

Figure 14:

$$\begin{aligned}
& + \frac{1}{8M_V^6} \left( p_1^2 p_2^2 (q_1^2 + q_2^2) + q_1^2 q_2^2 (p_1^2 + p_2^2) - s(p_1^2 p_2^2 + q_1^2 q_2^2) - t(p_1^2 q_1^2 + p_2^2 q_2^2) \right) + \\
& + \frac{1}{16M_V^8} \left( p_1^2 p_2^2 q_1^2 q_2^2 \right) \left[ I_2(q_1^2, q_2^2, p_2^2, p_1^2, s, t, M_V^2, M_V^2, M_V^2, M_V^2) + \right. \\
& + \left[ \frac{1}{4M_V^4} (-p_1^2 - p_2^2 + t + 2s - F_1) + \frac{1}{8M_V^6} (t(q_1^2 + q_2^2) + s(p_1^2 + p_2^2) - st - 2q_1^2 q_2^2 - \right. \\
& - p_1^2 q_2^2 - p_2^2 q_1^2 + sF_1) - \frac{q_1^2 q_2^2}{16M_V^8} (p_1^2 + p_2^2 - t + F_1) \left. \right] I_1(q_1^2, q_2^2, s, M_V^2, M_V^2, M_V^2) + \\
& + \left[ \frac{1}{4M_V^4} (-q_1^2 - q_2^2 + t + 2s - F_2) + \frac{1}{8M_V^6} (t(p_1^2 + p_2^2) + s(q_1^2 + q_2^2) - st - 2p_1^2 p_2^2 - \right. \\
& - p_1^2 q_2^2 - p_2^2 q_1^2 + sF_2) - \frac{p_1^2 p_2^2}{16M_V^8} (q_1^2 + q_2^2 - t + F_2) \left. \right] I_1(p_1^2, p_2^2, s, M_V^2, M_V^2, M_V^2) + \\
& + \left[ \frac{1}{4M_V^4} (-p_2^2 - q_2^2 + s + 2t - F_3) + \frac{1}{8M_V^6} (s(p_1^2 + q_1^2) + t(p_2^2 + q_2^2) - \right. \\
& - st - 2p_1^2 q_1^2 - p_1^2 q_2^2 - p_2^2 q_1^2 + tF_3) -
\end{aligned}$$

$$\begin{aligned}
& - \frac{p_1^2 q_1^2}{16M_V^8} (p_2^2 + q_2^2 - s + F_3) \Big] I_1(q_1^2, p_1^2, t, M_V^2, M_V^2, M_V^2) + \\
& + \left[ \frac{1}{4M_V^4} (-p_1^2 - q_1^2 + s + 2t - F_4) + \right. \\
& + \frac{1}{8M_V^6} (s(p_2^2 + q_2^2) + t(p_1^2 + q_1^2) - st - 2p_2q_2 - p_1^2q_2^2 - p_2^2q_1^2 + tF_4) - \\
& - \left. \frac{p_2^2 q_2^2}{16M_V^8} (p_1^2 + q_1^2 - s + F_4) \right] I_1(q_2^2, p_2^2, t, M_V^2, M_V^2, M_V^2) + \\
& + \left[ \frac{1}{4M_V^4} (1 + F_5 + F_6) + \frac{1}{8M_V^6} \left( \frac{s+t+u}{2} - 2q_1^2 + p_1q_2 + p_2^2 - q_2^2 - p_1^2 - \right. \right. \\
& - sF_5 - tF_6) + \frac{q_1^2}{16M_V^8} \left( \frac{s+t+u}{2} + p_2q_1 - p_1^2 - p_2^2 - \right. \\
& - \left. q_1^2 - q_2^2 + q_2^2F_5 + p_1^2F_6 \right) \Big] I_0(q_1^2, M_V^2, M_V^2) + \\
& + \left[ \frac{1}{4M_V^4} (1 - F_7 - F_8) + \frac{1}{8M_V^6} \left( \frac{s+t+u}{2} - 2q_2^2 + p_2q_1 + p_1^2 - \right. \right. \\
& - \left. q_1^2 - p_2 - sF_7 - tF_8 \right) + \\
& + \left. \frac{q_2^2}{16M_V^8} \left( \frac{s+t+u}{2} + p_2q_1 - p_1^2 - p_2^2 - q_1^2 - q_2^2 + q_1^2F_7 + p_2^2F_8 \right) \right] I_0(q_2^2, M_V^2, M_V^2) \\
& + \left[ \frac{1}{4M_V^4} (1 + F_9 + F_{10}) + \frac{1}{8M_V^6} \left( \frac{s+t+u}{2} - 2p_1^2 + p_2q_1 + \right. \right. \\
& + \left. q_2^2 - p_2^2 - q_1^2 - sF_9 - tF_{10} \right) + \\
& + \left. \frac{p_1^2}{16M_V^8} \left( \frac{s+t+u}{2} + p_2q_1 - p_1^2 - p_2^2 - q_1^2 - q_2^2 + q_1^2F_9 + p_2^2F_{10} \right) \right] \times \\
& \times I_0(p_1^2, M_V^2, M_V^2) + \left[ \frac{1}{4M_V^4} (1 + F_{11} + F_{12}) + \right. \\
& + \frac{1}{8M_V^6} \left( \frac{s+t+u}{2} - 2p_2^2 + p_1q_2 + q_1^2 - p_1^2 - q_2^2 - sF_{11} - tF_{12} \right) + \\
& + \frac{p_2^2}{16M_V^8} \left( \frac{s+t+u}{2} + p_1q_2 - p_1^2 - p_2^2 - \right. \\
& - \left. q_1^2 - q_2^2 + p_1^2F_{11} + q_2^2F_{12} \right) \Big] I_0(p_2^2, M_V^2, M_V^2) +
\end{aligned}$$

$$\begin{aligned}
& + \left[ -\frac{1}{4M_V^4} (2 - F_{13} - F_{14}) + \frac{1}{8M_V^6} \left( \frac{11}{6}s + \frac{5}{3}t - \frac{5}{6}p_1^2 - \frac{5}{6}p_2^2 - \frac{5}{6}q_1^2 - \frac{5}{6}q_2^2 - \right. \right. \\
& - \left. \left. \frac{(k_2^2 - k_1^2)(p_2^2 - p_1^2)}{6s} - sF_{13} - sF_{14} \right) - \right. \\
& - \frac{1}{16M_V^8} \left( p_1^2 p_2^2 + q_1^2 q_2^2 + \frac{q_1^2 p_2^2 + p_1^2 q_2^2}{2} - \frac{s(p_1^2 + p_2^2 + q_1^2 + q_2^2)}{6} - \right. \\
& - \left. \frac{(k_1^2 - p_1^2)(k_2^2 - p_2^2)}{3} - \frac{st + 2s^2}{6} + q_1^2 q_2^2 F_{13} + p_1^2 p_2^2 F_{14} \right] I_0(s, M_V^2, M_V^2) - \\
& - \left[ -\frac{1}{4M_V^4} (2 - F_{15} - F_{16}) + \frac{1}{8M_V^6} \left( \frac{11}{6}s + \frac{5}{3}t - \frac{5}{6}p_1^2 - \frac{5}{6}p_2^2 - \frac{5}{6}q_1^2 - \frac{5}{6}q_2^2 + \right. \right. \\
& + \left. \left. \frac{(k_1^2 - p_1^2)(k_2^2 - p_2^2)}{6t} - tF_{15} - tF_{16} \right) - \right. \\
& - \frac{1}{16M_V^8} \left( p_1^2 q_1^2 + p_2^2 q_2^2 + \frac{p_1^2 q_2^2 + p_2^2 q_1^2}{2} + \frac{t(p_1^2 + p_2^2 + q_1^2 + q_2^2)}{6} - \right. \\
& - \left. \left. \frac{(k_1^2 - p_1^2)(k_2^2 - p_2^2)}{3} - \frac{2t^2 + st}{6} - p_1^2 q_1^2 F_{15} - p_2^2 q_2^2 F_{16} \right) \right] \times \\
& \times I_0(t, M_V^2, M_V^2) + \frac{1}{16M_V^6} \log \frac{M_V^2}{M_W^2} \left[ s + t - \frac{14}{3}p_1^2 - \frac{14}{3}p_2^2 - \frac{14}{3}q_1^2 - \frac{14}{3}q_2^2 + \right. \\
& + \left. \frac{(k_2^2 - k_1^2)(p_2^2 - p_1^2)}{3s} + \frac{(k_1^2 - p_1^2)(k_2^2 - p_2^2)}{3t} \right] + \\
& + \frac{1}{4M_V^6} [p_1^2 + p_2^2 + q_1^2 + q_2^2] + \frac{1}{16M_V^8} \left[ \frac{s^2 + 4st + t^2}{18} + \right. \\
& + \left. \frac{(k_2^2 - k_1^2)(p_2^2 - p_1^2) + (k_1^2 - p_1^2)(k_2^2 - p_2^2)}{18} - \frac{(s+t)(p_1^2 + p_2^2 + k_1^2 + k_2^2)}{18} \right] \left. \right\}. \tag{2.34}
\end{aligned}$$

The result from Fig. 15 and the analogous diagram with the opposite vector boson current direction are obtained from the above expression but with the substitution  $p_2 \Leftrightarrow -q_2$ .

Here,

$$\begin{aligned}
F_1 = & \frac{1}{s^2 + q_1^4 + q_2^4 - 2sq_1^2 - 2sq_2^2 - 2q_1^2 q_2^2} \times \\
& \left\{ (t + q_1^2 - p_1^2) \left[ (s + q_1^2 - q_2^2)(q_1^2 - q_2^2) - 2sq_1^2 \right] + q_1^2 (p_2^2 - p_1^2 + q_1^2 - q_2^2)(s + q_2^2 - q_1^2) \right\} \tag{2.35}
\end{aligned}$$



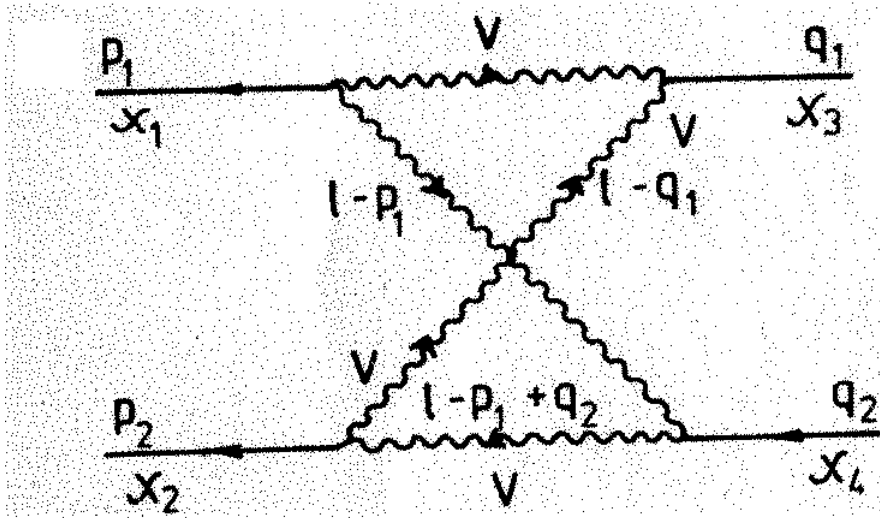

Figure 15:

$$F_2 = \frac{1}{s^2 + p_1^4 + p_2^4 - 2sp_1^2 - 2sp_2^2 - 2p_1^2p_2^2} \times \quad (2.36)$$

$$\left\{ (t + p_1^2 - q_1^2) \left[ (s + p_1^2 - p_2^2)(p_1^2 - p_2^2) - 2sp_1^2 \right] + p_1^2(p_1^2 - p_2^2 + q_2^2 - q_1^2)(s + p_2^2 - p_1^2) \right\}$$

$$F_3 = \frac{1}{t + p_1^4 + q_1^4 - 2p_1^2q_1^2 - 2tp_1^2 - 2tq_1^2} \times \quad (2.37)$$

$$\left\{ (s + q_1^2 - q_2^2) \left[ (t + q_1^2 - p_1^2)(q_1^2 - p_1^2) - 2tq_1^2 \right] + q_1^2(p_2^2 - p_1^2 + q_1^2 - q_2^2)(t + p_1^2 - q_1^2) \right\}$$

$$F_4 = \frac{1}{t^2 + p_2^4 + q_2^4 - 2tp_2^2 - 2tq_2^2 - 2p_2^2q_2^2} \times \quad (2.38)$$

$$\left\{ (s + q_2^2 - q_1^2) \left[ (t + q_2^2 - p_2^2)(q_2^2 - p_2^2) - 2tq_2^2 \right] + q_2^2(p_1^2 - p_2^2 + q_2^2 - q_1^2)(t + q_2^2 - p_2^2) \right\}$$

$$F_5 = \frac{(t + q_1^2 - p_1^2)(s + q_1^2 - q_2^2) + 2q_1^2(p_1^2 - p_2^2 + q_2^2 - q_1^2)}{s^2 + q_1^4 + q_2^4 - 2sq_1^2 - 2sq_2^2 - 2q_1^2q_2^2} \quad (2.39)$$

$$F_6 = \frac{(s + q_1^2 - q_2^2)(t + q_1^2 - p_1^2) + 2q_1^2(p_1^2 - p_2^2 + q_2^2 - q_1^2)}{t^2 + p_1^4 + q_1^4 - 2tp_1^2 - 2tq_1^2 - 2p_1^2q_1^2} \quad (2.40)$$

$$F_7 = \frac{(t + q_1^2 - p_1^2)(s + q_2^2 - q_1^2) + (p_1^2 - p_2^2 + q_2^2 - q_1^2)(s - q_1^2 - q_2^2)}{s^2 + q_1^4 + q_2^4 - 2sq_1^2 - 2sq_2^2 - 2q_1^2q_2^2} \quad (2.41)$$

$$F_8 = \frac{(s + q_2^2 - q_1^2)(t + q_2^2 - p_2^2) + 2q_2^2(p_2^2 - p_1^2 + q_1^2 - q_2^2)}{t^2 + p_2^4 + q_2^4 - 2tp_2^2 - 2tq_2^2 - 2p_2^2q_2^2} \quad (2.42)$$

$$F_9 = \frac{(t + p_1^2 - q_1^2)(s + p_1^2 - p_2^2) + 2p_1^2(p_2^2 - p_1^2 + q_1^2 - q_2^2)}{s^2 + p_1^4 + p_2^4 - 2sp_1^2 - 2sp_2^2 - 2p_1^2p_2^2} \quad (2.43)$$

$$F_{10} = \frac{(s + q_1^2 - q_2^2)(t + p_1^2 - q_1^2) + (t - q_1^2 - p_1^2)(p_2^2 - p_1^2 + q_1^2 - q_2^2)}{t^2 + p_1^4 + q_1^4 - 2tp_1^2 - 2tq_1^2 - 2p_1^2q_1^2} \quad (2.44)$$

$$F_{11} = \frac{(t + p_1^2 - q_1^2)(s + p_2^2 - p_1^2) + (s - p_1^2 - p_2^2)(p_2^2 - p_1^2 + q_1^2 - q_2^2)}{s^2 + p_1^4 + p_2^4 - 2sp_1^2 - 2sp_2^2 - 2p_1^2p_2^2} \quad (2.45)$$

$$F_{12} = \frac{(s + q_2^2 - q_1^2)(t + p_2^2 - q_2^2) + (t - p_2^2 - q_2^2)(p_2^2 - p_1^2 + q_1^2 - q_2^2)}{t^2 + p_2^4 + q_2^4 - 2tp_2^2 - 2tq_2^2 - 2p_2^2q_2^2} \quad (2.46)$$

$$F_{13} = \frac{-2s(t + q_1^2 - p_1^2) + (s + q_1^2 - q_2^2)(p_1^2 - p_2^2 + q_2^2 - q_1^2)}{s^2 + q_1^4 + q_2^4 - 2sq_1^2 - 2sq_2^2 - 2q_1^2q_2^2} \quad (2.47)$$

$$F_{14} = \frac{-2s(t + p_1^2 - q_1^2) + (s + p_1^2 - p_2^2)(p_1^2 - p_2^2 + q_2^2 - q_1^2)}{s^2 + p_1^4 + p_2^4 - 2sp_1^2 - 2sp_2^4 - 2p_1^2p_2^2} \quad (2.48)$$

$$F_{15} = \frac{-2t(s + q_1^2 - q_2^2) + (t + q_1^2 - p_1^2)(p_1^2 - p_2^2 + q_2^2 - q_1^2)}{t^2 + p_1^4 + q_1^4 - 2tp - 1^2 - 2tq_1^2 - 2q_1^2q_2^2} \quad (2.49)$$

$$F_{16} = \frac{-2t(s + q_2^2 - q_1^2) + (t + q_2^2 - p_2^2)(p_1^2 - p_2^2 + q_2^2 - q_1^2)}{t^2 + p_2^4 + q_2^4 - 2tp_2^2 - 2tq_2^2 - 2p_2^2q_2^2} \quad (2.50)$$

and

$$\begin{aligned} p_1p_2 &= \frac{1}{2}(s - p_1^2 - p_2^2), & p_1q_2 &= \frac{1}{2}(s + t - p_2^2 - q_1^2), \\ q_1q_2 &= \frac{1}{2}(s - q_1^2 - q_2^2), & p_2q_1 &= \frac{1}{2}(s + t - p_1^2 - q_2^2), \\ p_1q_1 &= -\frac{1}{2}(t - p_1^2 - q_1^2), \\ p_2q_2 &= -\frac{1}{2}(t - p_2^2 - q_2^2) \end{aligned} \quad (2.51)$$

with  $s, t, u$  being the Mandelstam variables.  $I_0, I_1, I_2$  are the scalar one-loop integrals calculated in [14].

### 3 The one-loop amplitudes.

The box diagrams of the previous Section and the diagrams drawn at *Fig. 16* (see also [13b]) contribute to the Higgs-Higgs amplitude up to fourth order of perturbation theory to give

$$i\mathcal{M}_a = \frac{9ig^2}{4}r_W \frac{M_\chi^2}{t + M_\chi^2}, \quad (3.52)$$

$$i\mathcal{M}_{b,c} = -\frac{3g}{2}r_W \frac{M_W \Gamma^{ren}(p_{1,2}^2, q_{1,2}^2, t)}{t + M_\chi^2}, \quad (3.53)$$

$$i\mathcal{M}_{d,e} = \frac{9g^2}{4}r_W \frac{M_\chi^2 \Pi^{ren}(p_{1,2}^2)}{(p_{1,2}^2 + M_\chi^2)(t + M_\chi^2)}, \quad (3.54)$$

$$i\mathcal{M}_{f,g} = \frac{9g^2}{4}r_W \frac{M_\chi^2 \Pi^{ren}(q_{1,2}^2)}{(q_{1,2}^2 + M_\chi^2)(t + M_\chi^2)}, \quad (3.55)$$

$$i\mathcal{M}_h = \frac{9g^2}{4} r_W \frac{M_\chi^2 \Pi^{ren}(t)}{(t + M_\chi^2)^2}, \quad (3.56)$$

$$i\mathcal{M}_i = \frac{9g^4}{16} r_W^2 \Pi^{(3)}(t), \quad (3.57)$$

$$i\mathcal{M}_j = \frac{g^4}{4} \Pi^{(5)}(t)|_{M_V^2=M_W^2} + \frac{g^4}{4} \frac{1}{R^2} \Pi^{(5)}(t)|_{M_V^2=M_Z^2}, \quad (3.58)$$

$$i\mathcal{M}_{k,l} = -\frac{27}{16} g^4 r_W^2 M_\chi^2 \Gamma^{(1)}(p_{1,2}^2, q_{1,2}, t), \quad (3.59)$$

$$i\mathcal{M}_{m,n} = -\frac{g^4}{2} M_W^2 \Gamma^{(3)}(p_{1,2}^2, q_{1,2}, t)|_{M_V^2=M_W^2} - \frac{g^4}{2} \frac{1}{R^2} M_Z^2 \Gamma^{(3)}(p_{1,2}^2, q_{1,2}, t)|_{M_V^2=M_Z^2}, \quad (3.60)$$

$$i\mathcal{M}_o = -\frac{3ig^2}{4} r_W, \quad (3.61)$$

$$i\mathcal{M}_p = -\frac{3g^2}{4} r_W \frac{\Pi^{ren}(p_1^2)}{(p_1^2 + M_\chi^2)}, \quad (3.62)$$

$$i\mathcal{M}_r = -\frac{3g^2}{4} r_W \frac{\Pi^{ren}(p_2^2)}{(p_2^2 + M_\chi^2)}, \quad (3.63)$$

$$i\mathcal{M}_s = -\frac{3g^2}{4} r_W \frac{\Pi^{ren}(q_1^2)}{(q_1^2 + M_\chi^2)}, \quad (3.64)$$

$$i\mathcal{M}_t = -\frac{3g^2}{4} r_W \frac{\Pi^{ren}(q_2^2)}{(q_2^2 + M_\chi^2)}. \quad (3.65)$$

The digrams describing the interaction of two Higgs particle ( $s$ -channel) are presented in [13], a solid line corresponds to the renormalized propagator and a black circle, to the renormalized vertex.

In the framework of the renormalization scheme [9] (using the unitary gauge) the appropriate counterterm for  $4\chi$  interaction is written as follows:

$$i\mathcal{M}^{c.t.} = -\frac{3g^2 M_\chi^2}{4M_W^2} \left[ 2(Z_\chi - 1) + 2\frac{\delta g}{g} + \frac{\delta M_\chi^2}{M_\chi^2} - \frac{\delta M_W^2}{M_W^2} \right]. \quad (3.66)$$

After substitution of the renormalization constants (see preceding Section) we have

$$i\mathcal{M}^{c.t.}(p_1^2, p_2^2, q_1^2, q_2^2, s, t) = -\frac{ig^4}{16\pi^2} \frac{3r_W}{4} \left\{ \left[ -\frac{3}{4} r_W - 9r_W^{-1} - \frac{9}{2R} r_Z^{-1} + \right. \right.$$

$$\begin{aligned}
& + \frac{6}{M_W^2 M_\chi^2} \text{Tr } m_i^4 \Big] P + \frac{52}{3} - \frac{56}{3}R - 8R^2 - \frac{19}{12R} - \frac{1}{12R^2} + \frac{31}{8}r_W - \\
& - \frac{1}{2}r_W^2 + \frac{1}{2}r_W r_Z + \frac{21}{2}r_W^{-1} + \frac{21}{4R}r_Z^{-1} + \\
& + \left(-\frac{3}{8}r_W + \frac{3}{4R} + \frac{9}{4R}r_Z^{-1}\right) \log R + \frac{1}{1-R} \left(-\frac{47}{6} + \frac{14}{3R} - \frac{1}{2R^2} - \frac{1}{24R^3} + \right. \\
& + \frac{3}{4}r_Z - \frac{1}{4}r_Z^2 + \frac{1}{24}r_Z^3) \log R + \left(-\frac{3}{4} - \frac{1}{4}r_W + \frac{1}{4}r_Z + \frac{1}{24}r_W^2 - \right. \\
& - \frac{1}{24}r_W r_Z - \frac{1}{24}r_Z^2) r_W \log r_W - \frac{20}{9}(1-R) \text{Tr } Q_i^2 + \\
& + \frac{1}{2M_W^2} \frac{R}{1-R} \left(-\frac{1}{12} - \frac{4}{3}R + \frac{17}{3}R^2 + 4R^4\right) L(-M_Z^2, M_W^2, M_W^2) + \\
& + \frac{1}{2M_W^2} \frac{R}{1-R} \left(-1 + \frac{1}{3}r_Z - \frac{1}{12}r_Z^2\right) L(-M_Z^2, M_Z^2, M_\chi^2) + \\
& + \frac{1}{2M_W^2} \frac{1}{1-R} \left(\frac{25}{3} - \frac{22}{3}R - 8R^2 - \frac{7}{6R} - \frac{1}{12R^2}\right) L(-M_W^2, M_W^2, M_Z^2) + \\
& + \frac{1}{2M_W^2} \frac{1}{1-R} \left(-1 + 2R + \frac{1}{3}r_W - \frac{2}{3}r_Z + \right. \\
& + \left. \frac{1}{6}r_W r_Z - \frac{1}{12}r_W^2\right) L(-M_W^2, M_W^2, M_\chi^2) + \\
& + \frac{1}{M_W^2} \left(-\frac{3}{8} + \frac{3}{2}r_W^{-2} - 6\frac{1}{r_W^2(r_W - 4)}\right) L(-M_\chi^2, M_W^2, M_W^2) + \\
& + \frac{1}{M_W^2} \left(-\frac{3}{16} + \frac{3}{4}r_Z^{-2} - 3\frac{1}{r_Z^2(r_Z - 4)}\right) L(-M_\chi^2, M_Z^2, M_Z^2) + \\
& + \frac{21}{16M_W^2} L(-M_\chi^2, M_\chi^2, M_\chi^2) + \\
& + \frac{1}{M_W^2} \text{Tr} \left[ \frac{1}{3}m_i^2 + \left(\frac{8}{3}|Q_i| - \frac{16}{3}Q_i^2\right) R m_i^2 + \frac{16}{3}Q_i^2 R^2 m_i^2 \right] + \\
& + \frac{1}{M_W^4} \text{Tr} \left[ \frac{1}{6}m_i^4 - \frac{1}{6} \frac{R}{1-R} m_i^4 - \frac{15}{2} r_W^{-1} m_i^4 \right] + \\
& - \frac{1}{M_W^2} \text{Tr} \left[ \frac{1}{6} \frac{1}{1-R} M_W^2 - \frac{2}{3} |Q_i| M_W^2 + \frac{1}{2} \left(1 - \frac{R}{1-R}\right) m_i^2 + \frac{3}{M_\chi^2} m_i^4 \right] \times \\
& \times \log \frac{m_i^2}{M_W^2} + \frac{1}{M_W^2} \text{Tr} \left[ -\frac{1}{12} \frac{R}{1-R} + \left(\frac{1}{3}|Q_i^2| - \frac{2}{3}Q_i^2\right) R + \frac{2}{3}Q_i^2 R^2 + \right.
\end{aligned}$$

$$\begin{aligned}
& + \frac{1}{12} \frac{R}{1-R} \frac{m_i^2}{M_Z^2} + \left( \frac{2}{3} |Q_i| - \frac{4}{3} Q_i^2 \right) R \frac{m_i^2}{M_Z^2} + \frac{4}{3} Q_i^2 R^2 \frac{m_i^2}{M_Z^2} \Big] L(-M_Z^2, m_i^2, m_i^2) - \\
& - \frac{1}{M_W^2} \text{Tr} \left[ \frac{m_i^2}{4M_\chi^2} + 2 \frac{m_i^4}{M_\chi^4} \right] L(-M_\chi^2, m_i^2, m_i^2) + \left( \frac{R}{1-R} - 1 \right) \times \\
& \times \sum_{ij}^{N_f/2} \left[ \frac{1}{3} \frac{m_i^2 m_j^2}{M_W^4} - \frac{1}{3} - \frac{m_i^2 + m_j^2}{2M_W^2} \right] \log \frac{m_i m_j}{M_W^2} + \frac{1}{12} \frac{(m_i^2 - m_j^2)^3}{M_W^6} \log \frac{m_i^2}{m_j^2} + \\
& + \left( \frac{1}{6M_W^2} - \frac{m_i^2 + m_j^2}{12M_W^4} - \frac{(m_i^2 - m_j^2)^2}{12M_W^6} \right) L(-M_W^2, m_i^2, m_j^2) \Big] K_{ij} K_{ij}^+ \Big\} - \\
& - \frac{g}{2M_W} \Gamma^{3\chi}(\text{tadpoles}). \tag{3.67}
\end{aligned}$$

I would also like to note that it is not useful to use the Stuart's computer algebra programm [21] since the preparation of the input data for the two-Higgs processes would consume more time than the calculations by hand.

## 4 Summary.

We calculated the Higgs-Higgs amplitude in the fourth order of perturbation theory (that is, with taking into account the one-loop corrections) in the Standard Model. The results do not coincide in full with the Durand *et al.* calculations in the Feynman gauge and within the different renormalization scheme [16].<sup>4</sup>

There exists a rather large number of different variants of the SM extensions. The most of these models are characterized by enlarging of the Higgs sector, namely by introduction of two and even more Higgs boson doublets [23]-[25]. The supersymmetric extension of the SM [26, 27] also requires introduction of at least two doublets of the scalar particles. The interest in these models has grown up in connection with the problem of suppression of the  $CP$  violation in strong interactions [28] and the problem of  $B^0 \bar{B}^0$  mixing [29] because they give the alternative theoretical solution to the problem of electroweak violation of the  $CP$  invariance [25, 30]. Therefore, in the approaching paper we are going to consider the Higgs-Higgs

---

<sup>4</sup>Recently, several authors proposed models which depended on the 4-potential, and, hence, on the gauge.

interaction problem in the framework of the extended variants of the SM. This is easily possible due to introduction of the parameters  $a_i, b_i$  for the fermionic interactions.

**Acknowledgements.** The author express his sincere gratitude to D. Yu. Bardin, R. N. Faustov, and Yu. N. Tyukhtyaev for valuable discussions. I appreciate very much the assistance of V. I. Kikot' in calculations, E. Saucedo for technical help, and I thank N. B. Skachkov for putting forward the problem.

## Appendix.

The integrals  $I_0, I_1$  and  $I_2$  are taken from the t'Hooft-Veltman paper [14]

$$\begin{aligned} I_0(q^2, M_1^2, M_2^2) &= \int_0^1 dx \log \frac{q^2 x(1-x) + M_1^2 x + M_2^2(1-x)}{M_W^2} = \\ &= -2 + \log \frac{M_1 M_2}{M_W^2} - \frac{1}{2} \frac{M_1^2 - M_2^2}{q^2} \log \frac{M_1^2}{M_2^2} + \frac{1}{2q^2} L(q^2, M_1^2, M_2^2) \end{aligned} \quad (4.68)$$

where

$$\begin{aligned} L(q^2, M_1^2, M_2^2) &= [(q^2 + M_1^2 + M_2^2) - \\ &- 4M_1^2 M_2^2] \int_0^1 \frac{dx}{q^2 x(1-x) + M_1^2 x + M_2^2(1-x)}, \end{aligned} \quad (4.69)$$

see Ref. [9a,p.440].

Next,

$$\begin{aligned} I_1(q^2, (p-q)^2, p^2, M_1^2, M_2^2, M_3^2) &= \int_0^1 dx \int_0^x dy [ax^2 + by^2 + cxy + \\ &+ dx + ey + f]^{-1}, \end{aligned} \quad (4.70)$$

with

$$\begin{aligned} a &= -(p-q)^2, & d &= M_2^2 - M_3^2 + (p-q)^2 \\ b &= -q^2, & e &= M_1^2 - M_2^2 + 2pq - q^2 \\ c &= -2(pq - q^2), & f &= M_3^2 - i\epsilon. \end{aligned}$$

And,

$$\begin{aligned}
I_2(q_1^2, q_2^2, p_2^2, p_1^2, s, t, M_1^2, M_2^2, M_3^2, M_4^2) &= \\
&= \int_0^1 dx \int_0^x dy \int_0^y dz [ax^2 + by^2 + gz^2 + cxy + hxz + jyz + \\
&+ dx + ey + kz + f]^{-2},
\end{aligned} \tag{4.71}$$

with

$$\begin{aligned}
a &= -p_2^2, & f &= M_4^2 - i\epsilon \\
b &= -q_2^2, & g &= -q_1^2 \\
c &= 2p_2q_2, & h &= 2p_2q_1 \\
d &= M_3^2 - M_4^2 + p_2^2, & j &= -2q_1q_2 \\
e &= M_2^2 - M_3^2 + q^2 - 2p_2q_2, & k &= M_1^2 - M_2^2 + q_1^2 + 2q_1q_2 - 2q_1p_2.
\end{aligned}$$

The traces of  $\gamma$ - matrices in an  $d$ -dimensional space are

$$Tr \gamma_\alpha = Tr \gamma_5 = Tr \gamma_\alpha \gamma_\beta \gamma_5 = 0, \tag{4.72}$$

$$Tr \gamma_\alpha \gamma_\beta = f(d) \delta_{\alpha\beta}, \tag{4.73}$$

$$Tr \gamma_\alpha \gamma_\beta \gamma_\rho \gamma_\sigma = f(d) d_{\alpha\beta\rho\sigma}, \tag{4.74}$$

$$Tr \gamma_\alpha \gamma_\beta \gamma_\rho \gamma_\sigma \gamma_5 = f(d) \epsilon_{\alpha\beta\rho\sigma}, \tag{4.75}$$

where

$$d_{\alpha\beta\rho\sigma} = \delta_{\alpha\beta} \delta_{\rho\sigma} - \delta_{\alpha\rho} \delta_{\beta\sigma} + \delta_{\alpha\sigma} \delta_{\beta\rho}. \tag{4.76}$$

In the present work we use  $f(d) = 2\omega = 4 - 2\epsilon$ ,  $d$  is the dimension of the space in the dimensional regularization.

## References

- [1] LHC Reports, CERN-LHC-2001-001 to 007, CERN-LHC-2002-001 to 024.
- [2] R. N. Cahn and M. Suzuki, *Phys. Lett.* **134B**(1-2), 115-119 (1984).
- [3] M. Anselmino *et al.*, *Phys. Lett.* **147B**(1-3), 207-211 (1984).
- [4] J.A. Grifols, *Phys. Lett.* **264B**(1-2), 149-153 (1991); J. A. Grifols and J. L. Diaz Cruz, UAB-FT-280-92, Dec. 1991.
- [5] G. Passarino, *Phys. Lett.* **156B**(3-4), 231-235 (1985); *ibid.* **161B**(4-6), 341-346 (1985).
- [6] M. Veltman, *Phys. Lett.* **139B**(4), 307-309 (1984).
- [7] R. Casalbuoni *et al.*, *Int. J. Mod. Phys.* **A4**(5), 1065-1110 (1989).



- [8] M. Veltman and F. Yndurain, *Nucl. Phys.* **B325**(1), 1-17 (1989).
- [9] D. Yu. Bardin, P. Ch. Christova and O. M. Fedorenko, *Nucl. Phys.* **B175**(3), 435-461 (1980); *ibid.* **B197**(1), 1-44 (1982).
- [10] A. Sirlin, *Phys. Rev. D* **22**(4), 971-981 (1980).
- [11] *Topical Conference on Radiative Corrections in  $SU(2) \times U(1)$* . Miramare-Trieste, Italy, June 6-8, 1983.
- [12] D. Yu. Bardin, *Precision Verifications of the Standard Theory. JINR Lectures for Young Scientists. No. 46* P2-88-189, Dubna:JINR, 1988, pp. 22-23 [in Russian].
- [13] V. V. Dvoeglazov, V. I. Kikot' and N. B. Skachkov JINR Communications E2-90-569, E2-90-570, Dubna:JINR, 1990; V.V.Dvoeglazov and N.B.Skachkov, JINR Communications E2-91-114,E2-91-115,E2-91-179, Dubna: JINR, 1991.
- [14] G. t' Hooft and M. Veltman, *Nucl. Phys.* **B153**(3-4), 365-401 (1979).
- [15] G. Passarino and M. Veltman, *Nucl. Phys.* **B160**(1), 151-207 (1979).
- [16] P.N. Maher, L.Durand and K.Riesselmann, *Phys. Rev. D* **48**(3), 1061-1083 (1993); *ibid.* , 1084-1096; L. Durand, J. M. Johnson and J. L. Lopez, *Phys. Rev. D* **45**(9), 3112-3127 (1992); L. Durand, J. M. Johnson and P. N. Maher, *Phys. Rev. D* **44**(1), 127-138 (1991); L. Durand, J. M. Johnson and J. L. Lopez, *Phys. Rev. Lett.* **64**(11), 1215-1218 (1990).
- [17] W. Marciano, G. Valencia and S. Willenbrock, *Phys. Rev. D* **40**(5), 1725R (1989); G. E. Vagenakis, *Europhysics Lett.* **12**, 89 (1990).
- [18] B. W. Lee, C. Quigg and M. B. Thacker, *Phys. Rev. Lett.* **38**(16), 883-885 (1977); *Phys. Rev. D* **16**(5), 1519-1531 (1977).
- [19] J. Cornwall, D. Levin and G. Ticktopoulos, *Phys. Rev. D* **10**(4), 1145-1167 (1974).
- [20] A. A. Logunov and A. N. Tavkhelidze, *Nuovo Cimento* **29**, 380-399 (1963); V. G. Kadyshevsky, *Nucl. Phys.* **B62**, 125-148 (1968).
- [21] R. Stuart, *Comp. Phys. Comm.* **48**, 367 (1988); R. Stuart and A. Gognora, *ibid.* **56**, 337 (1990).
- [22] G. t'Hooft, *Nucl. Phys.* **B331**, 173-199 (1971); *ibid.* **B35**(1), 167-188 (1971).
- [23] H. Georgi, *Hadronic J.* **1**(1), 155-168 (1978).
- [24] J. F. Donoghue and Ling-Fong Li, *Phys. Rev. D* **19**(3), 945-955 (1979).
- [25] G. C. Branco, A. J. Buras and J.-M. Gerard, *Nucl. Phys.* **B259**(2-3), 306-330 (1985).
- [26] H. E. Haber and G. L. Kane, *Phys. Repts.* **117**(2-4), 75-263 (1985).
- [27] J. F. Gunion and H. E. Haber, *Nucl. Phys.* **B272**(1), 1-76 (1986); *ibid.* **B278**(3), 449-492 (1986); *ibid.* **B307**(3), 445-475 (1988).
- [28] R. D. Peccei and H. R. Quinn, *Phys. Rev. Lett.* **38**(25), 1440-1443 (1977); *Phys. Rev. D* **16**(6), 1791-1797 (1977).
- [29] S. L. Glashow and E. E. Jenkins, *Phys. Lett.* **196B**(2), 233-236 (1987); S. Nandi, *Phys. Lett.* **202B**(3), 385-387 (1988).
- [30] T. D. Lee, *Phys. Rev. D* **8**(4), 1226-1239 (1973); S. Weinberg, *Phys. Rev. Lett.* **37**(11), 655-661 (1976).