

Particle Energy and Interaction: Explained and Derived by Energy Wave Equations

Jeff Yee

jeffsyee@gmail.com

April 30, 2017

Summary

Subatomic particle energies and their relationship to photon energies are presented in this paper with a new methodology to explain and calculate the transfer of energy between particles and photons. A new energy wave equation is proposed that governs particle mass, motion and interaction.

Ultimately, particles and photons are derived from a single energy wave equation, yet they have two distinct forms, consisting of four fundamental constants. The forms are longitudinal and transverse, and the four constants are wave speed, wavelength, amplitude and density. The energy equations are further derived based on wave differences – amplitude and wavelength – that are the cause of particle formation and interactions with other particles that create forces.

Particle energies are calculated without the complexity of the Standard Model; photon energies are calculated without the need for the Rydberg constant and can support calculations well beyond hydrogen's photon energy levels. Furthermore, there is a link between particle and photon energies that can be described mathematically and explained logically to illustrate the transfer of energy from one to another.

The proposed equations in this paper have successfully:

- Calculated rest energies and masses of subatomic particles from the neutrino to Higgs boson
- Calculated photon ionization energies of the first twenty elements from hydrogen to calcium
- Established a methodology for calculating orbital radii of atomic elements

The equations are derived with an explanation of why they work, describing the reason for mass, the quantum jumps of the electron in an atomic orbit and what happens to particles in antimatter collision. Interestingly, similarities were found between particle formation and atomic element formation.

These findings conclude that particles are made from fundamental building blocks of matter that reflect wave energy. This building block, possibly the neutrino, forms the basis of particle creation similar to how protons assembled in a nucleus give rise to different atomic elements.

Summary	1
1. Energy Wave.....	4
Particle Energy	4
Photon Energy	5
1.1. Energy Wave Equation Constants	6
Notation	6
Constants and Variables.....	7
1.2. Energy Wave Equations.....	9
Energy Wave Theory Assumptions.....	9
2. Calculations and Results	11
2.1. Particle Energy	11
2.2. Photon Energy	13
2.3. Photon Wavelength	17
2.4. Annihilation Energy & Wavelength.....	19
3. Deriving and Explaining the Energy Wave Equations.....	21
3.1. Particle Rest Energy - Longitudinal Energy Equation.....	23
Particle Formation Assumptions.....	23
3.2. Photon Energy – Transverse Wavelength Equation	27
Transverse Wave Assumptions	27
3.3. Photon Energy - Transverse Energy Equation.....	30
3.4. Transfer of Wave Energy (Longitudinal <-> Transverse).....	34
3.5. Photon Energy of Any Atom	38
3.6. Amplitude Factor Equation - 1s Orbital Ionization (H to Ca).....	46
4. Methodology for Determining Energy Wave Equation Constants.....	49
4.1. Longitudinal Wavelength Constant.....	49

4.2. Longitudinal Amplitude Constant.....	49
4.3. Density Constant.....	50
5. Conclusion.....	51
Acknowledgements.....	52

1. Energy Wave

This paper introduces longitudinal and transverse energy wave equations that can be used to calculate particle energy, mass and properties of the electromagnetic wave including photon energies and wavelengths. These equations derive from a simple energy wave equation that consists of density, wave speed, wavelength and amplitude, which form matter and govern how particles interact and exchange energy.

This section provides a brief introduction of particle and photon energies calculated in this paper, along with the equations and constants used in the calculations. Section 2 provides detailed calculations and results. Section 3 includes the derivations of the equations and their explanations. Finally, Section 4 derives the values of the constants used in this paper.

Particle Energy

Rest energy of subatomic particles are calculated using an equation that models longitudinal, standing wave energy, shown later in Eq. 1.1. It was assumed that particles consist of a fundamental particle as the building block; similar to the way atomic elements are constructed from an arrangement of nucleons. Whereas atomic elements are formed from protons (Z) as the building block, particles were assumed to consist of a combination of wave centers (K) as their building block. Wave centers are a special type of particle – closely resembling the properties of the neutrino – that reflect longitudinal waves to become a standing wave.

Particles were arranged by wave centers and given a name *particle number*, similar to atomic number for atomic elements. Atomic elements in the Periodic Table of Elements range from 1 (hydrogen) to 118 (ununoctium) and arranging these elements by atomic mass yields a linear solution when graphed against atomic number.

Arranging subatomic particles by their rest mass does not yield a linear solution like atomic elements, which is why a fundamental particle has not been established as the building block for all of the known particles. However, when considering a fundamental building block to the fourth power (K^4), which will be explained later in Section 3, particle energy can be linearized similar to atomic elements.

Fig 1.1 linearizes particle energies by the newly-introduced particle number (K). The particle's known rest energy (measured in eV – electronvolts) is divided by the fourth power (K^4) and a summation equation introduced later in Section 2.^{1,2} After plotting the particle energies from the lightest particle (neutrino) to the heavy Higgs boson, it is found that:

- Particle energies are nearly linear after dividing by the fourth power of the particle number, similar to atomic elements.
- The particle number ranges from 1 to 117, similar to atomic numbers ranging from 1 to 118.
- The lepton particles (neutrinos and electrons) fall at magic numbers shared with atomic elements 2, 8, 20, 28 and 50. Only the number 2 is a magic number that is not mapped to a currently known particle.

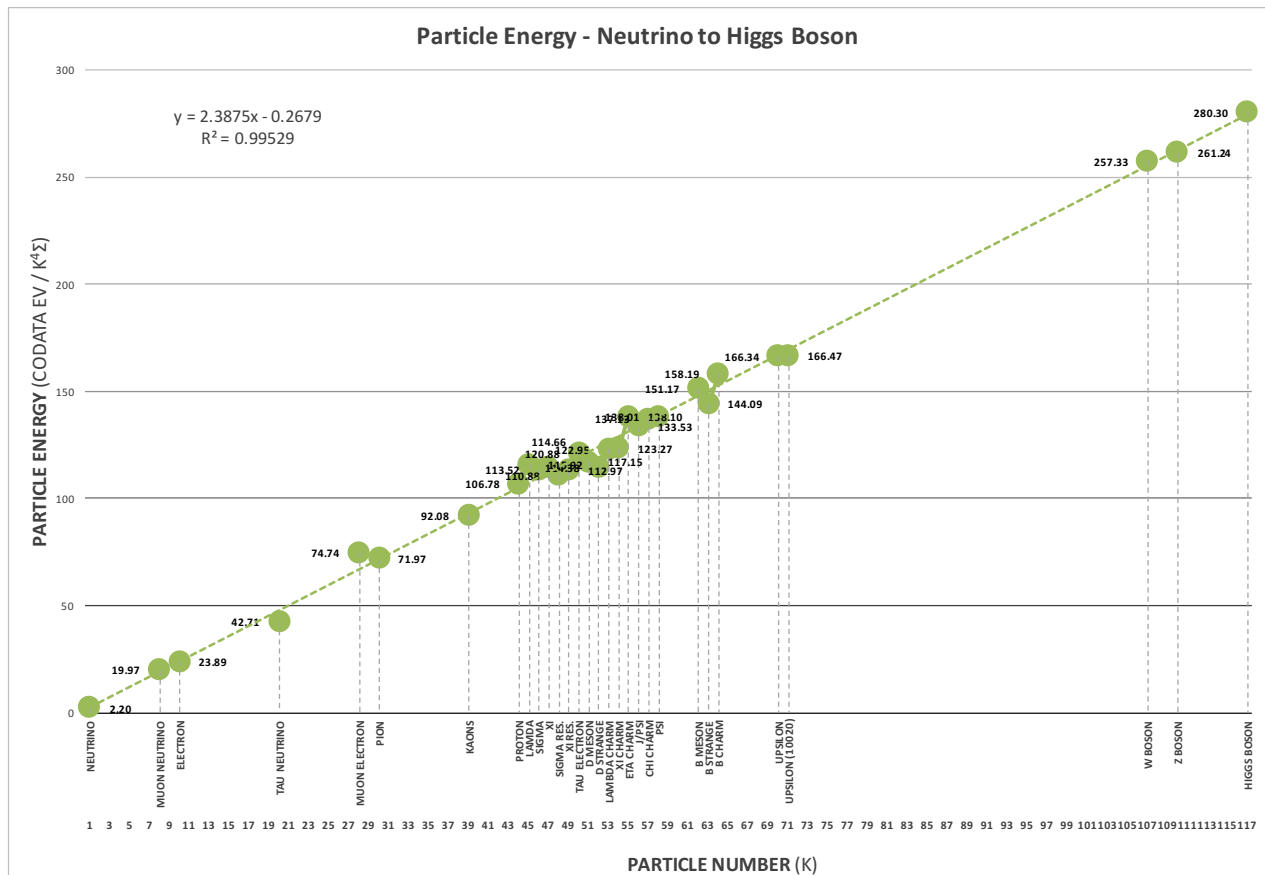

Fig 1.1 – Particle energy linearized as a function of particle number (K) to the fourth power.^{1,2}

In addition to comparisons between particles and atomic elements, the equation for longitudinal wave energy that is used to calculate the rest energy of particles, is extended to:

- Calculate the spherical, longitudinal energy within an atom that will eventually be converted to the transverse energy of photons. This energy is found to exactly match photon energy, described in detail in Section 3.4.
- Derive the Force Equation in the *Forces* paper, in which the particle force calculations for both electromagnetism and gravity have no difference compared to measured values (0.000%).³

This gives confidence that the equation to calculate particle energies and predict future particles is based on longitudinal wave energy. The Longitudinal Energy Equation is introduced to calculate particle energy later in this section.

Photon Energy

Beyond its standing wave structure, a particle still has longitudinal wave energy but it transitions from standing waves to longitudinal traveling waves. This longitudinal wave energy decreases with the square of the distance from the particle.

A vibrating particle will create a transverse wave perpendicular to the direction of vibration, creating photons. The energy of two photons – each traveling in opposite directions from the particle – is calculated in this paper to be exactly equal to the longitudinal wave energy between two particles. The vibrating particle (e.g. electron) is affected by other particles in its vicinity (e.g. protons) and the wave amplitude difference causes its motion.

Since photon energy is a transfer of longitudinal wave energy, a photon's energy can be calculated by knowing:

- The distance between the vibrating particle and the particle responsible for its vibration. For an electron in an atomic orbital, this is the radius (r) from the atom's nucleus.
- The wave amplitude difference between the vibrating particle and surrounding particles. A new variable has been assigned as a measurement of this constructive or destructive wave interference called the amplitude factor.

Photon energies were calculated using an energy equation for transverse waves with two variables: distance and wave amplitude factor. This methodology can be used for photons created by or absorbed by any atom. It can also be used for photon energies in the annihilation process of particles such as the combination of an electron and positron. In Fig. 1.2, the photon energies of the 1s electron (first orbital) are calculated for the first twenty elements from hydrogen to calcium, matching results from photoelectron spectroscopy experiments. Additional calculations and comparisons against other atomic arrangements are provided in Sections 2 and 3.

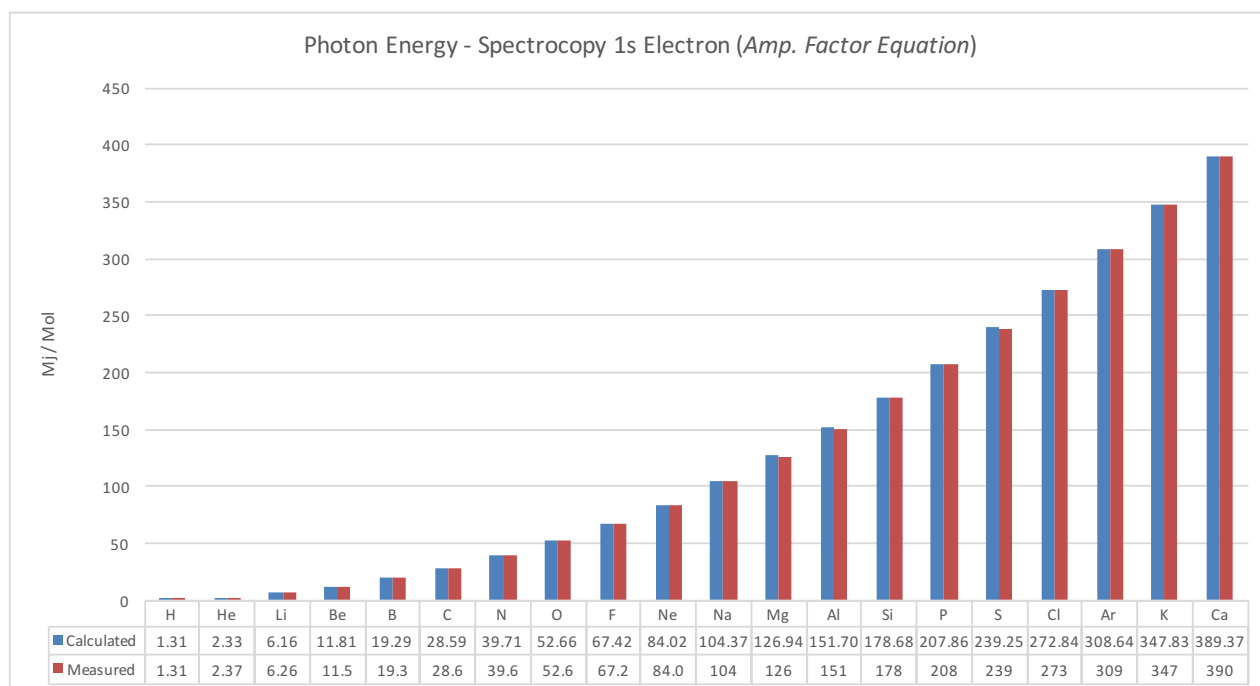

Fig. 1.2 – Photon energy absorbed for ionization of the 1s electron. Calculated results use the Amplitude Factor Equation - 1s Orbital Ionization and are compared with measured results from photoelectron spectroscopy results.⁴

The Transverse Energy Equation is introduced to calculate photon energies later in this section.

1.1. Energy Wave Equation Constants

Before the energy wave equations are introduced, the notation, constants and variables that are used in the equations are provided.

Notation

Notation	Meaning
K_e	e – electron (wave center count)
$\lambda_l \lambda_t$	l – longitudinal wave, t – transverse wave
$\Delta_e \Delta_{Ge} \Delta_T$	e – electron (orbital g-factor), Ge – gravity electron (spin g-factor), T – total (angular momentum g-factor)
F_g, F_m	g - gravitational force, m – magnetic force
$E_{(K)}$	Energy at particle with wave center count (K)

Table 1.1.1 – Energy Wave Equation Notation

Constants and Variables

The following are the wave constants and variables used in the energy wave equations, including a constant for the electron that is commonly used in this paper.

Symbol	Definition	Value (units)
Wave Constants		
A_l	Amplitude (longitudinal)	$3.662796647 \times 10^{-10}$ (m)
λ_l	Wavelength (longitudinal)	$2.817940327 \times 10^{-17}$ (m)
ρ	Density (aether)	$9.422369691 \times 10^{-30}$ (kg/m ³)
c	Wave velocity (speed of light)	299,792,458 (m/s)
Variables		
δ	Amplitude factor	variable - (m ³)
K	Particle wave center count	variable - <i>dimensionless</i>
n	Wavelength count	variable - <i>dimensionless</i>
Q	Particle count (in a group)	variable - <i>dimensionless</i>
Electron Constants		
K_e	Particle wave center count - electron	10 - <i>dimensionless</i>
Derived Constants*		
O_e	Shell energy multiplier – electron	2.138743820 – <i>dimensionless</i>
Δ_e / δ_e	Orbital g-factor /amp. factor electron	0.993630199 – <i>dimensionless</i> / (m ³)

Δ_{Ge}/δ_{Ge}	Spin g-factor/amp. gravity electron	0.982746784 – <i>dimensionless</i> / (m ³)
Δ_T	Total angular momentum g-factor	0.976461436 – <i>dimensionless</i>
α_e	Fine structure constant	0.007297353 – <i>dimensionless</i>
α_{Ge}	Gravity coupling constant - electron	2.400531449 x 10 ⁻⁴³ - <i>dimensionless</i>

Table 1.1.2 – Energy Wave Equation Constants and Variables

The derivations for the constants are:

The shell energy multiplier for the electron is a constant for readability, removing the summation from energy and force equations since it is constant for the electron. It is the addition of spherical wave amplitude for each wavelength shell (n).

$$O_e = \sum_{n=1}^{K_e} \frac{n^3 - (n-1)^3}{n^4} \quad (1.1.1)$$

The three modifiers (Δ) are similar to the g-factors in physics. The value of Δ_{Ge} was adjusted slightly by 0.0000606 to match experimental data. Since Δ_T is derived from Δ_{Ge} it also required an adjustment, although slightly smaller at 0.0000581. This could be a result of the value of one or more input variables (such as the fine structure constant, electron radius or Planck constant) being incorrect at the fifth digit. The fine structure constant (α_e) is used in the derivation in Eq. 1.1.2 as the correction factor is set against a well-known value.

$$\Delta_e = \delta_e = \frac{3\pi\lambda_l K_e^4}{A_l \alpha_e} \quad (1.1.2)$$

$$\Delta_{Ge} = \delta_{Ge} = 2A_l^3 K_e^{28} \quad (1.1.3)$$

$$\Delta_T = \Delta_e \Delta_{Ge} \quad (1.1.4)$$

The electromagnetic coupling constant, better known as the fine structure constant (α), can also be derived. In this paper, it is also used with a sub-notation “e” for the electron (α_e).

$$\alpha_e = \frac{\pi K_e^4 A_l^6 O_e}{\lambda_l^3 \delta_e} \quad (1.1.5)$$

The gravitational coupling constant for the electron can also be derived. α_{Ge} is baselined to the electromagnetic force

at the value of one, whereas some uses of this constant baseline it to the strong force with a value of one ($\alpha_G = 1.7 \times 10^{-45}$). The derivation matches known calculations as $\alpha_{Ge} = \alpha_G / \alpha_e = 2.40 \times 10^{-43}$.

$$\alpha_{Ge} = \frac{K_e^8 \lambda_l^7 \delta_e}{\pi A_l^7 O_e \delta_{Ge}} \quad (1.1.6)$$

1.2. Energy Wave Equations

For the purpose of understanding the energy wave equations in this section, it is accepted that there is a medium for the transmission of wave energy in the universe and that it consists of only two things: 1) a sub-particle that transfers wave energy in the direction of wave travel (hereafter called an aether granule), and 2) a sub-particle that reflects wave energy in the opposite direction of wave travel (hereafter called a wave center). Particles are created from wave centers in formation that consist of longitudinal in-waves and out-waves that form standing waves. Finally, particle motion, particularly a vibration, creates a transverse wave. The following assumptions are the foundation of the Energy Wave Equations.

Energy Wave Theory Assumptions

1. Energy waves travel throughout the aether at a defined wave speed and wavelength as wavelets to form a wavefront according to Huygen's principle.⁵ Amplitude is reduced at the square of distance from the source and experiences constructive and destructive wave interference.
2. Aether granules transfer energy to the next granule in the direction of wave travel. It may have a memory to understand its state, which holds a defined amount of energy.
3. Aether wave centers reflect energy in the opposite direction of wave travel, creating standing waves for a given distance as a combination of in-waves and reflected out-waves.
4. Aether wave centers may assemble in formation to create particles with various energy levels via constructive and destructive wave interference.
5. Aether wave centers move to minimize amplitude on the wave, thereby preferring the node position of the wave.
6. Wave energy is proportional to amplitude, wavelength, wave speed and density of a defined volume.

Energy Wave Equations

$$E_{l(K)} = \frac{4\pi\rho K^5 A_l^6 c^2}{3\lambda_l^3} \sum_{n=1}^K \frac{n^3 - (n-1)^3}{n^4} \quad (1.2.1)$$

Longitudinal Energy Equation

$$E_t = \frac{2\pi\rho K_e^7 \lambda_l^2 c^2 \delta}{A_l} \left(\frac{1}{r} - \frac{1}{r_0} \right) \quad (1.2.2)$$

Transverse Energy Equation

$$\lambda_t = \frac{4A_l}{3K_e^3} \frac{1}{\left(\frac{1}{n} - \frac{1}{n_0} \right)} (\Delta_e) \quad (1.2.3)$$

Transverse Wavelength Equation

$$\delta = \left((Z) - \frac{4}{3} \left(\frac{e_1 - 1}{2} + \frac{e_2}{8} + \frac{1}{2} \left(\frac{e_3}{8} \right) + \frac{1}{3} \left(\frac{e_4}{8} \right) \right) \right)^2 \quad (1.2.4)$$

Amplitude Factor Equation – 1s Orbital Ionization

The Amplitude Factor Equation - 1s Orbital Ionization (Eq. 1.2.4) works for the ionization energy up to the first twenty elements, calcium ($Z=20$), of the first orbital. Z is the number of protons, and e_1 , e_2 , e_3 , and e_4 are the number of electrons in the first orbital (1s), second (2s, 2p orbitals), third (3s, 3p orbitals) and fourth (4s, 4p orbitals) respectively. Note the sequence 2, 8, 8, 8 in the denominators that match the orbital subshells.

Energy calculations are in joules (J) and wavelength in meters (m) unless otherwise specified.

2. Calculations and Results

This section details the steps to reproduce the calculations using the energy wave equations. Explanations of the energy wave equations are reserved for Section 3.

2.1. Particle Energy

The Longitudinal Energy Equation (Eq. 1.2.1) was used to calculate the rest energy of many particles. Each particle is assumed to consist of wave centers, which is given the variable K to describe the unique wave center count for each type of particle.

Neutrino

For example, a particle with one wave center count (K=1) closely resembles the neutrino particle. Note that the neutrino has a difficult mass to measure and is estimated with a range that is 2.2 eV at its highest according to the Standard Model.⁶ The calculated value, shown below, is just slightly larger at 2.4 eV (3.8280×10^{-19} joules).

$$E_{l(1)} = \frac{4\pi\rho K^5 A_l^6 c^2}{3\lambda_l^3} \sum_{n=1}^K \frac{n^3 - (n-1)^3}{n^4} \quad (2.1.1)$$

Calculated Value: 3.8280×10^{-19} joules ($\text{kg m}^2/\text{s}^2$)

Electron

The electron was calculated at a wave center count at K=10. As this value of K appears in many equations related to the electron, it is given a special electron constant, K_e . At $K_e = 10$, a value of 8.1871×10^{-14} joules is calculated, which is no difference (0.000%) to that level of digits from the CODATA value of the electron in joules.

$$E_e = E_{l(10)} = \frac{4\pi\rho K_e^5 A_l^6 c^2}{3\lambda_l^3} \sum_{n=1}^{K_e} \frac{n^3 - (n-1)^3}{n^4} \quad (2.1.2)$$

Calculated Value: 8.1871×10^{-14} joules ($\text{kg m}^2/\text{s}^2$)

Particle rest energies were calculated using values K=1 to K=118 to represent the wave center count within the core of a particle. Then, known particles were mapped to the closest value of K based on their CODATA energy level and the calculated energy level of K. An example is shown in Table 2.1.1 for the lepton family of particles and the Higgs boson.

Wave Centers (K)	1	8	10	20	28	50	117
Particle Name	Neutrino	Muon Neutrino	Electron	Tau Neutrino	Muon Electron	Tau Electron	Higgs Boson
Rest Energy (Calculated) - Joules	3.83E-19	2.61E-14	8.19E-14	2.78E-12	1.52E-11	2.81E-10	2.00E-08
Rest Energy (CODATA) - Joules	3.52E-19	2.72E-14	8.19E-14	2.48E-12	1.70E-11	2.85E-10	2.01E-08

Table 2.1.1 Calculated Particle Rest Energy using Longitudinal Energy Equation – Leptons and Higgs Boson and compared to particle CODATA energy values.

Linear Solution to Particle Energy

In Fig. 1.1, particle energies were plotted in a linear solution from the neutrino to the Higgs boson, to demonstrate that particles have features similar to the construction of atomic elements. This is achieved by dividing a particle's rest energy by a denominator shown in Eq. 2.1.3.

$$K^4 \sum_{n=1}^K \frac{n^3 - (n-1)^3}{n^4} \quad (2.1.3)$$

The Longitudinal Energy Equation (Eq. 1.2.1) which describes particle energy is raised to the fifth power of the particle number (K^5). The explanation and derivation is upcoming in Section 3. In Eq. 2.1.4, a modified energy value for the purpose of plotting contains the Longitudinal Energy Equation in the numerator and Eq. 2.1.3 in the denominator. After simplification to become Eq. 2.1.5, the solution is now linear as a function of K (with the exception of K in the equation all of the remaining components are constant).

$$E' = \frac{\frac{4\pi\rho K^5 A_l^6 c^2}{3\lambda_l^3} \sum_{n=1}^K \frac{n^3 - (n-1)^3}{n^4}}{K^4 \sum_{n=1}^K \frac{n^3 - (n-1)^3}{n^4}} \quad (2.1.4)$$

$$E' = \frac{4\pi\rho A_l^6 c^2}{3\lambda_l^3} (K) \quad (2.1.5)$$

Note: Results are in joules. The energy values plotted in Fig. 1.1 and Fig 2.1.1 are in eV. The conversion is 6.2415×10^{18} electronvolts (eV) per joule. For example, using Eq. 2.1.5, the electron is calculated to be $3.828 \times 10^{-18} * 6.2415 \times 10^{18} = 23.89$. This is the electron value that is used in Fig. 1.1.

Plotting Particle Energy (Modified by Eq. 2.1.3) vs Particle Number

The known CODATA rest energy values of particles (in eV) were divided by Eq. 2.1.3 and plotted with the modified particle energy value and the particle number (K). Some particles had overlapping particle numbers (particularly

around particle numbers 44 to 60 where there is a cluster that is found from proton collision experiments). When this occurred, the neutral value of the closest particle was used (e.g. neutral kaon vs charged kaon).

This was displayed earlier in Fig. 1.1 for particles ranging from the lowest-known energy value (neutrino) to the largest known value (Higgs boson). Now, it is plotted again in Fig 2.1.1 with greater detail for the first 50 particles, from the neutrino to tau electron.

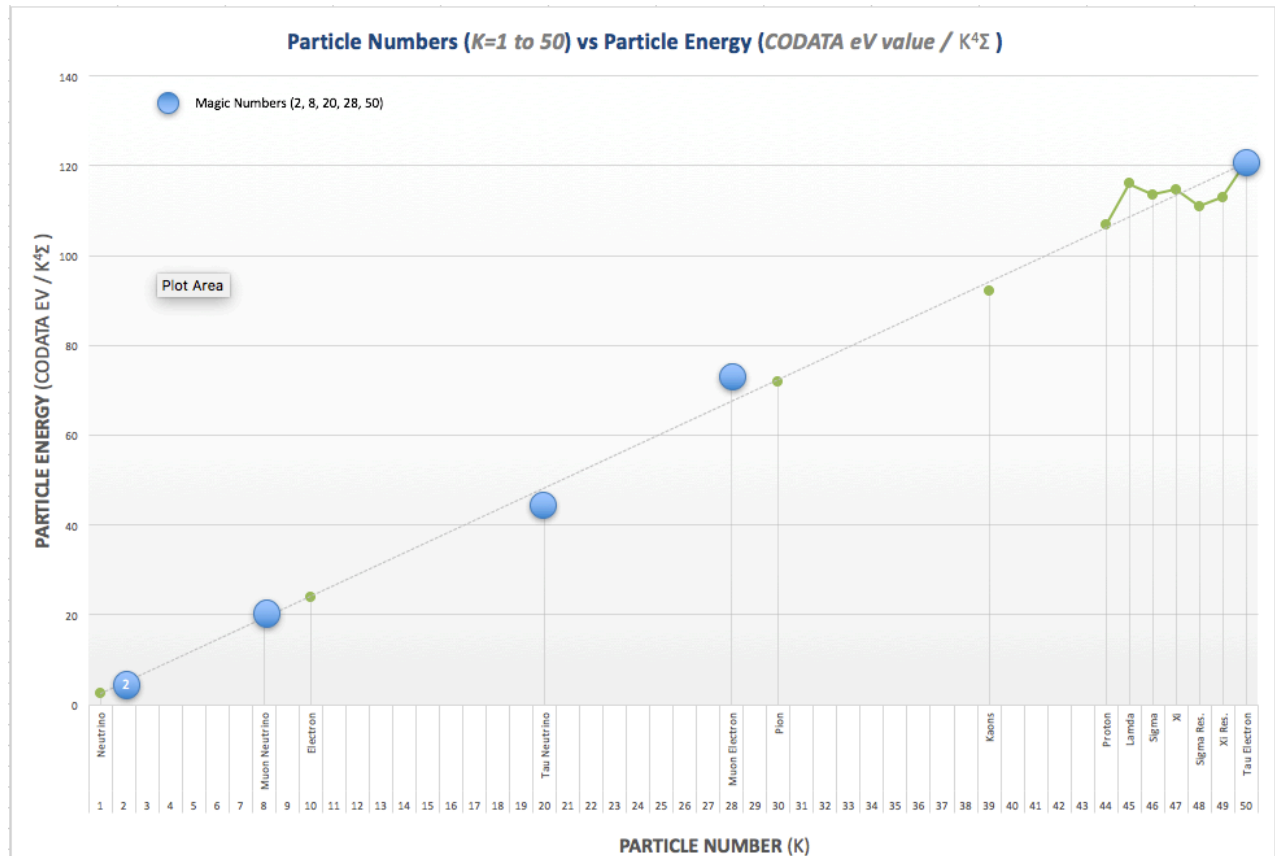

Fig. 2.1.1 Plotting particle energy (modified by Eq. 2.1.3) vs particle number (K). Leptons appear at magic numbers that are also seen in atomic elements: 2, 8, 20, 28, 50.

With the exception of the proton, which is known to be a composite particle consisting of smaller particles (thought to be quarks), the leptons are particles that appear in nature, even if they rapidly oscillate or decay into other particles. They appear at magic numbers 8 (muon neutrino), 20 (tau neutrino), 28 (muon electron) and 50 (tau electron). The first five magic numbers for atomic elements, which represents greater stability relative to other elements is: 2, 8, 20, 28 and 50. In this sequence, only particle number 2 (K=2), is an undiscovered particle which could be a lepton.

2.2. Photon Energy

In Fig 1.2, the photon energy required to ionize the 1s electron was calculated and compared against photoelectron spectroscopy results. This section details the calculations and displays the results of further atomic configurations of electrons being ionized from the first orbital.

Calculations are performed using the Transverse Energy Equation (Eq. 1.2.2) and require knowing the amplitude factor (δ) and the radius (r) to the electron being ionized. Hydrogen is the simplest atomic element with an amplitude factor of one ($\delta=1$) due to one proton and one electron, and the first orbital is a known radius known as the Bohr

radius. Other configurations of atoms and the methodology to calculate amplitude factors and radii is described in Section 3.

Hydrogen – 1s

The Transverse Energy Equation (Eq. 1.2.2) is shown below in Eq. 2.2.1 with an initial radius of the first orbital – known as the Bohr radius (a_0) and a final radius that is infinity (∞) as the electron is ionized and is no longer in the atom. Substituting an amplitude factor of one ($\delta=1$) for hydrogen and the Bohr radius ($a_0=5.2918 \times 10^{-11}$ m), the Rydberg unit of energy constant is found: 2.1799×10^{-18} joules. A negative sign in the final calculated value indicates a photon is absorbed by the atom; a positive sign would have indicated a photon was created. Note that the Bohr radius is another constant that can be derived from wave constants and is also calculated with 19 other physics constants in *Fundamental Physical Constants*.⁷

$$E_t = \frac{2\pi\rho K_e^7 \lambda_l^2 c^2 \delta}{A_l} \left(\frac{1}{\infty} - \frac{1}{a_0} \right) \quad (2.2.1)$$

Calculated Value: -2.1799×10^{-18} joules ($\text{kg m}^2/\text{s}^2$)

The calculated values are compared to ionization energies that are measured in megajoules per mole (MJ / mol) so each of the calculations for photon energies in joules were converted using Avogadro's number for units per mole (6.02214×10^{23}) and 1×10^6 to convert from joules to megajoules. The same calculation for hydrogen in Eq. 2.2.1, is now expressed in MJ / mol in Eq. 2.2.2.

$$E_t = \frac{2\pi\rho K_e^7 \lambda_l^2 c^2 \delta}{A_l} \left(\frac{1}{\infty} - \frac{1}{a_0} \right) \left(\frac{6.02214 \times 10^{23}}{1 \times 10^6} \right) \quad (2.2.2)$$

Calculated Value: -1.31 MJ / mol

Hydrogen to Calcium Photon Energies – 1s

A pattern emerged for ionization energies of electrons in the first orbital (1s), extending from hydrogen ($Z=1$) to calcium ($Z=20$). Instead of requiring two variables to calculate photon energy, for these configurations of atoms, it simplified to only one variable. Thus, a modified version of amplitude factor was created without needing radius and termed the Amplitude Factor Equation – 1s Orbital Ionization (Eq. 1.2.4).

Helium (He), for example, has two protons ($Z=2$) and two electrons in the first orbital ($e_1=2$). Using Eq. 1.2.4, these values can be inserted to determine the constructive/destructive wave interference.

$$\delta_{He} = \left((2) - \frac{4}{3} \left(\frac{2-1}{2} + \frac{0}{8} + \frac{1}{2} \left(\frac{0}{8} \right) + \frac{1}{3} \left(\frac{0}{8} \right) \right) \right)^2 \quad (2.2.3)$$

Calculated Value: 1.7778

Solving the equation, the modified amplitude factor for helium is 1.7778 ($\delta_{He}=1.7778$). The term *modified* amplitude factor is being used here because radius is not being solved when using the Amplitude Factor Equation – 1s Orbital Ionization.

When using the modified amplitude factor, the radius is the Bohr radius (a_0). This is not the actual radius of 1s electrons beyond hydrogen, but it may be used when estimating photon energies with the Amplitude Factor Equation – 1s Orbital Ionization. *The calculation of helium's true radius is covered in Section 3.5.*

Using the Transverse Energy Equation (Eq. 1.2.2) and converting to MJ / mol using Avogadro's number, the following values are substituted: a_0 is the Bohr radius (5.2918×10^{-11} m) and the modified amplitude factor δ_{He} is 1.7778 from Eq. 2.2.3.

$$E_t = \frac{2\pi\rho K_e^7 \lambda_l^2 c^2 \delta_{He}}{A_l} \left(\frac{1}{\infty} - \frac{1}{a_0} \right) \left(\frac{6.02214 \times 10^{23}}{1 \times 10^6} \right) \quad (2.2.4)$$

Calculated Value: -2.33 MJ / mol

These same steps were taken for elements from hydrogen to calcium and the positive values were charted against measured ionization energies in Fig. 1.2.

Ionized Hydrogen to Calcium Photon Energies – 1s

The same process using the Transverse Energy Equation and Amplitude Factor Equation (Eqs. 1.1.2 and 1.1.4 respectively) can be used for ionized elements that contain one or two electrons in the first orbital (1s).

$$\delta_{Ne^{8+}} = \left(10 - \frac{4}{3} \left(\frac{2-1}{2} + \frac{0}{8} + \frac{1}{2} \left(\frac{0}{8} \right) + \frac{1}{3} \left(\frac{0}{8} \right) \right) \right)^2 \quad (2.2.5)$$

Calculated Value: 87.111

Using the Transverse Energy Equation (Eq. 1.2.2) and converting to MJ / mol using Avogadro's number, the following values are substituted: a_0 is the Bohr radius (5.2918×10^{-11} m) and the modified amplitude factor $\delta_{Ne^{8+}}$ is 87.111 from Eq. 2.2.5.

$$E_t = \frac{2\pi\rho K_e^7 \lambda_l^2 c^2 \delta_{Ne^{+8+}}}{A_l} \left(\frac{1}{\infty} - \frac{1}{a_0} \right) \left(\frac{6.02214 \times 10^{23}}{1 \times 10^6} \right) \quad (2.2.6)$$

Calculated Value: -114.36 MJ / mol

The values for heavily ionized elements with only one electron in the first orbital ($1s^1$) that is ionized were calculated using the steps above and charted in Fig. 2.2.1 for the first twenty elements.

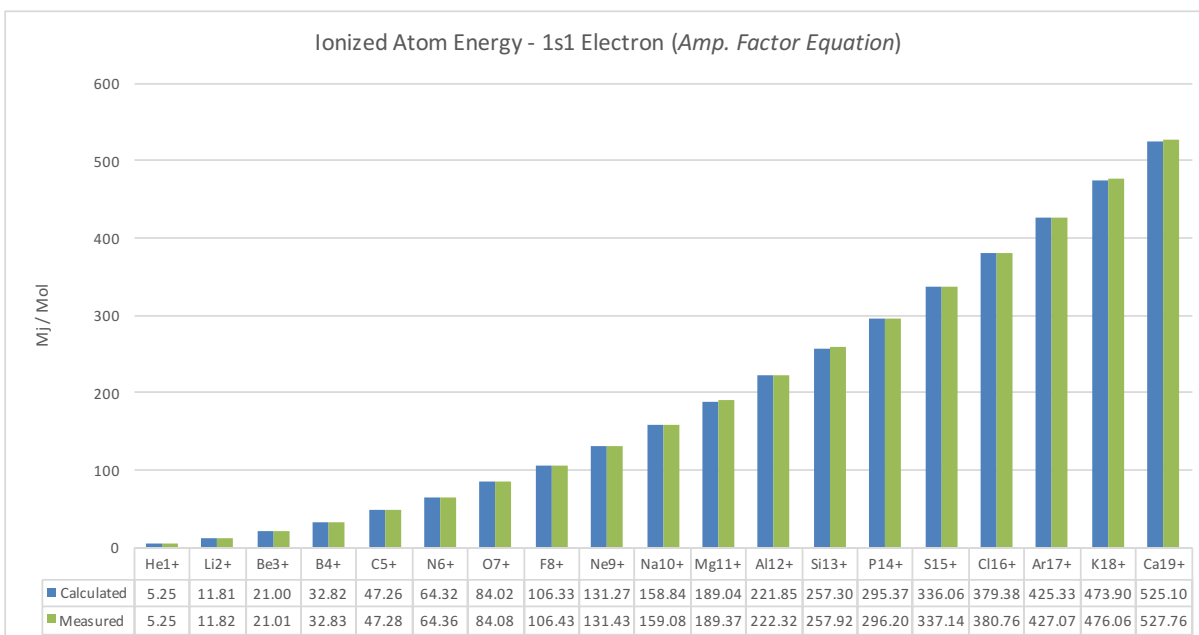

Fig. 2.2.1 Photon energy absorbed for ionization of the $1s^1$ electron of an ionized element. Calculated results use the Amplitude Factor Equation - $1s$ Orbital Ionization and are compared with measured results.⁸

Similar steps were taken for ionized elements containing two electrons in the first orbital ($1s^2$) and charted in Fig 2.2.2.

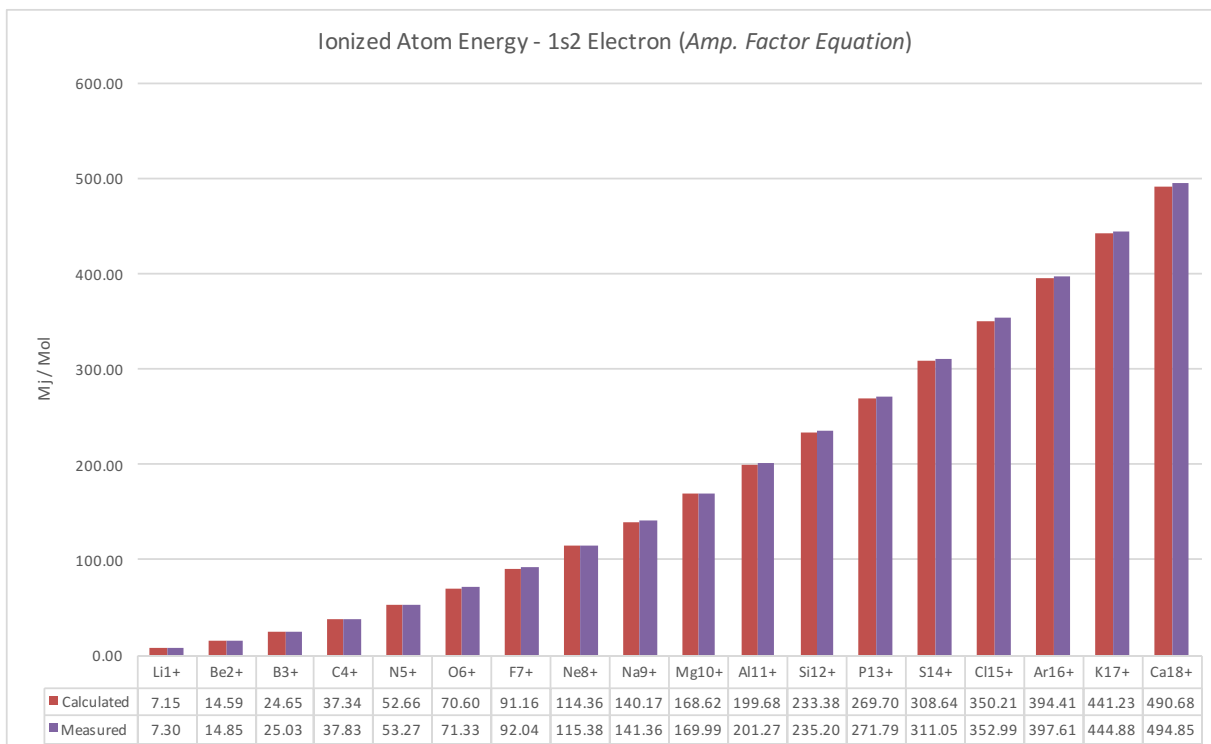

Fig. 2.2.2 Fig. 2.2.1 Photon energy absorbed for ionization of the 1s² electron of an ionized element. Calculated results use the Amplitude Factor Equation - 1s Orbital Ionization and are compared with measured results.⁸

Photon Energies – Any orbital & atomic configuration

The example calculations above demonstrate an amplitude factor equation that was created for the first orbital without the need to calculate the radius to the affected electron being ionized. It was developed because a pattern emerged for the first orbital.

The remaining orbitals, and remaining atomic elements beyond calcium, can be calculated knowing the radius to the ionized electron and the constructive/destructive wave interference affecting the particle, captured in the amplitude factor variable. This methodology and further examples are provided in Section 3.5.

2.3. Photon Wavelength

To find photon wavelengths, the Transverse Wavelength Equation is used (Eq. 1.2.3). In this equation, the number of electron wavelengths (n) is used as the measure of distance from the nucleus to the ionized electron. It is based on the orbital number (numerator) and the fine structure constant squared (denominator).

$$n_{1s} = K_e \frac{(1)^2}{\alpha_e^2} \quad (2.3.1)$$

Calculated Value: 187,789 electron wavelengths

Ionization

Eq. 2.3.1 is substituted into the Transverse Wavelength Equation (Eq. 1.2.3) shown below:

$$\lambda_t = \frac{4A_l}{3K_e^3} \frac{1}{\left(\frac{1}{\infty} - \frac{1}{n_{1s}}\right)} (\Delta_e) \quad (2.3.2)$$

Calculated Value: -9.1127×10^{-8} m

These steps were reproduced for hydrogen for the ground state (1s) to excited states (orbitals 2s to 6s) and charted against measured results in Fig. 2.3.1.

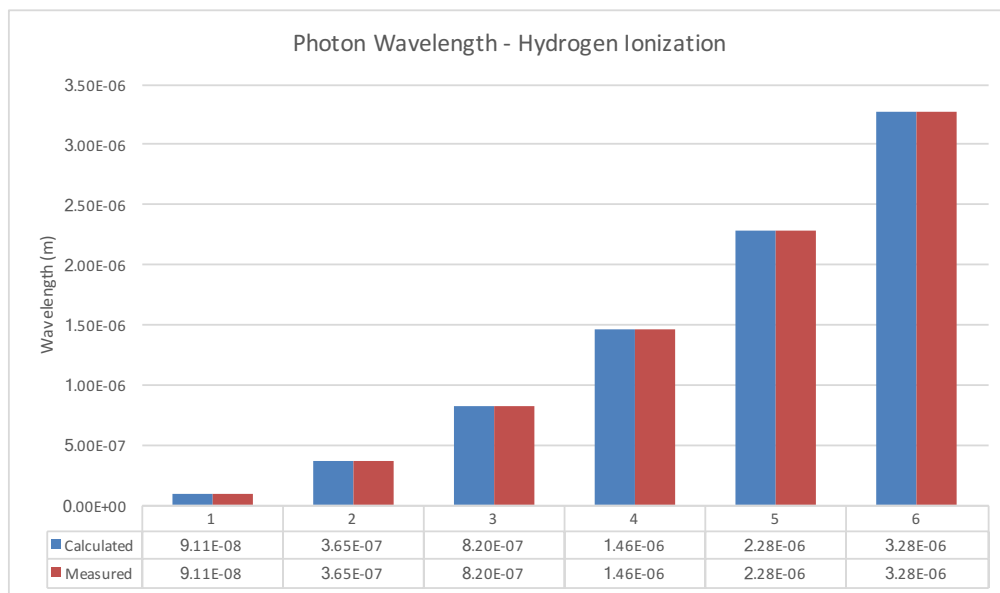

Fig. 2.3.1 Hydrogen photon wavelengths – ionization⁹

Orbital Transition

The same equation and steps can be used to calculate the photon that is emitted by an atom when an electron transitions to a lower energy state. For example, the following uses the Transverse Wavelength Equation (Eq. 1.2.3), substituting the value for electron wavelength count (Eq. 2.3.1) for the third and second orbitals.

3->2 (*electron transition from 3s to 2s for hydrogen*)

$$\lambda_t = \frac{4A_l}{3K_e^3} \frac{1}{\left(\frac{1}{K_e \frac{(2)^2}{\alpha_e^2}} - \frac{1}{K_e \frac{(3)^2}{\alpha_e^2}} \right)} (\Delta_e) \quad (2.3.3)$$

Calculated Value: $6.5611 \times 10^{-7} \text{ m}$

These steps were repeated for the transition of an electron in hydrogen from various orbitals to the second orbital (2s). The naming has convention of initial orbital -> final orbital (e.g. 3->2). The calculated wavelengths are charted in Fig. 2.3.2 and compared against measured results.

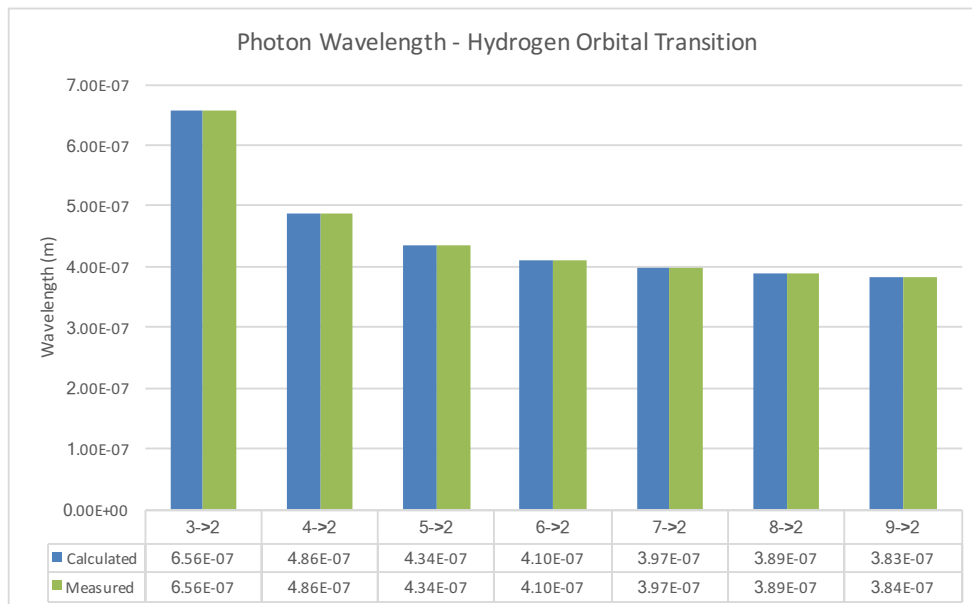

Fig. 2.3.2 Hydrogen photon wavelengths – transition between orbitals (initial->final).¹⁰

2.4. Annihilation Energy & Wavelength

A similar process can be used to determine photon energies and wavelengths during particle annihilation. Rather than eject a particle in ionization, the particle (e.g. electron) is attracted to the point where it settles in a position within its anti-matter counterpart (e.g. positron) when waves cancel and amplitude reaches zero. For the electron, this position is half of the electron's classical radius ($r_{\text{particle}} / 2$).

The Transverse Energy Equation (Eq. 1.2.2) is used below with an initial starting position of infinity and a final resting position where amplitude is zero at half of the electron's classical radius. Substituting the electron classical

radius of 2.8179×10^{-15} m for r_{particle} and then solving the equation yields the rest energy of the electron. All of its standing wave energy is converted to photon energy at this position when amplitude is zero.

$$E_t = \frac{2\pi\rho K_e^7 \lambda_l^2 c^2 \delta}{A_l} \left(\frac{1}{\frac{r_{\text{particle}}}{2}} - \frac{1}{\infty} \right) \quad (2.4.1)$$

Calculated Value: 8.1871×10^{-14} joules (*rest energy of the electron*)

The photon wavelength upon annihilation of two particles can also be calculated. The Transverse Wavelength Equation uses wavelength count for its calculations, so the distance required for annihilation is converted from meters to wavelength count. The position where waves cancel in Eq. 2.4.1 is half the electron's classical radius. There are 10 electron wavelengths (K_e) in the classical radius as described in the Longitudinal Energy Equation in Section 3.1. Therefore, the midway point is five electron wavelengths, or $K_e/2$. Eq. 1.2.3 is used to calculate wavelength where wavelength count (n) is substituted with $K_e/2$.

$$\lambda_t = \frac{4A_l}{3K_e^3} \frac{1}{\left(\frac{1}{\frac{K_e}{2}} - \frac{1}{\infty} \right)} (\Delta_e) \quad (2.4.2)$$

Calculated Value: 2.4263×10^{-12} m (*electron Compton wavelength*)

The Compton wavelength of the electron (2.4263×10^{-12} m) can be calculated using the Transverse Wavelength Equation (Eq. 2.4.2). This indicates that the particles settle in a position where their longitudinal amplitudes completely cancel. There is no mass that can be measured because their standing waves have collapsed and have transferred energy to transverse energy (photons). However, the particles remain and their wave centers are still resonating at the same frequency – it is just that amplitude is zero or negligible. These particles may eventually be separated again with sufficient energy in the pair production process, which explains why an electron and positron can be created in a vacuum with a photon equal to or greater than the sum of its two masses.¹¹

3. Deriving and Explaining the Energy Wave Equations

In previous sections, the energy wave equations were introduced, including their use and calculation of particle properties including rest energies, photon energies and transverse wavelengths. This section describes the derivation of these equations, explains why they work and how particles interact.

To begin, it is assumed that the energy in the universe, including particles, comes from a base wave energy equation in the following form. Frequency (f) is otherwise expressed as c / λ , which leads to Eq. 3.2.

$$E = \rho V (f_l A_l)^2 \quad (3.1)$$

$$E = \rho V \left(\frac{c}{\lambda} A \right)^2 \quad (3.2)$$

Base Energy Wave Equation

Before deriving the equations, it is important to understand the assumptions that were used to create the equations. Energy flows in waves, but there are two major forms of waves: longitudinal and transverse. Further, longitudinal waves may be standing or traveling. As particles are governed by these types of waveforms, an analogy may be helpful to understand how it works.

Imagine a balloon, under water in the middle of a pool, which is rapidly inflated and deflated repeatedly. The balloon will send spherical, longitudinal waves throughout the pool, losing energy proportional to the inverse square of the distance from the balloon. Now, imagine the balloon, while still being rapidly inflated and deflated, is also traveling up-and-down, from the bottom of the pool to the top and back again. This will create a secondary, transverse wave perpendicular to the motion – towards the sides of the pool.

Next, consider the balloon as the fundamental particle. There is nothing that is smaller than the balloon. It is the wave center and responsible for creating waves that travel through the pool. However, there may be a number of balloons arranged in geometric shapes that keep them together in a stable formation within the pool. Their collective energies are amplified and the waves in the pool become much larger. Although a simple analogy, this may paint a picture of how particles are formed.

Fig 3.1 is an example of wave centers reflecting longitudinal in-waves that are traveling throughout the universe (i.e. traveling waves), similar to the example of the balloon in the pool. When in-waves are reflected, they become out-waves. This produces spherical, standing waves to a defined radius from the wave center (noted in blue color in Fig 3.1). The energy is contained within this radius and may be thought of as stored, or potential, energy. It is measured as the mass of the particle.

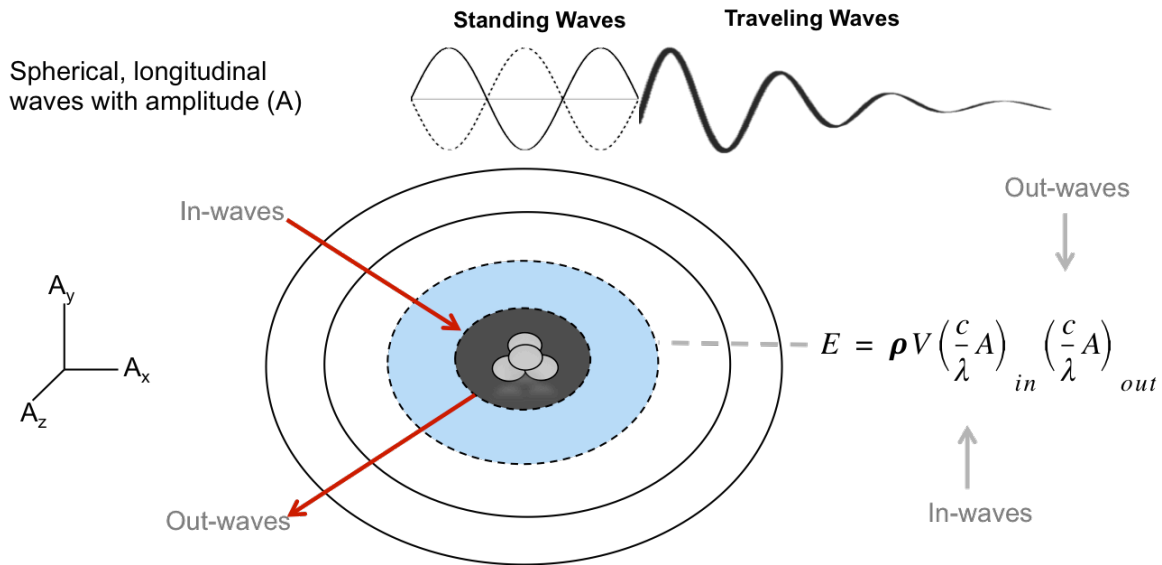

Fig 3.1 – Longitudinal Waves

The base wave energy equation is reflected by the fact that there is a frequency and amplitude for both the in-waves and out-waves, within a defined spherical volume that contains a medium (density property). This becomes the root of the longitudinal energy equation (Eq. 3.3) that will be further derived in Section 3.1.

$$E = \rho V \left(\frac{c}{\lambda} A \right)_{in} \left(\frac{c}{\lambda} A \right)_{out} \quad (3.3)$$

In the balloon example, it is moving up-and-down in the pool, creating a secondary wave. A particle that is vibrating will create a similar wave that is transverse. It is still generating a longitudinal wave, but now has a secondary, transverse wave with a poynting vector in the direction of propagation. It is traveling and no longer contains stored energy (standing waves) – it is kinetic energy.

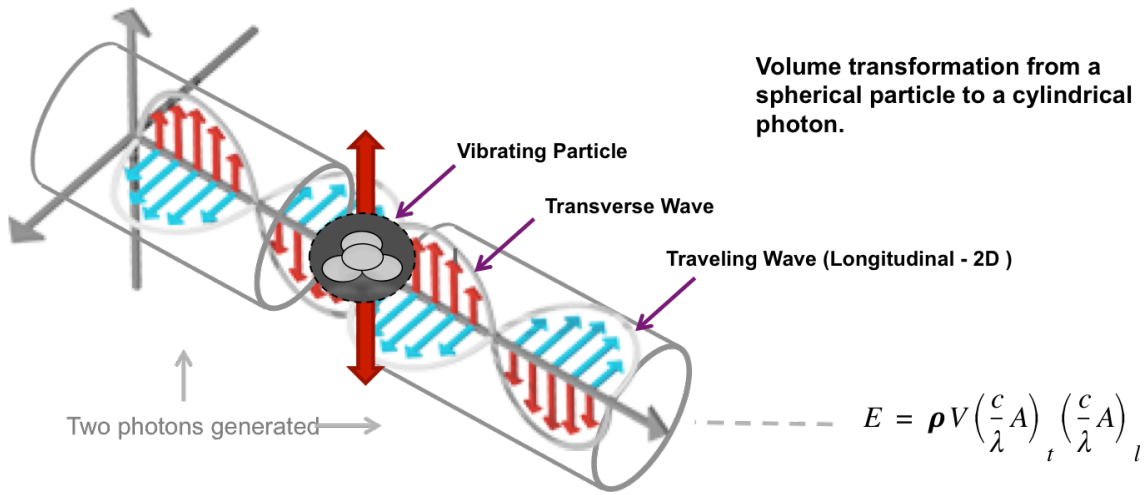

Fig 3.2 – Transverse Waves

The energy of this wave is very different than Eq. 3.3. It no longer has an in-wave. It is a traveling, longitudinal (l) wave with a transverse component (t). It is no longer spherical, but collapses to a volume that is cylindrical. This is the base of the transverse equation that will be further derived in Section 3.2.

$$E = \rho V \left(\frac{c}{\lambda} A \right)_t \left(\frac{c}{\lambda} A \right)_l \quad (3.4)$$

3.1. Particle Rest Energy - Longitudinal Energy Equation

The Longitudinal Energy Equation was shown in Section 1 to calculate a particle's rest energy. In this section, the equation is derived from the base energy wave equation. First, the following assumptions were required in the derivation, expanding on the wave theory laws also found in Section 1.

Particle Formation Assumptions

- The wave center is the fundamental particle, which is possibly the neutrino. Longitudinal in-waves are reflected to become out-waves. The amplitude of these waves decrease with the square of distance, with each wavelength, or shell (n).
- Particles are created from a combination of wave centers. A number of wave centers (K) form the core of the particle, resulting in a standing wave formation from the combination of in-waves and out-waves.
- Wave centers prefer to reside at the node of the wave, minimizing amplitude. They will move to minimize amplitude if not at the node.
- With sufficient energy, wave centers may be pushed together in arrangement to create a new particle (i.e. neutrino oscillation), but will decay (break apart) if the structure does not lend itself to a geometric shape where each wave center resides at the node in a wave.
- When wave centers are spaced in the nodes, at even wavelengths in the core, waves are constructive. A particle's amplitude is the sum of its individual wave center amplitudes in the particle core.
- If two wave centers are pi-shifted from each other on the wave (1/2 wavelength) it will result in destructive waves. This is an anti-particle. For example, if the neutrino is the fundamental wave center, then the anti-neutrino is a wave center pi-shifted from the neutrino.
- Particle radius is proportional to the total wave amplitude, and is the edge of where standing waves convert to traveling, longitudinal waves.
- Particle energy is the energy of standing waves within the particle's radius.

A visual of the wave, its amplitude, wavelength and nodes is shown in Fig 3.1.1 – neutrinos are assumed in the figure to be the fundamental wave center. Neutrinos and anti-neutrinos reside in the node of the wave to minimize amplitude and will move towards the node. Neutrinos at wavelengths create constructive waves; a neutrino and anti-neutrino will be destructive due to wave phase difference.

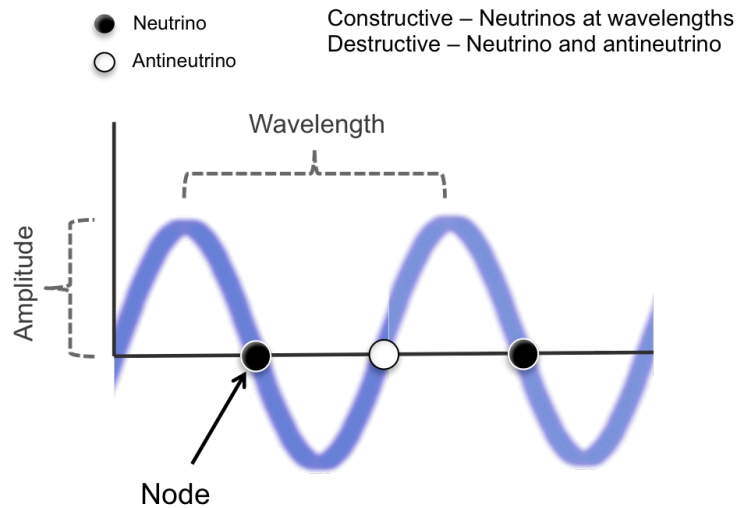

Fig 3.1.1 – Nodes and Neutrino Placement

Figure 3.1.2 illustrates a particle, such as an electron, that is formed from standing waves (in-waves and out-waves). Eventually, standing waves transition to traveling waves, as they cannot keep this form for infinity. This defines the particle radius, at the edge of where the transition occurs. The mass of the particle is then the energy captured within this radius, i.e. standing waves as shown below.

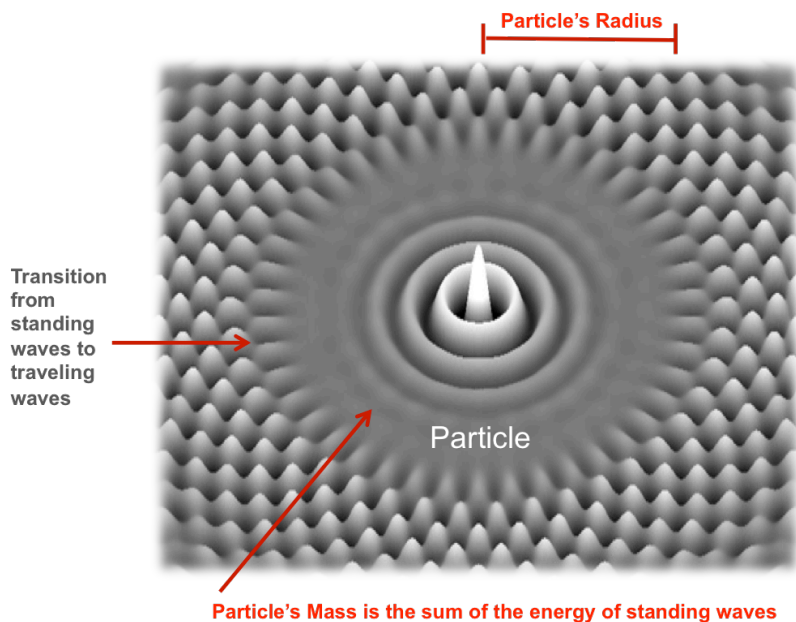

Fig 3.1.2 – Particle Radius and Mass

Fig. 3.1.3 describes spherical, longitudinal waves that have amplitude that decrease with the square of distance. As described in the assumptions in this section, the particle is assumed to consist of standing waves as a result of in-waves and out-waves. Also assumed is that the core of the particle may be made of one or more wave centers (K). Various combinations of wave centers (K) lead to different particles.

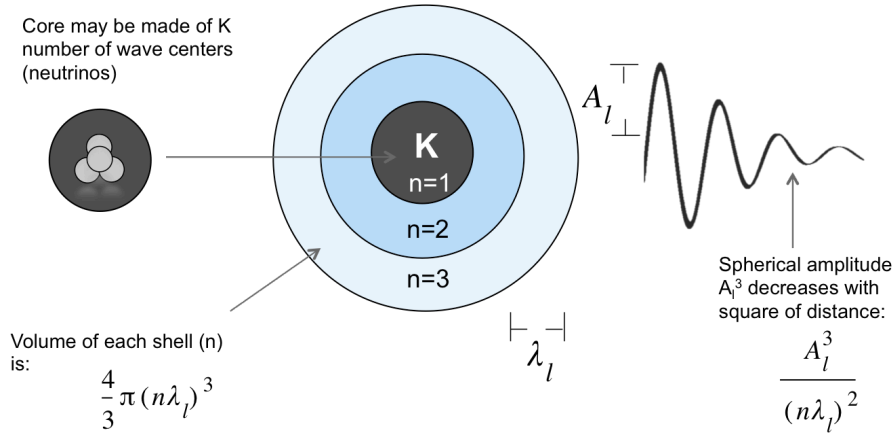

Fig 3.1.3 –Spherical Longitudinal Waves Originating from Particle

From Eq. 3.3, spherical amplitude is noted by A_x , A_y and A_z (or simply A_l^3 since they are equal) that decreases with the square of distance (r). This forms Eq. 3.1.1. At rest, the in-wave frequency and amplitude are the same so it can be simplified to Eq. 3.1.2, which also includes a spherical volume to replace V .

The number of wave centers in the particle affects the core distance (r_{core}). It is a measurement of wavelengths proportional to the number of wave centers (K) as shown in Eq. 3.1.3.

$$E_l = \rho V \left(\frac{c}{\lambda_l} \right)_{in} \left(\frac{A_l^3}{r^2} \right)_{in} \left(\frac{c}{\lambda_l} \right)_{out} \left(\frac{A_l^3}{r^2} \right)_{out} \quad (3.1.1)$$

$$E_l = \rho \left(\frac{4}{3}\pi r^3 \right) \frac{c^2}{\lambda_l^2} \left(\frac{A_l^3}{r^2} \right)^2 \quad (3.1.2)$$

$$r_{core} = K\lambda_l \quad (3.1.3)$$

Amplitude is also affected by the wave center count (K), similar to the particle's core. The resultant wave is the sum of the amplitudes. One assumption is that wave centers reside at wavelengths such that their amplitudes constructively combine, resulting in increased amplitude as described in Fig 3.1.4. Not every geometric relationship makes this possible for all particles, which leads to decay as wave centers are forced out of a stable position on a wave node. Certain geometric structures, particularly at magic numbers also seen in atomic elements, tend to be more stable than other particles when wave centers combine.

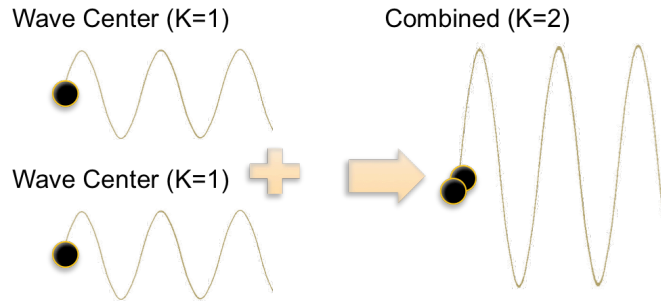

Fig 3.1.4 –Constructive Waves

The core of the particle contains a large amount of energy, based on constructive wave interference that adds amplitude based on the number of wave centers (K). Both amplitude (A) and the particle core radius (now replaced by $K\lambda$ in Eq. 3.1.4) are affected by K. The core energy at $n=1$ is:

$$E_{core} = \rho \left(\frac{4}{3} \pi (K\lambda_l)^3 \right) \frac{c^2}{\lambda_l^2} \left(\frac{(KA_l)^3}{(K\lambda_l)^2} \right)^2 \quad (3.1.4)$$

The core contains the greatest amount of energy per wavelength as amplitude declines with the square of the distance from the center of the particle. However, the total energy or mass of the particle is contained within its standing waves as illustrated in Fig 3.1.2. Beyond the core, particles lose energy with each wavelength. The energy for each shell can be determined, based on the energy at the particle core, and further reduced as amplitude decreases. A particle's rest energy is the energy in each of these shells until standing waves transition to traveling waves.

Each particle's standing wave transition and thus particle radius (r) depends on the number of wave centers (K). It is made of (n) shell numbers of standing waves, each with a particle wavelength of $K\lambda$. This is represented by Eq. 3.1.5. The transition to traveling waves occurs when the shell number matches the wave center count. In other words, $n=K$. The radius of a particle (r) is therefore $K^2\lambda$ as captured in Eq. 3.1.6.

$$r = nK\lambda_l \quad (3.1.5)$$

$$r_{particle} = K^2\lambda_l \quad (3.1.6)$$

The entire stored energy of a particle becomes the sum of each of these shells (n) until it reaches the radius at $n=K$. Eq. 3.1.7 is the sum of each of these shells and becomes the energy equation - the sum of each shell (n) until K wave centers using the radius in Eq. 3.1.5. This value of r is substituted into the Eq. 3.1.2. However, when doing a summation of volume, it is for spherical shells, not the entire sphere, so it should be noted that volume is adjusted accordingly ($n - (n-1)$) for radius. This becomes the longitudinal energy equation to calculate stored energy from standing waves of a particle in Eq. 3.1.7.

Lastly, Eq. 3.1.7 can be simplified in Eq. 3.1.8 to become the Longitudinal Energy Equation.

$$E_{l(K)} = \sum_{n=1}^K \rho \left(\frac{4}{3} \pi (n(K\lambda_l))^3 - \left(\frac{4}{3} \pi ((n-1)K\lambda_l)^3 \right) \right) \frac{c^2}{\lambda_l^2} \left(\frac{(KA_l)^3}{(n(K\lambda_l))^2} \right)^2 \quad (3.1.7)$$

$$E_{l(K)} = \frac{4\pi\rho K^5 A_l^6 c^2}{3\lambda_l^3} \sum_{n=1}^K \frac{n^3 - (n-1)^3}{n^4} \quad (3.1.8)$$

Longitudinal Energy Equation

Note: Standing waves complete at radius $K^2\lambda_l$, but longitudinal energy continues on beyond it as traveling waves.

3.2. Photon Energy – Transverse Wavelength Equation

This section derives and explains the Transverse Wavelength Equation. Similar to the Longitudinal Energy Equation, the derivations started with assumptions for the transverse wave.

Transverse Wave Assumptions

The following assumptions were made when understanding particle interaction, including atomic orbitals:

- Particle vibration creates a transverse wave. A particle may vibrate upon annihilation, when transitioning between orbitals in an atom, or when an entire atom vibrates due to kinetic energy.
- Longitudinal amplitude difference creates particle motion as particles seek to minimize amplitude.
- The difference in longitudinal energy is transferred to transverse energy in a wave packet known as the photon.
- Particles and their anti-matter counterparts attract because of destructive waves between the particles; like particles (e.g. electron-electron) repel due to constructive waves, seeking to minimize amplitude.
- Electrons in an atomic orbital are both attracted and repelled by the nucleus. A positron is assumed to be at its core to attract the orbital electron; opposing forces in the nucleus repel the orbital electron. A potential model of the proton with this structure is explained in *Fundamental Physical Constants*.

A transverse wave is created from a vibrating particle, perpendicular to the direction of motion as illustrated in Fig. 3.2.1. A faster vibrating particle results in a transverse wave with a shorter wavelength than a particle that vibrates slower. The greater the longitudinal amplitude differences in a particle's interaction with surrounding particles, the faster the particle's vibration.

The outgoing, spherical longitudinal wave (out-wave) has an amplitude of $(K \lambda_l)^3 / (K \lambda_l)^2$. In motion, the particle's vibration creates a secondary, transverse wave that takes on new characteristics as it transforms, including a new transverse amplitude and wavelength.

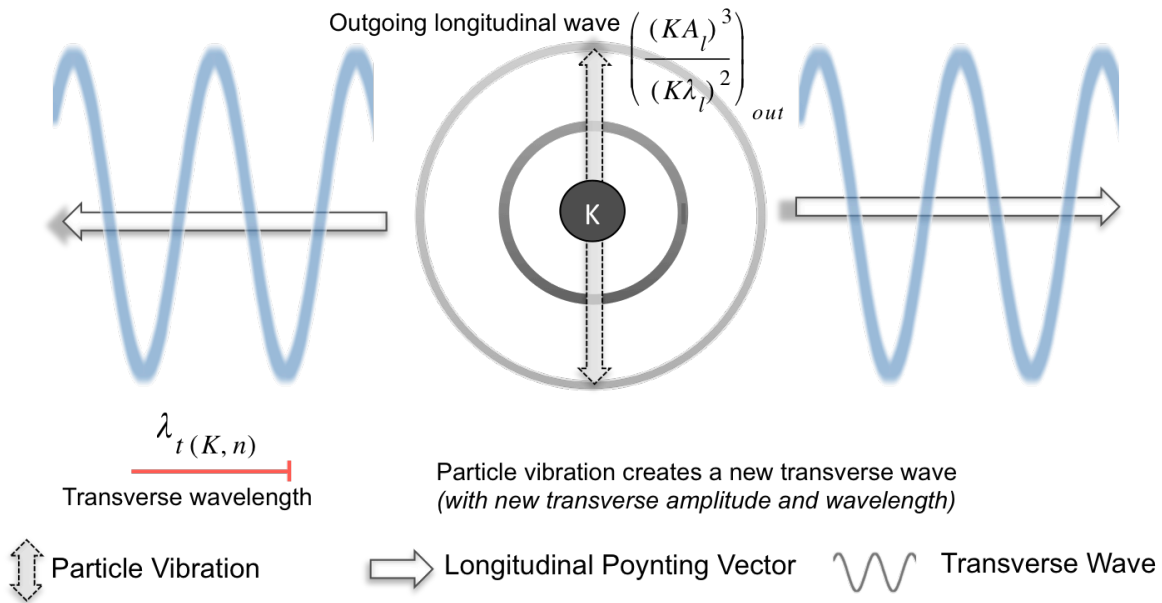
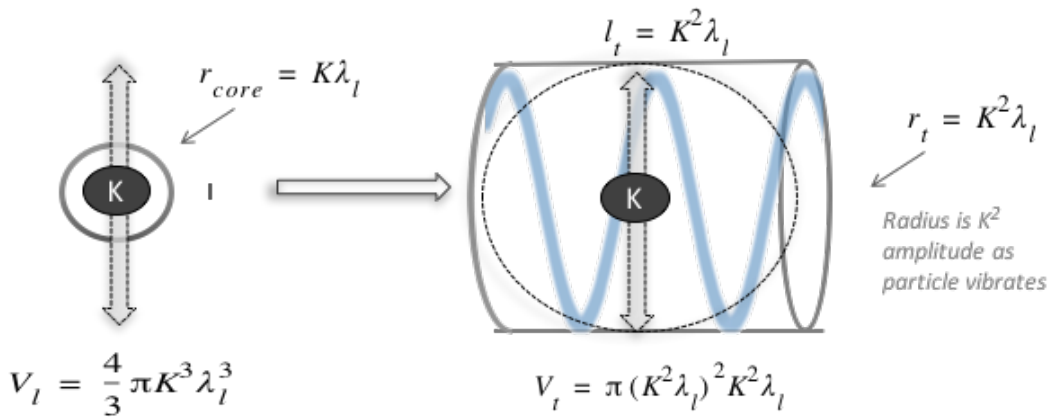

Fig 3.2.1 –Transverse Wave Created by Particle

During vibration, longitudinal energy is transferred to a transverse wave in a volume (shape) that resembles a cylinder. The characteristic of this transition has an impact on the volume in which energy is stored. Fig. 3.2.2 shows this volume transition from a spherical particle (V_l) to a cylindrical photon (V_t). The core, with a radius of $(K \lambda)$, can vibrate to the particle's radius, which is the edge of the standing waves at $K^2 \lambda$.



Volume transformation from a spherical particle to a cylindrical photon.

Fig 3.2.2 –Volume Change – Longitudinal to Transverse

The volume of the particle's spherical core is represented as V_l in Eq. 3.2.1. The photon's cylindrical volume after the particle's vibration is represented as V_t in Eq. 3.2.2.

$$V_l = \frac{4}{3}\pi r^3 = \frac{4}{3}\pi(K\lambda_l)^3 \quad (3.2.1)$$

$$V_t = \pi(r_t)^2 l_t = \pi(K^2\lambda_l)^2 K^2\lambda_l \quad (3.2.2)$$

The ratio of these two volumes (V_{lt}) is derived in the following. Eq. 3.2.5 is the simplified version.

$$V_{lt} = \frac{V_l}{V_t} \quad (3.2.3)$$

$$V_{lt} = \frac{\frac{4}{3}\pi(K\lambda_l)^3}{\pi(K^2\lambda_l)^2 K^2\lambda_l} \quad (3.2.4)$$

$$V_{lt} = \frac{4}{3K^3} \quad (3.2.5)$$

The orbital G-factor (Δ_e) is now introduced for the first time, required to fit data from experiments. In the spherical volume of the electron, the numerical value 4/3 appears as a part of the standard volume of a perfect sphere. However, the spin of the electron may likely change this perfect sphere to be imperfect ($4/3 * \Delta_e$). As seen by the value of the orbital G-factor (0.9936), the volume change is slight but it must be accounted for to match experimental data. In fact, the orbital G-factor can be derived as it was shown earlier in Eq. 1.1.2. Eq. 3.2.5 is now re-written to include the orbital G-factor in Eq. 3.2.6.

$$V_{lt} = \frac{4}{3K^3} (\Delta_e) \quad (3.2.6)$$

As the wave transitions from spherical to the cylindrical shape of the photon, the new, transverse wavelength is related to the original longitudinal amplitude (λ_l) and volume transformation (V_{lt}) for a single shell as described in Eq. 3.2.7.

$$\lambda_t = A_l V_{lt} \quad (3.2.7)$$

The wavelengths and energies will be calculated over a difference between wavelengths with a starting position (n_0) and ending position (n). An illustration is provided to understand the initial and final starting positions of the electron in an orbital in Fig. 3.3.3. Also pictured in the figure is a difference in amplitude as a result of constructive or destructive wave interference, amplitude factor δ .

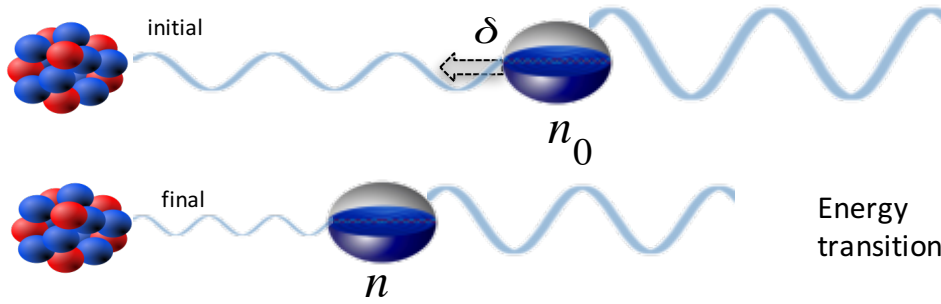

Fig 3.3.3 – Energy Transition

$$\lambda_t = A_l V_{lt} \frac{1}{\left(\frac{1}{n} - \frac{1}{n_0}\right)} \quad (3.2.8)$$

V_{lt} is known from Eq. 3.2.6 and can be substituted into Eq. 3.2.8 and then simplified. This is the transverse wavelength associated with a wavelength count (n).

$$\lambda_t = \frac{4A_l}{3K_e^3} \frac{1}{\left(\frac{1}{n} - \frac{1}{n_0}\right)} (\Delta_e) \quad (3.2.9)$$

Transverse Wavelength Equation

3.3. Photon Energy - Transverse Energy Equation

In Fig. 3.2, a particle was shown to create two photons with a transverse wave along with its longitudinal, traveling wave. This illustration is now updated to show the base wave energy equation expanded to have these wave

components. The energy equation for this wave will have both a transverse frequency and longitudinal frequency, described in Eq. 3.3.1, where V_t is the volume of the cylindrical photon. It can also be thought of as the **electrical** and **magnetic components** of the electromagnetic wave.

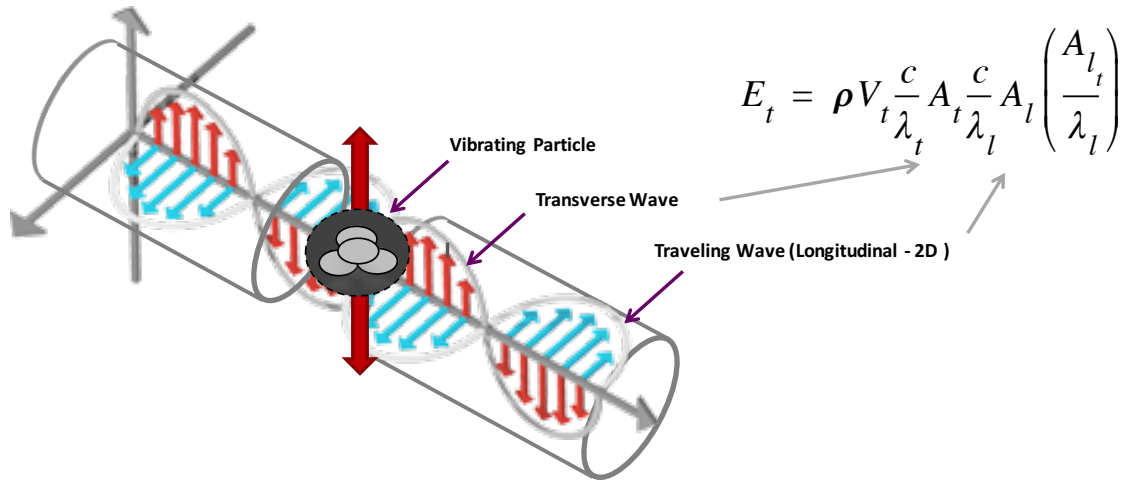

Fig 3.3.1 – Transverse Waves

The origin of this equation is again the base energy wave equation (Eq. 3.1), substituting the aforementioned volume, frequencies and amplitudes for transverse energy. The volume of energy is now cylindrical (V_t). The vibrating particle still has longitudinal waves reflected from the particle core but it is a 2-dimensional wave where amplitude, A_l^2 , is reduced proportional to each wavelength. The third dimension of this wave, is now transverse in the direction perpendicular to particle vibration. This is expressed mathematically in Eq. 3.3.1. Then, it is rewritten in a slightly different form (Eq. 3.3.2) to separate wave amplitude which will be replaced later.

$$E_t = \rho V_t \frac{c}{\lambda_t} A_t \frac{c}{\lambda_l} A_l \left(\frac{A_{l_t}}{\lambda_l} \right) \quad (3.3.1)$$

$$E_t = \rho V_t \frac{c}{\lambda_t} \frac{c}{\lambda_l^2} (A_t A_l^2) \quad (3.3.2)$$

To simplify the calculation of amplitude as it changes from longitudinal wave form to transverse wave form, a new variable is introduced called the amplitude factor (δ). This variable is a measure of amplitude change due to constructive or destructive wave interference. When a single proton/positron and electron interact, this factor is set to one ($\delta=1$). When additional protons or electrons interact, the variable changes because amplitude is modified due to wave interference.

The amplitude factor variable makes it simpler in calculations to determine the transverse wave energy. Longitudinal wave amplitude changes to transverse amplitude proportional to the volume change from spherical to cylindrical. There are also two photons that are created, traveling in opposite directions from the vibrating particle. This is described in Eq. 3.3.3. The equation is the rewritten to solve for transverse amplitude for substitution.

$$\delta = \frac{A_t A_l^2}{2V_{lt}} \quad (3.3.3)$$

$$A_t A_l^2 = 2V_{lt} \delta \quad (3.3.4)$$

Now, Eq. 3.3.4 can be substituted into Eq. 3.3.2.

$$E_t = \rho V_t \frac{c^2 2V_{lt} \delta}{\lambda_t \lambda_l^2} \quad (3.3.5)$$

Next, V_t and V_{lt} from Eqs. 3.2.2 and 3.2.6 respectively are used to expand Eq. 3.3.5. Then, it is simplified in Eq. 3.3.7.

$$E_t = \rho (\pi (K_e^2 \lambda_l)^2 K_e^2 \lambda_l) \frac{c^2 2\delta}{\lambda_t \lambda_l^2} \left(\frac{4}{3K_e^3} \Delta_e \right) \quad (3.3.6)$$

$$E_t = \frac{8}{3} \pi \rho K_e^3 \lambda_l c^2 \delta \frac{1}{\lambda_t} (\Delta_e) \quad (3.3.7)$$

The orbital G-factor (Δ_e) will eventually cancel out in upcoming steps, and since amplitude factor is constant for a single electron ($\delta=1$), it was chosen to combine two constants into one. This created the single electron amplitude factor constant ($\delta_e=0.9936$). It appears in some of the fundamental physical constants, but it does not affect transverse energy calculations as it will be shown later.

$$\delta_e = \delta (\Delta_e) \quad (3.3.8)$$

After substituting Eq. 3.3.8 into Eq. 3.3.7 to consolidate two constants into one, Planck's constant (h) is found in the equation. With the exception of transverse wavelength (λ_t), all of the remaining components in the equation are constant. Eq. 3.3.10 matches the Planck constant in both numerical value and units. Since frequency (f) is wave speed divided by wavelength (Eq. 3.3.11), it can be substituted to become Eq. 3.3.12.

$$E_t = \frac{8}{3} \pi \rho K_e^3 \lambda_l c^2 \delta_e \frac{1}{\lambda_t} \quad (3.3.9)$$

$$h = \frac{8}{3} \pi \rho K_e^3 \lambda_l c \delta_e = 6.6261 \cdot 10^{-34} \quad (3.3.10)$$

$$E_t = h \frac{c}{\lambda_t} \quad (3.3.11)$$

$$E_t = hf \quad (3.3.12)$$

The objective, however, is not to derive an energy equation that is already used today ($E=hf$). The objective is to derive the transverse energy in terms of wave constants used in this paper. Therefore, reverting back to Eq. 3.3.7 it is found that the remaining variable is transverse wavelength. This was previously solved in Eq. 3.2.9. Substituting transverse wavelength from Eq. 3.2.9 into Eq. 3.3.7:

$$E_t = \frac{8}{3} \pi \rho K_e^3 \lambda_l c^2 \delta (\Delta_e) \frac{1}{\left(\frac{4A_l}{3K_e^3} \frac{1}{\left(\frac{1}{n} - \frac{1}{n_0} \right)} \right) (\Delta_e)} \quad (3.3.13)$$

Now, the orbital G-factor will cancel from the equation. Simplifying Eq. 3.3.13 to become the Transverse Energy Equation in wavelength counts (n).

$$E_t = \frac{2\pi\rho K_e^6 \lambda_l c^2 \delta}{A_l} \left(\frac{1}{n} - \frac{1}{n_0} \right) \quad (3.3.14)$$

Transverse Energy Equation - Wavelengths

The Transverse Energy Equation can also be represented in radius (meters) instead of wavelengths. Since radius is related to the number of wavelengths (n), it is found that:

$$r = n K_e \lambda_l \quad (3.3.15)$$

$$n = \frac{r}{K_e \lambda_l} \quad (3.3.16)$$

Substituting Eq. 3.3.16 into Eq. 3.3.14 to get the Transverse Energy Equation in a distance measured in meters:

$$E_t = \frac{2\pi\rho K_e^7 \lambda_l^2 c^2 \delta}{A_l} \left(\frac{1}{r} - \frac{1}{r_0} \right) \quad (3.3.17)$$

Transverse Energy Equation

3.4. Transfer of Wave Energy (Longitudinal <-> Transverse)

Energy is always conserved but it may transfer forms. A photon is transverse wave energy, created from the conversion of a particle's longitudinal wave energy. It occurs if an electron is captured into an orbital of an atom or in a complete annihilation between particle and its anti-matter equivalent (e.g. electron and positron). Likewise, a photon can be absorbed by a particle, transferring transverse wave energy to longitudinal energy. Examples are electrons being ionized by an atom that has increased longitudinal energy or by the creation of particles, called pair production.

This section demonstrates that energy is perfectly conserved by calculating the longitudinal energy of a hydrogen atom and the Bohr radius (a_0), which is the distance to the first orbital where the electron resides. It will be shown that the longitudinal energy, using the Longitudinal Energy Equation, is equal to twice (2) the Rydberg unit of energy constant (R_y), matching experimental evidence for hydrogen photon calculations. It exactly twice, because there are two photons created with an energy value equal to the Rydberg constant. As this energy is released and

converted to photon energy, or transverse energy, the energy calculated by the Transverse Energy Equation at this distance is equal. Energy is always conserved.

First, the distance to the Bohr radius needs to be calculated. Orbitals are gaps in the atomic structure where the force on an electron is equal. The atomic nucleus is pulling and pushing the electron as shown in Fig. 3.4.1. An explanation and the derivation of the orbital distance will be detailed further in the next section.

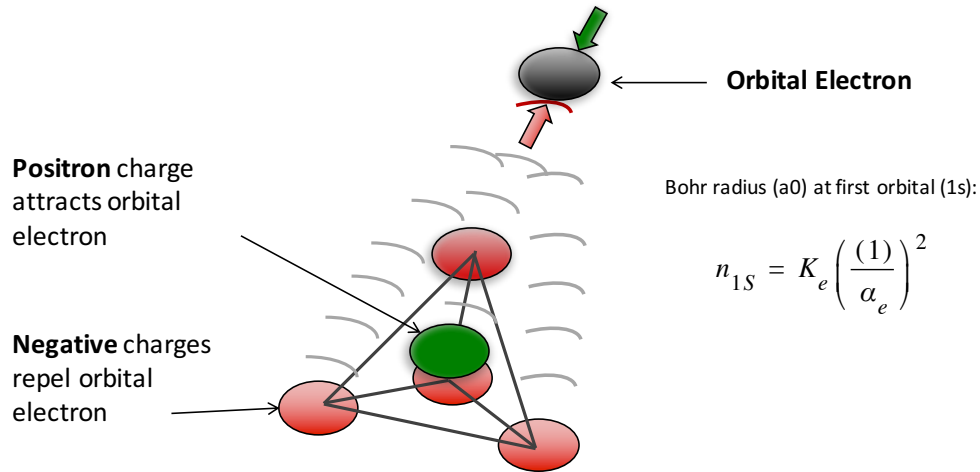

Fig 3.4.1 – Orbitals at Wave Cancellation Points

The Bohr radius at orbital 1s is expressed in wavelength count (n_{1s}) in Eq. 3.4.1, which is found to be 187,789 wavelengths. This value is then substituted into Eq. 3.3.15 to arrive at the Bohr radius (a_0) in meters (shown in Eq. 3.4.2). Its value is 5.2918×10^{-11} meters.

$$n_{1S} = K_e \left(\frac{(1)}{\alpha_e} \right)^2 \quad (3.4.1)$$

$$a_0 = n_{1S} K_e \lambda_l \quad (3.4.2)$$

Longitudinal Energy Calculation

First, the energy of the hydrogen nucleus in the form of spherical, longitudinal waves is calculated. It is expected that the photon energy produced by longitudinal energy is $\frac{1}{2}$, because it is split into two photons that are created by this longitudinal energy.

$$E = \frac{1}{2} \Delta E_l \quad (3.4.3)$$

Longitudinal energy can be calculated beyond particle standing waves based on the energy difference at two points (initial point r_0 and final point r). It is the energy of the electron (E_e) multiplied by a ratio of standing wave distance ($r_{particle}$) to the traveling wave distance (r) where the electron resides from atomic nucleus. The variables Q_1 and Q_2

are introduced here as the numerical count of particles in each group separated at distance r . It is the equivalent of the amplitude factor variable for transverse energy, but particle counts (Q) are used for longitudinal energy. For the purpose of this paper, it is simply one (1) for hydrogen as there is one proton and one electron in the atom. Particle counts beyond hydrogen are not addressed in this paper, however, they are used extensively and detailed in the *Forces* paper.

$$\Delta E_l = E_e \left(\frac{r_{particle} (Q_1) (Q_2)}{r} \right) - E_e \left(\frac{r_{particle} (Q_1) (Q_2)}{r_0} \right) \quad (3.4.4)$$

The electron's energy (E_e) can be substituted with the Longitudinal Energy Equation for particle rest energy found in Eq. 3.1.8. To simplify readability, the summation is replaced with the constant O_e , found in Eq. 1.1.1. Finally, $r_{particle}$ is replaced with the wave constants found in Eq. 3.1.6. The proof of the electron's energy and radius were shown to match the known values and units of measured results in previous sections. This expands to Eq. 3.4.5.

$$\Delta E_l = \frac{4\pi\rho K_e^5 A_l^6 c^2 O_e}{3\lambda_l^3} \left(\frac{K_e^2 \lambda_l (Q_1) (Q_2)}{r} \right) - \frac{4\pi\rho K_e^5 A_l^6 c^2 O_e}{3\lambda_l^3} \left(\frac{K_e^2 \lambda_l (Q_1) (Q_2)}{r_0} \right) \quad (3.4.5)$$

Eq. 3.4.5 is simplified:

$$\Delta E_l = \frac{4\pi\rho K_e^7 A_l^6 c^2 O_e (Q_1) (Q_2)}{3\lambda_l^2} \left(\frac{1}{r} - \frac{1}{r_0} \right) \quad (3.4.6)$$

Solving for hydrogen which has one proton ($Q_1=1$) and one electron ($Q_2=1$), and inserting these values into Eq. 3.4.7. For an ionized electron that leaves the atom, the distance can be treated as infinity (∞).

$$E = \frac{1}{2} \left(\frac{4\pi\rho K_e^7 A_l^6 c^2 O_e (1) (1)}{3\lambda_l^2} \right) \left(\frac{1}{\infty} - \frac{1}{a_0} \right) \quad (3.4.7)$$

Solving for Eq. 3.4.7, using the value a_0 found in Eq. 3.4.2, it is found to match the Rydberg unit of energy (R_y), measured in joules. Note that a negative energy value means a photon is absorbed. A positive value means a photon is created.

$$E = R_y = -2.1799 \cdot 10^{-18} \quad (3.4.8)$$

Transverse Energy Calculation

Next, the transverse energy of the photon that is absorbed for the ionization of an electron from the hydrogen 1s orbital from the Bohr radius (a_0). Using the Transverse Energy Equation (Eq. 1.2.2):

$$E_t = \frac{2\pi\rho K_e^7 \lambda_l^2 c^2 \delta}{A_l} \left(\frac{1}{\infty} - \frac{1}{a_0} \right) \quad (3.4.9)$$

The variables in this equation are the amplitude factor ($\delta=1$ for hydrogen) and the Bohr radius from Eq. 3.4.2. Solving this equation results in the same energy value found in the longitudinal equation- the Rydberg unit of energy constant in joules.

The photon has completely transferred its transverse wave energy to longitudinal wave energy.

$$E = R_y = -2.1799 \cdot 10^{-18} \quad (3.4.10)$$

Annihilation Example

A second example is provided to demonstrate that particle rest energy, in the form of longitudinal standing waves, can also be converted to photon energy (transverse waves). This example also shows the conversion that creates a photon, thus the energy value will be positive (instead of negative in the previous example where a photon was absorbed).

Earlier, it was shown that the longitudinal energy of the electron can be calculated using the Longitudinal Energy Equation, shown for the electron particle below in Eq. 3.4.11. The rest energy is calculated to be 8.1871×10^{-14} joules.

$$E_e = E_{l(10)} = \frac{4\pi\rho K_e^5 A_l^6 c^2 O_e}{3\lambda_l^3} = 8.1871 \cdot 10^{-14} \quad (3.4.11)$$

In annihilation, an electron and positron have wave amplitude that is completely destructive, which is why the particles can no longer be detected. All longitudinal wave energy disappears as there is zero amplitude after destructive wave interference, but the particles (consisting of wave centers) are still there and can be recreated if a photon with sufficient energy transfers transverse energy back to longitudinal.

Using the Transverse Energy Equation, the electron-positron amplitude factor is identical to the electron-proton amplitude factor seen in hydrogen ($\delta=1$). Now, the initial position of the electron is infinity, but it's final position is unknown as the particle settles in close proximity to the positron. It turns out that the final position, r , is half of the electron's classical radius ($r_{particle}$). At this position, the electron and its anti-particle, the positron, completely cancel wave amplitude.

$$E_t = \frac{2\pi\rho K_e^7 \lambda_l^2 c^2 \delta}{A_l} \left(\frac{1}{\frac{r_{particle}}{2}} - \frac{1}{\infty} \right) \quad (3.4.12)$$

Amplitude factor is replaced with the value one (1) and particle radius is replaced with its wave constants found in Eq. 3.1.6. After solving for Eq. 3.4.13, the energy value for the electron particle is found at 8.1871×10^{-14} joules. Two photons of this value will be created during annihilation, one for each particle (electron and positron).

$$E_t = \frac{2\pi\rho K_e^7 \lambda_l^2 c^2 (1)}{A_l} \left(\frac{1}{\frac{K_e^2 \lambda_l}{2}} - 0 \right) = 8.1871 \cdot 10^{-14} \quad (3.4.13)$$

This section demonstrates the transfer of energy from transverse to longitudinal wave form and vice versa for a simple atomic configuration with one electron and one proton/positron. Yet, using the amplitude factor variable for transverse waves, or the particle counts (Q) for longitudinal waves, energy levels for any atom can be found if the distance is known between particles. The next section highlights how to calculate distances and energies beyond hydrogen.

3.5. Photon Energy of Any Atom

The photon energy emitted or absorbed in any atom can be calculated using the Transverse Energy Equation if two things are known about the electron that is affected: 1) amplitude factor (δ) and 2) distance (r). These variables are highly dependent on other particles within the atom (protons and electron configuration), thus hydrogen is the simplest to calculate and is the starting point since it has a single electron and proton.

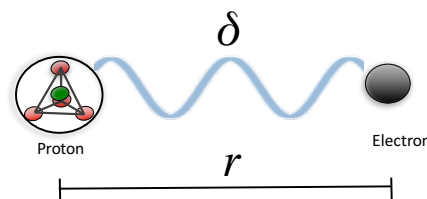

Fig 3.5.1 – Hydrogen atom. Destructive wave interference measured as amplitude factor (δ) at distance r .

This section will explain the methodology to calculate the amplitude factor and the orbital radius for electrons. Calculations are provided for the first orbital of hydrogen and helium in this paper, but the detailed calculations for the first twenty elements are reserved for a *forthcoming* paper on orbital distances and photon energies for each of the orbitals. To prove the Transverse Energy Equation in this paper, a simplified equation is presented for the 1s orbital of the first twenty elements in Section 3.6 based on a pattern that is found in the first orbital.

Calculating Amplitude Factor – First Orbital

Amplitude factor (δ) is a convenient way to measure constructive and destructive wave interference. When the number of protons (Z) and electrons (e) are equal at a given distance, this factor is set to one (1). If the number of

protons exceeds the number of electrons, such as ionized elements, then the factor is incremented by one for each additional proton for the 1s orbital. This is summarized in Eq. 3.5.1:

$$\delta_{1s} = Z - e_1 + 1 \tag{3.5.1}$$

For example, the amplitude factor of hydrogen with one proton (Z) and one electron (e_1) is one ($1-1+1 = 1$). Helium with two protons and two electrons is also one ($2-2+1 = 1$). However, ionized helium (He^+) with two protons and one electron is two ($2-1+1 = 2$).

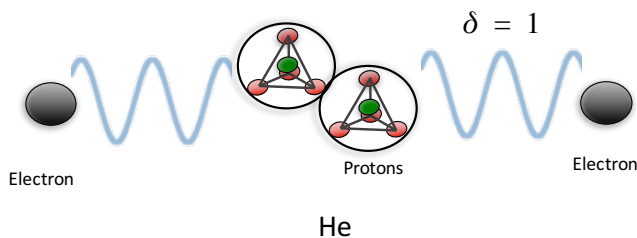

Fig 3.5.2 – Helium amplitude factor is 1.

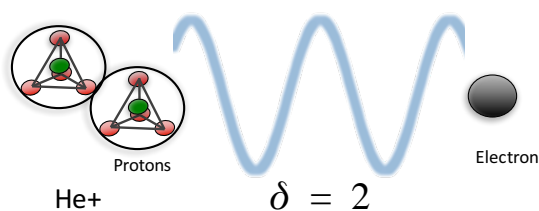

Fig 3.5.3 – Ionized helium amplitude factor is 2.

Amplitude factors for orbitals beyond 1s need to consider electrons in multiple orbitals which adjust constructive or destructive wave interference and thus have different equations to calculate. This is detailed in a *forthcoming* paper.

Calculating Orbital Distance – Radius (r)

Orbital distances, measured from the atomic nucleus as a radius, r , can be described by classical equations for force. The electron does not orbit the nucleus like the Moon orbits Earth. Instead, it is being both pulled and pushed by the proton, and the orbital is the position where the sum of the forces is zero as shown in Fig. 3.5.4. It requires a new model and understanding of the proton, but this model does accurately calculate orbital distances for at least the first twenty atomic elements.

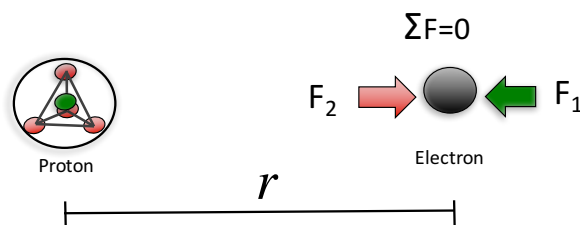

Fig 3.5.4 – Orbital distance r is where the sum of the forces on the electron is zero.

To explain the forces acting on the electron, the starting point is Eq. 3.4.4 which accurately calculated the longitudinal energy (Coulomb force) of an electron. Since the energy being calculated is the electron, r_e , which is the classical radius of the electron, it replaces r_{particle} . Q_1 is the electron and Q_2 is the anti-quark/positron in the center of the proton.

$$E = E_e \left(\frac{r_e Q_1 Q_2}{r} \right) \quad (3.5.2)$$

Force is energy over distance (r). Thus, the Coulomb force (F_1) attracting the electron to the proton is described in Eq. 3.5.2 with another r in the denominator. A complete derivation and calculations of the Coulomb force, gravitational force and strong force are provided in the *Forces* paper.

$$F_1 = \frac{E_e r_e Q_1 Q_2}{r^2} \quad (3.5.3)$$

A proton also has a force (F_2) that forces the electron away from the atomic nucleus. This is a different model of the proton, but experimental evidence suggests that it does exist:

1. In lower energy collision experiments, the proton was found to consist of three quarks (two up quarks and a down quark).¹²
2. Recently, in higher energy collision experiments, pentaquark arrangements have been found which consist of four quarks and an anti-quark.¹³
3. It is suggested for this new proton model that the pentaquark is the arrangement of the proton, and that lower energy experiments fail to detect the additional quark and anti-quark because they immediately annihilate and are unable to be detected. The four quarks arrange in a tetrahedral shape, with the anti-quark in the middle.
4. The anti-quark is responsible for the attractive force, F_1 .
5. The remaining quarks have special properties that tightly bound them together. This force bounding quarks is the strong force, which is an axial force seen as gluons. It is a conversion of spherical, longitudinal energy to axial energy. Energy is always conserved, but now energy is transferred to axial with an increase equal to the fine structure constant, but decreasing with the inverse square from distance. Force is energy over distance, so this axial force decreases with the inverse cube from distance. This becomes the force pushing the electron away from the atomic nucleus (F_2).
6. Although the components of the proton are called quarks, mathematically in these equations, they have the same properties as electrons. For example, the Coulomb force (F_1) attracting the electron to the proton is identical to the force of an electron and positron. Beta decay experiments do show the proton emits a positron, so it is possible that the anti-quark is a positron and quarks are electrons.¹⁴ This is explained in more detail in the *Forces* paper.

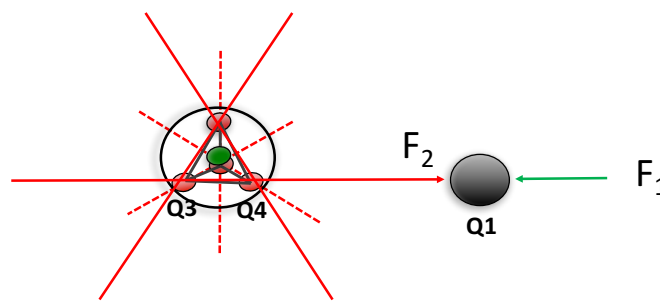

Fig 3.5.5 – Force 2 (F_2) is an axial force pushing the electron from the proton.

The axial force (F_2) is described mathematically in Eq. 3.5.4. Q_3 and Q_4 are the number of quarks in alignment for the axial force that pushes on the electron (Q_1). Each quark has an amplitude gain equal to the fine structure constant (α_e). It is simplified in Eq. 3.5.5. Although the force binding quarks together due to the axial force (gluons) has increased within the atomic core relative to the Coulomb force, it decreases faster with distance now that it is the inverse cube (r^3).

$$F_2 = E_e \frac{Q_3 r_e}{\alpha_e r} \left(\frac{Q_4 r_e}{\alpha_e r} \right) \frac{Q_1}{r} \quad (3.5.4)$$

$$F_2 = \frac{E_e r_e^2 Q_1 Q_3 Q_4}{\alpha_e^2 r^3} \quad (3.5.5)$$

Q_2 is the number of protons, so this can be replaced with the commonly used variable – Z (Eq. 3.5.6). Q_3 and Q_4 are equal, and will always be within a proton, so it will simply be called Q (Eq. 3.5.7). These are substituted into the equations for F_1 and F_2 found in Eqs. 3.5.3 and 3.5.5 respectively.

$$Q_2 = Z \quad (3.5.6)$$

$$Q = Q_3 = Q_4 \quad (3.5.7)$$

$$F_1 = \frac{E_e r_e Z Q_1}{r^2} \quad (3.5.8)$$

$$F_2 = \frac{E_e r_e^2 Q_1 Q^2}{\alpha_e^2 r^3} \quad (3.5.9)$$

The position where the electron rests – its orbital – is the position where the sum of the forces is zero. The attracting force is initially smaller than the repelling force, which is why the electron stays in orbit instead of annihilating with the proton. However, the attracting force decreases with the inverse square and the repelling force decreases with the inverse cube, which allows a position where the forces are equal. This is Eq. 3.5.10. At this position, r , the forces (F_1 and F_2) are set to equal as shown in Eq. 3.5.11.

Example: Hydrogen 1s – Bohr Radius

$$\Sigma F = 0 \quad (3.5.10)$$

$$F_1 = F_2 = \frac{E_e r_e Z Q_1}{r^2} = \frac{E_e r_e^2 Q_1 Q^2}{\alpha_e^2 r^3} \quad (3.5.11)$$

Eq. 3.5.11 is solved for in terms of radius, r . In Eq. 3.5.13 it is simplified to be a function of the electron's classical radius (r_e), the fine structure constant (α_e), the number of axial connections in line with the electron (Q) and the proton count (Z). Eq. 3.5.13 is used for any atom with one electron, whether it is hydrogen or an ionized atomic element with only one electron.

$$\frac{r^3}{r^2} = \frac{E_e r_e^2 Q_1 Q^2}{\alpha_e^2 E_e r_e Z Q_1} \quad (3.5.12)$$

$$r = \frac{r_e Q^2}{\alpha_e^2 Z} \quad (3.5.13)$$

The **Bohr radius** can be calculated with eq. 3.5.13. The classical electron radius and fine structure constant will always be constant, so the two variables are Q and Z . The Bohr radius is the simplest configuration of hydrogen – there is one proton ($Z=1$) and there is only one axial configuration of quarks ($Q=1$).

$$r = \frac{r_e (1)^2}{\alpha_e^2 (1)} \quad (3.5.14)$$

Solving for Eq. 3.5.14, the radius is 5.2918×10^{-11} meters, which is the Bohr radius.

Example: Hydrogen 2s

There are two ways an electron will move to the next orbital. The first is when the axial force aligns within two or more protons (requires same spin and geometric alignment of protons). The second is when the proton's spin increases, which has an effect on the amplitude gain (fine structure constant). The increased spin must be at integers to match the frequency of longitudinal waves because of the phenomenon known as resonance. It would be analogous to pushing a swing at a certain frequency. The swing can gain amplitude, but the swing's frequency should match the

frequency of the person pushing the swing. For the second orbital of hydrogen, this has an effect to double the amplitude of each quark in the axial force, although there is still only one axial force in alignment with the electron (Q=1). Eq. 3.5.15 is a modified version of Eq. 3.5.4 to include the effect on amplitude (modification of fine structure constant). It is simplified to Eq. 3.5.16 (again, Q₃ and Q₄ are one and Q₁ is the number of protons, Z).

$$F_2 = E_e \frac{Q_3 r_e}{\alpha_e \frac{r}{2}} \left(\frac{Q_4 r_e}{\alpha_e \frac{r}{2}} \right) \frac{Q_1}{r} \tag{3.5.15}$$

$$r = \frac{r_e (2)^2}{\alpha_e^2 (1)} \tag{3.5.16}$$

The second orbital is calculated to be 2.1167 x 10⁻¹⁰ meters.

Electron's Probability Cloud

The electron has a probability cloud which shows that it is not always at the orbital radius that is calculated in the examples above. Hydrogen's ground state (1s) and the first excited state (2s) were calculated, but actual results are similar to Fig. 3.5.6 below. Despite the electron having varying distances from the nucleus, its spectral results for photon energies are always predictable and do not vary.

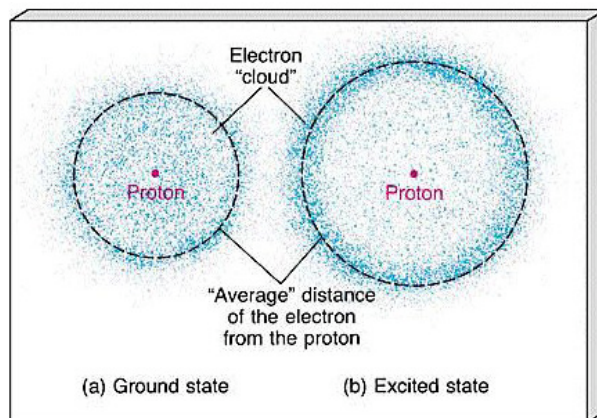

Fig 3.5.6 – Electron's probability cloud. Credit: Pearson Prentice Hall.

Electron radius probability is explained by the fact that there are axial forces that push the electron away from the nucleus at certain positions when the electron is in alignment with two or more quarks, but it is always pulled by the nucleus. The sum of the forces being equal is only when the electron is in alignment with two or more quarks. The proton is continuously spinning, so the electron is always being pushed and pulled by the nucleus. Assuming the four quarks are in a tetrahedral shape, this would be 6 different axial lines from the nucleus, or 12 different positions, where the sum of the forces is zero from a single proton. This is illustrated in Fig. 3.5.7.

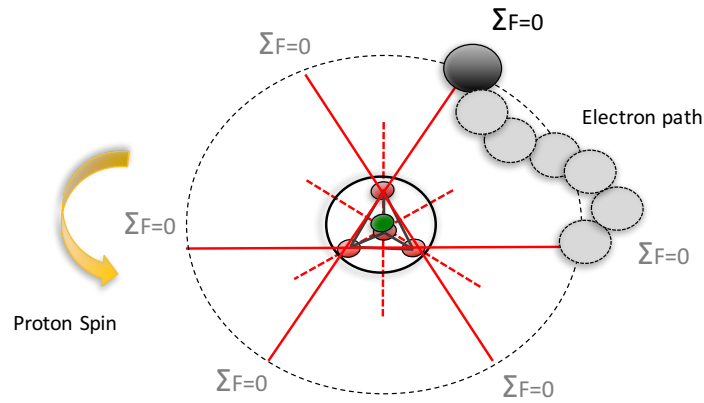

Fig 3.5.7 – The electron’s probability cloud as the proton spins, creating gaps where it is pulled into the nucleus and pushed out again.

In Section 3.4, transverse (photon) energy was derived and calculated to be a conversion of longitudinal energy. In Fig. 3.5.7, the longitudinal energy or Coulomb force comes from the anti-quark/positron in the nucleus that attracts the electron. This energy is converted from longitudinal to transverse or vice versa, based on the distance where the sum of the forces is zero.

Example: Hydrogen Photon Energy (3s -> 2s)

An example that proves the emission of a photon from a difference in longitudinal wave energy is hydrogen as the electron moves from the excited state at the 3s orbital to the 2s orbital. Using the Transverse Energy Equation (Eq. 1.2.2) and substituting for the radius values of the 3s and 2s orbitals from the equation found in Eq. 3.5.16:

$$E_t = \frac{2\pi\rho K_e^7 \lambda_l^2 c^2 (1)}{A_l} \left(\frac{1}{\frac{r_e(2)^2}{\alpha_e^2(1)}} - \frac{1}{\frac{r_e(3)^2}{\alpha_e^2(1)}} \right) \quad (3.5.17)$$

The solves to be 3.028×10^{-19} joules.

Example: Helium

Helium, or any ionized element with two electrons, is the next simplest of the atomic elements to calculate. The methodology remains the same, but an additional force needs to be considered from another electron (Q_s) in the atom. With helium, there is a second proton (Z) which increases the attractive force (F_1). Now, there is also a third force (F_3) acting on the electron as illustrated in Fig. 3.5.8.

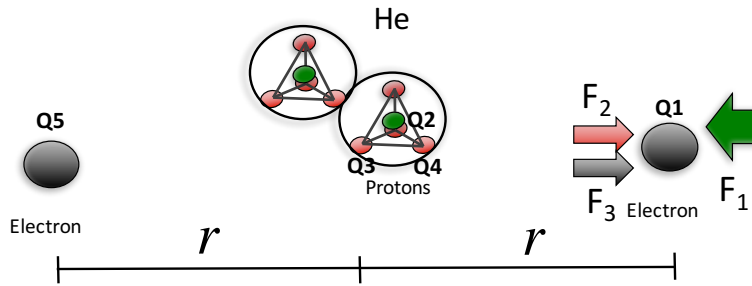

Fig 3.5.8 – Helium atom has an additional proton and electron to consider for the forces.

The third force (F_3) is a standard, Coulomb, force between two electrons. The electrons are both separated at a distance r from the nucleus. However, the force being calculated is in respect to one of the electrons (Q_1), thus the distance to the other electron (Q_5) is $r + r = 2r$. This force is shown in Eq. 3.5.18. Since it is a repelling force, it is added to the right side of Eq. 3.5.11, creating a new Eq. 3.5.19 for atomic elements with two electrons in orbit.

$$F_3 = \frac{E_e r_e Q_1 Q_5}{(2r)^2} \quad (3.5.18)$$

$$F_1 = F_2 + F_3 = \frac{E_e r_e Z Q_1}{r^2} = \frac{E_e r_e^2 Q_1 Q^2}{\alpha_e^2 r^3} + \frac{E_e r_e Q_1 Q_5}{(2r)^2} \quad (3.5.19)$$

This is simplified:

$$\frac{Z}{r^2} = \frac{Q^2 r_e}{r^3 \alpha_e^2} + \frac{Q_5}{4r^2} \quad (3.5.20)$$

Solving for standard helium, it has two protons or $Z=2$. There are only two quarks in alignment creating the axial force, just like hydrogen, as the second proton has an opposite spin, therefore $Q=1$. Q_5 represents one electron, so this value is also set to one. After substitution, and solving for radius r , it is simplified to Eq. 3.5.22.

$$\frac{2}{r^2} = \frac{r_e}{r^3 \alpha_e^2} + \frac{1}{4r^2} \quad (3.5.21)$$

$$r = \frac{4r_e}{7\alpha_e^2} \quad (3.5.22)$$

The radius for helium resolves to be 3.02×10^{-11} meters, or 30 pm.

With radius and amplitude factor known, the energy level for helium can now be calculated for the photon energy required to ionize an electron. The amplitude factor was described earlier in this section for helium and is equal to one (1). The radius was solved in Eq. 3.5.22. Using the Transverse Energy Equation (Eq. 1.2.2) this is:

$$E_t = \frac{2\pi\rho K_e^7 \lambda_l^2 c^2 \delta}{A_l} \left(\frac{1}{\infty} - \frac{1}{\frac{4r_e}{7\alpha_e^2}} \right) \quad (3.5.23)$$

The energy required to ionize helium is calculated to be -3.815×10^{-18} joules or 2.299 MJ/mol.

3.6. Amplitude Factor Equation – 1s Orbital Ionization (H to Ca)

A pattern emerges when calculating the two variables required for transverse energy calculation – amplitude factor and distance – for the 1s orbital of the first twenty elements until electrons begin to fill the 3d subshell. An alternative method was then developed to calculate photon energies for these elements without requiring a need to determine the 1s orbital radius.

This **simplified method** is given the name Amplitude Factor Equation – 1s Orbital Ionization. It can be used for any element through calcium knowing the number of protons and electrons for the element. The method works for heavily ionized elements where only one or two electrons exist in the atom, or an atom with its full complement of electrons but energized to 1s energy as found in photoelectron spectroscopy experiments. The method approximates photon energies for:

- **Ionization Energy of 1s² Electron from a Neutral Element (Photoelectron Spectroscopy)** – Removal of the electron from a neutral element, 1s orbital ionization energy captured in photoelectron spectroscopy experiments.
- **Ionization Energy of 1s² Electron of an Ionized Element** – Removal of the 2nd electron in an element that is ionized to only have two electrons (located in the 1s subshell).
- **Ionization Energy of 1s¹ Electron of an Ionized Element** – Removal of the 1st and only electron in an element that is ionized to only have one electron (located in the 1s subshell).

An illustration of these three types is as follows:

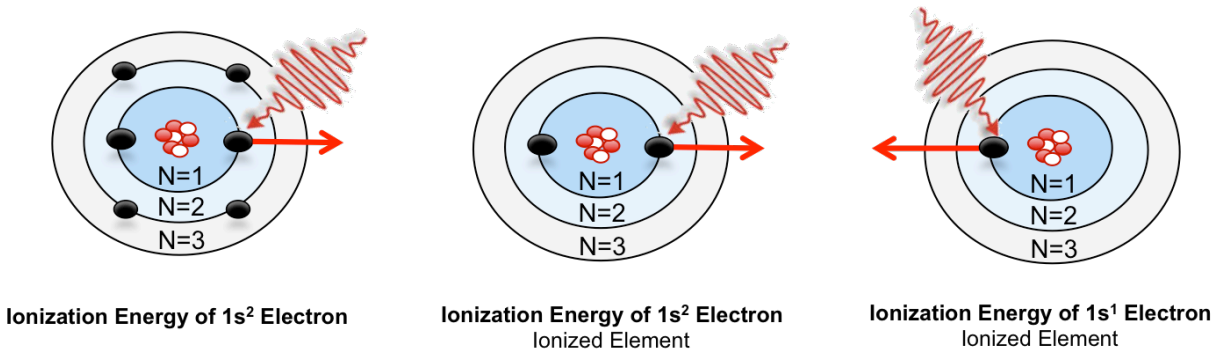

Fig. 3.6.1 – Electron Ionization and Amplitude Factors

The method works by setting the radius to the Bohr radius (a_0) then solving for a modified amplitude factor using Eq. 3.6.1. In the equation, Z is the number of protons in the atom, and e_1 , e_2 , e_3 and e_4 are the number of electrons in the first (1s), second (2s, 2p), third (3s, 3p) and fourth (4s, 4p) orbitals respectively.

$$\delta = \left((Z) - \frac{4}{3} \left(\frac{e_1 - 1}{2} + \frac{e_2}{8} + \frac{1}{2} \left(\frac{e_3}{8} \right) + \frac{1}{3} \left(\frac{e_4}{8} \right) \right) \right)^2 \quad (3.6.1)$$

Amplitude Factor Equation – 1s Orbital Ionization

Results were calculated for hydrogen to calcium and placed in Section 1, although another example will be provided here to demonstrate the calculation using Eq. 3.6.1. Standard calcium (Ca) has 20 protons and 20 electrons. The amplitude factor for this configuration is:

$$\delta_{Ca} = \left(20 - \frac{4}{3} \left(\frac{(2-1)}{2} + \frac{8}{8} + \frac{1}{2} \left(\frac{8}{8} \right) + \frac{1}{3} \left(\frac{2}{8} \right) \right) \right)^2 = 296.605 \quad (3.6.2)$$

This method uses a modified amplitude factor (above) and Bohr radius (a_0) to calculate photon energy. Inserting these values into the Transverse Energy Equation:

$$E_t = \frac{2\pi\rho K_e^7 \lambda_l^2 c^2 \delta_{Ca}}{A_l} \left(\frac{1}{\infty} - \frac{1}{a_0} \right) = 6.466 \cdot 10^{-16} \quad (3.6.3)$$

Eq. 3.6.3 calculates to be 6.466×10^{-16} joules or 389.4 MJ/mol. This is compared to a measured result of 390 MJ/mol. The remaining calculations are found in Section 1.

Why does it stop at calcium? In Fig. 3.6.1, note the order in which electrons fill the subshells in an atom. The first orbital (1s) has two electrons. The next orbitals have eight electrons each in the s and p subshells (e.g. 2s + 2p = 8 electrons). Note the denominator in the Amplitude Factor Equation. The equation stops working at calcium because electrons begin to fill subshell 3d before they fill subshell 4p.

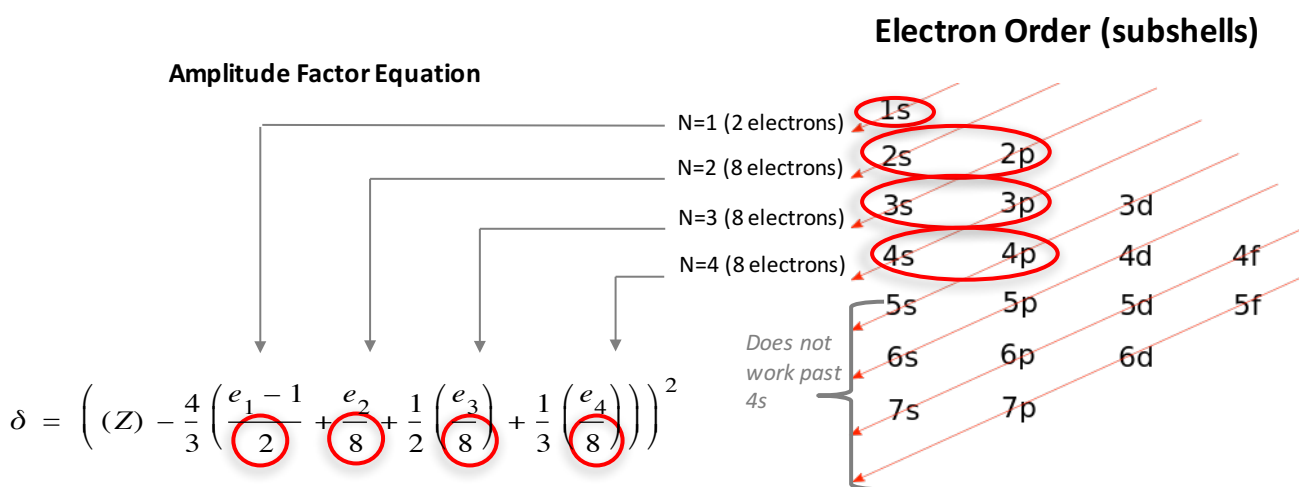

Fig 3.6.1 – Amplitude Factor Equation – 1s Orbital Ionization works for the first 20 atomic elements.

4. Methodology for Determining Energy Wave Equation Constants

This section describes the methodology that was used to find the constants that are used in the energy wave equations: 1) longitudinal amplitude, 2) longitudinal wavelength and 3) density. The fourth constant that is critical in these equations is already well known – the speed of light constant which is the speed at which waves travel through the universe.

4.1. Longitudinal Wavelength Constant

Longitudinal wavelength is based on the classical radius of the electron (r_e). When modeling the electron based on standing waves of energy, using the Longitudinal Energy Equation, it was assumed that amplitude and wavelength were proportional to the number of particle wave centers (K). Particles have a core at K times wavelengths and a radius at K^2 times wavelengths (λ_l). With the neutrino assumed as the fundamental particle, the electron fits the equation at $K=10$, or ten particle wave centers. Knowing the classical radius of the electron, and the value K for the electron, wavelength can be solved using the assumption of radius - $K_e^2 \lambda_l$.

The following is the calculation of Longitudinal Wavelength (λ_l) in meters:

$$\lambda_l = \frac{r_e}{K_e^2} \quad (4.1.1)$$

$$\lambda_l = \frac{2.817940327 \cdot 10^{-15}}{10^2} \quad (4.1.2)$$

Calculated Value: $2.817940327 \times 10^{-17}$ (m)

4.2. Longitudinal Amplitude Constant

Knowing the longitudinal wavelength constant, the longitudinal amplitude was solved using the derivation of the fine structure constant, found in the *Fundamental Physical Constants* paper. The derivation for the fine structure constant is in Eq. 4.2.1:

$$\alpha_e = \frac{\pi K_e^4 A_l^6 O_e}{\lambda_l^3 \delta_e} \quad (4.2.1)$$

As all of the constants are known in Eq. 4.2.1 (including longitudinal wavelength from Eq. 4.1.2), longitudinal amplitude is isolated from the equation and then solved.

$$A_l = \left(\frac{\alpha_e \lambda_l^3 \delta_e}{\pi K_e^4 O_e} \right)^{1/6} \quad (4.2.2)$$

Calculated Value: $3.662796647 \times 10^{-10}$ (m)

4.3. Density Constant

Density was calculated using the well-known value for the Planck constant ($6.62607004081 \times 10^{-34}$) that was derived in *Fundamental Physical Constants* (see Eq. 4.3.1). Planck constant is related to constants already solved above, so density (ρ , in kg/m^3), can be isolated and solved in Eq. 4.3.2.

$$h = \frac{8}{3} \pi \rho K_e^3 \lambda_l c \delta_e \quad (4.3.1)$$

$$\rho = \frac{3}{8 \pi K_e^3 \lambda_l c \delta_e} \quad (4.3.2)$$

Calculated Value: $9.422369691 \times 10^{-30}$ (kg/m^3)

Note: A density of $9.422 \times 10^{-30} \text{ kg} / \text{m}^3$ is slightly less dense than the critical density of the universe (although it is not certain that density is consistent across the universe).

5. Conclusion

Today's classical and quantum equations are undoubtedly correct. Countless experiments have verified the accuracy of these equations from the energies of various atoms and molecules to the specific energy of a photon at various wavelengths. However, there remains a separation of equations for the subatomic (quantum mechanics) and for the world larger than the size of these atoms (classical mechanics).

The conclusion of this paper is that there is indeed one fundamental set of rules and equations that govern everything in the universe, regardless of size. In this view of the universe, all energy comes in the form of waves, either longitudinal or transverse forms. Further, various particles seen both in nature and in experiments are a result of a combination of wave centers, combining to form a particle, whose stability is dependent on the ability to have a core structure in which wave centers can reside at the nodes of a three-dimensional wave to maintain stability. It is proposed that the neutrino may be the fundamental wave center.

The following evidence was presented in support of the new, proposed energy wave equations:

- Calculated the energy and mass of particles, including the lepton family which coincides with magic numbers also seen in atomic elements.
- Calculated the wavelengths of photons from hydrogen, both ionization and transitions between orbitals.
- Calculated the photon ionization energies of the first twenty elements using the Transverse Energy Equation, using different configurations of electrons in each element to prove that wave amplitude and distance are the variables in the equation that governs transverse energy.
- Finally, the electron classical radius, electron Compton wavelength, Rydberg constant, and Bohr radius were naturally derived with wave constants proposed in this paper.

This paper concludes that all energy comes from an energy wave equation and that classical and quantum energy equations are one - simply a difference of frequency or amplitude experienced by particles. Quantum jumps were further explained as the electron's movement between orbitals as it is both attracted and repelled by the nucleus, where its orbit is a gap when the sum of attractive and repelling forces is zero.

There is sufficient data, with reasonable explanation, that these energy wave equations should be seriously considered. The fact that the neutrino may be the building block of other particles should also be considered. These findings provide the basis of a new, encouraging way to explain subatomic particles and their interactions.

There is potential work that may prove or expand upon the theory presented in this paper, such as:

- If all of the magic numbers from the Periodic Table of Elements hold true for leptons, there may be a neutrino at $K=2$ (1.76×10^{-17} joules). Locating this neutrino may provide additional proof.
- Determining the structure of the proton with both attracting and repelling forces would be further proof. It is assumed that there is a positron in the proton's core that is responsible for the attractive force. In high-energy proton collisions that break quark confinement, it is possible that positrons (and electrons) may be found in the quark-gluon plasma.
- This paper has calculated the photon ionization energies of the first twenty elements for the first orbital. The atomic radii and photon energies for all of the orbitals has been calculated and will be published in a future paper. However, electron configuration for elements beyond calcium, requiring the positions of the d and f orbitals, needs to be established to continue this work.

Acknowledgements

These findings would not be possible without the research of the late Dr. Milo Wolff, Gabriel LaFreniere and Xavier Borg from whom this theory is based upon as a derivative of the Wave Structure of Matter (WSM). Special thanks to Dr. Karoly Kehrer, Susan C. Barlow, Declan Traill, Gary Simpson and members of the WSM group for reviewing components of this theory and providing valuable feedback. Lastly, my sincere appreciation to my family, who were considerably patient and understanding while I worked on this paper.

References

- ¹ “Constants of Physics and Mathematics”, Extra Byte, <http://www.ebyte.it/library/educards/constants/ConstantsOfPhysicsAndMath.html> (Accessed February 11, 2017)
- ² “Subatomic Particles”, National Physical Laboratory, http://www.kayelaby.npl.co.uk/atomic_and_nuclear_physics/4_8/4_8_4.html (Accessed February 11, 2017)
- ³ “Forces: Explained and Derived by Energy wave equations.” Vixra. <http://vixra.org/abs/1606.0112>
- ⁴ “Photoelectron spectroscopy”. Arizona University Chemistry. <http://cbc.arizona.edu/chemt/Flash/photoelectron.html>
- ⁵ “Huygen-Fresnel Principle.” Wikipedia. https://en.wikipedia.org/wiki/Huygens%E2%80%93Fresnel_principle
- ⁶ “The Standard Model Part I.” Real Clear Science. <http://www.realclearscience.com/blog/2012/03/the-standard-model-part-i.html>
- ⁷ “Fundamental Physical Constants: Explained and Derived by Energy wave equations.” Vixra. <http://vixra.org/abs/1606.0113>
- ⁸ “Molar Ionization Energies of the Elements.” Wikipedia. https://en.wikipedia.org/wiki/Molar_ionization_energies_of_the_elements
- ⁹ “Rydberg Formula.” Wikipedia. https://en.wikipedia.org/wiki/Rydberg_formula
- ¹⁰ “Measured Hydrogen Spectrum.” Hyperphysics. <http://hyperphysics.phy-astr.gsu.edu/hbase/hyde.html>
- ¹¹ “Pair Production Process.” Wikipedia. http://en.wikipedia.org/wiki/Pair_production
- ¹² “Proton”. Wikipedia. <https://en.wikipedia.org/wiki/Proton>
- ¹³ “Pentaquark”. Wikipedia. <https://en.wikipedia.org/wiki/Pentaquark>
- ¹⁴ “Beta Decay”. Wikipedia. https://en.wikipedia.org/wiki/Beta_decay