

“Emission & Regeneration” Unified Field Theory.

Oswaldo Domann

odomann@yahoo.com

Last revision February 2016

(This paper is an extract of [10] listed in section Bibliography.)

Copyright. All rights reserved.

Abstract

The methodology of today’s theoretical physics consists in introducing first all known forces by separate definitions independent of their origin, arriving then to quantum mechanics after postulating the particle’s wave, and is then followed by attempts to infer interactions of particles and fields postulating the invariance of the wave equation under gauge transformations, allowing the addition of minimal substitutions.

The origin of the limitations of our standard theoretical model is the assumption that the energy of a particle is concentrated at a small volume in space. The limitations are bridged by introducing artificial objects and constructions like particles wave, gluons, strong force, weak force, gravitons, dark matter, dark energy, big bang, etc.

The proposed approach models subatomic particles such as electrons and positrons as focal points in space where continuously fundamental particles are emitted and absorbed, fundamental particles where the energy of the electron or positron is stored as rotations defining longitudinal and transversal angular momenta (fields). Interaction laws between angular momenta of fundamental particles are postulated in that way, that the basic laws of physics (Coulomb, Ampere, Lorentz, Maxwell, Gravitation, bending of particles and interference of photons, Bragg, etc.) can be derived from the postulates. This methodology makes sure, that the approach is in accordance with the basic laws of physics, in other words, with well proven experimental data.

Due to the dynamical description of the particles the proposed approach has not the limitations of the standard model and is not forced to introduce artificial objects or constructions.

Contents

1	Introduction.	4
2	Space distribution of the energy of basic subatomic particles.	6
3	Definition of the field magnitudes dH_s and dH_n.	8
4	Linear momentum generated out of opposed angular momenta.	9
5	Interaction laws for field components and generation of linear momentum.	10
6	Fundamental equations for the calculation of linear momenta between subatomic particles.	12
7	Force quantification and the radius of a BSPs.	13
8	Analysis of linear momentum between two static BSPs.	14
9	Stern-Gerlach experiment and the spin of an electron	18
10	Ampere bending (Bragg law).	19
11	Induction between a moving and a probe BSP.	20
12	Newton gravitation force.	21
13	Ampere gravitation force.	24
13.1	Flattening of galaxies' rotation curve.	27
14	Quantification of irradiated energy and movement.	29
14.1	Quantification of irradiated energy.	29
14.1.1	Fundamental equations expressed as functions of the powers exchanged by the BSPs.	31
14.1.2	Physical interpretation of an electron and positron as radiating and absorbing FPs:	33
14.2	Energy and density of Fundamental Particles.	34
14.2.1	Energy of Fundamental Particles.	34
14.2.2	Density of Fundamental Particles.	35
14.3	Quantification of movement.	36

15 Quantification of forces between BSPs and CSPs.	37
15.1 Quantification of the Coulomb force.	38
15.2 Quantification of the Ampere force between straight infinite parallel conductors.	38
15.3 Quantification of the induced gravitation force (Newton).	39
15.4 Quantification of the gravitation force due to parallel reintegrating BSPs (Ampere).	40
15.5 Quantification of the total gravitation force.	41
16 Conventions introduced for BSPs.	42
17 Flux density of FPs and scattering of particles.	44
17.1 Flux density of FPs.	44
17.2 Scattering of particles.	45
17.3 Feynman diagram.	48
18 Emission Theory.	49
18.1 Sagnac effect.	51
19 BSP with light speed.	54
19.1 Redshift of the energy of a complex BSP with light speed (photon) in the presence of matter.	56
19.1.1 Refraction and red-shift at the sun.	57
19.1.2 Cosmic Microwave Background radiation.	58
20 Interpretation of Data in a theoretical frame.	58
21 Findings of the proposed approach.	60
Bibliography	62

1 Introduction.

An axiomatic approach was used for the deduction of the “Emission & Regeneration” Field Theory. To find the laws of interactions between the angular momenta of Fundamental Particles (FPs) a recursive procedure was followed until the well proven laws of physics, which describe the forces between particles, were obtained.

Fig. 1 shows schematically the difference between the proposed approach and the mainstream theory.

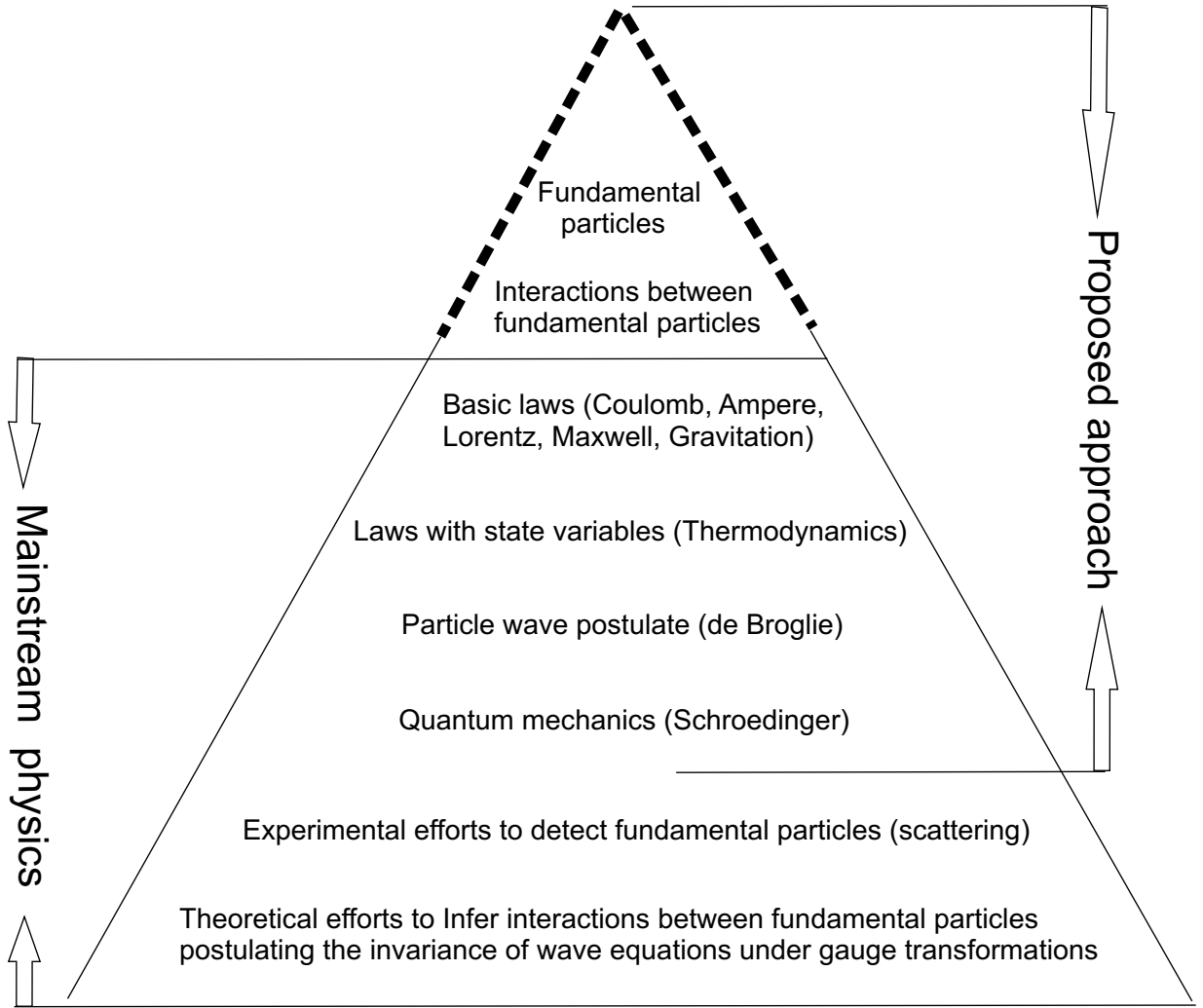

Figure 1: Methodology followed by the present approach

The approach is based on the following main conceptual steps:

The energy of an electron or positron is modeled as being distributed in the space around the particle’s radius r_o and stored in fundamental particles (FPs) with longitudinal and transversal angular momenta. FPs are emitted continuously with the speed $v_e \bar{s}_e$ and regenerate the electron or positron continuously with the speed $v_r \bar{s}$. There are two types of FPs, one type that moves with light speed and the other type that

moves with nearly infinite speed relative to the focal point of the electron or positron.
 The concept is shown in Fig. 2.

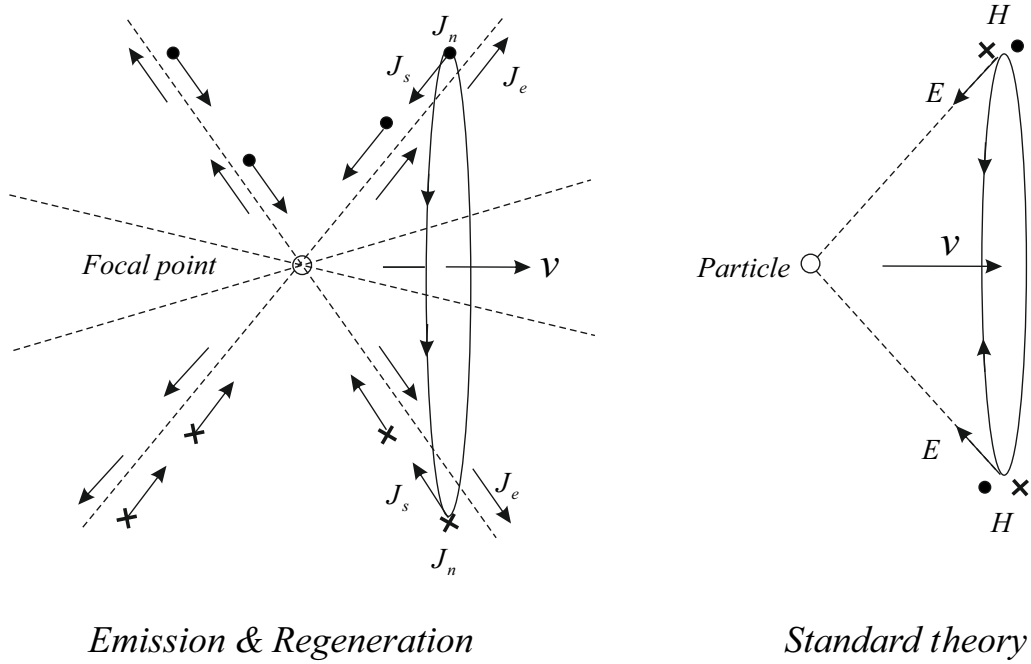

Figure 2: Particle as focal point in space

Electrons and positrons emit and are regenerated always by different types of FPs (see sec. 16) resulting the accelerating and decelerating electrons and positrons which have respectively regenerating FPs with light and infinite speed.

The density of FPs around the particle's radius r_o has a radial distribution and follows the inverse square distance law.

The concept is shown in Fig. 3

Field magnitudes $d\bar{H}$ are defined as square roots of the energy stored in the FPs. Interaction laws between the fields $d\bar{H}$ of electrons and positrons are defined to obtain pairs of opposed angular momenta \bar{J}_n on their regenerating FPs, pairs that generate linear momenta \bar{p}_{FP} responsible for the forces.

Based on the conceptual steps, equations for the vector fields $d\bar{H}$ are obtained that allow the deduction of all experimentally proven basic laws of physics, namely, Coulomb, Ampere, Lorentz, Gravitation, Maxwell, Bragg, Stern Gerlach and the flattening of galaxies' rotation curve.

Note: In this approach

Basic Subatomic Particles (**BSPs**) are:

- for $v < c$ the electron and the positron
- for $v = c$ the neutrino

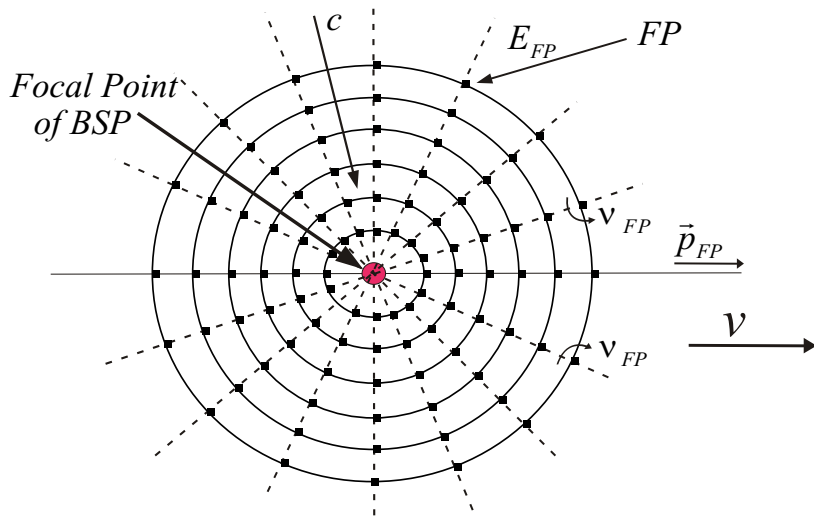

$$dE = dN_{FP} E_{FP} \quad dN_{FP} = \omega_{FP} dV = \frac{1}{2\pi} \frac{E}{E_{FP}} d\kappa$$

Figure 3: Regenerating Fundamental Particles of a BSP

Complex Subatomic Particles (CSPs) are:

- for $v < c$ the proton, the neutron and nuclei of atoms.
- for $v = c$ the photon.

BSPs and CSPs with speeds $v < c$ emit and are regenerated by FPs that are provided by the emissions of other BSPs and CSPs with speeds $v < c$.

BSPs and CSPs with $v = c$ don't emit and are not regenerated by FPs and move therefore independent from other particles.

2 Space distribution of the energy of basic subatomic particles.

The total energy of a basic subatomic particle (BSP) with constant $v \neq c$ is

$$E = \sqrt{E_o^2 + E_p^2} \quad E_o = m c^2 \quad E_p = p c \quad p = \frac{m v}{\sqrt{1 - \frac{v^2}{c^2}}} \quad (1)$$

The total energy $E = E_e$ is split in

$$E_e = E_s + E_n \quad \text{with} \quad E_s = \frac{E_o^2}{\sqrt{E_o^2 + E_p^2}} \quad \text{and} \quad E_n = \frac{E_p^2}{\sqrt{E_o^2 + E_p^2}} \quad (2)$$

and differential emitted dE_e and regenerating dE_s and dE_n energies are defined

$$dE_e = E_e d\kappa = \nu J_e \quad dE_s = E_s d\kappa = \nu J_s \quad dE_n = E_n d\kappa = \nu J_n \quad (3)$$

with the distribution equation

$$d\kappa = \frac{1}{2} \frac{r_o}{r^2} dr \sin \varphi d\varphi \frac{d\gamma}{2\pi} \quad (4)$$

The distribution equation $d\kappa$ gives the part of the total energy of a BSP moving with $v \neq c$ contained in the differential volume $dV = dr r d\varphi r \sin \varphi d\gamma$.

The concept is shown in Fig. 4.

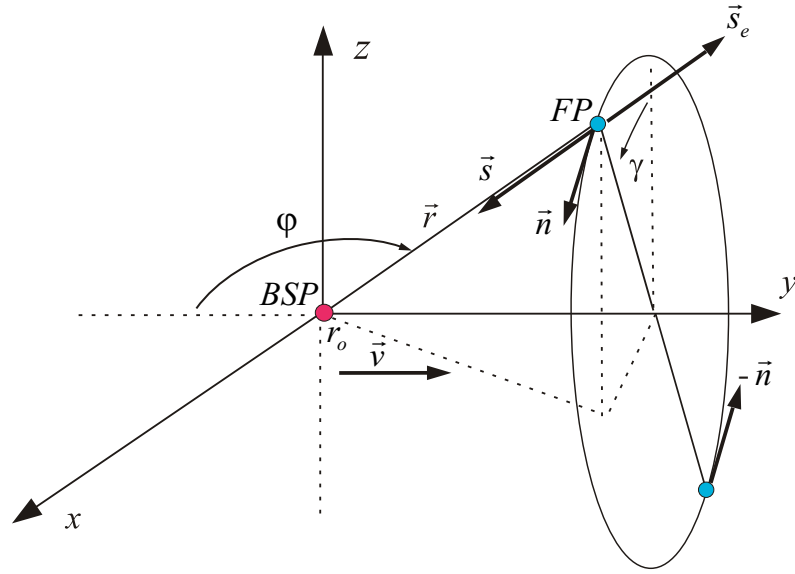

Figure 4: Unit vector \bar{s}_e for an emitted FP and unit vectors \bar{s} and \bar{n} for a regenerating FP of a BSP moving with $v \neq c$

The differential energies are stored as rotations in the FPs which define the longitudinal angular momenta $\bar{J}_e = J_e \bar{s}_e$ of emitted FPs and the longitudinal $\bar{J}_s = J_s \bar{s}$ and transversal $\bar{J}_n = J_n \bar{n}$ angular momenta of regenerating FPs (see also Fig. 2).

The rotation sense in moving direction of emitted longitudinal angular momenta \bar{J}_e defines the sign of the charge of a BSP. Rotation senses of \bar{J}_e and \bar{J}_s are always opposed. The direction of the transversal angular momentum \bar{J}_n is the direction of a right screw that advances in the direction of the velocity v and is independent of the sign of the charge of the BSP.

Conclusion: The elementary charge is replaced by the energy (or mass) of a resting electron ($E_e = 0.511 \text{ MeV}$). The charge of a complex SP (e.g. proton) is given by the difference between the **constituent** numbers of BSPs with positive $\bar{J}_e^{(+)}$ and negative $\bar{J}_e^{(-)}$ that integrate the complex SP, multiplied by the energy of a resting electron. As

examples we have for the proton with $n^+ = 919$ and $n^- = 918$ and a binding energy of $E_{B_{prot}} = -0.43371 \text{ MeV}$ a charge of $(n^+ - n^-) * 0.511 = 0.511 \text{ MeV}$, and for the neutron with $n^+ = 919$ and $n^- = 919$ and a binding energy of $E_{B_{neutr}} = 0.34936 \text{ MeV}$ a charge of $(n^+ - n^-) * 0.511 = 0.0 \text{ MeV}$.

The unit of the charge thus is the Joule (or kg). The conversion from the electric current I_c (Ampere) to the mass current I_m is given by

$$I_m = \frac{m}{q} I_c = 5,685631378 \cdot 10^{-12} I_c \left[\frac{kg}{s} \right] \quad (5)$$

with m the electron mass in kilogram and q the elementary charge in Coulomb.

Note: The Lorentz invariance of the charge from today's theory has its equivalent in the invariance of the difference between the **constituent** numbers of BSPs with positive $\bar{J}_e^{(+)}$ and negative $\bar{J}_e^{(-)}$ that integrate the complex SP, multiplied by the energy of a resting electron. In the present paper the denomination **charge** will be used according the previous definition.

3 Definition of the field magnitudes dH_s and dH_n .

The field dH at a point in space is defined as that part of the square root of the energy of a BSP that is given by the distribution equation $d\kappa$. The differential values dE and dH refer to the differential volume $dV = dr r d\varphi r \sin \varphi d\gamma$ (see also eq. (2)). For the emitted field we have

$$d\bar{H}_e = H_e d\kappa \bar{s}_e \quad \text{with} \quad H_e^2 = E_e \quad (6)$$

The longitudinal component of the regenerating field at a point in space is defined as

$$d\bar{H}_s = H_s d\kappa \bar{s} \quad \text{with} \quad H_s^2 = E_s = \frac{E_o^2}{\sqrt{E_o^2 + E_p^2}} \quad (7)$$

The transversal component of the regenerating field at a point in space is defined as

$$d\bar{H}_n = H_n d\kappa \bar{n} \quad \text{with} \quad H_n^2 = E_n = \frac{E_p^2}{\sqrt{E_o^2 + E_p^2}} \quad (8)$$

For the total field magnitude H_e it is

$$H_e^2 = H_s^2 + H_n^2 \quad \text{with} \quad H_e^2 = E_e \quad (9)$$

The vector \bar{s}_e is an unit vector in the moving direction of the emitted FP (Fig. 4). The vector \bar{s} is an unit vector in the moving direction of the regenerating FP. The vector \bar{n} is an unit vector transversal to the moving direction of the regenerating FP and oriented according the right screw rule relative to the velocity \bar{v} of the BSP.

Conclusion: BSPs are structured particles with emitted and regenerating FPs with longitudinal and transversal angular momenta. The rotation sense of the angular momenta of the emitted FPs defines the sign of the charge of the BSP. The longitudinal angular momenta of the regenerating FPs define the rest energy and the transversal angular momenta of the regenerating FPs define the kinetic energy of the BSP.

4 Linear momentum generated out of opposed angular momenta.

Linear momentum out of opposed angular momenta

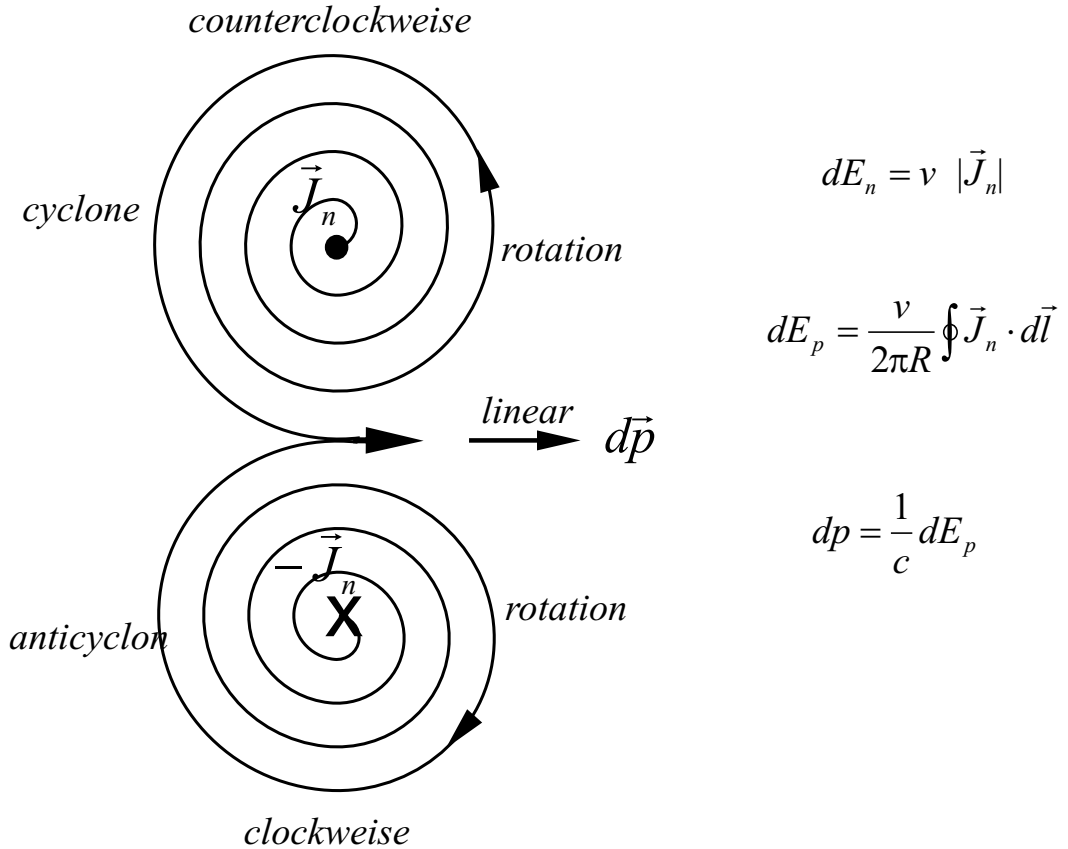

Figure 5: Generation of linear momentum out of opposed angular momenta

Fig. 5 shows how the linear momentum dp is calculated out of the opposed angular momenta \bar{J}_n and $-\bar{J}_n$ for a single moving subatomic particle (SP). For the single particle it is $dp = 0$ what means that $p = mv$ is constant in time.

Two SPs interact trough the cross or scalar products of the angular momenta of their FPs. For SP “1” and SP “2” we can write in a general form:

$$J \bar{e} = \sqrt{J_1} \bar{e}_1 \times \sqrt{J_2} \bar{e}_2 \quad (10)$$

with \bar{e} the unit vector. With $dE_i = \nu J_i = E_i d\kappa_i$ and $E_i = E_i(v)$ and $d\kappa = d\kappa(r_o, r, \varphi, \gamma)$ we get

$$dE \bar{e} = \sqrt{E_1} d\kappa_1 \bar{e}_1 \times \sqrt{E_2} d\kappa_2 \bar{e}_2 \quad (11)$$

and with $dH_i = \sqrt{E_i} d\kappa_i$ we get

$$dE \bar{e} = dH_1 \bar{e}_1 \times dH_2 \bar{e}_2 = d\bar{H} \times d\bar{H}_2 \quad (12)$$

We define that

$$dE'_p \bar{e} = \sqrt{E_1} \int_{r_o}^{\infty} d\kappa_1 \bar{e}_1 \times \sqrt{E_2} \int_{r_o}^{\infty} d\kappa_2 \bar{e}_2 = \int_{r_o}^{\infty} d\bar{H}_1 \times \int_{r_o}^{\infty} d\bar{H}_2 \quad (13)$$

and that

$$dE_p = \frac{1}{2\pi R} \oint dE'_p \bar{e} \cdot d\bar{l} \quad dp = \frac{1}{c} dE_p \quad dF = \frac{dp}{dt} \quad (14)$$

Note: For the Coulomb interaction $\bar{e}_i = \bar{s}_i$. For the Ampere interaction $\bar{e}_i = \bar{n}_i$ and for the inductive interaction $\bar{e}_1 = \bar{n}_1$ and $\bar{e}_2 = \bar{s}_2$ and the cross product has to be changed to the scalar product.

5 Interaction laws for field components and generation of linear momentum.

The interaction laws for the field components $d\bar{H}_s$ and $d\bar{H}_n$ are derived from the following interaction postulates for the longitudinal \bar{J}_s and transversal \bar{J}_n angular momenta.

1) If two fundamental particles from two static BSPs cross, their longitudinal rotational momenta J_s generate the following transversal rotational momentum

$$\bar{J}_{n_1}^{(s)} = - \text{sign}(\bar{J}_{s_1}) \text{sign}(\bar{J}_{s_2}) (\sqrt{J_{s_1}} \bar{s}_1 \times \sqrt{J_{s_2}} \bar{s}_2) \quad (15)$$

If both sides of eq. (15) are multiplied with $\sqrt{\nu_{s_1} d\kappa_1}$ and $\sqrt{\nu_{s_2} d\kappa_2}$, with ν_s the rotational frequency, results the differential energy

$$dE_{n_1}^{(s)} = \left| \sqrt{\nu_{s_1} J_{s_1} d\kappa_1} \bar{s}_1 \times \sqrt{\nu_{s_2} J_{s_2} d\kappa_2} \bar{s}_2 \right| \quad (16)$$

or

$$dE_{n_1}^{(s)} = |dH_{s_1} \bar{s}_1 \times dH_{s_2} \bar{s}_2| \quad \text{with} \quad dH_{s_i} \bar{s}_i = \sqrt{\nu_{s_i} J_{s_i} d\kappa_i} \bar{s}_i \quad (17)$$

If at the same time two other fundamental particles from the same two static BSPs generate a transversal rotational momentum $-\bar{J}_{n_1}^{(s)}$, so that the components of the pair are equal and opposed, the generated linear momentum on the two BSPs is

$$dp = \frac{1}{c} dE_p^{(s)} \quad \text{with} \quad dE_p^{(s)} = \left| \int_{r_{r_1}}^{\infty} dH_{s_1} \bar{s}_1 \times \int_{r_{r_2}}^{\infty} dH_{s_2} \bar{s}_2 \right| \quad (18)$$

2) If two fundamental particles from two moving BSPs cross, their transversal rotational momenta J_n generate the following rotational momentum.

$$\bar{J}_1^{(n)} = -\text{sign}(\bar{J}_{s_1}) \text{sign}(\bar{J}_{s_2}) (\sqrt{J_{n_1}} \bar{n}_1 \times \sqrt{J_{n_2}} \bar{n}_2) \quad (19)$$

If both sides of the equation are multiplied with $\sqrt{\nu_{n_1} d\kappa_1}$ and $\sqrt{\nu_{n_2} d\kappa_2}$, with ν_n the rotational frequency, and the absolute value is taken, it is

$$dE_1^{(n)} = |dH_{n_1} \bar{n}_1 \times dH_{n_2} \bar{n}_2| \quad \text{with} \quad dH_{n_i} \bar{n}_i = \sqrt{\nu_{n_i} J_{n_i} d\kappa_i} \bar{n}_i \quad (20)$$

If at the same time two other fundamental particles from the same two moving BSPs cross, and their transversal rotational momenta generate a rotational momentum $-\bar{J}_1^{(n)}$, so that the components of the pair are equal and opposed, the generated linear momentum on the two BSPs is

$$dp = \frac{1}{c} dE_p^{(n)} \quad \text{with} \quad dE_p^{(n)} = \left| \int_{r_{r_1}}^{\infty} dH_{n_1} \bar{n}_1 \times \int_{r_{r_2}}^{\infty} dH_{n_2} \bar{n}_2 \right| \quad (21)$$

3) If a FP 1 with an angular momentum \bar{J}_1 crosses with a FP 2 with a longitudinal angular momentum \bar{J}_{s_2} , the orthogonal component of \bar{J}_1 to \bar{J}_{s_2} is transferred to the FP 2, if at the same instant between two other FPs 3 and 4 an orthogonal component is transferred which is opposed to the first one. (see Fig. 11)

6 Fundamental equations for the calculation of linear momenta between subatomic particles.

The Fundamental equations for the calculation of linear momenta according to the interaction postulates are:

a) The equation for the calculation of linear momentum between two static BSPs according postulate **1**) is

$$dp_{stat} \bar{s}_R = \frac{1}{c} \oint_R \left\{ \frac{\bar{dl} \cdot (\bar{s}_{e_1} \times \bar{s}_{s_2})}{2\pi R} \int_{r_1}^{\infty} H_{e_1} d\kappa_{r_1} \int_{r_2}^{\infty} H_{s_2} d\kappa_{r_2} \right\} \bar{s}_R \quad (22)$$

where $H_{e_1} d\kappa_{r_1} \bar{s}_{e_1}$ is the longitudinal field of the emitted FPs of particle 1 and $H_{s_2} d\kappa_{r_2} \bar{s}_{s_2}$ is the longitudinal field of the regenerating FPs of particle 2. The unit vector \bar{s}_R is orthogonal to the plane that contains the closed path with radius R .

The linear momentum generated between two static BSPs is the origin of all movements of particles. The law of Coulomb is deduced from eq. (22) and because of its importance is analyzed in sec. 8.

b) The equation for the calculation of linear momentum between two moving BSPs according to postulate **2**) is

$$dp_{dyn} \bar{s}_R = \frac{1}{c} \oint_R \left\{ \frac{\bar{dl} \cdot (\bar{n}_1 \times \bar{n}_2)}{2\pi R} \int_{r_1}^{\infty} H_{n_1} d\kappa_{r_1} \int_{r_2}^{\infty} H_{n_2} d\kappa_{r_2} \right\} \bar{s}_R \quad (23)$$

where $H_{n_1} d\kappa_{r_1} \bar{n}_1$ is the transversal field of the regenerating FPs of particle 1 and $H_{n_2} d\kappa_{r_2} \bar{n}_2$ is the transversal field of the regenerating FPs of particle 2.

The laws of Lorentz, Ampere and Bragg are deduced from equation (23).

c) The equations for the calculation of the induced linear momentum between a moving and a static probe BSP_p according to postulate **3**) are

$$dp_{ind}^{(s)} \bar{s}_R = \frac{1}{c} \oint_R \left\{ \frac{\bar{dl} \cdot \bar{s}}{2\pi R} \int_{r_r}^{\infty} H_s d\kappa_{r_r} \int_{r_p}^{\infty} H_{s_p} d\kappa_{r_p} \right\} \bar{s}_R \quad (24)$$

$$dp_{ind}^{(n)} \bar{s}_R = \frac{1}{c} \oint_R \left\{ \frac{\bar{dl} \cdot \bar{n}}{2\pi R} \int_{r_r}^{\infty} H_n d\kappa_{r_r} \int_{r_p}^{\infty} H_{s_p} d\kappa_{r_p} \right\} \bar{s}_R \quad (25)$$

The upper indexes (s) or (n) denote that the linear momentum $d' p_{ind}$ on the static probe BSP_p (subindex s_p) is induced by the longitudinal (s) or transversal (n) field component of the moving BSP.

The Maxwell and the gravitation laws are deduced from equations (24) and (25).

The total linear momentum for all equations is given by

$$\bar{p} = \int_{\sigma} dp \bar{s}_R \quad (26)$$

where \int_{σ} symbolizes the integration over the whole space.

Conclusion: All forces can be expressed as rotors from the vector field $d\bar{H}$ generated by the longitudinal and transversal angular momenta of the two types of fundamental particles defined in chapter 1.

$$d\bar{F} = \frac{dp}{dt} = \frac{1}{8\pi} \sqrt{m} r_o \text{rot} \frac{d}{dt} \int_{r_r}^{\infty} d\bar{H} \quad (27)$$

7 Force quantification and the radius of a BSPs.

The relation between the force and the linear momentum for all the fundamental equations of chapter 6 is given by

$$\bar{F} = \frac{\Delta p}{\Delta t} \bar{s}_R \quad \text{with} \quad \Delta p = p - 0 = p \quad (28)$$

The force is quantized in force quanta

$$F = \Delta p \nu \quad \text{with} \quad \nu = \frac{1}{\Delta t} \quad (29)$$

and Δp the quantum of action.

The time Δt between the two BSPs is defined as

$$\Delta t = K r_{o_1} r_{o_2} \quad \text{where} \quad K = 5.4271 \cdot 10^4 \left[\frac{s}{m^2} \right] \quad (30)$$

is a constant and r_{o_1} and r_{o_2} are the radii of the BSPs.

The constant K results when eqs. (22) and (23) are equalized respectively with the Coulomb and the Ampere equations

$$F_{stat} = \frac{1}{4\pi\epsilon_o} \frac{Q_1 Q_2}{d^2} \quad F_{dyn} = \frac{\mu_o}{2\pi} \frac{I_1 I_2}{d} \quad (31)$$

The radius r_o of a particle is given by

$$r_o = \frac{\hbar c}{E} \quad \text{with} \quad E = \sqrt{E_o^2 + E_p^2} \quad \text{for BSPs with } v \neq c \quad (32)$$

and

$$E = \hbar\omega \quad \text{for BSPs with } v = c \quad (33)$$

and is derived from the quantified far field of the irradiated energy of an oscillating BSP [10].

8 Analysis of linear momentum between two static BSPs.

In this section the static eq.(22) is analyzed in order to explain

- why BSPs of equal sign don't repel in atomic nuclei
- how gravitation forces are generated
- why atomic nuclei radiate

Although the analysis is based only on the static eq.(22) for two BSPs, neglecting the influence of the important dynamic eq.(23) that explains for instance the magnetic moment of nuclei, it shows already the origin of the above listed phenomena.

With the integration limits shown in Fig. 6 and considering that for static BSPs it is $r_{o1} = r_{o2} = r_o$ and $m_1 = m_2 = m$, the integration limits are

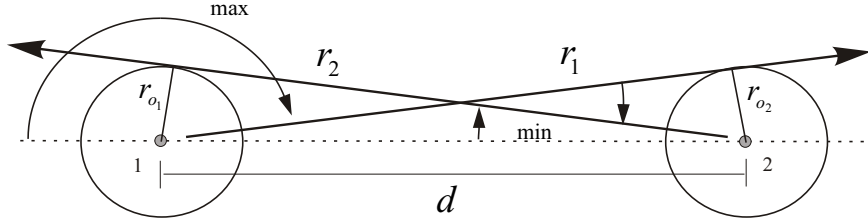

Figure 6: Integration limits for the calculation of the linear momentum between two static basic subatomic particles at the distance d

$$\varphi_{min} = \arcsin \frac{r_o}{d} \quad \varphi_{max} = \pi - \varphi_{min} \quad \text{for } d \geq \sqrt{r_o^2 + r_o^2} \quad (34)$$

$$\varphi_{min} = \arccos \frac{d}{2 r_o} \quad \varphi_{max} = \pi - \varphi_{min} \quad \text{for } d < \sqrt{r_o^2 + r_o^2} \quad (35)$$

and eq.(22) transforms to

$$p_{stat} = \frac{m c r_o^2}{4 d^2} \int_{\varphi_{1min}}^{\varphi_{1max}} \int_{\varphi_{2min}}^{\varphi_{2max}} |\sin^3(\varphi_1 - \varphi_2)| d\varphi_2 d\varphi_1 \quad (36)$$

The double integral becomes zero for $d \rightarrow 0$ because the integration limits approximate each other taking the values $\varphi_{min} = \frac{\pi}{2}$ and $\varphi_{max} = \frac{\pi}{2}$. For $d \gg r_o$ the double integral becomes a constant because the integration limits tend to $\varphi_{min} = 0$ and $\varphi_{max} = \pi$.

Fig.7 shows the curve of eq.(22) where five regions can be identified with the help of $d/r_o = \gamma$ from the integration limits:

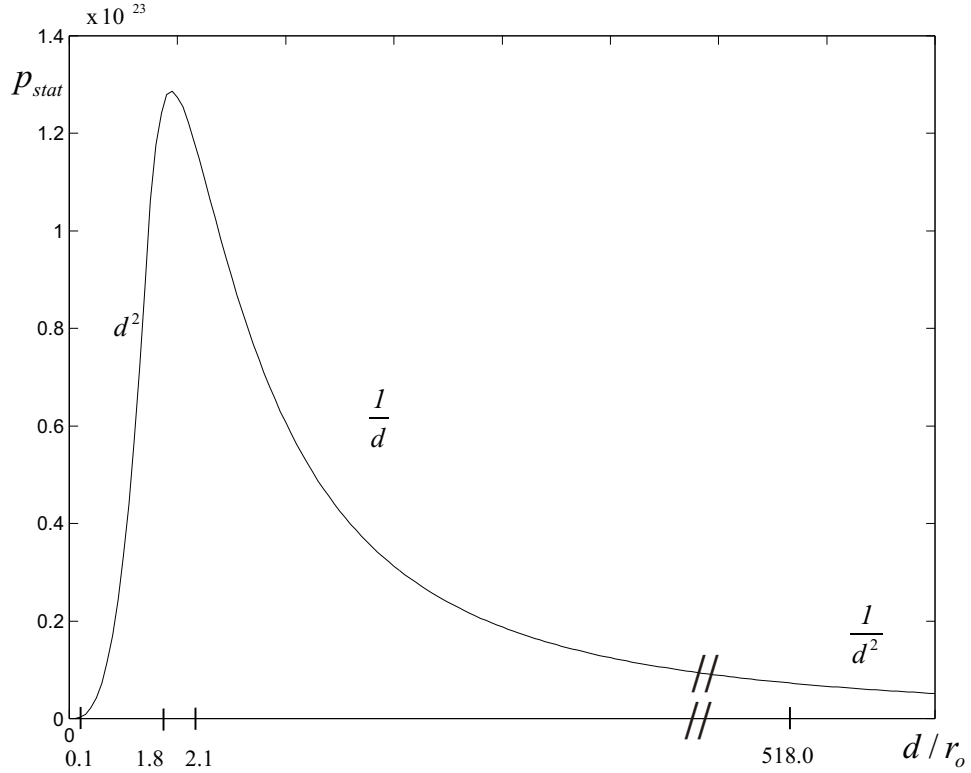

Figure 7: Linear momentum p_{stat} as function of $\gamma = d/r_o$ between two static BSPs with maximum at $\gamma = 2$

1. From $0 \ll \gamma \ll 0.1$ where $p_{stat} = 0$
2. From $0.1 \ll \gamma \ll 1.8$ where $p_{stat} \propto d^2$
3. From $1.8 \ll \gamma \ll 2.1$ where $p_{stat} \approx constant$
4. From $2.1 \ll \gamma \ll 518$ where $p_{stat} \propto \frac{1}{d}$
5. From $518 \ll \gamma \ll \infty$ where $p_{stat} \propto \frac{1}{d^2}$ (Coulomb)

See also Fig. 9.

The **first and second regions** are where the BSPs that form the atomic nucleus are confined and in a dynamic equilibrium. BSPs of different sign of charge don't mix

in the nucleus because of the different signs their longitudinal angular momentum of the emitted FPs have.

For BSPs that are in the first region, the attracting or repelling forces are zero because the angle β between their longitudinal rotational momentum is $\beta = \pi + \varphi_1 - \varphi_2 = \pi$. BSPs that migrate outside the first region are reintegrated or expelled with high speed when their FPs cross with FPs of the remaining BSPs of the atomic nucleus because the angle $\beta < \pi$.

Fig.8 shows two neutrons where at neutron 1 the migrated BSP "b" is reintegrated, inducing at neutron 2 the gravitational linear momentum according postulate 3) of sec 5.

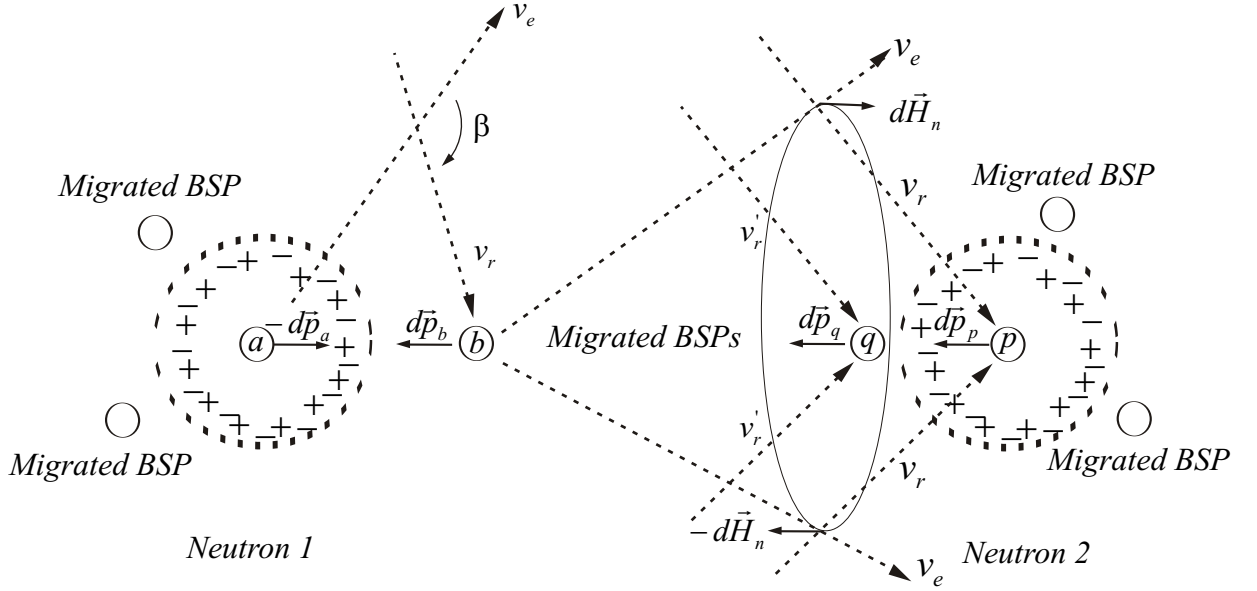

Figure 8: Transmission of momentum dp from neutron 1 to neutron 2

At stable nuclei all BSPs that migrate outside the first region are reintegrated, while at unstable nuclei some are expelled in all possible combinations (electrons, positrons, hadrons) together with neutrinos and photons maintaining the energy balance.

As the force described by eq. (25) induced on other particles during reintegration has always the direction and sense of the reintegrating particle (right screw of \vec{J}_n) independent of its charge, BSPs that are reintegrated induce on other atomic nuclei the gravitation force. The inverse square distance law for the gravitation force results from the inverse square distance law of the radial density of FPs that transfer their angular momentum from the moving to the static BSPs according postulate 3) of sec. 5. Gravitation force is thus a function of the number of BSPs that migrate and are reintegrated in the time Δt (migration current), and the reintegration velocity.

The **third region** gives the width of the tunnel barrier through which the expelled particles of atomic nuclei are emitted. As the reintegration process of BSPs that migrate outside the first region depend on the special dynamic polarization of the remaining BSPs of the atomic nucleus, particles are not always reintegrated but expelled when the special dynamic polarization is not fulfilled. The emission is quantized and follows the exponential radioactive decay law.

The **fourth region** is a transition region to the Coulomb law.

The transition value $\gamma_{trans} = 518$ to the Coulomb law was determined by comparing the tangents of the Coulomb equation and the curve from Fig.7. At $\gamma_{trans} = 518$ the ratio of their tangents begin to deviate from 1.

At the transition distance d_{trans} , where $\gamma_{trans} = 518$, the inverse proportionality to the distance d_{trans} from the neighbor regions must give the same force F_{trans}

$$F_{trans} = \frac{1}{\Delta t} \frac{K'}{d_{trans}} = \frac{1}{\Delta t} \frac{K'_F}{d_{trans}^2} \quad (37)$$

with K' and K'_F the proportionality factors of the fourth and fifth regions.

The transition distance for BSPs (electron and positron) is:

$$d_{trans} = \gamma_{trans} r_o = \gamma_{trans} \frac{\hbar c}{E_o} = 518 \cdot 3.859 \cdot 10^{-13} = 2.0 \cdot 10^{-10} m \quad (38)$$

which is of the order of the radii of neutral isolated atoms.

The **fifth region** is where the Coulomb law is valid.

The concept is shown in Fig. 9

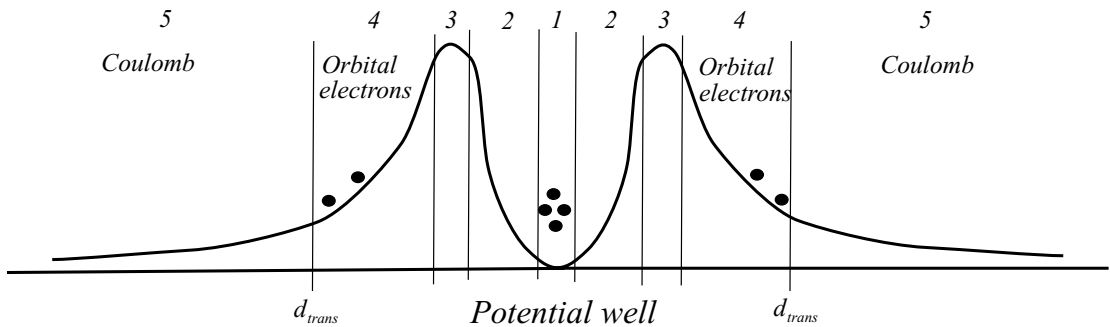

Figure 9: Potential well between BSPs

9 Stern-Gerlach experiment and the spin of an electron

To explain the splitting of the atomic ray in the Stern-Gerlach experiment, electrons were assigned an intrinsic spin with a quantized magnetic field that takes two positions, up and down relative to an external magnetic field, although it is not possible to explain how the intrinsic magnetic field is generated. The proposed approach with particles as focal points of rays of FPs has also no possibility to explain how such an intrinsic magnetic field could be generated.

An explanation is now given how the splitting of the atomic ray in the Stern-Gerlach experiment is generated.

A single electron orbiting the atomic nucleus is bound to the nucleus only in the radial direction r with arbitrary coordinates φ and θ . The single orbiting electron doesn't define a rigid rotating axis in space where an external torque can be applied and has therefore not the characteristics of a gyroscope, like the precession of the rotation axis. An external force applied to the electron changes immediately the orbit of the plane without resistance.

When an atom with only one orbiting electron enters a homogeneous external magnetic field, the orbiting electron adopts immediately an orbit in a plane orthogonal to the magnetic field rotating in one of the two possible directions. In one direction the Lorentz force will add to the Coulomb force reducing the radius and increasing the angular speed and the centrifugal force. In the other direction will occur the opposed.

An orbiting electron generates a magnetic field perpendicular to the plane of its orbit, which in the case of an atom with only one electron will align with the external magnetic field up or down. A second electron will rotate in the opposed direction with a different radius compensating the magnetic field of the first electron. That explains the pairs of up and down electrons in the configuration of the atoms.

With an inhomogeneous external magnetic field there exists no orbiting plane for an electron where the Lorentz force is permanently in a plane. There is permanently a component of the Lorentz force in the direction of the gradient of the inhomogeneous external field, up or down according to the rotation sense.

For atoms like the Silver atom with one valence electron and all the other electrons forming a closed shell, the valence electron behaves like an atom with only one electron with no gyroscopic characteristics. The part of the atom with electrons that form a closed shell has a rigid configuration because of the forces between the orbit electrons and the nucleus. This part allows the application of a torque and behaves like a gyroscope.

An isolated electron has no intrinsic angular neither magnetic momentum (spin).

10 Ampere bending (Bragg law).

With the fundamental eq. (23) from sec. 6 for parallel currents the force density generated between two straight parallel currents of BSPs due to the interactions of their transversal angular momenta is calculated in [10] and gives

$$\frac{F}{\Delta l} = \frac{b}{c} \frac{r_o^2}{\Delta_o t} \frac{I_{m_1} I_{m_2}}{64 m} \int_{\gamma_{2min}}^{\gamma_{2max}} \int_{\gamma_{1min}}^{\gamma_{1max}} \frac{\sin^2(\gamma_1 - \gamma_2)}{\sqrt{\sin \gamma_1 \sin \gamma_2}} d\gamma_1 d\gamma_2 \quad (39)$$

with $\int \int_{Ampere} = 5.8731$.

In the case of the bending of a BSP the interaction is now between one BSP moving with speed v_2 and one reintegrating BSP of a nucleus that moves with the speed v_1 parallel to v_2 . The reintegration of a migrated BSP is described in sec. 8.

The concept is shown in Fig. 10

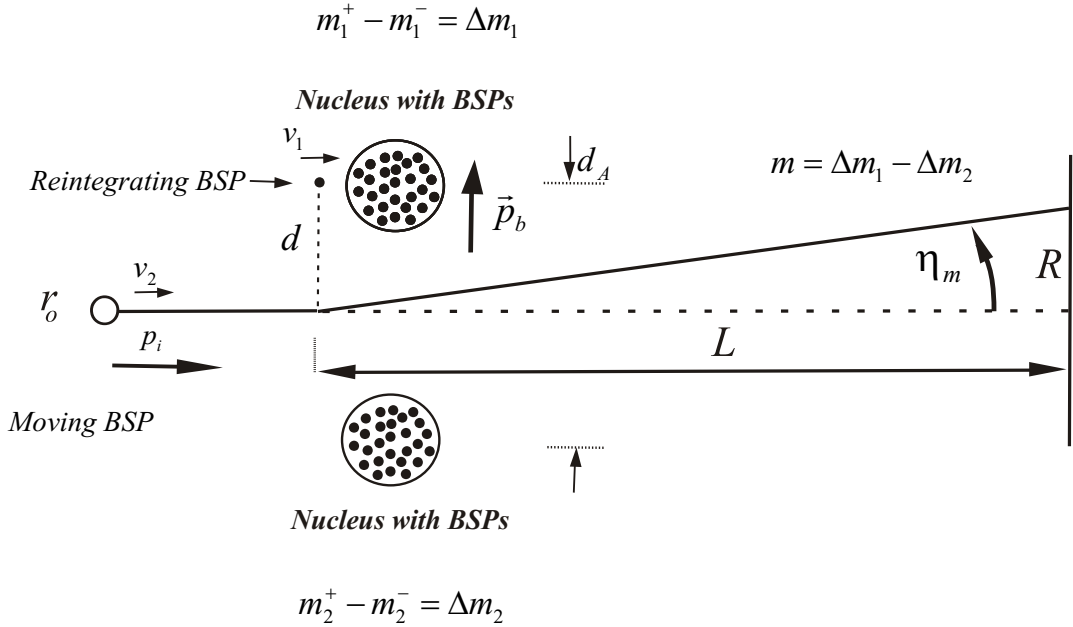

Figure 10: Bending of BSPs

For $v \ll c$ it is

$$\rho_x = \frac{N_x}{\Delta x} = \frac{1}{2 r_o} \quad I_m = \rho m v \quad \Delta_o t = K r_o^2 \quad p = F \Delta_o t \quad (40)$$

We get for the force

$$F = \frac{b}{4 \Delta_o t} \frac{5.8731}{64 c} \frac{\sqrt{m} v_1 \sqrt{m} v_2}{d} \Delta l \quad (41)$$

We have defined a density ρ_x of BSPs for the current so that one BSP follows immediately the next without space between them. As we want the force between one

pair of BSPs of the two parallel currents we take $\Delta l = 2 r_o$.

The interaction between the two parallel BSPs takes place along a distance $\Delta'' l = v_2 \Delta'' t$ giving a total bending momentum $p_b = F \Delta'' t$. With all that we get

$$p_b = \frac{b}{2 K r_o} \frac{5.8731}{64 c} \frac{m v_1}{d} \Delta'' l \quad (42)$$

which is independent of the speed v_2 . In [10] the speed of a reintegrating BSP is deduced giving $v_1 = k c$ with $k = 7.4315 \cdot 10^{-2}$. We get

$$p_b = \frac{b}{2 K r_o} \frac{5.8731}{64 c} \frac{m k c}{d} \Delta'' l \quad (43)$$

If we now write the bending equation with the help of $\tan \eta = 2 \sin \theta$ for small η and with $2 d = d_A$ we get

$$\sin \theta = \frac{p_b}{2 p_i} = \left(\frac{5.8731 b m v_1}{64 c K r_o h} \Delta'' l \right) \frac{h}{2 p_i d_A} n \quad (44)$$

To get the Bragg law the expression between brackets must be constant and equal to the unit what gives for the constant interaction distance $\Delta'' l$

$$\Delta'' l = \frac{64 c K r_o h}{5.8731 b m k c} = 8.9357 \cdot 10^{-9} \text{ m} \quad (45)$$

We get for the bending momentum and force

$$p_b = \frac{h}{d_A} n \quad F_b = \frac{1}{2} \frac{h}{d \Delta_o t} = \frac{1}{2} \frac{n E_o}{d} \quad (46)$$

The bending force is quantized in energy quanta equal to the rest energy E_o of a BSP.

Conclusion: We have derived the Bragg equation without the concept of particle-wave introduced by de Broglie. Numerical results obtained using the quantized irradiated energy instead of the particle-wave are equivalent, different is the physical interpretation of the underlying phenomenon.

11 Induction between a moving and a probe BSP.

In the present approach the energy of a BSP is distributed in space around the radius (focal point) of the BSP. The carriers of the energy are the FPs with their angular momenta, FPs that are continuously emitted and regenerate the BSP. At a free moving BSP each angular momentum of a FP is balanced by an other angular momentum of a FP of the same BSP.

The concept is shown in Fig. 11.

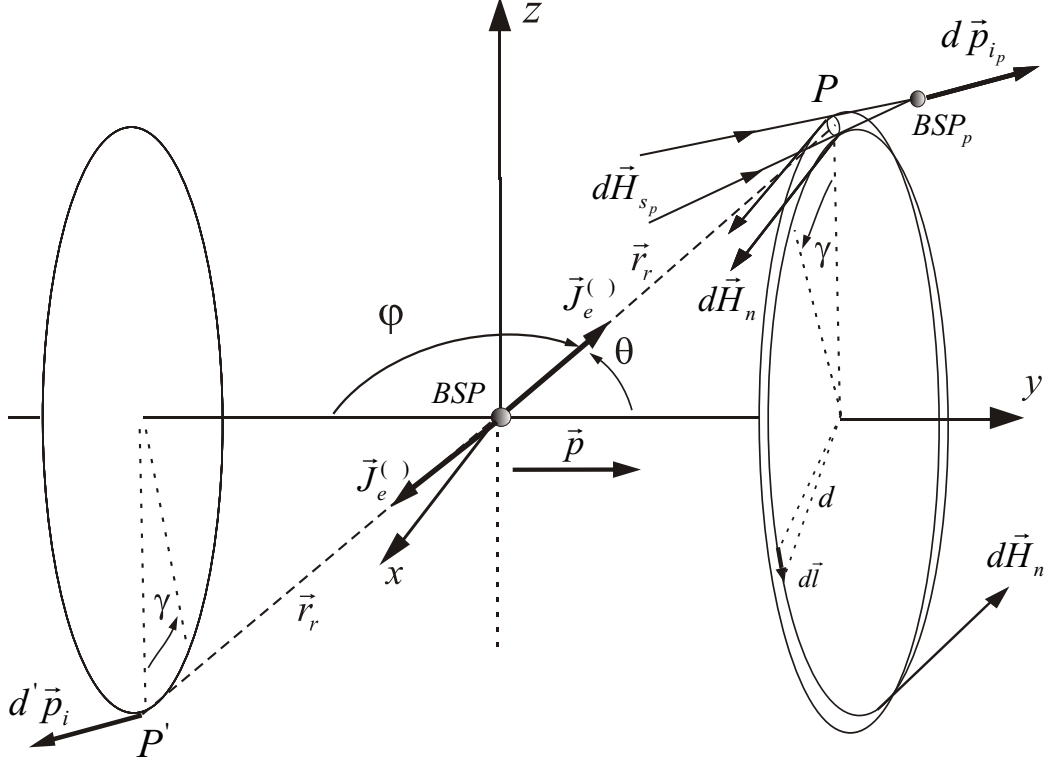

Figure 11: Linear momentum balance between static and moving BSPs

Opposed transversal angular momenta $d\bar{H}_n$ and $-d\bar{H}_n$ from two FPs that regenerate the BSP produce the linear momentum \bar{p} of the BSP. If a second static probe BSP_p appropriates with its regenerating angular momenta ($d\bar{H}_{sp}$) angular momenta ($d\bar{H}_n$) from FPs of the first BSP according postulate 3) of sec. 5, angular momenta that built a rotor different from zero in the direction of the second BSP_p generating $d\bar{p}_{i_p}$, the first BSP loses energy and its linear momentum changes to $\bar{p} - d\bar{p}_{i_p}$. The angular momenta appropriated at point P by the probe BSP_p generating the linear momentum $d\bar{p}_{i_p}$ are missing now at the first BSP to compensate the angular momenta at the symmetric point P' . The linear momenta at the two symmetric points are therefore equal and opposed $d'\bar{p}_i = -d\bar{p}_{i_p}$ because of the symmetry of the energy distribution function $d\kappa(\pi - \theta) = d\kappa(\theta)$.

As the closed linear integral $\oint d\bar{H}_n d\bar{l}$ generates the linear momentum \bar{p} of a BSP, the orientation of the field $d\bar{H}_n$ (right screw in the direction of the velocity) must be independent of the sign of the BSP, sign that is defined by $\bar{J}_e^{(\pm)}$.

12 Newton gravitation force.

To calculate the gravitation force induced by the reintegration of migrated BSPs, we need to know the number of migrated BSPs in the time Δt for a neutral body with

mass M .

The following equation was derived in [10] for the **induced gravitation** force generated by one reintegrated electron or positron

$$F_i = \frac{dp}{\Delta t} = \frac{k c \sqrt{m} \sqrt{m_p}}{4 K d^2} \iint_{Induction} \quad \text{with} \quad \iint_{Induction} = 2.4662 \quad (47)$$

with m the mass of the reintegrating BSP, m_p the mass of the resting BSP, $k = 7.4315 \cdot 10^{-2}$. It is also

$$\Delta t = K r_o^2 \quad r_o = 3.8590 \cdot 10^{-13} \text{ m} \quad \text{and} \quad K = 5.4274 \cdot 10^4 \text{ s/m}^2 \quad (48)$$

The direction of the force F_i on BSP p of neutron 2 in Fig. 8 is independent of the sign of the BSPs and is always oriented in the direction of the reintegrating BSP b of neutron 1.

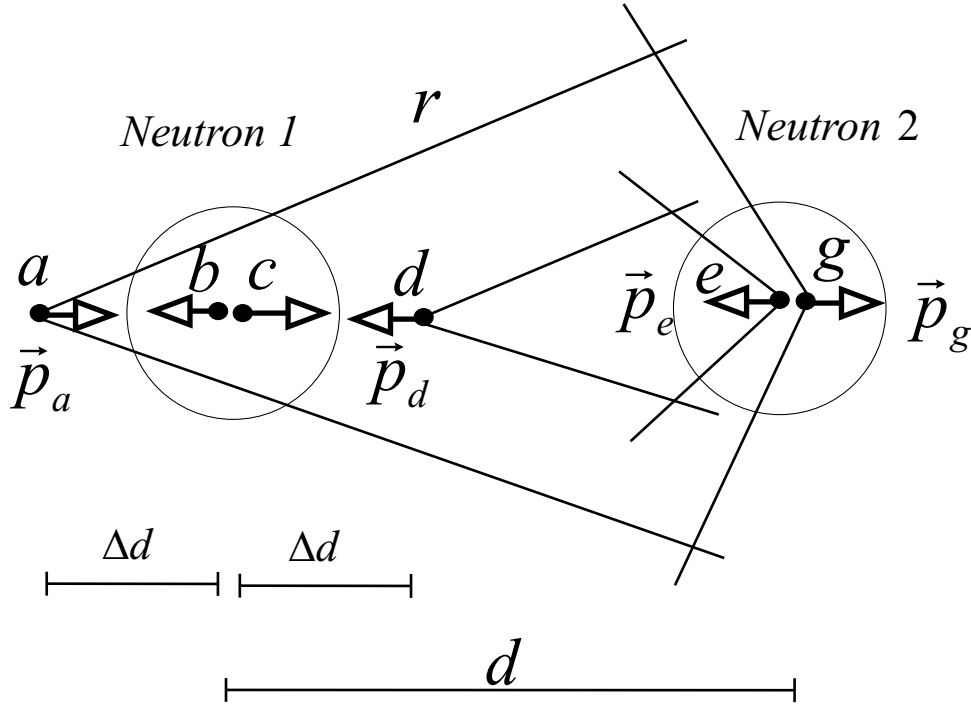

Figure 12: Net momentum transmitted from neutron 1 to neutron 2

Fig. 12 shows reintegrating BSPs a and d at Neutron 1 that transmit respectively opposed momenta p_g and p_e to neutron 2. Because of the greater distance from neutron 2 of BSP a compared with BSP d , the probability for BSP d to transmit his momentum is greater than the probability for BSP a . Momenta are quantized and have all equal absolute value independent if transmitted or not. The result computed over a mass M

gives a net number of transmitted momentum to neutron 2 in the direction of neutron 1, what explains the attraction between neutral masses.

For two bodies with masses M_1 and M_2 and where the number of reintegrated BSPs in the time Δt is respectively Δ_{G_1} and Δ_{G_2} it must be

$$F_i \Delta_{G_1} \Delta_{G_2} = G \frac{M_1 M_2}{d^2} \quad \text{with} \quad G = 6.6726 \cdot 10^{-11} \frac{m^3}{kg \ s^2} \quad (49)$$

As the direction of the force F_i is the same for reintegrating electrons Δ_G^- and positrons Δ_G^+ it is

$$\Delta_G = |\Delta_G^-| + |\Delta_G^+| \quad (50)$$

We get that

$$\Delta_{G_1} \Delta_{G_2} = G \frac{4 K M_1 M_2}{m k c \int \int_{Induction}} \quad (51)$$

or

$$\Delta_{G_1} \Delta_{G_2} = 2.8922 \cdot 10^{17} M_1 M_2 = \gamma_G^2 M_1 M_2 \quad (52)$$

The number of migrated BSPs in the time Δt for a neutral body with mass M is thus

$$\Delta_G = \gamma_G M \quad \text{with} \quad \gamma_G = 5.3779 \cdot 10^8 \ kg^{-1} \quad (53)$$

Calculation example: The number of migrated BSPs that are reintegrated at the sun and the earth in the time Δt are respectively, with $M_\odot = 1.9891 \cdot 10^{30} \ kg$ and $M_\dagger = 5.9736 \cdot 10^{24} \ kg$

$$\Delta_{G_\odot} = 1.0697 \cdot 10^{39} \quad \text{and} \quad \Delta_{G_\dagger} = 3.2125 \cdot 10^{33} \quad (54)$$

The power exchanged between two masses due to gravitation is

$$P_G = F_i c = \frac{E_p}{\Delta t} = \frac{k m c^2}{4 K d^2} \Delta_{G_1} \Delta_{G_2} \int \int_{Induktion} \quad (55)$$

The power exchanged between the sun and the earth is, with $d_{\odot\dagger} = 1.49476 \cdot 10^{11} \ m$

$$P_G = F_G c = G \frac{M_\odot M_\dagger}{d_{\odot\dagger}^2} c = 1.0646 \cdot 10^{31} \ J/s \quad (56)$$

13 Ampere gravitation force.

In the previous sections we have seen that the induced gravitation force is due to the reintegration of migrated BSPs in the direction d of the two gravitating bodies (longitudinal reintegration). When a BSP is reintegrated to a neutron, the two BSPs of different signs that interact, produce an equivalent current in the direction of the positive BSP as shown in Fig. 13.

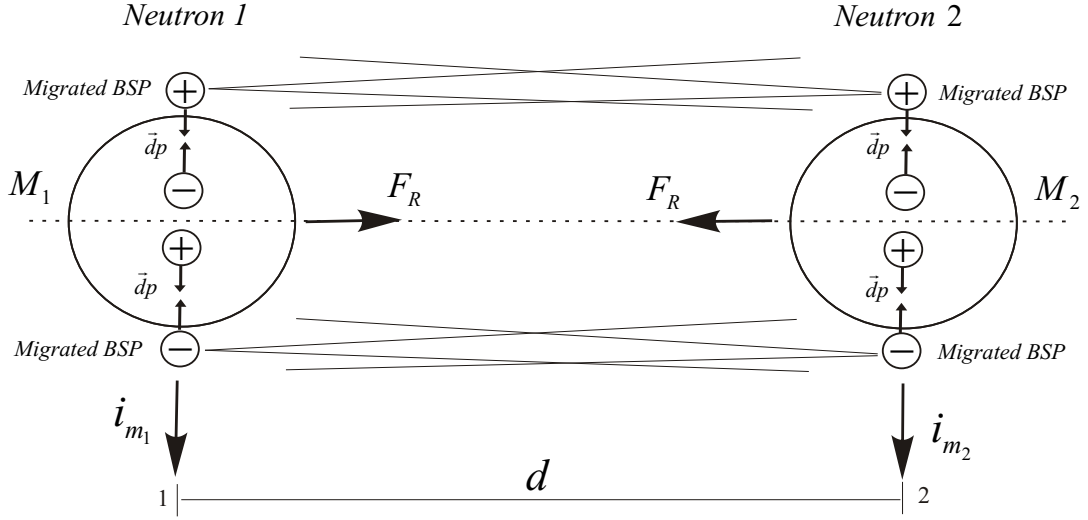

Figure 13: Resulting current due to reintegration of migrated BSPs

As the numbers of positive and negative BSPs that migrate in one direction at one neutron are equal, no average current should exist in that direction in the time Δt . It is

$$\Delta_R = \Delta_R^+ + \Delta_R^- = 0 \quad (57)$$

We now assume that because of the power exchange (55) between the two neutrons, a synchronization between the reintegration of BSPs of equal sign in the direction orthogonal to the axis defined by the two neutrons is generated, resulting in parallel currents of equal sign that generate an attracting force between the neutrons. The synchronization is generated by the relative movements between the gravitating bodies and is zero between static bodies. Thus the total attracting force between the two neutrons is produced first by the induced (Newton) force and second by the currents

of reintegrating BSPs (Ampere).

$$F_T = F_G + F_R \quad \text{with} \quad F_G = G \frac{M_1 M_2}{d^2} \quad \text{and} \quad F_R = R \frac{M_1 M_2}{d} \quad (58)$$

To derive an equation we start with the following equation from [10] derived for the total force density due to Ampere interaction.

$$\frac{F}{\Delta l} = \frac{b}{c} \frac{r_o^2}{\Delta_o t} \frac{I_{m_1} I_{m_2}}{64 m} \int_{\gamma_{2min}}^{\gamma_{2max}} \int_{\gamma_{1min}}^{\gamma_{1max}} \frac{\sin^2(\gamma_1 - \gamma_2)}{\sqrt{\sin \gamma_1 \sin \gamma_2}} d\gamma_1 d\gamma_2 \quad (59)$$

with $\int \int_{Ampere} = 5.8731$.

It is also for $v \ll c$

$$\rho_x = \frac{N_x}{\Delta x} = \frac{1}{2 r_o} \quad I_m = \rho m v \quad \Delta_o t = K r_o^2 \quad I_m = \frac{m}{q} I_q \quad (60)$$

We have defined a density ρ_x of BSPs for the current so that one BSP follows immediately the next without space between them. As we want the force between one pair of BSPs of the two parallel currents we take $\Delta l = 2 r_o$.

For one reintegrating BSP it is $\rho = 1$. The current generated by one reintegrating BSP is

$$I_{m_1} = i_m = \rho m v_m = \rho m k c \quad \text{with} \quad v_m = k c \quad k = 7.4315 \cdot 10^{-2} \quad (61)$$

We get for the force between one transversal reintegrating BSP at the body with mass M_1 and one longitudinal reintegrating BSP at M_2 moving parallel with the speed v_2

$$dF_R = 5.8731 \frac{b}{\Delta_o t} \frac{2 r_o^3}{64} \rho^2 m k \frac{v_2}{d} = 2.2086 \cdot 10^{-50} \frac{v_2}{d} N \quad (62)$$

with $I_{m_2} = i_2 = \rho m v_2$.

The concept is shown in Fig. 14.

Note: The sign that takes the current i_m of the reintegrating BSP at the body with mass M_1 which interacts with the current i_2 , is a function of the direction of the magnetic poles of M_1 . The Ampere gravitation force F_R is therefore an attraction or a repulsion force depending on the relative directions of the magnetic poles of M_1 and the speed v_2 .

In sec. 12 we have derived the mass density γ_G of reintegrating BSPs. At Fig. 12 we have seen that half of the longitudinal reintegrating BSPs of a neutron 1 induce momenta on neutron 2 in one direction while the other half of longitudinal reintegrating

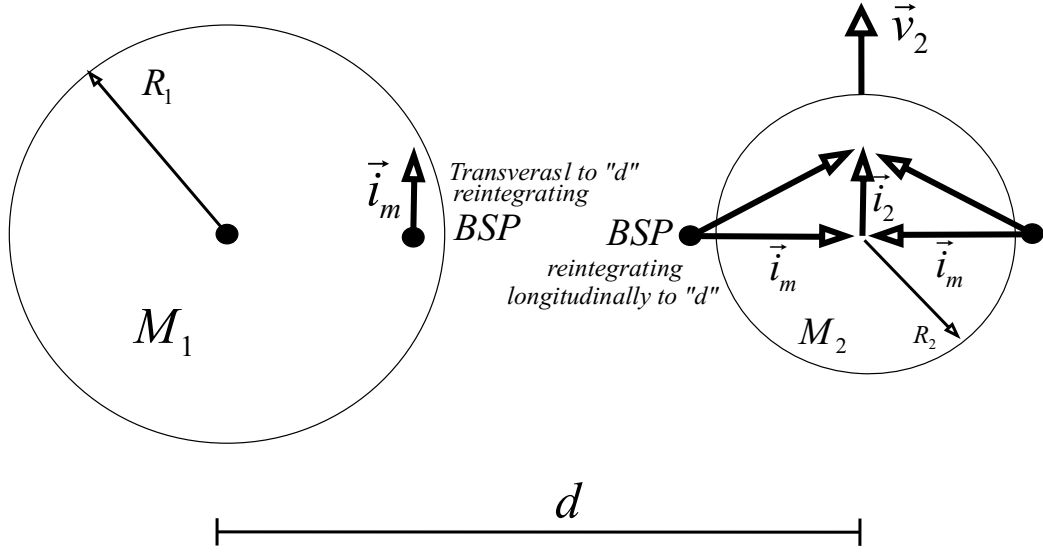

Figure 14: Ampere gravitation

BSPs induce momenta in the opposed direction on neutron 2. In Fig. 14 we see, that all longitudinal reintegrating BSPs at M_2 generate a current component i_2 in the direction of the speed v_2 . This means that we have to take for the density γ_A of reintegrating BSPs for the Ampere gravitation force approximately twice the value of the density γ_G of the Newton gravitation force

$$\gamma_A \approx 2 \gamma_G = 2 \cdot 5.3779 \cdot 10^8 = 1.07558 \cdot 10^9 \text{ kg}^{-1} \quad (63)$$

resulting for the total Ampere gravitation force between M_1 and M_2

$$F_R = 5.8731 \frac{b}{\Delta_o t} \frac{2 r_o^3}{64} \rho^2 m k v_2 \gamma_A^2 \frac{M_1 M_2}{d} = 2.5551 \cdot 10^{-32} v_2 \frac{M_1 M_2}{d} \text{ N} \quad (64)$$

where

$$F_R = R \frac{M_1 M_2}{d} \quad \text{with} \quad R = 2.5551 \cdot 10^{-32} v_2 = R(v_2) \quad (65)$$

The total gravitation force gives

$$F_T = F_G + F_R = \left[\frac{G}{d^2} + \frac{R}{d} \right] M_1 M_2 \quad (66)$$

The concept is shown in Fig. 15.

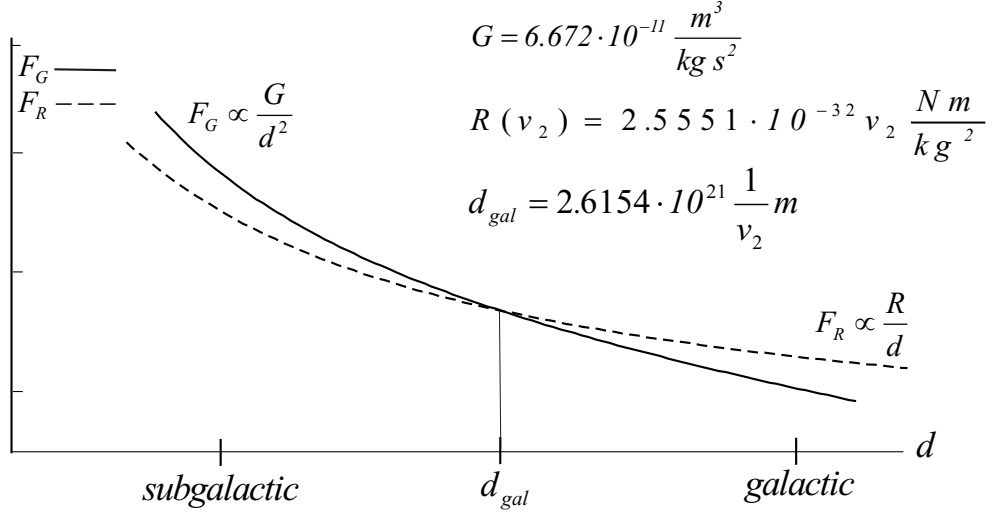

Figure 15: Gravitation forces at sub-galactic and galactic distances.

Calculation example

To verify that the Newton component predominates over the Ampere component for the case of the earth and the sun, we calculate now d_{gal} for this case and compare it with the distance $d_{\odot,+} = 1.5 \cdot 10^{11}$ m between the earth and sun. It is for the sun $M_{\odot} = 2 \cdot 10^{30}$ kg, and for the earth $M_{+} = 5.97 \cdot 10^{24}$ kg, and $v_2 = 29.78 \cdot 10^3$ m/s.

$$d_{gal} = \frac{G}{R(v_2)} = 8.733 \cdot 10^{16} \text{ m} \gg d_{\odot,+} \quad (67)$$

The Ampere component of the force is $F_A = 6.056 \cdot 10^{16}$ N and the Newton component is $F_G = 3.54 \cdot 10^{22}$ N. It is $F_G \gg F_A$ what explains why we only can measure the Newton component of the gravitation force.

13.1 Flattening of galaxies' rotation curve.

For galactic distances the Ampere gravitation force F_R predominates over the induced gravitation force F_G and we can write eq. (66) as

$$F_T \approx F_R = \frac{R}{d} M_1 M_2 \quad (68)$$

The equation for the centrifugal force of a body with mass M_2 is

$$F_c = M_2 \frac{v_{orb}^2}{d} \quad \text{with } v_{orb} \text{ the tangential speed} \quad (69)$$

For steady state mode the centrifugal force F_c must equal the gravitation force F_T .

For our case it is

$$F_c = M_2 \frac{v_{orb}^2}{d} = F_T \approx F_R = \frac{R}{d} M_1 M_2 \quad (70)$$

We get for the tangential speed

$$v_{orb} \approx \sqrt{R M_1} \quad \text{constant} \quad (71)$$

The tangential speed v_{orb} is independent of the distance d what explains the flattening of galaxies' rotation curves.

Calculation example

In the following calculation example we assume that the transition distance d_{gal} is much smaller than the distance between the gravitating bodies and that the Newton force can be neglected compared with the Ampere force.

For the Sun with $v_2 = v_{orb} = 220 \text{ km/s}$ and $M_2 = M_\odot = 2 \cdot 10^{30} \text{ kg}$ and a distance to the core of the Milky Way of $d = 25 \cdot 10^{19} \text{ m}$ we get a centrifugal force of

$$F_c = M_2 \frac{v_{orb}^2}{d} = 3.872 \cdot 10^{20} \text{ N} \quad (72)$$

With

$$R(v_2) = 2.5551 \cdot 10^{-32} v_2 = 5.6212 \cdot 10^{-27} \text{ Nm/kg}^2 \quad (73)$$

and

$$F_c \approx R \frac{M_1 M_2}{d} \quad (74)$$

we get a Mass for the Milky Way of

$$M_1 = F_c d \frac{1}{R M_\odot} = 4.3 \cdot 10^6 M_\odot \quad (75)$$

and with

$$F_G = F_R \quad \text{we get} \quad d_{gal} = \frac{G}{R(v_2)} = 1.1870 \cdot 10^{16} \text{ m} \quad (76)$$

justifying our assumption for $F_T \approx F_R$ because the distance between the Sun and the core of the Milky Way is $d \gg d_{gal}$.

Note: The mass of the Milky Way calculated with the Newton gravitation law gives $M_1 \approx 1.5 \cdot 10^{12} M_\odot$ which is huge more than the bright matter and therefore called dark matter. The mass calculated with the present approach corresponds to the bright matter and there is no need to introduce virtual masses in space.

For sub-galactic distances the induced force F_G is predominant, while for galactic distances the Ampere force F_R predominates, as shown in Fig. 15.

$$d_{gal} = \frac{G}{R(v_2)} \quad (77)$$

Note: The flattening of galaxies' rotation curve was derived based on the assumption that the gravitation force is composed of an induced component and a component due to parallel currents generated by reintegrating BSPs and, that for galactic distances the induced component can be neglected.

14 Quantification of irradiated energy and movement.

14.1 Quantification of irradiated energy.

To express the energy irradiated by a BSP as quantified in angular momenta over time we start with

$$E = E_e = E_s + E_n = \sqrt{E_o^2 + E_p^2} \quad \Delta t = K r_o r_{op} \quad r_o = \frac{\hbar c}{E_e} \quad r_{op} = \frac{\hbar c}{E_o} \quad (78)$$

with r_o the radius of the moving particle and r_{op} the radius of the resting probe particle. It is

$$\Delta t = K r_o r_{op} \frac{r_{op}}{r_{op}} = K r_{op}^2 \frac{r_o}{r_{op}} = \Delta_o t \frac{r_o}{r_{op}} \quad (79)$$

with

$$\Delta_o t = \Delta t_{(v=0)} = K \frac{\hbar^2 c^2}{E_o^2} = 8.082097 \cdot 10^{-21} \text{ s} \quad \text{with} \quad K = 5.4274 \cdot 10^4 \text{ s/m}^2 \quad (80)$$

We now define $E_e \Delta t$ and get

$$E_e \Delta t = K \frac{\hbar^2 c^2}{E_o} = K \frac{h^2}{4 \pi^2 m} = h \quad (81)$$

equation that is valid for every speed $0 \leq v \leq c$ of the BSP giving

$$E_e \Delta t = E_o \Delta_o t = h \quad (82)$$

where h is the Planck constant.

Note: In the equation $E_e \Delta t = h$ the energy E_e is the total energy of the moving particle and the differential time Δt is the time the differential momentum Δp is active to give the force $F = \Delta p / \Delta t$ between the moving and the probe particle.

In connection with the quantification of the energy $E = J \nu$ the following cases are possible:

- A common frequency ν_g exists and the angular momentum J is variable.
- A common angular momentum J_g exists and the frequency ν is variable.

The concept is shown in Fig. 16.

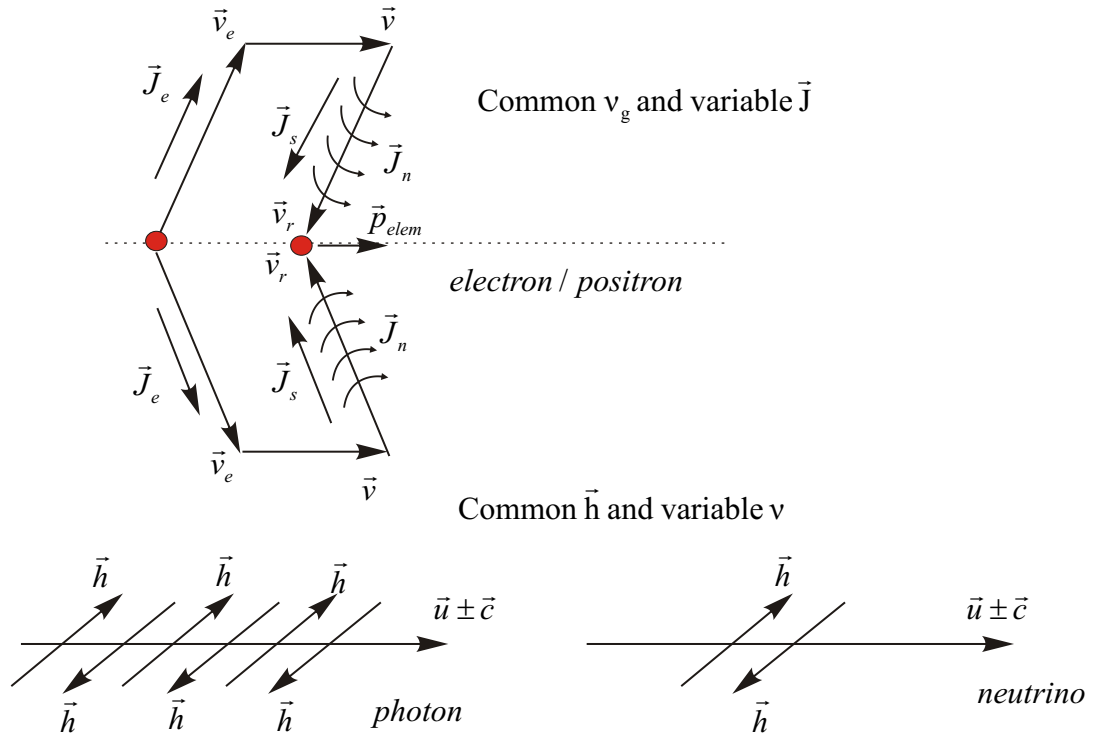

Figure 16: Quantification of linear momentum

We define for a common angular momentum $J_g = h$ the equivalent angular frequencies ν , ν_o and ν_p with the following equations

$$E = E_e = h \nu \quad \nu = \frac{1}{\Delta t} \quad \text{and} \quad E_p = p c = h \nu_p \quad (83)$$

and

$$E_o = m c^2 = h \nu_o \quad \nu_o = \frac{1}{\Delta_o t} = 1.2373 \cdot 10^{20} \text{ s}^{-1} \quad (84)$$

We have already defined the angular frequencies ν_e , ν_s and ν_n for the FPs with the following equations

$$E_e = E_s + E_n \quad \text{and} \quad dE_e = dE_s + dE_n \quad (85)$$

With a common angular momentum $J_g = h$ it is

$$dE_e = E_e d\kappa = h \nu_e \quad dE_s = E_s d\kappa = h \nu_s \quad dE_n = E_n d\kappa = h \nu_n \quad (86)$$

The relation between the angular frequencies of FPs and the equivalent angular frequencies is

$$\nu = \sum_i \nu_{e_i} = \sum_i \nu_{s_i} + \sum_i \nu_{n_i} = \sqrt{\nu_o^2 + \nu_p^2} \quad (87)$$

If all FPs have the same angular frequency $\nu_{e_i} = \nu_{s_i} = \nu_{n_i} = \nu_{FP}$ we get

$$\nu = N_e \nu_{FP} = N_s \nu_{FP} + N_n \nu_{FP} = \sqrt{\nu_o^2 + \nu_p^2} \quad (88)$$

with N the corresponding total number of FPs of the BSP. If we multiply the equation with h we get

$$h \nu = N_e h \nu_{FP} = N_s h \nu_{FP} + N_n h \nu_{FP} = h \sqrt{\nu_o^2 + \nu_p^2} \quad (89)$$

or

$$E = E_e = E_s + E_n = \sqrt{E_o^2 + E_p^2} \quad (90)$$

with $E_{FP} = h \nu_{FP}$ the energy of one FP.

14.1.1 Fundamental equations expressed as functions of the powers exchanged by the BSPs.

We define the quantized emission of energy for a BSP with $v \neq c$ defining the power as

$$P_e = \frac{E_e}{\Delta t} = E_e \nu \quad \nu = \frac{1}{\Delta t} \quad (91)$$

$$P_e = \frac{E_e}{\Delta t} = \frac{1}{\Delta t} \sqrt{E_o^2 + E_p^2} = \sqrt{P_o^2 + P_p^2} = E_s \nu + E_n \nu = P_s + P_n \quad (92)$$

where

$$P_o = E_o \nu \quad P_p = E_p \nu \quad P_s = E_s \nu \quad P_n = E_n \nu \quad (93)$$

For the differential powers we get

$$dP_e = \nu E_e d\kappa \quad dP_s = \nu E_s d\kappa \quad dP_n = \nu E_n d\kappa \quad (94)$$

Now we show that the fundamental equations of sec 6 for the generation of linear momentum can be expressed as functions of the powers of their interacting BSPs.

With

$$dE = E d\kappa \quad dH = \sqrt{E} d\kappa = H d\kappa \quad \text{and} \quad \frac{H}{\sqrt{\Delta t}} = \sqrt{E} \nu = \sqrt{P} \quad (95)$$

the equations for the Coulomb, Ampere and induction forces of sec. 6 can be transformed to

$$d'F \bar{s}_R = \frac{d'p}{\Delta t} \bar{s}_R \propto \frac{1}{c} \oint_R \left\{ \int_{r_1}^{\infty} \frac{H_1}{\sqrt{\Delta_1 t}} d\kappa_{r_1} \int_{r_2}^{\infty} \frac{H_2}{\sqrt{\Delta_2 t}} d\kappa_{r_2} \right\} \bar{s}_R \quad (96)$$

with

$$\sqrt{\Delta_1 t} \sqrt{\Delta_2 t} = \sqrt{K} r_{o_1} \sqrt{K} r_{o_2} = K r_{o_1} r_{o_2} = \Delta t \quad (97)$$

and

$$\frac{H_1}{\sqrt{\Delta_1 t}} = \frac{\sqrt{E_1}}{\sqrt{\Delta_1 t}} = \sqrt{\frac{E_1}{\Delta_1 t}} = \sqrt{P_1} \quad P = \frac{E^3}{K \hbar^2 c^2} \approx \frac{E^3}{K \cdot 10^{-51}} \quad (98)$$

Finally we get the general formulation for the fundamental equations of sec 6 for the generation of linear momentum expressed as functions of the powers of their interacting BSPs.

$$d'F \bar{s}_R = \frac{d'p}{\Delta t} \bar{s}_R \propto \frac{1}{c} \oint_R \left\{ \int_{r_1}^{\infty} \sqrt{P_1} d\kappa_{r_1} \int_{r_2}^{\infty} \sqrt{P_2} d\kappa_{r_2} \right\} \bar{s}_R \quad (99)$$

It is also possible to define differential energy fluxes for BSPs. We start with

$$dP_e = \nu E_e d\kappa \quad dP_s = \nu E_s d\kappa \quad dP_n = \nu E_n d\kappa \quad (100)$$

and with

$$d\kappa = \frac{1}{2} \frac{r_o}{r^2} dr \sin \varphi d\varphi \frac{d\gamma}{2\pi} \quad \text{and} \quad dA = r^2 \sin \varphi d\varphi d\gamma \quad (101)$$

The concept is shown in Fig. 17.

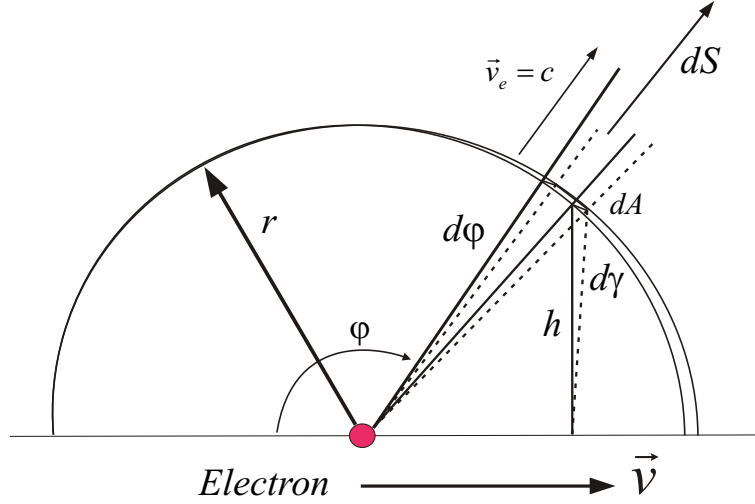

Figure 17: Emitted Energy flux density dS of a moving electron

The cumulated differential energy flux is

$$\int_r^\infty dP_e = \nu E \int_r^\infty d\kappa = \nu E \frac{1}{2} \frac{r_o}{r} \sin \varphi d\varphi \frac{d\gamma}{2\pi} \quad J \text{ s}^{-1} \quad (102)$$

The cumulated differential energy flux density is

$$\int_r^\infty dS_e = \frac{1}{dA} \int_r^\infty dP_e = \nu E_e \frac{1}{4\pi} \frac{r_o}{r^3} \quad \frac{J}{m^2 \text{ s}} \quad (103)$$

To get the total cumulated energy flux through a sphere with a radius r we make $r_o = r$ and integrate over the whole surface $A = 4\pi r^2$ of the sphere and get

$$4\pi r^2 \int_r^\infty dS_e = \nu E_e \quad \frac{J}{m^2 \text{ s}} \quad (104)$$

Note: The differential energy flux density is independent of φ and γ and therefore independent of the direction of the speed v . This is because of the relativity of the speed v that does not define who is moving relative to whom.

14.1.2 Physical interpretation of an electron and positron as radiating and absorbing FPs:

The emitted differential energy is

$$dE_e = E_e d\kappa = \frac{h}{\Delta t} \frac{1}{2} \frac{r_o}{r^2} dr \sin \varphi d\varphi \frac{d\gamma}{2\pi} \quad (105)$$

With the help of Fig. 17 we see that the area of the sphere is $A = 4\pi r^2$, and we get

$$dE_e = \frac{h}{\Delta t A} r_o dr \sin \varphi d\varphi d\gamma \quad (106)$$

We now define

$$dE_e = \sigma_h r_o dr \sin \varphi d\varphi d\gamma \quad \text{with} \quad \sigma_h = \frac{h}{\Delta t A} \quad (107)$$

where σ_h is the *current density of fundamental angular momentum* h .

We can also write

$$dE_e = \sigma_h dA \quad \text{with} \quad dA = r_o dr \sin \varphi d\varphi d\gamma \quad (108)$$

14.2 Energy and density of Fundamental Particles.

14.2.1 Energy of Fundamental Particles.

The emission time of photons from isolated atoms is approximately $\tau = 10^{-8} s$ what gives a length for the train of waves of $L = c \tau = 3 m$. The total energy of the emitted photon is $E_t = h \nu_t$ and the wavelength is $\lambda_t = c/\nu_t$. We have defined (see Fig. 16), that the photon is composed of a train of FPs with alternated angular momenta where the distance between two consecutive FPs is equal $\lambda_t/2$. The number of FPs that build the photon is therefore $L/(\lambda_t/2)$ and we get for the energy of one FP

$$E_{FP} = \frac{E_t \lambda_t}{2 L} = \frac{h}{2 \tau} = 3.313 \cdot 10^{-26} J = 2.068 \cdot 10^{-7} eV \quad (109)$$

and for the angular frequency of the angular momentum h

$$\nu_{FP} = \frac{E_{FP}}{h} = \frac{1}{2 \tau} = 5 \cdot 10^7 s^{-1} \quad (110)$$

The number N_{FP_o} of FPs of an resting BSP (electron or positron) is

$$N_{FP_o} = \frac{E_o}{E_{FP}} = 2.4746 \cdot 10^{12} \quad (111)$$

Note: The frequency ν_t represents a linear frequency where the relation with the velocity v and the wavelength λ_t is given by $v = \lambda_t \nu_t$. The frequency ν_{FP} represents the angular frequency of the angular momentum h .

The momentum generated by a pair of FPs with opposed angular momenta is

$$p_{FP} = \frac{2 E_{FP}}{c} = 2.20866 \cdot 10^{-34} kg m s^{-1} \quad (112)$$

The angular momentum of a FP is $h = \rho p$ and we get

$$\rho = \frac{h}{p_{FP}} = 3.0 m \quad (113)$$

Note: Isolated FPs have only angular momenta, they have no linear momenta

and therefore cannot generate a force through the change of linear momenta . Linear momentum is generated only out of pairs of FPs with opposed angular momentum. It makes no sense to define a dynamic mass for FPS because they have no linear inertia, which is a product of the energy stored in FPs with opposed angular momenta. FPs that meet in space interact changing the orientation of their angular momenta but conserving each its energy $E_{FP} = 3.313 \cdot 10^{-26} J$.

14.2.2 Density of Fundamental Particles.

We have defined that

$$dE = E d\kappa = E \frac{1}{2} \frac{r_o}{r^2} dr \sin \varphi d\varphi \frac{d\gamma}{2\pi} \quad \text{and} \quad dV = r^2 dr \sin \varphi d\varphi d\gamma \quad (114)$$

resulting for the energy density

$$\omega = \frac{dE}{dV} = \frac{E}{4\pi} \frac{r_o}{r^4} \quad J m^{-3} \quad (115)$$

The density of FPs we define as

$$\omega_{FP} = \frac{\omega}{E_{FP}} = \frac{1}{4\pi} \frac{E}{E_{FP}} \frac{r_o}{r^4} \quad m^{-3} \quad (116)$$

with $E_{FP} = h \nu_{FP} = 3.313 \cdot 10^{-26} J$.

The concept is shown in Fig. 3

The energy emitted by a BSP is equal to the sum of the energies of the regenerating FPs with longitudinal (s) and transversal (n) angular momenta. The corresponding densities are

$$\omega_{FP}^{(s)} = \frac{1}{4\pi} \frac{E_s}{E_{FP}} \frac{r_o}{r^4} \quad \omega_{FP}^{(n)} = \frac{1}{4\pi} \frac{E_n}{E_{FP}} \frac{r_o}{r^4} \quad m^{-3} \quad (117)$$

As $E_e = E_s + E_n$ we get

$$\omega_{FP}^{(e)} = \omega_{FP}^{(s)} + \omega_{FP}^{(n)} \quad m^{-3} \quad (118)$$

The number dN_{FP} of FPs in a volume dV is given with

$$dN_{FP} = \omega_{FP} dV \quad \text{and with} \quad dV = r^2 dr \sin \varphi d\varphi d\gamma \quad (119)$$

we get

$$dN_{FP} = \frac{1}{2\pi} \frac{E}{E_{FP}} d\kappa \quad (120)$$

With the definition of $\mu_{FP} = E_{FP}/c^2$, where μ_{FP} is the dynamic mass of a FP, we get for the density of the mass

$$\omega_\mu = \frac{\mu_{FP} dN_{FP}}{dV} = \mu_{FP} \omega_{FP} \quad kg \ m^{-3} \quad (121)$$

The rest mass m of a BSP expressed as a function of the dynamic mass μ_{FP} of its FPs is

$$m = N_{FP_o} \mu_{FP} = \frac{\nu_o}{\nu_{FP}} \mu_{FP} \quad (122)$$

Note: In the present theory all BSPs are expressed through FPs with the Energy E_{FP} , the angular frequency ν_{FP} and the dynamic mass μ_{FP} .

14.3 Quantification of movement.

An isolated moving BSP has a potential energy

$$E = E_s + E_n \quad (123)$$

which is a function of the relative speed v to the selected reference coordinate. The potential energy will manifest when the isolated moving BSP interacts with a BSP which is static in the selected coordinate system.

The time variation Δt derived for the variation dp of the momentum for the Coulomb, Ampere and Induction forces between two BSPs, we use also as time variation to describe the movement of a BSP that moves with constant speed $v = \Delta x/\Delta t$ where $dp = 0$.

The energy E_n is responsible for the movement of the BSP and the number of FPs that generate the movement during the time Δt is

$$N_{FP}^{(n)} = \frac{E_n}{E_{FP}} \quad (124)$$

The total momentum of a BSP moving with constant speed v is therefore

$$p = m v = N_{FP}^{(n)} p_{FP} = m \frac{\Delta x}{\Delta t} \quad (125)$$

with p_{FP} defined in eq. (112). For Δx we get

$$\Delta x = N_{FP}^{(n)} p_{FP} \frac{\Delta t}{m} \quad (126)$$

For $v = 0$ we get

$$v = 0 \quad E_n = 0 \quad N_{FP}^{(n)} = 0 \quad \Delta x = 0 \quad (127)$$

For $v \rightarrow c$ we get with $\Delta t = K r_o^2$ with r_o the radius of the moving BSP

$$v \rightarrow c \quad E_p \rightarrow \infty \quad E_n \rightarrow \infty \quad N_{FP}^{(n)} \rightarrow \infty \quad \Delta t \rightarrow 0 \quad (128)$$

$$\lim_{v \rightarrow c} \Delta x = \lim_{v \rightarrow c} \frac{2 K \hbar^2 c}{m E_p} = 0 \quad for \quad v \rightarrow c \quad (129)$$

$$\lim_{v \rightarrow c} \frac{\Delta x}{\Delta t} = v \quad (130)$$

Note: For the isolated BSP moving with constant speed v we have no static probe BSP with radius r_{op} that measures the force between them, force that is zero because $dp = 0$. There is no difference between the two BSPs and the equation $\Delta t = K r_o r_{op}$ becomes $\Delta t = K r_o^2$ with r_o the radius of the moving BSP.

15 Quantification of forces between BSPs and CSPs.

In [10] the speed $v = k c$ was derived with which migrated BSP are reintegrated generating the Coulomb force and the two components of the gravitation force. In sec. 14.2.1 we have seen that the momentum generated by one pair of FPs with opposed angular momenta is

$$p_{FP} = \frac{2 E_{FP}}{c} = 2.20866 \cdot 10^{-34} \text{ kgms}^{-1} \quad (131)$$

We define now an elementary momentum

$$p_{elem} = m k c = 2.0309 \cdot 10^{-23} \text{ kgms}^{-1} \quad (132)$$

The number of pairs of FPs required to generate the momentum p_{elem} in the time $\Delta_o t$ is

$$\frac{p_{elem}}{p_{FP}} = 9.1951 \cdot 10^{10} \quad (133)$$

In the following subsections we express all known forces quantized in elementary linear momenta p_{elem} .

15.1 Quantification of the Coulomb force.

From the general eq. (25) from sec. 6 for the induced force, the Coulomb force between two BSPs was deduced in [10] giving

$$F_2 = \frac{a m c r_o^2}{4 \Delta_o t d^2} \int \int_{Coulomb} \quad \text{with} \quad \int \int_{Coulomb} = 2.0887 \quad (134)$$

We now write the equation as follows

$$F_2 = N_C(d) \frac{1}{\Delta_o t} p_{elem} = N_C(d) \nu_o p_{elem} \quad p_{elem} = m k c \quad a = 8.774 \cdot 10^{-2} \quad (135)$$

with

$$N_C(d) = \frac{a r_o^2}{4 k d^2} \int \int_{Coulomb} = 9.1808 \cdot 10^{-26} \frac{1}{d^2} \quad (136)$$

$N_C(d)$ gives the probability that FPs meet in space and generate opposed angular momenta.

We can define a frequency $\nu_C(d) = N_C(d) \nu_o$ which gives the number of elementary linear momenta p_{elem} during the time $\Delta_o t$ resulting in the force F_2 .

For an inter-atomic distance of $d = 10^{-10} m$ we get $N_C = 9.1808 \cdot 10^{-6}$ resulting a frequency of elementary momenta of

$$\nu_C(d) = N_C(d) \nu_o = 1.1359 \cdot 10^{15} s^{-1} \quad \text{for} \quad d = 10^{-10} m \quad (137)$$

15.2 Quantification of the Ampere force between straight infinite parallel conductors.

From the general eq. (23) from sec. 6 the Ampere force between two parallel conductors was derived in [10] arriving to

$$\frac{F}{dl} = \frac{b}{c \Delta t} \frac{r_o^2}{64 m} \frac{I_{m_1} I_{m_2}}{d} \int \int_{Ampere} \quad \text{with} \quad \int \int_{Ampere} = 5.8731 \quad (138)$$

and $b = 0.25$. We now write the equation in the following form assuming that the velocity of the electrons is $v \ll c$ so that $\Delta t \approx \Delta_o t$ and the currents are $I_m \approx \rho_x m v$, where $\rho_x = N_x/\Delta x$ is the linear density of electrons that move with speed v in the

conductors.

$$F = N_A(d, I_{m_1}, I_{m_2}, \Delta l) \nu_o p_{elem} \quad p_{elem} = k m c \quad \nu_o = \frac{1}{\Delta_o t} \quad (139)$$

with

$$N_A(d, I_{m_1}, I_{m_2}, \Delta l) = \frac{b r_o^2}{64 k m^2 c^2} \frac{I_{m_1} I_{m_2}}{d} \int \int_{Ampere} \Delta l \quad (140)$$

or

$$N_A(d, I_{m_1}, I_{m_2}, \Delta l) = 6.1557 \cdot 10^{17} \frac{I_{m_1} I_{m_2}}{d} \Delta l \quad (141)$$

For a distance of $1m$ between parallel conductors with a length of $\Delta l = 1m$ and currents of $1A$ we get $N_A = 6.1557 \cdot 10^{17}$. The frequency of elementary momenta for this particular case

$$\nu_A = N_A(d, I_{m_1}, I_{m_2}, \Delta l) \nu_o = 7.6158 \cdot 10^{37} s^{-1} \quad (142)$$

15.3 Quantification of the induced gravitation force (Newton).

From sec. 12 eq. (47) we have that the gravitation force for **one** aligned reintegrating BSPs is

$$F_i = \frac{k m c}{4 K d^2} \int \int_{Induction} \quad with \quad \int \int_{Induction} = 2.4662 \quad (143)$$

which we can write with $\Delta_o t = K r_o^2$ and $p_{elem} = k m c$ as

$$F_i = N_i \nu_o p_{elem} \quad with \quad N_i = \frac{r_o^2}{4 d^2} \int \int_{Induction} \quad (144)$$

Considering that $\Delta G_1 \Delta G_2 = \gamma_G^2 M_1 M_2$ we can write for the total force between two masses M_1 and M_2

$$F_G = F_i \Delta G_1 \Delta G_2 = N_G \nu_o p_{elem} \quad with \quad N_G = N_i \Delta G_1 \Delta G_2 \quad (145)$$

where N_G represents the probability of elementary forces $f_{elem} = \nu_o p_{elem}$ in the time $\Delta_o t = K r_o^2$.

Finally we get

$$F_G = N_G(M_1, M_2, d) \nu_o p_{elem} \quad \text{with} \quad N_G = 2.6555 \cdot 10^{-8} \frac{M_1 M_2}{d^2} \quad (146)$$

The frequency with which elementary momenta are generated is

$$\nu_G = N_G(M_1, M_2, d) \nu_o = 3.2856 \cdot 10^{12} \frac{M_1 M_2}{d^2} \quad (147)$$

For the earth with a mass of $M_{\oplus} = 5.974 \cdot 10^{24} \text{ kg}$ and the sun with a mass of $M_{\odot} = 1.9889 \cdot 10^{30} \text{ kg}$ and a distance of $d = 147.1 \cdot 10^9 \text{ m}$ we get a frequency of $\nu_G = 1.8041 \cdot 10^{45} \text{ s}^{-1}$ for aligned reintegrating BSPs.

15.4 Quantification of the gravitation force due to parallel reintegrating BSPs (Ampere).

From sec. 13 eq. (62) we have for a pair of parallel reintegrating BSPs that

$$dF_R = 5.8731 \frac{b}{\Delta_o t} \frac{2 r_o^3}{64} \rho^2 m k \frac{v_2}{d} = 2.2086 \cdot 10^{-50} \frac{v_2}{d} N \quad (148)$$

which we can write as

$$dF_R = N \nu_o p_{elem} \quad \text{with} \quad N = 8.7893 \cdot 10^{-48} \frac{v_2}{d} \quad (149)$$

where

$$p_{elem} = k m c \quad \text{and} \quad k = 7.4315 \cdot 10^{-2} \quad (150)$$

The total Ampere force between masses M_1 and m_2 is given with eq. (64)

$$F_R = 2.5551 \cdot 10^{-32} v_2 \frac{M_1 M_2}{d} N \quad (151)$$

We now write the equation in the form

$$F_R = N_R(M_1, M_2, d) \nu_o p_{elem} \quad \text{with} \quad N_R = 1.01682 \cdot 10^{-29} v_2 \frac{M_1 M_2}{d} \quad (152)$$

The frequency with which pairs of FPs cross in space is

$$\nu_R = N_R(M_1, M_2, d) \nu_o = 1.25811 \cdot 10^{-9} v_2 \frac{M_1 M_2}{d} \text{ s}^{-1} \quad (153)$$

For the earth with a mass of $M_{\oplus} = 5.974 \cdot 10^{24} \text{ kg}$ and the sun with a mass of $M_{\odot} = 1.9889 \cdot 10^{30} \text{ kg}$ and a distance of $d = 1.5 \cdot 10^8 \text{ m}$ and a tangential speed of the earth around the sun of $v_2 = 30 \text{ m/s}$ we get a frequency of $\nu_R = 2.9896 \cdot 10^{39} \text{ s}^{-1}$ for parallel reintegrating BSPs. The frequency ν_G for aligned BSPs is nearly 10^6 times grater than the frequency for parallel reintegrating BSPs and so the corresponding forces.

15.5 Quantification of the total gravitation force.

The total gravitation force is given by the sum of the induced force between aligned reintegrating BSPs and the force between parallel reintegrating BSPs.

$$F_T = F_G + F_R = [N_G(M_1, M_2, d) + N_R(M_1, M_2, d)] p_{elem} \nu_o \quad (154)$$

or

$$F_T = F_G + F_R = p_{elem} \nu_o \left[\frac{2.6555 \cdot 10^{-8}}{d^2} + \frac{1.01682 \cdot 10^{-29}}{d} v_2 \right] M_1 M_2 \quad (155)$$

We define the distance d_{gal} as the distance for which $F_G = F_R$ and get

$$d_{gal} = \frac{2.6555 \cdot 10^{-8}}{1.01682 \cdot 10^{-29} v_2} = 2.6116 \cdot 10^{21} \frac{1}{v_2} \text{ m} \quad (156)$$

16 Conventions introduced for BSPs.

Fig. 18 shows the convention used for the two types of electrons and positrons introduced.

The accelerating positron emits FPs with high speed $v_e = \infty$ and positive longitudinal angular momentum \bar{J}_s^+ ($\infty+$) and is regenerated by FPs with low speed $v_r = c$ and negative longitudinal angular momentum \bar{J}_s^- ($c-$).

The decelerating electron emits FPs with low speed $v_e = c$ and negative longitudinal angular momentum \bar{J}_s^- ($c-$) and is regenerated by FPs with high speed $v_r = \infty$ and positive longitudinal angular momentum \bar{J}_s^+ ($\infty+$).

The emitted FPs of the accelerating positron regenerate the decelerating electron and the emitted FPs of the decelerating electron regenerate the accelerating positron.

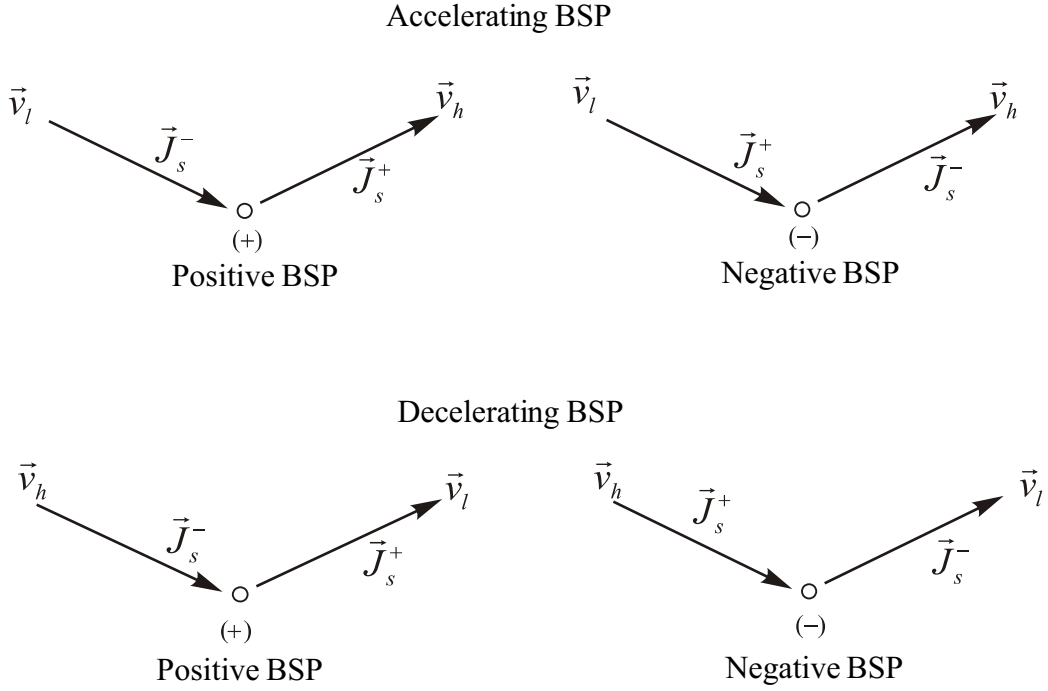

Figure 18: Conventions for BSPs

Fig. 19 a) shows a neutron with the internal and external rays for emitted and regenerating FPs. The complex SP is formed by accelerating positrons and decelerating electrons.

Fig. 19 b) shows a proton with the net external rays for emitted and regenerating FPs. The complex SPs is formed by accelerating positrons and decelerating electrons.

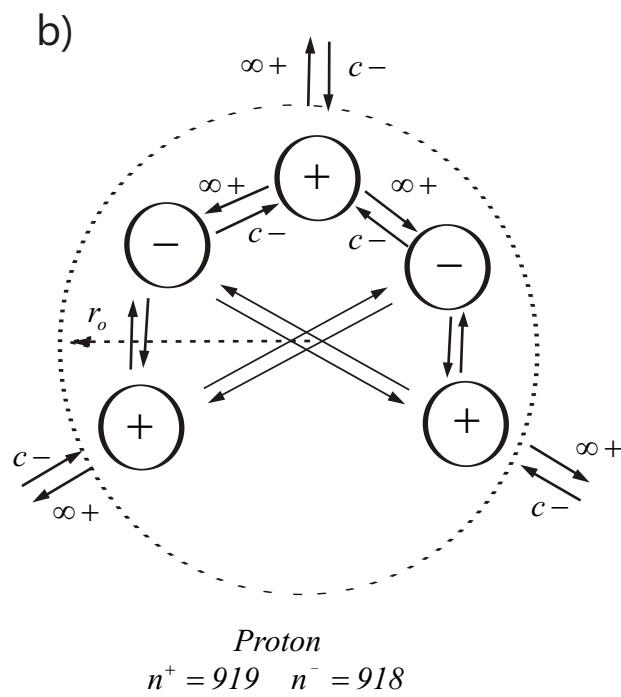
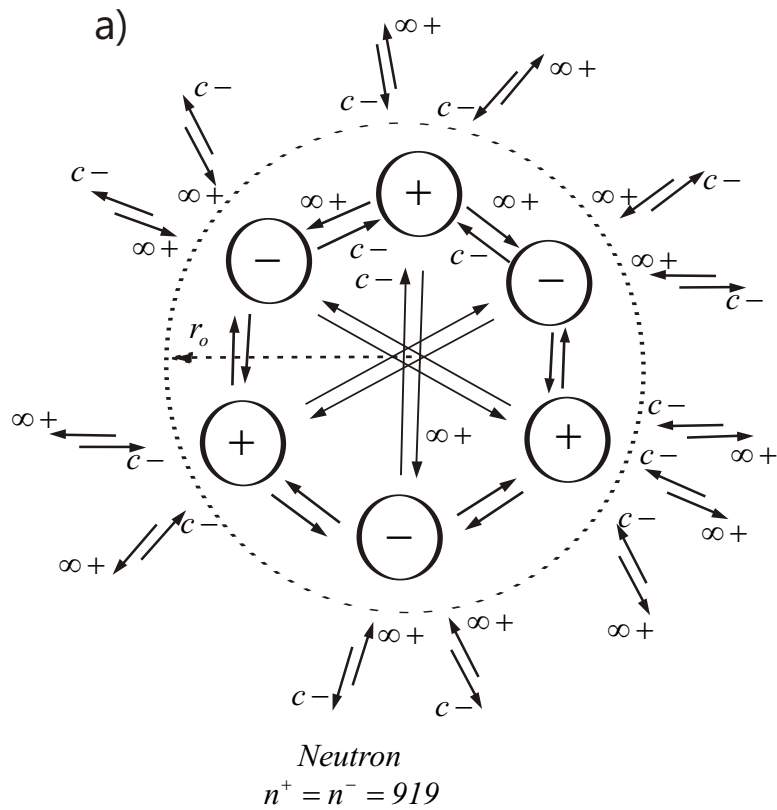

Figure 19: Neutron and proton composed of accelerating positrons and decelerating electrons

Fig. 20 shows a neutron with one migrated BSP and the net external field.

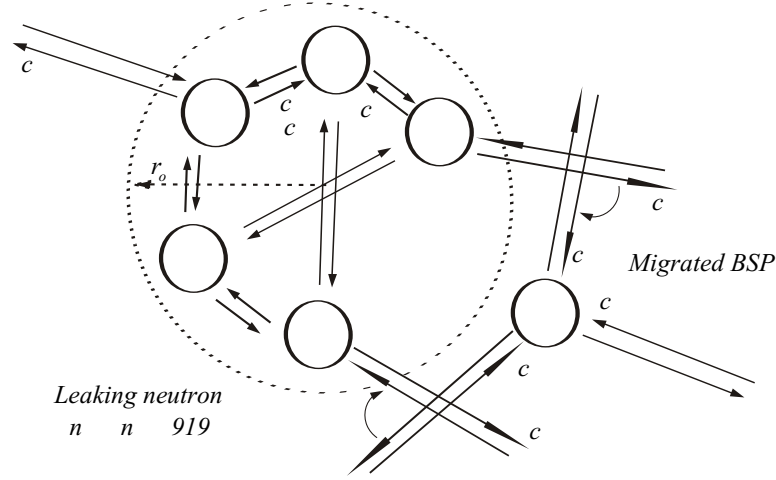

Figure 20: Neutron with migrated BSP

17 Flux density of FPs and scattering of particles.

17.1 Flux density of FPs.

At each BSP the flux density of emitted FPs is equal to the flux density of regenerating FPs although the different speeds of the FPs.

In a complex SP formed by more than one BSP (Fig.19), a mutual internal regeneration between the BSPs of the complex SP exists. Part of the emitted positive rays of FPs with $\bar{J}_e^{(+)}$ of the positive BSPs of the complex SP regenerate the negative BSPs of the complex SP, and part of the emitted negative rays of FPs with $\bar{J}_e^{(-)}$ of the negative BSPs regenerate the positive BSPs. The other part of the emitted and regenerating rays of FPs respectively radiate into space and regenerate from space.

At a complex SP with equal number of positive and negative BSPs Fig.19 a) the flux density of FPs radiated into space with positive angular momenta is equal to the flux density of FPs radiated into space with negative angular momenta. The same is valid for the flux density of regenerating FPs.

At a complex SP with different number of positive and negative BSPs Fig.19 b) the flux density of FPs radiated into space with positive angular momenta is not equal to the flux density of FPs radiated into space with negative angular momenta. If the complex SP has more positive BSPs in the nucleous, the flux density of FPs radiated

into space with positive angular momenta is bigger than the flux density of FPs radiated into space with negative angular momenta and vice versa.

17.2 Scattering of particles.

Elastic scattering.

Elastic scattering we have when the scattering partners conserve their identity. No photons, neutrinos, electrons, positrons, protons, neutrons are emitted.

There are two types of elastic scatterings according the smallest scattering distance d_s that is reached between the scattering partners.

”**Electromagnetic**” scattering we have when the smallest scattering distance d_s is in the fifth region of the linear momentum curve p_{stat} of Fig.7 where the Coulomb force is valid. Electromagnetic scattering is characterized by the inverse square distance force between particles.

”**Mechanical**” scattering we have when the smallest scattering distance d_s is in the fourth region of Fig.7. Mechanical scattering is characterized by the combination of inverse square distance and inverse distance forces between particles.

Plastic or destructive scattering.

Plastic scattering we have when the identity of the scattering partners is modified and photons, neutrinos, electrons, positrons, protons or neutrons are emitted.

In plastic or destructive scattering the smallest scattering distance d_s enters the third and second region of the linear momentum curve p_{stat} of Fig.7.

The internal distribution of the BSPs is modified and the acceleration disturbs the internal mutual regeneration between the BSPs. The angular momenta of each BSP of the scattering partners interact heavily, and new basic configurations of angular momenta are generated, configurations that are balanced or unbalanced (stable or unstable).

In today’s point-like representation the energy of a BSP is concentrated at a point and scattering with a second BSP requires the emission of a particle (gauge boson) to overcome the distance to the second BSP which then absorbs the particle. The energy violation that results in the rest frame is restricted in time through the uncertainty principle and the maximum distance is calculated assigning a mass to the interchanged particle (Feynman diagrams).

Conclusion: In the present approach the emission of FPs by BSPs is continuous and not restricted to the instant particles are scattered. In the rest frame of the scattering partners no energy violation occurs. When particles are destructively scattered, during a transition time the angular momenta of all their FPs interact heavily according to the three interaction from sec. 5 and new basic arrangements of angular momenta are produced, resulting in balanced and unbalanced configurations of angu-

lar momenta that are stable or unstable, configurations of quarks, hadrons, leptons and photons. The interacting particles (force carriers) for all types of interactions (electromagnetic, strong, weak, gravitation) are the FPs with their longitudinal and transversal angular momenta.

The concept is shown in Fig. 21

Note: The proposed theory considers **elementary particles** those which are stable as free particles or as part of composed particles like the electron, positron, neutron, proton, neutrino, photon, nuclei of atoms. All particles with a short life time (transitory particles) are not elementary particles and are produced at collisions. With increasing collision energies more and more transitory particles of higher energies can be produced without adding new substantial information to the theory.

Clasification of particles

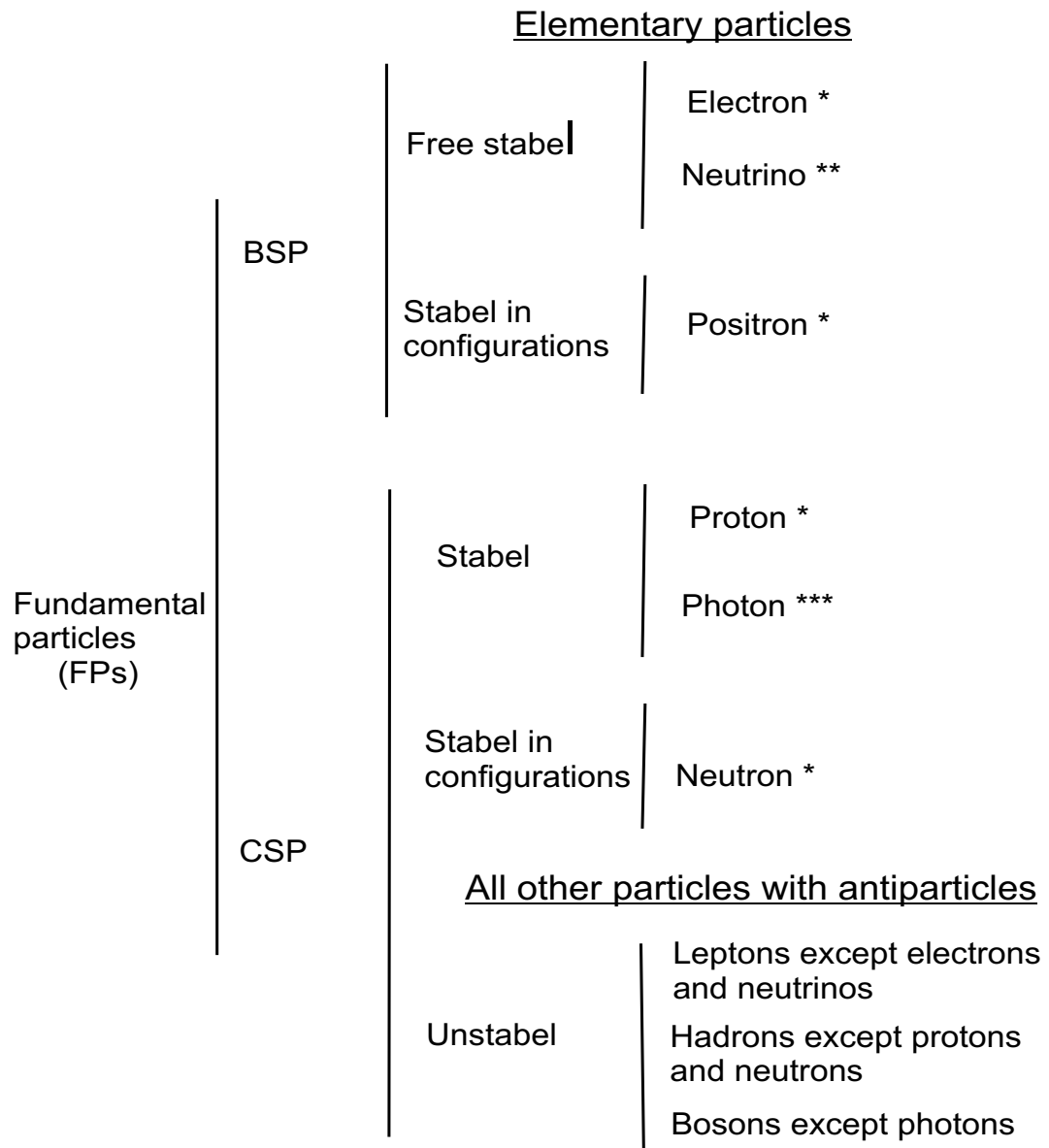

Legend

BSP =Basic Subatomic Particles

CSP=Complex Subatomic Particles (composed of BSP)

* Focal point of rays of FPs

** Pair of FPs with opposed angular momenta

*** Sequence of pairs of FPs with opposed angular momenta

Figure 21: Clasification of particles

17.3 Feynman diagram.

The proposed approach postulates that the force carriers between the focal points, which replace the subatomic particles, are the FPs with their dH fields. The forces between the subatomic particles are generated by the interactions of the angular momenta of their FPs or dH fields, and not by the exchanges of particles as the standard model teaches.

A flawless analysis of the disintegration of radioactive nuclei shows that there is no violation of conservation of energy, contrary to Feynmans conclusions.

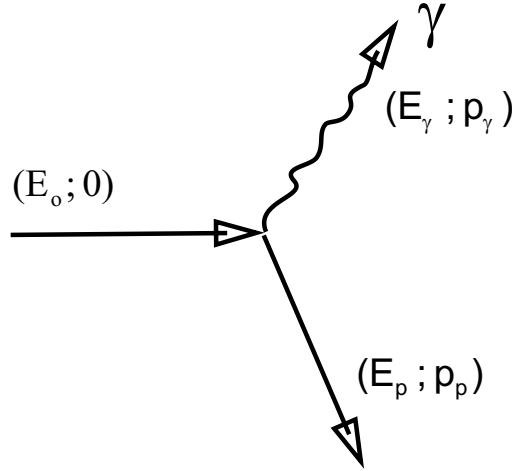

Figure 22: Feynman diagram

The concept is shown in Fig. 22

$$(E_o; 0) \rightarrow (E_p; p_p) + (E_\gamma; p_\gamma) \quad (157)$$

$$E_k = \sqrt{E_o'^2 + E_p^2} \quad E_p = p_p c \quad E_\gamma = p_\gamma c \quad (158)$$

with

$$\bar{p}_p = -\bar{p}_\gamma \quad E_p = E_\gamma \quad (159)$$

$$\Delta E = E_k + E_\gamma - E_o = \sqrt{E_o'^2 + E_p^2} + E_\gamma - E_o \quad (160)$$

For $\Delta E = 0$ we get

$$E_o' = \sqrt{E_o^2 - 2 E_o E_p} = \sqrt{E_o^2 - 2 E_o E_\gamma} \quad (161)$$

For stable BSPs like the electron and the positron which don't disintegrate by radiation $E_p = E_\gamma = 0$ and $E_o' = E_o$.

For CSPs like heavy nuclei that disintegrate by radiation $E_p > 0$ and $E_o' < E_o$.

The same analysis is valid for nuclei that radiate α , β and γ particles. The radiated energy goes always in detriment of the rest mass E_o of the nuclei. No violation of conservation of energy occurs.

18 Emission Theory.

The present approach is based on the postulate that light is emitted with light speed relative to the emission source.

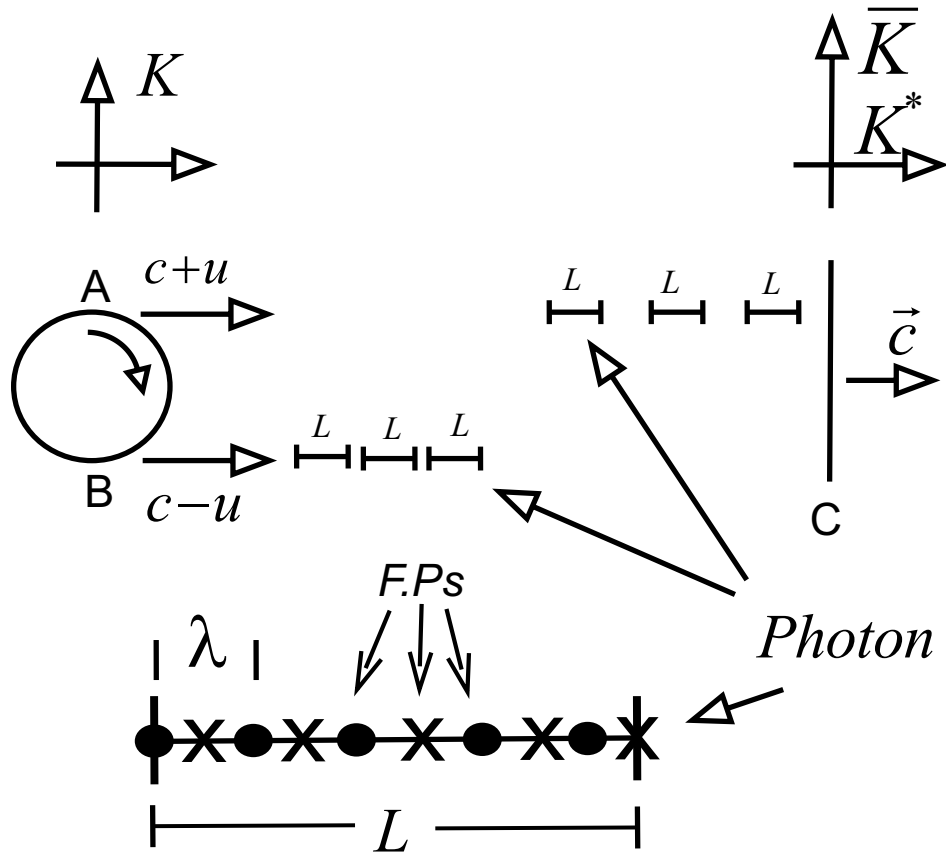

Figure 23: Emission Theory.

Fig 23 shows how bursts of FPs with opposed angular momenta (photons) emitted with light speed c by a star in a double star system, travel from frame K to frames \bar{K} and K^* with speeds $c+u$ from A and $c-u$ from B . When they arrive at the measuring instruments at C , the transformations to the frames \bar{K} and K^* take place from where they continue than with the speed of light c .

The emission time of photons from **isolated** atoms is approximately $\tau = 10^{-8}$ s what gives a length for the wave train of $L = c \tau = 3$ m. The total energy of the emitted photon is $E_t = h \nu_t$ and the wavelength is $\lambda_t = c/\nu_t$. We have defined that

the photon is composed of a train of FPs with alternated angular momenta where the distance between two consecutive FPs is equal $\lambda_t/2$. The number of FPs that build the photon is therefore $L/(\lambda_t/2)$ and we get for the energy of one FP

$$E_{FP} = \frac{E_t \lambda_t}{2 L} = \frac{h}{2 \tau} = 3.313 \cdot 10^{-26} \text{ J} = 2.068 \cdot 10^{-7} \text{ eV} \quad (162)$$

and for the angular frequency of the angular momentum h

$$\nu_{FP} = \frac{E_{FP}}{h} = \frac{1}{2 \tau} = 5 \cdot 10^7 \text{ s}^{-1} \quad (163)$$

The number N_{FP_o} of FPs of an resting BSP (electron or positron) is

$$N_{FP_o} = \frac{E_o}{E_{FP}} = 2.4746 \cdot 10^{12} \quad (164)$$

Note: The assumption of our standard model that light moves with light speed c independent of the emitting source induces the existence of an absolute reference frame or ether, but at the same time the model is not compatible with such absolute frames.

The objections made by Willem de Sitter in 1913 about Emission Theories based on a star in a double star system, is based on a representation of light as a continuous wave and not as bursts of sequences of FPs with opposed transversal angular momenta with equal length L .

In the quantized representation photons with speeds $c + v$ and $c - v$ may arrive simultaneously at the measuring equipment showing the two Doppler spectral lines corresponding to the red and blue shifts in accordance with Kepler's laws of motion. No bizarre effects, as predicted by Willem de Sitter, will be seen because photons of equal length L and λ with speeds $c + v$ and $c - v$ are detected independently by the measuring instrument giving well defined lines corresponding to the Doppler effect.

The present approach is based on a modern physical description of nature postulating that

- photons are emitted with light speed c relative to their source
- photons emitted with c in one frame that moves with the speed v relative to a second frame, arrive to the second frame with speed $c \pm v$.
- photons with speed $c \pm v$ are reflected with c relative to the reflecting surface
- photons refracted into a medium with $n = 1$ move with speed c independent of the speed they had in the first medium with $n \neq 1$.

The concept is shown in Fig. 24

When the Lorentz transformation is applied with the above postulates, "Special Relativity without time delay and length contraction" results as shown in [10].

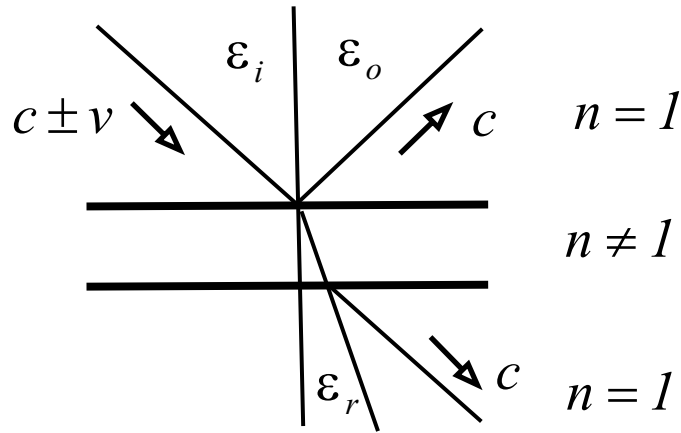

Figure 24: Light speed at reflections and refractions

18.1 Sagnac effect.

In the SM the results of the Sagnac experiment are not compatible with Special Relativity and are easily explained with non relativistic equations but still assuming that light moves with light speed independent of its source.

The equations for the Sagnac experiment are now derived based on the emission, reflection and refraction postulates.

The concept is shown in Fig. 25

Fig. 1 of Fig. 25 shows the arrangement with a light source at point “0” and a detector for the two counter-rotating light rays also at point “0’”. Mirrors are placed at points “1”, “2”,”n” of the ring. The tangential speed of the rotating arrangement is “v”.

Points “0” and “1” are placed in the parallel planes “a” and “b”. For the time a photon of the length L and wavelength λ takes to pass from plane “a” to plane “b” the relative speed between them of $v_r = v(1 - \cos \varphi)$ can be assumed constant. If we imagin that plane “a” moves relative to plane “b” then, according to the emission theory, the speed of the ray that leaves “a” in the direction of “ b “ has the speed $v_{b_i} = c - v_r$ as shown in Fig. 2 of Fig. 25.

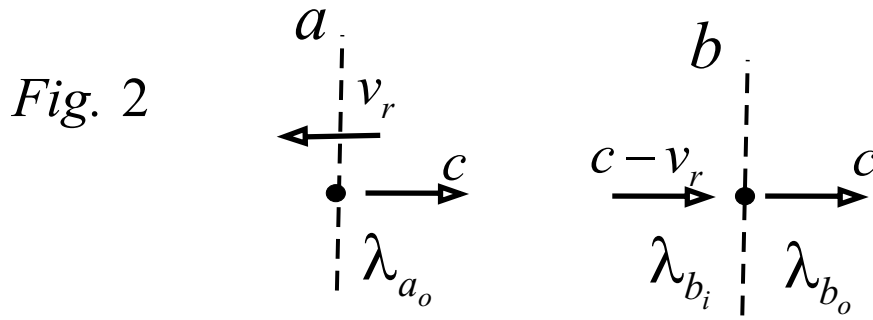
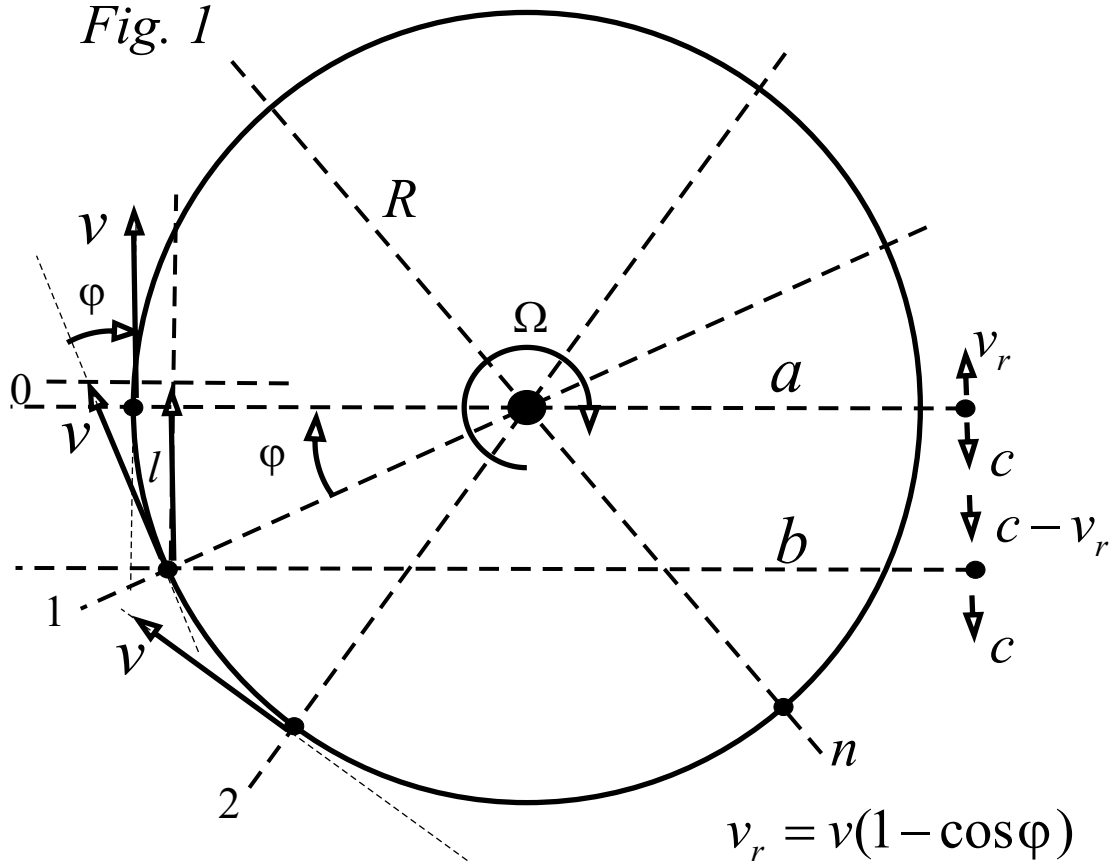

Figure 25: Sagnac experiment

Also according to the emission theory the output wavelength λ_{a_o} at "a" must be equal to the input wavelength λ_{b_i} . We get for the frequencies ν

$$\lambda_{b_i} = \frac{c - v_r}{\nu_{b_i}} = \lambda_{a_o} \quad \rightarrow \quad \nu_{b_i} = \frac{c - v_r}{\lambda_{a_o}} \quad (165)$$

The frequencies at the input and output of plane "b" must be equal

$$\nu_{b_i} = \frac{c - v_r}{\lambda_{a_o}} = \nu_{b_o} = \frac{c}{\lambda_{b_o}} \quad \rightarrow \quad \lambda_{b_o} = \frac{c}{c - v_r} \lambda_{a_o} \quad (166)$$

Writing the last equation with the nomenclature used for the points “0” and “1” we get

$$\lambda_{1_o} = \frac{c}{c - v_r} \lambda_{0_o} \quad (167)$$

and for the points “1” and “2” we get

$$\lambda_{2_o} = \frac{c}{c - v_r} \lambda_{1_o} = \left(\frac{c}{c - v_r} \right)^2 \lambda_{0_o} \quad (168)$$

Generalising for “n” we get for the ray in counter clock direction

$$\lambda_{n_o} = \left(\frac{c}{c - v_r} \right)^n \lambda_{0_o} = \frac{1}{(1 - v_r/c)^n} \lambda_{0_o} \quad (169)$$

and for the ray in clock direction

$$\lambda'_{n_o} = \left(\frac{c}{c + v_r} \right)^n \lambda_{0_o} = \frac{1}{(1 + v_r/c)^n} \lambda_{0_o} \quad (170)$$

With

$$(1 \pm v_r/c)^{-n} = 1 \mp n(v_r/c) + \frac{n(n+1)}{2!} (v_r/c)^2 \mp \dots \quad \text{for } |v_r/c| < 1 \quad (171)$$

neglecting all non linear terms we get for the wavelength

$$\lambda_{detect} = 1 + n(v_r/c) \lambda_{0_o} \quad \lambda'_{detect} = 1 - n(v_r/c) \lambda_{0_o} \quad (172)$$

and for the difference

$$\Delta \lambda_{detect} = \lambda_{detect} - \lambda'_{detect} = 2 n(v_r/c) \lambda_{0_o} \quad (173)$$

With R the radius of the ring we have that $\Omega = v/R$ and with $v_r = v(1 - \cos \varphi)$ we get

$$\Delta \lambda_{detect} = 2 n \frac{R(1 - \cos \varphi) \lambda_{0_o}}{c} \Omega \quad (174)$$

For $n \gg 1$ and with l the length of the arc on the ring between two consecutive mirrors, we can write that $2\pi R m \approx n l$ with m the number of windings of the fibre coil. We also have that $\cos \varphi \approx 1 - \varphi^2/2$ and that $\varphi = l/R$. We get

$$\Delta \lambda_{detect} = 2 \pi m \frac{l}{c} \lambda_{0_o} \Omega \quad (175)$$

The wavelength difference between the clock and anticlockwise waves is proportional

to the angular speed Ω of the arrangement.

The interference of two sinusoidal waves with nearly the same frequencies ν and wavelengths λ is given with

$$F(r, t) = 2 \cos \left[2\pi \left(\frac{r}{\lambda_{mod}} - \Delta\nu t \right) \right] \sin \left[2\pi \left(\frac{r}{\lambda} - \nu t \right) \right] \quad \lambda_{mod} \approx \frac{\lambda^2}{\Delta\lambda} \quad (176)$$

For our case it is $\Delta\nu = 0$ and $\Delta\lambda = \Delta\lambda_{detect}$ and we get

$$F(r, t) = 2 \cos \left[4\pi^2 m \frac{l}{\lambda_0 c} r \Omega \right] \sin \left[2\pi \left(\frac{r}{\lambda_0} - \nu_0 t \right) \right] \quad (177)$$

For a given arrangement the argument of the sinus wave varies with r for a given Ω following a cosinus function.

For the intensity of the interference of two light waves with equal frequencies but differing phases we have

$$I(r) = I_1(r) + I_2(r) + 2 \sqrt{I_1(r) I_2(r)} \cos[\varphi_1(r) - \varphi_2(r)] \quad (178)$$

The phases are in our case

$$\varphi_1(r) = 2\pi \frac{r}{\lambda_0^2} \Delta\lambda_{detect} \quad \varphi_2(r) = - 2\pi \frac{r}{\lambda_0^2} \Delta\lambda_{detect} \quad (179)$$

The intensity of the interference fringes are given with

$$I(r) = I_1(r) + I_2(r) + 2 \sqrt{I_1(r) I_2(r)} \cos \left[4\pi^2 m \frac{l}{\lambda_0 c} r \Omega \right] \quad (180)$$

The fringes of the intensity vary with r for a given Ω following a cosinus function .

We have derived the interference patterns for the sagnac arrangement based on the emission postulate that light is emitted with light speed c relative to its source and that light is refracted or reflected with light speed independent of the input speed. There is no incompatibility with ‘‘SR without time delay and length contraction’’.

19 BSP with light speed.

BSPs with speeds $v \neq c$ emit and are regenerated continuously by fundamental particles that have longitudinal and transversal angular momenta. With $v \rightarrow c$, eq. (7) becomes zero and so the longitudinal field $d\bar{H}_s$ and the corresponding angular momentum \bar{J}_s . According eq. (8) only the transversal field $d\bar{H}_n$ and the corresponding angular momentum \bar{J}_n remain. With $v \rightarrow c$, the BSP reduces to a pair of FPs with opposed transversal angular momenta \bar{J}_n , with no emission (no charge) nor regeneration.

The concept is shown in Fig. 26

Fig. 26 shows at **a)** a BSP with parallel \bar{p}_c^{\parallel} linear momentum and at **b)** with transversal \bar{p}_c^{\perp} linear momentum. At **c)** a possible configuration of a photon is shown as a sequence of BSPs with light speed with alternated transversal linear momentums \bar{p}_c^{\perp} , which gives the wave character, and intercalated BSPs with longitudinal momentums \bar{p}_c^{\parallel} that gives the particle character to the photon.

Conclusion: BSPs with light speed are composed of pairs of FPs with opposed angular momenta \bar{J}_n , they don't emit and are not regenerated by FPs. They are not bound to an environment that supplies continuously FPs to regenerate them. The potential linear momentum \bar{p}_c of each pair of opposed angular momenta can have any orientation relative to the speed \bar{c} . BSPs with light speed can be identified with the neutrinos.

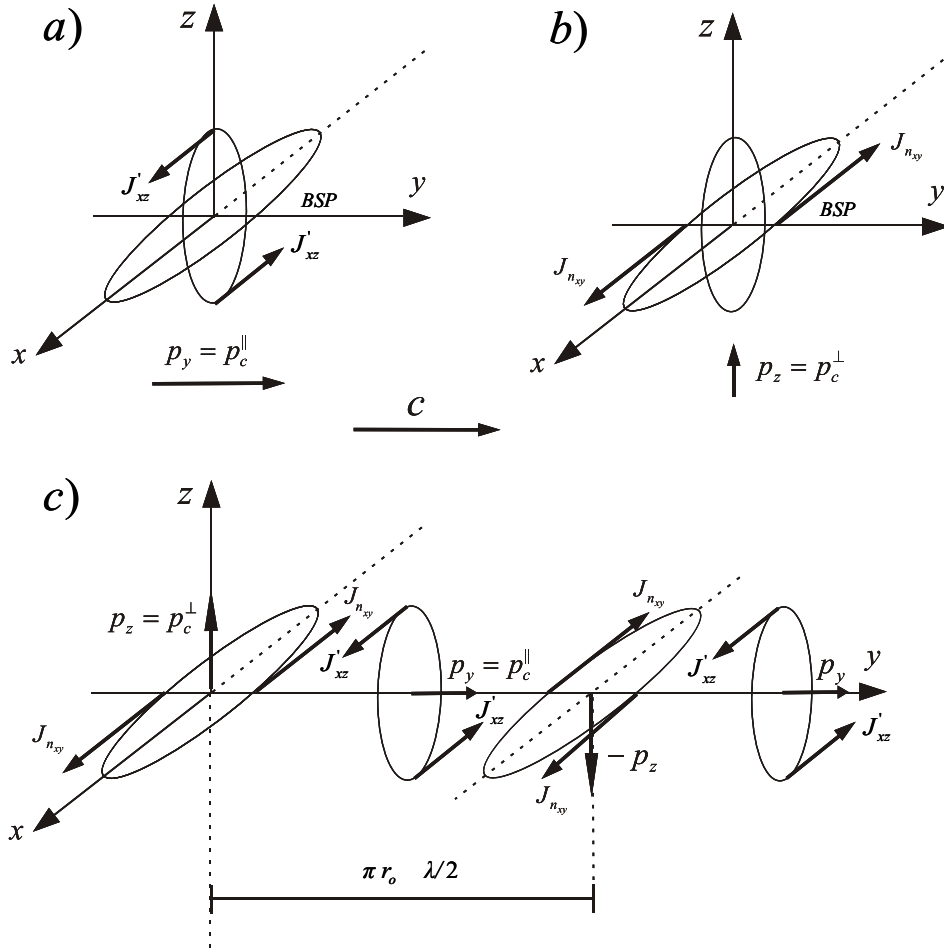

Figure 26: Different forms of BSP with light speed

19.1 Redshift of the energy of a complex BSP with light speed (photon) in the presence of matter.

Fig. 27 shows a sequence of BSPs with light speed (photon) with their potential linear momenta p before and after the interaction with the ray of regenerating FPs of the BSPs of matter. When the regenerating rays are approximately perpendicular to the trajectory of the opposed dH_n (dots and crosses) fields of the photon, part of the energy of the dH_n field is absorbed by the regenerating FPs of the ray and carried to the BSPs of the matter. The photon doesn't change its direction and loses energy to the BSPs of the matter shifting its frequency to the red. The inverse process is not possible because the BSPs of the photon (opposed dH_n fields) have no regenerating rays of FPs that can carry energy from the BSPs of matter and shift the frequency to the violet.

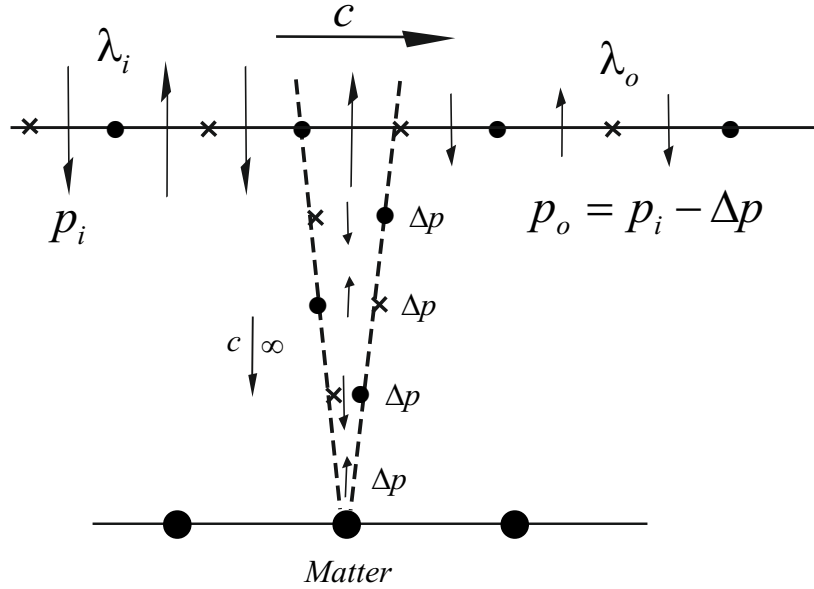

Figure 27: Loss of energy of a BSP with $v = c$

The process of loss of energy is according the interaction law **3**) of sec. 5 which postulates that pairs of regenerating FPs with longitudinal angular momenta from a BSP can adopt opposed pairs of transversal angular momentum from another BSP (see Fig. 11). As photons have no regenerating FPs they can only leave pairs of transversal angular momentum to other BSPs and lose energy. During the red shift, two adjacent opposed potential linear momenta of the photon compensate partially by passing part of their opposed linear momenta to the BSP of matter.

The energy exchanged between a photon and an electron is

$$E_i = \frac{h c}{\lambda_i} \quad E_b = \frac{p_b^2}{2 m_p} \quad (181)$$

The frequency shift of the photon is with $E_i = E_o + E_b$

$$\Delta\nu = \nu_i - \nu_o = \frac{1}{h}(E_i - E_o) = \frac{E_b}{h} \quad z = \frac{\Delta\nu}{\nu_i} \quad (182)$$

where $E_i = h c/\lambda_i$ is the energy before the interaction, $E_o = h c/\lambda_o$ the energy after the interaction and E_b the energy carried to the BSP of matter.

Light that comes from far galaxies loses energy to cosmic matter resulting in a red shift approximately proportional to the distance between galaxy and earth (Big Bang).

Light is not bent by gravitation nor by a bending target, it is reflected and refracted by a target.

19.1.1 Refraction and red-shift at the sun.

Fig.28 shows two light rays one passing outside the atmosphere of the sun and one through the atmosphere. The first ray is red shifted due to regenerating FPs of matter of the sun as explained with Fig. 27. The second ray is refracted in the direction of the sun surface when crossing the sun atmosphere. Due to the refractions the speed in the atmosphere is $v < c$. Red-shift is also possible at the second ray but not shown in the drawing.

Note: Bending takes place only between BSPs with rest mass.

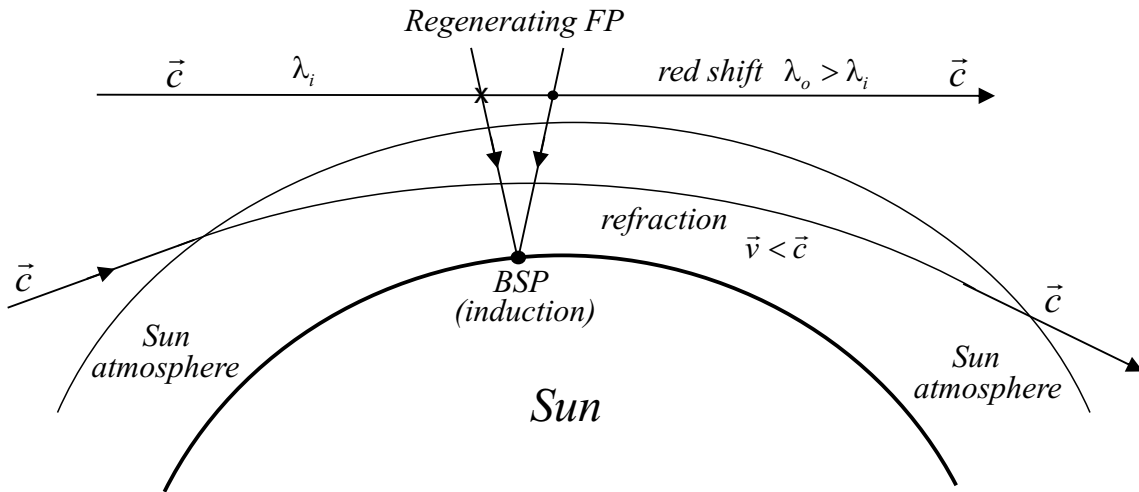

Figure 28: Refraction and red-shift at the Sun

19.1.2 Cosmic Microwave Background radiation.

From Fig. 27 we have learned how a photon passes energy to matter shifting its frequency to red. The transfer of energy takes place according postulate 8 from rays that not necessarily hit directly matter. If we put on the place of the matter the microwave detector of the COBE satellite we see how microwave radiation from radiating bodies that are not placed directly in front of the detector lenses can reach the detector. What is measured at the FIRAS (Far-InfraRed Absolute Spectrophotometer), a spectrophotometer (Spiderweb Bolometer) used to measure the spectrum of the CMB, is the energy lost by microwave rays that pass in front of the detector lenses. The so called Cosmic- Background Radiation is not energy that comes from microwave rays that have their origin in the far space in a small space angle around the detector axis. As the loss of energy from rays of photons to the microwave detector that don't hit directly the detector is very low, the detector must be cooled down to very low temperatures to detect them.

20 Interpretation of Data in a theoretical frame.

A theory like our Standard Model was improved over time to match with experimental data introducing fictitious entities (particle wave, gluons, gravitons, dark matter, dark energy, time dilation, length contraction, Higgs particle, Quarks, Axions, etc.) and helpmates (duality principle, equivalent principle, uncertainty principle, violation of energy conservation, etc.) taking care that the theory is as consistent and free of paradoxes as possible. The concept is shown in Fig. 29. These improvements were integrated to the existing model trying to modify it as less as possible what led, with the time, to a model that resembles a monumental patchwork. To return to a mathematical consistent theory without paradoxes (contradictions) a completely new approach is required that starts from the basic picture we have from a particle. "E & R" UFT is such an approach representing particles as focal points in space of rays of FPs. This representation contains from the start the possibility to describe interactions between particles through their FPs, interactions that the SM with its particle representation attempts to explain with fictitious entities.

Fallacy used to conclude that the existence of fictitious entities is experimentally proven

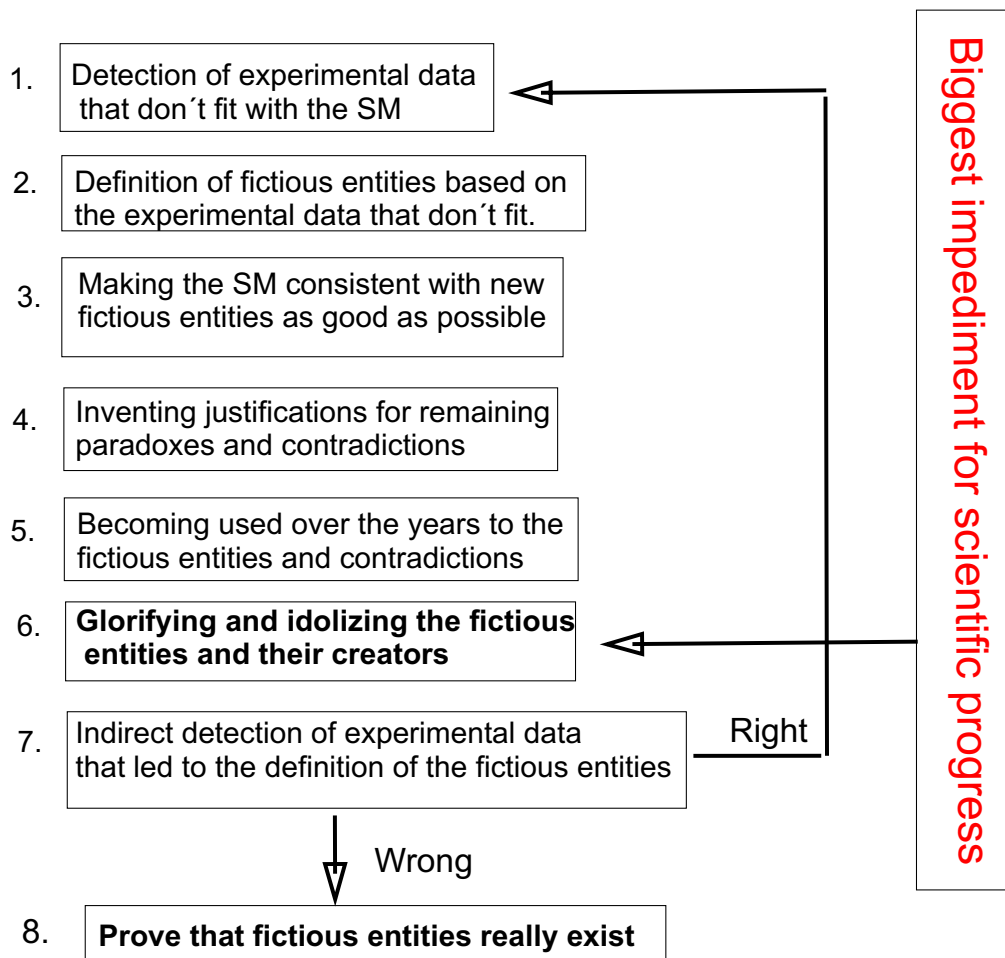

Fictitious entities of the SM

Particle wave
 Gravitons
 Dark energy
 Length contraction
 Quarks
 Gluons
 Dark matter
 Time dilation
 Higgs
 Axions

Helpmates of the SM

Duality principle
 Equivalent principle
 Uncertainty principle
 Violation of energy conservation (Faynman)

Figure 29: Fallacy used to conclude that fictitious entities really exist

Fig. 29 is an organigram where the main steps of the integration of fictitious entities to the SM are shown. All experiments where the previously defined fictitious entities are indirectly detected (point 7. of Fig. 29) are not a confirmation of the existence of the fictitious entities (point 8. of Fig. 29), they are simply the confirmation that the model was made consistent with the fictitious entities (point 3. of Fig. 29).

All experiments where time dilation or length contraction are apparently measured are indirect measurements and where the experimental results are explained with time dilation or length contraction, which stand for the interactions between light and the

measuring instruments, interactions that were omitted.

In the case of the increase of the life time of moving muons the increase is because of the interactions between the FPs of the muons with the FPs of the matter that constitute the real frame relative to which the muons move. To explain it with time dilation only avoids that scientists search for the real physical origin of the increase of the life time.

21 Findings of the proposed approach.

The main findings of the proposed model [10], from which the present paper is an extract, are:

- The energy of a BSP is stored as rotations in FPs defining the longitudinal angular momenta of the emitted fundamental particles. The rotation sense of the longitudinal angular momenta of emitted fundamental particles defines the sign of the charge of the BSP.
- All the basic laws of physics (Coulomb, Ampere, Lorentz, Maxwell, Gravitation, bending of particles and interference of photons, Bragg) are derived from one vector field generated by the longitudinal and transversal angular momenta of fundamental particles, laws that in today's theoretical physics are introduced by separate definitions.
- The interacting particles (force carriers) for all types of interactions (electromagnetic, strong, weak, gravitation) are the FPs with their longitudinal and transversal angular momenta.
- Quantification and probability are inherent to the approach.
- The incremental time to generate the force out of linear momenta is quantized.
- Gravitation has its origin in the induced momenta when BSPs that have migrated outside their nuclei are reintegrated.
- The gravitation force is composed of an induced component and a component due to parallel currents of reintegrating BSPs. For galactic distances the induced component can be neglected, what explains the flattening of galaxies' rotation curve. (dark matter).
- The photon is a sequence of BSPs with potentially opposed transversal linear momenta, which are generated by transversal angular momenta of FPs that comply with specific symmetry conditions (pairs of opposed angular momenta).

- Permanent magnets are explained through closed energy flows at static BSPs stored in transversal angular momenta of FPs.

Bibliography

Note: The present approach is based on the concept that fundamental particles are constantly emitted by electrons and positrons and constantly regenerate them. As the concept is not found in mainstream theory, no existing paper can be used as reference.

1. Günter Lehner. **Elektromagnetische Feldtheorie**. 7. bearbeitete Auflage 2010. Springer Verlag.
2. Hering · Martin · Stohrer. **Physik für Ingenieure**. Vierte, verbesserte Auflage 1992. VDI Verlag.
3. Albrecht Lindner. **Grundkurs Theoretische Physik**. Teubner Verlag, Stuttgart 1994.
4. Georg Joos. **Lehrbuch der Theoretischen Physik**. 15., völlig neu bearbeitete Auflage 1989. AULA-Verlag Wiesbaden.
5. Max Schubert / Gerhard Weber. **Quantentheorie, Grundlagen und Anwendungen**. Spektrum, Akad. Verlag 1993.
6. Harald Klingbeil. **Electromagnetische Feldtheorie**. 2. überarbeitete Auflage 2011, Vieweg + Teubner Verlag.
7. Benenson · Harris · Stocker · Lutz. **Handbook of Physics**. Springer Verlag 2001.
8. B.R. Martin & G. Shaw. **Particle Physics**. John Wiley & Sons 2003.
9. Stephen G. Lipson. **Optik**. Springer Verlag 1997.
10. Osvaldo Domann. **“Emission & Regeneration” Field Theory**. June 2003. www.odomann.com.