

The Impossible Zero Point Electric Black Hole:

**Leo Vuyk,
Architect,
the Netherlands.**

Abstract.

Recent turmoil around the foundation of Black hole theory principles by Stephen Hawking and others, is a clear sign of great uncertainty about black holes and adjacent subjects.

As a consequence, it seems a good moment to come up with a Black Hole alternative already prepacked in my Quantum FFF Theory (Function Follows Form)

Quantum FFF (Function Follows Form) theory states, that the vacuum is seeded with fast opposite oscillating massless 3-Dimensional torus shaped Preons, responsible for pair production. Two Preons are able to change form into two entangled Fermion propeller strings by an overflow of energetic opposite collision. This energy overflow is supposed to be present at the black hole event horizon (fig 5).

Thus the FORM of all particles is based on real joints and gears, responsible for the FUNCTION even for composite Quarks and Photons, however all particles are instant entangled and guided in a dual mirror multiversal way.

That dual oscillating Higgs particles are the same as Preons and are responsible for the Casimir Dark Energy of 126 GeV recently observed in the LHC at CERN.

That the oscillating Higgs vacuum system is the messenger medium of all Photon information and Black Holes are equipped with a nucleus of compacted Higgs particles, compressed by the oscillating Higgs vacuum.

The vacuum energy flow around such a Black hole indicates that different sized globular horizons are needed, an event or Photon horizon and two Fermion repulsion horizons, which can explain lots of astronomical unresolved phenomena.

Introduction.

In Quantum FFF theory it is assumed that there are four kinds of dark matter black holes,
1: The Big Bang – or Big Crunch Black Hole, the origin of the cyclic multiverse.(ref. 42,35,33,26,23,)

2: Primordial Big Bang splitting Black Holes as the product of the exploding Big Bang black hole, identified as a pairing and splitting process of Galaxy Anchor Black Holes (GABHs, ref. 33),

3: Supernova Black Holes identified as and after a pairing and splitting process as Herbig Haro hotspots as the origin of Stellar Anchor Black Holes (SABHs, ref. 10).

4: Electro Magnetic Interference Black Holes, described as the origin of so called Quantum Knots found in the lab.(ref, 27,22,14,11.) , Ball Lightning, Earth bound Micro Comets, Solar related Comets and Sunspots.

All Black Holes are equipped with at least three horizons (fig 5):

1: A 3 dimensional globular massless quantum black hole nucleus, surrounded by a globular event horizon, (7, fig 5) This is the globular shell where maximum opposing photon energy (also vacuum energy) is concentrated

A Fermion repulsion zone located in between two horizons:

2: A fermion attraction/repulsion horizon with entangled pair production (partly annihilated) creating plasma,

3: A fermion repulsion/attraction boundary (by fermion spin flip, ref. 14) with zero point electric plasma polarization of electrons pushed outside and protons pushed at the inside. This is supposed to be the base for all Birkeland/ Alfvén current circuits in space.(fig 10, ref 28,22.)

Quantum FFF theory.

Quantum FFF (Function Follows Form) theory states, that the vacuum is seeded with fast oscillating massless dual Higgs particles (the origin of dark energy) , oscillating along a complex chiral tetrahedral vacuum lattice, which has the ability to transfer Photon and Graviton FORM information in bunches of linear but chiral oscillations, through the chiral (helix shaped) vacuum lattice with the local speed of light.

The local speed of light is created around massive objects which seem to be able to “drag:” the Higgs vacuum oscillations into an anti-symmetrical action called “LASOF” or Local Anti Symmetrical Oscillating vacuum Frame.

There are no attraction forces in Q-FFF theory. Gravity seems to be the result of two different impulse vector arrays: the massless Higgs impulse array and the (less effective) massless Graviton impulse array, which is supposed to be based on the same massless Higgs particle transporting the “FORM information energy” of the Graviton.

As a consequence, new paradigm Dark Matter Black holes suffer only from the gravitational influence of Higgs vacuum (photon) impulses also coined Casimir push-gravity, because no gravitons can escape from the Black hole. The Black hole is supposed to be a super dense knot of Higgs particles floating inside (and compressed and attacked by) the energetic oscillating Higgs vacuum frame. (Fig. 2)

In Q-FFF theory it is postulated that only micro black hole nuclei below a certain size are able to evaporate back into the Higgs vacuum. Black hole types larger than ball lightning and small Comets are supposed to have a steady growth.

No photons like gravitons can escape from inside the Black hole. However, in Q-FFF theory, the vacuum is constantly “eaten” by these NEW Black hole nuclei and the origin of the Casimir quantum gravity effect of Black holes..(fig 2,3,4,5,6)

In the Q-FFF model, Fermions are assumed to have a propeller shape equipped with a left- or right hand “pitch” (fig 1) Quarks and some leptons are compound particles (with photonic gluons) however, electrons and positrons are singular.

Only the statistical sum of the different kinds of vacuum impulses (in the form of butterfly shaped vector arrays : fig 5,10) by real collisions from all directions on Fermions are responsible for all (energetic) phenomena in the universe.

The polarisation and so called spin flip of Fermions around Black holes is the origin that Black holes are equipped with a narrow Fermion repelling and plasma creating globular zone between two horizons. (fig, 5,6,7,9,10,11)

As a result, Black holes are Zero Point Energy driven electric generators with negative charge at the outside and positive charge at the inside, able to change the world and our economy.. (page 29,30,31)

The mysterious ball lightning.



What do we observe here? Are we able to analyze the truth and think out of the box ?

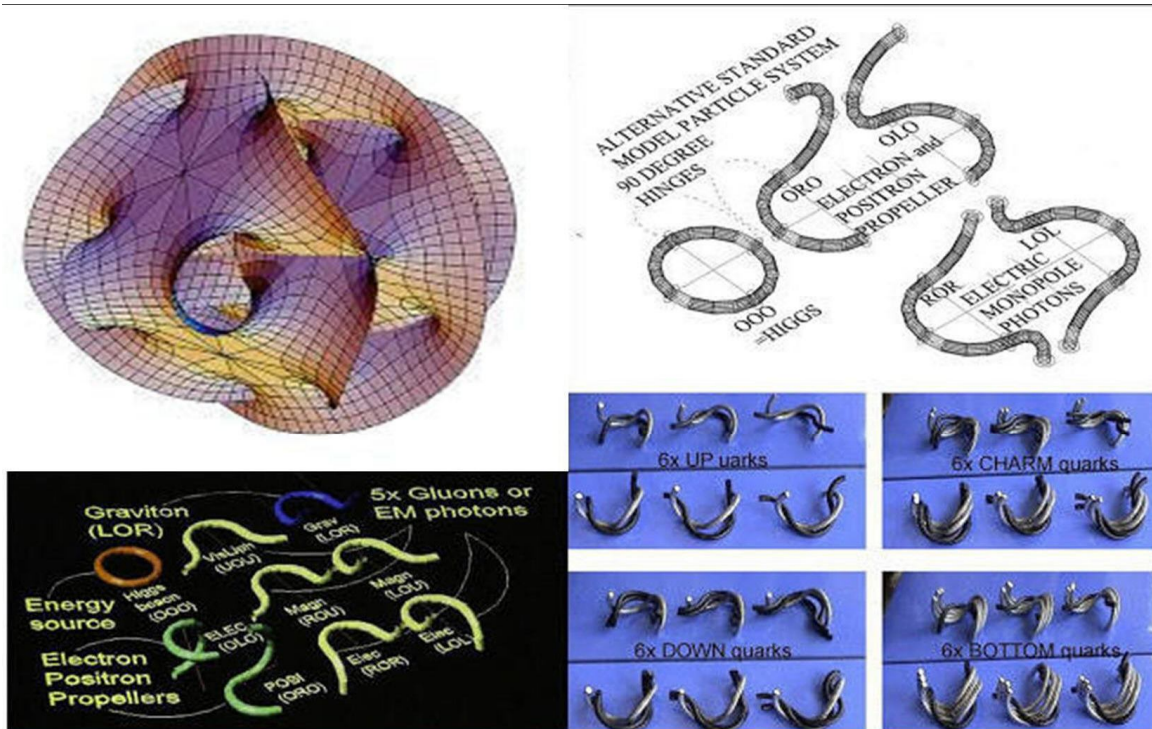

Calabi Yau structures by the dual axis spin of Fermions, according to Quantum FFF Theory.

Figure 1. Cog wheels, joints and hinges at the Quantum scale of spinning Fermion strings with double rotation axis forming Calabi Yau Manifolds.



Figure 2, Impression of a Quantum Knot based nucleus of the new paradigm Dark Matter Black Hole. The Quantum Knot is supposed to be compressed by the Dark Energy of the Higgs vacuum lattice attracted and absorbed by the nucleus. However black hole nuclei smaller than Comet- or Sunspot nuclei such as Ball Lightning are supposed to evaporate quickly due to the vacuum energy attack.

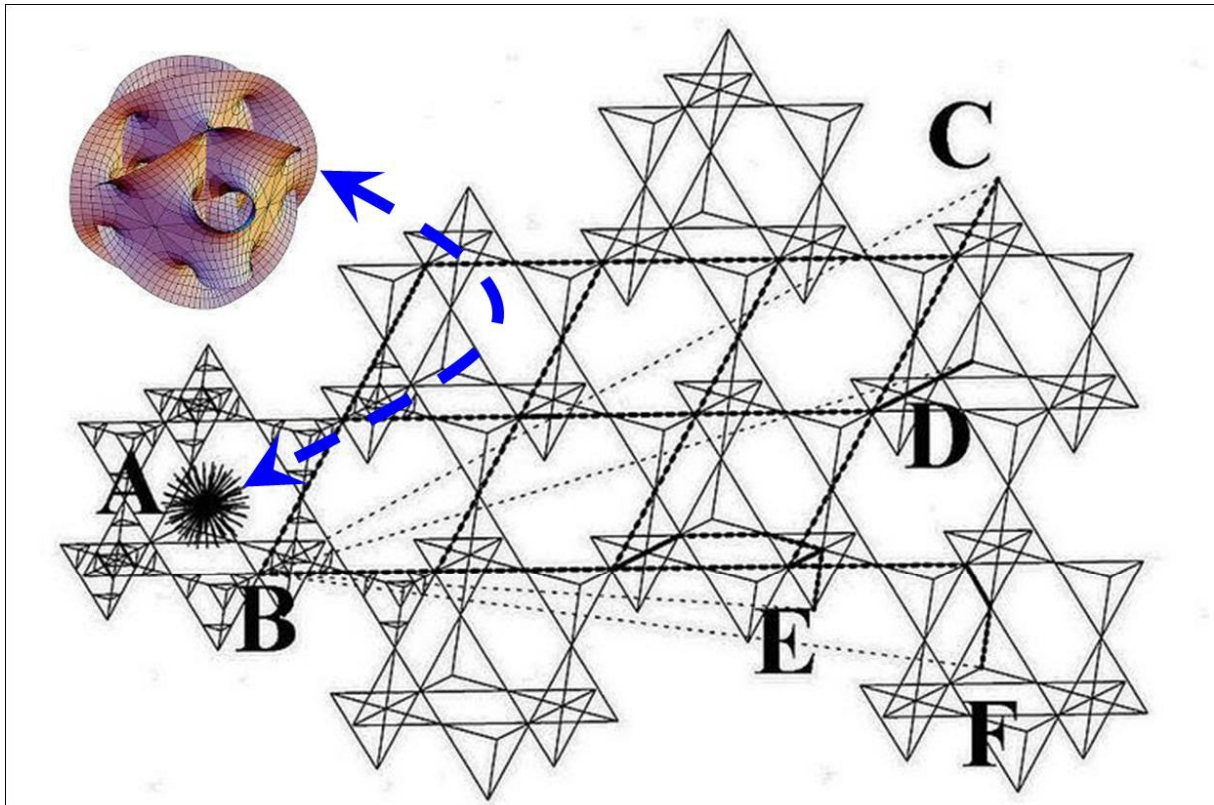

Photon trajectories through the tetrahedral oscillating Higgs vacuum lattice. (Acc. to Quantum FFF Theory)

A: a real shaped Photon is created by Higgs collision with a dual axis spinning (Calabi Yau) Fermion propeller.

B: that Photon transfers CODED form information (monopole photon info) and direction information into one Higgs particle which transfers this information by mutual Higgs collisionary oscillations through the vacuum in one specific direction.

C,D,E, or F.

I: Only magnetic photonic information (2x : North and South) are subject to curvature by an undisturbed symmetric oscillating vacuum

II: Local Anti-Symmetric Oscillating vacuum Frames are influenced by massive objects like the earth and responsible for semi relativistic effects.

III The vacuum lattice has helix- or chiral quality being the origin of our material universe.

Figure: 3. Photon trajectories through the oscillating chiral vacuum lattice, with Calabi Yau propeller manifolds created by all double axis spinning Fermions, driven by the vacuum collisions.

New Dark Matter Black Hole, “Eat” the chiral oscillating Higgs vacuum.(Quantum-FFF Theory)

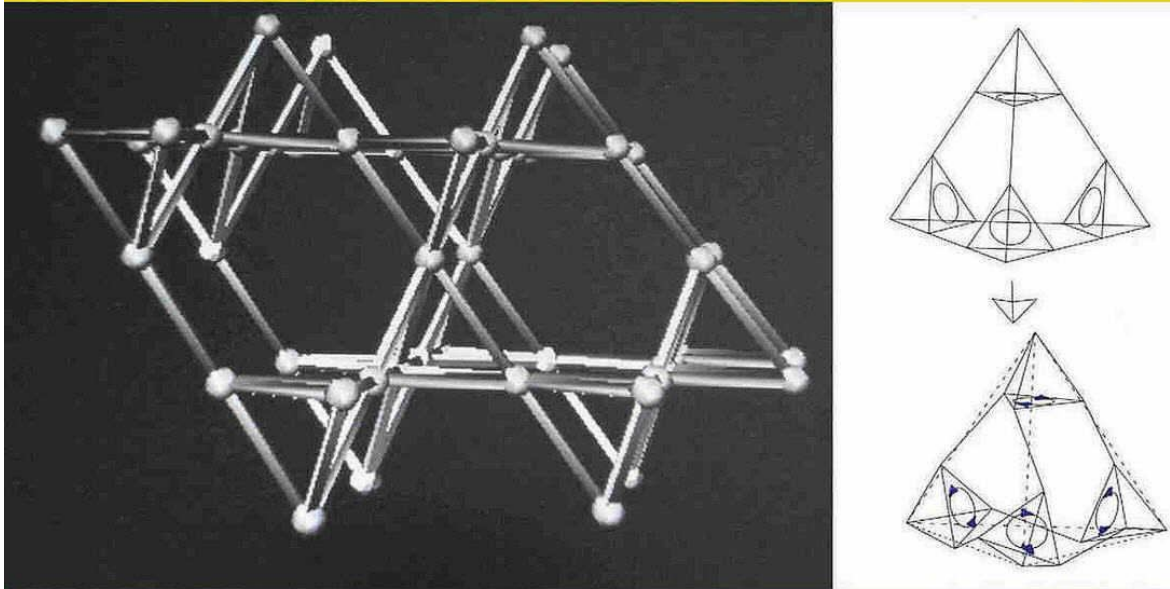

Symplified tetrahedral vacuum lattice structure (left), constructed by complex chiral tetrahedral building blocks (right). Each universe has to choose between a left- or righthanded rotation of its tetrahedral building blocks. Each chiral lattice has the Planck length and is supposed to be equipped with at least two oscillating massless new Higgs particles.

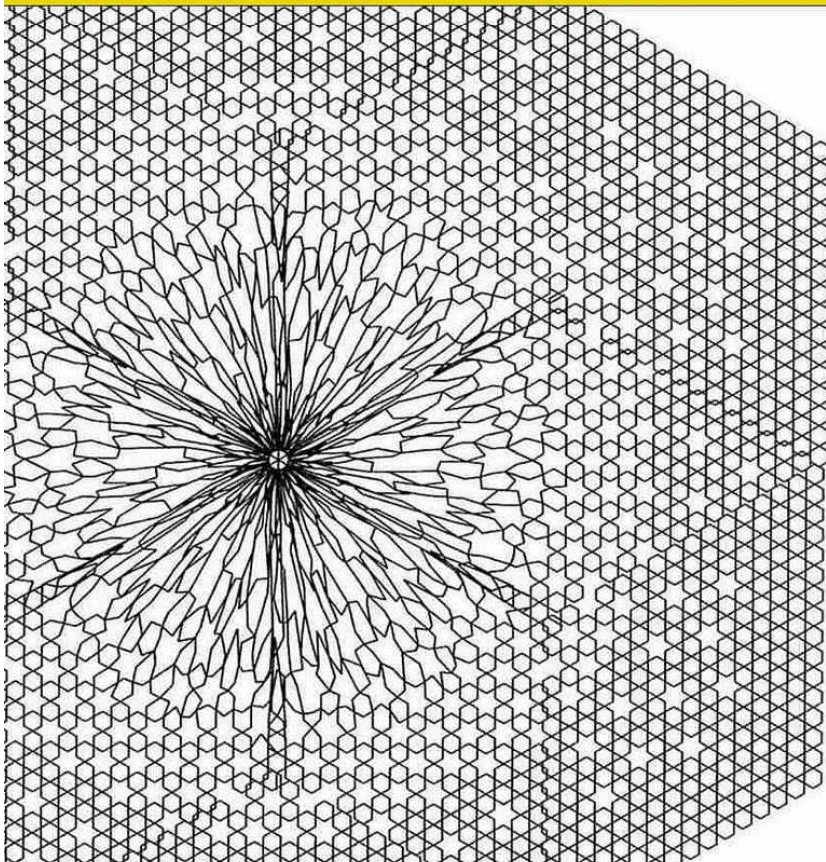

Black holes EAT the vacuum lattice with the oscillating Higgs particles,

So, the vacuum lattice structure around a black hole could be represented like this.

As a result, the near vacuum is thinner or diluted, it has holes, which could be the origin of the Universal HUBBLE redshift.

By contrast, my new black hole paradigm says: the origin of universal redshift is Dark matter.

Dark matter is the proliferation of vast numbers of Black holes around Galaxies. Conclusion, based on Hubble redshift, we don't know anything about expansion or contraction of the universe.

(Author Leo Vuyk)

Figure 4, The Chirality principle and structure of the oscillating Dark Energy Higgs vacuum lattice.

Triple Black Hole horizons found by NASA in accordance with Quantum FFF Theory.

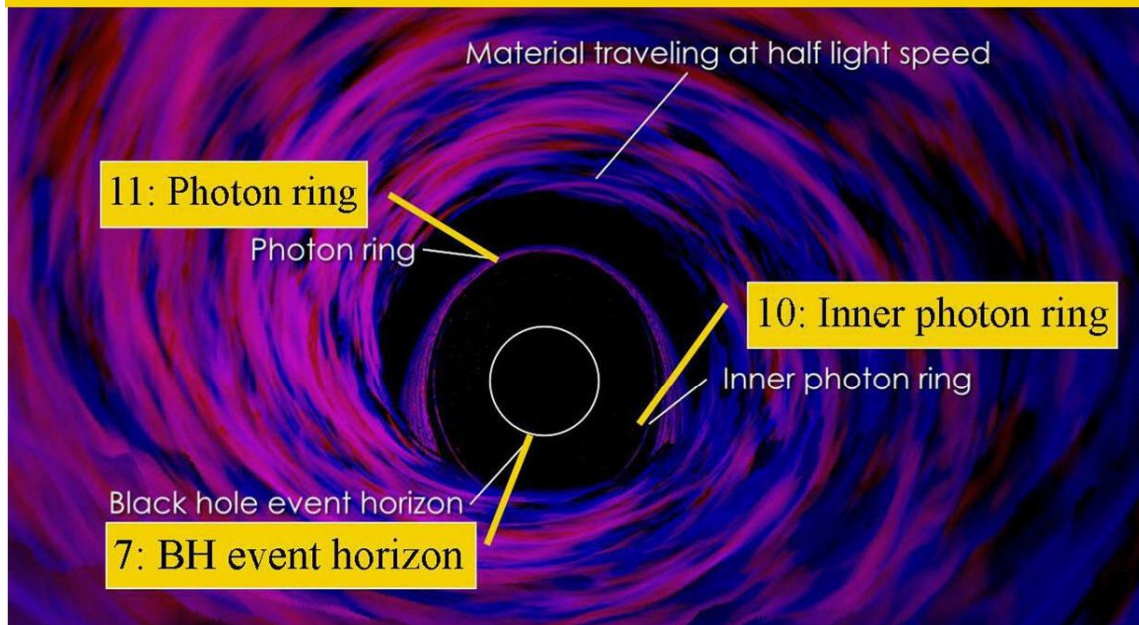

For tripple B-H horizons in Quantum FFF theory see (nrs: 7: Event horizon, 10: Inner photon ring, (10+11 =Fermion repulsion zone) 11: Photon ring)

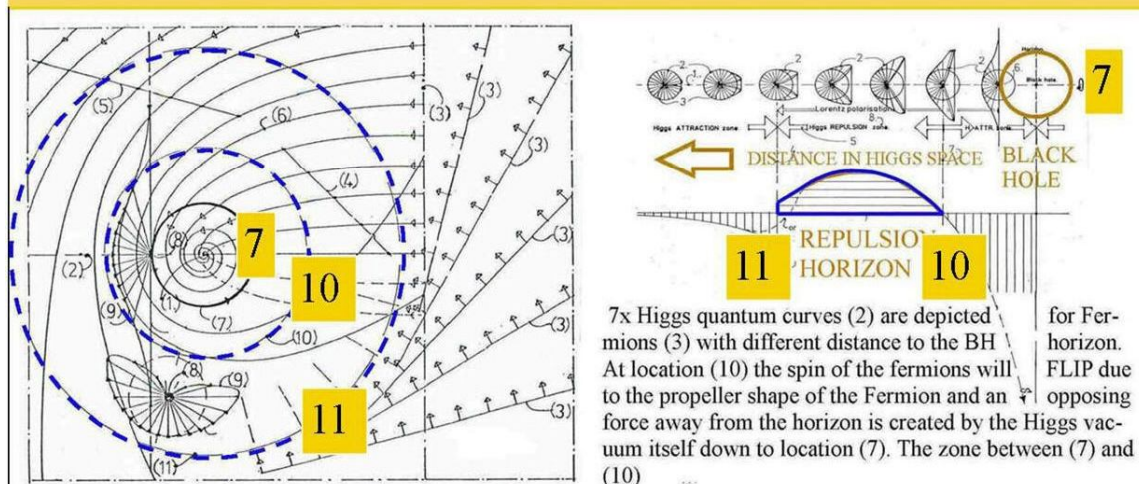

- 1: Non rotating Black hole nucleus (in 2D cross section).
- 2: Reference axis for trajectories 4,5 and 6.
- 3: Other incoming photonic/Higgs fronts (without depicted trajectories)
- 7: High photon energy collider globular shell, with intense Quantum effects like pair production (e^-e^+). 8: test masses.
- 9: Butterfly shaped Higgs/photon Fermion pushing curves in 2D.
- 10 and 11: Fermion repulsion zone. Due to the propeller shape of the Fermions, they will experience a so called "Spin Flip" in this zone.

Figure 5, Triple Black hole horizons recently proposed by NASA, in accordance with Quantum FFF theory.

The origin of plasma and H₂ production originated by pair producing of Quantum Fluctuations around the black hole. The chirality of the vacuum is the origin of preference for positron mergers with photons into composite positive charged Quarks forming ions. Negative Quarks are only stable in the neighbourhood of positive Ions to form protons.

The OLD and NEW Black Hole differences.

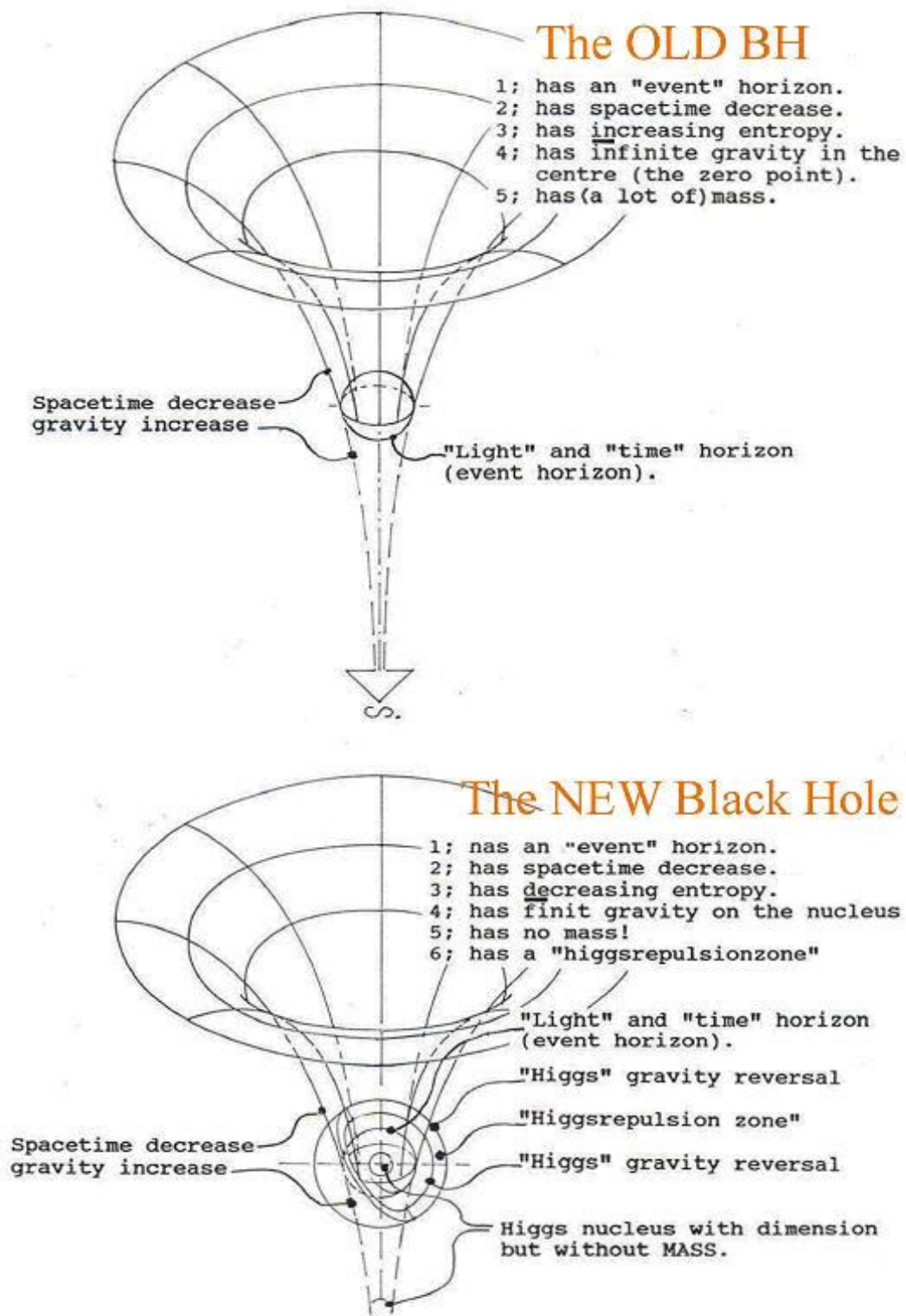
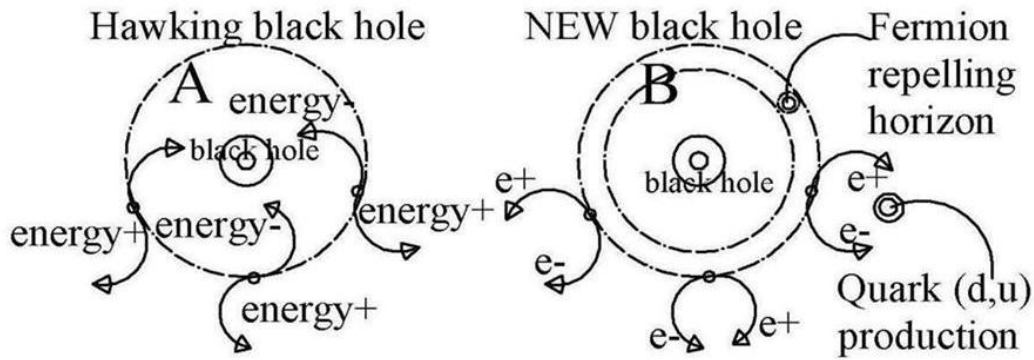

Figure 6, The difference between the old and new paradigm Black hole according to Quantum FFF Theory .



The NEW Black Hole is equipped with a Fermion repelling horizon. In addition Quantum Fluctuations produce twin Electron- Positron propeller shaped Fermion particles out of two convertible Higgsen. (See the 3D particle zoo of the theory) Quarks (d,u) are created by the “dressing up” these twins with Photon/Gluon particles. So BHs create simple plasma clouds like Bock Globules and plasma pillars in Nebula and Herbig Haro objects. (Author Leo Vuyk)

Figure 7, Quantum Fluctuations as the origin of pair production and Plasma creation (Quarks) around Dark Matter Black Holes.

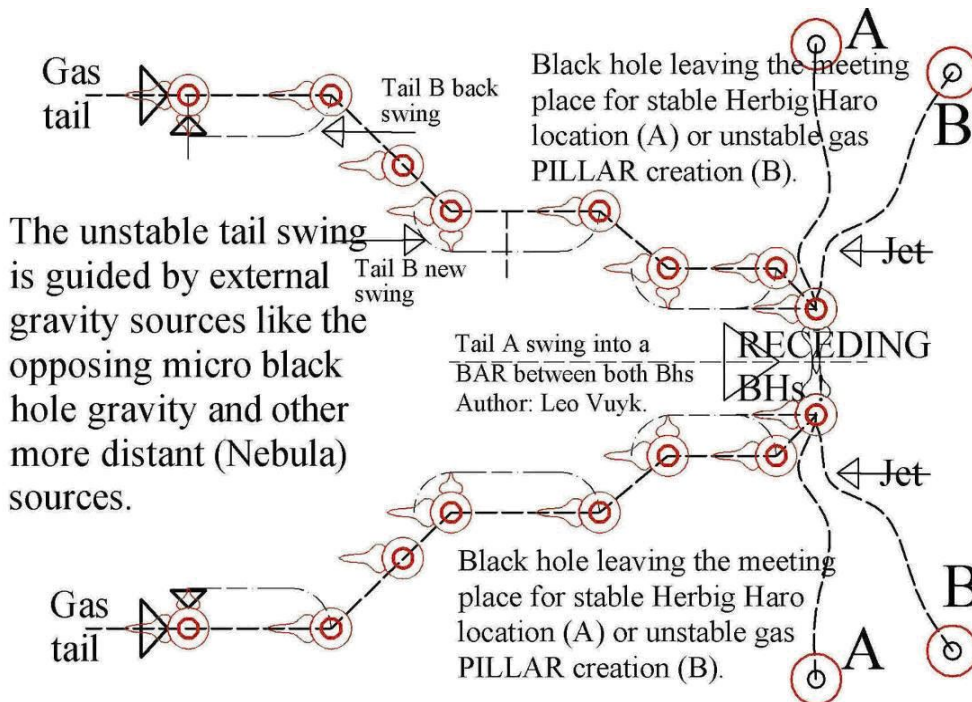

Figure 8, New Black hole propulsion principle by a self produced plasma-dust tail,. As a consequence, New black holes do not merge to form larger nuclei, they even repel negative charged metal surfaces by their own exterior electron charge. (see also fig. 9)

This Ball Lightning photo is an important piece of the new physics of Quantum FFF theory. It shows a self produced vapor trail washed out by the opposing wind of the massless BL nucleus, which seem to be pushed against the wind. Just as observed in multiple single- and pairing Black Hole examples in nebula like the Carina.



Other examples of BLs with plasma tails



Figure: 9. Evidence for Plasma vapour and even energy production by a micro black hole such as ball lightning or earth bound micro Comet.

At the same time it seems a support for the new Black Hole paradigm (see first photo). The BL is propelled against the main wind direction because it left a vapour trail behind and the vapour trail is “washed out” by the wind showing “feathers” of gas.

It is clear that Ball Lightnings DENY and violate the second law of thermodynamics and are examples of entropy decrease and even plasma creation.

Birkeland/ Aflven circuit currents around stars and galaxies, are driven by new paradigm tandem black holes, producing an external excess of negative charged plasma accelerated by the Casimir polarized vacuum (or Higgs polarized oscillations, according to Q-FFF Theory)

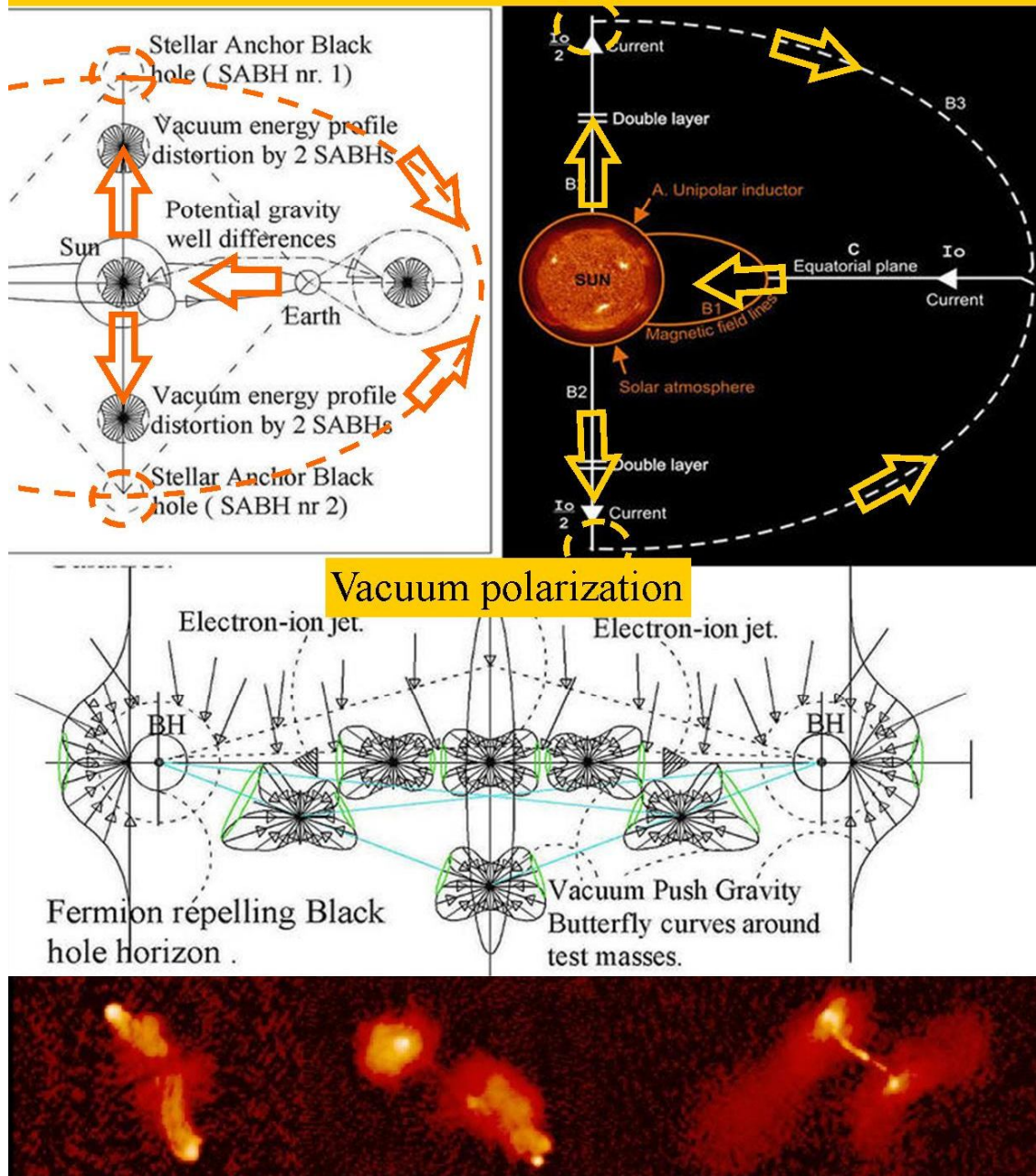

Figure: 10. Black hole propulsion and pairing principle of fig 8, seems to be the origin of dual Stellar or galaxy Anchor black holes (see figure 11) and even so called Birkeland /Alfven current circuits around stars and galaxies by vacuum polarization. The energetic polarized vacuum oscillation spectrum is the motor for fast gas and electron transport starting direct after the big bang.

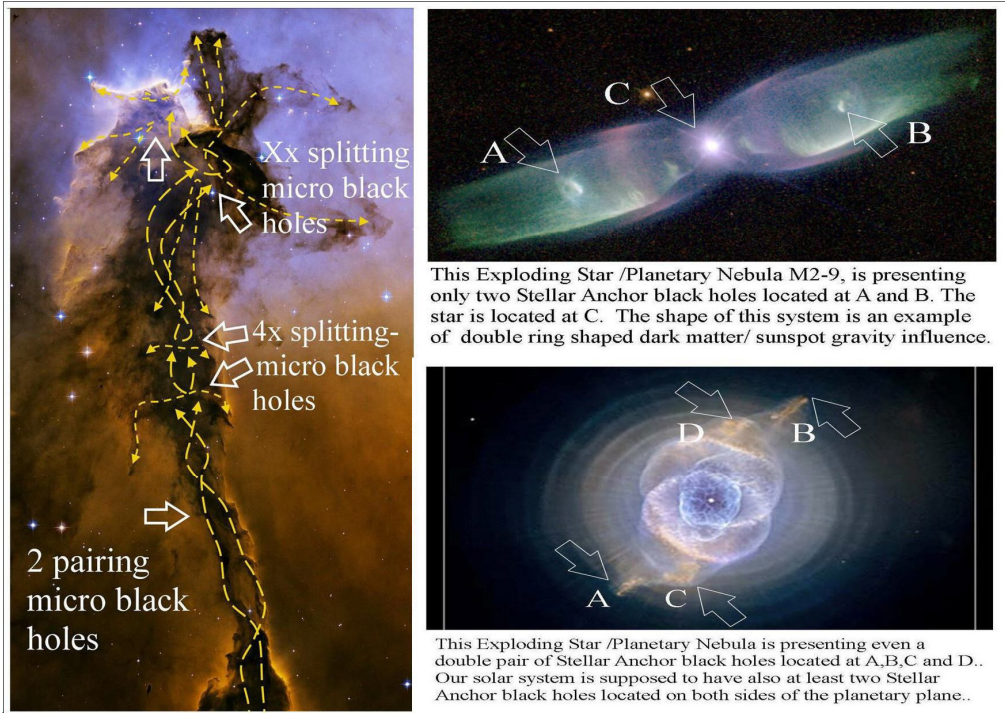
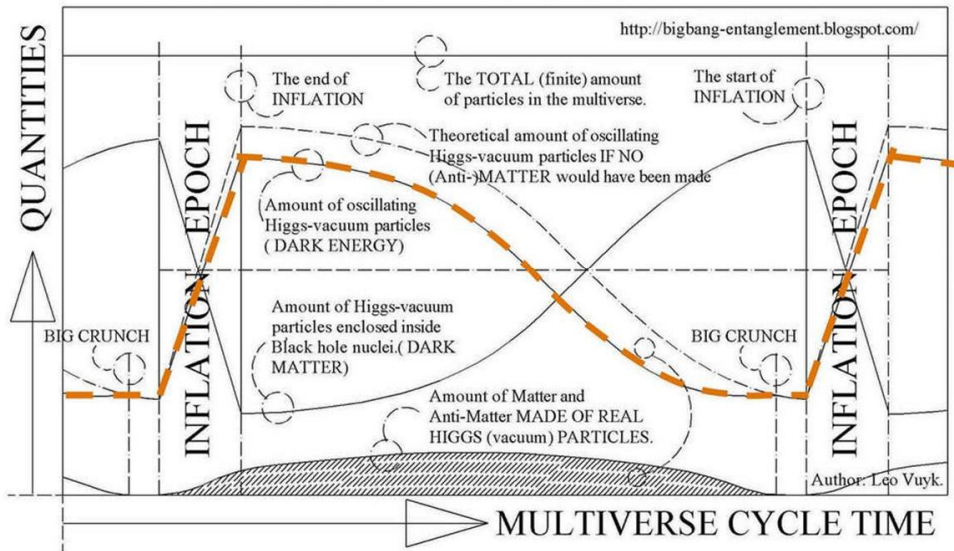

Figure: 11. examples of dual pairs of stellar anchor black holes and the so called Spire creation of star forming dust pillars by a splitting and pairing black hole, also proposed for the fast galaxy formation after the big bang. (fig 12)

The CPT SYMMETRIC MULTIVERSE CYCLE.

The Inflation epoch starts if the decreasing vacuum pressure equals the increasing Higgs tension of the Big Crunch black hole nucleus. Inflation epoch ends if all splintered black hole nuclei are evaporated, or left behind as Galaxy Anchor Black Holes.



The Pulsating Multiverse depicted as a continuous flow of increasing and decreasing numbers free oscillating- and Black hole condensed Higgs particles and the amount of Quarks and leptons. The size of the pulsating multiverse vacuum is given in orange.

Figure: 12. Abundant Black Holes observed in the early universe by the CIB and CXB of Chandra and Spitzer space telescopes (2013). A strong support for the Quantum FFF theory based Black Hole splitting Big Bang and contracting Big Crunch Cycle of the Multiverse

Characteristics of Quantum FFF Theory.

1: The clear MICROSTRUCTURE or the 3D FORM of elementary particles, (also called 3D-Preons) made out of convertible Higgs particles, is responsible for “Bound states of Fermions” and composite Quarks. (ref. 4)

2: The Higgs is supposed to be energetic oscillating, it is the origin all particle motion and spin states and Dark energy (126 GeV) inside a truncated tetrahedron shaped chiral vacuum lattice. The lattice chirality (left or right handed) is the origin of our material universe. Higgs particles are zero point “Planck Oscillators” the origin of the Casimir force, waiting to be harnessed as free energy. (ref. 17)

3: NOTHING SUCKS IN PHYSICS, Gravitons act counter intuitive with less pressure on Fermions than the Higgs vacuum (dark energy) and all particles and vacuum photonic information (radiation) is ENTANGLED by INSTANT communication between at least two anti-copy UNIVERSES or MULTIVERSE, being entangled since the big bang. (ref. 7)

4: Black holes of all sizes (down to ball lightning) do not emit gravitons, they feel only Casimir Gravity of the vacuum oscillations so they are massless but counter intuitively the origin of dark matter and producers of all Hydrogen by Electron and Positron pairs as horizon fluctuations and repel all Fermions even positrons at the double BH horizon. (ref. 9,10,11)

5: Black Holes are supposed to have a negative electron based surface charge in a material based universe and a positive charge inside an ANTI-material universe, due to the chirality (left or right handed vacuum lattice spiralling) of the oscillating dark energy Higgs vacuum. (ref. 27,28).

6: The Multiverse is Pulsating by two phenomena, A; vacuum (Higgs) eating new paradigm dark matter black holes (causing the Hubble redshift) and B: by universal expansion caused by the oscillation force (Dark energy) of the Higgs vacuum lattice. (ref: 33)

FUNCTION FOLLOWS FORM in Quantum FFF-Theory. The Microstructure of elementary particles, is supposed to be the origin of FUNCTIONAL differences between Higgs- Photon- and propeller shaped Fermion particles. Something SMALL is missing in mainstream physics: a NEW splitting and pairing MASSLESS BLACK HOLE, the origin of all dark matter, Ball Lightning Micro Comets , Comets, Sunspots up to Galaxy external Anchor Black Holes and the Big Crunch of the CP symmetric pulsating raspberry shaped multiverse.

The multiverse is a collection of huge entangled pinball machines, with dark energy in the form of linear oscillating double Higgs pins as the origin of photonic collision products with the propeller shaped Fermions running and spinning as balls.

All forces are the result of this entangled Pin-Ball interaction. The 126GeV Boson recently found in the LHC is not supposed to be a single but a double massless Higgs boson linear oscillating in tandem as opposing boxer engine pistons in a chiral truncated tetrahedron lattice.

The 126GeV energy is the base for universal dark energy, the frequency is the base for local time and the length a base for the Planck scale. (Twin Higgs, Dual Higgs, Duplex Higgs, or Tandem Higgs).

AS A RESULT, Free energy devices and electron-muon decay levitation is proposed. An unstable Higgs vacuum seems to be present around all black hole horizons by observed H₂ production and annihilation radiation created by pair production of positrons and electrons. (Instability of the Higgs field)

The main difference with mainstream physics is in short as follows:

A: That a "black hole" has no mass- it does not emit gravitons-, but is the origin of all "dark matter" in the universe and can exist at all scales from Quantum Knots (or Ball lightning) up to Comets, Sunspots, external Galaxy Anchor Black Holes, up to the Big Crunch- or Big Bang Black Hole.

B: That "dark energy" is based on microcopic massless vacuum (non SM) Higgs particles, energetic oscillating in opposing pairs and able to convert into pairs of electrons and positrons, e.g. at the horizon of black holes.

C: That the 126 GeV mass of the Higgs particle (found by the LHC in Geneva) could be translated into 126 GeV energy of the paired vacuum particles. (alternative non SM Higgs) (And is consequently THE FIRST SIGN OF "DARK ENERGY") The LHC found a first sign of Dark Energy!!

D: That as a result, the Universe is cyclic, super symmetric and has the form of a raspberry shaped pulsating symmetric Multiverse with finite cycle time.

E: That all matter and humans have their instant entangled copy symmetric counterpart living inside the opposing super symmetric lobes of the raspberry multiverse. which is supposed to be the base for consciousness.

F: That Humans have the ability to influence conscious acts by a small retardation or lagging effect (300 m.sec) in decision making. This lagging effect phenomenon is already found and described for humans by Benjamin Libet, called RPI and RPII (Readiness Potential 1 and 2) see: "Wavefunction Collapse and Human Choice-Making Inside an Entangled Mirror Symmetrical Multiverse." (Ref. 6,43.)

Comparison of the Final ESA CMB Planck map with a cross section through the Raspberry Multiverse according to Quantum Function Follows Form theory. Compare the Cold Spot with the Void and the Warmer and Colder Hemisphere of the Plack CMB (left) with observation boundaries (right)

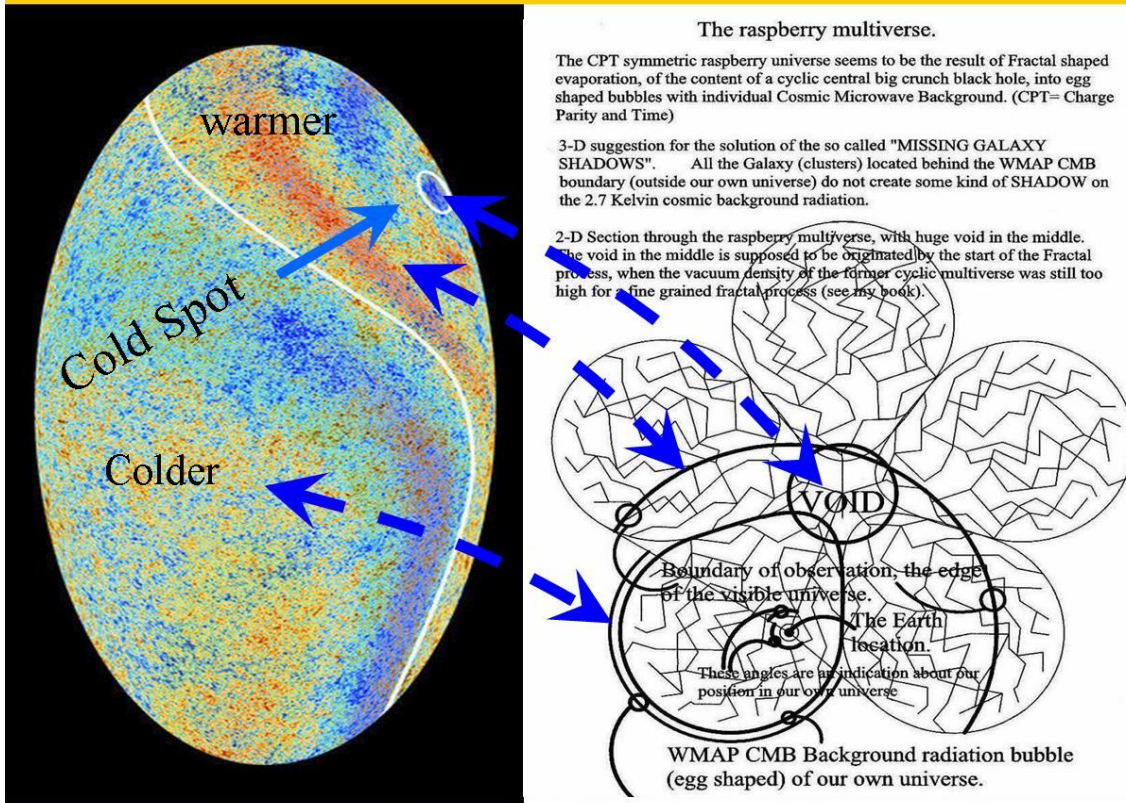

Quantum FFF theory is a combination of a holistic and a reductionist approach of nature. Holistic by the introduction of complexity into the sub quantum geometry or microstructure of elementary particles and fields and reductionist, by reducing that complexity into single elements and monopole forces.

However all these particles and fields are supposed to be connected by continuous active information fields called instant entanglement, between one or even more symmetrical anti matter universes at a long distant.

If particles combine together into simple knots they form quarks and some leptons.

If these knots become more complex (more than 6 particles) they are supposed to form ball lightning alike Casimir energy producing systems called micro black holes..

If stars explode into supernovas they for also quantum knots based on the remaining particles left over from the star's interior and form black holes.

All black hole nuclei are supposed to be based on such quantum knots.

The big bang is supposed to be the evaporation and explosion of the one and only big crunch black hole.

As a consequence we live inside a cyclic symmetric multiverse interconnected by instant entanglement between these anti-copy universe at the quantum scale.

Consciousness should also be subject of this active information system, and my thoughts are continuous competing with my brothers over there.... (Leo Vuyk)

Figure 13, The Pulsating Raspberry shaped Multiverse also to be observed from the Planck Cosmic Background Radiation image.

Synchrotron radiation by Polarized Fermion spin combined with high speed motion through the resistive oscillating Higgs vacuum (according to Quantum FFF theory)

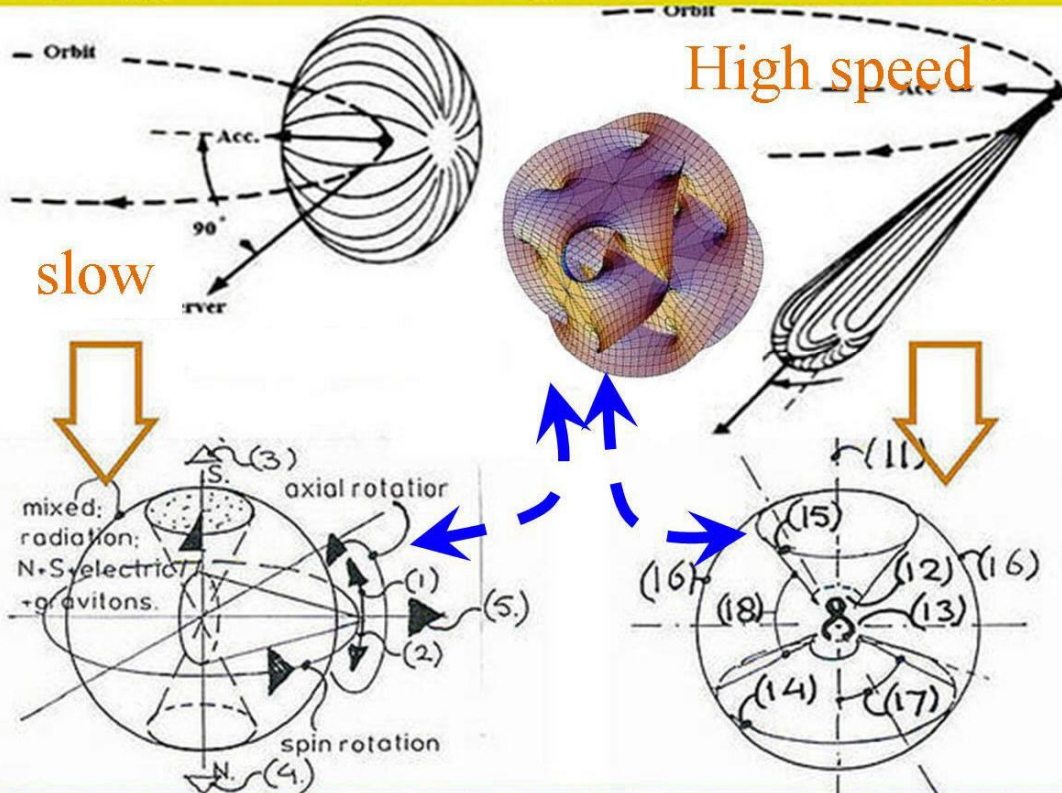

The propeller shape of Fermions is the origin of a dual spin state by collision influences of the oscillating massless Higgs vacuum at low speeds. (Spin rotation and axial rotation) At high relativistic speed the Lorentz polarization of the Fermion "propeller nose" (1 or 2) is preferentially pointing into direction (11) with photon cone focussing into the opposing vacuum direction (15) and the Spin rotation has gone. (Calabi Yau)

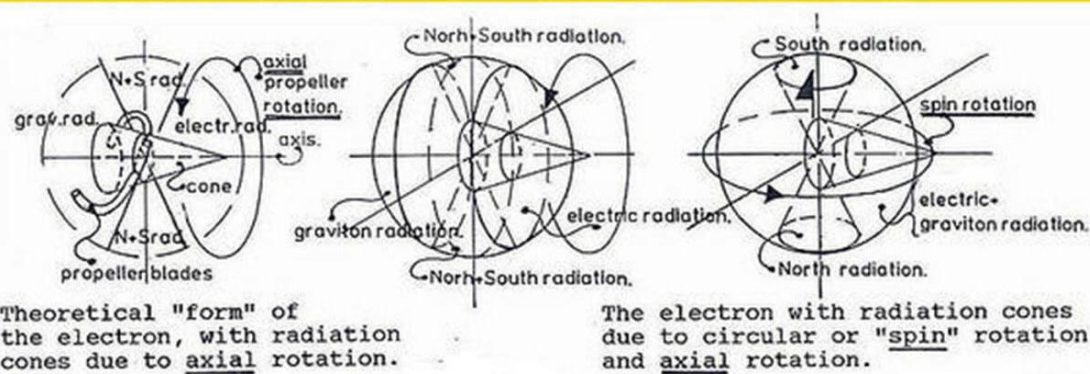
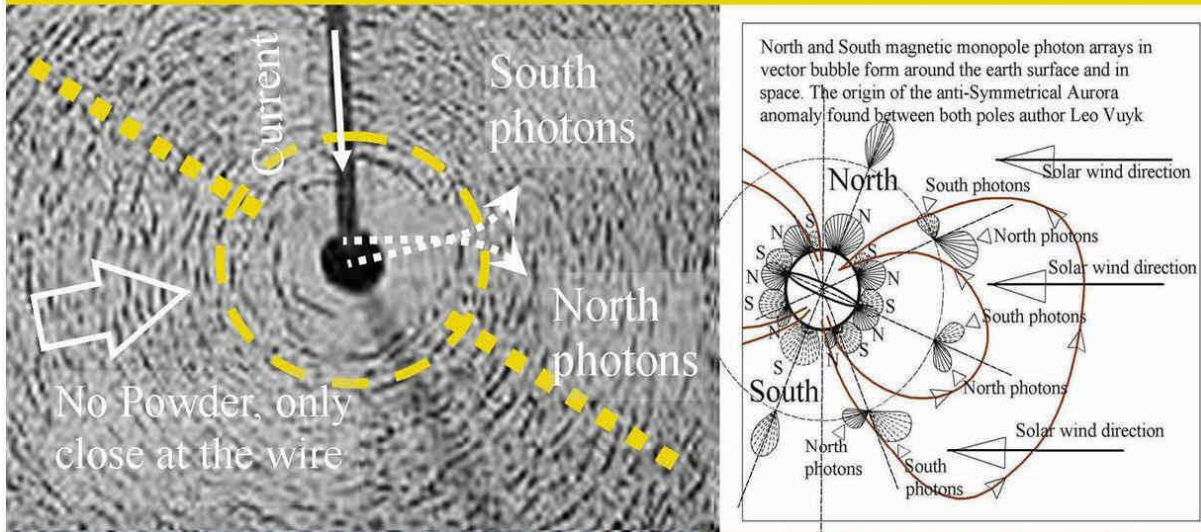
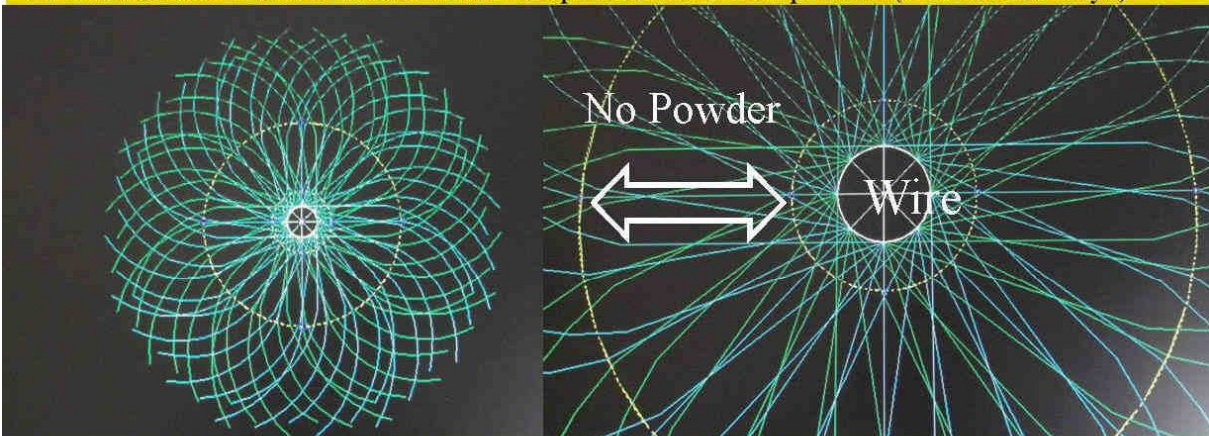

Figure 14, The polarisation of the double spinning propeller shape of Fermions is the origin of the monopole radiation differences radiated into different directions from the Fermion radiation area around the centre. It is assumed that electric and gravity radiation is not mixing with magnetic monopole radiation inside the magnetic double cone area. Consequently, the measured difference between the Equatorial gravity (9.78 m/sec²) and Polar gravity (9.83 m/sec²) should be greater without this effect.

Magnetic field variations by the “Curl” of Magnetic Monopole (N and South) Radiation around a wire and the earth.



According to Quantum FFF theory, all magnetic fields can be presented as DUAL Magnetic Monopole Photon Vector Arrays. These monopole arrays undergo curvature. As a result, the magnetic field intensity around the Earth and a wire is NOT dropping off with the square of the distance from the source!! The field become stronger polarized away from the source (See images). Close to the current transporting wire the magnetic field strength is zero due to the parallel trajectories of North and South Photons before curvature and polarisation of iron powder (Author: Leo Vuyk)



TWO (North and South) Monopole Photon trajectories around a current in a wire shown in cross section. Between the two yellow circles both (N+S) trajectories are pointing about parallel. The result: No iron Powder orientation between the concentric circles, as is observed in the lab (see upper photo). This is a firm support for the monopole photon vector array element of Quantum FFF Theory.

Figure 15, Magnetic field variations originated by the curl potential of Magnetic monopole vector arrays around a wire or around the earth.

Alternative standard particle model

All SINGLE (non-compound) elementary particles suggested by Quantum FFF Theory. OLO, ORO have "click-on potential" to form compound quark particles with only 5 different shaped Gluons/Photons. In yellow colour: Quantum-FFF suggestions for NEW PHYSICS particles. The Majoranas: (OUO+ mirroring Majoranas RUR+ LUL) and 4x extra neutrinos (RLU+ RRU+ LLU and LRU) (author:Leo Vuyk)

Explanation of the codes:
 U= Up rotation (180 degrees)
 O= Unchanged circle.
 L= Left rotation (90 degrees)
 R= Right rotation (90 degrees)

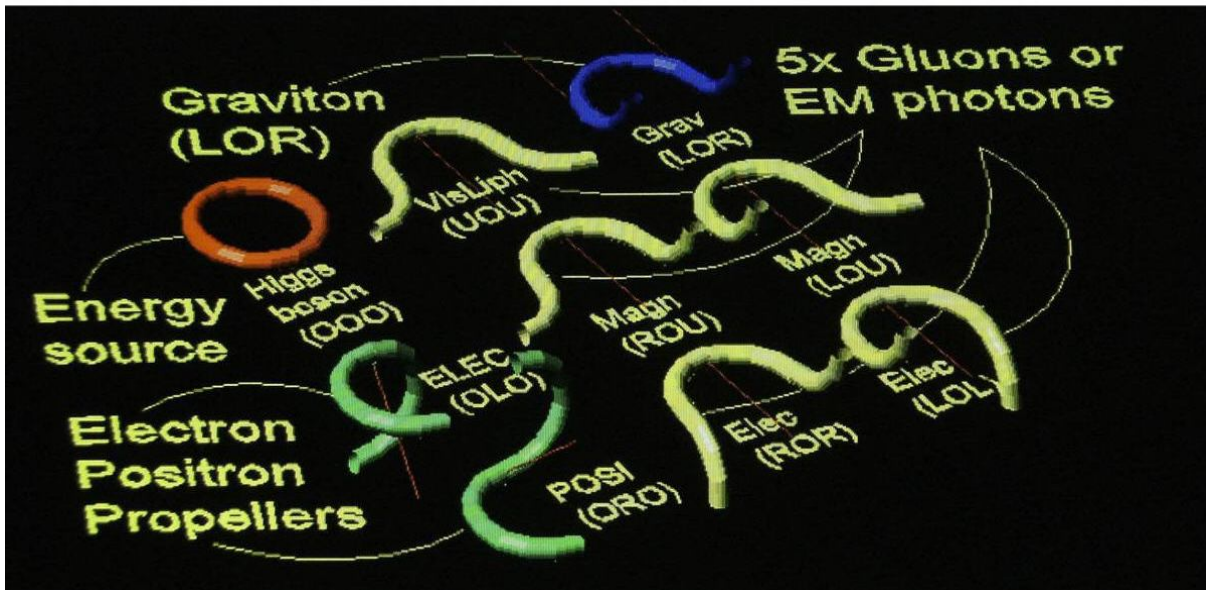
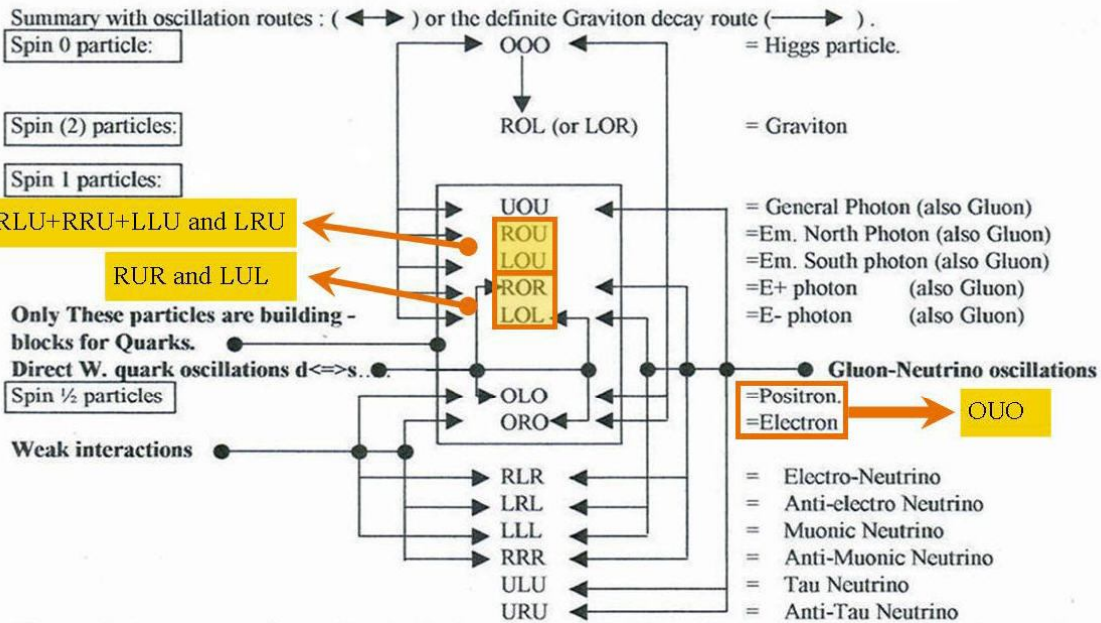
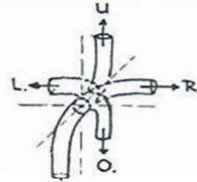

Figure 16, The particle zoo of single ELEMENTARY particles made out of ONE convertible Torus shaped Higgs particle, equipped with three hinges of 90 degree rotation.

Quantum Function Follows Form Model

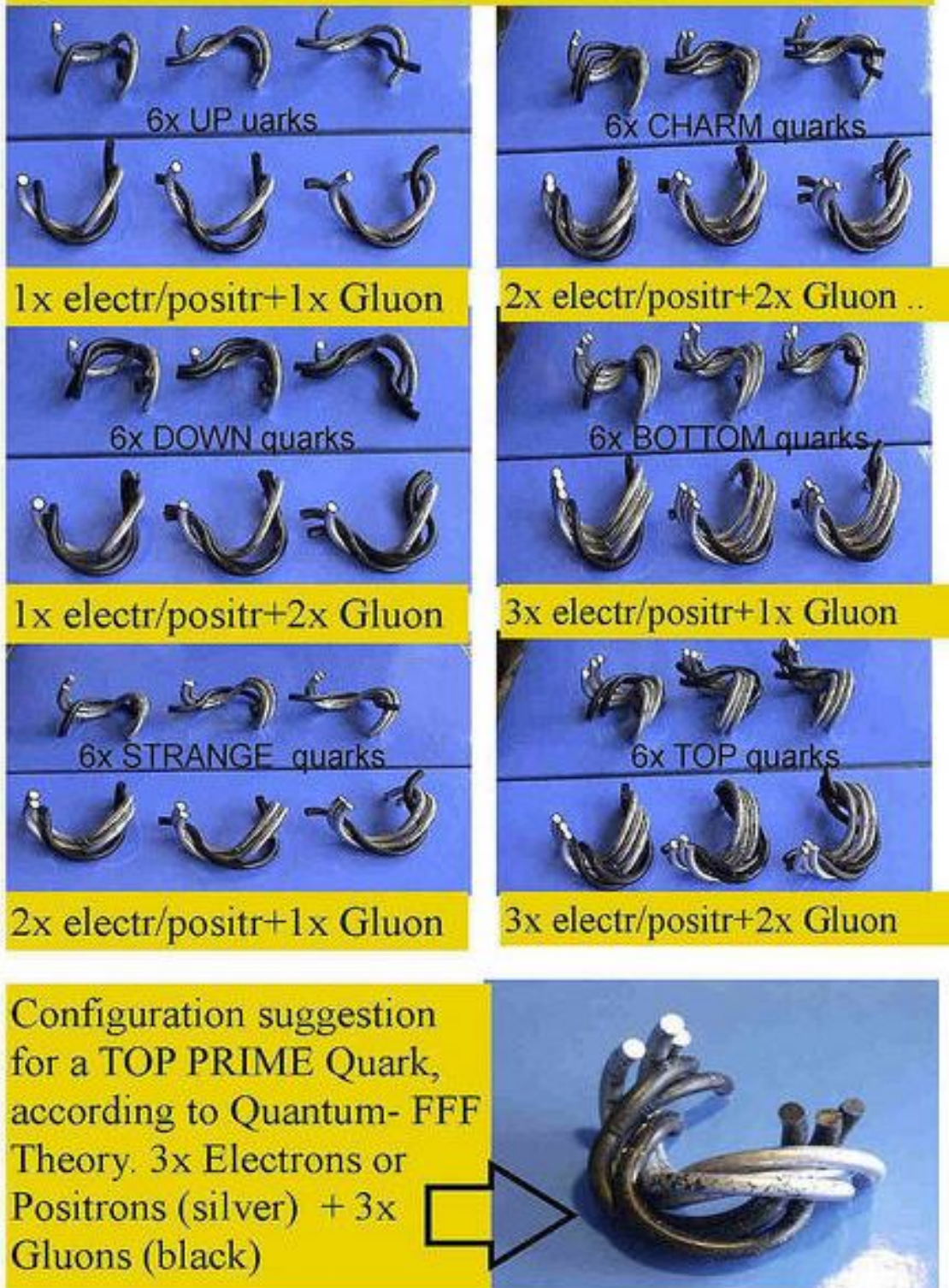
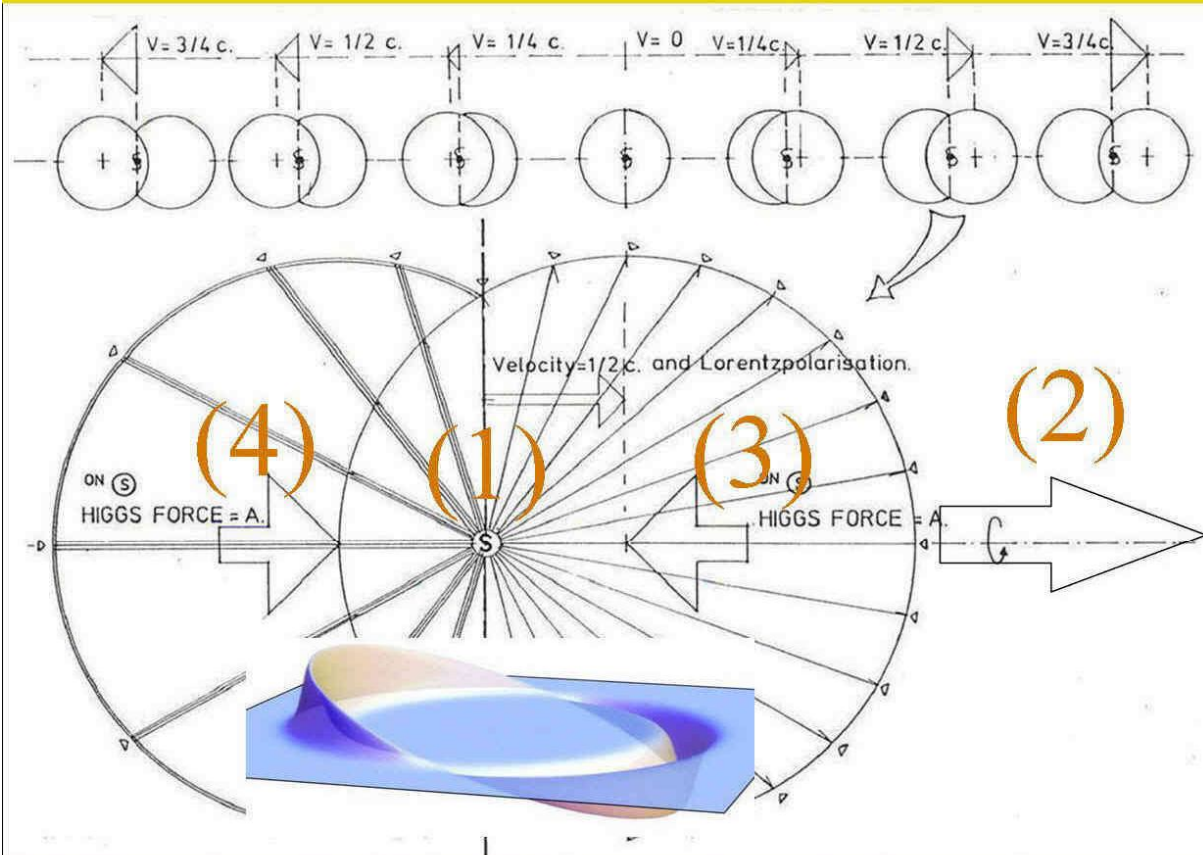

Figure 17, 5x different shaped Photon/Gluons can combine with the two propeller shapes of the Electron and Positron to form all coloured (QCD) Quarks and even a so called Top Prime Quark. The Muon and Tau particle are supposed to be the same as the Down quark, respectively the Charm quark.

Polarized Fermion Mass in motion through the resistive, but also pushing oscillating Higgs vacuum (according to Quantum FFF theory)



Cross section through the 3D vector field pressure distribution on a Fermion point mass (1). Propeller shaped spinning Fermions are supposed to be Polarized into the direction of flight through the vacuum lattice (2). As a result, the resistive vacuum Higgs force (3) is compensated by the Higgs Pushing force (4) from the “backside” of the Fermion. However every Fermion need to have polarization memory consciouness. (by a multi universal entanglement system see: Quantum-FFF theory)

Figure 18. Polarized Fermion based Mass in motion through the resistive BUT also pushing (from the back, called warp drive) oscillating Higgs vacuum lattice

Quantum Knot based Micro Black Holes (Ball Lightning), produced by Photon interference in air and in Silicon globules according to Quantum FFF Theory.



Quantum Knots in air

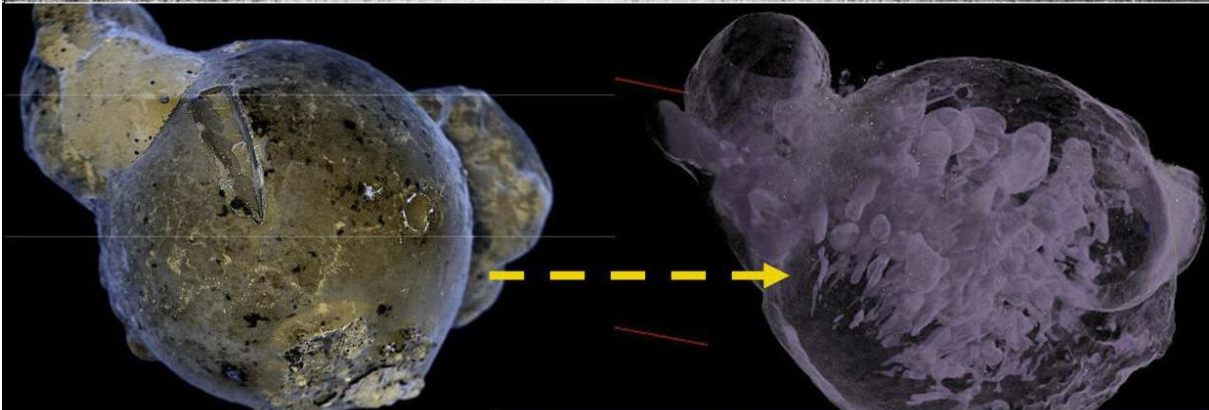
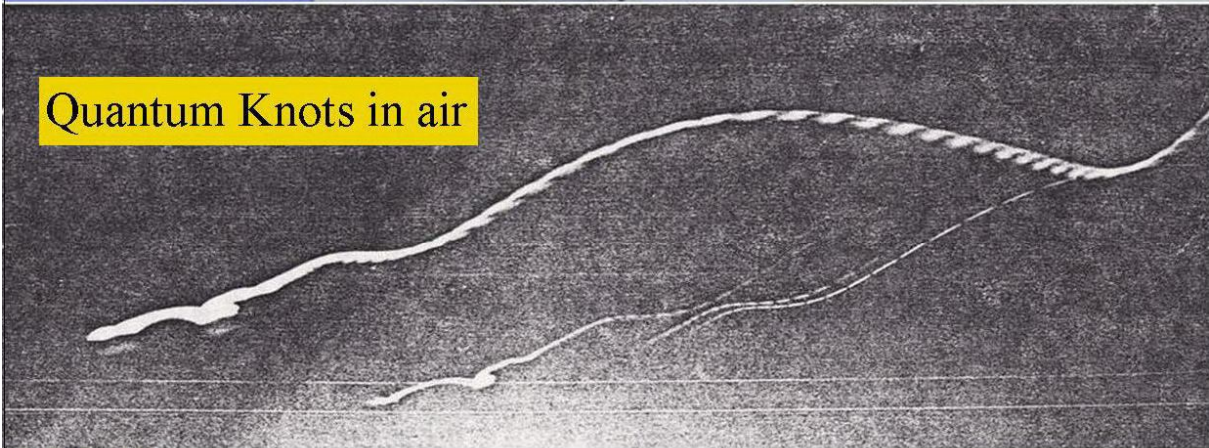

CT scan of Quantum Knots in Silicon

TU/e Technische Universiteit Eindhoven University of Technology

1 mm
M.P.F.H.L. van Maris

Figure: 19.

Suggestion for the origin of UFO dust particles inside the LHC at CERN: particle based Quantum Knot heating according to Quantum FFF theory.



Comparison of UFO dust particles diam. 10 μm at CERN (left) inside ceramic tubes and on Silicon discharge globules in the lab. 100 μm (Right)

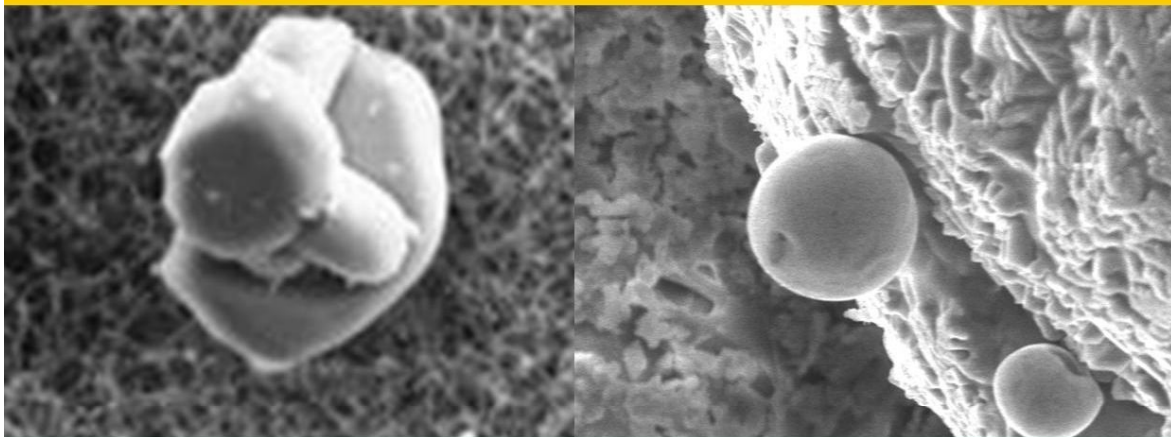

Below (in yellow) the Quantum Knot trajectory

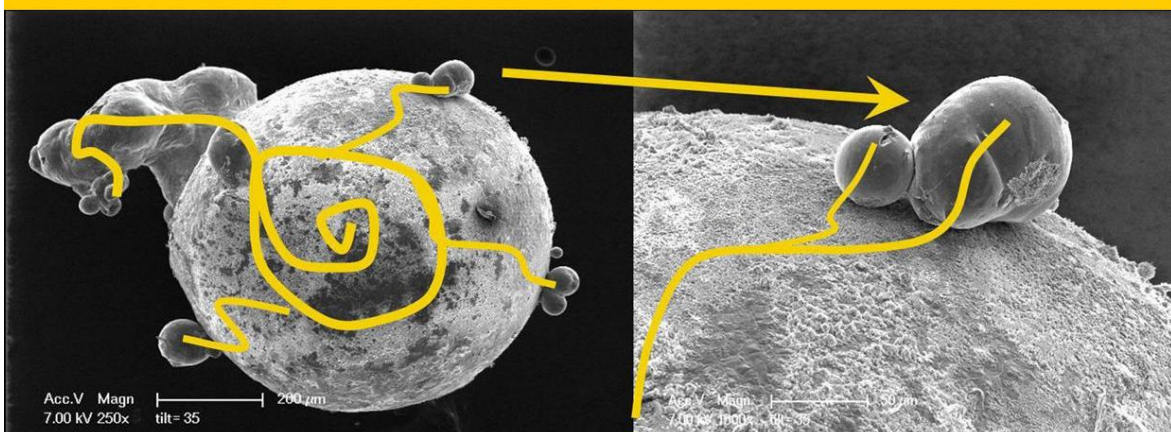
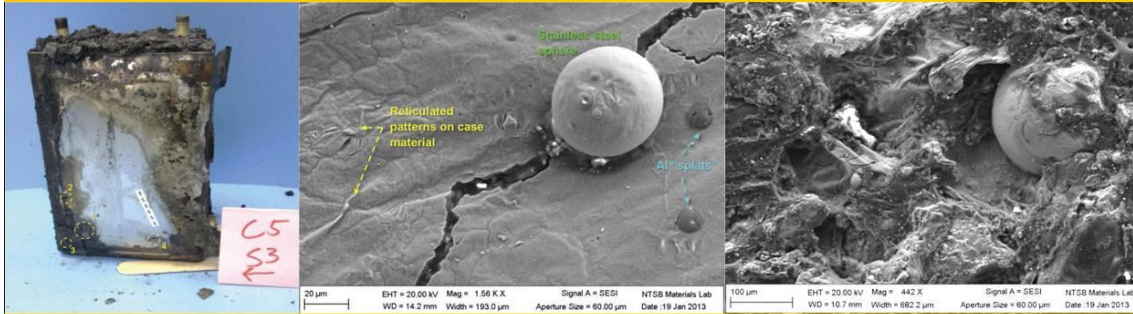
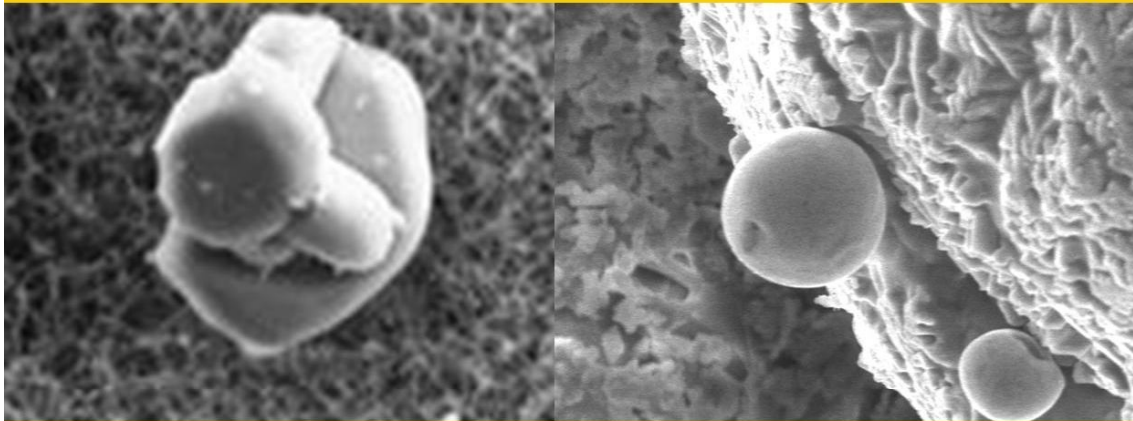

Figure 20. Comparison between LHC (CERN) UFO dust particles (10 μm) with molten Silicon globules (100 μm) originated in the lab by travelling and evaporating Interference Quantum Knots (micro dark Matter Black Holes)

Suggestion for the origin of external stainless steel globules found on the Boeing 787 Dreamliner APU battery damage jan.7.2013 at Boston airport.(below)



Comparison of UFO dust particles diam. 10 mu.m at CERN (left) inside ceramic tubes and on Silicon discharge globules in the lab. 100 mu m (Right, below)



Below (in yellow) the Quantum Knot trajectory

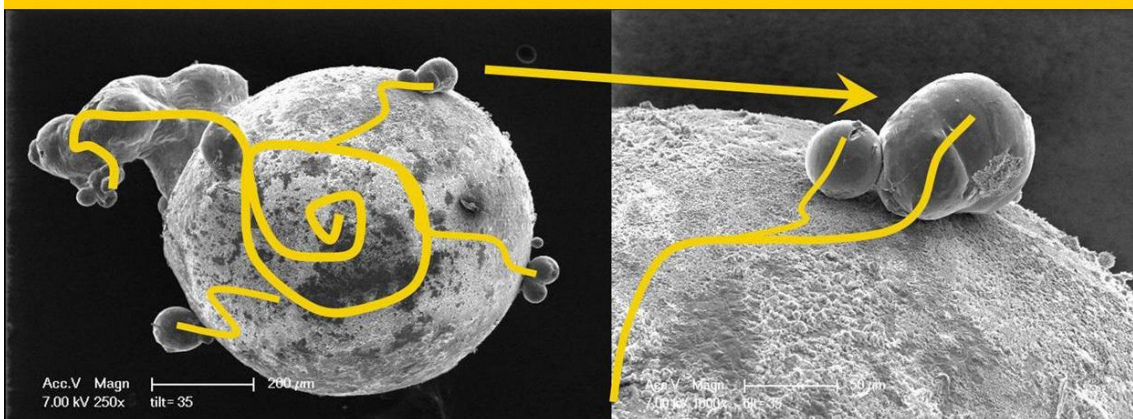
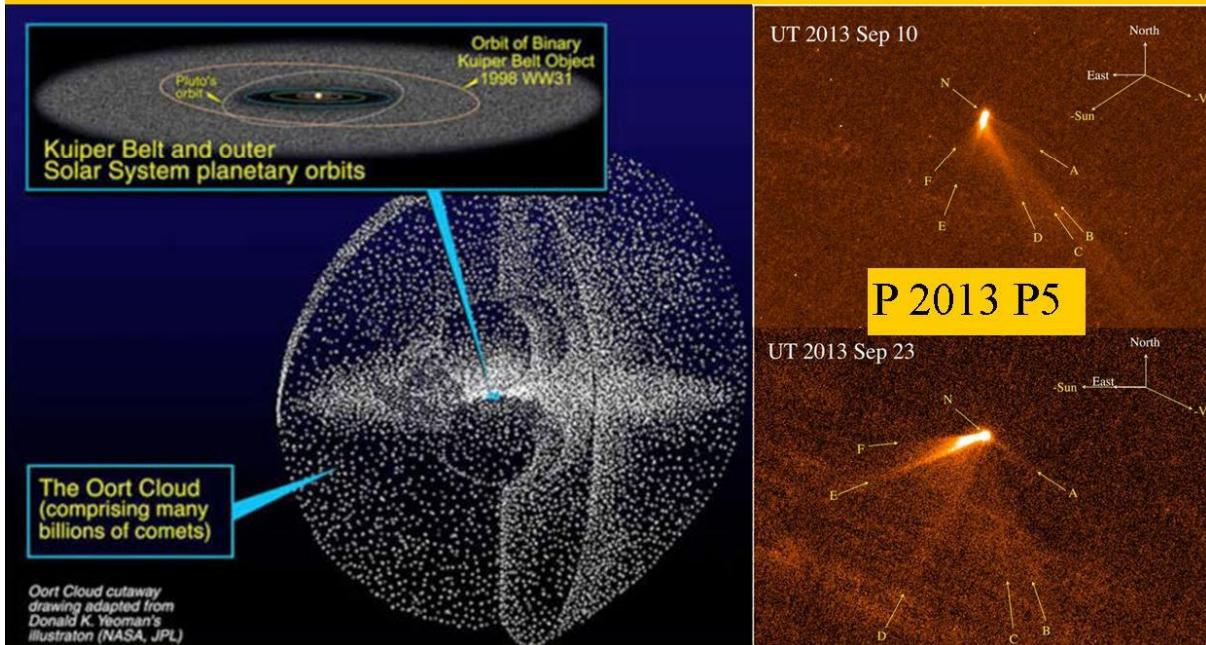

Figure 21. An other example of Quantum Knot heated globules found on an exploded battery. Suggestion for the origin of external stainless steel globules found on the Boeing 787 Dreamliner APU battery damage jan.7.2013 at Boston airport. Discharge Quantum Knot black holes seem to be able to melt stainless steel! Melting point of stainless steel is 3000 degree C! (Globule diameter 30-120 mu.meter)

Micro black hole based Comets produce H₂ and Water molecules building the icy Comet nucleus, spouting icy dust tails. Semi-Stationary Cometary objects (P2013 P5) should be located all over the solar system, in the Oort cloud, the Kuiper belt and inner astroid belt, according to Quantum FFF Theory.



Oort cloud (above), Inner Jupiter astroid belt, and Kuiper belt (below)

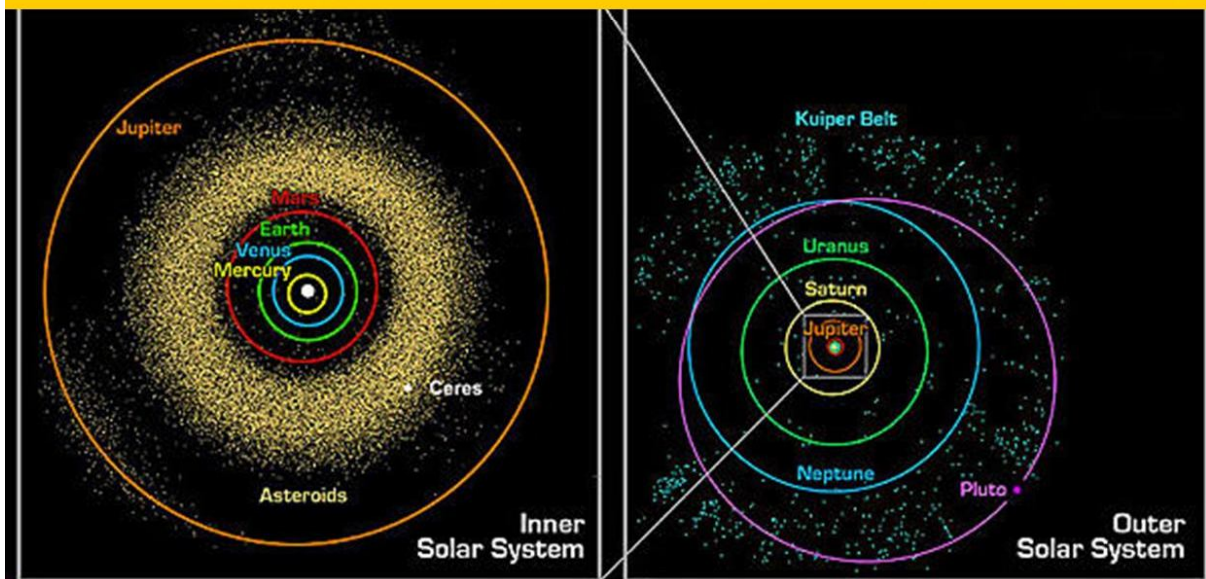

Figure: 22, Micro black hole based Comets produce H₂ and Water molecules building the icy Comet nucleus, spouting icy dust tails. Semi-Stationary Cometary objects (P2013 P5) should be located all over the solar system, in the Oort cloud, the Kuiper belt and inner astroid belt, according to Quantum FFF Theory.

Quantum FFF Theory and New Physics by:

- 1: Dark Matter Black Holes without gravitons.
 - 2: Dark Energy (Casimir) Higgs Field.
 - 3: Dual push Gravity = Attraction (Higgs-Casimir opposing Graviton push).
 - 4: The Big Bang is a Splitting Big Bang Black Hole (BBBH) into smaller primordial Splinters.

 - 5: Primordial Big Bang Black Hole splinters (PBBS) produce the energetic Dark Energy Higgs field by partly evaporation.
 - 6: Dual PBBSs produce plasma in giant Herbig Haro systems as a base for Giant stars in open clusters as a start for Spiral Galaxies.
 - 7: Spiral Galaxies keep both Primordial Black Holes as Galaxy Anchor Black Holes (GABHs) at long distance.
 - 8: After Galaxy Merging these GABHs are the origin of Galaxy- and Magnetic field complexity.
 - 9: Dual Black Hole systems produce Plasma out of the Higgs field by a convertible Higgs particle.
 - 10: Dwarf Galaxies are created after Galaxy merging in between two or more local GABHs (irregulars) or around GABHs Globular Clusters.
 - 11: The first Supernovas produce medium sized Black Hole as the base for secondary Herbig Haro systems.
- (author Leo Vuyk)

Figure: 23.

THE SECRET OF BALL LIGHTNING. Its production by e.m.- x-ray interference into a KNOTTY Nucleus, able to accelerate, decrease Entropy and produce Vapour.

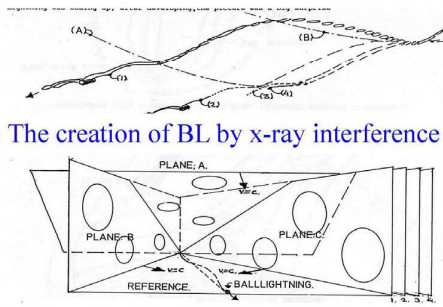
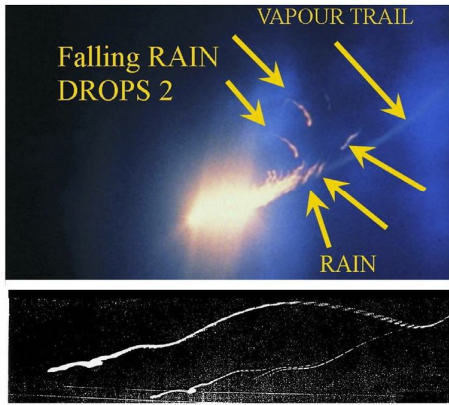

Author: Leo Vuyk 10-02-2011 NL.

Figure: 24. poster 1.

The NEW Black Hole Paradigm

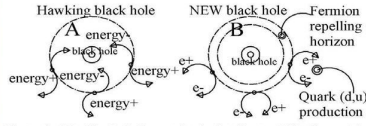

The standard Hawking Radiation postulate is: that all matter (NOT all energy) is drawn into the Black hole. My NEW postulate is that matter is even created (and pushed outside) at the Black hole horizon by QUANTUM FLUCTUATIONS producing Electrons and Positrons. The reason for this NEW Fermion production effect is, that it is a consequence of the concentration of head-on Higgs particle collisions just at the horizon. Some Electrons and Positrons will annihilate, but the rest will form Quarks and plasma, because the Higgs vacuum lattice is CHIRAL and prefer to link Gluons to Positrons and form U⁺-Quarks in favour of Electrons and Gluons, which form D-Quarks. Thus more Electrons will stay single and form Hydrogen atom shells. However they have less mass than Quarks and feel less attraction to the Black hole nucleus, thus Electrons form also an external shell around the Black hole inner shell of Protons and some Neutrons! Due to the propeller shape of the particles all the plasma is repelled away from the black hole! The Black hole will not evaporate! This is the base for NEW Physics and a support for a new explanation of Cometary X-rays, Hydrogen and AMINO ACID production. Even Gas Pillar and Herbig Haro formations inside Nebula become a logic base. Author Leo Vuyk.

The Fermion repelling horizon

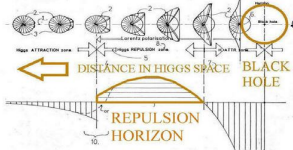

7x Higgs quantum curves (2) are depicted for Fermions (3) with different distance to the BH horizon. At location (10) the spin of the fermions will FLIP due to the propeller shape of the Fermion and an opposing force away from the horizon is created by the Higgs vacuum itself down to location (7). The zone between (7) and (10) ...



How is the vacuum able to release energy to overcome the opposing wind? By SPIN FLIP and the Plasma tail is always swept at the back of the BL by the wind itself!

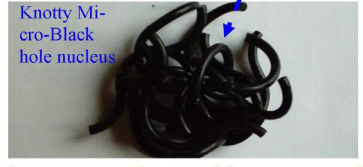
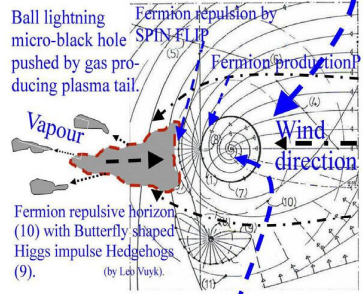

<http://bigbang-entanglement.blogspot.com/>

Author: Leo Vuyk 4-02-2011 NL

Figure: 25. poster 2.

What is wrong with Physics at the astronomical scale?



Leo Vuyk@Gmail.com

The inflation epoch starts if the decreasing vacuum pressure equals the increasing Higgs tension of the Big Crunch black hole nucleus. Inflation epoch ends if all splintered black hole nuclei are evaporated, or left behind as Galaxy Anchor Black Holes.

<http://bigbang-entanglement.blogspot.com/>

What is wrong with Physics

Wave-Particle duality

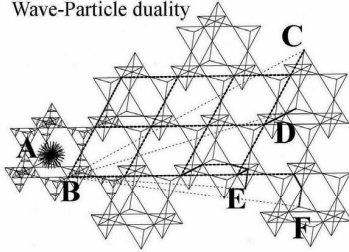

Photon trajectories through the tetrahedral Chiral vacuum lattice.

A photon is created as a deformed Higgs particle at position (A), thus as a single (Photon/Gluon) particle which after some distance changes form back into a Higgs particle (B). The photon energy is transferred into the oscillating Higgs system and travelling through the vacuum lattice in the form of a pulsating BUNCH of entangled energetic Higgs oscillations with the local speed of light. The distance between two cycles of the bunch resembles the wavelength of the photon pulsating bunch. (The bunch idea matches with the single photon double slit experiment) After collision with a second Fermion, at locations C,D,E,F, the BUNCH of energy collapses and change the FORM of a local Higgs particle into the shape of the original Photon. Five different shaped Photons after some distance are called Gluons. Author: Leo Vuyk.

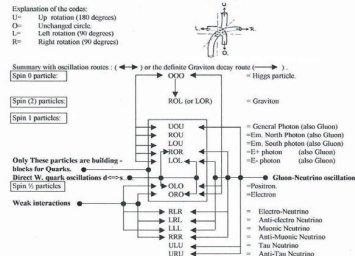

Author: Leo Vuyk 30-01-2011 NL

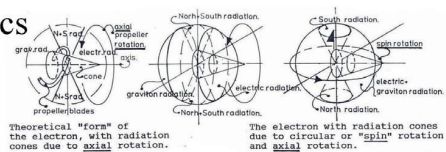

Theoretical "Form" of the electron, with radiation cones due to axial rotation. The electron with radiation cones due to circular or "spin" rotation and axial rotation. The "Eigen energy" distribution around the spinning Fermion propeller, is supposed to come in cone form. The Fermion spin and radiation is the product of a scattering process with oscillating Higgs vacuum particles. As a result, the Fermion has a double spin around two polar axes. This is supposed to be the origin of a dipole Magnetic field with North and South monopole photon radiation and the circular distribution of graviton and electric radiation. In addition it must be stated that all Fermions are entangled with their object/subject particle far away.

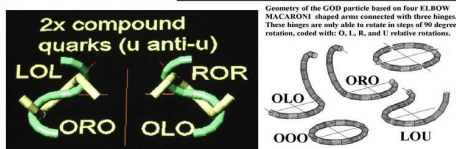
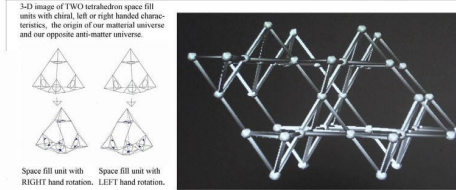
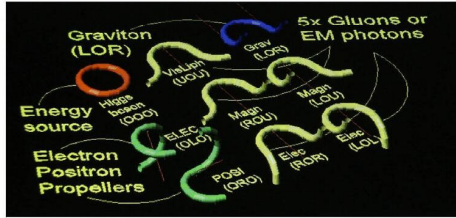

Leo Vuyk@Gmail.com <http://bigbang-entanglement.blogspot.com/>

Figure: 26. poster 3.

At the Quantum level



Double LeSage Quantum Gravity.

Higgs/Graviton pressure vector hedgehogs acting on a mass carrying Quantum particle. The irregular distribution of mass inside the earth is supposed to influence the 3D pressure vector hedgehog according to the new Double LeSage gravity paradigm, see image below.

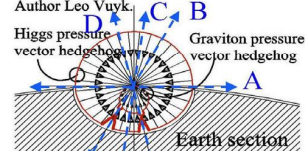

Locations inside the Earth, with extreme high mass concentration, (near Volcanos) measured by inertia pendulum experiment.

Oscillation directions A,B,C,D, of the NEW Inertia Oscillator device, will give larger DAMPING differences as expected by Newtonian gravity rules

LIGHTSPEED Extinction exp.

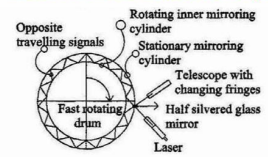

The Babcock and Bergman test done in 1964, resulted in a positive lightspeed drag factor of only 0,7%, which could be translated in a drag extinction effect over less than 1 cm distance after signal passage through the fast moving glass window. See: Journal of the Optical Society of America Vol. 54, nr 2 page 147-151 Febr. 1964. Determination of the Constancy of the speed of Light by Babcock and Bergman.

If the Quantum Mechanical Vacuum structure is influenced over maximal 1 cm. by matter, as the experiment done by Babcock and Bergman seems to indicate, then a fast moving mirror cylinder inside a stationary cylinder should influence the interference pattern produced inside the telescope much more, than the Babcock and Bergman's experiment did. We should get better results, if the distance between the inner and outer mirror cylinder is minimized and the number of lightpath reflections is maximized.

Some FFF Theory related Experiments Function Follows Form in QM and Cosmo

Repeating investigation of the CHAMP/GPS satellite outliers of 180 meter, in relation to the gravity-drag LASOF Ellipsoidal EXTINCTION influence on the lightspeed.

A clear example of GPS failure for sat-sat signals at higher altitudes (CHAMP, 430 km, GPS, 20.000km) Kinematic orbit solution comparison showing GPS data outliers up to 180 meters, (2x) during a CHAMP flight long 24 hours with 15 earth revolutions in 2003.

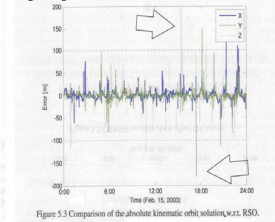
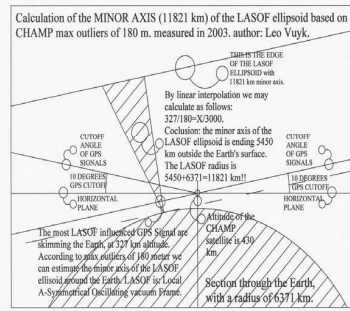

Figure 5.3 Comparison of the absolute kinematic orbit solution, w.r.t. RSO.



Calculation of the MINOR AXIS (11821 km) of the LASOF ellipsoid based on CHAMP max outliers of 180 m. measured in 2003. author: Leo Vuyk.

Support for Atomic ENTANGLEMENT in single and DOUBLE Stern Gerlach experiments

New Stern Gerlach experiment, based on the hypothesis, that the non-smearing paradox described by J.S.Bell, in his book "speakeable and unspeakable in QM" Ch. 16, (page 140-141) is originated by a new unknown form of entanglement at a distance between the first silver atom inside the S-G magnet and the rest, waiting in the silver oven to be released. It is assumed, that the vaporized silveratoms inside and outside the silver oven, are always entangled two by two, to guarantee a total zero-spin state, and the absence of a "SMEARING" effect. author: Leo Vuyk, 23-10-2005

The traditional Stern Gerlach experiment.

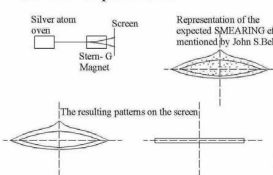

The screen pattern with the S-G magnet ON. The screen pattern with the S-G magnet OFF.

The new proposed experiment, with two S-G magnets always ON

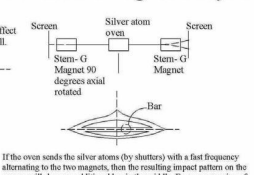

If the oven sends the silver atoms (by shutters) with a fast frequency alternating to the two magnets, then the resulting impact pattern on the screen, will show an additional bar in the middle. Even no smearing of impacts in between is supposed to show up, because of the absence of intermediate polarized atoms between 0 and 90 deg.

Author: Leo Vuyk 30-01-2011 NL

Opposite running LASER signal interference exp. in triangular shape between two Balloons or Satellites and the Earth.

GRAVITY DIRECTION DEPENDENT LIGHT SPEED FRAME DRAGGING by LASOF Local Anti-Symmetrical Oscillating vacuum Frame). SIGAR shaped LASOF Bubble structure of the Earth with proposals for a future two way TRIANGLE satellite signal interference experiment, dates: 9-11-2006 (this is an enlargement of figure B1 dated: 14-01-2005) author : Leo Vuyk.

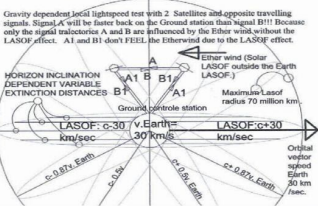

Leo Vuyk@Gmail.com <http://bigbang-entanglement.blogspot.com/>

DOUBLE LeSage Gravity

Higgs/Graviton pressure vector hedgehogs acting on a mass carrying Quantum particle. The irregular distribution of mass inside the earth is supposed to influence the 3D pressure vector hedgehog according to the new Double LeSage gravity paradigm, see image below.

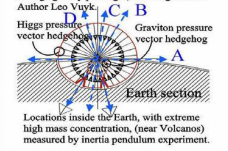

Locations inside the Earth, with extreme high mass concentration, (near Volcanos) measured by inertia pendulum experiment.

Oscillation directions A,B,C,D, of the NEW Inertia Oscillator device, will give larger DAMPING differences as expected by Newtonian gravity rules

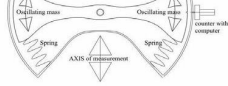

MULTIVERSE exp. New B.Libet experiments focussed on RPI - RPII statistics.

If humans are cooperating decision makers inside the postulated 8 or 12 entangled but separated universes, then for every decision we need one preplanning test-person who preplans his choice. The other 7 or 11 test-occupy-persons are only able to follow OR RECTIFY this decision.

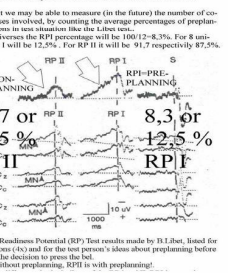

Leo Vuyk@Gmail.com <http://bigbang-entanglement.blogspot.com/>

Figure: 27. poster 4.

References:

[47] **The New God Particle and Free Will.**

Author: Leo Vuyk, **LuLu publishers, 2008.**

ISBN number 978-1-4092-1031-3

<http://www.lulu.com/spotlight/LeoVuyk>

[46] **Quantum FFF Theory is also published in the form of POSTERS at the Flickr site:**

<http://www.flickr.com/photos/93308747@N05/>

[45] **Numbered listing of Vixra essays by Leo Vuyk (see below).**

http://vixra.org/author/leo_vuyk

[44] viXra:1401.0115

Calabi Yau Shaped Double Fermion Spin States.

[43] viXra:1401.0071

Democratic Free Will in the Instant Entangled Multiverse.

[42] viXra:1312.0143

The Navel Cord Multiverse with Raspberry Shape.

[41] viXra:1312.0076

Are Sunspots Made of Gravitating Dark Matter Black Holes?

[40] viXra:1310.0101

The New Nuclear Magic Number (34) Explained by the Polar Coaxial Ring System of
Category: Nuclear and Atomic Physics

[39] viXra:1310.0059

The Semi Relativistic Higgs Field Aether with Mass Related Lightspeed Adaptation.

[38] viXra:1309.0081

New Physics by Table Top Experiments.

[37] viXra:1308.0083

The Raspberry Shaped Super Symmetric Multiverse

[36] viXra:1307.0068

Quantum Function Follows Form Theory, the Small Scale, Posters part 1.

[35] viXra:1307.0067

Quantum Function Follows Form Theory, the Large Scale, Posters part 2.

[34] viXra:1306.0218

Dark Matter UFO Dust Particles or Quantum Knots in the LHC at CERN ?

33, viXra:1306.0065

The Splitting Dark Matter- Black Hole- Big Bang and the Cyclic Multiverse.

32, viXra:1305.0140

Quantum FFF Theory Experiments, a Summary.

31, viXra:1305.0041

The Shnoll Effect Explained by Quantum FFF Theory.

30, viXra:1304.0022

The Self Organizing Universe in the Carina Nebula.

29, viXra:1303.0211

Hubble Redshift Combined with Universal Contraction is Possible.

28, viXra:1303.0053

Micro Birkeland Currents Between Two RF Generated Plasma Balls in the Laboratory.

27, viXra:1302.0172
Silicon Based Ball Lightning Globule Structures and Signs for Accumulation and Retarded Decrease of Tunnelling Energy Bullets.

26, viXra:1301.0088
Two or Three Large Quasar Groups (LQGs) Located at the Start of Two or Three Lyman Alpha Systems and a Part of the Raspberry Multiverse?

25, viXra:1301.0050
Dwarf Galaxies and Their Relation with Dark Matter Based Galaxy Anchor Black Holes (Gabhs).

24, viXra:1210.0177
Instant Broglie Bohm Pilot Waves, the Origin of All Entanglement Effects in the Lab and Wavefunction Collapses in Our Universe as Related to Our Opposing Anti-Copy Universe(s) According to Quantum FFF Theory.

23, viXra:1209.0092
New Dark Matter Black Holes and a New Dark Energy Higgs Field, Lead to a Bouncing CP Symmetrical Multiverse, and New Experiments.

22, viXra:1209.0061
Birkeland Currents, Sunspots, Comets and Ball Lightning Originated by New Paradigm Dark Matter Black Holes.

21, viXra:1209.0030
Majorana and Sterile Neutrino Solutions in the Quantum-FFF Model.

20, viXra:1208.0031
Clumpy Dark Matter Around Dwarf Galaxies a Support for an Alternative Black Hole Theory According to the Quantum Function Follows Form Model.

19, viXra:1202.0091
Earth Magnetic Monopole Array Field Interaction with Cyclotron –Synchrotron Electrons and Muon Conversion Used for Levitation Systems.

18, viXra:1201.0092
Earth Magnetic Monopole Array Field Interaction with Cyclotron Electrons used for Levitation Systems.

17, viXra:1112.0065
LHC Signals Between 121-130 GeV Interpreted with Quantum-FFF Theory

16, viXra:1111.0096
Reconciliation of QM and GR and the Need for a Pulsating Entangled CPT Symmetric Raspberry Shaped Multiverse.

15, viXra:1111.0061
Black Hole Horizon Curvature Dependent Balance Between Plasma Creation and e-e+ Annihilation in Quantum FFF Theory.

14, viXra:1108.0036
Artificial Ball Lightning Production and Exploitation Device for Zero Point Electric Energy Usage.

13, viXra:1108.0006
Mass in Motion in Quantum FFF Theory

12, viXra:1104.0083
Quantum FFF Theory in Posters.

11, viXra:1104.0044
Ball Lightning, Micro Comets, Sprite-Fireballs and X-Ray/gamma Flashes According to Quantum FFF Theory.

10, viXra:1104.0002
Stellar Anchor Black Holes as the Remnants of Former Herbig Haro Objects

9, viXra:1103.0097
ZPE Zero Point Energy Examples Around Black Holes.

8, viXra:1103.0068
Funktion Follows Form, at the Quantum Scale and Beyond.

7, viXra:1103.0024
Quantum Gravity and Electro Magnetic Forces in FFF Theory

6, viXra:1103.0015
Wavefunction Collapse and Human Choice-Making Inside an Entangled Mirror Symmetrical Multiverse.

5, viXra:1103.0011
An Alternative Black Hole, Provided with Entropy Decrease and Plasma Creation

4, viXra:1103.0002
3- Dimensional String Based Alternative Particles Model

3, viXra:1102.0056
Experiments to Determine the Mass Related Lightspeed Extinction Volume

2, viXra:1102.0054
Atomic Nuclear Geometry Based on Magic Number Logic.

1, viXra:1102.0052
Construction Principles for Chiral “atoms of Spacetime Geometry

Could Zero Point Electric Energy (ZPEE) of small dual black hole energy systems save the world?

The exhaustion of earth's resources, the criminal financial system, consumerism, overpopulation, poverty, corporate and personal greed, have brought the earth in great danger. The only way out, seems to be a dramatic but radical change of all these subjects.

However what radical change, should save us and prevent chaos and a third world war?

My only guess is Free Zero Point Electric Energy (ZPEE) Vacuum Energy by New Physics, based on Birkeland/ Alfvén electric currents found around the earth and galaxies, adapted to local/ regional scales of use.

As a consequence all physics intelligence power and finance should be much more focussed on so called "Energetic Blind Spots" in physics and astronomy on local and universal scale.

Examples:

A: There is still no serious world wide coordinated research on Ball Lightning and Earth bound micro Comets going on!

B: Physicists are still guessing about the real origin of the magnetic power of Sunspots!

C: The energetic origin of Comets is a mystery, though the research on Comets is taken more serious in the last years.

Secondly we have to think about new political structures to be able to change the base of world scale ZPEE electricity based food production techniques, earning models and law, to create a democratic Sustainable SUPER SOCIAL SOCIETY.

Only supported by free local/ regional electric vacuum energy, the world will be able to produce local food even in deserts, by influencing the weather/climate conditions by global air conditioning, and to build a world federation of stable local societies governed by computer aided management of production and consumption.

If we are able turn to the deserts by weather/climate change into fertile land, the world should be able to feed a multiple number of inhabitants under the sun, than we have now.

Introduction.

It is an ongoing debate between physicists what the origin should be of the well known polar Birkeland currents and so called electric Alfvén circuits measured around earth and around galaxies.

If we have found the origin of these electric circuits, we probably have also found the origin of several other energetic mysteries on earth and in space, as there are; Ball Lightning, Earth bound Micro Comets, Comets and Sunspots.

The so called Electric Universe Theory has uncovered lots of important cosmological facts around this issue. (ref. 1)

However even this theory does not have a clear physical answer about the origin of these electric currents.

Could it be, that beyond the standard model there is room for an extra role of dark matter and black hole physics?

Professor Matt Strassler wrote about black holes: Why has the controversy gone on so long? It is because the mathematics required to study these problems is simply too hard — no one has figured out how to simplify it enough to understand precisely what happens when black holes form, radiate particles, and evaporate.

<http://profmattstrassler.com/2013/09/16/a-quantum-gravity-cosmology-conference/>

Recently it was even Stephan Hawking who changed his mind about the character of the “apparent horizon” of black holes (ref 2)

“Hawking: Black Holes Do Exist—But it's Complicated” | TIME.com

<http://science.time.com/2014/01/27/black-holes-hawking/#ixzz2rmd6fJoT>

Sunspots, Comets and Ball Lightning.

Could sunspots, comets and ball lightning represent a new kind of Quantum Knots or Dark Matter Black Holes of different sizes, as the origin of those electric currents, or do we have to look for larger scale sunspot resembling objects?

The conventional sunspot solutions,

“How Are Magnetic Fields Related To Sunspots?”

http://sohowww.nascom.nasa.gov/explore/lessons/sunspots6_8.html

Wikipedia:

“They are caused by intense magnetic activity, which inhibits convection by an effect comparable to the **eddy current** brake, forming areas of reduced surface temperature. They usually appear as pairs, with each sunspot having the opposite magnetic pole to the other.”

<https://en.wikipedia.org/wiki/Sunspot>

Solar energy output is now understood to be a result of a dynamo mechanism within the sun, converting the energy of plasma flow beneath the surface of the sun to magnetic energy foci on the surface that are observed in the form of sunspots.

<http://www.hindustantimes.com/india-news/newdelhi/indian-solves-400-year-old-sunspot-mystery/article1-668735.aspx>

The electric universe theory by Wallace Thornhill and David Talbott.

It is suggested that sunspots produce enormous electric currents (ref. 3)

(Thunderbolts) “Electric Sunspots” by Wallace Thornhill and David Talbott.

“Conventional theorists look to magnetism to solve the problem of solar energy distribution. If they were to open their eyes to the electrical cause of magnetism, the solution would suddenly become visible.”

http://www.thunderbolts.info/tpod/2007/arch07/070222electric_sunspots.htm

and “Electric Sun” by Wallace Thornhill and David Talbott

http://www.bibliotecapleyades.net/electric_universe/electric_sun01.htm

and the “Electric Comet” by Wallace Thornhill and David Talbott

http://www.bibliotecapleyades.net/electric_universe/esp_electricuniverse17.htm

“a synopsis of the electric universe” by Wal Thornhill.

http://www.bibliotecapleyades.net/electric_universe/esp_electricuniverse16.htm

Toward a Real Cosmology in the 21st Century

Wallace W. Thornhill*

<http://www.benthamsience.com/open/toaaj/articles/V004/SI0162TOAAJ/191TOAAJ.pdf>

Other sources of electric sunspot ideas:

and: “Sunspot physics” Frequently sunspots occur in pairs. The two spots have opposite magnetic polarities, like the north and south poles of a horseshoe magnet.”

<http://www.esrl.noaa.gov/gsd/outreach/education/sam1/Activity10.html>

other sources;

The Origin of Sunspots - A New Hypothesis, by Ackerman, J.

“Sunspots are caused by highly energetic solid bodies falling into the Sun”
Comets?

<http://adsabs.harvard.edu/abs/2003AGUFMSH42B0546A>

The puzzle: Why do sunspots last for weeks instead of flying apart? Like huge magnets, strong magnetic fields in sunspots naturally repel each other. What holds them together?

<http://soi.stanford.edu/press/ssu11-01/>

Sunspots are not the result of convection of gas modified by magnetism. Sunspots are electrical structures.

Nasa: “What Lies Beneath a Sunspot?”

“Planet-sized dark spots on the Sun have puzzled scientists for hundreds of years”

http://science1.nasa.gov/science-news/science-at-nasa/2001/ast07nov_1/

Dark Matter Black Hole Sunspots:

“The Self Organizing Universe in the Carina Nebula.”

My own contribution. <http://rxiv.org/pdf/1304.0022v1.pdf>

“Are Sunspots made of gravitating Dark Matter Black Holes? (My own contribution).”

<http://vixra.org/pdf/1312.0076v1.pdf>

Universal Dark Matter Black Holes.

"Massless black hole pairs in string theory" By: R. Emparan 1996. Department of Physics University of California <http://arxiv.org/pdf/hep-th/9607102v3.pdf>

“Hubble Redshift Despite Universal Contraction is possible.”

http://fqxi.org/data/essay-contest-files/Vuyk_13747558.pdf [Hubble Re.pdf](#)

”The Bouncing CP symmetrical Multiverse, based on a massless but energetic oscillating (non SM Higgs) Vacuum Particle System.”

http://fqxi.org/data/essay-contest-files/Vuyk_13121461.pdf [The bounc 1.pdf](#)

"The case for primordial black holes as dark matter" Author: M.R.S. Hawkins(20 Jun 2011)

<http://arxiv.org/abs/1106.3875>

Recent evidence for polar solar hotspots found by the IceCube experiment as telltale for Solar Anchor Black Holes (SABHs)?.

See: IceCube Neutrino Observatory

https://en.wikipedia.org/wiki/IceCube_Neutrino_Observatory#Results

“Strange cosmic ray hotspots stalk southern skies”

<http://www.newscientist.com/article/dn20436-strange-cosmic-ray-hotspots-stalk-southern-skies.html#.UuqH1j15OJp>

Could this be one of the telltales (the southern) of a Solar Anchor Black Holes?

=====