

Unsolved Problems in Special and General Relativity

Chief Editor:

Florentin Smarandache

Vice Chief Editors:

Fu Yuhua & Zhao Fengjuan

Education Publishing - ISBN: 9781599732206

Florentin Smarandache
editor-in chief

Fu Yuhua
Zhao Fengjuan
associate editors

Unsolved Problems in Special and General Relativity
21 collected papers

Educational Publishing & Journal of Matter Regularity (Beijing)

2013

Unsolved Problems in Special and General Relativity
21 collected papers

Florentin Smarandache
editor-in-chief

Fu Yuhua
Zhao Fengjuan
associate editors

2013

This book can be ordered on paper or electronic formats from:

Education Publishing
1313 Chesapeake Avenue
Columbus, Ohio 43212
USA
Tel. (614) 485-0721
E-mail: info@edupublisher.com

Copyright 2013 by *Education Publishing & Journal of Matter Regularity (Beijing), Editors and the Authors for their papers*

Front and back covers by the Editor-in-Chief & V. Christianto

Peer-reviewers:

Eng. Victor Christianto, Indonesia, URL: <http://www.sciprint.org>, email: victorchristianto@gmail.com.

Prof. Marinela Preoteasa, Str. Mânastirii, Nr 7, Bloc 1C, Scara A, Et. 3, Ap. 13, Slatina, Jud. Olt, Cod postal: 230038, Romania.

Prof. Valeri Kroumov, Dept. of Electrical and Electronic Engineering, Okayama University of Science, 1-1 Ridai-cho, Kita-ku, Okayama 700-0005, Japan.

ISBN: 9781599732206

Printed in the United States of America

Preface

This book includes 21 papers written by 23 authors and co-authors. All papers included herein are produced by scholars from People's Republic of China, except two papers written by Prof. L. Sapogin, V. A. Dzhanibekov, Yu. A. Ryabov from Russia, and by Prof. Florentin Smarandache from USA. The editors hope that all these papers will contribute to the advance of scholarly research on several aspects of Special and General Relativity. This book is suitable for students and scholars interested in studies on physics.

The first paper is written by Hua Di. He writes that Einstein's general theory of relativity cannot explain the perihelion motion of Mercury. Einstein's explanation, based on wrong integral calculus and arbitrary approximations, is a complete failure.

The following paper is written by Li Zifeng. His paper reviews basic hypotheses and viewpoints of space-time relationship in Special Relativity; analyzes derivation processes and the mistakes in the Lorentz transformation and Einstein's original paper. The transformation between two coordinate systems moving uniformly relatively to another is established. It is shown that Special Relativity based upon the Lorentz transformation is not correct, and that the relative speed between two objects can be faster than the speed of light.

The next paper is written by Li Wen-Xiu. His paper presents problems with the special theory of relativity (STR), including: (1) The principle of relativity as interpreted by Einstein conflicts with the uniqueness of the universe. (2) The light principle conflicts with the notion that natural phenomena depend only upon mutual interaction and the involved relative motion. The principle contains a tacit assumption that leads to self-contradiction.

The next paper by Shi Yong-Cheng says that Einstein's book "The Meaning of Relativity" contains of a supper mistake which leads to the famous twin "paradox".

The following paper by Xu Jianmin proposes the assumptions of radiation and redshift, establishes the quantum gravitational field equations and motion equations, and presents that particles move along the path with the minimum entropy production. The paper also applies the equivalence principle of acceleration and the gravitational field into the electromagnetic field, which makes the electromagnetic field equation to have the same form with gravitational field equation.

The next paper is written by Dong Jingfeng. By the analysis of twin paradox, it is pointed out that the constriction of space-time is the only effect of measurement and all paradoxes do not exist actually. The essence of special relativity is a number method for ways to provide math and physical idea.

The following paper is written by Duan Zhongxiao. Through comparing the two Lorentz transformations located at different regions, the author finds that for two inertial systems running the relative uniform speed translational motion, if two clocks are synchronous in one system, they are also synchronous looked from another system; this means that the relative character of simultaneity is not the ultimate source of temporal and spatial transformation. Thus we know that it is wrong to introduce the one-way spreading light signals along with all directions in space into transformation.

Fu Yuhua writes the next paper. He says that special theory of relativity and general theory of relativity have three basic shortcomings. First, the special and general theory of relativity respectively have two basic principles, altogether have four basic principles in the

interior of relativity, these obviously do not conform to the truth uniqueness. Second, for the two basic principles of special theory of relativity and the two basic principles of general theory of relativity, no one is generally correct. Third, establishes the physical theory from the mathematics principle instead of the physical principle. Based on these, the applicable scopes of special and general theory of relativity are presented.

Guo Kaizhe and Guo Chongwu write the following paper. They write that there are magnetic field forces between positive charge and negative charge in an electric dipole which is moving in a laboratory reference frame. Whereas, examining the electric dipole in a reference frame which is at rest relative to the electric dipole, we find no magnetic field force exists between the two charges.

The next paper is written by Guo Ying-Huan and Guo Zhen-Hua. They write that by carefully comparing the results given by the general theory of relativity and the actual astronomical observation, the contradiction between them is found to be difficult to overcome. Furthermore, there is no sign so far of the existence of “the waves” predicted by the general theory of relativity.

Hu Chang-Wei writes the next paper. According to him, in the absolute space-time theory, the ether is a compressible superfluid, a change in the ether density causes a change in the actual space-time standard, and thus, the phenomena occur. The relativity made up the shortcoming of absolute space-time theory in quantity, while the physical basis of relativity can be described and its limitations can be showed on the basis of absolute space-time theory.

Jiang Chun-Xuan writes the following paper. Using two methods he deduces the new gravitational formula. Gravity is the tachyonic centripetal force.

In the next paper, he also found a new gravitational formula: $\bar{F} = -mc^2/R$, established the expansion theory of the universe, and obtained the expansion acceleration: $g_e = u^4/C^2R$.

Liu Taixiang writes the following paper. On the basis of the system relativity, the author firstly proves the absoluteness of movement, and then deduces the conclusion that time derives from movement, then subsequently obtains such properties of time as one dimension, irreversibility, infiniteness, non-uniformity and relativity, etc. by illustrating the relationship between time and space and the concept of universe state, and ultimately deduces a steady cosmological model and a prospect of the total universe.

Tu Runsheng writes the next paper. He writes that in a limited number of experiments that support Theory of Relativity, there also exist some points that are not supportive of the theory. Therefore, Theory of Relativity does not solve the problem of experimental verification.

The following paper is written by Wu Fengming. According to the “paradox of singularity theorem” proof of concept of time, the mathematical logic and the prerequisite conditions, based on successive analytical, logical argumentation about time singularity theorem proving the beginning and the end of the conclusions cannot be established.

Yang Shijia writes that he has studied Einstein's original “on the Electrodynamics of Moving Body” for many years, found its own 30 unsolved problems at least, Einstein's theory of relativity is a mistake from beginning to end.

Chao Shenglin writes in the next paper that if ones think of the possibility of the existence of the superluminal-speeds (the speeds faster than that of light) and re-describe the special theory of relativity following Einstein's way, it could be supposed that the physical space-time is a Finsler space-time.

In the following paper, Fu Yuhua writes that although the explanation of general relativity for the advance of planetary perihelion is reasonably consistent with the observed data, because its orbit is not closed, whether or not it is consistent with the law of conservation of energy has not been verified. For this reason a new explanation is presented: The advance of planetary perihelion is the combined result of two motions. The first elliptical motion creates the perihelion, and the second vortex motion creates the advance of perihelion.

Sapogin, Dzhaniybekov, and Ryabov discuss the problems of new unitary quantum view of the world in its applications to the different aspects of the reality.

In the last paper, Florentin Smarandache revisits several paradoxes, inconsistencies, contradictions, and anomalies in the Special and General Theories of Relativity. Also, he re-proposes new types of Relativities and two physical experiments.

Florentin Smarandache

Unsolved Problems in Special and General Relativity

Contents

Preface	iv
1 Einstein’s Explanation of Perihelion Motion of Mercury	
Hua Di	3
2 Special Relativity Arising from a Misunderstanding of Experimental Results on the Constant Speed of Light	
Li Zifeng	8
3 Problems with the Special theory of Relativity	
Li Wen-Xiu	21
4 Criticism to Einstein’s Physics Thinking in His Book “The Meaning of Relativity”	
Shi Yong-Cheng	33
5 Using Space-time Quantization to Solve the Problems Unsolved by General Relativity	
Xu Jianmin	41
6 New Exploration for the Enigma of Paradox in Special Relativity	
Dong Jingfeng	59
7 Unsolved Problems in Special Relativity and Methods to Solve Them	
Duan Zhongxiao	66
8 Shortcomings and Applicable Scopes of Special and General Theory of Relativity	
Fu Yuhua	81
9 Reconsideration on Validity of the Principle of Relativity in Relativistic Electromagnetism	
Guo Kaizhe, Guo Chongwu	104
10 Is The General Theory of Relativity a Scientific Theory?	
Guo Ying-Huan, Guo Zhen-Hua	108
11 The Theory of Relativity and Compressibility Ether	
Hu Chang-Wei	113
12 New Gravitational Formula: $\bar{F} = -\frac{mc^2}{R}$	
Jiang Chun-Xuan	125
13 The Expansion Theory of the Universe Without Dark Energy	
Jiang Chun-Xuan	131
14 An Unsettled Issue of Time in Relativity Theory and New Comprehension on Time	
Liu Taixiang	141
15 Theory of Relativity Does Not Solve the Problem of Experimental Verification	

Tu Runsheng	154
16 Analysis of “Singular Point Theorems”—Further Understanding of Relativistic Time View	
Wu Fengming	173
17 The Own Unresolved Issues of Einstein's Original Work: On the Electrodynamics of Moving Body	
Yang Shijia	181
18 The Theory of Relativity and Cosmology on the Finsler Space-time	
Cao Shenglin	191
19 New Explanation of Advance of Planetary Perihelion and Solar System’s Vortex Motion	
Fu Yuhua	249
20 Relativistic Problems in the Unitary View Quantum View of The World	
Leo G. Sapogin, V.A. Dzhanibekov, and Yu. A. Ryabov	253
21 Questioning the Special and General Relativity	
Florentin Smarandache	288

Einstein's Explanation of Perihelion Motion of Mercury

Hua Di

Academician, Russian Academy of Cosmonautics

Research Fellow (ret.), Stanford University

dihua36@gmail.com

Abstract: Einstein's general theory of relativity cannot explain the perihelion motion of Mercury. His explanation, based on wrong integral calculus and arbitrary approximations, is a complete failure.

Keywords: Einstein, general theory of relativity, perihelion motion of Mercury

Einstein applied his general theory of relativity to explain three astronomical phenomena: The sunlight's red shift (1911), the perihelion motion of Mercury (1915) and the angular deflection of light by the sun's gravitation (1916). Among the three, the explanation of perihelion motion of Mercury was his dearest. In a letter to a friend he wrote: *“Last month was one of the most exciting, intense and, of course, harvest periods in my life. An equation yields correct data of the perihelion motion of Mercury and you can imagine how glad I was! For a few days I was beside myself with excitement, unable to do anything, immersed in an enchanted dream-like stupor.”*

1 Einstein's Explanation from His General Theory of Relativity

In his 1915 paper *“Explanation of the Perihelion Motion of Mercury from the General Theory of Relativity”*^[1] Einstein provided the following formula for calculating perihelion motion of planets:

$$\varepsilon = 24\pi^3 \frac{a^2}{T^2 c^2 (1 - e^2)}, \quad (1)$$

where ε is the perihelion advance in the sense of orbital motion after a complete orbit, T the orbital period, a the orbit's semi major axis, e the orbit's eccentricity and c the velocity of light.

For Mercury: $T \approx 87.969$ [earth day] $\approx 7.6 \times 10^6$ [s], $a \approx 5.791 \times 10^{10}$ [m] and $e \approx 0.205631$. With these data, his formula (1) yields Mercury's perihelion motion $\varepsilon \approx 5.013 \times 10^{-7}$ [radian] per mercury-year. For every 100 earth-year (365318 earth-day)

Mercury makes $\frac{365318}{87.969} = 415.28$ orbital rounds. Therefore, its perihelion motion per 100

earth-years is:

$$5.013 \times 10^{-7} \times 415.28 \approx 2.08 \times 10^{-4} [\text{rad}] \approx 43''$$

Matching the astronomical observation. Einstein declared his success: “***I find an important confirmation of this most fundamental theory of relativity, showing that it explains qualitatively and quantitatively the secular rotation of the orbit of Mercury.***”

According to Einstein’s 1915 paper, his formula (1) comes from an equation:

$$\phi = \pi \left[1 + \frac{3}{4} \alpha (\alpha_1 + \alpha_2) \right]. \quad (2)$$

ϕ is the angle described by the radius-vector between perihelion and aphelion. Therefore, the

perihelion advance is $\varepsilon = 2(\phi - \pi)$. $\alpha_1 = \frac{1}{r_1}$ and $\alpha_2 = \frac{1}{r_2}$ signify the reciprocal values of

the orbit’s maximum and minimum distances r_1 and r_2 from the sun.

$\alpha = \frac{2kW}{c^2} \approx 2.9535 \times 10^3 [m]$ is a constant with the gravitational constant

$k = 6.673 \times 10^{-11} [m^3 kg^{-1} s^{-2}]$ and the sun’s gravitational mass $W \approx 1.9891 \times 10^{30} [kg]$.

Mercury’s $r_1 \approx 6.9818 \times 10^{10} [m]$ and $r_2 \approx 4.6002 \times 10^{10} [m]$. So, its

$\alpha_1 \approx 1.432309 \times 10^{-11} [m^{-1}]$ and $\alpha_2 \approx 2.173847 \times 10^{-11} [m^{-1}]$. Placing these data **directly** into Einstein’s equation (2), **without needlessly resorting to his formula (1) which will be questioned in §3**, it can be obtained:

$$\varepsilon = 2(\phi - \pi) = \frac{3}{2} \pi \alpha (\alpha_1 + \alpha_2) \approx 5.019 \times 10^{-7} [\text{rad}] \text{ per mercury-year}$$

or $5.019 \times 10^{-7} \times 415.28 \approx 2.084 \times 10^{-4} [\text{rad}] \approx 43''$ per 100 *earth-years*.

2 Einstein’s Fatal Error in Integral Calculus

Einstein obtained his equation (2) from an integration deduced **approximately** from his general theory of relativity:

$$\phi = \left[1 + \alpha (\alpha_1 + \alpha_2) \right] \int_{\alpha_1}^{\alpha_2} \frac{dx}{\sqrt{-(x - \alpha_1)(x - \alpha_2)(1 - \alpha x)}}, \quad (3)$$

or **approximately**, upon expansion of $(1 - \alpha x)^{-1/2}$,

$$\phi = \left[1 + \alpha(\alpha_1 + \alpha_2)\right] \int_{\alpha_1}^{\alpha_2} \frac{\left(1 + \frac{\alpha}{2}x\right) dx}{\sqrt{-(x - \alpha_1)(x - \alpha_2)}}. \quad (4)$$

“*The integration*” Einstein writes, “*yields* $\phi = \pi \left[1 + \frac{3}{4}\alpha(\alpha_1 + \alpha_2)\right]$.” This is a fatal

error! Actually, a correct integration should be as follows:

$$\begin{aligned} \int \frac{\left(1 + \frac{\alpha}{2}x\right) dx}{\sqrt{-(x - \alpha_1)(x - \alpha_2)}} &= \int \frac{dx}{\sqrt{-(x - \alpha_1)(x - \alpha_2)}} + \frac{\alpha}{2} \int \frac{xdx}{\sqrt{-(x - \alpha_1)(x - \alpha_2)}} \\ &= \int \frac{dx}{\sqrt{-(x - \alpha_1)(x - \alpha_2)}} + \frac{\alpha}{2} \left[-\sqrt{-(x - \alpha_1)(x - \alpha_2)} + \frac{\alpha_1 + \alpha_2}{2} \int \frac{dx}{\sqrt{-(x - \alpha_1)(x - \alpha_2)}} \right] \\ &= \left[1 + \frac{\alpha}{4}(\alpha_1 + \alpha_2)\right] \int \frac{dx}{\sqrt{-(x - \alpha_1)(x - \alpha_2)}} - \frac{\alpha}{2} \sqrt{-(x - \alpha_1)(x - \alpha_2)} \\ &= \left[1 + \frac{\alpha}{4}(\alpha_1 + \alpha_2)\right] \times \arcsin \frac{2x - (\alpha_1 + \alpha_2)}{\alpha_2 - \alpha_1} - \frac{\alpha}{2} \sqrt{-(x - \alpha_1)(x - \alpha_2)}. \end{aligned}$$

$$\begin{aligned} \text{Therefore, } \int_{\alpha_1}^{\alpha_2} \frac{\left(1 + \frac{\alpha}{2}x\right) dx}{\sqrt{-(x - \alpha_1)(x - \alpha_2)}} &= \left[1 + \frac{\alpha}{4}(\alpha_1 + \alpha_2)\right] \left[\arcsin \frac{\alpha_2 - \alpha_1}{\alpha_2 - \alpha_1} - \arcsin \frac{\alpha_1 - \alpha_2}{\alpha_2 - \alpha_1} \right] \\ &= \left[1 + \frac{\alpha}{4}(\alpha_1 + \alpha_2)\right] [\arcsin 1 - \arcsin(-1)] \\ &= \left[1 + \frac{\alpha}{4}(\alpha_1 + \alpha_2)\right] \cdot 2 \arcsin 1 = \pi \left[1 + \frac{\alpha}{4}(\alpha_1 + \alpha_2)\right], \end{aligned}$$

not Einstein’s $\pi \left[1 + \frac{3}{4}\alpha(\alpha_1 + \alpha_2)\right]!$

Finally, the correct integration yields:

$$\begin{aligned} \phi &= \left[1 + \alpha(\alpha_1 + \alpha_2)\right] \int_{\alpha_1}^{\alpha_2} \frac{\left(1 + \frac{\alpha}{2}x\right) dx}{\sqrt{-(x - \alpha_1)(x - \alpha_2)}} = \left[1 + \alpha(\alpha_1 + \alpha_2)\right] \pi \left[1 + \frac{\alpha}{4}(\alpha_1 + \alpha_2)\right] \\ &= \pi \left[1 + \frac{5}{4}\alpha(\alpha_1 + \alpha_2) + \frac{1}{4}\alpha^2(\alpha_1 + \alpha_2)^2\right]. \end{aligned}$$

and $\varepsilon = 2(\phi - \pi) = \frac{\pi}{2} \alpha(\alpha_1 + \alpha_2)[5 + \alpha(\alpha_1 + \alpha_2)] \approx 8.3651 \times 10^{-7} \text{ [rad] per mercury-year}$

or $8.3651 \times 10^{-7} \times 415.28 \approx 3.4738 \times 10^{-4} \text{ [rad]} \approx 71.5'' \text{ per 100 earth-years.}$

It is far different from 43'' of the astronomical observation.

Einstein's explanation contains one more operational error. Although $[1 + \alpha(\alpha_1 + \alpha_2)] \approx 1$ since Mercury's

$$\alpha(\alpha_1 + \alpha_2) = 2.9535 \times 10^3 (1.432309 \times 10^{-11} + 2.173847 \times 10^{-11}) \approx 1.0651 \times 10^{-7} \ll 1,$$

the $[\alpha(\alpha_1 + \alpha_2)]$ is not negligible. Because, the very fine quantity of Mercury's perihelion motion $\varepsilon = 2(\phi - \pi)$ originates exactly from the very small difference between ϕ and π , so

that the approximation of $\phi = \int_{\alpha_1}^{\alpha_2} \frac{\left(1 + \frac{\alpha}{2}x\right)dx}{\sqrt{-(x - \alpha_1)(x - \alpha_2)}}$ instead of

$\phi = [1 + \alpha(\alpha_1 + \alpha_2)] \int_{\alpha_1}^{\alpha_2} \frac{\left(1 + \frac{\alpha}{2}x\right)dx}{\sqrt{-(x - \alpha_1)(x - \alpha_2)}}$ is misleading. Actually, without his arbitrary

approximation, Einstein's wrong integration would have led to:

$$\begin{aligned} \phi &= [1 + \alpha(\alpha_1 + \alpha_2)] \int_{\alpha_1}^{\alpha_2} \frac{\left(1 + \frac{\alpha}{2}x\right)dx}{\sqrt{-(x - \alpha_1)(x - \alpha_2)}} = [1 + \alpha(\alpha_1 + \alpha_2)] \pi \left[1 + \frac{3}{4} \alpha(\alpha_1 + \alpha_2)\right] \\ &= \pi \left[1 + \frac{7}{4} \alpha(\alpha_1 + \alpha_2) + \frac{3}{4} \alpha^2 (\alpha_1 + \alpha_2)^2\right] \end{aligned}$$

and $\varepsilon = 2(\phi - \pi) = \frac{\pi}{2} \alpha(\alpha_1 + \alpha_2)[7 + 3\alpha(\alpha_1 + \alpha_2)] \approx 11.711 \times 10^{-7} \text{ [rad] per mercury-year,}$

or $11.711 \times 10^{-7} \times 415.28 \approx 4.8633 \times 10^{-4} \text{ [rad]} \approx 100.1'' \text{ per 100 earth-years.}$

The result would be even worse!

3 Einstein's Formula (1) is Questionable

According to Einstein's formula (1), $\varepsilon \neq 0$ even if $e = 0$. However, if a planet moves along a circular orbit ($e = 0$) without eccentricity, then its orbit has neither perihelion nor aphelion. How can it have perihelion motion $\varepsilon \neq 0$?

Mercury's orbit is not a strict ellipse. That's why it has perihelion motion. Nevertheless,

Einstein makes an **approximation** by use of the relationships among an elliptic orbit's parameters:

$$r_1 = a(1+e), \quad r_2 = a(1-e), \quad \alpha_1 + \alpha_2 = \frac{1}{r_1} + \frac{1}{r_2} = \frac{1}{a(1+e)} + \frac{1}{a(1-e)} = \frac{2}{a(1-e^2)}.$$

Thus, his equation (2) becomes $\phi = \pi \left[1 + \frac{3}{2} \frac{\alpha}{a(1-e^2)} \right]$ and he **approximately** obtains:

$$\varepsilon = 2(\phi - \pi) = 3\pi \frac{\alpha}{a(1-e^2)}. \quad (5)$$

Since elliptic orbit's period is $T = \frac{2\pi}{\sqrt{kW}} a^{3/2}$, so $\alpha = \frac{2kW}{c^2} = \frac{8\pi^2 a^3}{T^2 c^2}$ which leads (5)

to his formula (1):
$$\varepsilon = 24\pi^3 \frac{a^2}{T^2 c^2 (1-e^2)}$$

with irrational appearance of the eccentricity e in it.

For every round of its orbit ($360^\circ = 1296000''$), Mercury's perihelion motion is just about $1''$. To deal with such a fine quantity, it does not allow Einstein to do **so many arbitrary approximations**.

4 Conclusion and More

Einstein's general theory of relativity cannot explain Mercury's perihelion motion. He obtained "*for the planet Mercury, a perihelion advance of 43'' per century*" by an incorrect integral calculus and many arbitrary approximations. His formula (1) is a poorly patched wrong result, tailored specially for Mercury. That is why his formula (1) fails to explain the perihelion motions for Earth and Mars. Einstein was unfair to blame "*the small eccentricities of the orbits of these planets*" for his failure. To sum up, Einstein's general theory of relativity is dubious.

Moreover, based solely on the principle of relativity without any postulate (such as Einstein's constant speed of light and Lorentz-Fitzgerald's length-contraction), this author has developed a new relativistic mechanics^[2]. The new relativistic mechanics can precisely explain all the three astronomical phenomena (the sunlight's red shift, the perihelion motion of Mercury and the angular deflection of light by the sun's gravitation) within mechanical framework. In short, gravitation is force by nature. Geometrized gravitation with four-dimensional space-time warped by matter is not true.

Reference

- [1] A. Einstein, The Collected Papers of Albert Einstein, Princeton University, 6:112-116.
 [2] Di Hua, Challenging Einstein's Theory of Relativity, China Astronautics Publishing Co.,

Special Relativity Arising from a Misunderstanding of Experimental Results on the Constant Speed of Light

Li Zifeng

(Yanshan University, Qinhuangdao, Hebei, 066004, China)

Abstract: All experiments show that the speed of light relative to its source measured in vacuum is constant. Einstein interpreted this fact such that any ray of light moves in the “stationary” system with a fixed velocity c , whether the ray is emitted by a stationary or by a moving body, and established Special Relativity accordingly. This paper reviews basic hypotheses and viewpoints of space-time relationship in Special Relativity; analyzes derivation processes and the mistakes in the Lorentz transformation and Einstein’s original paper. The transformation between two coordinate systems moving uniformly relatively to another is established. It is shown that Special Relativity based upon the Lorentz transformation is not correct, and that the relative speed between two objects can be faster than the speed of light.

Keywords: Special Relativity, light speed, Einstein, Lorentz transformation

1 Introduction

Special Relativity was established by Einstein nearly a century ago¹ and has become nowadays a compulsory course in many universities². However, the rationality of its derivation process and its conclusions are still under suspicion³⁻²⁸.

This paper briefly reviews the basic hypotheses and the main viewpoints of space-time in Special Relativity. The derivations and the mistakes involved in the Lorentz transformation and Einstein’s original paper are analyzed. The transformation between two coordinate systems moving uniformly relatively to another will be revised. It will be shown that Special Relativity based upon the Lorentz transformation is not correct, and that the relative speed between two objects can be faster than the speed of light.

2 Summary of Special Relativity²

2.1 Basic hypotheses in Special Relativity

(1) Principle of relativity: For describing any law of motion, all inertial coordinate systems moving uniformly relatively to another are equal.

(2) Principle of the constant speed of light: The speed of light measured in vacuum in all inertial coordinate systems moving uniformly relatively to another is the same.

2.2 Lorentz transformation

Two coordinate systems K and K' ($OXYZ$ and $O'X'Y'Z'$), with their respective axes parallel to another, move uniformly relatively to another with a speed v of K' relative to K along X -axis. The time count starts when O and O' coincide with each other, as shown in Fig. 1.

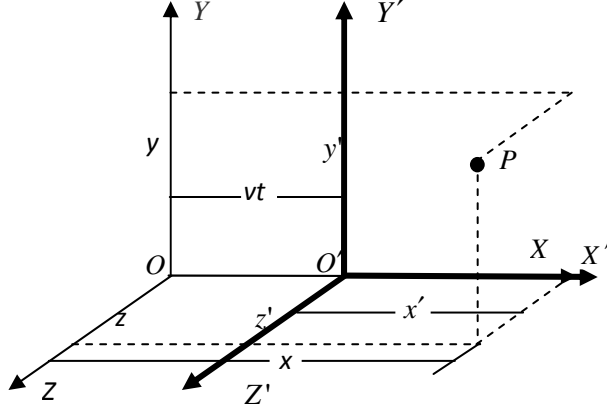

Figure 1. Coordinate system 1

Let (x, y, z, t) be an event appearing in K at time t , the same event appears in K' as (x', y', z', t') at time t' . Time-space coordinates (x, y, z, t) and (x', y', z', t') that describe the same event satisfy the Lorentz transformation

$$x' = \frac{x - vt}{\sqrt{1 - \left(\frac{v}{c}\right)^2}}, y' = y, z' = z, t' = \frac{t - \frac{vx}{c^2}}{\sqrt{1 - \left(\frac{v}{c}\right)^2}}. \quad (1)$$

$$x = \frac{x' + vt'}{\sqrt{1 - \left(\frac{v}{c}\right)^2}}, y = y', z = z', t = \frac{t' + \frac{vx'}{c^2}}{\sqrt{1 - \left(\frac{v}{c}\right)^2}}. \quad (2)$$

where, c is the speed of light.

The derivation of the Lorentz transformation is as follows.

For point O , $x = 0$ is observed in K all the time; but $x' = -vt'$ is observed in K' at time t' , viz. $x' + vt' = 0$. Therefore it could be seen that x and $x' + vt'$ become zero at the same time for the point O . Then, suppose that there is a direct ratio k between x and $x' + vt'$ all the time, i.e.,

$$x = k(x' + vt'). \quad (3)$$

Or, for point O' ,

$$x' = k'(x - vt). \quad (4)$$

The principle of relativity requires that K is equal to K' . The two equations above have to be of the same form, such that k is equal to k'

$$k = k'. \quad (5)$$

Thus

$$x' = k(x - vt). \quad (6)$$

To establish the transformation, the constant k must be determined. According to the principle of the constant speed of light, if a light signal goes along OX when O and O' are at the same point ($t = t' = 0$), at any time t (t' in K'), the positions of this signal at these two coordinate systems are as follows respectively

$$x = ct, x' = ct'. \quad (7)$$

Substituting equation (7) into the product of equation (3) and equation (6), we have

$$k = \frac{c}{\sqrt{c^2 - v^2}} = \frac{1}{\sqrt{1 - \left(\frac{v}{c}\right)^2}}. \quad (8)$$

Substituting equation (8) into (3) and (4), we have

$$x' = \frac{x - vt}{\sqrt{1 - \left(\frac{v}{c}\right)^2}}, t' = \frac{t - \frac{vx}{c^2}}{\sqrt{1 - \left(\frac{v}{c}\right)^2}}. \quad (9)$$

$$x = \frac{x' + vt'}{\sqrt{1 - \left(\frac{v}{c}\right)^2}}, t = \frac{t' + \frac{vx'}{c^2}}{\sqrt{1 - \left(\frac{v}{c}\right)^2}}. \quad (10)$$

2.3 Key points of Special Relativity

Based on the Lorentz transformation, Special Relativity concluded that:

(1) Simultaneity effect: If two events appear at two points in a coordinate system at rest synchronously, the times that these two events appear in another coordinate system moving uniformly are not same.

(2) Length contraction effect: In a coordinate system with a relative speed, the length of an object measured along the speed direction of the system is shorter than that measured in another coordinate system in which the object is at rest.

(3) Time dilation effect: For an event, the time measured in a coordinate system with relative speed to the place is longer than that measured in another coordinate system in which the place is at rest.

2.4 Dynamics of Special Relativity

(1) The mass of an object measured in a moving coordinate system is larger than that measured in the coordinate system in which the object is at rest.

(2) The energy of an object equals its mass multiplied by the square of the speed of light.

3 Some Mistakes in Special Relativity

3.1 Wrong comprehending of experimental results on the constant speed of light

Until now, all experiments show that the speed of light relative to its source measured in vacuum is constant. This can be explained as follows.

(1) For light signals in vacuum radiated from sources that are fixed in any inertial coordinate systems, measured speeds of these light signals relative to their sources (or coordinate systems) respectively are equal.

(2) For light signals in vacuum radiated from a definite source, light speeds relative to its source measured in coordinate systems moving uniformly relatively to another are equal.

The above fact described by Ref. 2, and Section 2.1 of this paper, is changed to “the speed of light measured in vacuum in all inertial coordinate systems moving uniformly relatively to another is the same”, named as “principle of the constant speed of light”. It does not point out that the speed of the light is relative to its source. In the derivation of the Lorentz transformation, the above fact is formulated such that for light in vacuum radiated from a definite source, light speeds relative to any coordinate systems are equal. In Einstein’s words, any ray of light moves in the “stationary” system of coordinates with the determined velocity

c, whether the ray is emitted by a stationary or by a moving body. This is also named “the principle of the constant speed of light”. This is wrong, because it neglects relative motions between coordinate systems, as listed in Table 1.

Table 1. Experimental result of light speed and the principle of the constant speed of light

	True fact	Incomplete statement	Wrong explanation
Statement	The speed of light relative to its source measured in vacuum in all inertial coordinate systems moving uniformly relatively to another is constant.	The speed of light measured in vacuum in all inertial coordinate systems moving uniformly relatively to another is the same.	Any ray of light moves in the “stationary” system of coordinates with the determined velocity c, whether the ray be emitted by a stationary or by a moving body.
Name	No	The principle of the constant speed of light by ref 2.	The principle of the constant speed of light by Einstein.
Mistakes	No	Not pointing out that the speed is light relative to its source.	Neglecting relative motions between coordinate systems.

Equations (1) through (6) describe an object’s motion in a fixed system, its motion in another moving system and the possible transformation between these two systems. Here, k must be determined using equation (7). In equation (7), $x = ct$ describes a photon emitted from a source fixed at the origin of the fixed system. Equation $x' = ct'$ describes another photon emitted from a source fixed at the origin of the moving system. There is a relative motion between these two sources. So, there is a relative motion between these two photons from two different sources. Equations (1) through (6) describe one object in two systems. On the other hand, Equations (7) $x = ct$, $x' = ct'$ describe two different objects (photons) moving in two systems independently. It is problematic to substitute Eq. (7) into equation (6). Actually, to obtain k , $x = ct$, $x' = ct' - vt'$ must be used instead of those in Eq. (7).

3.2 The coordinate in the direction of motion of the Lorentz transformation²⁰ is 0=0

With reference to the equations in Section 2.2, in expression $x' = \frac{x - vt}{\sqrt{1 - \left(\frac{v}{c}\right)^2}}$,

because $x - vt \equiv 0$, we have $x' \equiv 0$. Similarly, in expression $x = \frac{x' + vt'}{\sqrt{1 - \left(\frac{v}{c}\right)^2}}$, $x' + vt' \equiv 0$

results in $x \equiv 0$.

Also in Section 2.2, there is a statement “For point O , $x = 0$ is observed in K all the time; but $x' = -vt'$ observed in K' at time t' , viz. $x' + vt' = 0$. Therefore it could be viewed that x and $x' + vt'$ become zero at the same time for the point O . Then, suppose that there is a direct ratio k between x and $x' + vt'$ all the time, i.e., $x = k(x' + vt')$ ”. Because $x' + vt' = 0$ always holds, $x = 0$ holds all the time.

“Or, for point O' , $x' = k'(x - vt)$ ”. Because $x + vt = 0$ is valid all the time, $x' = 0$ always holds.

So, the coordinate in the direction of motion of the Lorentz transformation is $0=0$.

3.3 Wrong derivation of equations

3.3.1 Description of an event replacing description of another event

Equations (3) through (6) describe the point O in two coordinate systems. Equation (7) describes the positions of two photons radiated from sources fixed in these two coordinate systems at their origins respectively, not the positions of one photon. By substitution of equation (7) into equations (3) through (6), the description of an event replaces the description of another event. A substitution mistake occurs.

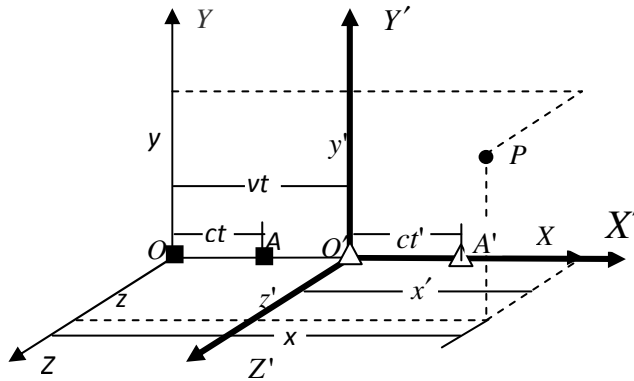

Figure 2. Coordinate system 2

Based on equation (7), in $OXYZ$ as shown in Fig. 2, a photon starts from point O at time $t=0$, and arrives at point A at time t ; in $O'X'Y'Z'$, another photon starts from point O' at time $t'=0$, and arrives at point A' at time t' . It is obvious that these are two events of two different photons. It would be clearer if these two origins do not lie at the same point, with an original displacement S at time $t=0$, as shown in Fig. 3.

Let's follow the derivation process of the Lorentz transformation.

Two coordinate systems K and K' ($OXYZ$ and $O'X'Y'Z'$), with their corresponding axes parallel to each other respectively, move uniformly relative to the other, the speed of K' is v relative to K along the X -axis. The time count starts when O' is S from O in the $+X$ direction.

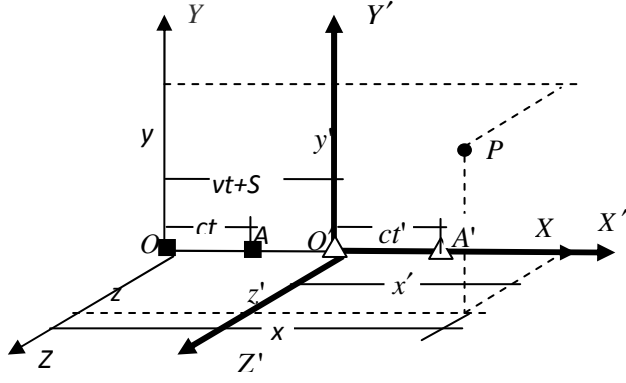

Figure 3. Coordinate system 3

For point O , $x=0$ is observed in K all the time; but $x' = -vt' - S$ is observed in K' at time t' , viz. $x'+vt'+S = 0$. Thus it can be seen that x and $x'+vt'+S$ become zero at the same time for this point. Then, suppose that there is a direct ratio between x and $x'+vt'+S$ for all the time, and let k be the proportional factor such that

$$x = k(x'+vt'+S). \quad (11)$$

Similarly for point O' , we have

$$x' = k'(x - vt - S). \quad (12)$$

From the principle of relativity, K is equal to K' . The two equations above must be of the same form. Therefore, k must be equal to k'

$$k = k'. \quad (13)$$

We further have

$$x' = k(x - vt - S). \quad (14)$$

To finish the transformation, the constant k must be given.

Absurdity 1. Based upon the principle of the constant speed of light, if a light signal goes along OX when O and O' at the same point ($t = t' = 0$), at any time t (t' in K'), the positions at these two coordinate systems are

$$x = ct, x' = ct' \quad (15)$$

respectively. It is obvious that these are two events of two sources.

Substitution of equation (15) into the product of equation (11) and equation (14) yields

$$\left. \begin{aligned} xx' &= k^2(x'+vt'+S)(x - vt - S) \\ c^2tt' &= k^2(ct'+vt'+S)(ct - vt - S) \end{aligned} \right\} \quad (16)$$

k is indeterministic.

Absurdity 2. From the principle of the constant speed of light, if a light signal goes along OX when O and O' coincide with each other ($t = t' = 0$), at any time t (t' in K'), the positions at these two coordinate systems are as follows, respectively

$$x = ct, x' = ct' - S. \quad (17)$$

It is obvious that these are two events of two sources.

Substitution of equation (17) into the product of equation (11) and equation (14) gives

$$\left. \begin{aligned} xx' &= k^2(x'+vt'+S)(x - vt - S) \\ c^2t(t'-S) &= k^2(ct'+vt'+S)(ct - vt - S) \end{aligned} \right\} \quad (18)$$

k is also indeterministic.

3.3.2 Direct transformation is not equal to indirect transformation

Suppose there are three coordinate systems K, K' and K'' ($OXYZ, O'X'Y'Z'$ and $O''X''Y''Z''$), whose respective axes are parallels to one another, move uniformly relatively to another, speed of K' is v relative to K along X -axis, speed of K'' is u relative to K' along the X -axis. The time count starts when O, O' and O'' are located at the same point.

The direct transformation from K to K'' is

$$x'' = \frac{x - (v + u)t}{\sqrt{1 - \left(\frac{v + u}{c}\right)^2}}. \quad (19)$$

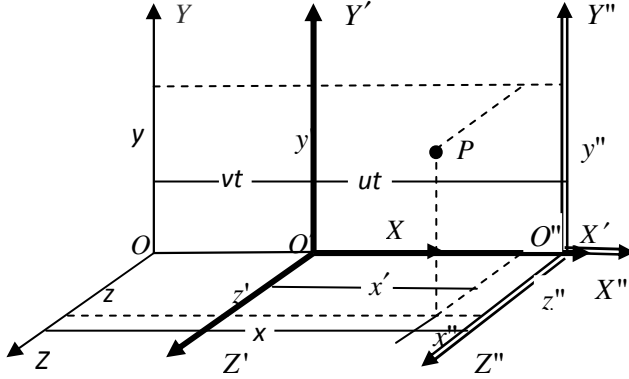

Figure 4. Coordinate system 4

The indirect transformation from K to K'' via K' is

$$x'' = \frac{x' - ut'}{\sqrt{1 - \left(\frac{u}{c}\right)^2}} = \frac{x\left(1 + \frac{uv}{c^2}\right) - (u + v)t}{\sqrt{1 - \left(\frac{u}{c}\right)^2} \sqrt{1 - \left(\frac{v}{c}\right)^2}}. \quad (20)$$

It is obvious that equation (19) is not equivalent to equation (20).

3.4 The relative speed between two objects can neither reach nor exceed the light speed

The process of the above derivations does not make the assumption that the relative speed between two objects is smaller than the light speed, but the result is that the relative speed between two objects can neither reach nor exceed the light speed. The Lorentz transformation is self-contradictory. Now, astronomy observations find that many planets move apart faster than the light speed.

3.5 There is an antinomy between the length contraction effect and the principle of relativity

The length contraction effect indicates that if a sphere is fixed in a coordinate system, this sphere observed in another coordinate system moving uniformly relatively to the system will become an ellipsoid. A direct extension to this claim is that if the relative speed equals the light speed, the sphere will become a circle, changing from 3-dimensions to 2-dimensions. Therefore, there is an antinomy between the length contraction effect and the principle of relativity.

4 Mistakes in Einstein's "On the Electrodynamics of Moving Bodies"

4.1 Excerpt from Einstein's paper¹

The following reflections are based on the principle of relativity and on the principle of the constancy of the velocity of light. These two principles we define as follows:

(1) The laws by which the states of physical systems undergo change are not affected, whether these changes of state be referred to the one or the other of two systems of co-ordinates in uniform translational motion.

(2) Any ray of light moves in the “stationary” system of coordinates with the determined velocity c , whether the ray be emitted by a stationary or by a moving body. Hence

$$\text{velocity} = \frac{\text{light path}}{\text{time interval}}.$$

We imagine further that at the two ends A and B of the rod, clocks are placed which synchronize with the clocks of the stationary system, that is to say that their indications correspond at any instant to the “time of the stationary system” at the places where they happen to be. These clocks are therefore “synchronous in the stationary system”.

We imagine further that with each clock there is a moving observer, and that these observers apply to both clocks the criterion established for the synchronization of two clocks. Let a ray of light depart from A at the time t_A , let it be reflected at B at the time t_B , and reach A again at the time t'_A .

Taking into consideration the principle of the constancy of the velocity of light we find that

$$t_B - t_A = \frac{r_{AB}}{c - v} \quad \text{and} \quad t'_A - t_B = \frac{r_{AB}}{c + v}, \quad (21)$$

where r_{AB} denotes the length of the moving rod—measured in the stationary system. Observers moving with the moving rod would thus find that the two clocks were not synchronous, while observers in the stationary system would declare the clocks to be synchronous.

Let us in “stationary” space take two systems of co-ordinates, i.e. two systems, each of three rigid material lines, perpendicular to one another, and issuing from a point. Let the axes of X of the two systems coincide, and their axes of Y and Z respectively be parallel. Let each system be provided with a rigid measuring-rod and a number of clocks, and let the two measuring-rods, and likewise all the clocks of the two systems, be in all respects alike.

Now to the origin of one of the two systems (k) let a constant velocity v be imparted in the direction of the increasing x of the other stationary system (K), and let this velocity be communicated to the axes of the co-ordinates, the relevant measuring-rod, and the clocks. To any time of the stationary system K there then will correspond a definite position of the axes of the moving system, and from reasons of symmetry we are entitled to assume that the motion of k may be such that the axes of the moving system are at the time t (this “ t ” always denotes a time of the stationary system) parallel to the axes of the stationary system.

We now imagine space to be measured from the stationary system K by means of the stationary measuring-rod, and also from the moving system k by means of the measuring-rod moving with it; and that we thus obtain the co-ordinates x, y, z , and ξ, η, ζ , respectively. Further, let the time t of the stationary system be determined for all points thereof at which there are clocks by means of light signals in the manner indicated before; similarly let the time τ of the moving system be determined for all points of the moving system at which there are clocks at rest relatively to that system by applying the method, given before, of light signals between the points at which the latter clocks are located.

To any system of values x, y, z, t , which completely defines the place and time of an event in the stationary system, there belongs a system of values ξ, η, ζ, τ , determining that event relatively to the system k , and our task is now to find the system of equations connecting these quantities.

In the first place it is clear that the equations must be linear on account of the properties of homogeneity which we attribute to space and time.

If we place $x' = x - vt$, it is clear that a point at rest in the system k must have a system of values x', y, z , independent of time. We first define τ as a function of x', y, z , and t . To do this we have to express in equations that τ is nothing else than the summary of the data of clocks at rest in system k , which have been synchronized according to the rule given before.

From the origin of system k let a ray be emitted at the time τ_0 along the X-axis to x' , and at the time τ_1 be reflected thence to the origin of the coordinate, arriving there at the time τ_2 ; we then must have

$$\frac{1}{2}(\tau_0 + \tau_2) = \tau_1. \quad (22)$$

by inserting the arguments of the function τ and applying the principle of the constancy of the velocity of light in the stationary system:

$$\frac{1}{2} \left[\tau(0, 0, 0, t) + \tau\left(0, 0, 0, t + \frac{x'}{c-v} + \frac{x'}{c+v}\right) \right] = \tau\left(x', 0, 0, t + \frac{x'}{c-v}\right) \quad (23)$$

Hence, if x' be chosen infinitesimally small,

$$\frac{1}{2} \left(\frac{1}{c-v} + \frac{1}{c+v} \right) \frac{\partial \tau}{\partial t} = \frac{\partial \tau}{\partial x'} + \frac{1}{c-v} \frac{\partial \tau}{\partial t}. \quad (24)$$

or

$$\frac{\partial \tau}{\partial x'} + \frac{v}{c^2 - v^2} \frac{\partial \tau}{\partial t} = 0. \quad (25)$$

With the help of this result we easily determine the quantities ξ, η, ζ , by expressing in equations that light (as required by the principle of the constancy of the velocity of light, in combination with the principle of relativity) is also propagated with velocity c when measured in the moving system.

We now have to prove that any ray of light, measured in the moving system, is propagated with the velocity c , if, as we have assumed, this is the case in the stationary system; for we have not as yet furnished the proof that the principle of the constancy of the velocity of light is compatible with the principle of relativity.

4.2 Mistakes

(1) Equation (21) is derived from the assumption that “Any ray of light moves in the stationary system of co-ordinates with the determined velocity c , whether it is emitted by a stationary or by a moving body”. In fact, the light seen by us is emitted by the body observed by us, no matter whether this body is moving or not, and the light speed is c relative to the body. So, Eq. (21) is just a hypothetical phenomenon that does not exist in the world. The fact is that observers moving with the moving rod and observers in the stationary system will find

that the two clocks are synchronous. For further theories of moving objects observation, see ref. 26.

(2) It is evident that if equation (21) is true (equation (21) is false in fact), then equation (22) will be false. But the author continued to substitute equation (21) into equation (22). As a consequence, equation (23) is incorrect.

(3) There is a mistake from equation (23) to equation (24). From equation (23), there is

$$\begin{aligned} & \frac{1}{2} \frac{\partial \tau}{\partial(t + \frac{x'}{c-v} + \frac{x'}{c+v})} (\frac{\partial t}{\partial x'} + \frac{1}{c-v} + \frac{1}{c+v}) \\ & + \frac{1}{2} \frac{\partial \tau}{\partial t} \frac{\partial t}{\partial x'} = \frac{\partial \tau}{\partial x'} + \frac{\partial \tau}{\partial(t + \frac{x'}{c-v})} (\frac{\partial t}{\partial x'} + \frac{1}{c-v}) \end{aligned} \quad (26)$$

Because $x' = x - vt$,

$$\frac{\partial \tau}{\partial(t + \frac{x'}{c-v} + \frac{x'}{c+v})} \neq \frac{\partial \tau}{\partial t} \quad \text{and} \quad \frac{\partial \tau}{\partial(t + \frac{x'}{c-v})} \neq \frac{\partial \tau}{\partial t},$$

then

$$\frac{1}{2} (\frac{1}{c-v} + \frac{1}{c+v}) \frac{\partial \tau}{\partial t} \neq \frac{\partial \tau}{\partial x'} + \frac{1}{c-v} \frac{\partial \tau}{\partial t}. \quad (27)$$

(4) For a definite ray, it is first defined that the ray moves with velocity c relative to the stationary system; then, it is also defined that the ray moves with velocity c relative to the moving system. This is an evident mistake.

(5) In equations (21), (23) and (24), the velocity between bodies and photons $c + v$ exceeds the light velocity c . This conflicts with the main claim of Special Relativity.

(6) "If we place $x' = x - vt$, it is clear that a point at rest in the system k must have a system of values x', y, z , independent of time". Here, first, let $x' = x - vt$, then let x' be independent of t . This is a conflict.

(7) First assuming $x' = x - vt$, and then the result is $\xi = \frac{x - vt}{\sqrt{1 - (\frac{v}{c})^2}}$. $\xi = x'$. This is also a

conflict.

Einstein's paper "On the Electrodynamics of Moving Bodies" is full of mistakes and conflicts.

5 Correct Transformation²⁶

5.1 Re-establishment of transformations

To finish the transformation, the constant k must be determined. Based upon the experimental result of the constant speed of light, if a light signal goes along OX when O

and O' are at the same point ($t=t'=0$), at any time t (t' in K'), the positions at these two coordinate systems are as follows respectively

$$x = ct, x' = ct' - vt' . \quad (28)$$

Substitution of equation (28) into the product of equation (3) and equation (6) yields

$$k = 1 . \quad (29)$$

Substitution of equation (29) into (3) and (4) yields

$$\left. \begin{aligned} x &= x' + vt' \\ x' &= x - vt \\ t &= t' \end{aligned} \right\} . \quad (30)$$

This is the classic Galilean transformation. There is no light speed in it.

5.2 Equation (28) accords with experimental result of the constant speed of light

As shown in Fig. 2, if a photon emitted from a source fixed at O of $OXYZ$ system moves from O at time $t=0$, arrives at A at time t , then its relative speed to O (or source) in $OXYZ$ is $\frac{\overline{OA}}{t} = \frac{x}{t} = \frac{ct}{t} = c$; and its relative speed to O' in $O'X'Y'Z'$ is $\frac{\overline{O'A}}{t'} = \frac{x'(A)}{t'} = \frac{ct' - vt'}{t'} = c - v$; and the measured speed of this photon relative to its source in $O'X'Y'Z'$ is $\frac{\overline{OA}}{t'} = \frac{x'(A) - x'(O)}{t'} = \frac{(ct' - vt') - (-vt')}{t'} = c$. For a specific photon, its relative speeds to different systems are varied; its relative speeds to its source measured in different systems are the same.

5.3 Deductions

Special Relativity based upon the Lorentz transformation is not correct. As the key components of Special Relativity, the simultaneity effect, length contraction effect, time dilation effect, mass increasing effect and the question of rest energy are all groundless. The relative speed between two objects can exceed the light speed.

6. Conclusions

(1) Special Relativity is derived from a misunderstanding of experimental results involving the constant speed of light.

(2) Special Relativity based upon the Lorentz transformation is not correct.

(3) Descriptions of a definite event in all inertial coordinate systems moving uniformly relatively to another are equal.

(4) The relative speed between two objects can exceed the light speed.

(5) Einstein's paper "On the Electrodynamics of Moving Bodies" is full of mistakes and conflicts.

Acknowledgments

The author gratefully acknowledges Dr. Thomas Smid for discussions.

Li Zifeng is a professor of Yanshan University, China, Technical Editor of SPE Drilling & Completion. Before joining Yanshan University, he was a professor of Daqing Petroleum Institute and then a professor of China University of Geosciences. He has published 100 papers and 4 books on drill string, casing, rod pumping mechanics & well bore stability. He

holds a BS degree in drilling engineering and an MS degree in machinery engineering from Daqing Petroleum Institute and a Ph.D. degree in petroleum development engineering from China University of Petroleum.

References

1. A. Einstein. On the Electrodynamics of Moving Bodies. *The Principle of Relativity*, Methuen and Company Ltd. of London, 1923.
2. Cheng Shuozhu, Jiang Zhiyong. *General physics*. Beijing: People's Education Press, 1978: 231-254. (In Chinese)
3. Kelly A. Special Relativity - Right or Wrong?[J].*Electronics World*, 2000, 106 (1773): 722-723.
4. Yin Z. Investigation of specialrelativity and an alternative explanation of the speed of light [J].*Physics Essays*, 2002, 15(4): 363-370.
5. Bitsakis E. Space and Time: The Ongoing Quest[J].*Foundations of Physics*, 2005, 35 (1): 57-83.
6. G. O. Mueller, Karl Kneckebradt. 95 Years of Criticism of the Special Theory of Relativity (1908-2003)[R]. Germany, 2006.
7. Will CM. Was Einstein Right?[J].*Annalen der Physik*, 2006, 15 (1-2): 19-33.
8. Varcoe BTH. Testing Special Relativity Using Slow Light [J].*Contemporary Physics*, 2006, 47 (1): 25-32.
9. Xu Shaozhi. The Mathematic Basis of Relativity is Wrong. *Invention and Innovation*, 2001, (1):32-33. (In Chinese)
10. Xu Shaozhi. To Look at Scientific Platform, New Events Happen in China. *Invention and Innovation*, 2001, (2): 34-35. (In Chinese)
11. Xu Shaozhi. Misunderstandings on Mass-Energy Relations. *Invention and Innovation*, 2002, (2):32. (In Chinese)
12. Xu Shaozhi, Xiang Qun. Generalized Relativity Is So Different From Science. *Invention and Innovation*, 2002, (3): 30-31. (In Chinese)
13. Xu Runsheng. SR Goes Against Factuality Principles. *Invention and Innovation*, 2002, (10):32. (In Chinese)
14. Zhu Jidong. Discussing the Fundament of the Experiment about Special Relativity. *Journal of Shanghai University of Electric Power*, 2003, 19(3):57-60. (In Chinese)
15. Cui Jidong. On China's Own Innovation Way -Impressions of Reading "Rethought on Relativity". *Invention and Innovation*, 2003, (3):34. (In Chinese)
16. Lei Yuanxing. Criticizing Voice on Relativity is Worth Analyzing in Two Ways-The First Impression of "Rethought on Relativity". *Invention and Innovation*, 2003, (3):37. (In Chinese)
17. Huang Zhixun. Theoretical Development and Experimental Examinations in Special Relativity. *Engineering Science*, 2003, 5(5):8-12. (In Chinese)
18. Liu Dayi. A Debate between Relativity and the Concept of Classics' Space-Time & Matter. *Invention and Innovation*, 2003, (9):36. (In Chinese)
19. Xiang Qun. Do Away with Superstitious and Read Relativity Cautiously. *Invention and Innovation*, 2003, (10):36. (In Chinese)
20. Liu Dayi. Making Zero Divisor Is a Math's Mistake. *Invention and Innovation*, 2003, (10):37. (In Chinese)
21. Huang Demin. *On the Essence of Physical phenomenon -Matter Effect Study Challenges*

- Relativity*. Shanxi Science and Technology Publishing House, 2001. (In Chinese)
22. Song Zhenghai, Fan Dajie, Xu Shaozhi, Hao Jianyu. *Rethinking on Relativity*. Earthquake Publishing House, 2001. (In Chinese)
 23. Qi Ji. *New Physics*. Publishing House of Northeast Forestry University, 2003. (In Chinese)
 24. Li Zifeng, Li Tianjiang, Wang Changjin, Wang Zhaoyun, Tian Xinmin. The Essence of Special Relativity and Its Influence on Science, Philosophy & Society[J]. *Scientific Inquiry*, 2007, 8(2): 229-236.
 25. Li Zifeng, Wang Zhaoyun. Materialistic Views of Space-time and Mass-energy [J]. *Scientific Inquiry*, 2007, 8(2): 237-241.
 26. Li Zifeng. Moving Objects Observation Theory in Place of Special Relativity [J]. *Scientific Inquiry*, 2007, 8(2): 242-249.
 27. Li Zifeng, Tian Xinmin. Magic Weapons for Supporting Relativity[J]. *Scientific Inquiry*, 2007, 8(2): 250-255.
 28. Li Zifeng. The Essential Relationship Between Mass and Energy[J]. *Scientific Inquiry*, 2007, 8(2): 256-262.

Problems with the Special theory of Relativity

Li Wen-Xiu

Department of Earth and Space Sciences

University of Science and Technology of China

wxl@ustc.edu.cn

Abstract: This paper presents problems with the special theory of relativity (STR), including: (1) The principle of relativity as interpreted by Einstein conflicts with the uniqueness of the universe. (2) The light principle conflicts with the notion that natural phenomena depend only upon mutual interaction and the involved relative motion. The principle contains a tacit assumption that leads to self-contradiction. (3) The Lorentz transformation(LT) is based, not upon the so-called light principle, but rather upon a general time-space dependence, and lacks a proof of necessity and uniqueness. (4) The LT contradicts its premises, holding for no observer. (5) The Lorentz contraction is shown untenable in practice. (6) The prediction of time dilation is only a special case of a general result that is self-contradictory.

Keywords: Special Relativity, principle of relativity, light principle, Lorentz transformation, Lorentz contraction, time dilation.

1 Introduction

There is no doubt that the physical Universe is the only object of study of physics. The basic view of the world, underlying all physical theories and justified by history of physics, is the doctrine that the world is made up of objects whose existence is independent of human consciousness. The objectivity, reality, and uniqueness of the universe are therefore the initial premises of natural sciences. Based on this view, the phenomena of nature, which ultimately depend only upon interaction between matter and relative motion thereof, can simultaneously and equally be described by means of any single coordinate system; *i.e.*, nothing in the Universe can be changed by the employment of a coordinate system.

Consider, for example, a stone dropped, but not thrown, to the embankment by Einstein standing at a window of a railway carriage, which is traveling uniformly with respect to the embankment. With respect to the embankment, the railway carriage, or any other body in the Universe, the stone traverses an absolutely definite, independent trajectory. Clearly, the phrase ‘the motion of the stone’ has no definite meaning without the reference body being specified. Given a single specified coordinate system, all motions of all bodies in the Universe with respect to this frame, and with respect to one another, can be described simultaneously by means of this frame. Whatever coordinate system is employed, the trajectory traced by Einstein’s stone with respect to the ground is a parabola, while that with respect to the carriage is a straight line.

It is incorrect to consider a coordinate system as able to describe only motions of bodies

with respect to itself. It is even more fallacious to regard a coordinate transformation as a reference-body switch of relative motions[1]. When the coordinate system rigidly attached to the ground is employed, the carriage is still there, and the motion of the stone with respect to it cannot be destroyed or altered by the employment of that frame. Everybody knows how to figure out the trajectory of this motion by using this system, just as well as by using the system rigidly attached to the carriage. It is only because the stone is in an absolutely definite, independent motion with respect to every other body in the Universe that we can simultaneously compare them and find them different from each other, whereby we obtain the knowledge that motion is relative.

It is therefore not right to interpret the relativity of motion only as: 'viewed from the embankment' the stone is in a parabola motion, while 'viewed from the carriage' it is in a straight line motion. The phrase 'viewed from the embankment' is ambiguous. It is unlucky for physics that such phraseology has come into use in published articles. Although it means here 'with respect to the embankment', one often fails to know what it means; say, "viewed from the coordinate system S'", in S the laws of electrodynamics are in the form of Maxwell's equation, whereas in S', they are not. This kind of phraseology also makes the coordinate system now subject, then object, depending on one's requirement.

One should also know that not only "viewed from the embankment" the stone is in straight line motion with respect to the carriage, but also "viewed from anywhere", the stone is in straight line motion relative to the carriage too, as well as in parabolic motion relative to the embankment. The two relative motions are really both *absolute*, here meaning that either of them has already contained within it the consequence of all physical effects exerted upon it, *and cannot still be anything different depending on viewpoint*.

In accord with the special theory of relativity (STR), 'relativity' means that one and the same thing is different according to different definitions (the phrase 'when viewed from different inertial observers' is here equivalent to 'according to different definitions'[3]). The relativity of lengths, masses, and times, all refer to one and the same body or one and the same pair of clocks, as clearly stated by Miller [2]:

"There were no such notions as the true time or the true length of an object; rather these were relative concepts: For example, the length of the rod was either r_{AB} , depending upon the rod's motion relative to an inertial observer".

Surely, Miller is correct only 'when viewed from STR'. According to STR, there were also no such notions as the true length contraction or the true time dilation; rather these were relative effects: for example, the length of the rod was contracted by either the factor α or the factor β , depending upon the rod's speed relative to an inertial observer. All the experiments that have been claimed to confirm STR turn out to confirm at most these untrue effects. Even the two postulates set forth by Einstein are untrue 'when viewed in any coordinate system whatsoever'[3].

When we delve into how Miller obtained such conclusions, we find all these conclusions self-contradictory. When we, as observers not standing on Olympus, measure the length of the rod to be L , we are unable simultaneously to know and believe that other observers in motion relative to us should regard it as shorter than L . How can we come to such a conclusion? All we can do is use our standards of length and time to measure all bodies and all time intervals, and we must thereby find that during two events every object in the Universe, moving or not with respect to us, must age the amount equal to the interval of the two events, independent of the reading of the clock traveling with it. It is not allowed by STR for us, on the one hand, to measure the interval of the two events with our own standard of time, and, on the other hand, to measure the aging of the object with the readings of the clock which is traveling with the object and which, according to STR, we do not think keeps the correct time, in order that we can agree that the object, if moving relatively to us, ages less than the interval of the two events.

It is perhaps necessary to point out here that Einstein's defining the reading of a clock as time is no less absurd than defining the reading of a speedometer as speed, the reading of a log as distance, the reading of a counter as number, the reading of a potentiometer as electric potential. A clock is nothing but a measuring instrument. If no quantity precedes, no measuring instrument is necessary, without mentioning the fact that no one can design an instrument for measuring the unknown quantity, still less can one know the measuring precision and the stability of the instrument. Therefore time and the unit of time must both be well defined before any clock or watch comes into use.

1. The Principle of Relativity

The so-called principle of relativity, which, as quoted by Rindler [4], reads in Einstein's own words as: "All inertial frames are totally equivalent for the performance of all physical experiments", and which is said to be evolved from the 'fact' that in a ship "all motions and all mechanics happen in the same way whether the ship is at rest or is moving uniformly".[4] This cannot be regarded as an important law of nature, since, considering the fact that there is only one Universe while there are an infinite number of inertial coordinate systems, there is no case such that in every inertial coordinate system there is an identical physical system at rest and under otherwise exactly the same conditions.

In fact, the ship is never moving uniformly with respect to Earth. When the ship is said to move uniformly, it is actually at rest in the coordinate system of which the origin is located at the center of Earth, and which is rotating with respect to the Earth around the axis through its origin and perpendicular to the alleged velocity of the ship, with the angular velocity $\omega=v/R$, where v is the alleged speed of the ship, R the radius of the Earth. Especially when v is large enough, all motions and all mechanics will not happen in the same way as when the ship is at

rest. Besides, granted that the ship is moving uniformly, it is not the ship, but rather a uniformly moving flatcar, that can be regarded as an inertial coordinate system. One cannot see what is seen in the ship when he is on the flatcar. The reason is very simple: there is only one atmosphere that cannot be in the same state of motion relative to the Earth as relative to the flatcar.

It is to be emphasized that the Einsteinian relativity is essentially different from the Galilean relativity, which says that all inertial coordinate systems are totally equivalent for the description of the Universe.

2 The Light Principle

It is well known that the LT is set up on the two postulates put forward by Einstein [5] in 1905. The so-called principle of the constancy of light speed reads, in Einstein's own words, "Any ray of light moves in the 'stationary' system of coordinates with the determined velocity c , whether the ray be emitted by a stationary or by a moving body".

What is concerned with and meaningful is only the speed of light relative to its receiver, which is obviously independent of reference frames, and of which the principle should completely be stated, namely, the light emitting body and the light receiver should both be involved in the principle, since both of them are generally in motion in the 'stationary' system of coordinates. However, the light principle does not refer to light receiver at all, violating completely the mutuality of motion between emitting body and receiver. This, together with the tacit assumption mentioned below, make the speed of light with respect to the light receiver from the outset observer dependent [3]. This is the root of why simultaneity is relative.

Even in accordance with Einstein's understanding of this principle, as shown first in defining time and then in deriving the LT, the principle should strictly and completely be stated as follows: The speed of light with respect to every inertial coordinate system, only when measured by stationary observers of that system according to their own stationary clocks synchronized by using light signals in accordance with the synchronization definition that is made based upon this now being stated principle which postulates that the speed of ... (repeating exactly the same statement endlessly).

This endless statement is the root of the circular demonstration present in STR, making STR from the outset untenable. The reason for the statement being endless lies in the fact that the principle, in itself through the definition of velocity, already contains time, which is in turn to be re-defined based upon this principle; *i.e.*, that the principle is not qualified to be a principle, unless time is previously otherwise defined [6].

Einstein's argumentation of the relativity of simultaneity involves a tacit assumption which reads: when an observer A at rest in an inertial coordinate system receives a ray of light at time t , the observer B who is in motion relative to A, and happens to be adjacent to A, can also receive this ray of light. It is based upon this tacit assumption that Einstein uses $c-v$ and

$c+v$ in demonstrating the relativity of time, although his usage is still illegal in terms of STR [7]. This assumption has been shown untenable [1,8], and now we shall further show that it may lead to absurd conclusions.

Suppose the coordinate system K' is in uniform motion relative to the coordinate system K in the x -direction with speed v , with the axes of x of the two system coinciding. Now let a ray of light be emitted at time $t=t'=0$ when the origins of the two systems coincide, from the instant common origin, in the direction of the instant common y -axes. According to the light principle, in either coordinate system the ray of light is propagated only along the y -axis; *i.e.*, only the observers at rest on y -axis can receive the ray of light. However, since the y' -axis is moving relatively to the y -axis, when an observer at rest on y' -axis receives the ray of light, there must be some observer who is at rest in system K but not on the y -axis runs into him and, according to the tacit assumption, receives the ray of light too. This leads to the absurd conclusion that, in system K , not only the observers located on the y -axis, but all observers located above the x -axis, can receive the ray of light since v can take any value from $-\infty$ to $+\infty$, and *vice versa* in system K' .

3 Derivation of the LT

In physics, in fact, the only bases underlying all physical equations is the unquestionable fact that a thing is always identical with itself. In other words, both sides of every equation always stand for one and the same quantity. This has already been, and will forever be, the unique basis for us to establish physical equations, the coordinate transformation equations being no exception.

Suppose there are two bodies, A and B, if we want to express the position of A with respect to B, we need, first of all, to establish a Cartesian coordinate system, K , rigidly attached to B and with B at the origin, then measure the three coordinates, x , y , and z of A to obtain the position of A relative to B,

$$\vec{r} = x\hat{i} + y\hat{j} \quad (1)$$

Now for some reason we need to express this very relative position in terms of a coordinate system, K' , which is in uniform motion with velocity v with respect to B. Let the position of A with respect to K' at time t be

$$\vec{r}'_A = x'_A\hat{i}' + y'_A\hat{j}' + \quad (2)$$

Since the position of B with respect to K' is

$$\vec{r}'_B = -v\hat{i}'t \quad (3)$$

The position of A with respect to B is therefore

$$\vec{r} = \vec{r}'_A - \vec{r}'_B = \vec{r}'_A + \vec{v}t = (x' + v_x t)\hat{i} + (y' + v_y t)\hat{j} + (z' + v_z t)\hat{k} \quad (4)$$

It is the fact that Eqs. (1) and (4) are one and the same position of A with respect to B that gives the Galilean transformation (GT) equations

$$x = x' + v_x t, y = y' + v_y t, z = z' + v_z t \quad (5)$$

With the proof of the uniqueness and necessity of these equations absolutely unnecessary. Moreover, we have no choice but to accept all features of these equations. In other words, not before, but only after these equations have been so soundly obtained can we know and believe all their properties to be true.

By contrast, the derivation of the LT is completely groundless. Einstein and others, such as Bergmann [9] and Rindler [10], made no proof of the uniqueness and necessity of the LT equations either before or after the derivation of the LT. Moreover, their derivations are full of fictitious assumptions, such as the *linear* dependence of t' , not only on t , but also on x , y , and z , and the properties of homogeneity of space and time (in fact, these assumptions are not only *petitio principii*, but also in conflict with the conclusions resulting from the LT based on them. For example, ‘viewed from either of the two coordinate systems in uniform relative motion’ clocks in the other system placed along the y - or z -axis are synchronized with each other, whereas those placed along the x -axis are not; namely, time is not homogeneous and for a similar reason neither is space).

The LT is said to be derived from Einstein’s two formal postulates that are mathematically expressed as

$$x^2 + y^2 + z^2 - c^2 t^2 \equiv 0, \quad x'^2 + y'^2 + z'^2 - c^2 t'^2 \equiv 0 \quad (6)$$

It is explicit that t and t' are both arbitrary *constants*, not independent variables in the same sense as x , y , and z , namely that only when they are both given are the two equations both spherical equations; nevertheless, they are treated, in deriving the LT, as independent variables, on completely equal footing with x , y , and z , since Einstein substitutes x , y , z , t , contained in Eq. (6) for the spacial coordinates x , y , z , and the time t of an *arbitrary event*. Clearly, this treatment not only makes space and time interrelated, as definitely shown by the LT, but also makes Eq. (6) no more or less than the time-space dependence, which is obviously absurd.

Without any proof of the uniqueness of the LT, Rindler alleged, after his derivation of the LT, “if there is a transformation satisfying the requirements of SR, then it must be (the LT)”. Rindler’s allegation has been shown outright untenable by Xu Shaozhi and Xu Xiangqun [7].

What is even more seriously shown by Xu Shaozhi and Xu Xiangqun is that the LT is actually not based upon Einstein’s two postulates as expressed by Eq.(6) but upon the

following equation

$$x^2 + y^2 + z^2 - c^2t^2 \equiv F, x'^2 + y'^2 + z'^2 - c^2t'^2 \equiv F \quad (7)$$

With t and t' being independent variables on completely equal footing with x , y , and z , which is now absolutely in conflict with the light principle, being really an interrelation of time and space. This fact not only implies that the LT is not based on Eq. (6), much less on Einstein's two postulates, but reveals how space and time have already been from the outset interrelated as well.

4 Premises of the LT

Besides what is exposed above, the other premises of the LT are obviously as follows: First, each coordinate system is equipped with a rigid measuring rod and a number of clocks, each measuring rod and all clocks being 'in all respects alike'. Second, the clocks fixed at different points of each system are synchronized with each other.

On reflection, we find that we do not know to whom we are saying these premises; i.e., for whom these premises hold good. According to the STR, even we ourselves do not accept them as valid, if we are not really on Olympus. An observer at rest in S would find the clocks in S' not synchronized to one another, the two measuring-rods and the clocks in S and S' in no respects alike, and vice versa. Therefore, no observer in either system can derive the LT, much less can they accept it as correct. Although the observers in either system do not accept the LT, it is very strange that when we use the LT (granted that we are entitled to use it) to get from the space-time coordinates of an event relative to S to the new space-time coordinates of that event relative to S' for the observers in S' , the observers in S' have to regard the new space-time coordinates not only as true but also as measured by themselves. We know of no other place in physics where there exists such a peremptory logic. Observers are no more or less than puppets when viewed from Einstein. We wish we were not observers.

5 Lorentz Contraction

The following experiment indicates the impossibility of the Lorentz contraction.

Turn a railway carriage upside down so that its front and rear wheels can turn freely. Join the two wheels with a rigid rod by means of two eccentric axles fixed respectively on the edges of the two wheels. Practice tells us that only when the length of the rod is equal to the distance between the two central axles of the two wheels can the two wheels still turn freely. We now suppose the rod is equal to the distance, and these wheels are turned swiftly; the rod is thus in motion with respect to the carriage, suffering the Lorentz contraction 'when viewed in the coordinate system attached rigidly to the carriage'. Since the two central axles are rigidly fixed on the carriage, the distance between them does not suffer such an effect. The rod is therefore shorter than the distance between the two central axles, whence it follows that these wheels cannot be turned. This conclusion is obviously out of accord with the fact that these wheels are turning.

It is to be noted that, in accordance with STR, Lorentz contraction means that the length of a rod, under any conditions whatsoever, at any instant, is simultaneously different ‘viewed from different inertial observers’, not that the rod has different lengths at different times or in different situations. The length of a rod is always the consequence of all known and unknown effects acted on it by all objects present in the Universe. Even granted that there is an ether, the notion that, in the ether, when a rod is moving with speed v parallel to its length, its length is shorter compared to its resting length, has nothing to do with the Lorentz contraction.

6 Time Dilation

Immediately after his discussion of length contraction, Einstein made another prediction. He argued as follows:

“We imagine one of the clocks which are qualified to make the time t when at rest relatively to the stationary system (the system S in this paper), and the time τ (t' in this paper) when at rest relatively to the moving system (S' in this paper), to be located at the origin of the coordinates of (S'), and so adjusted that it marks the time τ . What is the rate of this clock, when viewed from the stationary system?”

“Between the quantities x and x' , which refer to the position of the clock, we have, evidently, $x = vt$ and

$$\tau = (t - vx/c^2)/\sqrt{1 - v^2/c^2}$$

Therefore,

$$\tau = t\sqrt{1 - v^2/c^2} = t - \left(1 - \sqrt{1 - v^2/c^2}\right)t$$

Whence it follows that the time marked by the clock (viewed in the stationary system) is

slow by $1 - \sqrt{1 - v^2/c^2}$ seconds per second, or neglecting magnitudes of fourth and

higher order, by $v^2/2c^2$.”

The late Herbert Dingle made a reasonable objection to Einstein’s conclusion. He made a parallel passage, leading to the opposite conclusion [11, 12, 13]:

$$t = \tau\sqrt{1 - v^2/c^2} = \tau - \left(1 - \sqrt{1 - v^2/c^2}\right)\tau$$

Which shows that the moving clock is fast by $1 - \sqrt{1 - v^2/c^2}$ seconds per second, being in

conflict with Einstein's conclusion.

In order to show Einstein's conclusion being untenable, we should first ascertain what he meant by the phrase 'viewed in the stationary system'. In STR, this kind of phraseology appears in every conclusion, and has different meanings in different conclusions, really being an *elixir* playing the role of confusing reader's mind. Here it may be in the place of the phrase 'compared to the stationary clock'.

It is common sense that whenever one compares two things, there always exist two exactly equivalent statements of the result. Take, for example, the comparison of the two clocks, A and B. If one finds the clock A to be m seconds per second slower than B, one will claim that the clock B is m seconds per second faster than A. In other words, 'compared to B the clock A runs slow' is exactly equivalent to 'compared to A the clock B runs fast'. Besides,

the relation $\tau = t\sqrt{1 - v^2/c^2} = t - (1 - \sqrt{1 - v^2/c^2})t$ is nothing but the equation

connecting the interval τ , 'viewed from the moving system', of the two events occurring respectively at $\tau = 0$ and $\tau = \tau$, and the interval t , 'viewed from the stationary system', of the same two events. Why is it 'viewed in the stationary system' but not 'viewed in the moving system' that is to be added to the relation? Is science language games?

Therefore, Einstein's conclusion is exactly equivalent to the assertion that the stationary clock is fast by the same amount compared to the moving clock which, as shown by Dingle, should be faster than the stationary clock. This is what is shown by Dingle to be the inconsistency of the theory.

For refutation of Dingle's objection, Max Born [14] and McCrea [15] made an argument to the effect that Einstein's conclusion results from the comparison of the proper time interval of the moving clock to the stationary non-proper time interval, whereas Dingle's results from the comparison of the stationary proper time interval to the moving non-proper time interval. The two conclusions therefore 'refer to different physical situations'; t and τ have not the same meaning in the two expressions. Dingle's conclusion is therefore not in conflict with Einstein's conclusion.

What a strange explanation. We now fail to know how many different meanings the time t (or τ) has. This is the first time we have heard that physical situation can alter the nature of time. And we also fail to know why, neither Max Born nor McCrea explains whether there is any relation between a proper time interval and its corresponding non-proper time interval of the same coordinate system. As known, since clocks are all synchronized, there must be a certain relation between the two intervals. As long as such relation exists, whatsoever it may be, Dingle's objection must hold good.

The following demonstration may be necessary for further refuting Max Born's argument and similar ones. Between the two times t and τ , there is a general relation that can be drawn from the LT, and of which both Einstein's and Dingle's conclusions are merely special cases. Let us assume that at the time $t = 0$, a mass point M that is moving with constant speed u in the x-direction, passes through the origin of S, which coincides at that moment with the origin of S', and at S-time t arrives at $x = ut$. According to Einstein's logic exactly, between the quantities x , t , and τ , which refer to the position of M, we have evidently, $x = ut$ and $\tau = (t - vx/c^2)/\sqrt{1 - v^2/c^2}$. Therefore, $\tau = \gamma(1 - vu/c^2)t$, where γ is the Lorentz factor, whence it follows that the time marked by the clock of S' (viewed in the stationary system S) is slow by $1 - \gamma(1 - vu/c^2)$ seconds per second when $\gamma(1 - vu/c^2) < 1$, fast by $\gamma(1 - vu/c^2) - 1$ seconds per second when $\gamma(1 - vu/c^2) > 1$.

Clearly, this result reduces to Einstein's conclusion when $u = v$, and to Dingle's when $u = 0$. Nothing shows that the two conclusions refer to different physical situations in which t and τ have not the same meaning. This general result is now the comparison of the two non-proper time intervals between the same two events. What in this theory can make now one, and then the other, the greater one?

Max Born's argument means that, in the stationary system, although all clocks fixed at different places are synchronized with each other, the non-proper time interval t has no relation to any proper time interval of the clock at rest at $x = 0$, namely, this clock has no reading corresponding to t , or in other words, that one cannot use any proper time interval of the clock at $x = 0$ to calculate the position of the moving clock, namely, if we let Δt stand for the proper time interval of the clock at $x = 0$, whatever Δt may be, $v\Delta t \neq vt$. If really so, we would fail to understand as to what Einstein meant by "the property of homogeneity which we refer to time", and the theory would completely be meaningless, because it makes us unable to determine even the position and velocity of the moon relative to the earth, since it is impossible for us to place clocks at different points on the orbit of the moon. If not, however,

no matter what the relation between Δt and t may be, Dingle's objection is valid.

In fact, the equality of Δt to t has been used by all authors, including Einstein himself (Einstein clearly knows that a theory which even fails to give the relation between Δt and t cannot be regarded as a good theory). The strong evidence is that in the quoted paper Einstein simultaneously uses both proper time interval and non-proper time interval to express the same velocity of light c , namely, $2AB/(t'_A - t'_B) = c$, using the proper time interval, $AB/(t_B - t_A) = c$, using the non-proper time interval. This completely means that the two time-intervals have the same meaning. We are surprised that those physicists claiming to be of integrity should be regardless of these facts when they explain away Dingle's objection.

7 Concluding Remarks

Every problem presented above is fatal to STR. This determines that STR must suffer acute refutation. We know that the STR is *per se* an observer-dependent theory. But this does not mean that we should start from this viewpoint to disprove this viewpoint, and are considered to be wrong when we demonstrate and assert something really independent of observers. First to ascertain why it is observer-dependent, and then point out where and how it goes wrong by demonstrating how and why it is really independent of observers, is a valid way to disprove this theory.

It is surprising that, although some authors confess that STR is inconsistent, they hold the doctrine that Einstein was so fortunate that he frequently came to the right conclusions by using false reasoning, and claim that all relativistic paradoxes of length contraction of rods, *etc.*, have been resolved through absolute space and time physics, derived from the Galilei covariant Maxwell equations. Clearly, according to the above analysis, these authors' claim shows only that their 'theory' is no better than STR.

References

- [1] Wen-xiu Li, "Is Galilean Relativity Really Incompatible With Maxwell's Equations?", *Physics Essays* 7, 255-260(1994).
- [2] A. I. Miller, *Albert Einstein's Special Theory of Relativity*, p. 205(Addison-Wesley, Boston, 1981).
- [3] Wen-Xiu Li, "On the Relativity of Length and Times", *Apeiron* 2, 16-19(1995).
- [4] W. Rindler, *Essential Relativity*, 2nd ed., pp. 7, 4 (Springer-Verlag, New York, 1977).
- [5] A. Einstein, "On the Electrodynamics of Moving Bodies", in H. A. Lorentz *et al*, *The*

Principle of Relativity, p.41(Dover, New York, 1952).

- [6] Wen-Xiu Li, “Logical Inconsistencies in Special Relativity theory”, Galilean Electrodynamics 10, 49-50 & 56(1999).
- [7] Xu Shaozhi and Xu Xiangqun, “A Reexamination of the Lorentz Transformation”, Galilean Electrodynamics 3, 5-8(1992).
- [8] Wen-Xiu Li, “On the Galilean Relativity of the Laws of Electrodynamics”, Physics Essays 7, 403-409(1994).
- [9] P. G. Bergmann, Introduction to the Theory of Relativity, p. 33(Prentice-Hall, Englewood Cliffs, N. J., 1942).
- [10] Ref. 4, p. 33.
- [11] H. Dingle, “Special Theory of Relativity”, Nature 195, 985-986(1962).
- [12] H. Dingle, “Special Theory of Relativity”, Nature 197, 1248-1249(1963).
- [13] H. Dingle, “Special Theory of Relativity”, Nature 216, 119-122(1967).
- [14] M. Born, “Special Theory of Relativity”, Nature 197, 1287-1288(1963).
- [15] W. H. McCrea, “Why the Special Theory of Relativity is Correct”, Nature 216, 122-124(1967).

Criticism To Einstein's Physics Thinking in His Book "The Meaning of Relativity"

Shi Yong-Cheng

(Shaoxing University, Shaoxing , 312000, P. R. China. [E-mail:shiygood@126.com](mailto:shiygood@126.com))

Abstract: It is discovered that Einstein's book "The Meaning of Relativity" contains of a supper mistake which leads to the famous twin "paradox". It is proven that the principle of constancy of the velocity of light in a vacuum is the result obtained by artificially set of measuring instruments and then the Galilean transformation and Lorenz transformation are unified based on the verification of their **equivalency** crossing 300 years history of physical space-time with one step - smashing the shackles of Einstein theory of relativity limitation of the velocity of macro object movement and eliminating the fairytale of Shrink-foot clock slow

Keywords: Lorentz transformation, Ideal clock, Geographic time-difference

1 Criticism to Einstein physics thinking in STR

The Galilean transformation

$$\begin{cases} x' = x - V\tau, y' = y, z' = z, & (1) \\ \tau' = \tau, & (2) \end{cases}$$

was put forward by physicist in the 16th century and it can make the equation of Newton mechanics second law has covariance, but it can't made that electromagnetic field equation has covariance, therefore Einstein attempted to change general understanding for time in Newton mechanics and then to build new transformation while he first employed the principle of the constancy of the velocity of light in a vacuum, to complete the definition of time by means of his scheme of adjustment of the clocks at rest relatively to an inertial system K^[1]. After these clocks are regulated according to the Einstein scheme in K, all these clocks have a same rate and have not geographic time difference and then if the time t recorded by the clock situated at rest at the origin O of the system K to be denoted by τ , the time t recorded by arbitrary clock situated at rest at a point where $x \neq 0$ in the system K is same with τ , therefore we have

$$t = \tau. \quad (2')$$

In his book^[1] Einstein said that space and time data have a physically real, and a mere fictitious, significance; in particular this holds for all the relation in which coordinates and time enter. There is, therefore, sense in asking whether those equations are true or not, as well as in asking what the true equations of transformation are by which we pass from one inertial system K to another, K', moving relatively to it. We point out that Einstein's problem and

thinking above are no any sense and are wrong. Since space and time data relate both of different observers and different measurement instruments, therefore these data has not any physically real significance and then the so-called true equations of transformation cannot be uniquely settled. It was proven that equations of transformation settled by means of the principle of the constancy of the velocity of light in a vacuum is not uniquely true equations, the equations of Galilean transformation are also true equations of transformation, they are equivalent each other's^[4].

In order to obtain new equations of transformation to replace the Galilean transformation, Einstein started from linear transformation of the type^{(see [1], p-32, (24))}

$$x'_\mu = a_\mu + b_{\mu\alpha}x_\alpha, \quad (A)$$

where x'_μ to be the space-time coordinates of an event in another inertial system K' , moving relative to K , applying the principle of special relativity and the principle of the constancy of the velocity of light, he obtained the Lorentz transformation^{[1] p-34}

$$(29) \quad \begin{cases} x'_1 = \frac{x_1 - vt}{\sqrt{1-v^2}}, \\ t' = \frac{t - vx_1}{\sqrt{1-v^2}}, \\ x'_2 = x_2, \\ x'_3 = x_3, \end{cases}$$

where $\gamma = 1/\delta$, $\delta = \sqrt{1-v^2}$, $v = v/c$, and $l (= ct)$, $l' (= ct')$ to be light-time. This transformation make that the Maxwell electromagnetic equations have covariance.

Eliminating x_1 in the second equation of (29) by means of the first equation of (29), we obtain following geographic time difference formula of clocks in moving inertial system K'

$$l' = \delta l - vx'_1, \quad (B)$$

which indicates (1^0) all clocks situated at rest at the space points where $x_1 \neq 0$ have same rate and different geographic time difference $-vx_1'$ with the standard clock situated at rest at origin O' , (2^0) the rates of all clocks situated at rest at the space points of the inertial frame of reference K' are $\delta (= \sqrt{1-v^2})$ time of the rate of the clocks situated at rest at the space points of the inertial frame of reference K where all clocks have been synchronized according Einstein's scheme of adjustment of the clocks at rest relatively to an inertial system.

Replace x_1, x_2, x_3, l by x, y, z, ct , these equations can be written in the form

$$\begin{cases} x' = \beta(x - vt), y' = y, z' = z, & (1^*) \\ t' = \beta(t - vx/c^2), & (2^*) \end{cases}$$

where $\beta = 1/\delta$. Since equations (A) has not any information which shows what measuring-sticks and what clocks to be applied in the system K' , the Lorentz transformation only

guarantees that the principle of the constancy of the velocity of light holds, but it cannot guarantee that the space-time coordinates of an event in system K' calculated by means of Lorentz transformation do not conflict with his scheme of adjustment of the clocks in another inertial system. Therefore it is fantasy that Einstein and his followers considered that the coordinates (x', y', z', t') in K' are found in the same way as the coordinates in K by means of standard clocks at rest in K' [2] (p36).

What measuring-sticks and what clocks should be applied for the system K'? whole deducing process of Lorentz transformation indicates that they should not be decided by Einstein and his followers, but they must be determined by Lorentz transformation. The famous twin "paradox" in STR shows that the Einstein scheme of adjustment of the clocks cannot be applied in the system K'. It is proven that the famous twin "paradox" in STR will not exist after the clocks to be regulated according to the geographic time difference formula (B)^[4].

2 Simultaneity and pig brain

When they consider the concept of simultaneously, they take same criterion for simultaneity in K and K' and then obtained a mistake conclusion that the concept of simultaneity has lost its absolute meaning^{[2](p34)} since their criterion for simultaneity cannot hold in K'. Their famous example on the simultaneity of two events occurring at different points just verifies that Einstein scheme of adjustment of the clocks is unlawful in K'. Since different clocks situated at rest at different places in K' have different geographic time difference expressed by the formula (B)^{[3](chpt.4)[4]}, they are simultaneous with the standard clock situated at rest at the origin O' after their geographic time difference to be reduced. Therefore the simultaneity between two event in different space points in system K still has its exact meaning for the men as observers in K' since the signals of light can carry TV information relating the registered exact time of local clocks when the event happening and observers can transform local time to standard time. A pig reading in a flying aircraft cannot understand it is simultaneous events that a Peking dog and a Washington dog died at a same Greenwich Mean Time when the TV signal coming from Washington early arrives at the aircraft than the TV signal coming from Peking while its owner will understand that the two dogs are simultaneously died from registered time of the Washington local clock and registered time of the Peking local clock whose images are showed respectively in the two TV signals.

3 Twin "paradox" and Einstein's super mistake

In order to expose the truthful face of Einstein's mythology on moving clocks, let us to examine the paragraph in page 36 of his book^[1] as follows: "A clock at rest at the origin $x_1=0$ of K, whose beats are characterized by $l = n$, will, when observed from K', have beats characterized by

$$l' = \frac{n}{\sqrt{1-v^2}}, \quad (C)$$

This follows from the second of equation (29) and shows that the clock goes slower than if it were at rest relatively to K'' . It is obvious here Einstein compared the clock (which is now denoted by (C) situated at rest at origin O of K with the clock (which is now denoted by C') situated at rest at a fixed point A' of the x_1' -axis. When $l=n$, the clock C just meeting the clock C'. Therefore we can obtain the coordinate of the clock C' on x_1 -axis as follows

$$x_1' = -vl' = -\frac{vn}{\sqrt{1-v^2}}.$$

Replace n by l in Eq. (C), we obtain

$$l = \sqrt{1-v^2} l', \quad (C^*)$$

Consider that the clock C' at rest at the origin $x_1'=0$, we can obtain from the first and second equations of (B)

$$l' = \sqrt{1-v^2} l, \quad (C^{**})$$

Einstein and his followers considered that (C*), (C**) are equivalent to following formulas respectively

$$\Delta l = \sqrt{1-v^2} \Delta l', \quad (D^*)$$

$$\Delta l' = \sqrt{1-v^2} \Delta l, \quad (D^{**})$$

and then present the mythology of moving clocks based upon (D*) and (D**) which leads to the famous twin ‘‘paradox’’. However we will prove that the formula (D*) is not equivalent to (C*) and it does not hold.

Since l, l' are instantaneously registered time, it is Einstein’s supper mistake that their comparison has been considered as the criterion for the comparison of rates of clocks . We must consider their started time respectively to compare their time difference respectively. When the origin O coinciding with origin O', for all clocks situated at rest at different space points in K, we have $l = 0$ since these clocks are regulated according to the Einstein scheme. Therefore we have

$$\Delta l = l - 0 = n.$$

For clock C' when the origin O coinciding with origin O', its registered time can be obtained from (B) by putting $t=0$ and $x_1'=-vl'$ as follows

$$l' = -v \left(-\frac{vn}{\sqrt{1-v^2}} \right) = \frac{v^2 n}{\sqrt{1-v^2}}.$$

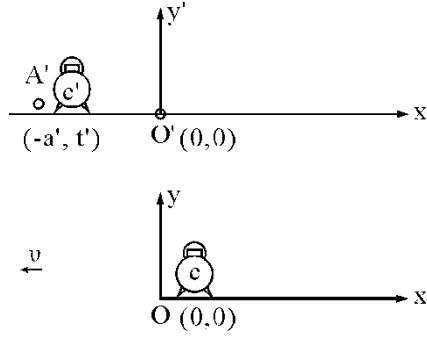

Fig 1. At $t' = t = 0$, the clock C which is situated at rest at the origin O coinciding with the origin O'

while the clock C' which is situated at rest at the point A' specified by coordinate $x' = x'_1 = -v'l'$

on the x' -axis records the geographic time difference $l' = -v^2 n / \sqrt{1-v^2}$.

Therefore we obtain

$$\Delta l' = \frac{n}{\sqrt{1-v^2}} - \frac{v^2 n}{\sqrt{1-v^2}} = \sqrt{1-v^2} n. \quad (E^*)$$

Then we have

$$\Delta l' = \sqrt{1-v^2} \Delta l, \quad (E)$$

which is same with (D**) and leads to an opposite consequence to Einstein as follows: “The clock goes faster than if it were at rest relatively to K”. The formula (E) comes from (C*) and (C**) respectively that shows that (E) and its physics deduction are independent of observers. The local clocks situated at rest at different space points in K' go slower than the local clocks situated at rest at different space points in K where Einstein scheme has been performed. This result holds for all observers and then there is no a little of relativity.

4Equivalence between Galilean transformation and Lorentz transformation

From the pointing out of Galilean transformation to confirmation of Lorentz transformation by Einstein and then the establishment of special theory of relativity by Einstein, it stepped over about 300 years; therefore, the modern physics theory building was established in the 20th century. However, the book “A Brief History of Time” (Stephen Hawking) became popular all around world and Einstein theory of relativity of hundred years’ history was considered as supreme civilization. The verification of the equivalency between Galilean transformation and Lorentz transformation---marking the end of Einstein theory of relativity: utilizing the following SGTd formula (Shi geographic time difference formula)

$$t = \tau + \lambda x, \quad (3) \quad t' = \tau' - \lambda x', \quad (4)$$

where

$$\lambda = \left(1 - \sqrt{1 - v^2/c^2}\right) / v = \left(\sqrt{1 + V^2/c^2} - 1\right) / V, \quad (5)$$

$$V = dx/d\tau, \quad (6) \quad v = dx/dt, \quad (7)$$

$$v = V / \sqrt{1 + V^2/c^2}, \quad (8)$$

utilizing extremely simple elementary mathematical operation, it can make strict derivation each other between Galilean transformation (1) and(2)and Lorenz transformation (1*) and(2*) (see relating paper 4 and 5), so it denies the traditional fallacy that Galilean transformation is the low speed similarity of Lorenz transformation while the same correctness of these two transformations is definitely proven. The velocity v , V in (6), (7) relate the different definitions of velocity. Using clock without geographic time difference to measure time, the velocity definition is (6), so we call it proper velocity. The macro object proper velocity and light proper velocity obey the Galilean addition theorem for velocities, vacuum light speed is changeable and Newtonian mechanics is beyond limitation of Lorenz transformation---velocity is no limit. The velocity in (7) is coordinate velocity and macro object movement coordinate velocity and coordinate light speed obey the Einstein velocities addition formula: the vacuum coordinate light speed is not changeable, the coordinate velocity of any macro object can't surpass light speed in vacuum. In the application science filed of mechanics and electrodynamics relating with large scale time and space area, it can use these two transformations, however, Lorenz transformation relates with artificial setup of different location with geographic time difference and it is not suitable to apply, therefore it does not have the actual value and for space navigation, it is useless at all.

Considering the geographic time difference(3),(4) hided in time coordinate in Lorenz transformation, the calculation made by the transformation shows: the moving clock and static clock work at the same rate and moving ruler and static ruler have the same length which completely denies the fallacy of Einstein^[4].

5Lorenz transformation in absolute Space-time

Because the time variable t in Maxwell field equation is measured by synchronous clock without time difference, butLorenz transformation deduced by Einstein from symmetry determines that the time variables before and after transformation all have non-zero time difference, so the Lorenz transformation deduced by Einstein can't be used for the Maxwell electromagnetic field equation, however, we prove that Lorenz transformation still holds giving up symmetry (see relating paper 4). In this article, we consider two inertial reference frames K , K' which is moving along positive direction of x - axis relative K . In K all clocks are synchronized with zero geographic time differences. In K' we take shorter unit measurement rule which has δ^* time of the length of the unit measurement rule used in K , her δ^* to be thecoefficient of Shrink-foot

$$\delta^* = \sqrt{1 - v^2/C^2}, C \in (v, \infty), \quad (9)$$

here C is a constant and it can be arbitrarily chosen in the real interval (v, ∞) , and take slowly δ time synchronized clocks than the clocks in K while non-zero geographic time differences to be set for these clock according to following Shi formulas

$$t' = \delta^* t - \frac{vx'}{C^2}.$$

Therefore the Galilean transformation can then be expressed in the form

$$\begin{cases} x' = \frac{1}{\delta^*}(x - vt), & y' = y, & z' = z, \\ t' = \delta^* t - \frac{vx'}{C^2}, \end{cases}$$

which is the Shi's Galilean transformation which guarantees that the Maxwell equations to be co-variant with respect to the transformation in the absolute space-time. Shi's Galilean transformation has the same mathematical formulas with the Lorentz transformation, but they are different transformation since there are different installations of clocks and rules respectively in two inertial systems for the Shi's Galilean transformation, and then **iteliminating the fairytale of Shrink-foot clock slow**. Shi's Galilean transformation is independent of the Einstein's suppositions on the physical symmetry and the principle of constancy of the velocity of light in vacuum. Shi's Galilean transformation continues to have the fundamental hypotheses of the Newton mechanics:

(1). **Time is absolute**, (2). **Length is absolute**.

The transformation result of Lorenz transformation on Maxwell field equation keeps the same physics effect with Galilean transformation besides their different mathematical formats.

For the most typical physical deduction “**the moving clock works slower**” of Einstein theory

of relativity, we change a letter for it in the result “**the moving clock adjusts slower**” as the end of Einstein theory of relativity.

It has been proven that Shi's Galilean transformation with its inverse transformation has same artificial installation of measurement instruments.^[6]

The curtain of a physical farce spanning the two centuries will fall down soon.

References

- [1] Einstein, The Meaning of Relativity, Princeton University Press.1955.
- [2]C.Moller,The Theory of Relativity,Clarendon Press.Oxford,1972
- [3]Bergmann.P.G.(1942).Introduction to the theory of relativity, Prentice Hall,New York
- [4] Yong-Cheng shi , Einstein's Mistakes in Special Theory of Relativity and their corrections,

Matter Regularity, Vol.11 Sum No.43, p6-p29 , 2011 USA.

www.qiji.cn/eprint/abs/3579.html. www.qiji.cn/eprint/abs/3580.html.(2007)

www.wbabin.net/science/yongcheng.pdf

[5] Using one letter to correct Einstein theory of relativity, Shi Yongcheng. .Beijing theory of relativity association the 5th annual meeting paper album.4 VOL, 2009, p136-144

[6] Shi Yongcheng,The remark about “Using one letter to overrun the Einstein theory of relativity”, 2010-3-19, Matter Regularity, p87ol.10 No38, 2010-4-30.

[7] Shi Yong-Cheng, Shi’s Galilean transformation, 2010-5. gsjournal.net

www.wbabin.net/science/yongcheng5.pdf

[8] Shi Yong-Cheng, The Demise of Eintein’s STR—Verification of the equivalency between the Galilean and Lorenz transformations, www.wbabin.net/science/yongcheng7.pdf

Using Space-time Quantization to Solve the Problems Unsolved by General Relativity

Xu Jianmin

(Lawyer of Beijing Unitalen Law Office, jianminshu213@yahoo.com.cn)

Abstract: Based on the law of thermodynamics, the paper proposes the assumptions of radiation and redshift, establishes the quantum gravitational field equations and motion equations, and presents that particles move along the path with the minimum entropy production. The paper also applies the equivalence principle of acceleration and the gravitational field into the electromagnetic field, which makes the electromagnetic field equation to have the same form with gravitational field equation. Under the quantization of space-time, the unification of electromagnetic field and gravitational field is achieved. An attempt is also made to propose a scheme to unify all fields, namely, all fields are quantum metric fields. The reason for different strengths of fields is their different fine structure constants. The problems of singularity in gravitational field and the infinity in quantum electrodynamics are solved, and all equations return to classical theories under extreme conditions.

Keywords: quantum field, redshift, minimum entropy production, general relativity

1 Introduction

As is well known, the following problems of general relativity have not been solved: firstly, the equivalence principle resulted from the direct proportion between inertia mass and gravitational mass and the Mach principle notably established based on the assumption of instantaneous action-at-a-distance could not be the first principles. They should be rooted on a higher level of principles. What is the final principle then? Secondly, the problem of singularity. Since the establishment of general relativity, some solutions have occurred singularities which make the metric difficult to be defined. Although some physicists believe that both collapsed star and evolution of the universe would inevitably lead to singularities, the equation of general relativity fails on the singularities with zero time existence, zero volume, infinite density and infinite gravity. Thirdly, problem of unified field. After the establishment of general relativity, Einstein attempted to unify gravitational field and electromagnetic field based on the general relativity, but failed. The problem here is whether the geometrization of space-time could be taken as the foundation of the total field. If not, what is the foundation of the unification? Fourthly, the problem of quantization of space-time. If all fields are defined on the framework of space-time, then the quantization of field is actually the quantization of space-time, but it is the problem which has not been solved by the general relativity. Obviously, problems above are fundamental and significant problems of physics. It is impossible to solve the problems just in this paper. The paper only attempts to draw the outline of the issue. The basic idea of the paper is to build the general relativity on a higher level of principle, and based on this, to realize the quantization of fields and the unification of gravitational field and electromagnetic field. Meanwhile, new theory is consistent with the general relativity in the following aspects: Space-time is completely dynamic; physical equations should be covariant to any transformation of coordinates. To all

observers, no matter whether it is uniform motion, accelerated movement or rotation, laws of nature appear the same. The metric determines the space-time, and space-time affects the metric. This is the so called background independence.

2General assumptions established based on law of thermodynamics

Any physical theory needs one or several basic assumptions, and these assumptions may come from the observation of objective world or from logical reasoning. Early in the beginning of the 20th century, Poincare pointed out that, if a scientific law is taken as the observation result in the eyes of a mathematician, and is taken as a theorem of mathematics in the eyes of observers, then the law could be taken as the consolidated and long lasting foundation of the overall physics. He regarded the first and second law of thermodynamics are these types of laws. Apparently, the law of conservation of energy is the foundation of present physics, while the second law of thermodynamics is in an embarrassing position. There is a serious contradiction between the law and the most of the physics. On the one hand, almost all of our empirical processes are irreversible, and they should be interpreted by the second law of thermodynamics; on the other hand, the second law of thermodynamics almost has no reason to exist in all physics, including classical mechanics, quantum mechanics, quantum electrodynamics and the theory of relativity. Some physicists like Boltzmann hold that classical mechanics is the foundation of all physics, and the second law of thermodynamics is just the logic conclusion of classical mechanics. So he attempted to use mechanics to interpret entropy in order to solve the contradiction between classical mechanics and the second law of thermodynamics, but failed. Along with the development of physics, there has been an increasing awareness that taking mechanics as the foundation of physics is not reliable. People think if the mechanics could not be used to interpret the entropy, then whether it is possible to use entropy to interpret thermodynamics? The logical consequences of the thinking above must be consistent with the ideal of Poincare, namely, the law of thermodynamics is the only foundation of the overall physics. The paper attempts to establish such a new physical theory, which accords with the viewpoint that entropy is irreversible and could return to the currently applied and recognized kinetic theory under the extreme conditions.

According to the statistical interpretation of Boltzmann on entropy, the nature of entropy is that, in an isolated system, any biogenetic process always makes energy irreversibly tend to a balance state, or each change of entropy is to make the physical system transfer towards a balance state or towards a state with larger probability. This kind of balancing process should include both the balancing of energy density and balancing of energy magnitude. Therefore, we propose the following assumptions according to the concept of entropy:

1) Hypothesis of radiation and redshift. In an system consisting of material objects and empty space, since the energy density of material object is larger than that of empty space, the energy radiation from material objects to empty space is a spontaneous process; the redshift of quantum in an isolated system is spontaneous, and the quantum could not automatically occur blue shift;

2) Equivalence between acceleration and the gravitational field. Field generates particle acceleration, and acceleration generates inertial field. The principle could also be expressed like this: if a process tending to balance (redshift) is damaged by acceleration, then an inertial field for the recovery of balance (blue shift) must be generated; if the former process is a positive process, then the latter is a reversed process of recovery. Positive comes from negative, vice versa. Inertia originates from entropy.

3) Principle of minimum entropy production: particles moving along with the path with the minimum entropy production

3 Quantum gravitational field equation

In an isolated system, the energy density of material objects is larger than that of space, and the radiation of energy from material objects to space is a natural process. By taking the earth as an example, given earth radiates quantum $\hbar\omega$ with certain frequency, and its momentum is as follows:

$$p_0 = \frac{\hbar\omega_0}{c}$$

In the formula, \hbar is simplified Planck constant, ω_0 is the frequency of quantum when $t = 0$, and c is light velocity. According to hypothesis, the quantum should continue to carry out red shift towards empty space, and the change of quantum momentum is:

$$\Delta p = -\frac{\hbar}{c}(\omega - \omega_0) = -\frac{\hbar}{c}\Delta\omega = -(p - p_0)$$

“-”stands for quantum redshift. The change of momentum could be expressed as:

$$\frac{\Delta p}{\Delta t} = -\frac{\hbar}{c} \frac{\Delta\omega}{\Delta t}$$

Namely, the impulsive force generated by quantum redshift, (Note that, in order to provide convenience, vectors used in the paper are one dimensional)

$$F = -\frac{\hbar}{c} \frac{\Delta\omega}{\Delta t} \quad (1)$$

Since the direction of impulse force is same with the momentum increase, the negative sign shows that the direction of the force generated by quantum redshift points to field source. This kind of radiation is isotropic spherical radiation, and the force of this radiation to the earth surface is symmetrical.

Given

$$f = \frac{\Delta\omega}{\Delta t}$$

Then

$$F = -\frac{\hbar}{c} f \quad (2)$$

As a new function, f could be called frequency fluctuation rate. According to the equivalence theory of mass and energy, energy quantum has mass, and the force generated by the quantum should be equivalent to the universal gravitation of Isaac Newton, namely,

$$-\frac{\hbar}{c} f = \frac{\hbar\omega}{c^2} g$$

$$f = -gk \quad (3)$$

In the formula, $k = \frac{2\pi}{\lambda}$ is wave vector. Negative sign means that the direction of f decrease is opposite to the field direction, namely, it is an attractive force. As a scalar product, the formula above could also be written as $f = -gk\cos\theta$. In the formula, θ is the

included angle between g and k ; when $\theta = \pi/2$, $f = 0$, which means that no energy change occurs on the equipotential line; when $\theta = \pi$, $f > 0$, direction of g is opposite to that of k , namely, there is repulsive force.

Obviously, the solution of formula (3) is

$$\omega = \omega_0 \exp(-gt / c) \quad (4)$$

Since the speed of gravitational field is light velocity, the formula above could be written as:

$$\omega = \omega_0 \exp(-gr / c^2) \quad (5)$$

Meanwhile, the following formula could also be figured out based on $c = \lambda\nu$.

$$k = k_0 \exp(-gr / c^2)$$

Take the logarithm on both sides of equation (5),

$$g = -\ln\left(\frac{\omega}{\omega_0}\right) \frac{c^2}{r} \quad (6)$$

This is the equation of static gravitational field. The equation shows that, all the fields between same high frequency and same low frequency are equal, and they have nothing to do with the matters of field source.

Under the circumstance of weak gravitational field, the frequency change could be taken as continuous process, and equation (1) could be written as:

$$F = -\frac{\hbar}{c} \frac{d\omega}{dt} \quad (7)$$

Given V is force potential.

$$\begin{aligned} F &= -\nabla V(r) \\ V(r) &= -\int_{r_0}^{r_1} \frac{\hbar}{c} f \cdot dr + V_0 \\ &= -\hbar \int_{r_0}^{r_1} f \cdot dt + V_0 \quad (8) \\ &= -\hbar \int_{\omega_0}^{\omega_1} d\omega + V_0 \\ V(r) - V_0 &= -\hbar(\omega_1 - \omega_0) \end{aligned}$$

The formula above indicates that the force field generated by quantum redshift is conservative force field. Frequency difference constitutes potential difference. When considering $k \rightarrow \nabla$,

$$f = f_0 \exp(Gm / c^2 r) = \nabla^2 \varphi$$

Poisson's equation is substituted into above equation.

$$f_0 \exp(Gm / c^2 r) = 4\pi G\rho \quad (9)$$

4Comparison of quantum gravity space-time and general relativity space-time

If ω_0 is taken as the quantum frequency measured by the clock moving along with the observer, and λ_0 is the space measured by a ruler moving along with observer, then the

frequency and wavelength of next neighbouring quantum are ω and λ , and they are calculated by the following two equations:

$$\omega = \omega_0 \exp(-GM / c^2 r) \quad (5a)$$

$$\lambda = \lambda_0 \exp(GM / c^2 r) \quad (10)$$

Here, the space-time is quantized. In a strong gravitational field, it is neither possible to continuously read values in space-time coordinates, nor to get zero, since the frequency and wavelength could not be zero.

In the equations, $\exp(GM / c^2 r)$ is the quantum space-time metric, which is used to measure the space-time. In quantum gravity, coordinate no longer has direct metric meaning. Space-time coordinate is determined by metric, and meanwhile the space-time also affects metric. Therefore, in a strong gravitational field, there is no globally unified space-time.

Under the condition of $GM / c^2 r \ll 1$, namely, in a weak gravitational field , Taylor expansions of above two equations are made as follows:

$$\omega = \omega_0 (1 - GM / c^2 r + \dots) \quad (11)$$

$$\lambda = \lambda_0 (1 + GM / c^2 r + \dots) \quad (12)$$

Obviously, $1 + GM / c^2 r$ is Schwarzschild metric. So, the time interval is $\Delta t = 1 / \Delta \omega$, and space interval is $\Delta r = \Delta \lambda$. Choosing a proper coordinate for equation (12), we can get the following equation.

$$\Delta r = 4\pi G \rho r^3 / 9c^2$$

In the equation, ρ is the mass density within the sphere. This is the Einstein's Law of space mean curvature, namely, Einstein field equation.

The frequency and wavelength of quantum are related to the distribution of matters. Therefore, space-time is not absolute, but changes along with different locations.

In strong gravitational field, the space-time variables are discrete, namely, quantized. In the equation (5), when

$$r \rightarrow R = Gm / c^2$$

The frequency of the quantum shows a nonlinear variation. But when $r \rightarrow 0$

$$\omega \rightarrow 0 ,$$

It indicates that the asymptotic freedom occurs inside the particles. Since the wavelength of the quantum from particle radiation cannot be smaller than the particles themselves, and the wavelength of the particles cannot equal to zero, which means that space-time has a limit, and thus there can be no singularity problems. When $r \rightarrow \infty$, $\omega = \omega_0$

it is an inertial system with no field. But since the wavelength of quantum can neither be zero nor infinity, the formula above will never occur, and there must exist at zero-point energy.

From the following formula,

$$\Delta \omega = \omega_0 GM / c^2 r$$

it can be seen that changes of local phase generate the gravitational field, or, in other words, the introduction of gravitational field is a must to keep local phase unchanged. Therefore, quantum gravity field complies with the principles and specifications.

5 Equation of Motion

Since

$$f = \frac{d\omega}{dt} = -\frac{g}{c} \omega_0 \exp\left(-\frac{gt}{c}\right)$$

Substitute the formula above into equation (7) to obtain

$$F = \frac{\hbar g}{c^2} \omega_0 e^{-\frac{gt}{c}}$$

Considering the mass of energy quantum $m = \frac{\hbar\omega_0}{c^2}$, and hence

$$a = g_0 e^{-\frac{gt}{c}} \quad (13)$$

a is the acceleration of particles, and this is the equation of motion. The acceleration of an object has nothing to do with its mass.

For object motion, the equation should be used in three levels.

Firstly, for extremely strong gravitational field, the object acceleration changes exponentially.

Secondly, for strong gravitational field with particle oscillation, namely when $\frac{gt}{c} \ll 1$, conduct Taylor expansion to the left side of the equation above.

$$a = g_0 - \frac{g_0 \times v}{c} + \dots \quad (14)$$

In the formula, $v = g_0 t$. The first item on the right side of the equation is the inertial field paralleled with g_0 , which can be written as $g_{//}$; the second item on the right side

$$g_{\perp} = -\frac{g}{c}$$

g_{\perp} is the inertial field vertical to a , which is named transverse field for short, and can also be called gravitomagnetic field. These two fields can be referred to as dynamic gravitational field, and they are the sources of gravitational waves. The resultant force on an accelerating object in gravitational field with particle oscillation is:

$$F = m(g_0 + v \times g_{\perp}) \quad (15)$$

Obviously, it is equivalent to the Lorentz force.

Thirdly, in the case that acceleration is very small or the gravitational field is very weak, the second item on the right side of the above equation can be ignored, and then go back to Newton's equation.

6 Wave Equation

Particle oscillation results in gravitational waves and the wave equations are:

$$k \times g_{//} = \omega g_{\perp}$$

$$k \times g_{\perp} = \mu_0 \epsilon_0 \omega g_{//}$$

Among them, ω and k are the frequency and wave vector of the field point energy level respectively. In a weak gravitational field,

$$\nabla \times g_{//} = \omega g_{\perp}$$

$$\nabla \times g_{\perp} = \mu_0 \epsilon_0 \omega g_{//}$$

Single particle acceleration won't produce gravitational waves, and only particles oscillating back and forth would produce gravitational waves. When single particle accelerates, the inertial field $g_{//}$ and the gravitational field g_o are in opposite directions, and they can almost offset in a weak field, so that it's as if inside a lift free falling in the earth's gravitational field. However, when particles oscillate back and forth, $g_{//}$ and g_{\perp} could form and outspread gravitational waves through mutual excitation. Accelerating particles may interact with the gravitational waves. This effect can be detected at the time of solar eclipse. When solar eclipse occurs, the moon is suddenly attracted by the solar gravitational field to accelerate, and then reverberated back due to the earth's gravity attraction, generating oscillation (acceleration). At this time, the acceleration of the moon approximately equals to the solar gravitational field for the moon orbiting the sun. According to formula (15), if ignoring the transverse field, the inertial field generated by the moon equals to its acceleration generated by the sun. The additional acting force imposed on moving bodies on the earth such as torsional pendulum by this inertial field is $F \approx mg_{\text{sun}}$. In the formula, m is the mass of the torsional pendulum, and g_{sun} is the gravitational acceleration of the sun. According to

estimation, the force is $F \approx \frac{GM_{\text{sun}}}{r^2} m \approx 5.89 \times 10^{-3} m$. Since they are moving gravitational field, they only affect accelerating objects. Only moving bodies (accelerating) produce gravitational waves, and therefore gravitational waves can only be detected by moving bodies. Experimental physicists are expected to inspect the conclusions drawn above.

7 Entropy of Open System

Any reversible process accords with this equation

$$\oint f dt = 0 \quad (16)$$

The work produced by quantum redshift

$$dw = F dr = -\frac{\hbar}{c} f dr = -\hbar f dt$$

$$W = \int_1^2 F dr = -\hbar \int_{t_1}^{t_2} f dt = -\hbar \int_{\omega_1}^{\omega_2} d\omega = -\hbar(\omega_2 - \omega_1)$$

Thus equivalent work produced by quantum redshift only relates to the quantum at the beginning and the end states, but has nothing to do with the path of the quantum. According to the law of conservation of energy, the work generated from quantum redshift transformation into field and their energy dissipations are equivalent. Therefore, it is in a reversible state

$$\omega_2 - \omega_1 = \int_1^2 f dt = 0$$

$$\Delta\omega = 0 \quad f = 0$$

R in the formula represents the integral along the reversible process.

However, in a static gravitational field, due to the quantum redshift, there must be

$$\omega_2 < \omega_1$$

Hence $\int_1^2 f dt < 0$

$$\Delta\omega < 0 \quad f < 0$$

It is an irreversible process. To combine both reversible and irreversible circumstances

$$\Delta\omega \leq 0 \quad f \leq 0$$

That is to say, in a static gravitational field, frequency variation rate never increase.

Moreover, in a gravitational field, due to

$$\frac{\omega}{\omega_0} = e^{-\frac{gt}{c}} \quad (17)$$

$\frac{\omega}{\omega_0}$ is the probability of quantum redshift, and take logarithms on both sides of the equation above, obtaining

$$\ln\left(\frac{\omega}{\omega_0}\right) = -\frac{gt}{c}$$

$$S = k \ln\left(\frac{\omega}{\omega_0}\right) \quad (18)$$

Therefore, entropy is

$$S = -k \frac{gt}{c}$$

or

Among them, k is the Boltzmann constant. The equation above is the relationship between field and entropy.

Since $f \leq 0$ under the natural state, the entropy increase process is the decrease process of frequency variation rate f .

$$\Delta S = S_2 - S_1 = k\left(\frac{g_1 r_1}{c^2} - \frac{g_2 r_2}{c^2}\right) = k \frac{V_1 - V_2}{c^2} > 0$$

V here is gravitational potential. The increase of entropy means the capability to produce work declines.

Then we discuss the entropy change in the gravitational field with accelerating particle system.

From the concept of entropy, quantum redshift is the natural direction of energy transfer, and could proceed spontaneously. Blue shift is the unnatural direction, and it cannot proceed without external influence. Acceleration is the unnatural direction, and cannot proceed without external force. Here we popularize Prigogine's Entropy Change Theory. Prigogine thought the entropy change of system (dS) is equal to the sum of entropy flow

($d_e S$) and entropy production ($d_i S$) within the system. Namely,

$$dS = d_e S + d_i S (d_i S \geq 0) \quad (19)$$

in an isolated system, $d_e S = 0$,

so $dS = d_i S \geq 0$.

In a system with acceleration, inertial field makes the original red-shifted quantum have a blue shift again, like negative entropy flow entering the system from the outside.

$$d_e S < 0$$

However, since acceleration must be with a gravitomagnetic field vertical to it, and this field makes no contribution to the quantum's blue-shift of the original field. This could also be proven by the aspect of field to do work. An object accelerating at the radial direction

certainly generate a gravitomagnetic field vertical to the radial direction.

$$mg_{\perp} = mg_0 \frac{1}{2} \frac{ar}{c^3} \times v_r \quad (20)$$

The displacement at radial direction is

$$v_r dt = dr$$

Both sides of equation (20) multiply by $v_r dt$, and the right side is 0, which means the Coriolis field doesn't do any work on the mass point, and the blue-shift of inertial field is not able to restore the red-shifted quantum into original state, namely, there is always

$$d_e S + d_i S \geq 0 \quad (21)$$

So the second law of thermodynamics is effective generally.

8 Particles always move along the path with minimum entropy production

In classical mechanics, the movements of particles comply with the principle of least action. According to the principle, the difference between mean kinetic energy and mean potential energy of the path where particles go from one point to another point should be as small as possible. Particles choose a shortest path after considering all the paths in the process of movement. This seems contradictory with human intellect. Nobody could explain the reason of the existence of such principle contradictory with human intellect even today. The red-shift field theory could explain this. The acceleration of particle breaks the original process (positive process) approaching to balance. So there must be a reversed process (reverse process), and this reversed process will certainly approximate to the positive process as far as possible. The difference of these two processes should be the least.

For a complete process of acceleration, the energy change is: under the circumstance of weak gravitational field, doing Taylor expansion on formula (5) and ignoring small amounts above second order, we can get

$$\omega_1 = \omega_0 (1 - gr / c^2)$$

This is the change of red-shift of positive field. The change of blue-shift of inertial field generated by particles' acceleration— reverse field is

$$\omega_2 = \omega_1 (1 + gr / c^2)$$

So the total change of energy is

$$\omega_2 = \omega_0 \{1 - (gr / c^2)^2\}$$

Apparently, the difference between kinetic energy and potential energy is a second order small amount. The principle of least action is to ignore this second order small amount, namely,

$$\delta \int \Delta \omega = 0$$

We know is the clock-measuring frequency difference fixed on the movement reference system. It's the reciprocal value of time difference, so the formula above could also be expressed as the longest original time.

This is the principle of least action of reversible kinetics. The second law of thermodynamics shows that every acceleration movement has a largest inertia correspondingly, the difference between original field and inertial field is always the least, and nature is always tending to balance. This is the essence of principle of least action.

However, for irreversible kinetics, the system's tending to balance is still an irresistible force. Nevertheless, when the boundary conditions prevent the system from going to a balance, the system chooses the second best, going toward the state of minimum entropy production,

namely, approaching to the balanced state as far as possible. Particles move along the path with minimum entropy production.

$$S = -k \frac{gr}{c^2}$$

$$\text{Entropy production rate } \Theta = \frac{ds_i}{dt} = \frac{k}{c^2} \frac{dr}{dt} \frac{Gm}{r^2}$$

Entropy production could be expressed as the product of flow and force.

Without proving, we believe that the entropy production rate is constantly positive. $\Theta > 0$

When the system deviates from steady state, it transits to steady state

$$\frac{d\Theta}{dt} < 0 \quad (\text{deviating from steady state})$$

$$\frac{d\Theta}{dt} = 0 \quad (\text{steady state}).$$

Entropy doesn't change with the passage of time, $dS = 0$, namely, $d_e s = -d_i s < 0$.

The energy flow or material flow coming from the environment (acceleration of particles) determines a negative entropy flow, but it's counteracted by the entropy in the system, and the system transmits entropy to the outside. A stationary state with nonequilibrium state is formed.

9 The same principle and different metric field

If all the fields are defined on space-time, and the measurement of space-time is accomplished by metric, then all the fields are metric fields. If the frequency and wavelength of quantum is space-time itself, then unified field is the theory of using metric to measure the changes of different frequencies and wavelengths.

The equivalence principle aforementioned is given by entropy theorem directly, which is different from the Einstein's equivalence principle of general relativity. Firstly, the equivalence principle is not restricted to gravitational field, and the new equivalence principle is effective at all fields. Secondly, there is no need of auxiliary of Mach principle, and inertial field is directly from acceleration, rather than from remote matters. We make this conclusion before: all the fields between same high frequency and same low frequency are equal, having no relation with the material of field source. If this field includes both gravitational field and electromagnetic field, then we need to popularize the equivalence principle of acceleration and gravitational field. This popularization is very simple, namely, equivalence of acceleration and electromagnetic field, if

$$\omega = \omega_0 \exp(-at / c)$$

Acceleration of electrons $a = qE / m$

e and m are respectively the charge and mass of electron, E is electric field strength.

Then we get

$$\omega = \omega_0 \exp(-qEt / mc) \quad (24)$$

Similarly, for electromagnetic field,

$$f = \frac{d\omega}{dt} = \frac{qE}{mc} \omega_0 \exp\left(-\frac{qEt}{mc}\right)$$

$$\text{So } F = \frac{qE}{m} \frac{\hbar\omega}{c^2} \exp\left(-\frac{qEt}{mc}\right)$$

We get

$$a = \frac{qE}{m} \exp\left(-\frac{qEt}{mc}\right) \quad (25)$$

When $at \ll c$, ignoring small amounts above second order, then

$$a = \frac{qE}{m} - \frac{qE}{c} \frac{qEt}{m} + \dots$$

Namely, $\mathbf{F} = q(\mathbf{E}_0 + \mathbf{v} \times \mathbf{B})$

$$\text{In the formula, } v = \frac{qEt}{m}$$

Above equations of gravitational field and electromagnetic field are not only unified in forms, but also have the same generation mechanism, both being the products of quantum frequency variation. For purpose of convenience, we express both fields by the formula of

gravitational field, only changing g to $\frac{e}{m}E$ when involving electromagnetic field.

10 Export of fine structure constant

From equation (22), we can get

$$\omega = \omega_0 \exp(-e^2 / 4\pi\epsilon_0 mc^2 r) \quad (27)$$

In a weak field, when system is deviated from the steady state, the law of minimum entropy production requires the system to tend to a steady stationary state.

$$s = k \ln \frac{\omega}{\omega_0} = -k \frac{e^2}{4\pi\epsilon_0 mc^2 r} \quad (28)$$

s is a determined amount which does not change along with the time. In addition, it should have a maximum value, so in the equation of (26), r should be the minimum value. Based on quantization of space-time, it is not allowed to freely take values on the space-time coordinates, and r should be the wavelength of a certain quantum. Since entropy requires that particle is not allowed to radiate the quantum with higher static energy than itself. For electromagnetic field, the minimum wavelength emitted from electron should not be smaller than the Compton wavelength of the electron. The quantum wavelength of electron radiation is most likely to be the Compton wavelength of the electron. $r = \lambda_e$ then the exponential part of equation (25) becomes a constant, and it is called fine structure constant. This constant indicates the strength of this field. Then

$$\omega = \omega_0 e^{-\alpha}$$

In the formula, α is fine structure constant. For electromagnetic field

$$\alpha = \frac{e^2}{4\pi\epsilon_0 c\hbar} \approx \frac{1}{137.040}$$

For strong nuclear field $\alpha = \frac{g^2}{4\pi\epsilon_0 c\hbar}$

In the formula, g is strong nuclear

For the deduction of the fine structure constant of strong nuclear field, we must turn the frequency of the quantum into the particle with mass. We assume π meson is the energy level in atomic nucleus, and the redshift of the proton could only occur by reaching π with one step. Namely,

$$\pi = p \exp\left(-\frac{g^2}{4\pi\epsilon_0 m_0 c^2 r_0}\right)$$

In the formula, m_0 and r_0 are the mass and wavelength of proton respectively, the fine structure constant of neutron is

$$\alpha_n = \ln \frac{\pi}{p} = -(g^2 / 4\pi\epsilon_0 c^2 r_0) = -1.91, \quad (29)$$

Meanwhile, when proton has redshift to π meson, recoil must occur, so as to have an inertial field in which particle blue shift occurs. So

$$\pi = (p - \pi) \exp(g^2 / 4\pi\epsilon_0 c^2 r)$$

Fine structure constant of proton is:

$$\alpha_p = \ln \frac{\pi}{p - \pi} = 1.79 \quad (30)$$

Since the directions of transverse fields (magnetic field) generated by red shift and blue shift are opposite, so the field strength is finally represented on the difference of the two transverse fields, namely 0.12.

The hadronic charge is calculated through formula (27), namely, $g = 2.59 \times 10^{-18}$, which is 1.616×10^1 times of electron charge.

The ratio between the strength of strong nuclear field and that of electromagnetic field is $0.12 / 0.0073 = 1.643 \times 10^1$.

For gravitational field,

$$\alpha = \frac{GM}{c^2 R}$$

R is radius of object. For example, the fine structure constants of sun and earth are

$$\alpha_{g\text{Sun}} = \frac{GM_{\text{Sun}}}{c^2 r_0} = 2.11 \times 10^{-6} \quad (31)$$

$$\alpha_{g\text{Earth}} = \frac{GM_{\text{Earth}}}{c^2 r_0} = 6.95 \times 10^{-10} \quad (32)$$

For weak gravitational field, we could globally define the space-time, namely, the r of above two equations could directly use the distance between sun and earth.

Under Planck length of $L = \sqrt{G\hbar / c^3}$, fine structure constant is

$$G\hbar / c^3 r^2$$

Here, R is wavelength, and space-time must be locally defined.

11 Physical significance of fine structure constant and the physical problems solved

We can see that, fine structure constant not only can measure the strength of fields, but it is also the probability of mechanical quantity in the field to the inherent mechanical quantity; meanwhile, it is taken as the metric to measure variation of space-time and phase.

$$F = -\frac{\hbar}{c} f$$

It can be seen from $F = -\frac{\hbar}{c} f$, force is in direct proportion to the frequency fluctuation rate, and the frequency fluctuation rate is in direct proportion to frequency. Therefore, the larger the fluctuation rate of frequency is, the larger the energy level spacing of the equipotential surface, the more remarkable of its non-continuity and the stronger the force will be. Along with the quantum redshift, the frequency decrease, frequency fluctuation rate decreases, and the energy level spacing also decreases. Consequently, the far field energy level will show continuity, and the force will become weaker. It can be seen from equation

(25), when $r \rightarrow \infty$, $\omega = \omega_0$, no field exists. When r is close to zero, $\frac{\omega}{\omega_0} = 0$, namely, when the wavelength of particles is extremely small, the frequency will maintain unchanged, which is also called asymptotic freedom. From the angle of the quantization of space-time, it is not possible for above two cases to exist, because the wavelength of the quantum could neither be infinite, nor be zero. As a result, the above two cases could only approximately exist.

From above analysis, we can work out the relation schema between the total field intensity and the particle wavelength.

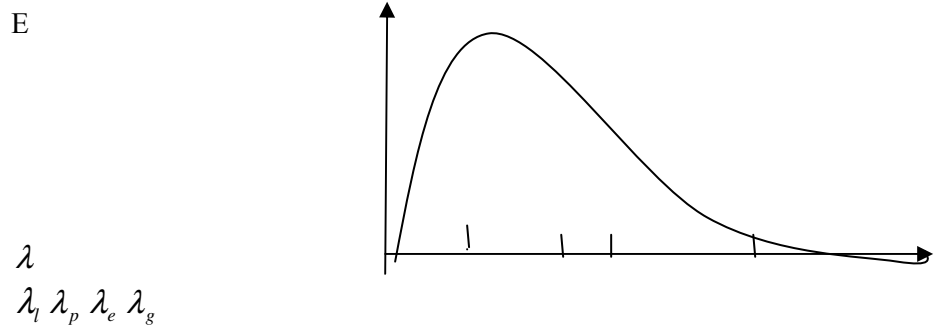

Here, λ_1 , λ_p , λ_e , and λ_g stands for Planck wavelength and wavelengths of proton, electron as well as graviton respectively. There are different fine structure constants on these points. Since the particle mass is discrete, the fine structure constant is also discrete. Each fine structure constant could only measure the strength of the section it represented, so the above figure is only the rough description.

By using fine structure constant, we can solve the energy level and field problems inside the hydrogen atom. Energy level or fields come from the quantum redshift caused by the energy quantum radiated from nucleus. Therefore

$$\frac{1}{\lambda_1} = \frac{1}{\lambda_e} (1 - q^2 / 4\pi\epsilon_0 m_e c^2 r)$$

When inertial field (blue shift) is generated by electron acceleration (transition), the change of wave number of quantum is as the following:

$$\frac{1}{\lambda_2} = \frac{1}{\lambda_1} (1 + q^2 / 4\pi\epsilon_0 m_e c^2 r)$$

The average total energy change of a redshift and a blue shift is

$$\frac{1}{\lambda} = \frac{1}{\lambda_e} \left\{ 1 - \frac{1}{2} (q^2 / 4\pi\epsilon_0 m_e c^2 r)^2 \right\} \quad (33)$$

Time-space is quantized, so when $r = n\lambda_e$, (here n could be either integer or fraction, when $n = 1, 2, 3, \dots$)

$$\frac{1}{\lambda} = \frac{1}{\lambda_e} \left\{ 1 - \frac{1}{2} (a^2 / n^2) \right\}$$

In the formula, a is fine structure constant. This is the energy level of hydrogen atom.

The anomalous magnetic moment of particles could be calculated by using fine structure constant.

Given r is the wavelength of the electron, namely, $r = \frac{h}{mc}$, then electron magnetic moment could be calculated by equation (25).

$$u_s = -u_0 \exp\left(-\frac{a}{2\pi}\right) \quad (34)$$

In the formula, a is fine structure constant, and u_0 is electronic inherent magnetic moment.

Since $\frac{a}{2\pi} \ll 1$, the above equation could be written as:

$$u_s = -u_0 \exp\left\{1 - \alpha/2\pi + 1/2(\alpha/2\pi)^2 - \dots\right\}$$

Since electron acceleration generates an inertial field, namely, positive electron, and a magnetic field. Inertial field restores the original field through blue shift, and generates a magnetic field again at the same time. It is an alternating process between positive and negative fields, so the above equation must be further corrected. We still make analogy of vacuum polarization of quantum electrodynamics and electron self-energy process:

So called vacuum polarization means the red shift of atomic nucleus after radiating a photon.

$$\omega_1 = \omega_0 \exp\left(-\frac{a}{2\pi}\right),$$

It accelerates electron and the acceleration generates an inertial field, namely positive electron, which further makes photon blue shift, and is equivalent to an absorption of the photons. Namely,

$$\omega_2 = \omega_1 \left(1 + \frac{a}{2\pi}\right) = \omega_0 - \omega_0 \left(\frac{a}{2\pi}\right)^2$$

$$\Delta\omega = \omega_0 - \omega_2 = \omega_0 \left(\frac{a}{2\pi}\right)^2$$

Or the probability is $\frac{\Delta\omega}{\omega_0} = \left(\frac{a}{2\pi}\right)^2$

The so called electron self-energy means electron is accelerated to emit virtual photon, generating a positive electron and a magnetic field. The virtual photon is blue shifted by positive electron, namely being absorbed, and its probability increases $\left(\frac{a}{2\pi}\right)^2$ times. If the

two processes above are continuous, then the probability is $\left(\frac{a}{2\pi}\right)^4$.

Since a field must have a reversed field, or a blue shift must be with a red shift, the remaining $\Delta\omega$ after the offset of both is accumulated, namely, path summing (quantum electrodynamics is path integral) is the track of particle. By using above methods, the mutual effect between light and matter and the mutual effect between electron and electron will not occur infinity, so it is not necessary to carry out renormalization. Reason for infinity occurred in quantum electrodynamics is that electron emission and assimilation of virtual photons must involve the change of electron mass and electric charge, while the red shift and blue shift only involves field. In other words, the electron acceleration has nothing to do with the mass and charge of electron. It is the equivalence principle of electromagnetic field.

Anomalous magnetic moment of protons and neutrons: we have got the fine structure constants of protons and neutrons respectively from equations of (27) and (28). Since protons have electric charge and natural magnetic moments, proton magnetic moment is $u_n = u_{n0}(1+1.79)$. In the formula, $1.79\mu_{n0}$ is anomalous magnetic moment. Neutron has neither charge nor natural magnetic moments, and its magnetic moment is $u_n = -1.91u_N$, all of which are anomalous magnetic moments.

By the same token, the fine structure constant of gravitational field could be used to calculate the curve of light movement and precession of perihelion of Mercury in gravitational field. Bending of the light and the precession of perihelion of Mercury are the results of the effect of gravitomagnetic field.

Given ω_0 is the frequency of incident photons, the frequency of photons after the effect of gravitational field is,

$$\omega = \omega_0 \exp(-GM/c^2 r) = \omega_0 (1 - GM / c^2 r)$$

G is the gravitational constant, M is the mass of stars, and r is the radius of stars. The average value of energy deviation in every degree of freedom is

$$\Delta\omega / \omega_0 = GM / c^2 r$$

For the reason that the movements of photons have four degrees of freedom, among which no one is superior to the others, namely, they are statistically independent, so the deflected angle of photons is

$$\frac{\Delta\omega}{\omega_0} = \frac{4GM}{c^2 r}$$

It must be pointed that when calculating the above red-shift, if not ignoring the small amount, the final result should have a modification of $(\frac{GM}{c^2 r})^2$.

$\frac{\Delta p}{p} = \frac{gr}{c^2}$ is the probability of Mercury's deviating from the normal track, so the deflected

radian in one degree of freedom of each circle around the sun is $\frac{2\pi GM}{c^2 r}$. However , among the three degrees of freedom, no one is superior than the others, namely, they are statistically

independent, so there must be $\frac{3 \times 2\pi GM}{c^2 r}$. To precisely calculate the procession of Mercury's

perihelion, small amount like $\left(\frac{GM}{c^2 r}\right)^2$ should be included. $\frac{GM}{c^2 r}$ is actually the irreversible part, so the procession is irreversible, namely, the part of entropy production, which is also the reason why procession is continuously cumulative.

12 Discussion about range of force and polarity

The repulsion problem of gravitational field: a positive field must be with a negative field. If the positive field is a field along with time, then the reversed field will be against time. We use Einstein elevator to explain this question.

When the lift goes free fall in the gravitational field of earth, acceleration would generate an inertial field with a reversed direction against the gravitational field. Given this inertial field is $g_{inertia}$, ignoring horizontal field $g_0 \approx -g_{inertia}$, we get

$$\omega = \omega_0 \exp[-(g_0 - g_{inertia})t / c] \quad (35)$$

$$\omega = \omega_0 \quad f = 0 \quad g = 0$$

Namely, the red-shift quantum forming gravitational field in the lift is blue-shifted by the inertial field with reversed direction. There is neither energy change under the first order approximation nor field in the lift. The objects in the lift have no acceleration and they are under zero gravity condition.

Now assuming when the lift is in the free fall in gravitational field, a force with the same direction and acceleration on the lift is exerted. According to the equivalence principle of acceleration and field, this new field will surely generate an inertial field superposed with the original inertial field. Then we get $g_{inertia} > g_0$, from

$$\omega = \omega_0 \exp[-(g_0 - g_{inertia})t / c]$$

$$f > 0$$

Namely, the quantum in the lift is blue-shifted, which means that the energy of system increases, and leads to a repulsion force. If the lift is completely closed, the person in the lift would feel there is a repulsion force between him and the floor of lift and he is making accelerated movement toward the top of lift.

Why gravitational field is rarely seen? This is actually a problem of probability. Red-shift has a larger probability than blue-shift. Because red-shift is a natural process in which energy is tending to a balance without external force, while the realization of blue-shift needs external force. Under natural state (not bound state), two electrons with the same nature are impossible to have repulsion force. One electron accelerating to the other one under external force would surely generate blue shift, generate repulsion force. So the blue-shift can't take place under natural state, and blue-shift is the cause of repulsion force.

If the mass (gravitational mass) which accelerates objects is positive mass, then the mass of accelerated objects (inertial mass) is negative mass. This negative mass is against time, just as the positive charge is an electric charge against time. Charge could only be distinguished between positive and negative in an electromagnetic field. It's meaningless to talk about the polarity of electron without field. Similarly, gravitational mass and inertial mass could only be distinguished in a field. The direction of gravitomagnetic fields (or called spin) generated by gravitational mass are different from the one generated by the inertial mass.

The quantization of space-time would certainly lead to the quantization of the range of force. From $f = -gk$ we can see there is a frequency variation in every wave vector interval,

namely, a recoil force. So the range of force is in direct proportion to the wavelength. The smaller the wavelength is, the shorter the range of force will be. The wavelength of interacting particle of strong and weak nuclear force is small, so it's a short-range force. Along with the red-shift of quantum, the wavelength increases, and its change is not apparent until it presents an approximate continuity, recoil force of single quantum getting close and range of force increasing, which is the reason why gravity or electricity are long-range forces.

13. Discussion about dark energy and dark matter

According to the cosmologic observation, the mass determined by aster orbital velocity is seriously inconsistent with the galaxy mass observed by direct counting and the former is ten times higher than the latter, which make people think there is a kind of dark matter. The mass determined by star orbital velocity is calculated on the basis of Newton's laws of motion. We know that Newton's laws of motion is supposed to be modified. Spectrum redshift

$$z = \frac{\Delta\omega}{\omega_0} = \frac{gr}{c^2} \quad (36)$$

According to Hubble's law:

$$z = \frac{H_0 r}{c} = \frac{r}{R} \quad (37)$$

H_0 is Hubble constant, and R is universe radius. Comparing the two formulas above we can get:

$$\frac{r}{R} = \frac{gr}{c^2}$$

$$g = \frac{c^2}{R} \approx 1.5 \times 10^{-10} (m/s^2)$$

This is the acceleration of cosmic expansion generated by gravitomagnetic field, which is not included in the Newtonian mechanics. So the Newtonian mechanics must be modified as follows:

$$g = g_{//} e^{-\frac{ar}{c^2}} \quad (38)$$

Under weak gravitational field or when $\frac{gr}{c^2} \ll 1$, the Taylor expansion of above equation keeps the second order approximation

$$g = g_{//} - g_{//} \frac{ar}{c^2} \quad (39)$$

The second item on the right is vertical field

$$g_{\perp} = \frac{GM}{r} \frac{a_{\perp}}{c^2}$$

Vertical field is perpendicular to the direction of propagation r and changes along with $1/r$. It depends on the acceleration of aster in a simple and direct form. Without acceleration, there is no such vertical field. Obviously, with the increase of spatial distance, the longitudinal field $g_{//}$ changing with $1/r^2$ disappears, and only vertical field is left.

It is just because Newton law of gravitation cannot explain the expansion acceleration of the universe; then people assume that there exists dark matter in addition to visible matter. When Newtonian mechanics is corrected, and gravitational field is taken as the result of

quantum redshift, the hypothesis of existence of dark matter becomes needless.

Actually, vertical field is the result of quantum redshift, and the redshift is an immediate inference of the second law of thermodynamics. In other words, redshift is the initial causation of generation of gravitational force. The so-called cosmic expansion is based on the theory of Doppler redshift. It indicates that the astral accelerated motion is the cause, and the redshift is the result. In the absence of external force, objects accelerate automatically. This is a process of entropy reduction, and it doesn't accord with the second law of thermodynamics. Therefore, we believe that it seems a little far-fetched to infer the existence of Doppler motion from quantum redshift, then arrive at the cosmic expansion, and consequently reach a conclusion of the existence assumption of dark energy.

Reference

Poincare, translated by Ye Yunli, Science and Hypothesis, Commercial Press, 1997, P92.

About the author: Xu Jianmin, male, born in February, 1960, native Beijing, a lawyer of Beijing Unitalen Law Office

Mailing address: Ya Yuan, Western Hill, Baijiatuan, Wenquan Town, Haidian District, Beijing, Tel. 13366005271

New Exploration for the Enigma of Paradox in Special Relativity

Dong Jingfeng

(Scientific and Technology Bureau in Rushi County, Henan Province, 472200, China)

Abstract : By the analysis of twin paradox, it is pointed out that the constriction of space-time is the only effect of measurement and all paradox do not exist actually. The essence of special relativity is a number method forways to provide math and physical idea. Experiments to verify special relativity have verified general relativity.

Keywords: Twin paradox, Time Standard, Measurement effect

Since the establishing special relativity by Einstein in 1905, a century has passed. So many experiments show that the theory is correct in very high precision. Special relativity has been used widely and become one of the most important foundations of modern physics. But meanwhile, so many paradoxes appears in the theory just as twin paradox, submarine paradox, slide paradox soft rope paradox, right-angle level paradox, the paradox of strict length limit, the paradox of seeing form of moving body and stress constriction of length and so on. Theses paradox caused furious argument and much diverge. The understanding for space-time constriction is very different: it is untrue, it is unphysical and true, it is apparent, mathematical, it is seeing effect, it is decided by measurement, it is a relative result of simultaneity and so on. Many beginners are puzzled by the space-time concepts of relativity and the relativity of simultaneity. It is necessary for us to make clear the essence of special relativity to eliminate theses paradox.

1 New explore for twin paradox

1.1 Definition of twin paradox

According to special relativity, suppose that new born twin A carried a digital clock A and was at rest at the original point of the airship reference system representing by the coordinate $oxyz$ (time coordinate is t). His brother B carried a digital clock B and was at rest at the original point of the earth reference system representing by the coordinate $OXYZ$ (time coordinate is T). Suppose that both reference systems are superposition each other at time $T_1 = t_1 = 0$, and the airship moved along $+X$ axis in speed u . When A is 20 years old, the airship returns along the same way. When airship arrived original place, according to Einstein's theory and without considering the change of speed from $+u$ to $-u$, A found that the recorded time of B clock was less and B is young than A . But B found that the recorded

time of A clock was less and A is younger than B . This is so-called twin paradox. The real situation would be that A clock was less and A is younger than B . This conclusion is recognized now (see document [1], page 60).

1.2 Analyzing on viewpoint of special relativity.

By consider the fact that the speed of airship changed from $+u$ to $-u$, the adherent of Einstein insists that both A and B are inertial systems in the process. They use the method deducting the effect of simultaneity to eliminate twin paradox. . This is called as the method of special relativity only to use the idea of special relativity (see document [1], page 60).

In fact, all so-called analyze, calculation and conclusion of special relativity on twin paradox are incorrect. The reasons are follows.

☐The so-called twin paradox is calculated by using formula $\Delta T = \gamma \cdot \Delta t$. But the formula is effect only under the $\Delta x = 0$ condition, $\Delta t \neq 0$ and $\Delta X = \gamma \cdot u \Delta t \neq 0$. When A returned to the earth, we have $\Delta X = 0$, so that the condition $\Delta X = \gamma \cdot u \Delta t \neq 0$ cannot be satisfied. The calculation is wrong.

☐As shown in Document [2], 77 ~ 78, many scholars try to explain twin paradox recurring to space-time diagram now. But they forget the basic and key conclusion which can be considered correct, that is there are different time standard on different reference frame. Because when airship swerved to return to the earth, its speeds and directions were different before and after swerved. So the time's reading of A clock are different before and after swerved. Because of neglecting the difference of speed, the adherent of Einstein calculate the new time standard in the swerved airship (according to special relativity, airship should be considered as two different inertial reference system with different speed before and after airship swerved.), so the result is certainly wrong.

☐ There are some scholars who try to explain twin paradox by the atomic clock traveling around the earth, the disk circumrotates and the μ meson fly to explain twin paradox (see Document [1]61 ~ 88pages). This is also wrong. So called twin paradox is calculated by time expansion formula $\Delta T = \gamma \cdot \Delta t$. But the formula $\Delta T = \gamma \cdot \Delta t$ is deduced based on the concept of inertial reference frame, so it is only suitable to inertial system. But the experiments just as atomic clock traveling around the earth are not on inertial system, so these experiments cannot verified twin paradox.

For this problem, some scholars consider that the orbit can be divided into infinite limited sect and each sect can be considered as inertial system, though the process of airship traveling around the earth is not inertial. Then by the integral of time quantum, we can still

obtain twin paradox (see Document [2], page 73 ~ 78, Document [1], page 61 ~ 88). This idea is also wrong, for the result of integral only represent the time sum of each sect of inertial processes. It does not represent the change of time standard caused by the change of speed from an inertial system into another inertial system. So the result of integral is incorrect, (the mistake is the same with \int). Some scholars consider that the relativity of time originates from the differences of time's direction. The time observed in the static reference frame is the time's projection of moving reference frame down to the static reference frame. So the person who travels by airship would be older for his time forms a curve. Meanwhile, the person who is at rest on the earth would be younger, for his time is linear. But this opinion is untrue. In fact, in light of Person A, his time is a linear, but in light of B, his time is curved.

The detail calculation above to use special relativity to explain the so-called twin paradox referees to the professor Shi Jiaoming's work 《The Enigma and Beauty of Dynamics》^[3].

2 The essence of special relativity

The most important distinguish between special relativity and classical mechanics is the definition of simultaneity. The essential difference between special relativity and classical mechanics is the definition of simultaneity. Though the simultaneity is implicated in classical mechanics, but there exists no sign which can propagate in infinite speed in practices, and we can only use light signal to adjust clocks in reality. In other word, the contraction of moving ruler and the slowing of moving clock are caused by our measurement using light as toll. If we do not use light as toll, or do no any measurement, there would have no effect happen. For a simple example, a man who is in an airship which moves in a high speed spend two minute to drink a cup of water by his measurement But the person on the ground thinks that the man on airship take longer time to drink water, because the person can only use light's single (which need time to propagate) to transform information for no infinite time setting signal. However, the time the man on airship takes to drink water does not change. In this way, twin paradox is easy to solve. No one of two twins becomes older actually though they think another's time becoming slow by measurement. If we do not think so, as an ideal experiment, we let the earth splitting into two parts, each one carry one of twins apart away in a high speed, then let them meet again. Which one is younger? No one can answer this problem if we do not consider problem as above. Based on this nature of special relativity, we can conclude that when an observer observes an object, owing to the difference of observational conditions (the motion state of observer's reference frame), he can reach completely different results (the constrictions of time and length). This result explains a principle of philosophy, i.e., condition decides law and observation.

By this character of special relativity, we prefer to consider it as a philosophic principle in the name of physics, that is, for an observer, the result of measurement is completely

different under different condition (i.e., the moving state of reference frame which observer located). It indicates a philosophic principle: condition decides law and measure results.

So the paradoxes of special relativity do not exist. Taken the submarine paradox as an example, we first suppose that a submarine submerged keeps balance without raising or sinking in sea water. Then suppose that the submarine moves in a speed nearing light's speed. Because the length would contract in the direction of motion, according to observers who are at rest on the surface of sea, the density of submarine would become great so that the submarine would sink. But according to the sailors who are in submarine, the sea water moves back off, and the density of sea water becomes great with greater buoyancy, so that submarine would be floated up. According to special relativity, two viewpoints are alright. What would be for submarine, sinking or floating? By our viewpoint, it is easy to decide. The contraction of sea water is only a measurement effect caused by observers in different reference frames. But there are constrictions or both submarine and sea water. The paradox of submarine does not exist actually.

So we can say that the essence of special relativity is only a method of mathematics. It exposures the connection of space and time and provides mathematic method and physical idea for general relativity.

3 Why does special relativity not represent practical space?

Because of the common existence of gravitation, there are always accelerations among any reference frames. We have no real inertial reference systems. The Lorentz transformation holds only for inertial reference systems which move in uniform speed. The experiment verification of special relativity should be carried out in the inertial reference systems which move in uniform speed, but this condition cannot be satisfied in practice.

The observation of modern astronomy shows that, men rotates with the earth, the earth rotates with the sun, the sun rotates with the Milky and Way galaxy rotates around its center. So there is no real inertial reference frame in the universe. The scale is bigger and material is thinner, the gravity is weaker and the reference frame is more nearly inertial reference frame. Even though the earth is considered as reference frame approximately, the experiments carried out on it cannot avoid the influence of acceleration. It is an unverifiable problem whether or not physical processes are the same in different inertial reference frames. Because there are the relative motions of experimental instrument and observers between two reference frames, if we want to verify the predication of special relativity, we should move the instrument and matter from one reference to another through accelerating or decelerating it. In this way, the non-inertial motions are involved. Because there are the motion processes of acceleration and deceleration, the physical effect cannot be explained by special relativity.

So speaking strictly, "the space-time in which special relativity holds is the space-time without material ^[4]". As we know that space-time is the most foundational form of material's existence. The space-time without material is only theoretical abstraction, or does not exist

actually. From this angle, special relativity is only a method of mathematics. It points out that the action of a universal constant c (light's speed) in the law of nature. The relativity of simultaneity is disclosed. The closed relation between time and space is uncovered by means of the four dimensions space-time and the Lorentz transformation. The invariability of four dimensions element ds^2 provides mathematical method and physical idea for general relativity. It should be pointed out that the mathematical method here indicates the calculation in "four dimensions", not mathematical tools. It is obvious that what used in special relativity are Euclidean geometry and algebra equation, but in general relativity, what used are non-Euclidean geometry and tensor analysis. The effects of special relativity are not dynamic ones, having nothing to do with the physical process of material and interaction force. It is only kinematical ones relative to correlation between objects, just as the multi-values of velocities [5].

4 The essence of experiments of special relativity is to verify the conclusion of general relativity

The space-time theory of special relativity does not relative to acceleration. It only considers the measurement relation of space-time between two references which are in inertial motion states. At first, we suppose that they are at rest each other and define the same unit time and length. Otherwise we cannot define the same unit time and length when two reference frames are at relative motion states. It is necessary for us to accelerate one of them if we want introduce relative velocity between two reference frames which are at rest each other at beginning. After acceleration stops and two frames reach the state of relative motion, the structure of space-time of accelerated frame would change^[6]. This process of acceleration can be explained by general relativity (the principle of equivalence), i.e., the frame can be considered to place into gravity field. All experimental condition in the earth does not satisfies the demand of inertial reference frame, why all experiments coincide with the predication of special relativity? The practical space-time is that of general relativity. The transformation of special relativity which is only ideal and linear one does not involve gravitation and acceleration. The ideal situation can only be approached but not be reached. Just known this localization of special relativity, Einstein developed general relativity. So speaking strictly, special relativity is an only mathematics to disclosure the retraction of material moving state on space-time as well as the closed connection between time and space. It provides a firm foundation of mathematics and physics for general relativity. By means of the equation of gravitational field, the space-time metric, and the energy and momentum of material motion are connected by general relativity. In this way, the law of object accelerated motion in gravitational field is obtained. General relativity is just the extension of special relativity.

In general relativity, the effects of rule becoming short and clock becoming slow is determined by the potential of gravity or the material distribution and motion. The measurement results of space-time have nothing to do with the choice of coordinate system.

What decides space-time is only the moving state of material. The does not depends on the difference of observations. So the effects of general relativity are absolute, which do not change with measurement method. The absoluteness is the real reason that special relativity acknowledge that the effects of clock being slow and mass increasing is measurement effects and the result verified by experiment is real effects and the objects moving in high speed have physical changes. In general relativity, the effects of “clock becoming slow and ruler becoming short” are the real result of dynamic, not measurement effect ^[7]. That is to say, the real reason to cause the changes of mass, length, time is acceleration or gravity fields.

5Conclusion

As we known that the effects of “ruler becoming short and clock becoming slow” in special relativity are caused by the change of observation condition. They have nothing to do with practical forms of observed objects. In other word, the practical forms do not changed under different conditions of observation. The “reality” of special relativity stays in the level of information, not in the ontological level. So many persons who discuss special relativity confuse the reality of the two levels. They consider the original explain of Einstein about “ruler becoming short and clock becoming slow” as a evidence to deny the reality of special relativity, or demote it as “explaining relativity using traditional idea”. In fact, most explanation about twin paradox, submarine paradox and so no are wrong. As long as considering “ruler becoming short and clock becoming slow” as measurement effects, all paradox would not appear.

Therefore, we cannot use special relativity to explain the experiments of atomic clock travel around the earth, μ meson decay and mass increase, for these physical phenomena represent the real change of objects which move in high speed. They are different from the observation effect of special relativity. We should use general relativity to explain them. The author thinks that there is a faultage between special relativity and general relativity. The theory existing in this faultage can explain these experiments simply and clearly without introducing any logical paradox. So the author hope that scholars are interesting in this problem and do further research. The influence of frame’s recti lineal and uniform motion on space-time structure is different from that of acceleration motion. Special relativity is only suitable for the reference frame which is in uniform motion. As soon as it oversteps this extent, special relativity would lose effect. Different from special relativity, general relativity is suitable to non-inertial motion to explain the physical events when reference frame does acceleration motion or in gravity fields. There is no any logical contraction and paradox to use general relativity to explain these experiments. The author hopes other scholar who are interesting in these problems to do further research.

References

[1] Zhang Yuanzhong, Experimental foundation of Special Relativity, Beijing, Science

Publishing Company, 1979.9.

- [2] Liu Liao, Zhang Yunzhong , Special Relativity, Shijiazhuang, Hebei Publishing Education Company, 1987.9.
- [3] Shi Jiaoming, Enigma and Beauty of Dynamics, [M], Hebei Science and Technology Publishing Company, 2007.8
- [4] Zhang Jialu, Relativity Physics, Thermodynamics and Statistical Physics, [M] Chinese Science and technology Publishing Company. 1990
- [5] Mei Xiaochun ,The Absolution of Velocity Caused by Acceleration Process and Absolute Theory of Space-time with Variable Scalar of Space-time [J],(Wait for publication of)
- [6] Xue Xiaochou, The philosophy Problems of Modern Physics [J] . Journal of Xinxiang Normal University (Version of Social Science), No.1, 1983
- [7] Zhang Zhengjiu, Modern Relativity and Black hole Physics, Wuhan, Huazhong Normal University Publishing Company 1986.8.
- [8] Cheng Jianguo, Dong Jingfeng, Understanding and Treatment Relativity Correctly, Advance Science, [J] No.3, 008.

About the author: The author is the Director of Scientific and Technology Bureau in Rushi County, Henan Province, the commissioner of Special Committee of Chinese Physical History, the visiting researcher of Institute of Innovative Physics in Fuzhou. The major area of the author's research is relativity, particle physics, atomic physics. As the master of partial committee, the author has attended 15 domestic and international meetings of physics, and has published more than 40 papers in Scientific Inquiry, Matter Regularity, Advance Science, Science, High Technology and Industrialization, Achievement of Science and Technology, Journal Of Shandong Normal University, Learned Foreland.

Tel: 15516323715, E-mail: dongjingfeng@sohu.com

Unsolved Problems in Special Relativity and Methods to Solve Them

Duan Zhongxiao

(Member of Beijing Relativity Theory Research Federation, Room 3-1-1, Building Jia-8, No.77, Dongmao Rd., Shenhe District, Shenyang, Liaoning, 110161, China)

(E-mail: pingsan11111@126.com)

Abstract: The special relativity is based on the principle of constant speed of light and the assumption that the inertial systems are all “Equality (Equal Right)”. However, through comparing the two Lorentz transformations located at different regions, the author finds that for two inertial systems running the relative uniform speed translational motion, if two clocks are synchronous in one system, they are also synchronous looked from another system; this means that the relative character of simultaneity is not the ultimate source of temporal and spatial transformation. Thus we know that it is wrong to introduce the one-way spreading light signals along with all directions in space into transformation. Based on this the further analysis proposes that, all the above mentioned problems can be solved only in the way that theoretically introducing the vacuum matter, vacuum energy, as well as the two-way spreading vacuum matter waves along with any directions in space. According to an important characteristic of the Lorentz transformation, namely the continuous transformations will be equivalent to one certain transformation, the author deeply considers the “Equality” of inertial systems and concludes that, the principle of relativity and the “Equality” of inertial systems are two entirely different things, the principle of relativity is correct, but the “Equality” is wrong. Based on the above discussions, the author also finds many problems and errors in the special relativity (for details see the text of this paper). On this basis, the author already established “The Matter Space-time Theory of Relativity” (“Matter Theory” for short). “Matter Theory” is based on the matter space only. The two principles and other assumptions are no longer needed. “Matter Theory” overcomes almost all the problems and errors in special relativity, explains all the contents that can be explained by special relativity, and presents many new predictions, such as the conclusions of “Matter Theory” show that not only the moving clock will slow down, but also all the inertial systems running the relative uniform speed translational motion will have the characteristics of multi-level of space-time. Besides this paper, other results can be found in reference [1].

Keywords: Matter space, vacuum matter wave, principle of relativity, application condition of the principle of relativity, inertia reference system

1 Vacuum’s matter space essence and basic characteristics

1.1 Using Lorentz transformation to discuss vacuum’s matter space essence

Looking at the single Lorentz transformation alone, vacuum's matter space essence and its action cannot be reflected in the transformation. Because as long as theoretically introducing the light signal and based on the hypothesis of "Equality", then the Lorentz transformation can be established. However, when we compare the two Lorentz transformations in different regions, the matter space and its action in the transformation are obvious.

Supposing that the space is uniform and isotropic, thus the transformation rule is not restricted by time, region and direction. In this aspect the actual performance is as follows: The experiment to test the validity of theory is not restricted by time, region and direction also. For different times, different regions and different directions, doing the same experiments, if the theory is correct and the experimental procedure is perfect also, thus the results must be the same.

This objective fact can be described more strictly theoretically.

The Lorentz transformation is based on the Cartesian rectangular coordinate system, this coordinates system is formed by the origin of coordinates and three frame straight lines. However a very simple fact is, the origin is chosen arbitrarily, and not restricted by the spatial location. Therefore, the frames are also chosen arbitrarily, and not restricted by the spatial location.

Starting from this fact to discuss the problem, we find that the matter space is existed really, and the action of matter space in transformation is irreplaceable.

Supposing that there are two inertial systems Σ_A and Σ_B running the relative uniform speed translational motion, and the speed of Σ_B relative to Σ_A is v .

Choosing anyone straight line in Σ_A and taking this line as the x coordinate axis in the three coordinate systems to be established below. From this line arbitrarily choosing different three points O_A , O_{A1} , and O_{A2} , and taking these three points as three origins. Thus in Σ_A we have established three Cartesian rectangular coordinate systems, namely $\Sigma_A (x_A, y_A, z_A, t_A)$, $\Sigma_{A1} (x_{A1}, y_{A1}, z_{A1}, t_{A1})$, and $\Sigma_{A2} (x_{A2}, y_{A2}, z_{A2}, t_{A2})$.

Similarly, choosing anyone straight line in Σ_B and taking this line as the x coordinate axis in the three coordinate systems to be established below. From this line arbitrarily choosing different three points O_B , O_{B1} , and O_{B2} , and taking these three points as three origins. Thus in Σ_B we have established three Cartesian rectangular coordinate systems, namely $\Sigma_B (x_B, y_B, z_B, t_B)$, $\Sigma_{B1} (x_{B1}, y_{B1}, z_{B1}, t_{B1})$, and $\Sigma_{B2} (x_{B2}, y_{B2}, z_{B2}, t_{B2})$.

In order to simplify the discussion, further provisions are as follows:

1) The x coordinate axis in the coordinate system Σ_B is also the x axis in Σ_A , and they have the same direction;

2) The movement of Σ_B is relative to Σ_A along the positive direction of the common x axis (in order to prove that the transformation rule is not restricted by the direction, we should

also discuss the case that Σ_B is relative to Σ_A along the negative direction of the common x axis, but the process and result are the same to the case of positive direction, therefore we will not discuss it);

3) In Σ_A and Σ_B , for all the cases, the coordinates y and z are all equal to zero;

4) Supposing that as $t_A = t_B = 0$ for the time in Σ_A and time in Σ_B , O_A is superposed on O_B , O_{A1} is superposed on O_{B1} , and O_{A2} is superposed on O_{B2} (this moment, $t_A = t_{A1} = t_{A2} = 0$ and $t_B = t_{B1} = t_{B2} = 0$).

Therefore at the time t_{A1} in Σ_{A1} , the Lorentz transformation between Σ_{A1} and Σ_{B1} is as follows:

$$x_{B1} = \gamma(x_{A1} - vt_{A1}) \quad (1.1-1)$$

$$t_{B1} = \gamma\left(t_{A1} - \frac{vx_{A1}}{c^2}\right) \quad (1.1-2)$$

At the time t_{A2} in Σ_{A2} , the Lorentz transformation between Σ_{A2} and Σ_{B2} is as follows:

$$x_{B2} = \gamma(x_{A2} - vt_{A2}) \quad (1.1-3)$$

$$t_{B2} = \gamma\left(t_{A2} - \frac{vx_{A2}}{c^2}\right) \quad (1.1-4)$$

Supposing that at the time t_A in Σ_A , the time in Σ_{A1} is t_{A1} , and the time in Σ_{A2} is t_{A2} . Because for the same inertial system, the clocks are synchronous, therefore we have: $t_A = t_{A1} = t_{A2}$.

For the reason that the light signal is also assumed arbitrarily, it is not restricted by the time and region. Therefore, when we assume that one light signal is radiated from the origin O_A , we can also assume that at this time other two light signals are radiated from O_{A1} and O_{A2} respectively, and at the time t_A in Σ_A we have: $x_A = x_{A1} = x_{A2} = ct_A = ct_{A1} = ct_{A2}$.

Substituting $x_{A1} = x_{A2}$, $t_{A1} = t_{A2}$ into Eq. (1.1-3) and Eq. (1.1-4), we can get

$$x_{B2} = \gamma(x_{A1} - vt_{A1}) \quad (1.1-5)$$

$$t_{B2} = \gamma\left(t_{A1} - \frac{vx_{A1}}{c^2}\right) \quad (1.1-6)$$

To compare Eq. (1.1-1) with Eq. (1.1-5), and compare Eq. (1.1-2) with Eq. (1.1-6), we can get

$$x_{B1} = x_{B2}, t_{B1} = t_{B2} \quad (1.1-7)$$

Substituting Eq. (1.1-7) into Eq. (1.1-3), Eq. (1.1-4), we can get

$$x_{B1} = \gamma(x_{A2} - vt_{A2}) \quad (1.1-8)$$

$$t_{B1} = \gamma\left(t_{A2} - \frac{vx_{A2}}{c^2}\right) \quad (1.1-9)$$

For the reason that x_{B1} and x_{B2} are located at the different regions of Σ_B , therefore the clocks used to measure t_{B1} and t_{B2} are also located at different regions. For the same inertial system the clocks are synchronous, therefore the two clocks are synchronous in Σ_B . To compare Eq. (1.1-2) with Eq. (1.1-6), we know that, observing from Σ_A , the clock used to measure t_{B1} and the one to measure t_{B2} are also synchronous, then we can get the following conclusions:

1) For two inertial systems running the relative uniform speed translational motion, if the clocks are synchronous in one system, observing from another system they are still synchronous.

2) The relative character of simultaneity is not the ultimate source of the rule of temporal and spatial transformation. Namely, the relative character of simultaneity serves no useful purpose to the rule of temporal and spatial transformation.

3) It is wrong to introduce the one-way spreading light signals along with all directions into transformation equation, and the relative character of simultaneity is nothing but the apparent phenomenon appeared by introducing the one-way spreading light signal into the equation.

4) Although the rates of the clocks in two systems running the relative uniform speed translational motion may be different, the ratio of the rates of the clocks in two systems is absolute. Therefore, the temporal and spatial transformation will not be reversible.

5) All the temporal and spatial transformations are not originated from the relative motion of physical system.

6) Although the principle of relativity is correct, while the assumption that the inertial systems are all "Equality (Equal Right)" is wrong.

We would like to emphasize several points in the above discussion, because they decide the main features of the transformation rules.

1) The t_A (including t_{A1} , t_{A2}) in Σ_A , the t_B (including t_{B1} , t_{B2}) in Σ_B , represent arbitrary times in Σ_A , Σ_B . This indicates that the temporal and spatial transformation rules and their

actions are not restricted by time, they are existed eternally, and affect the rules of physical state changes in the physical system.

2) In Σ_A the origins of coordinates of Σ_{A1} , Σ_{A2} are arbitrary non-superposed space points in Σ_A ; in Σ_B the origins of coordinates of Σ_{B1} , Σ_{B2} are arbitrary non-superposed space points in Σ_B . Therefore the consistencies of above transformation rules (such as the consistencies of Eq. (1.1-1), Eq. (1.1-2) and Eq. (1.1-5), Eq. (1.1-6)) show that the transformation rules are not restricted by the spatial locations (namely the coordinate's locations).

The more in-depth discussion on this content will present the more definite conclusions as follows.

The temporal and spatial transformations between two systems running the relative uniform speed translational motion exactly are the transformations between arbitrary space points in one system and arbitrary space points in another system.

Our discussions are carried out in the uniform isotropic space, therefore $x_{A1}, x_{A2}, x_{B1}, x_{B2}$ and $(x_{A1} - vt_{A1}), (x_{A2} - vt_{A2})$ can be interpreted as the set of points, and based on this we can get the above conclusions by means of brief discussion.

3) In the above discussion we assume that the movement of Σ_B is running along with the positive direction of the common x axis. If we assume that the movement of Σ_B is running along with the negative direction of the common x axis, or changing the direction of x axis and the direction of signal propagation, we can get the same results as above conclusions.

This means that the transformation rules are not restricted by direction.

In the above discussion, for the transformation equation, we deny the action of light signals (one-way spreading along with all directions in space), but we do not deny the status and action of c in the transformation equation. This requires us to give c a new physical content.

In the transformation, if the action of c is irreplaceable, then from the basic characteristics of the transformation roles we can get:

1) The action of c must not be restricted by time, and not restricted by spatial position and direction; namely the actions of c are existed at anywhere and anytime, and effected on the transformation rules eternally. This action of c fully explains its characteristics of matter space. That means that c is the energy wave of matter space, and we name this wave the vacuum matter wave.

2) In order to ensure the transformation rules do not appear the problems of the relative character of simultaneity, and ensure the transformation rules are not restricted by directions, the spreading of vacuum matter wave along with all directions in space must be two-way.

3) In order to ensure the relativistic effects of transformation rules (such as the rule of moving clock slows down), the vacuum matter wave's propagation velocity must be limited.

4) In order to ensure the transformation rules are always identical, and not restricted by time and space (namely all the transformations between any space point in one system and

any space point in another system are identical), the spreading rates of vacuum matter waves must be always identical at anywhere and anytime, and in the inertial systems running the relative uniform speed translational motion, the vacuum matter waves' propagation velocities must be invariable (measured by each system's clock and measuring ruler).

1.2 Theoretical foundation of vacuum matter, vacuum energy and vacuum matter wave

Based on the above discussions we can get the basic characteristics of matter space:

1) In vacuum the mass points with energy are uniformly distributed. The mass point's energy is spreading outward in the form of spherical wave. Therefore, each mass point not only is spreading energy outward, but also receiving energy. This determines that the wave is two-way spreading along with any direction in space. These matter, energy and energy wave are named vacuum matter, vacuum energy and vacuum matter wave by us.

2) The vacuum matter waves are existed at anywhere and anytime; and spreading with the limited invariable rate at anywhere and anytime. The spreading rate of vacuum matter wave is indicated as c_m .

3) The spreading rates of vacuum matter waves in the inertial systems running the relative uniform speed translational motion are all equal to c_m (measured by each system's clock and measuring ruler).

It should be noted that "The Matter Space-time Theory of Relativity" ^[1] ("Matter Theory" for short) is based on the matter space and vacuum matter wave, the two principles and other assumptions are no longer needed.

2 Discussion on the application conditions of the principle of relativity

The author affirms the principle of relativity, but also proves that the application of principle of relativity is conditional, while in the past this is not clear for many people. One of the important reasons created the unsolved problems in special relativity is unclear for the application conditions of the principle of relativity.

Although in the past many people do not know the application conditions of the principle of relativity, but the correct theory and the correct parts of theory can be established with the prerequisite to conform the application conditions of the principle of relativity. The correct experiments testing theory are all in progress with the prerequisite to conform the application conditions of the principle of relativity.

The principle of relativity tells us that, in all inertial systems running the relative uniform speed translational motion, the laws of physics are identical in the mathematical form. But both the establishment of laws of physics and the experiments testing theory must contain two

contents: 1) The observer and the inertial system at which the observer is located; 2) The observation object (or experiment object).

The principle of relativity does not tell us that, whether or not all the physical objects running the uniform speed translational motion relative to a certain inertial system will obey the laws of physics established in this inertial system (for all the inertial systems the laws are identical in the mathematical form). It also does not tell us that, in all the inertial systems running the uniform speed translational motion relative to a certain physical object, whether or not all the observing results about this physical object will obey the laws of physics established in each inertial system (for all the inertial systems the laws are identical in the mathematical form).

The following discussions will show that, for specific physical object, there are two types of different inertial systems. The first one can make the correct observation and description about the physical state changing rule of this physical object, while the second cannot. In order to distinguish these two types of inertial systems, the first one is called the inertial reference system of this physical system (in the past, the inertial system and the inertial reference system are not distinguished).

After the deep discussion on the transformation between the two inertial systems running the relative uniform speed translational motion, we can get:

1) In all the inertial systems running the relative uniform speed translational motion, the laws of physics with identical mathematical form are all established between the physical system and its inertial reference system;

2) For the two inertial systems Σ_A and Σ_B , running the relative uniform speed translational motion, if Σ_A is the inertial reference system of Σ_B , definitely Σ_B is not the inertial reference system of Σ_A .

These two sections are the application conditions of the principle of relativity.

The application conditions of the principle of relativity are not the theoretical foundation, but they are the prerequisite for establishing the theory, before the establishment of theory, we must stress that the theory should be consistent with the application conditions of the principle of relativity, otherwise the theory will not be valuable.

We will make the concrete argument below.

Supposing that there are three inertial systems, $\Sigma_A (x_A, t_A)$, $\Sigma_B (x_B, t_B)$ and $\Sigma_C (x_C, t_C)$, mutually running the relative uniform speed translational motion. Further assuming that the speed of Σ_B relative to Σ_A is v_1 , the speed of Σ_C relative to Σ_A is v_2 , and $v_2 > v_1$, the speed of Σ_C relative to Σ_B is w . For the sake of convenient, we make the following provisions:

1) Supposing that the three x axes of Σ_A , Σ_B and Σ_C are superposed.

2) Σ_B and Σ_C are moving along with the positive direction of the x axis of Σ_A .

From the Lorentz transformation we can get:

The transformation equations between Σ_A and Σ_B are as follows

$$x_B = \gamma(x_A - v_1 t_A) \quad (2-1) \quad t_B = \gamma\left(t_A - \frac{v_1 x_A}{c^2}\right) \quad (2-2)$$

The inverse transformation equations are as follows

$$x_A = \gamma(x_B + v_1 t_B) \quad (2-3) \quad t_A = \gamma\left(t_B + \frac{v_1 x_B}{c^2}\right) \quad (2-4)$$

The transformation equations between Σ_A and Σ_C are as follows

$$x_c = \gamma'(x_A - v_2 t_A) \quad (2-5) \quad t_c = \gamma'\left(t_A - \frac{v_2 x_A}{c^2}\right) \quad (2-6)$$

The inverse transformation equations are as follows

$$x_A = \gamma'(x_c + v_2 t_c) \quad (2-7) \quad t_A = \gamma'\left(t_c + \frac{v_2 x_c}{c^2}\right) \quad (2-8)$$

The transformation equations between Σ_B and Σ_C are as follows

$$x_c = \gamma''(x_B - w t_B) \quad (2-9) \quad t_c = \gamma''\left(t_B - \frac{w x_B}{c^2}\right) \quad (2-10)$$

The inverse transformation equations are as follows

$$x_B = \gamma''(x_c + w t_c) \quad (2-11) \quad t_B = \gamma''\left(t_c + \frac{w x_c}{c^2}\right) \quad (2-12)$$

Supposing that Eq. (2-1), (2-2), (2-5), (2-6), (2-9), (2-10) are all correct.

Substituting Eq. (2-1) and Eq. (2-2) into Eq. (2-9), we can get

$$x_c = \gamma'' \left[\gamma(x_A - v_1 t_A) - w \gamma \left(t_A - \frac{v_1 x_A}{c^2} \right) \right] = \gamma'' \gamma \left(x_A - \frac{w + v_1}{1 + \frac{w v_1}{c^2}} t_A \right) \left(1 + \frac{w v_1}{c^2} \right) \quad (2-13)$$

13)

Because $\gamma'' = \frac{1}{\sqrt{1 - \frac{w^2}{c^2}}}$; $\gamma = \frac{1}{\sqrt{1 - \frac{v_1^2}{c^2}}}$, so Eq. (2-13) can be written as

$$x_c = \frac{\left(x_A - \frac{w+v_1}{1+ww_1/c^2} t_A \right) (1+ww_1/c^2)}{\sqrt{(1-w^2/c^2)(1-v_1^2/c^2)}} = \frac{\left(x_A - \frac{w+v_1}{1+ww_1/c^2} t_A \right)}{\sqrt{1 - \frac{(w+v_1)^2}{(1+ww_1/c^2)^2 c^2}}} \quad (2-$$

14) Supposing

$$u = \frac{w+v_1}{1 + \frac{ww_1}{c^2}} \quad (2-15)$$

Substituting Eq. (2-15) into Eq. (2-14) , we can get

$$x_c = \frac{(x_A - ut_A)}{\sqrt{1 - u^2/c^2}} \quad (2-16)$$

Because the continuous transformations will be equivalent to one certain transformation, comparing Eq. (2-16) with Eq. (2-5), we can get

$$v_2 = u = \frac{w+v_1}{1+ww_1/c^2} \quad (2-17)$$

Supposing that the inverse transformation equations between Σ_B and Σ_C are correct, substituting Eq. (2-5) and Eq. (2-6) into Eq. (2-11) , it gives

$$\begin{aligned} x_B &= \gamma'' \left[\gamma'(x_A - v_2 t_A) + w \gamma'(t_A - \frac{v_2 x_A}{c^2}) \right] \\ &= \gamma'' \gamma' \left(x_A + \frac{w-v_2}{1-ww_2/c^2} t_A \right) (1-ww_2/c^2) \quad (2-18) \end{aligned}$$

Substituting $\gamma'' = \frac{1}{\sqrt{1-w^2/c^2}}$; $\gamma' = \frac{1}{\sqrt{1-v_2^2/c^2}}$ into Eq. (2-18) , it gives

$$x_B = \frac{\left(x_A + \frac{w-v_2}{1-ww_2/c^2} t_A \right) \left(1 - \frac{ww_2}{c^2} \right)}{\sqrt{(1-w^2/c^2)(1-v_2^2/c^2)}} = \frac{\left(x_A + \frac{w-v_2}{1-ww_2/c^2} t_A \right)}{\sqrt{1 - \frac{(w-v_2)^2}{(1-ww_2/c^2)^2 c^2}}} \quad (2-19)$$

Supposing

$$u' = \frac{w - v_2}{1 - wv_2 / c^2} \quad (2-20)$$

Substituting Eq. (2-20) into Eq. (2-19), it gives

$$x_B = \frac{(x_A + u't_A)}{\sqrt{1 - u'^2 / c^2}} \quad (2-21)$$

Because the continuous transformations will be equivalent to one certain transformation, comparing Eq. (2-21) with Eq. (2-1), we can get

$$v_1 = -u' = -\frac{w - v_2}{1 - wv_2 / c^2} \quad (2-22)$$

Substituting Eq. (2-17) into Eq. (2-22), it gives

$$v_1 = -\frac{w - \frac{w + v_1}{1 + wv_1 / c^2}}{1 - w \left(\frac{w + v_1}{1 + wv_1 / c^2} \right) / c^2} \quad (2-23)$$

In order to guarantee Eq. (2-23) is correct, only in the case that $w = 0$, however, from the initial assuming we know that $w \neq 0$, so Eq. (2-23) is not correct. Eq. (2-23) is not correct means that either Eq. (2-17) is not correct, or Eq. (2-22) is not correct, and both may be not correct. Eq. (2-17) is derived by comparing Eq. (2-16) with Eq. (2-5), while Eq. (2-5) is from the first set of transformation equation, we already assume that the first set of transformation equation should be correct, so Eq. (2-5) is correct. Eq. (2-16) is derived by both of Eq. (2-14) and Eq. (2-15), both of Eq. (2-14) and Eq. (2-15) are derived by three of Eq. (2-1), Eq. (2-2), and Eq. (2-9). Eq. (2-1), Eq. (2-2) and Eq. (2-9) are from the first set of transformation equation. We already assume that the first set of transformation equation should be correct, so Eq. (2-1), Eq. (2-2) and Eq. (2-9) are correct, therefore Eq. (2-16) is correct. This means that Eq. (2-17) is correct.

From the above discussion we know that, Eq. (2-23) is not correct only means that Eq. (2-22) is not correct. While Eq.(2-22) is derived by comparing Eq.(2-21) with Eq.(2-1), however, from the initial assuming we know that Eq.(2-1) is correct, so Eq.(2-22) is not correct only means that Eq.(2-21) is not correct, Eq.(2-21) is derived by both of Eq.(2-20) and Eq.(2-19), both of Eq.(2-20) and Eq.(2-19) are derived by three of Eq.(2-5), Eq.(2-6) and Eq.(2-11), we already assume that both of Eq.(2-5) and Eq.(2-6) are correct, so Eq.(2-21) is not correct only means that Eq.(2-11) is not correct.

From the results of above discussion we can get the conclusions as follows.

In the case that supposing that the first set of Lorentz transformation equations Eqs. (2-1), (2-2), (2-5), (2-6), (2-9), (2-10) are all correct, then the inverse transformation equations

Eq. (2-11) and Eq. (2-12) between Σ_B and Σ_C will not be correct. While Σ_B and Σ_C are two arbitrary inertial systems running the relative uniform speed translational motion, so the above results show that, between the two inertial systems running the relative uniform speed translational motion, if one set of Lorentz transformation equations are correct, then another set of transformation equations will not be correct. This conclusion has proven that for two arbitrary inertial systems running the relative uniform speed translational motion, they cannot be “Equality (Equal Right)”. This conclusion is derived in the case that supposing that the first set of Lorentz transformation equations Eqs. (2-1), (2-2), (2-5), (2-6), (2-9), (2-10) are all correct, if they are really correct, then the above conclusion must be correct. However the purpose of our discussion is to prove that for two arbitrary inertial systems running the relative uniform speed translational motion, they cannot be “Equality (Equal Right)”. If that is really true, then the Lorentz transformations cannot be mutually inverse. This means that in the Lorentz transformation equations, only one set of transformation equation are correct. But before the new theory is established, for the two sets of transformation equation (including the inverse transformation equation), we don't know which one is correct. Therefore, we would also like to assume that another set of Lorentz transformation (inverse transformation) are correct, and use this set of transformation to discuss the problem of inertial systems’ “Equality (Equal Right)”. If this discussion gives the same result as given in the previous conclusion, it will be proven that regardless of which set of transformation equation are correct, the conclusions are the same, namely: In the two sets of Lorentz transformation equations, if one set are correct, the another set must not be correct. So, for two arbitrary inertial systems running the relative uniform speed translational motion, they cannot be “Equality (Equal Right)”.

Supposing that the inverse transformation equations Eqs. (2-3), (2-4), (2-7), (2-8), (2-11), (2-12) are correct, substituting Eq. (2-11) and Eq. (2-12) into Eq. (2-3), it gives

$$x_A = \gamma \left[\gamma'' (x_c + wt_c) + v_1 \gamma'' (t_c + wx_c / c^2) \right]$$

Because $\gamma = \frac{1}{\sqrt{1 - v_1^2 / c^2}}$; $\gamma'' = \frac{1}{\sqrt{1 - w^2 / c^2}}$, so it can be written as follows

$$x_A = \frac{(x_c + \frac{w + v_1}{1 + wv_1 / c^2} t_c)(1 + wv_1 / c^2)}{\sqrt{(1 - v_1^2 / c^2)(1 - w^2 / c^2)}} = \frac{x_c + \frac{w + v_1}{1 + wv_1 / c^2} t_c}{\sqrt{1 - \frac{(w + v_1)^2}{(1 + wv_1 / c^2)^2} c^2}} \quad (2-24)$$

Supposing

$$u = \frac{w + v_1}{1 + wv_1 / c^2} \quad (2-25)$$

Substituting Eq. (2-25) into Eq. (2-24), it gives

$$x_A = \frac{(x_c + ut_c)}{\sqrt{(1 - u^2 / c^2)}} \quad (2-26)$$

Comparing Eq. (2-26) with Eq. (2-7), we can get

$$v_2 = u = \frac{w + v_1}{1 + wv_1 / c^2} \quad (2-27)$$

Substituting Eq. (2-9) and Eq. (2-10) into Eq. (2-7), it gives

$$\begin{aligned} x_A &= \gamma' \left[\gamma'' (x_B - wt_B) + v_2 \gamma'' (t_B - wx_B / c^2) \right] \\ &= \frac{(x_B - \frac{w - v_2}{1 - wv_2 / c^2} t_B) (1 - wv_2 / c^2)}{\sqrt{(1 - v_2^2 / c^2) (1 - w^2 / c^2)}} = \frac{x_B - \frac{w - v_2}{1 - wv_2 / c^2} t_B}{\sqrt{1 - \frac{(w - v_2)^2}{(1 - wv_2 / c^2)^2 c^2}}} \quad (2-28) \end{aligned}$$

Supposing

$$u' = \frac{w - v_1}{1 - wv_2 / c^2} \quad (2-29)$$

Substituting Eq. (2-29) into Eq. (2-28), we can get

$$x_A = \frac{(x_B - u' t_B)}{\sqrt{(1 - u'^2 / c^2)}} \quad (2-30)$$

Comparing Eq. (2-30) with Eq. (2-3), it gives

$$v_1 = -u' = -\frac{w - v_2}{1 - wv_2 / c^2} \quad (2-31)$$

Substituting Eq. (2-27) into Eq. (2-31), we can get

$$v_1 = -\frac{w - \frac{w + v_1}{1 + wv_1 / c^2}}{1 - \frac{w \left(\frac{w + v_1}{1 + wv_1 / c^2} \right)}{c^2}} \quad (2-32)$$

In order to guarantee Eq. (2-32) is correct, only in the case that $w = 0$, however, from the initial assuming we know that $w \neq 0$, so Eq. (2-32) is not correct. Eq. (2-32) is derived

by Eq. (2-31) and Eq. (2-27) , Eq. (2-32) is not correct means that either Eq. (2-31) is not correct, or Eq. (2-27) is not correct, and both may be not correct. Eq.(2-27) is derived by comparing Eq.(2-26) with Eq.(2-7), while Eq.(2-26) is derived by Eqs. (2-11), (2-12), (2-3), Eqs. (2-11), (2-12), (2-3), (2-7) are all inverse transformation equations, we already assume that the inverse transformation equations should be correct, so Eqs. (2-11), (2-12), (2-3), (2-7) are all correct. Therefore Eq.(2-27) is correct. Hence Eq.(2-32) is not correctly means that Eq.(2-31) is not correct. While Eq.(2-31) is derived by Eq.(2-3) and Eq.(2-30), Eq.(2-3) is the inverse transformation equation, we already assume that the inverse transformation equations should be correct, so Eq.(2-3) is correct. Hence Eq.(2-31) is not correct means that Eq.(2-30) is not correct. While Eq.(2-30) is derived by Eq.(2-7), Eq.(2-9) and Eq.(2-10), while Eq.(2-7) is the inverse transformation equation, we already assume that Eq.(2-7) is correct, so Eq.(2-30) is not correct only means that Eq.(2-9) and Eq.(2-10) are not correct.

The results of above discussion show that, between Σ_B and Σ_C , if Eq.(2-11) and Eq.(2-12) are correct, then Eq.(2-9) and Eq.(2-10) will not be correct. The results of discussion show again that in the two sets of Lorentz transformation equations, if one set are correct, the another set must not be correct.

Synthesizing all the above discussions we can get the conclusions as follows:

1) Between arbitrary two inertial systems running the relative uniform speed translational motion, the transformation equations cannot be mutually inverse.

2) For two arbitrary inertial systems running the relative uniform speed translational motion, they cannot be “Equality (Equal Right)”.

If Σ_A and Σ_B are two inertial systems running the relative uniform speed translational motion, from the principle of relativity we know that, in both of Σ_A and Σ_B , the laws of physics with the same mathematical form can be established. However, the above two conclusions tell us that, if the temporal and spatial changing rules established in Σ_B will agree with the transformation equation established in Σ_A , then the temporal and spatial changing rules established in Σ_A will not agree with the transformation equation established in Σ_B . If the physical state changing rules of a physical system agree with the laws of physics established in a certain inertial system, then we say that this inertial system is the physical system's inertial reference system. (In the past, many people do not know the application conditions of the principle of relativity, so the inertial system and the inertial reference system are not distinguished.)

According to the above discussion we can induce as follows:

1) In all the inertial systems running the relative uniform speed translational motion, the laws of physics with identical mathematical form are all established between the physical system and its inertial reference system;

2) For the two inertial systems Σ_A and Σ_B , running the relative uniform speed translational motion, if Σ_A is the inertial reference system of Σ_B , definitely Σ_B is not the inertial reference system of Σ_A .

These two sections are the application conditions of the principle of relativity.

The application conditions of the principle of relativity are not the theoretical foundation, but they are the prerequisite for establishing the theory, before the establishment of theory, we must stress that the theory should be consistent with the application conditions of the principle of relativity, otherwise the theory will not be valuable.

According to the above conclusions we can get the following deduces:

1) The temporal and spatial transformations are not from the relative motion of the physical system, but from the motion of the physical system relative to its inertial reference system.

2) The so-called matter space is also the inertial reference system space.

3) The temporal and spatial transformation rules have nothing to do with the relative character of simultaneity.

4) It is wrong to introduce the one-way spreading light signals along with all directions in space into equation.

3 Brief Introduction to “The Matter Space-time Theory of Relativity”

“The Matter Space-time Theory of Relativity” (“Matter Theory” for short) is the theory established to solve many unsolved problems in special relativity. “Matter Theory” is based on the matter space only. The principle of constant speed of light, the principle of relativity and other assumptions are no longer needed. “Matter Theory” overcomes almost all the unsolved problems in special relativity, explains all the physical phenomena and experiments that can be explained by special relativity, and presents many new predictions. Here we take the temporal and spatial transformations as examples to explain the following problems. The temporal and spatial transformations of “Matter Theory” show that not only the moving clock will slow down, but also the same inertial system space will have the characteristics of multi-level of space-time. For different levels of space-time, the clock rates are different, the masses are different, and the energies are also different, but there is not the contraction of moving ruler. Although we have the multi-level of space-time, for each level, the space is always three-dimensional, the time is always one-dimensional. The indivisible four-dimensional space-time does not exist in the world of objective reality. Of course, also there are not the phenomena of time-like interval, space-like interval, time sequence reverse, cause and effect reverse, and so on. These errors are the apparent phenomena resulting from special relativity introduced one-way spreading light signals along with all directions in space.

The special relativity is a systematic theory, so “Matter Theory” is also a systematic theory, and covers a wide range, besides this paper, other results can be found in reference [1].

Reference

1 Duan Zhongxiao, The Matter Space-time Theory of Relativity, Matter Regularity, 2012, Vol.12, No.5, Sum No.53, 30-63

Shortcomings and Applicable Scopes of Special and General Theory of Relativity

Fu Yuhua

(Beijing relativity theory research federation, Beijing, 100049, China)(E-mail: fuyh1945@sina.com)

Abstract: The special theory of relativity and general theory of relativity have three basic shortcomings. First, the special and general theory of relativity respectively have two basic principles, altogether have four basic principles in the interior of relativity, these obviously do not conform to the truth uniqueness; Second, for the two basic principles of special theory of relativity and the two basic principles of general theory of relativity, no one is generally correct; Third, establishing the physical theory from the mathematics principle instead of the physical principle. Based on these, the applicable scopes of special and general theory of relativity are presented. Some wrong results caused by the theory of relativity (including the Lorentz transformation) are pointed out, such as the problems caused relativity is in a sad plight that the sonic speed in vacuum permanently is equal to zero, the twin paradox that the two brothers' state of motion are quite same, and so on. Moreover, in this paper not only solving the problem of a body's restrained motion in gravitational field such as a small ball rolls along an incline that cannot be solved by relativity, but also with the help of relativity deriving the improved Newton's universal gravitation formula that gives the same results as given by general relativity for the problem of Mercury's advance of perihelion and the problem of gravitational deflection of a photon orbit around the sun. This paper proposes that taking law (principle) of conservation of energy as the interdisciplinary grand unified theory to unified process all the problems related to energy in physics, astronomy, mechanics, chemistry, biology, medicine, engineering and so on; taking the unified variational principle for quantization in dynamic Smarandache multi-space and the fractal method as the interdisciplinary grand unified method; and taking the "science of conservation of energy" to replace or partially replace the theory of relativity.

Keywords: Special and general theory of relativity, shortcomings, applicable scope, science of conservation of energy

Introduction

People generally believe that Einstein is the greatest scientist in the 20th century, and his achievement is only next to Newton.

At the same time, the scientific circles generally thought the theory of relativity is one of the greatest scientific achievements in the 20th century.

But on the other hand, since the 1920s, Einstein and the theory of relativity have been gradually held in both hands to the god world.

Enter into the 21st century, the situation has changed, Einstein and the theory of relativity already start to go down the god world.

The Chinese renowned scientist Academician Song Jian boldly questions Einstein, and calls the young scientists dare to innovate. He read out the science report entitled “Astronautics, Astronavigation and Light Barrier” in the 242nd Xiangshan conference. Pointed out that, 100 years ago, Einstein, in his paper about special relativity that shocked the scientific circles, proposed a famous saying, it is impossible to exist any movement to travel faster than the speed of light. The present scientific circles name this phenomenon “light barrier”. However, this “extrapolation” certainly hasn’t been proven by any direct experiment.

Many men of insight already pointed out that, taking the research and challenge to the theory of relativity as the turning point, will have the possibility to lead more scientists to occupy the more and more scientific peaks gradually.

As we analyze the theory of relativity, besides the positive, remorseless, careful and valuable consideration, also emphasize and give prominence to the aspects of philosophy and critique. All of these provide the beneficial imagination space for surmounting Einstein and the theory of relativity. The people are not difficult to understand that, from the angle of natural sciences theory to criticize the theory of relativity, is an extremely difficult matter, this paper truly involves many contents about this aspect, however the effects will wait for the reader to comment; Whereas, from the angle of philosophy to challenge and criticize the theory of relativity, will have the possibility to let the reader easy to understand, and may extrapolate, positively join the beneficial exploration.

The rivers and mountains breed the talent person from generation to generation. Einstein and the theory of relativity will be surpassed; this is the matter of sooner or later.

Recently, some scientists pointed out, the theory of relativity had not considered temperature factor, this is a big flaw. While considering the temperature factor, the theory of relativity inevitably must be rebuilt.

The purpose of this paper is to discuss the shortcomings and applicable scopes of special and general theory of relativity

1 Shortcomings of special and general theory of relativity

The first basic shortcoming of the special and general theory of relativity is that they do not conform to the truth uniqueness.

In the natural sciences domain, as dealing with a specific issue, should only have one truth.

But, the two basic principles of special theory of relativity are the special principle of relativity and the principle of constant speed of light; the two basic principles of general theory of relativity are the principle of equivalence and the principle of general covariance; In

other words, the special theory of relativity has two truths; the general theory of relativity also has two truths; while in the entire theory of relativity, altogether has four truths. These obviously do not conform to the truth uniqueness.

For the reason to disobey the truth uniqueness, between the two basic principles of special theory of relativity, as well as between the two basic principles of general theory of relativity, inevitably will appear the contradictions which are unable to solve.

The second basic shortcoming of the special and general theory of relativity is that, for the two basic principles of special theory of relativity and the two basic principles of general theory of relativity, no one is generally correct. Therefore it is wrong to take them as the general truth.

This certainly doesn't mean that, the special theory of relativity and general theory of relativity are completely wrong. For some partial questions, the special theory of relativity and general theory of relativity also may produce the correct conclusions or the approximate results.

The third basic shortcoming of the special and general theory of relativity is that, to establish the physical theory from the mathematical principle instead of the physical principle.

If this road is correct, then the mathematicians will have the ability to govern physics and nearly all natural sciences. But this obviously is not impossible.

In the physics domain, to command physics with mathematics, instead of command mathematics with physics, this is the biggest misguide to physics given by Einstein. As a result of this kind of misguide, besides some individual success, the innumerable time and energy of many people with outstanding ability (including Einstein himself) have been wasted.

2 Contradictions between the basic principles of special and general theory of relativity

Firstly we discuss the contradictions between the two basic principles of special theory of relativity.

The special principle of relativity states that physical laws should be the same in all inertial reference frames.

The principle of constant speed of light states that light is propagated in empty space in straight lines with a velocity $c = 300,000$ km/s.

Einstein firstly noted the apparent incompatibility of the law of propagation of light with the principle of relativity. It can be stated briefly as follows ^[1].

As such a system let us again choose our embankment. If a ray of light be sent along the embankment, the tip of the ray will be transmitted with the velocity c relative to the embankment. Now let us suppose that our railway carriage is again traveling along the railway lines with the velocity v , and that its direction is the same as that of the ray of light. Let us inquire about the velocity of propagation of the ray of light relative to the carriage, w is the required velocity of light with respect to the carriage, and we have

$$w = c - v.$$

The velocity of propagation of a ray of light relative to the carriage thus comes out smaller than c .

But this result comes into conflict with the principle of relativity. For, like every other general law of nature, the law of the transmission of light in vacuum must, according to the principle of relativity, be the same for the railway carriage as reference body as when the rails are the body of reference.

For this apparent incompatibility, Einstein proposed two kinds of choices: (1) abandon either the principle of relativity or the law of the propagation of light in vacuum; (2) systematically holding fast to both these laws a logically rigid theory could be arrived at.

This theory has been called the *special theory of relativity*, which was established by Einstein according to the second choice.

Now we must discuss the question that, whether or not the special theory of relativity can truly solve the contradiction between the law of propagation of light and the special principle of relativity. Our answer is that it cannot.

Considering all the possible situations, the people cannot help to ask: As deriving the Lorentz transformation, why only the principle of invariance of light speed was used? Why didn't consider the principle of invariance of other speed?

Obviously, for the principle of invariance of other speed, combining with the special theory of relativity, similarly may obtain other one kind of transformation relations. Thus inevitably appears the irreconcilable contradiction.

Then, whether or not the principle of invariance of other speed is existed? The answer is affirmative. For example, in all the reference frames at the vacuum state, the sound propagation velocity is zero.

In addition, we also may find many examples that the conclusions of special theory of relativity (including the Lorentz transformation) bring on the wrong results, see below.

Therefore, the special theory of relativity doesn't successfully solve the contradiction between the law of propagation of light and the special principle of relativity.

Whether has the other way to successfully solve this contradictory? The answer is affirmative. For the apparent incompatibility of the law of propagation of light with the principle of relativity, besides the two kind of choices proposed by Einstein, still may simultaneously give up the special principle of relativity and the law of propagation of light in vacuum, and choose another principle or law (for example, the law of conservation of energy) as the only truth, to establish the new physical system. This choice may be considered as a correct way to surmount or replace the theory of relativity. Certainly, it is very difficult to reach this achievement.

Secondly we discuss the contradictions between the two basic principles of general theory of relativity.

Einstein stated that, The Equality of Inertial and Gravitational Mass as an Argument for

the General Postulate of Relativity. Its main content is as follows^[1].

We imagine a large portion of empty space, as reference body let us imagine a spacious chest resembling a room with an observer inside who is equipped with apparatus. Gravitation naturally does not exist for this observer. To the middle of the lid of the chest, is fixed externally a hook with rope attached, and now a “being” begins pulling at this with a constant force. The chest together with the observer then begin to move “upwards” with a uniformly accelerated motion. He is then standing in the chest in exactly the same way as anyone stands in a room of a home on our earth. If he releases a body which he previously had in his hand, the body will approach the floor of the chest with an accelerated relative motion. Relying on his knowledge of the gravitational field, the man in the chest will thus come to the conclusion that he and the chest are in a gravitational field which is constant with regard to time. Of course he will be puzzled for a moment as to why the chest does not fall in this gravitational field. Just then, however, he discovers the hook in the middle of the lid of the chest and the rope which is attached to it, and he consequently comes to the conclusion that the chest is suspended at rest in the gravitational field.

Guided by this example, Einstein attempted to point out that, our extension of the principle of relativity implies the *necessity* of the law of the equality of inertial and gravitational mass.

Here Einstein attempted to explain that the two basic principles of general theory of relativity (the principle of equivalence and the principle of general covariance) do not have contradictory. But this endeavor is a futile effort.

Einstein said that, our extension of the principle of relativity implies the *necessity* of the law of the equality of inertial and gravitational mass.

According to this viewpoint, how to process the temperature mass and electromagnetic mass, friction mass and so on? Whether or not our extension of the principle of relativity implies the *necessity* of the law of the equality of the three of temperature, inertial and gravitational mass?

If the three masses are not equal, then between “the principle of equivalence” (at present it should be the equality of the three of temperature, inertial and gravitational mass) and the principle of relativity (the principle of general covariance) the contradiction is appeared.

If the three masses are equal, then it is a wrong conclusion. Because as the object temperatures are different, it will contain the different thermal energy. According to the special theory of relativity, the energy may be translated into mass, thus for the same object, when its temperatures are different, its masses are different. But the reason for this mistake is the supposition that the two basic principles of general theory of relativity (the principle of equivalence and the principle of general covariance) do not have contradictory. Therefore this supposition is wrong.

It should be noted that, because the temperature, inertial and gravitational mass are not equal, in passing we find another example that between the special theory of relativity and the general theory of relativity the contradictory is appeared.

3 Mistakes of the basic principles of special and general theory of relativity

Firstly we discuss the mistakes of the two basic principles of special theory of relativity.

According to the special principle of relativity, physical laws are the same in *all* inertial reference frames.

If the meaning of “same” is “completely equal”, then the special principle of relativity has the question in the philosophy.

In the world never have two completely equal leaves.

For any two reference frames (coordinate systems), the descriptions to some physical laws impossibly to be completely same. Regarding the different reference-bodies (or their state of motion), at least we may say, the convenient degrees to describe “the law of nature” are different. That is the reason that the rectangular coordinates and polar coordinates are more universal (or more predominant) than other coordinates.

Especially, if these physical laws refer to the quantity relations, or for the reason that some conditions are different, the descriptions for them may be completely dissimilar.

For example, for the law of sound velocity, we may say that, “on the earth's surface with air temperature is 15°C, the sound velocity is 340m/s”.

But, for the airplane flying with the sound velocity, if its flight direction is consistent with the sound propagation direction, then the sound velocity is 0m/s. If its flight direction is opposite to the sound propagation direction, then the sound velocity is 680m/s.

Moreover, for the coordinate systems in vacuum state, among them the sound simply cannot propagate, thus the sound velocity is 0m/s forever. Please note this conclusion, because we can see later that no other than this conclusion, will cause the Lorentz transformation to induce the wrong result.

The reader may display own imagination as far as possible, to find more misgivings about the special principle of relativity.

According to the principle of constant speed of light, light is propagated in empty space in straight lines with a velocity $c= 300,000$ km/s.

For the experimental confirmations to the principle of constant speed of light, we should say that the experiments are extremely limited, many factors have not considered. For example, under the strong heat source radiation, whether or not the speed of light is the same as no heat source radiation?

For the light propagation, if on a certain point to project two lights along the opposite direction at the same time, then the speed for these two lights to be mutually far away no longer is a speed of light, but is two times of speed of light. In other words, if taking one of these two lights as the reference system, then the speed of another light is $-2c$. Not only this

example indicates that the principle of constant speed of light is wrong, but also demonstrates the contradiction between the special principle of relativity and the principle of constant speed of light.

Moreover, Einstein also pointed out that, one of the significant inferences from the general principle of relativity is: in general, rays of light are propagated curvilinearly in gravitational fields. A curvature of rays of light can only take place when the velocity of propagation of light varies with position. Therefore the special theory of relativity cannot claim an unlimited domain of validity; its results hold only so long as we are able to disregard the influences of gravitational fields on the phenomena (*e.g.* of light).

Here we have a problem immediately: Only in the gravitational field could the light be curving?

Be careful, Einstein wrote that, the special theory of relativity cannot claim an unlimited domain of validity. In other words, this is another example that between the special theory of relativity and the general theory of relativity the contradictory is appeared.

Second we discuss the mistakes of the two basic principles of general theory of relativity.

Now we discuss the question of the principle of equivalence (inertia mass and gravitational mass are equal). Still consider the temperature question. For the heavenly body moves around the sun, if the sun does not radiate the heat energy, then the principle of equivalence may be correct. But, the sun radiates the heat energy. Front already has said, as the object temperatures are different, then its masses are also different, therefore, the inertia mass under one kind of temperature is not the same as the gravitational mass under another kind of temperature.

Thus it can be seen, the principle of equivalence at least should be revised as follows: Under the same temperature the inertial mass and the gravitational mass are equal.

But another question will be coming, the masses of some objects also could be changed in the electromagnetic field, thereupon the principle of equivalence should be revised again as follows: Under the same temperature and the same electromagnetic field situation the inertial mass and the gravitational mass are equal.

To this analogizes, when will such revisions be finished?

As for the question of principle of relativity (the principle of general covariance), it does not need us to point out, Einstein himself already revised his original viewpoint. In other words, to withdraw a stride from his originally proposed principle of relativity (the principle of general covariance).

In reference [1] Einstein pointed out that, the following statement corresponds to the fundamental idea of the general principle of relativity: “All *Gaussian coordinate systems are essentially equivalent for the formulation of the general laws of nature*”.

Here, Einstein already has obviously drawn back a step, from “*All coordinate systems are essentially equivalent for the formulation of the general laws of nature*”, drew back to be

restricted in “all Gaussian coordinate systems” only.

As for the reason to draw back this step, we cannot find the explanation.

A logical explanation is that the general principle of relativity has encountered the problem.

Moreover, it also has another question: Why has to draw back to “all Gaussian coordinate systems”? We cannot find the explanation also. A logical explanation is that, because the general theory of relativity used the Gaussian coordinate systems, therefore it could not draw back further.

It is difficult to understand that, the Einstein already discarded the general principle of relativity, i.e., “*All coordinate systems are essentially equivalent for the formulation of the general laws of nature*” (or similar statement), but at present it still be used in many textbooks!

Here we present an example to show that *all coordinate systems are not essentially equivalent for the formulation of the general laws of nature*.

As well-known, the fractal distribution reads

$$N = \frac{C}{r^D}$$

The fractal distribution is a straight line only in the double logarithmic coordinates. Therefore, if some law of nature conforms to the fractal distribution rule, then the law that “the change of this natural phenomenon conforms to the linear rule” is only correct in the double logarithmic coordinates.

4 Applicable scopes of special and general theory of relativity

Firstly we discuss the applicable scope of special theory of relativity.

Because the two basic principles of special theory of relativity are the special principle of relativity and the principle of constant speed of light, we may say that, in the case that these two principles are correct simultaneously, generally the special theory of relativity is applicable.

For the experiment of Fizeau, these two principles are correct simultaneously.

It should be noted that, in special case, even if these two principles are correct simultaneously, it also possibly causes the wrong result. For example the Lorentz transformation may cause the wrong result.

Secondly we discuss the applicable scope of general theory of relativity.

Because the two basic principles of general theory of relativity are the principle of equivalence and the principle of general covariance, we may say that, in the case that these two principles are correct simultaneously, generally the general theory of relativity is applicable.

For the problems of the motion of the perihelion of Mercury, deflection of light by a gravitational field, displacement of spectral lines towards the red and so on, these two principles are correct simultaneously.

Similarly, in special case, even if these two principles are correct simultaneously, it also possibly causes the wrong result.

5 From mathematics principle or physical principle to establish the physical theory

Einstein thought that ^[1], every general law of nature must be so constituted that it is transformed into a law of exactly the same form when, instead of the space-time variables x, y, z, t of the original coordinate system K , we introduce new space-time variables x', y', z', t' of a coordinate system K' . In this connection the relation between the ordinary and the accented magnitudes is given by the Lorentz transformation. Or in brief: General laws of nature are covariant with respect to Lorentz transformations. This is a definite mathematical condition that the theory of relativity demands of a natural law, and in virtue of this, the theory becomes a valuable heuristic aid in the search for general laws of nature.

This speech extremely and clearly indicated the viewpoint that to command physics with mathematics, instead of command mathematics with physics. This really is Einstein's biggest misleading to the physics.

Every general law or principle of physics must automatically satisfy the covariance in some significance (but it is not the covariance in the significance of theory of relativity), or it is correct for all coordinate systems (but it doesn't have the completely same forms). For example, the law of conservation of energy may automatically satisfy the covariance in some significance, namely it is correct for all coordinate systems. But it doesn't have the completely same forms, for different coordinate systems, the sizes of conservation are different.

Therefore, it completely is unnecessary to propose the explicit mathematical condition to the physical law in advance. The physical theory should be established from the physical principle.

It should be noted that, Newton and Einstein formed a sharp contrast. As well-known, Newton was the greatest mathematician, while Einstein wasn't a mathematician. But as establishing the physical theory, Newton simply didn't apply the profound mathematical tool. The Newton's first law and third law nearly didn't apply mathematics. The second law only applied the multiplication operation. The law of universal gravitation also only applied the multiplication, division and square operation. Newton's rich and profound mathematical knowledge only was applied to realize the utilization of the simple and important physical laws.

6 Wrong results caused by Lorentz transformation

First example, suppose we have two reference systems at the vacuum state and their relative speed isn't equal to zero, there is an alarm clock in a reference system, because it is at the vacuum state, the sound propagation speed is equal to zero. According to the Lorentz transformation, in the second reference system the sound propagation speed will not be equal to zero. This obviously is wrong.

Second example, from the Lorentz transformation expression we may see that, the speed of light is the limit of speed. Once appear the speed faster than light, the Lorentz transformation either is not correct, or will cause the wrong conclusion.

But we already said in front, if on a certain point to project two lights along the opposite direction at the same time, then the speed for these two lights to be mutually far away is two times of speed of light. In other words, in this case, the Lorentz transformation will obtain the speed for these two lights to be mutually far away is still equal to the speed of light. That is wrong.

The Lorentz transformation causes the wrong conclusions that certainly are not limited in these two examples, the reader may try to propose other examples.

7 Other mistakes caused by theory of relativity and some questions cannot be solved by theory of relativity

The phenomena of “rods look shorter and clocks look slower” derived by theory of relativity can be stated as follows.

The rigid rod is shorter when in motion in the direction of its length than when at rest, and the more quickly it is moving, the shorter is the rod.

As a consequence of its motion the clock goes more slowly than when at rest.

Now we consider the phenomenon of “clocks look slower”, the purpose is to present a wrong conclusion derived by theory of relativity.

As well-known, the phenomenon of “clocks look slower” causes the twin paradox: According to theory of relativity, supposing there are pair of twins, the younger brother keeps on the Earth, the elder brother roams through the outer space as an astronaut. As the elder brother returns to the Earth, he will be much younger than his younger brother. The twin paradox means: Because the movement is relative, also may think the younger brother is carrying on the space navigation, therefore the younger brother should be much younger than the elder brother. Such two conclusions mutually conflict.

There are many explanations given by theory of relativity to this twin paradox (some of them even use general theory of relativity to carry on the complex computation), but their basic starting point is as follows: Two brothers' states of motion are different. Thereupon we may make another special twin paradox that two brothers' states of motion are quite same. If the younger brother doesn't keep on the Earth, but the elder brother and the younger brother all ride their respective high speed airships, facing the completely opposite directions to navigate from the identical time and the identical site with the same speed along a straight

line, after a quite long period they begin to decelerate simultaneously until static, then they turn around to navigate again along the same straight line with the manner of front to front, finally simultaneously return to the starting point. From the younger brother's viewpoint that, according to the theory of relativity, the elder brother should be much younger than the younger brother; Similarly, from the elder brother's viewpoint that, according to the theory of relativity, the younger brother should be much younger than the elder brother. Who is much younger to the end?

With the theory of relativity, how to explain this special twin paradox that two brothers' states of motion are quite same?

According to the kinetic energy formula of special theory of relativity, when the speed v approaches speed of light c , the kinetic energy approaches infinity; when the speed v is greater than speed of light c , the kinetic energy is an imaginary number. But, it already pointed out in reference [2] that there is no speed barrier in the universe. We also pointed out that, if on a certain point to project two lights along the opposite direction at the same time, then the speed for these two lights to be mutually far away no longer is a speed of light, but is two times of speed of light. In this case, can we have the imaginary number kinetic energy? We cannot. Here the wrong result is derived by the kinetic energy formula of special theory of relativity.

We already pointed out that, the two basic principles of special theory of relativity, in certain situations, will not be correct. Therefore, all conclusions of special theory of relativity, in certain situations also are not correct. The most famous formula in theory of relativity, $E=mc^2$, also is not exceptional, it needs to be revised in certain situations. Some of the revised formula may be found in the related literature or on the internet.

Einstein believed that, there is no more common-place statement than that the world in which we live is a four-dimensional space-time continuum.

Space is a three-dimensional continuum. By this we mean that it is possible to describe the position of a point (at rest) by means of three numbers (coordinates) x , y , z , and that there is an indefinite number of points in the neighborhood of this one, which may be as near as we choose to the respective values of the coordinates x , y , z , of the first point.

Minkowski thought that the "world" is naturally four dimensional. For it is composed of individual events, each of which is described by four numbers, namely, three space coordinates x , y , z , and a time coordinate, the time value t .

The four-dimensional mode of consideration of the "world" is natural on the theory of relativity, since according to this theory time is robbed of its independence.

But, in many situations, it is not enough to describe the movement of an event in space by means of three numbers (coordinates) x , y , z . For example, for the planet movement around the sun, it needs six coordinates (other three coordinates are those to determine the planet rotation around x , y , z axis). In fact, in the engineering, those six coordinates have already been used. For example, in finite element structure analysis, as well as in ship

movement analysis.

Now we have this question: How many coordinates are needed to describe the movement of an event in space? Six coordinates are sufficient?

As if we may say that, the coordinate numbers to describe the movement of an event in space should not be fixed. For different question, should have the different solution. For example regarding certain questions, if facilitates, we may again add the temperature coordinate, mass coordinate and so on.

In fact, at present many physical theories have already been established in higher dimensional space. Such as the string theory and so on, they must be established in the space higher than nine-dimension, some even in 26-dimensional space.

As for time, it also does not need to define as one-dimensional. At present, the time was four-dimensional, three-dimensional, six-dimensional and so on already are proposed. Now we derive one kind of three-dimensional time according to the related formula of Lorentz transformation.

Choosing two different reference systems S and S', their coordinates are x, y, z and x', y', z' respectively. At beginning S and S' are superposition, in system S there is a radial line r to pass the origin of coordinates O, the angles between r and x, y, z are α, β, γ respectively. The corresponding radial line in system S' is r'. Then the origin of coordinates O' of system S' moves with uniform speed V along the direction of radial line r, and x', y', z' are always paralleled with x, y, z respectively. The signs t_x, t_y, t_z and t_r denote the times in the directions of x, y, z respectively in system S, the signs $t'_{x'}, t'_{y'}, t'_{z'}$ and $t'_{r'}$ denote the times in the directions of x', y', z' respectively in system S'.

Suppose the system S is absolutely at rest, then we have

$$t_x = t_y = t_z = t_r = t \quad (1)$$

For the theory of relativity, suppose system S' is transmitted along x-axis, then the time transformation formula in Lorentz transformation reads

$$t' = \frac{t - (V / c^2)x}{(1 - V^2 / c^2)^{1/2}} \quad (2)$$

According to this, suppose system S' is transmitted along the direction of r, then the time transformation formula in the direction of r' reads

$$t'_{r'} = \frac{t - (V / c^2)r}{(1 - V^2 / c^2)^{1/2}} \quad (3)$$

To project it into the directions of x', y', z', we obtain the times of $t'_{x'}, t'_{y'}, t'_{z'}$ along the directions of x', y', z' in system S' are as follows

$$t'_{x'} = t'_{r'} \cos \alpha \quad (4)$$

$$t'_{y'} = t'_{r'} \cos \beta \quad (5)$$

$$t'_{z'} = t'_{r'} \cos \gamma \quad (6)$$

Thus, for a special case all the related formulas of the three-dimensional time in system S' have already been derived.

Now we discuss the problem of a body's restrained motion in gravitational field such as a small ball rolls along an incline that cannot be solved by relativity

Firstly, the variational principles established by the law of conservation of energy can be given with least squares method (LSM).

Supposing that in a closed system the initial total energy equals $W(0)$, for time t the total energy equals $W(t)$, then according to the law of conservation of energy, it gives

$$W(0) = W(t) \quad (7)$$

It can be written as

$$R_w = \frac{W(t)}{W(0)} - 1 = 0 \quad (8)$$

According to LSM, for the interval $[t_1, t_2]$, we can get the following variational principle

$$\Pi = \int_{t_1}^{t_2} R_w^2 dt = \min_0 \quad (9)$$

where, \min_0 denotes the minimum value of functional Π and it should be equal to zero.

Besides the time coordinate, another one also can be used. For example, for interval $[x_1, x_2]$, the following variational principle can be given according to the law of conservation of energy

$$\Pi = \int_{x_1}^{x_2} R_w^2 dx = \min_0 \quad (10)$$

The above-mentioned principles are established by using the law of conservation of energy directly. Sometimes, a certain principle should be established by using the law of conservation of energy indirectly. For example, a special physical quantity Q is interested , not only it can be calculated by using the law of conservation of energy, but also can be calculated by using other laws (for this paper they are the law of gravity, Newton's second law and so on). For distinguishing the values, denotes the value given by other laws as Q , while denotes the value given by the law of conservation of energy as Q' , then the value of R_w can be redefined as follows

$$R_w = \frac{Q}{Q'} - 1 = 0 \quad (11)$$

Substituting Eq. (11) into Eqs. (9) and (10) , as Q' is the result calculated with the law of conservation of energy, it gives the variational principle established by using the law of conservation of energy indirectly. Otherwise, it is clear that the extent of the value of Q accords with Q' .

Substituting the related quantities into Eq. (9) or Eq. (10) , the equations derived by the condition of extreme can be written as follows

$$\frac{\partial \Pi}{\partial a_i} = \frac{\partial \Pi}{\partial k_i} = 0 \quad (12)$$

After solving these equations, besides the original undetermined values, the improved law of gravity, and Newton's second law can be reached at one time. According to the value of Π , the effect of the solution can be judged. The more close to zero of the value of Π , the better effect of the solution.

Now we discuss an example. As shown in Fig.1, we assume that a small ball (as a mass point) rolls along a long incline from A to B. Its initial velocity equals zero and the friction and rotating energy are neglected.

Let circle O' denotes the Earth, M denotes its mass; m denotes the mass of the small ball (taken as mass point P), Supposing that $O'A$ is a plumb line, coordinate x uprights to $O'A$, coordinate y uprights to coordinate x (parallel to $O'A$), BC uprights to $O'A$. The lengths of OA , OB , BC , and AC are all equal to H , $O'C$ equals the radius R of the Earth.

For this example, the value of v_p^2 which is the square of the velocity for the ball located on point P is interested, for the sake of distinguish, denotes the value given by the improved law of gravity and Newton's second law as v_p^2 , while denotes the value given by the law of conservation of energy as $v_p'^2$, then Eq. (10) can be written as

$$\Pi = \int_{-H}^0 \left(\frac{v_p^2}{v_p'^2} - 1 \right)^2 dx = \min_0 \quad (13)$$

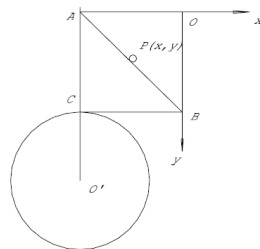

Fig.1 A small ball rolls from A to B

Now the improved law of gravity and Newton's second law with the form of constant dimension fractal can be written as follows

$$F = -\frac{GMm}{r^D} \quad (14)$$

$$F = ma^{1+\varepsilon} \quad (15)$$

where, $D = \text{const}$, $\varepsilon = \text{const}$.

According to the improved law of gravity, i.e., Eq. (14), the gravitational potential energy of the ball located on point P reads

$$V = -\frac{GMm}{(D-1)r_{O'P}^{D-1}} \quad (16)$$

According to the law of conservation of energy, we can get

$$-\frac{GMm}{(D-1)r_{O'A}^{D-1}} = \frac{1}{2}mv_P'^2 - \frac{GMm}{(D-1)r_{O'P}^{D-1}} \quad (17)$$

And therefore

$$v_P'^2 = \frac{2GM}{D-1} \left[\frac{1}{r_{O'P}^{D-1}} - \frac{1}{(R+H)^{D-1}} \right] \quad (18)$$

Considering the straight line between A and B reads

$$\mathbf{y} = \mathbf{x} + \mathbf{H} \quad (19)$$

For the ball located at point P

$$\mathbf{dv}/dt = \mathbf{a} \quad (20)$$

Because

$$dt = \frac{ds}{v} = \frac{\sqrt{2}dx}{v}$$

Therefore

$$vdv = a\sqrt{2}dx \quad (21)$$

The force along to the tangent is

$$F_a = \frac{GMm}{r_{O'P}^D} \frac{1}{\sqrt{2}} \quad (22)$$

According to the improved Newton's second law, for point P, the acceleration along to the tangent is

$$a = \left(\frac{F_a}{m} \right)^{1/1+\varepsilon} = \left(\frac{GM}{r_{O'P}^D \sqrt{2}} \right)^{1/1+\varepsilon} \quad (23)$$

From Eq. (21), it gives

$$v dv = \left\{ \frac{GM}{[(H+x)^2 + (R+H-y)^2]^{D/2} \sqrt{2}} \right\}^{1/1+\varepsilon} \sqrt{2} dx \quad (24)$$

For the two sides, we run integral operation from A to P, it gives

$$v_P^2 = 2 \int_{-H}^{x_P} \left\{ \frac{GM}{[(H+x)^2 + (R-x)^2]^{D/2}} \right\}^{1/1+\varepsilon} (\sqrt{2})^{\varepsilon/1+\varepsilon} dx \quad (25)$$

Then the value can be calculated by numerical integral method.

The given data are assumed as follows: For the Earth, $GM = 3.99 \times 10^{14} \text{m}^3/\text{s}^2$; the radius of the Earth $R = 6.37 \times 10^6 \text{m}$, $H = R/10$, try to solve the problem shown in Fig. 1, find the solution for the value of v_B^2 , and derive the improved law of gravity and the improved Newton's second law at one time.

Firstly, according to the original law of gravity, and the original Newton's second law (i.e., let $D=2$ in Eq. (14), $\varepsilon=0$ in Eq. (15)) and the law of conservation of energy, all the related quantities can be calculated, then substitute them into Eq. (13), it gives

$$\Pi_0 = 571.4215$$

Here, according to the law of conservation of energy, it gives $v_B^2 = 1.0767 \times 10^7$, while according to the original law of gravity, and the original Newton's second law, it gives $v_B^2 = 1.1351 \times 10^7$, the difference is about 5.4%. For the reason that the value of Π_0 is not equal to zero, then the values of D and ε can be decided by the optimum seeking method. At present the optimum seeking methods can be divided into two types, one type may not depend on the initial values which program may be complicated, and another type requires the better initial values which program is simple. One method of the second type, namely the searching method will be used in this paper.

Firstly, the value of D is fixed so let $D=2$, then search the value of ε , as $\varepsilon=0.0146$, the value of Π reaches the minimum 139.3429; then the value of ε is fixed, and search the value of D , as $D=1.99989$, the value of Π reaches the minimum 137.3238; then the value of D is fixed, and search the value of ε , as $\varepsilon=0.01458$, the value of Π reaches minimum 137.3231. Because the last two results are highly close, the searching can be stopped, and the final results are as follows

$$D = 1.99989, \quad \varepsilon = 0.01458, \quad \Pi = 137.3231$$

Here the value of Π is only 24% of Π_0 . While according to the law of conservation of energy, it gives $v_B^2 = 1.0785 \times 10^7$, according to the improved law of gravity and the improved Newton's second law, it gives $v_B^2 = 1.1073 \times 10^7$, the difference is about 2.7% only.

The results suitable for this example with the constant dimension fractal form are as follows

The improved law of gravity reads

$$F = -\frac{GMm}{r^{1.99989}} \quad (26)$$

The improved Newton's second law reads

$$F = ma^{1.01458} \quad (27)$$

Now we discuss the dimension (unit) of the improved law of gravity and the improved Newton's second law. Two precepts can be given.

First one: To prescript the dimensions of $a^{1+\varepsilon}$ and $r^{2-\varepsilon}$ use the same for a^1 and r^2 separately.

Second one: To handle the dimension, for each formula, the right side multiplies by a factor, for example, the improved Newton's second law can be written as $F = K'ma^{1+\varepsilon}$, where the value of K' is equal to 1, while the dimension of K' should be chosen to make the dimensions of the left side and right side identical.

The first precept is used in this paper for the advantage that the formula form may not be changed, while for the second one the formula form will be changed. Of course, other precept also may be discussed further.

Now we discuss the result given by the special relativity for this example. According to SR, the Newton's second law reads

$$F = \frac{d}{dt}(mv\gamma) \quad (28)$$

where, $\gamma = \frac{1}{\sqrt{1 - \frac{v^2}{c^2}}}$

For the case as shown in Fig.1, from Eq. (28) we can get

$$F \approx \gamma m \frac{dv}{dt} + \gamma^3 \frac{mv^2}{c^2} \frac{dv}{dt} \approx ma \left(1 + \frac{v^2}{2c^2} + \frac{v^2 \gamma^3}{c^2} \right) \quad (29)$$

Substituting $v_B^2 = 1.0767 \times 10^7 \text{ m}^2/\text{s}^2$, $c = 3 \times 10^8 \text{ m/s}$ into Eq. (29), it gives

$$F = ma(1 + 1.7945 \times 10^{-10})$$

This means that, if 5 significance digits are required, then the special relativity will give the same result as given by the original Newton's second law, namely the result of SR is not agreed with the result given by the law of conservation of energy.

Now we discuss the results given by the variable dimension fractal.

Supposing that the improved law of gravity and Newton's second law with the form of variable dimension fractal can be written as follows: $F = -GMm/r^{2-\delta}$, $\delta = k_2 u$; $F = ma^{1+\varepsilon}$, $\varepsilon = k_1 u$; where u is the horizon distance that the small ball rolls ($u = x + H$).

With the similar searching method, the values of k_1, k_2 can be determined, and the results are as follows

$$\varepsilon = 8.779 \times 10^{-8} u, \quad \delta = 1.206 \times 10^{-12} u$$

The results of variable dimension fractal are much better than that of constant dimension fractal. For example, the final $\Pi = 0.1906446$, it is only 0.033% of Π_0 . While according to the law of conservation of energy, it gives $v_B^2 = 1.0767 \times 10^7$, according to the

improved law of gravity and the improved Newton's second law, it gives $v_B^2 = 1.0781 \times 10^7$, the difference is about 0.13% only.

Einstein believed that, the Newtonian mechanics was unable to solve the problem of advance of Mercury's perihelion and the problem of gravitational deflection of a photon orbit around the sun. Only the general theory of relativity was able to solve these problems. Actually it is not the case. With the help of some results of general relativity, the improved law of gravity can be derived.

As discussing the problem of planet's movement around the sun according to the general relativity, the following equation can be given^[7]

$$u'' + u = \frac{1}{p} + \frac{3GMu^2}{c^2} \quad (30)$$

where, $u = \frac{1}{r}$; G – gravitational constant ; M – mass of sun ; c – velocity of light ; p - half normal focal chord.

Due to the central force, the orbit differential equation (Binet's formula) reads

$$h^2 u^2 (u'' + u) = -\frac{F}{m} \quad (31)$$

where, h^2 – a constant.

Substituting Eq. (30) into Eq. (31), we have

$$F = -mh^2 u^2 \left(\frac{1}{p} + \frac{3GMu^2}{c^2} \right) \quad (32)$$

The original law of gravity reads

$$F = -\frac{GMm}{r^2} = -GMmu^2 \quad (33)$$

For Eq. (32) and Eq. (33), comparing the terms including u^2 , we have

$$h^2 = GMp$$

Substituting h^2 into Eq.(32), we have

$$F = -GMmu^2 - \frac{3G^2 M^2 m p u^4}{c^2} \quad (34)$$

Substituting $u = \frac{1}{r}$ into Eq. (34), the improved law of gravity reads

$$F = -\frac{GMm}{r^2} - \frac{3G^2M^2mp}{c^2r^4} \quad (35)$$

where: G is gravitational constant, M and m are the masses of the two objects, r is the distance between the two objects, c is the speed of light, p is the half normal chord for the object m moving around the object M along with a curve, and the value of p is given by: $p = a(1-e^2)$ (for ellipse), $p = a(e^2-1)$ (for hyperbola), $p = y^2/2x$ (for parabola).

For the problem of planet's movement around the sun, substituting $p = a(1-e^2)$ into Eq. (35), it gives

$$F = -\frac{GMm}{r^2} - \frac{3G^2M^2ma(1-e^2)}{c^2r^4} \quad (36)$$

For the problem of gravitational deflection of photon orbit around the sun, according to the general relativity, the hyperbolic half normal focal chord reads

$$p = \frac{c^2r_0^2}{2GM}$$

where, r_0 represents the nearest distance to the center of the sun as shown in Fig.2.

Hence, we have the following improved law of gravity

$$F = -\frac{GMm}{r^2} - \frac{1.5GMmr_0^2}{r^4} \quad (37)$$

Now we prove that, according to Eq. (37), the deflection angle calculated by Newton's Mechanics equals two times of the value given by the original law of gravity, and equals to the value given by general relativity.

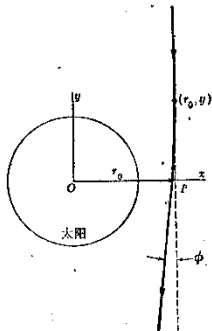

Fig.2 Gravitational deflection of photon orbit around the sun

Supposing that m represents the mass of photon. Because the deflection angle is very small, we can assume that $x=r_0$; thus on point (x, y), its coordinate can be written as (r_0, y) , then the force acted on photon reads

$$F_x = \frac{Fr_0}{(r_0^2 + y^2)^{1/2}} \quad (38)$$

$$\text{where, } F = -\frac{GMm}{r^2} - \frac{1.5GMmr_0^2}{r^4}$$

Because

$$mv_x = \int F_x dt = \int F_x \frac{dy}{v_y} \approx \frac{1}{c} \int F_x dy$$

Hence

$$v_x \approx -\frac{GMr_0}{c} \int_{-\infty}^{\infty} \frac{dy}{(r_0^2 + y^2)^{3/2}} - \frac{1.5GMr_0^3}{c} \int_{-\infty}^{\infty} \frac{dy}{(r_0^2 + y^2)^{5/2}}$$

Then we have

$$v_x \approx -\frac{2GM}{cr_0} - \frac{2GM}{cr_0} \quad (39)$$

The deflection angle reads

$$\phi \approx \text{tg} \phi \approx \frac{|v_x|}{c} = \frac{4GM}{c^2 r_0} \quad (40)$$

The value of ϕ is the same as given by general relativity. This means that the improved Newton's formula also can be used to solve the problem of movement with high velocity.

It should be noted that in the area of experiment, reference [6] already pointed out that the momentum-energy relation given by relativity didn't agree with some experimental results.

8 New theory to replace or partially replace the theory of relativity

How to establish the new theory to replace or partially replace the theory of relativity? We think that the law (principle) of conservation of energy may be taken as the interdisciplinary grand unified theory to unified process all the problems related to energy in physics, astronomy, mechanics, chemistry, biology, medicine, engineering and so on; taking the unified variational principle for quantization in dynamic Smarandache multi-space^[4] and the fractal method as the interdisciplinary grand unified method; and taking the "science of conservation of energy" to replace or partially replace the theory of relativity.

In fact, the concept of "science of conservation of energy" already appeared in 2004^[3,5].

In science of conservation of energy, the law of conservation of energy plays a leading

role. For all problems related with energy, the law of conservation of energy is the only truth; other laws will be derived from or verified by the law of conservation of energy. At present four issues are discussed. First, the relationship between force, mass and velocity is reconsidered according to the law of conservation of energy. It is shown that in the general expression of the force $F = f(m, v, x, y, z, t)$, the form of the function can be obtained by applying the law of conservation of energy. Second, it is shown that other laws, such as the law of gravity and law of Coulomb, can be derived by applying the law of conservation of energy. In passing, the changing rule for the gravitational coefficient (the so-called gravitational constant) is given. Thirdly, it is shown that other laws should be verified or denied according to the law of conservation of energy, and as examples, it is shown that the law of conservation of momentum and the law of conservation of angular momentum are not correct (as their results are in contradiction with the law of conservation of energy). Fourthly, an old discipline of sciences can be updated into a new one; for example, Newton's mechanics can be updated into New Newton's mechanics, in which the law of conservation of energy is taken as the source law to obtain the law of gravity and Newton's second law. New Newton's mechanics can be used partly in place of relativity and even can be used to solve problems which cannot be solved by relativity.

Here we actually already propose a new method to establish the natural science theory, i.e., through taking a principle or law as the only truth, to establish a new discipline. This discipline may process unified many questions that is related to this principle or law in many different original disciplines.

Perhaps the reader wants to ask that, why we take the law of conservation of energy as the only truth? Whether or not the law of conservation of momentum or the law of conservation of angular momentum can be taken as the only truth?

Essentially, the law of conservation of momentum or the law of conservation of angular momentum also can be taken as the only truth, thus establish the science of conservation of momentum or the science of conservation of angular momentum. But, the applicable scope of the law of conservation of energy is much greater than that of the law of conservation of momentum or the law of conservation of angular momentum. For example in chemistry, medicine and so on, the law of conservation of momentum or the law of conservation of angular momentum law nearly cannot be used. Therefore we should take the law of conservation of energy as the only truth.

As for taking the unified variational principle for quantization in dynamic Smarandache multi-space and the fractal method as the interdisciplinary grand unified method, the reason can be stated briefly as follows.

Firstly, we discuss the applications of Dynamic Smarandache Multi-Space (DSMS) Theory. Supposing for the n different dynamic spaces (n is a dynamic positive integer and the function of time) the different equations have been established, as these n different dynamic

spaces synthesize the DSMS, and they are mutually affected, some new coupled equations need to establish in the DSMS to replace some equations in the original dynamic spaces, as well as supply other equations to process the contact, boundary conditions and so on. For the unified processing of all equations in the DSMS, this paper proposes to run the quantization processing to all the variables and all the equations and establish the unified variational principle of quantization with the collocation method based on the method of weighted residuals, and simultaneously solve all the equations in the DSMS with the optimization method. Thus by using the unified variational principle of quantization in the DSMS and the fractal quantization method, will pave the way for the unified processing of the theory of relativity and the quantum mechanics, and the unified processing of the four foundational interactions. At present this method can be used to find the coupled solution for the problem of relativity and quantum mechanics.

Secondly, as well-known, the fractal method has been successfully used in some fields, it is used to find the organized structure that deeply hidden in the complex phenomenon. According to many scholars' viewpoints, it will be able to have great development and obtain a bigger success in the 21st century.

At present for the fractal method in common use, the fractal dimension D is a constant, for example the fractal dimension D for the coastline may be taken as 1.02, 1.25 and so on. This kind of fractal may be called the constant dimension fractal. But, in nature the phenomenon that strictly satisfies the relation of constant dimension fractal simply does not exist. Therefore the massive complex phenomena are unable to process with constant dimension fractal. In order to overcome this difficulty, now the concept of variable dimension fractal has been proposed, namely the fractal dimension D is the function of the characteristic scale r . Later, based on the complex number dimension fractal and the fractal series, the variable dimension fractal in hyper complex spaces (in which the fractal dimension D is the function of variable and hyper complex) also is presented.

In a word, the domestic and foreign scholars have already developed the fractal method in many aspects.

Therefore, the fractal method will certainly have the extremely widespread applications.

References

- [1] Albert Einstein, *Relativity: The Special and General Theory*, Methuen & Co Ltd, 1924
- [2] Smarandache, Florentin, *There Is No Speed Barrier In The Universe*, Bulletin of Pure and Applied Sciences, Delhi, India, Vol. 17D (Physics), No. 1, p. 61, 1998
- [3] Florentin Smarandache, V. Christianto, Fu Yuhua, R. Khrapko, J. Hutchison, *Unfolding the Labyrinth: Open Problems in Physics, Mathematics, Astrophysics, and Other Areas of Science*, Hexis-Phoenix, p. 85-99, 2006
- [4] Fu Yuhua, *A Unified Variational Principle for Quantization in Dynamic Smarandache Multi-Space*, in: *Applications of Smarandache's Notions to Mathematics, Physics, and Other*

Sciences (Edited by Yuhua FU, Linfan MAO, and Mihaly BENCZE), ILQ, 2007

[5] Fu Yuhua, Science of Conservation of Energy. Journal of Dezhou University. 2004(6):
20 ~ 24 (in Chinese)

[6] Ji Hao, On Experiment that Measures the Momentum-Energy Relation of Moving
Electrons, Engineering Sciences, 2006, 8(10), 60~65(in Chinese)

[7] Hu Ning, General Relativity and Gravitational Field Theory. Beijing : Science Press,
2000(in Chinese)

Reconsideration on Validity of the Principle of Relativity in Relativistic Electromagnetism

Guo Kaizhe¹, Guo Chongwu²

1 Electronic Engineering College, University of Science and Technology of China, Chengdu, China;

2 Hoff Lu Matter Regularity Institute, Shanghai, China

Abstract: The applicability of the principle of relativity was reconsidered. There are magnetic field forces between positive charge and negative charge in an electric dipole which is moving in a laboratory reference frame. Whereas, examining the electric dipole in a reference frame which is at rest relative to the electric dipole, we find no magnetic field force exists between the two charges. The results obtained in the two frames are different, which indicate some electromagnetism laws do not satisfy the principle of relativity whether under Galilean transformation or under Lorentz transformation. The form invariance of Maxwell's equations under Lorentz transformation has been regarded as deeply significant, but the present research shows that the form invariance of the field equations is nothing more than an expression of the Doppler Effect.

Keywords: The principle of relativity; validity; inertial reference frame; magnetic field force; Lorentz transformation; Maxwell's equations

1 Introduction

The Special Relativity has changed the space-time concepts formed in Newton's time, and it was based on the principle of relativity and the constancy of the velocity of light [1]. In the past century, the two postulates had been accepted universally. Nevertheless, the Special Relativity has been challenged continuously since its establishment from both theories and experiments. In 2000, *Nature* journal declared an experiment result finding super-light velocity by L. J. Wang et al. [2]. Thenceforth, different laboratories in the world have successively accomplished a series of parallel test results about super-light velocity. In 2007, C. W. Guo proved that the crossed Doppler Effect of light existed in Newton's space-time concepts [3], that is to say, a moving clock runs slow cannot be thought to be "time dilation". In 2011, C. W. Guo revealed a conflict between the relativistic mechanics and the momentum conservation law [4], which indicated that the relativistic mechanics was faced with a serious difficulty.

In the classical physics, the mechanics laws satisfy the requirement of the principle of relativity under Galilean transformation. Upon the development of Maxwell's equations for electromagnetism, those equations were not found to satisfy that same principle under the

same transformation. With the establishment of the Special Relativity, the laws of mechanics were revised to satisfy the principle of relativity under Lorentz transformation, and Maxwell's equations were shown to satisfy that same principle under Lorentz transformation. Thenceforth, the principle of relativity has been thought to be applicable for all physical laws, which mean that all physical laws maintain invariant form in all inertial reference frames connected by Lorentz transformation.

However, in the present research, it was discovered that some laws in electromagnetism are not quite like that. Furthermore, it was found that the form invariance of Maxwell's equations has a precedent in the familiar Doppler Effect.

2 Force Analysis within an electric dipole

In a laboratory reference frame S , we have an electric dipole. The positive charge P and negative charge N within the electric dipole lie on x, y -coordinate plane, and the coordinate values of the negative charge N are bigger than those of the positive charge P . Denote by α the angle between the direction of line segment PN and the x -axis, let the distance between the two charges be r , and the electricity quantities of the two charges be q and $-q$ respectively. Suppose that the electric dipole is moving with a velocity v along the x -axis direction, according to Biot-Svart law, we get the magnetic strength at point N produced by the positive charge P ,

$$B_N = \frac{\mu_0}{4\pi} \frac{qv \sin \alpha}{r^2}$$

And according to Ampere law, we have the magnetic force acting on negative charge N ,

$$F_N = \frac{\mu_0}{4\pi} \frac{q^2 v^2 \sin \alpha}{r^2} \quad (1)$$

F_N directs towards the y -axis direction. With the same method we get the magnetic force acting on the positive charge P by the negative charge N ,

$$F_P = -\frac{\mu_0}{4\pi} \frac{q^2 v^2 \sin \alpha}{r^2} \quad (2)$$

Where minus denote that F_P is towards the negative y -axis direction. Equation (1) and (2) indicate that the direction of the electric dipole PN will be perpendicular to the x -axis under the actions of F_N and F_P unless the initial condition is $\alpha = 0$.

Suppose we have a reference frame S' that is moving relative to the laboratory reference frame S at the velocity v along the x -axis direction, the electric dipole is motionless from

the view point of observers in the frame S' . The magnetic forces between the positive charge and negative charge are zero when computing with Biot-Svart law and Ampere law, therefore, the electric dipole PN may point to any directions in the frame S' . The result is absolutely inconsistent with that in the laboratory reference frame. Apparently, some electromagnetism laws can not satisfy the requirement of the principle of relativity whether according to classical electromagnetism or according to relativistic electromagnetism.

3 Result of Maxwell's Equations in Lorentz Transformation

The analysis below shows that the form invariance of the field equations is nothing more than an expression of the Doppler Effect.

Set up two inertial reference frame S and S' . The x -axis is coincident with the x' -axis, y -axis is parallel to y' -axis and z -axis parallel to z' -axis. The frame S' is moving at a velocity v relative to frame S in the x direction. When the origin of frame S' passes the origin of frame S , the clocks at the two origins read zero.

Transition of Maxwell's equations in going from the frame S to the frame S' by Lorentz transformation gives the equations for Lorentz transformation of the electromagnetic field:

$$E'_x = E_x$$

$$E'_y = \gamma(E_y - vB_z)$$

$$E'_z = \gamma(E_z + vB_y)$$

$$B'_x = B_x$$

$$B'_y = \gamma(B_y + vE_z / c^2)$$

$$B'_z = \gamma(B_z - vE_y / c^2)$$

Where $\gamma = \frac{1}{\sqrt{1 - v^2 / c^2}}$, E_x , E_y , and E_z are electric field strengths in the directions of x -axis, y -axis, and z -axis, respectively, B_x , B_y , and B_z are magnetic field strengths in the directions of x -axis, y -axis, and z -axis, respectively, and c is the velocity of light. In the free space, the relations between the electric field strength \vec{E} and the magnetic field strength \vec{B} in the electromagnetic waves are

$$\vec{E} = -c\vec{n} \times \vec{B}$$

$$\vec{B} = \frac{1}{c} \vec{n} \times \vec{E}$$

Where \vec{n} denotes the unit vector in the direction of the propagation of electromagnetic waves. Now we suppose the light source that is at rest in the frame S emits light and the light propagates in the x direction. From the above equations we get

$$E'_y = \gamma(1 - v/c)E_y$$

$$E'_z = \gamma(1 - v/c)E_z$$

$$B'_y = \gamma(1 - v/c)B_y$$

$$B'_z = \gamma(1 - v/c)B_z$$

It seems that the equations are the same as the expression of the Doppler Effect.

4 Conclusion

The principle of relativity has been widely recognized to be applicable for the electromagnetism under Lorentz transformation for as long as one century. However the present research shows that some electromagnetism laws do not meet the requirement of the principle of relativity.

In addition, the form invariance of Maxwell's equations under Lorentz transformation has been regarded as deeply significant. However, the present research shows that the form invariance is just a reflection of the Doppler Effect.

References

- [1] Einstein A. On the Electrodynamics of Moving Bodies [J]. Ann. Physik, 1905, 17: 891-921.
- [2] Wang L J, Kuzmich A, and Dogariu A. Gain-assisted Superluminal Light Propagation [J]. Nature, 2000, 406: 277-279.
- [3] Guo C W. Researches of the Crossed Doppler Effect in the Classical Physics [J]. Galilean Electrodynamics, 2007, 18 (Special Issues 1): 2-6.
- [4] Guo C W. Contradictions in the Relativistic Mechanics [J]. Science and Technology Innovation Herald, 2011, 5: 237-238.

Is “The General Theory of Relativity” a Scientific Theory?

Guo Ying-Huan

(Institute of High Energy Physics, Chinese Academy of Sciences. Beijing 100049. P. R .China.)

Guo Zhen-Hua

(Dept. Phys. and information technology, Baoji Univ. Arts & Sci., Baoji 721007, Shaanxi, China , P. R .China. e-mail:guozhh2670@163.com)

Abstract:By carefully comparing the results given by the general theory of relativity and the actual astronomical observation, the contradiction between them is found to be difficult to overcome. Furthermore, there is no sign so far of the existence of “the waves” predicted by the general theory of relativity. Therefore, the general theory of relativity is pointed as a wrong theory. All the research results and inference based on the general theory of relativity should be queried.

Keywords:The general theory of relativity , Gravitational field, the time and space, curvature, torsion, Field energy, the universe, the origin, evolution.

1 Introduction

Einstein’s research in physics, achieved brilliant success, (Special) relativistic far-fetched to propose a general theory of relativity. General relativity theory is a description of the gravitational interaction between celestial bodies in the universe. Material strong (S), weak (W), electromagnetic (EH), gravitational (G) are four interaction theories of gravitation theory. Evidence that he was “far-fetched”, is due to Newton’s ability to prove “the existence of absolute space-time reference system”, which proposed “rotating bucket experiment”: The aqueous phase (spinning) “Barrel wall” spin down [relative (in the inertial reference system) still] the water is flat; the water phase (spinning) “Barrel wall” relatively static [relative (in the inertial reference system) rotation—bucket of water synchronous rotation] “sunken”. That is to say, the “complex and mysterious” “Barrel wall” said absolute reference system. The Mach thus Mach's principle “by the reference system of the universe all of substances ‘Barrel wall’ (it’s external) decision is an absolute reference system”. Einstein was thus impatient to the basis of Mach's principle, proposed his “all space-time reference system (affine) equivalent to each other”, the General Principle of Relativity (space-time general covariance), the creation of a general theory of relativity. In this theory, the material between the gravitational interactions—gravitational field, and as a material in which the space-time geometry was treated. However, we have strict that [1], Newton's rotating bucket experiment,

in essence, has completely proven the universal principle of relativity flat space-time. Perhaps Einstein has long been aware of this, which makes him later abandon his general theory of relativity, Mach's principle reasons for it. This body out of nowhere “principle of general covariance, talking nonsense like given” generalized principle of relativity, and thus the establishment of the castles in the air general relativity. The last century, the general theory of relativity was holding red fire, and took pains (this theory has a complex mathematical structure) rather inexplicably given theory: “The structure of the universe substances, dark matter, dark energy”; “universe, the origin of the Big Bang”; “the expansion of the universe, the evolution of explosive expansion”; “time tunnel” through which can pass through to the “past” and “future”, etc. This undoubtedly gives a magical and magical. However, the huge theory and human practice activities (navigation, aviation, aerospace...) irrelevant.

Therefore, very natural scholars: Use general relativity to study our side in the universe's meticulous observation part of the structure of the universe. This can either theoretically be a more accurate understanding of our cosmic environment, but also further witness the absolute correctness of the theory of general relativity. This proposal is very good. In this way, we now know very clearly, ironclad accurate observation of facts, to absolute falsification of general relativity.

2 Questioned: The general theory of relativity is a scientific theory

Proposition: General relativity is false scientific theories

Proof 1: We first give the main results of the general theory of relativity, and then given the hard facts observed by the human universe's survival. Directly according to the review, see “General Theory of Relativity” is correct?

2.1 Some of the main conclusions of the theory of general relativity [2,3]

General relativity to Riemannian space-time $R^4 (x^\mu / 0 \leq \mu \leq 3)$ structure of the affine reference system based on infinitesimal distance given in R^4

$$ds^2 = g_{\mu\nu} dx^\mu dx^\nu. \quad (1)$$

$g_{\mu\nu}$ become symmetrical Association 2-order metric tensor in R^4 . The vector \vec{a} translation deterioration $\delta\vec{a}$ in R^4 , Contact $\Gamma_{\mu\nu}^\kappa$ covariant/inverter derivative

$$\begin{aligned} \delta a^\kappa &= -\Gamma_{\mu\nu}^\kappa a^\nu \delta x^\mu \quad (\delta a_\kappa = -\Gamma_{\mu\nu}^\kappa a_\nu \delta x^\mu), \\ \Gamma_{\mu\nu}^\kappa &= \frac{1}{2} g^{\kappa\lambda} (g_{\mu\lambda,\nu} + g_{\nu\lambda,\mu} - g_{\mu\nu,\lambda}), \quad (2) \\ a_{;\kappa}^\mu &= a_{,\kappa}^\mu + \Gamma_{\lambda\kappa}^\mu a^\lambda \quad (a_{\mu;\kappa} = a_{\mu,\kappa} - \Gamma_{\mu\kappa}^\lambda a_\lambda). \end{aligned}$$

Particle in R^4 the trajectory—the geodesic equation

$$\frac{d^2 x^\kappa}{ds^2} + \Gamma_{\mu\nu}^\kappa \frac{dx^\mu}{ds} \frac{dx^\nu}{ds} = 0. \quad (3)$$

Where $\Gamma_{\mu\nu}^\kappa$ is contact in R^4 ? Riemann curvature tensor given by the vector of the R^4 2 order exchange covariant derivative of 2-dimensional surfaces

$$a_{[\mu,\nu]}^\kappa = R_{\mu\nu\lambda}^\kappa a^\lambda, \quad (4)$$

$$R_{\mu\nu\lambda}^\kappa = \Gamma_{\lambda\mu,\nu}^\kappa - \Gamma_{\nu\mu,\lambda}^\kappa - \Gamma_{\gamma\mu}^\kappa \Gamma_{\lambda\nu}^\gamma + \Gamma_{\gamma\nu}^\kappa \Gamma_{\lambda\mu}^\gamma.$$

In Riemann space-time R^4 , covariant indicators symmetry due to contact, 1-dimensional motion of the particle track—the geodesic torsion $T_{\mu\nu}^\kappa$ identically zero.

$$T_{\mu\nu}^\kappa = \Gamma_{\mu\nu}^\kappa - \Gamma_{\nu\mu}^\kappa = 0. \quad (5)$$

In the R^4 , these substances of symmetry energy—momentum—tension tensor density $T_{\mu\nu}(x)$ of Einstein's gravitational field equation

$$G_{\mu\nu} = -8\pi G T_{\mu\nu};$$

$$G_{\mu\nu} = R_{\mu\nu} - \frac{1}{2} g_{\mu\nu} R, R_{\mu\nu} = R_{\kappa\mu\nu}^\kappa, R = g^{\mu\nu} R_{\mu\nu}. \quad (6)$$

Where $R_{\mu\nu}$ for Ritchie curvature tensor, $G_{\mu\nu}$ for the Einstein tensor. Centroid of the coordinate origin in R^4 , the quality of the m objects, the strict geometry in the R^4 [equation (5) Schwarzschild's rigorous solution]

$$ds^2 = \left(1 - \frac{2Gm}{c^2 r}\right) c^2 dt^2 - \frac{1}{1 - 2Gm/c^2 r} dr^2 - r^2 (d\theta^2 + \sin^2 \theta d\varphi^2). \quad (7)$$

This means that there are 3 space spherically symmetric structure in the R^4 .

2.2. The human universe survival observed irrefutable fact that [4, 5]

Since the birth of mankind on Earth, "Pan gu created the heaven splitting". The discovery of the day, month, and stars. Claudius Ptolemaeus (BC90-168) in the 2nd century AD, the geocentric draw geocentric system celestial bodies figure. Copernicus (1473-1543) in the early 16th century proposed the heliocentric system. Which gives the extremely concise description of the laws of celestial bodies, which is more objective truth. This is entirely in line with the truth avenue from simple principle. Now no one I do not know: The earth goes around the heliocentric (approximate) turn, the moon orbits around the center of the earth (approximate) transfer. To the precise results of the observations of the heliocentric system, Earth orbit curvature about 1.15×10^{-5} . Not only curvature about lunar orbit 1.39×10^{-4} , and torsion about 1.155×10^{-4} . Visible the lunar orbit torsion or large.

2.3. Directly from the above results, we see that, in General Relativity, due to the symmetry of the R^4 , the moderate regulatory covariant indicators Riemann space R^4 torsion constant 0. Torsion of the actual trajectory of the planet (such as the moon) the heliocentric system is non-zero. Huge contradiction between the results and the actual observed facts which make the “general relativity”. Some scholars may be aware of this problem, and torsion of general relativity [6]. Riemannian space-time R^4 with torsion, however, will lose the only three-dimensional spherical symmetry in the R^4 , which makes R^4 no symmetry (covariant) sexual. This theory will completely and “special/general relativity principle” irrelevant, no say general relativity? Therefore, the contradiction here is absolutely impossible to approve the amendment of the general relativity to be overcome. A theory with actual observations are completely the opposite, that the theory can be absolutely sure is wrong. However, this theory is generally as “science”, we can only say that this “science” must be pseudo-science.(QED)

Proof 2: General relativity in the Riemannian space-time R^4 painstaking claimed Riemannian space-time from which an object has energy. But where in the energy density of the number, but not precise and uniform. In-laws are different. Only opposite result, this space-time energy radiation of gravitational waves. Moreover, now has positive mass conjecture “proved” positive mass theorem. That gravitational waves will be sky everywhere. “Only the curved space-time, there would be no gravitational waves”? It is not to mention the “trickery” suspected. On the recognition of gravitational waves, it is a long time, of a lot of effort, has yet to detect gravitational waves gossamer ant trails.

The results showed that (S, W, EH, G) in the gravitational interaction (gravitational field). It has been four kinds of interactions between substances [7-9], homogeneous and isotropic flat space-time, through its quantum negative phase of the overall state of the U (1) specification, given its quality (Netherlands); through its quantum state U (1) local gauge negative phase, resulting in its gravitational field. The gravitational field is a negative energy field. The gravitational field cannot be positive energy to the material source external radiation of gravitational waves. Gravitational waves are impossible to detect gravitational source. Day-to-day experience of everything, including a free-fall and Mossbauer Effect experiments, are proven.

Here is also clear from the energy given the need to question the general relativity scientific argumentation.(Q.E.D)

In short, we can clearly see, general relativity as the basis of the results of all the findings and inferences are impossible to set up.

References

- [1] Guo Yinghuan , Guo Zhen-Hua , Guo Wei , Modern Physics, 2009 (5)(in Chinese) ;
- [2] The Relativistic Introduction P . G. The Bergman book , Zhou Qi , Hao Ping translation , People's Education Press , Beijing (1961) (in Chinese) ;

- [3] field theory , Л.Д. Landau , EM Li Fu Xizi forward , any Lang , Yuan Bingnan translation , Higher Education Press , 1959 , Beijing(in Chinese) ;
- [4] Astronomy new concept , the Soviet Union should be compiled , Science Press , (2009 , Beijing) (in Chinese) ;
- [5] planets , stars , galaxies , of the SJ Inglis book , Lizhi Sen , Lee Chong Wei , He Xiangtao , Xiao Xinghua translation, Science Press, Beijing (1979) (in Chinese);
- [6] Wan Ming Fang , flex time and space gravitational unified theory of electromagnetic fields , Wuhan University of Technology (Transportation Science & Engineering), 2000 , 05 ; Luo Shijun , Peng Guangxiong torsion scalar - - tensor theory of gravity inflationary universe model, Hubei Automotive Industries Institute , 1996 , 01 ; Zhangcheng Min , Liu Xindian , it Shuxian , the gravitational effects of the torsion and its background , the Capital Normal University (natural Science Edition) , 1994 , 01 ; paragraph Shao light , with general relativity plus torsion interpretation of Galactic rotation , Chongqing University , in 2003,06(in Chinese) ;
- [7] Wei Guo , Guo Yinghuan , Guo Zhen-Hua , The Weyl-U(1) Gaugefield theory of gravitation and it's universe, Matter Regularity, 2010 , (5) 43; frontier science, 2012,1 , Volume 6 , total 21 , 49-64 (in Chinese);
- [8] Guo Wei of Guo Guo Yinghuan , Guo Zhen-Hua , gravitational field characteristics of negative energy—a whole new view of the universe , frontier science , 2011 , (1) 68 (in Chinese);
- [9] Guo Wei , Guo Ying Huan , Guo Zhen-Hua , the gravitational field of negative energy characteristics and steady state evolution of the universe, Matter Regularity, 2012 (5) 17 (in Chinese).

The Theory of Relativity and Compressibility Ether

Hu Chang-Wei

Beijing Relativity Theory Research Federation

(huchangwei@sina.cn)

Abstract: Its physical basis and limitations do not be explained by the theory of relativity itself, so that it seems that is an existence without matter. Its physical basis is, in fact, the macroscopic physical vacuum, which is called ether. In the absolute space-time theory, the ether is a compressible superfluid, a change in the ether density causes a change in the actual space-time standard, and thus, the phenomena occur. The relativity made up the shortcoming of absolute space-time theory in quantity, while the physical basis of relativity can be described and its limitations can be showed on the basis of absolute space-time theory. Relativistic and absolute space-time theories are two different space-time theories in nature. It is not the relation that one negates the other and yet there are certain discrepancies, corresponding relationships and complementarities between them

Keywords: The theory of relativity, Compressibility ether, Absolute space-time theory, Quantitative effect, Corresponding relationship,

1 Introduction

The theory of relativity is one of the bases of modern physics. Nevertheless, it is like an axiomatic system that derived a series of quantitative relations from several principles but the mechanism why this quantitative relation can be established does not be explained. Therefore what it describes is only some appearance. The relativity should not be an existence without matter, what is its material basis? It is a physical vacuum. A vacuum is not a void, which is showed by Casimir effect^[1,2] and so on. The matter of vacuum state is called ether, which is different from the mechanical ether in 19th century, is a compressible superfluid, and can be used to explain Michelson-Morley experiment and the origin of Lorentz invariability, namely the uniformity of the four dimensional space-time continuum.

In the 80's of the 20th century, I was already to point out that the Lorentz transformation can be derived by means of fluid mechanics^[3]. Contemporaneously, Liao Mingsheng discovered that the equations with form of relativistic formula can be obtained through taking Lorentz covariance to the fundamental equations of fluid mechanics^[4,5]. Later, Yang Xintie and others considered that relativistic effects are similar to compressible effects of fluid^[6,7]. These can provide leads for researches in physical basis and limitation of relativity.

2 The Lorentz transformation is derived with means of fluid mechanics

In fluid mechanics, the velocity potential ϕ of an incompressible fluid satisfies the following equation:

$$\Delta\phi(x,y,z) = 0. \quad (1)$$

Let a body move with velocity v in an infinite compressible fluid, which causes disturbances in the velocity, density and pressure. If the disturbances are assumed to be infinitesimal quantities of the first order, the equation of linearization can be obtained^[8]:

$$\left(1 - \frac{v^2}{c^2}\right) \frac{\partial^2 \phi}{\partial x^2} + \frac{\partial^2 \phi}{\partial y^2} + \frac{\partial^2 \phi}{\partial z^2} = 0 \quad \left(\frac{v}{c} < 1\right), \quad (2)$$

Where c is the speed of sound in the fluid.

The following transformation (3) can be used:

$$\begin{cases} x' = \beta x \\ y' = y \\ z' = z \end{cases} \left(\beta = \frac{1}{\sqrt{1 - \frac{v^2}{c^2}}} \right), \quad (3)$$

Substituting (3) into (2), the resulting equation is identified with (1): $\Delta\phi(x'.y'.z') = 0$.

Therefore, Eq. (3) is the transformation of the fluid from a compressible to an incompressible state.

If two parallel right-angled coordinate systems $O_1(x_1, y_1, z_1)$, $O_2(x_2, y_2, z_2)$ are constructed on two special fluids that satisfy equation (2), if their x-axes are superposed, and if O_2 with speed v moves in the positive x-direction, a Galilean transformation can be performed between them, as in Eqs. (4) and (5):

$$x_2 = x_1 - vt_1 \quad y_2 = y_1 \quad z_2 = z_1, \quad (4)$$

$$x_1 = x_2 + vt_2 \quad y_1 = y_2 \quad z_1 = z_2. \quad (5)$$

(Note: Here, the time t is written as t_1 and t_2 separately.)

Substituting (3) into (4) and (5), where x_1 in (4) and x_2 in (5) do not change because they are of the proper length, gives Eqs. (6) and (7):

$$x'_2 = \beta(x'_1 - vt_1) \quad y'_2 = y'_1 \quad z'_2 = z'_1, \quad (6)$$

$$x'_1 = \beta(x'_2 + vt_2) \quad y'_1 = y'_2 \quad z'_1 = z'_2, \quad (7)$$

Substituting the first equation in (6) into (7) leads to

$$t_2 = \frac{1}{v\beta} (x_1' - \beta^2 x_1' + \beta^2 v t_1) = \beta \left(t_1 - \frac{x_1' (\beta^2 - 1)}{v\beta^2} \right), \quad \beta^2 = \frac{c^2}{c^2 - v^2},$$

$$t_2 = \beta \left(t_1 - \frac{v x_1'}{c^2} \right). \quad (8)$$

If the speed of sound c in the special fluid is the speed of light in a vacuum, then the combination of (6) and (8) is the Lorentz transformation.

Above special fluid, whose distribution is infinite in space where the speed of sound is the speed of light in vacuum, cannot be a conventional fluid. It is, in fact, the macroscopic physical vacuum, namely the ether. Moreover the Galilean transformation expresses the absolute space-time theory, and the Lorentz transformation expresses the relativistic space-time theory, therefore the ether, absolute and relativistic space-time theories are linked together by above derived course.

3 Macroscopic ether is a compressible superfluid

The theory of quantum fields assumes that a physical vacuum is the ground state of the quantum field, which is a microscopic description. The image of matter can lead to a significant difference between the microscopic and the macroscopic descriptions. For instance, microscopically, water is composed of molecules, which move at random, and it is difficult to find its most fundamental characteristic as a fluid of continuity. Above derived course shows that the macroscopic ether is a continuous fluid. The following ether are all the macroscopic ether.

Moreover any body can move without resistance in the ether, whether it is smooth, rough or full of cracks. Therefore, the ether is a superfluid, and only a superfluid can satisfy the established condition of equation (2) completely. There are two different sounds in a general super-fluid: The first sound of density wave, which is the conventional sound; and the second sound of temperature wave^[9], which propagates with heat. In the vacuum, the thermal propagation is carried out through thermal radiation, namely, similar to the electromagnetic wave, therefore the electromagnetic wave, including the light, is the second sound in ether.

The ether theory in the 19th century was already to be negated by the Michelson-Morley experiment, how is the explanation of compressibility ether theory? This question, in fact, was already to have a definite answer. In compressible fluid, there exists the phenomenon where the stripe of loop sound interference is invariant to the speed of wind, which was verified by Liu Weiping, Su Benqing, Xi Deke and Yang Xintie with numerical simulation and sound interference experiment; and Norbert Feist, a Germanic engineer, made an experiment of Galilean velocity meter in high-velocity car, and the stripe of loop sound interference is also invariant^[10]. These facts show that the moved effect of fluid is offset by compressible effect of fluid, which mean that the relativistic effect is equivalent to compressible effect of ether.

The derivation of the Lorentz transformation by means of fluid mechanics shows that the ether is the compressible in absolute space-time theory, and it became the incompressible in the relativistic space-time theory. The incompressible ether, whose density can't be changed, is homogeneous and isotropic, it is, in fact, the four dimensional space-time continuum, which also is the origin of relativistic space-time uniformity or the Lorentz invariability.

4 The formulas of relativistic form are derived from the formulas of fluid mechanics

The ether is an incompressible superfluid in the relativity, so that we can regard ether as an ideal fluid, in which having a disturbances of sound, its equation of state is

$$dP = d\rho c^2, \quad (9)$$

Where the dP is the tiny increment of ether pressure; the c is the sound velocity; the $d\rho$ is tiny increment of ether density.

The Eq.(9) is identical with the mass-energy relation of relativity formally, which seems to mean that the relativistic energy is corresponds to the tiny increment of ether pressure and the relativistic mass is corresponds to the tiny increment of ether density. Has whether such a corresponding relation universality? Let us make some analyses further.

The ether should satisfy the equation of continuity: $\frac{\partial \rho}{\partial t} + \text{div} \rho \vec{u} = 0$. Using the Lorentz covariance, it can be shown that

$$\rho' = \beta \rho (1 - v u_x / c^2), \quad \rho' u'_x = \beta (\rho u_x - v \rho), \quad \rho' u'_y = \rho u_y, \quad \rho' u'_z = \rho u_z. \quad (10)$$

Where the u is the velocity of moved body; the v is the velocity that a frame of reference $O'(x', y', z')$ relative to $O(x, y, z)$ and its direction is parallel to the x -axis.

Substituting the first equation into the second, third and fourth equations in Eq. (10), gives Eq. (11):

$$u'_x = \frac{u_x - v}{1 - u_x v / c^2}, \quad u'_y = \frac{u_y}{\beta (1 - u_x v / c^2)}, \quad u'_z = \frac{u_z}{\beta (1 - u_x v / c^2)}. \quad (11)$$

Moreover,

$$\vec{u}^2 = u_x^2 + u_y^2 + u_z^2; \quad \vec{u}'^2 = u'^2_x + u'^2_y + u'^2_z. \quad (12)$$

According the Eqs.(11) and (12), the Eq.(13) can be proved^[5]

$$\sqrt{1 - u'^2 / c^2} = \frac{\sqrt{1 - u^2 / c^2}}{\beta (1 - u_x v / c^2)}. \quad (13)$$

By the first equation of (10) and (13), it can be obtained

$$\frac{\rho'}{\rho} = \beta(1 - u_x v / c^2) = \frac{\sqrt{1 - u^2 / c^2}}{\sqrt{1 - u'^2 / c^2}}, \text{ 那么 then}$$

$$\rho' \sqrt{1 - u'^2 / c^2} = \rho \sqrt{1 - u^2 / c^2} = \rho_0 \text{ (a constant) , hence}$$

$$\rho = \frac{\rho_0}{\sqrt{1 - u^2 / c^2}}. \quad (14)$$

Taking differentiation of density in the two sides of Eqs. (10) and (14), gives Eqs. (15) and (16):

$$\left\{ \begin{array}{l} d\rho' = \beta d\rho \left(1 - \frac{vu_x}{c^2}\right) \\ u'_x d\rho' = \beta(u_x d\rho - vd\rho), \\ u'_y d\rho' = u_y d\rho \\ u'_z d\rho' = u_z d\rho \end{array} \right. \quad (15)$$

$$d\rho = \frac{d\rho_0}{\sqrt{1 - u^2 / c^2}}. \quad (16)$$

Obviously, the Eq. (11) is the formulae of velocity transformation in the relativity; and the density ρ can be replaced by mass m in (15) and (16), which are separately the transformation of mass and momentum, and the mass-velocity formula, in the relativity. Therefore there is universality that the relativistic mass is corresponds to the tiny increment of ether density. Why is it so? This question concerns the space-time theories.

5 The relations between two space-time theories: The quantitative effects

The derivation of the Lorentz transformation by means of fluid mechanics shows that the absolute and relativistic space-time theories are two different space-time theories in nature. Newton said that the space and time can be divided into the absolute and the relative^[11]. The absolute space and time are not related to matter, and they are difficult to be measured directly because the measure is a course interacted or interlinked between a measuring tool and a measured body. The relative space and time are related to matter and can be measured directly. The physics is an experimental science, whose space-time are all the measurable relative space-time. What the classical physics researches are the physical phenomena in low velocity or weak gravitational field, where the differences are very small and may be omitted between relative and absolute space-time, so that the space-time of the classical physics was considered to be the absolute space-time. The differences are obvious between these two space-time in high velocity or strong gravitational field, and thus, the relativistic phenomena occur.

A few people or groups' intuitions are not reliable, but the intuitions of entire mankind are the real generally. The absolute space-time, which describes the world with an invariable space-time standard, considers that the space is flat three dimensions and the time is homogeneous one dimension, which is a reflection of human intuitions. However, the actual standard tools of length and time, such as rulers, clocks and light, can vary with the environment due to temperature, velocity and gravitational potential. Thus, there are always certain differences between the actual quantitative relation and the absolute space-time theory. Now the most accurate standards of length and time are defined by light and the invariable velocity of light, for example, a meter is the distance traveled by light in a vacuum in $1/299,792,458$ of a second, where the distance traveled by light in a vacuum in a second is always 299792458 meters whether it is fast or slow, the light speed become an invariable definitional speed, which is just a premise of relativity, so that we can regard the relativity as a quantitative theory with light as the measure of space-time. There seems in absolute space-time theory that the theory of relativity regards a change of space-time standard as a change of space-time itself, which is only a practicable mathematical model.

The description on the basis of absolute space-time theory is called the **absolute description**, which describes the world with an invariable space-time standard. The description on the basis of measuring data is called the **quantitative description**, which describes the world with a variable space-time standard. There are always certain differences between the quantitative and absolute descriptions. The effects caused by this differences or the variability of space-time standards are called **quantitative effects**. The theory of relativity is a theory of quantitative description, and the relativistic effects are the quantitative effects.

There can be different representations one thing in different space-time theory, or there are certain discrepancies between two different space-time theories, that is to say, there seems that any quantitative theory may be twisted more or less by a quantitative effect.

6 The corresponding relationships between two descriptions

Above equations of fluid mechanics are established on the basis of the absolute space-time theory. Using the Lorentz covariance, these equations would be transformed into relativistic space-time theory, and thus, the meaning of related physical quantities will change, so that there are some corresponding relationships between transformation before and after, which is just the meaning of above "the relativistic mass corresponds to the tiny increment of ether density". Because mass is a characteristic of an object (the matter with mass) and does not have spatial extension, and in view of the relationships between mass and a gravitational field, the intrinsic relationship among the ether, gravitational field and objects can be found. The distribution of the ether density is closely related to the objects in the unified ether ocean of the cosmos. The object is the core of the ether density wave-packet, and its mass center is the point of maximal value of the ether density. Here, the corresponding relationships between the quantitative and absolute descriptions are as follows: The absolute

value of the gravitational potential corresponds to the ether density, the intensity of the gravitational field corresponds to the gradient of the ether density, and the mass corresponds to the tiny increment of the ether density (relative to the average density of the ether). The energy corresponds to the tiny increment of the ether pressure (relative to the average pressure of the ether).

As indicated above, the ether is without mass but is closely related to an object. The dimension of ether density equals the dimension of the gravitational potential, it is $m^2 \cdot s^{-2}$, or $m^2 \cdot kg \cdot s^{-2} (energy) / kg (mass)$. The deflection of light in gravitational field can be seen that a light beam bends to where the ether density is higher, which is just as the sound would bend to where the atmosphere density is higher.

An object with mass m , the relation between its gravitational potential ϕ and the distance r away from it is $\phi \propto m / r$. It can be known with simple calculation that the ϕ of the earth $< \phi$ of the sun $< \phi$ of the galaxy and so on at a point of the ground. Therefore Prof. Tsao Chang said: "The ether background field seems a very deep sea, and the change of ether density nearby a object is only small wave on a surface of this sea".^[12] Then it is practicable that the mass of an object is regarded as the tiny increment of density in ideal ether fluid.

7 The quantitative effects equations of relativity and its application

The theory of relativity, in fact, does not depart from the absolute space-time theory because it explains how the space-time standard changes with the help of the relative invariable quantity of the absolute description. The proper quantities in relativity are the particular quantities of absolute description, and thus, there would be certain complementarities between the quantitative and absolute descriptions.

The special theory of relativity shows that the relation between unit length dr or unit time dt and velocity v are

$$dt = \frac{dt_0}{\sqrt{1 - v^2 / c^2}} \quad dr = \sqrt{1 - v^2 / c^2} dr_0 \quad (17)$$

Where dr_0 and dt_0 are the proper unit length and time, respectively. They do not vary with velocity and are used to measure the change of space-time standards on objects in relative motion with any velocity. Thus, they are the unit length and time in the absolute description on this inertia frame of reference, and Eq. (17) is the equations of quantitative effects in the special theory of relativity.

Similarly, it can be proven there are Eq. (18)^[13]

$$dt = \frac{dt_0}{\sqrt{1+2\varphi/c^2}} dr = \sqrt{1+2\varphi/c^2} \quad (18)$$

Where the dt_0 and dr_0 are the proper unit length and unit time on the reference frame that is far away from the gravitational field, the φ is the gravitational potential of a heavenly body. The dt_0 and dr_0 do not vary with the gravitational potential; that is, they are the quantity in the absolute description. Eq. (18) is the equations of quantitative effects in the general theory of relativity.

The equations of quantitative effects can be used to explain relativistic phenomena simply. One example is given below.

The experiment on the delay of radar echo^[14,15] showed that the velocity of light becomes slower in a gravitational field, which can be solved simply using (18): The relation between the velocities of the quantitative description (dr/dt) and the absolute description (dr_0/dt_0) is

$$dr/dt = \frac{\sqrt{1+2\varphi/c^2} dr_0}{dt_0 / \sqrt{1+2\varphi/c^2}} = (1+2\varphi/c^2) dr_0/dt_0 \quad (19)$$

Let the velocity of light without the gravitational field is c . Then, the velocity of light with units dr_0/dt_0 in the gravitational field is

$$c_0 = (1+2\varphi/c^2)c = (1 - \frac{2GM}{c^2 r})c (dr_0/dt_0) \quad (20)$$

Eq. (20) is identical to the calculated result of the general theory of relativity with complex way.

Obviously, the conclusion that the velocity of light becomes slower in a gravitational field is an absolute description, which is the result of measuring the velocity of light over the whole gravitational field with an invariable space-time standard. Quantitatively, the principle of the invariability of the velocity of light is still established because the standards of space-time in a gravitational field can vary with gravitational potential. Using the quantitative space-time standard of one point to measure the velocity of light of this point, according to (19), if the quantitative unit dr/dt is substituted for the absolute unit dr_0/dt_0 in (20), then the velocity of light is always constant c , which shows a complementary between these two descriptions.

8 The mechanism responsible of relativistic effects

The mechanism responsible of relativistic effects was already to be described in certain degree by above ideas of macroscopic vacuum and quantitative effects. The relativistic effects

include kinematical effects of the special theory of relativity and the gravitational effects of the general theory of relativity. Both of them can be seen as the effects of density change in the ether. A change in the ether density causes a change in the actual space-time standard, or where the density of the ether is greater, rulers become shorter, and clocks run more slowly. The kinematical effects are due to the compressibility of the ether: If an object moves in a compressible ether, its own density is increased such that a ruler becomes shorter, and a clock runs more slowly. The gravitational effect is due to the ether density, which corresponds to the gravitational potential, so that where the absolute value of the gravitational potential is greater, a ruler becomes shorter, and a clock runs more slowly.

According to the method of fluid mechanics, the ether can be described as being composed of countless ether particles. Then, the unit length is proportional to an interval between two adjacent ether particles, and the unit time is proportional to the time interval that the light travels through an interval of ether particles. Using such standards to measure the ether, it becomes homogeneous and isotropic, and the light velocity is invariable. In addition, both of the standards of length and time have a relationship with the interval of the ether particles. Thus, the space and time are entangled, and are turned into the four dimensional space-time continuum. Therefore we can say that the ether is the material basis of the relativity.

The general theory of relativity considers that the four dimensional space-time continuum is homogeneous and isotropic but it is bent, where it regards the change rate of standards of space-time as the curvature of time-space. As the absolute space-time theory see it is only a mathematical model describing the distribution of ether is not homogeneous.

9 The limitation of relativity

The relativistic phenomenon is caused by the changes of the ether density. Then, relative motion can be divided into formal motion and substantial motion, the formal motion is that the ether density himself of the moving objects does not change, it would only produce the observed effect and the formulas of relativity are ineffective. The substantial motion is that the ether density himself of the moving objects can change, it would produce real effects, and the formulas of relativity are effective. The phenomenon of the stars moving around the earth is caused by the earth's rotation, which is only the formal motion because they do not affect each other between the ether wave-packets of the earth and stars. Of course, the pure formal motion or pure substantial motion does not exist. It is probable that both of relative motion, one is the substantial motion and the other is formal motion mainly. For example, the movement of a particle in the earth ether field is a substantive motion, while the earth moves relative to this particle is the formal motion because earth ether wave packet does not be affected by the particle overall. The relative motions between the sun and earth, comparatively speaking, the movement of the earth around the sun is a substantive motion, and the movement of the sun around the earth is a formal motion. Therefore the heliocentric

theory is greater than the geocentric theory, and the relativity of the movement is always set up in the form, but both of relative motions are not necessarily equalization essentially.

When a body moves, the ether's distribution around it would change, so that the ether is not an absolute frame of reference. Because the kinematical effects are due to the compressibility of the ether, the ether where an object is located must be used as the reference frame. When studying the movement of a body in the galaxy, the sum of the ether wave-packet without the galaxy could be regarded as a homogeneous background field, and thus, the galactic ether wave-packet should be used as the reference frame. When studying the movement of a planet in the solar system, the galactic ether wave-packet becomes part of the background field because the distance is nearly the same between each planet and the galactic center. Thus, the solar ether wave-packet should be used as the reference frame. However, the solar ether wave-packet also becomes part of the background field on the surface of the earth, and thus, the ether wave-packet of the earth should be used as the reference frame when studying phenomena on the earth. The experiment of atomic clocks flying around the earth conducted by Hafele and Keating in 1971^[16,17] proved this point. The experiment showed that, on average, a flying clock is slower by 59×10^{-9} seconds than a clock on the ground after flying towards the east, and the flying clock is faster by 273×10^{-9} seconds than the clock on the ground after flying towards the west, which demonstrates that "a moving clock is always slower" is not necessarily true. Here, the center of mass of the earth must be taken as the origin of the coordinates system. Only in this way can the calculations with the formulae of the special theory of relativity lead to results that are roughly in agreement with the experiment. Actually, this coordinate system with the center of mass of the earth as the origin is the same as the coordinate system with the ether wave-packet of the earth as the reference frame.

In addition, there are certain approximations in relativity. In the past, the cosmological principle was used to derive the Lorentz transformation intentionally or unconsciously. The meaning of cosmological principle is that the universe is homogeneous and isotropic, which ensures that the Lorentz transformation is linear^[17], and also leads up to his approximation because time and space is closely related to object in relativity, and the cosmological principle can only be a large range of statistical approximation. In fact, the derivation of the Lorentz transformation by means of fluid mechanics in this book also shows the approximation of the relativistic formulas because the formula (2) is linearized, which means that it is conditioned and approximate, and it is correct only in the ether as a complete superfluid. The superfluid would have a certain critical speed, critical density, critical pressure and so on. The ether density can vary with the velocity, and would lose his super-fluidity when it is risen certain height, and thus, the relativistic formulas will be no longer effective. Actually, Einstein said: "For the large field density and the material density, field equations and the field variables in these equations would not have the true mean. Overall, need a clear understanding that the equations must not be extended to this region".^[18] Also we point out that the relativistic mass

is corresponds to the tiny increment of ether density and the relativistic energy is corresponds to the tiny increment of ether pressure. Those indicate that the theory of relativity is ineffective for the dense and huge heavenly body or superluminal.

10 Conclusions

As indicated above, Absolute space-time theory is a scientific abstract, where the ether is a compressible superfluid, whose density field is the gravitational field, and a change in its density causes a change in the actual space-time standard, and thus, relativistic quantitative effects occur. The relativity, which is a quantitative theory with light as the measure of space-time, made up the shortcoming of absolute space-time theory in quantity. Nevertheless as absolute space-time theory sees it, the relativity, which regards the change of the actual space-time standard as the change of space-time itself, is a practicable mathematical model. The absolute and relativistic theories are two different theories in nature. It is not the relation that one negates another and yet there are certain discrepancies, corresponding relationships and complementarities between them. The relativity is quite effective when the increment of ether density is tiny, or the velocity of a body is lower than light velocity; and it is ineffective for the dense and huge heavenly body or superluminal.

References

- [1]H. Casimir, D. Polder, The influence of retardation on the London-van der Waals forces, Phys. Rev, 1948, 73 (4), 360-372.
- [2] Larrimore, L. Vacuum fluctuations and the Casimir force, physics, 115, 1-4(2002).
- [3] Yue Gong (Hu Changwei) , The theory of Interval Field Ether, Potential Science No. 4 1989, pp39-40 (in Chinese).
- [4] Liao Mingsheng, Establishment of the Relativity of Fluid Mechanics Potential Science No. 4 1989, pp33-38, (in Chinese).
- [5] Liao Mingsheng, Invariability Theory of Fluid, Shanghai Science and Technology Press, 1993, (in Chinese).
- [6] Yang X T, *et al.* The application of aerodynamic method in the development of relativity [A]. IWCCPA[C] , Nanjing, China, 2001.
- [7] Yang X T, *et al.* Lorentz time2space relation is only a transform from incompress flow to compress flow[A]. IWCCPA[C], Nanjing, China, 2001.
- [8]Y. C. Fung, A First Course in Continuum Mechanics, Beijing, Tsinghua University Press, 2005, pp. 257-259.
- [9] Л. Д. Ландау, Е. М. Лифшиц, The Mechanics of Continual medium, Beijing, The Publishing House Of People Education, 1960 , p672 (in Chinese).

- [10] Liu Weiping¹, Su Benqing², Xi Deke¹, Yang Xintie. Mackerson-Morei Experiment in Sound Interference of Compressible Fluid, Mechanical Science and Technology for Aerospace Engineering, Vol. 26, No. 9, 2007 (in Chinese).
- [11] S. I. Newton, The Newton's Principia
- [12] Tsao Chang, Research on the Theory of Space and Time, Shanghai Science and Technology Document Press, 2011, p.57 (in Chinese).
- [13] Hu Chang-Wei, Vacuum, Space-time, Matter and the Models of Smarandache Geometry, USA, Educational Publishers, 2012.
- [14] I. I. Shapiro, et al, Phys. Rev. Lett. 20, 1265(1968).
- [15] J. D. Anderson, et al, Astrophys, 200, 221(1975).
- [16] C. Hafele, R. Keating, Around-the-World Atomic Clocks: Predicted Relativistic Time Gains[J], Science, 1972, 177: 166-167.
- [17] C. Hafele, R. Keating, Around-the-World Atomic Clocks: Observed Relativistic Time Gains[J], Science, 1972, 177: 168-170.
- [18] A. Einstein, The Meaning of Relativity, Fifth Edition, 1955.

New Gravitational Formula: $\bar{F} = -\frac{mc^2}{R}$

Jiang Chun-Xuan

P. O. Box 3924, Beijing 100854, P. R. China

123jiangchunxuan@gmail.com

Abstract: Using two methods we deduce the new gravitational formula. Gravity is the tachyonic centripetal force. Anybody may understand gravity. This paper is the first human to a true description of gravity.

In the Universe there are two matters: (1) Observable subluminal matter called tardyon and (2) unobservable superluminal matter called tachyon which coexist in motion. Tachyon can be converted into tardyon, and *vice versa*. Tardyonic rotating motion produces the centrifugal force, but tachyonic rotating motion produces the centripetal force, that is gravity. In this paper using tardyonic and tachyonic coexistence principle we deduce the new gravitational formula,

We first define two-dimensional space and time number [1]

$$Z = \begin{pmatrix} ct & x \\ x & ct \end{pmatrix} = ct + jx, \quad (1)$$

where x and t are the tardyonic space and time coordinates, c is light velocity in vacuum,

$$j = \begin{pmatrix} 0 & 1 \\ 1 & 0 \end{pmatrix}.$$

(1) can be written as Euler form

$$Z = ct_0 e^{j\theta} = ct_0 (\text{ch}\theta + j \text{sh}\theta), \quad (2)$$

where ct_0 is the tardyonic invariance, θ tardyonic hyperbolic angle.

From (1) and (2) we have

$$ct = ct_0 \text{ch}\theta, \quad x = ct_0 \text{sh}\theta \quad (3)$$

$$ct_0 = \sqrt{(ct)^2 - x^2}. \quad (4)$$

From (3) we have

$$\theta = \text{th}^{-1} \frac{x}{ct} = \text{th}^{-1} \frac{u}{c}. \quad (5)$$

where $c \geq u$ is the tardyonic velocity.

Using the morphism $j : z \rightarrow jz$, we have

$$jz = \bar{x} + jc\bar{t} = \bar{x}_0 e^{j\bar{\theta}} = \bar{x}_0 (\text{ch } \bar{\theta} + j \text{sh } \bar{\theta}), \quad (6)$$

where \bar{x} and \bar{t} are the tachyonic space and time coordinates, \bar{x}_0 is tachyonic invariance, $\bar{\theta}$ tachyonic hyperbolical angle.

From (6) we have

$$\bar{x} = \bar{x}_0 \text{ch } \bar{\theta}, \quad c\bar{t} = \bar{x}_0 \text{sh } \bar{\theta}. \quad (7)$$

$$\bar{x}_0 = \sqrt{(\bar{x})^2 - (c\bar{t})^2}. \quad (8)$$

From (7) we have

$$\bar{\theta} = \text{th}^{-1} \frac{c\bar{t}}{\bar{x}} = \text{th}^{-1} \frac{c}{\bar{u}}. \quad (9)$$

where $\bar{u} \geq c$ is the tachyonic velocity.

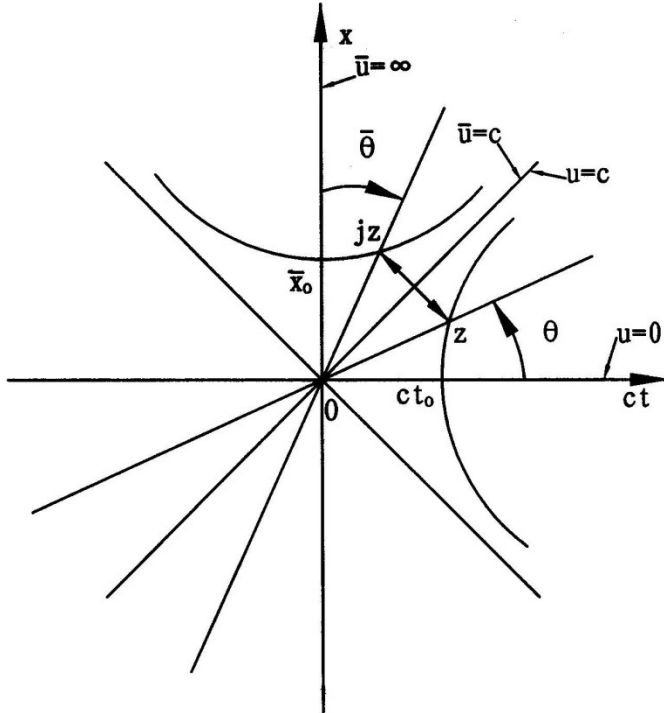

Fig. 1. Tardyonic and tachyonic coexistence principle

Figure 1 shows the formulas (1)-(9). $j : z \rightarrow jz$ is that tardyon can be converted into tachyon, but $j : jz \rightarrow z$ is that tachyon can be converted into tardyon. $u = 0 \rightarrow u = c$ is the positive acceleration, but $\bar{u} = \infty \rightarrow \bar{u} = c$ is the negative acceleration, which coexist. At the x - axis we define the tachyonic unit length

$$\bar{X}_0 = \lim_{\substack{\bar{u} \rightarrow \infty \\ t \rightarrow 0}} \bar{u}t = \text{constant}. \quad (10)$$

Since at rest the tachyonic time $t = 0$ and $\bar{u} = \infty$, we prove that tachyon is unobservable.

Assume $\theta = \bar{\theta}$, from (5) and (9) we get the tardyonic and tachyonic coexistence principle [1-4]

$$u\bar{u} = c^2. \quad (11)$$

Using the analytical method we deduce the new gravitational formula. Differentiating (11) by the time, we get

$$\frac{d\bar{u}}{dt} = -\left(\frac{c}{u}\right)^2 \frac{du}{dt}. \quad (12)$$

$\frac{du}{dt}$ and $\frac{d\bar{u}}{dt}$ can coexist in motion, but their directions are opposite.

We study the tardyonic and tachyonic rotating motions. In 1673 Huygens discovered that the tardyonic rotation produces centripetal acceleration

$$\frac{du}{dt} = \frac{u^2}{R}, \quad (13)$$

where R is rotating radius.

Substituting (13) into (12) we have the tachyonic centrifugal acceleration

$$\frac{d\bar{u}}{dt} = -\frac{c^2}{R}. \quad (14)$$

(13) and (14) have the same form. From (13) we get the tardyonic centrifugal force

$$F = \frac{Mu^2}{R}, \quad (15)$$

where M is the inertial mass.

From (14) we get the tachyonic centripetal force, that is gravity

$$\bar{F} = -\frac{mc^2}{R}, \quad (16)$$

where m is the gravitational mass converted into by tachyonic mass \bar{m} . Eqs. (15) and (16) have the same form. Eq. (16) is the new gravitational formula.

Using the geometrical method we deduce the new gravitational formula...

Figure 2 shows that the rotation ω of body A emits tachyon mass \bar{m} , which forms the tachyon and gravitation field and gives the body B revolutions u and \bar{u} .

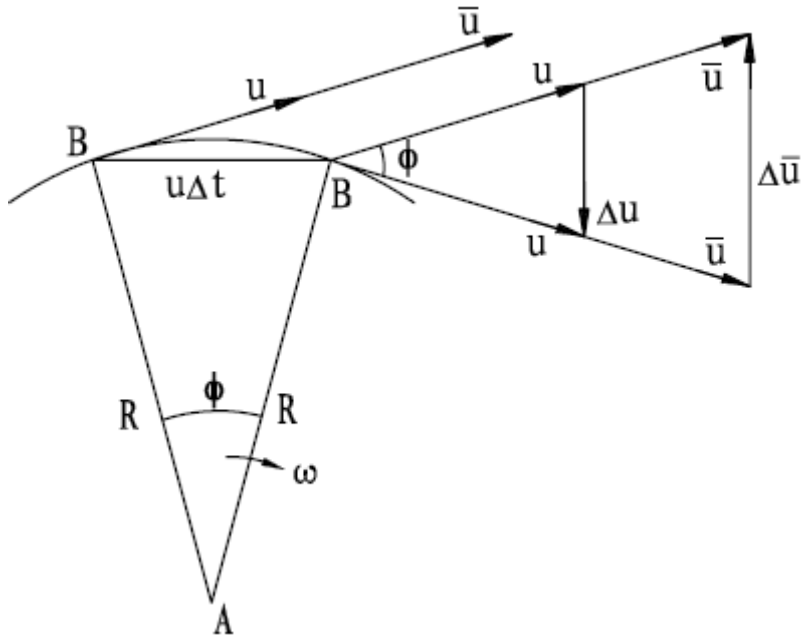

Fig.2. On body B $\frac{du}{dt}$ and $\frac{d\bar{u}}{dt}$ coexistence [2].

From Fig. 2 .it follows

$$\frac{u\Delta t}{R} = \frac{\Delta u}{u} . \quad (17)$$

From (17) it follows the tardyon centripetal acceleration on the body B [2-4],

$$\frac{du}{dt} = \lim_{\substack{\Delta u \rightarrow 0 \\ \Delta t \rightarrow 0}} \frac{\Delta u}{\Delta t} = \frac{u^2}{R} . \quad (18)$$

From Fig. 2. it follows

$$\frac{u\Delta t}{R} = -\frac{\Delta \bar{u}}{\bar{u}} . \quad (19)$$

From (19) and (11) it follows the tachyon centrifugal acceleration on the body B [2-4],

$$\frac{d\bar{u}}{dt} = \lim_{\substack{\Delta \bar{u} \rightarrow 0 \\ \Delta t \rightarrow 0}} \frac{\Delta \bar{u}}{\Delta t} = -\frac{u\bar{u}}{R} = -\frac{c^2}{R} . \quad (20)$$

On body B $\frac{du}{dt}$ and $\frac{d\bar{u}}{dt}$ coexistence.

From (18) it follows the tardyon centrifugal force on body B [2-4],

$$F = \frac{M_B u^2}{R}, \quad (21)$$

where M_B is body B mass.

From (20) it follows the tachyon centripetal force on body B , that is gravity [2-4],

$$\bar{F} = -\frac{mc^2}{R}, \quad (22)$$

where m is the gravitation mass converted into by tachyon mass \bar{m} which is unobservable, but m is observable.

(22) is the new gravitational formula. On body B F and \bar{F} coexistence.

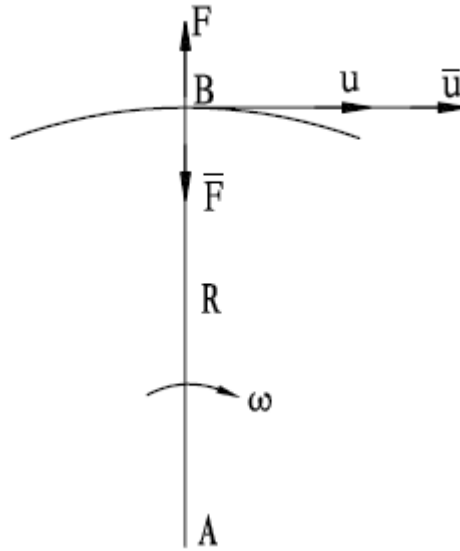

Fig.3. On body B F and \bar{F} coexistence[2].

From Fig. 3, it follows

$$F + \bar{F} = 0. \quad (23)$$

From (21), (22) and (23) it follows

$$\frac{m}{M_B} = \frac{u^2}{c^2}. \quad (24)$$

Body B increases mass m and centrifugal force is greater than gravitation force, then body B expands outward.

From (22) it follows Newtonian gravitation formula. The m is proportional to body A mass M_A , in (24) m is proportional to M_B , is inversely proportional to the distance R between body A and body B . It follows

$$m = k \frac{M_A M_B}{R}, \quad (25)$$

where k is constant

Substituting (25) into (22) it follows the Newtonian gravitation formula [2-4]

$$\bar{F} = -G \frac{M_A M_B}{R^2}, \quad (26)$$

where $G = kc^2 = 6.673 \times 10^{-8} \text{ cm}^3 / \text{g} \cdot \text{sec}^2$ is gravitation constant.

References

- [1] Chun-Xuan Jiang, A Theory of Morphisms Between the Tardyon and Tachyon, Physics(Chinese), 4. (1975)119-125.
- [2] Chun-Xuan Jiang, On Nature for Gravitation, J. Beijing observatory (Chinese), 7(1976)32-38.
- [3] Chun-Xuan Jiang, An Approach on the Nature of Attractive Force, Potential Science (Chinese), 4(1982)19-20.
- [4] Chun-Xuan Jiang, A Unified Theory of the Gravitational and Strong Interactions, Hadronic J., 24(2001)629-638.

The Expansion Theory of the Universe without Dark Energy

Jiang Chun-Xuan

P. O. Box 3924, Beijing 100854, P. R. China

jexxxx@163.com

Abstract: This paper found a new gravitational formula: $\bar{F} = -mc^2/R$, established the expansion theory of the universe, and obtained the expansion acceleration: $g_e = u^4/C^2R$.

Keywords: The universe equation; the universe expansion theory

1 Introduction

According to Jiang idea[1], in the Universe there are two kinds of matter: (1) Observable subluminal matter called tardyons(locality) and (2) unobservable superluminal matter called tachyons(non-locality). They coexist in motion. What are tachyons? Historically tachyons are described as particles which travel faster than light. Describing tachyon as a particle with an imaginary mass is wrong[2]. In our theory[1] tachyon has no rest time and no rest mass. It is unobservable. Tachyons can be converted into tardyons and vice versa. Tardyonic rotating motion produces the centrifugal force but tachyonic rotating motion produces the centripetal force which is force of gravity. Using the coexistence principle of tardyons and tachyons it follows that

a new gravitational formula: $\bar{F} = -mc^2/R$. We establish the expansion theory of the universe. We obtain the expansion acceleration:

$$g_e = u^4/C^2R.$$

2 The new gravitational formula: $\bar{F} = -mc^2/R$

We first define two-dimensional space and time number[1]

$$z = \begin{pmatrix} ct & x \\ x & ct \end{pmatrix} = ct + jx, \quad (1)$$

where x and t are the tardyonic space and time coordinates, c is light velocity in vacuum,

$$j = \begin{pmatrix} 0 & 1 \\ 1 & 0 \end{pmatrix}.$$

(1) can be written in Euler form

$$z = ct_0 e^{j\theta} = ct_0 (\text{ch } \theta + j \text{sh } \theta), \quad (2)$$

where ct_0 is the tardyonic invariance, and θ is the tardyonic hyperbolic angle.

From (1) and (2) it follows

$$ct = ct_0 \operatorname{ch} \theta, \quad x = ct_0 \operatorname{sh} \theta \quad (3)$$

$$ct_0 = \sqrt{(ct)^2 - x^2}. \quad (4)$$

From (3) it follows

$$\theta = \operatorname{th}^{-1} \frac{x}{ct} = \operatorname{th}^{-1} \frac{u}{c}. \quad (5)$$

where $c \geq u$ is the tardyonic velocity, $\operatorname{ch} \theta = \frac{1}{\sqrt{1-(u/c)^2}}$ and $\operatorname{sh} \theta = \frac{u/c}{\sqrt{1-(u/c)^2}}$.

The z denotes space-time of the tardyonic theory.

Using the morphism $j : z \rightarrow jz$, it follows

$$jz = \bar{x} + jc\bar{t} = \bar{x}_0 e^{j\bar{\theta}} = \bar{x}_0 (\operatorname{ch} \bar{\theta} + j \operatorname{sh} \bar{\theta}), \quad (6)$$

where \bar{x} and \bar{t} are the tachyonic space and time coordinates, \bar{x}_0 is tachyonic invariance, $\bar{\theta}$ tachyonic hyperbolic angle.

From (6) it follows

$$\bar{x} = \bar{x}_0 \operatorname{ch} \bar{\theta}, \quad c\bar{t} = \bar{x}_0 \operatorname{sh} \bar{\theta}. \quad (7)$$

$$\bar{x}_0 = \sqrt{(\bar{x})^2 - (c\bar{t})^2}. \quad (8)$$

From (7) it follows

$$\bar{\theta} = \operatorname{th}^{-1} \frac{c\bar{t}}{\bar{x}} = \operatorname{th}^{-1} \frac{c}{\bar{u}}. \quad (9)$$

where $\bar{u} \geq c$ is the tachyonic velocity, $\operatorname{ch} \bar{\theta} = \frac{1}{\sqrt{1-(c/\bar{u})^2}}$ and

$$\operatorname{sh} \bar{\theta} = \frac{c/\bar{u}}{\sqrt{1-(c/\bar{u})^2}}.$$

The jz denotes space-time of the tachyonic theory. Both the z and the jz form the entire world but the jz world is unexploited and unstudied.

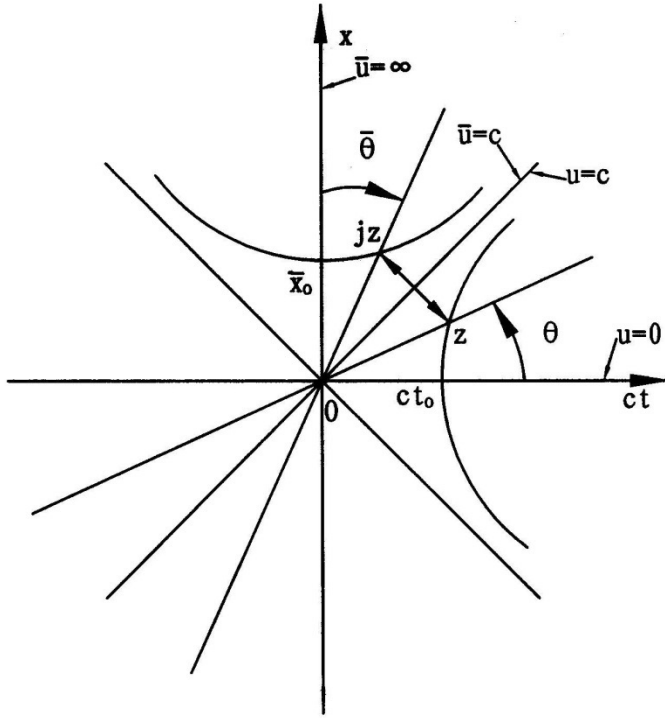

Fig. 1. Minkowskian space-time diagram

Figure 1 shows the formulas (1)-(9). $j : z \rightarrow jz$ shows that a tardyon can be converted into a tachyon, but $j : jz \rightarrow z$ shows that a tachyon can be converted into a tardyon. $u = 0 \rightarrow u = c$ is a tardyonic velocity, but $\bar{u} = \infty \rightarrow \bar{u} = c$ is a tachyonic velocity, which coexist. At the $x -$ axis we define the tachyonic string length

$$\bar{x}_0 = \lim_{\substack{\bar{u} \rightarrow \infty \\ t \rightarrow 0}} \bar{u}t = \text{constant}. \quad (10)$$

where t is the rest time.

Since at rest the tachyonic string time $t = 0$ and $\bar{u} = \infty$, it shows that the tachyon is a string which is unobservable. In the rest system the tachyonic string motion is an action-at-a distance motion. This simple thought made a deep impression on me. It impelled me toward the only string theory[1]. Other string theories all are guesses.

Assume $\theta = \bar{\theta}$, from (5) and (9) it follows that the tardyonic and tachyonic coexistence principle[1,3,4]

$$u\bar{u} = c^2 \quad (11)$$

Differentiating (11) by the time, it follows

$$\frac{d\bar{u}}{dt} = -\left(\frac{c}{u}\right)^2 \frac{du}{dt}. \quad (12)$$

$\frac{du}{dt}$ and $\frac{d\bar{u}}{dt}$ can coexist in motion, but their directions are opposite.

We study the tardyonic and tachyonic rotating motions. The tardyonic rotation produces centripetal acceleration

$$\frac{du}{dt} = \frac{u^2}{R}, \quad (13)$$

where R is rotating radius.

Substituting (13) into (12) it follows that the tachyonic rotating produces centrifugal acceleration

$$\frac{d\bar{u}}{dt} = -\frac{c^2}{R}. \quad (14)$$

It is independent of tachyonic velocity \bar{u} , only inversely proportional to radius R .

Eqs. (13) and (14) are dual formulas, which have the same form. It is unique and perfect.

From (13) it follows the tardyonic centrifugal force

$$F = \frac{Mu^2}{R}, \quad (15)$$

where M is the inertial mass.

From (14) it follows the tachyonic centripetal force, that is gravity

$$\bar{F} = -\frac{mc^2}{R}, \quad (16)$$

where m is the gravitational mass converted into by tachyonic mass \bar{m} which is unobservable but m is observable.

Whether $u = 0$ or $u \neq 0$, all matter produces gravity. Eqs. (15) and (16) are dual formulas, which have the same form. Eq. (16) is a new gravitational formula called an equation that changed the universe. This simple thought made a deep impression on me. It impelled me toward a theory of gravitation. It has simplicity, elegance and mathematical beauty. It is the foundations of gravitational theory and cosmology. In the universe there are two main forces: The tardyonic centrifugal force (15) and tachyonic centripetal force (16) which make structure formation of the universe.

Now we study the freely falling body. Tachyonic mass \bar{m} can be converted into tardyonic mass m , which acts on the freely falling body and produces the gravitational force

$$\bar{F} = -\frac{mc^2}{R}, \quad (17)$$

where R is the Earth radius.

We have the equation of motion

$$\frac{mc^2}{R} = Mg, \quad (18)$$

where g is gravitational acceleration, M is mass of freely falling body.

From (18) it follows the gravitational coefficient

$$\eta = \frac{m}{M} = \frac{Rg}{c^2} = 6.9 \times 10^{-10}. \quad (19)$$

Eötvös(1922) experiment $\eta \sim 5 \cdot 10^{-9}$ and Dicke experiment $\eta \sim 10^{-11}$ [5]. Since the gravitational mass m can be transformed into the rest mass in freely falling body, we define Einstein's gravitational mass $M_g = M_i + m$ and inertial mass $M_i = M$ [6]. It follows

$$M_g > M_i. \quad (20)$$

Therefore it shows that the principle of equivalence is nonexistent.

3The expansion theory of the universe

The Big Bang threw all the matter in the universe outwards. Both Newton's and Einstein's theories of gravity predict that the expansion must be slowing down to some degree: The mutual gravitational attraction of all the matter in all the galaxies should be pulling them inwards. But measurements of distant supernovae show just the opposite[7]. All the matter in the universe appears to be accelerating outwards. Its speed is picking up. There is no agreement yet about how to explain these mysterious observations. Now we explain our accelerating universe.

Using (16) we study the expansion theory of the Universe. Figure 2 shows an expansion model of the Universe. The rotation ω_1 of body A emits tachyonic flow, which forms the tachyonic field. Tachyonic mass \bar{m} acts on body B , which produces its rotation ω_2 , revolution u and gravitational force

$$\bar{F}_1 = -\frac{mc^2}{R}, \quad (21)$$

where R denotes the distance between body A and body B , m is gravitational mass converted into by tachyonic mass \bar{m} which is unobservable but m is observable.

The revolution of the body B around body A produces the centrifugal force

$$F_1 = \frac{M_B u^2}{R}, \quad (22)$$

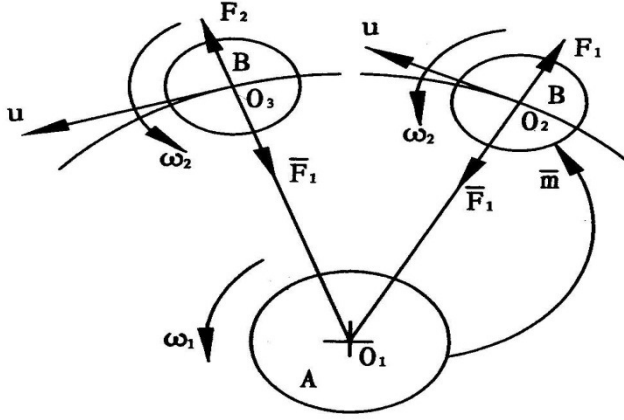

Fig. 2. An expansion model of the Universe

where M_B is the inertial mass of body B , u is the orbital velocity of body B .

At the O_2 point we assume

$$F_1 + \bar{F}_1 = 0. \quad (23)$$

From (23) it follows that the coexistence of the gravitational force and centrifugal force.

From (21)-(23) it follows the gravitational coefficient

$$\eta = \frac{m}{M_B} = \left(\frac{u}{c}\right)^2. \quad (24)$$

At the O_3 point the tachyonic mass \bar{m} can be converted into the rest mass m in body B , it follows

$$F_2 = \frac{M_B u^2}{R} + \frac{m u^2}{R}. \quad (25)$$

Since $F_2 + \bar{F}_1 > 0$, centrifugal force F_2 is greater than gravitational force \bar{F}_1 , then the body

B expands outwards and its mass increases. This is an expansion mechanism of the Universe.

From (21)-(23) we have

$$F_2 + \bar{F}_1 = \frac{m u^2}{R} = M_B g_e \quad (26)$$

From (26) we obtain the expansion acceleration

$$g_e = \frac{m u^2}{M_B R} \quad (27)$$

Substituting (24) in (27) we obtain

$$g_e = \frac{u^4}{C^2 R} \quad 136$$

(28)

If body A is the Earth, then body B is the Moon; if body A is the Sun, then body B is the Earth; It can explain our accelerating universe. In this model universe there are no dark matter and no dark energy. This simple thought made a deep impression on me. It impelled me toward an expansion theory of the universe without dark matter and dark energy.

If the body A is the Sun and body B is the planet. We calculate the gravitational coefficients η as shown in table 1.

Table 1: Values of the gravitational coefficients η

Planet	u (km/sec)	$\eta(10^{-10})$
Mercury	47.89	255.2
Venus	35.03	136.5
Earth	29.79	98.7
Mars	24.13	64.8
Jupiter	13.06	19.0
Saturn	9.64	10.3
Uranus	6.81	5.2
Neptune	5.43	3.3
Pluto	4.74	2.5

Since gravitational mass m can be transformed into the rest mass in body B , we define

Einstein's gravitational mass $M_g = M_i + m$ and inertial mass $M_i = M_B$ [6].

It follows

$$M_g > M_i. \quad (29)$$

Therefore it shows that the principle of equivalence in the Solar system is nonexistent. Of all the principles at work in gravitation, none is more central than the principles of equivalence[5], which could be wrong.

The tachyonic mass \bar{m} can be converted into electrons and positrons which are the basic building-blocks of elementary particles [8,9]. In this universe there are no Higgs particles. They have not been produced at the Large Hadron Collider and other particle accelerators.

From (21) it follows Newtonian gravitational formula. The m is proportional to M_A , which

denotes inertial mass of body A , in (24) m is proportional to M_B , is inversely proportional to the distance R between body A and body B . It follows

$$m = k \frac{M_A M_B}{R}, \quad (30)$$

where k is a constant.

Substituting (30) into (21) it follows Newtonian gravitational formula[3,4]

$$\bar{F}_1 = -G \frac{M_A M_B}{R^2}, \quad (31)$$

where $G = kc^2$ is a gravitational constant.

We have Einstein's gravitational mass

$$M_g = M_i + m = M_i(1 + \eta). \quad (32)$$

Substituting (32) into (31) it follows Newtonian generalized gravitational formula

$$\bar{F}_1 = -G \frac{M_A(1 + \eta_A)M_B(1 + \eta_B)}{R^2}, \quad (33)$$

where η_A and η_B denote gravitational coefficients of body A and body B separately.

Assume ρ_A and ρ_B denote the densities of body A and body B separately. In the same way from (33) it follows unified formula of the gravitational and strong forces [4]

$$\bar{F}_1 = -G_0 \frac{\rho_A M_A(1 + \eta_A)\rho_B M_B(1 + \eta_B)}{R^2} \quad (34)$$

where $G_0 = 5.2 \times 10^{-10} \text{ cm}^9/\text{g}^3 \cdot \text{sec}^2$ is a new gravitational constant.

In the nucleus exists the strong interactions. It follows[4]

$$\frac{\text{Strong interaction}}{\text{Gravitational interaction}} = \frac{G_s}{G_g} = 10^{38} \quad (35)$$

where $G_g = 6.7 \times 10^{-8} \text{ cm}^3/\text{g} \cdot \text{sec}^2$ and $G_s = 6.7 \times 10^{30} \text{ cm}^3/\text{g} \cdot \text{sec}^2$

In the nucleus we assume $\rho_A = \rho_B = \rho$. From (34) it follows

$$G_s = G_0 \rho^2 \quad (36)$$

From (36) it follows the formula of the particle radii

$$r = 1.55[m(\text{Gev})]^{1/3} \text{ jn}, \quad (37)$$

where $1 \text{ jn} = 10^{-15} \text{ cm}$ and m (Gev) is the mass of the particles.

From (37) it follows that the proton and neutron radii are 1.5 jn [4,10]. Pohl et al measure the proton diameter 3 jn [11].

We have the formula of the nuclear radii [12]

$$r = 1.2(A)^{1/3} \text{ fm}, \quad (38)$$

where $1 \text{ fm} = 10^{-13} \text{ cm}$ and A is its mass number.

It shows that (37) and (38) have the same form. The particle radii $r < 5 \text{ jn}$ and the nuclear radii $r < 7 \text{ fm}$.

Similar to equation (10) we define the tachyonic momentum of a string length \bar{x}_0 [1,4].

$$\bar{P}_0 = \lim_{\substack{m_0 \rightarrow 0 \\ \bar{u} \rightarrow \infty}} m_0 \bar{u} = \text{const}, \quad (39)$$

where m_0 is tachyonic string rest mass.

Since $\bar{u} \rightarrow \infty$ and $t = 0$, tachyonic string has no rest mass and no rest time, it shows that tachyon is unobservable, that gravity is action-at-a-distance and gravitational wave is unobservable. If quantum teleportation, quantum computation and quantum information are the tachyonic motion [13], then they are unobservable.

4 Conclusion

Special relativity is the tardyonic theory. Einstein pointed out those velocities greater than that of light have –as in our previous results–no possibility of existence [14], which could be wrong. But gravitation is the tachyonic theory and an action-at-a-distance.

What is gravity? Newton wrote, “I have not been able to discover the cause of those properties of gravity from phenomena, and I frame no hypotheses” Einstein’s theory of general relativity answered Newton’s question: Mass causes space-time curvature which is wrong. Gravity is the tachyonic centripetal force.

Where did we come from? Where are we going? What makes up the universe? These questions have occupied mankind for thousands of years. Over the course of history, our view of the world has changed. Theologians and philosophers, physicists and astronomers have given us very different answers. Where did we come from? We answer these questions this way $\bar{m} \rightarrow m$, tachyons \rightarrow tardyons, that is gravitons can be converted into the electrons and positrons which are the basic building-blocks of particles. In this model Universe there are no quarks and no Higgs particles. Where are we going? We answer this question this way $m \rightarrow \bar{m}$, that is the tardyons produce tachyons. The tardyons and tachyons make up the Universe.

Jiang found a gravitational formula[3] : $\bar{F} = -\bar{m}c^2/R$, where \bar{m} is the tachyonic mass. In 2004 Jiang studied the Universe expansion and found $\bar{F} = -mc^2/R$, where m is gravitational mass converted into by tachyonic mass \bar{m} .

References

- [1] Jiang,C-X.A Theory of Morphisms Between the Tardyons and Tachyons, Wuli (Physics) (Chinese), 4, (1975)119-125.
- [2] Mignani, R. and Recami, E,Classical Theory of Tachyons(Special relativity extended to superluminal frames and objects).Rivista Del Nuovo Cimento,4,(1974)209-290.
- [3] Jiang,C-X,On Nature of Gravity, J. Beijing Observatory (Chinese), 7,(1976)32-38.
- [4] Jiang,C-X.,A Unified Theory of the Gravitational and Strong Interactions, Hadronic J.,Vol.24(2001)629-638.
- [5] Misner,C.W.et al(eds). Gravitation,Preeman,1050.1973.
- [6] Einstein,A.The Meaning of Relativity(6-th ed., Chapman and Hall,London),56.1967.
- [7] Perlmutter,S. Supernovae, Dark Energy, and the Accelerating Universe, Physics Today,(2003)53-59.April.
- [8] Jiang,C-X).A Simple Approach to the Computation of the Total Number of Hadronic Constituents in Santilli Model, Hadronic J,Vol.3,(1979)256-292.
- [9]Jiang,C-X.,A Mathematical Model for Particle Classification,Acta Math.,Scientia,Vol.8,(1988)133-144.
- [10] Jiang,C-X.,Determination of Proton and Neutron Radii,APEIRON,Vol.3 Nr.3-4July-Oct.(1996)126
- [11] Pohl,R.et al,The Size of the Proton, Nature 466,(2010)213-216.
- [12] Beiser,A,Concepts of Modern Physics,Mcgraw-Hill Book Company,371.1973.
- [13] Horodecki,R,et al(eds). Quantum Entanglement, Rev. Mod. Phys., Vol.81, No. 2.(2009) 865-942.
- [14] Einstein,A.Zur Elektrodynamik Bewegter Korper,Ann.Phys.,17,(1905)891-921.

An Unsettled Issue of Time in Relativity Theory and New Comprehension on Time

Liu Taixiang

Abstract: Einstein regarded time as an item independent of space, and called three-dimensional space and one-dimensional time jointly as four-dimensional space-time, i.e., Einstein did not acknowledge the inseparability between time and space. On the basis of the system relativity, the author firstly proves the absoluteness of movement, and then deduces the conclusion that time derives from movement, then subsequently obtains such properties of time as one dimension, irreversibility, infiniteness, non-uniformity and relativity, etc., by illustrating the relationship between time and space and the concept of universe state, and ultimately deduces a steady cosmological model and a prospect of total universe.

Keywords: Relativity theory, time, time density, time-dependent space, Time Island, time-dependent reference frame.

Foreword

Einstein regarded time as an item independent of space, and called three-dimensional space and one-dimensional time jointly as four-dimensional space-time, i.e., Einstein did not acknowledge the inseparability between time and space. Therefore the author believes that the physical revolution launched by Einstein is not thoroughgoing, which is why he failed to establish the “unified field theory” regardless of his consumption of lifelong energy.

American physicist L. Smolin asserts that the dilemmas confronted by string theory, loop quantum gravity and other means trying to unify physics all originate from some wrong assumptions, among which the key issue lies in the nature of time. In deep meaning in both quantum theory and general relativity, the nature of time has been wrongly understood^[1]. The author has deduced the properties of time that are different in some aspects in accordance with system relativity^[2].

1 Time and Movement

We know that there are two kinds of object motion, linear motion and angular motion. The velocity v in linear motion is indicated by the ratio of movement distance a to the required time t , i.e., $v=a/t$; the angular velocity ω in angular motion is indicated by the ratio of rotation angle θ to the required time t , i.e., $\omega=\theta/t$. Thus it can be perceived that time and movement are inseparable.

1.1 Absoluteness of Substance Movement

It is acknowledged in both philosophy and physics that movement is the basic pattern of

substance existence, substance and movement are inseparable. However, why substance movement is inevitable. The integrated explanation on the issue was not given in either philosophy or physics.

According to system relativity, the vast and boundless space is made up of fluid state (continuous state) substance, space is the expression of the static property of the fluid state substance, and field is the embodiment of the dynamic property of the fluid state substance, therefore space and field are unified, and their entities are all fluid state substances, thus it can be perceived that the space in system relativity corresponds to the ground state (i.e., vacuum) of quantum field.

According to system relativity, S is the elementary unit in constituting space, the S in space are arranged together seamlessly and tightly, just like the combination of pulmonary alveolus. Due to the evenness and elasticity S, space is an ideal continuous medium. Each S has an energy portion e_0 . If S volume V tends to be infinitely great, the space energy density $\rho=e_0/V=0$, and the S is in static state, i.e., the movement velocity v of S equals 0; If the S volume is limited, the space energy density $\rho > 0$, and the velocity v of S is > 0 . Obviously the change of S volume will lead to the change of its motion state, and vice versa, i.e., the form of S and its motion state interact as both cause and effect. It can be deduced from this that space movement is a spontaneous mechanism of fluid state substance that can undergo without external motivation.

Space movement is vortex movement. At the effect of self-induced movement, an S is continuously deformed and ultimately an isolated round line vortex ---vortex ring, takes shape, which is the solitary wave solution nonlinear Schrodinger equation on the space made up of the S. In accordance with Biot-Savart formula, this vortex ring formed by a single S moves along its axis in a constant velocity of \underline{v}_c without getting its appearance changed [3].

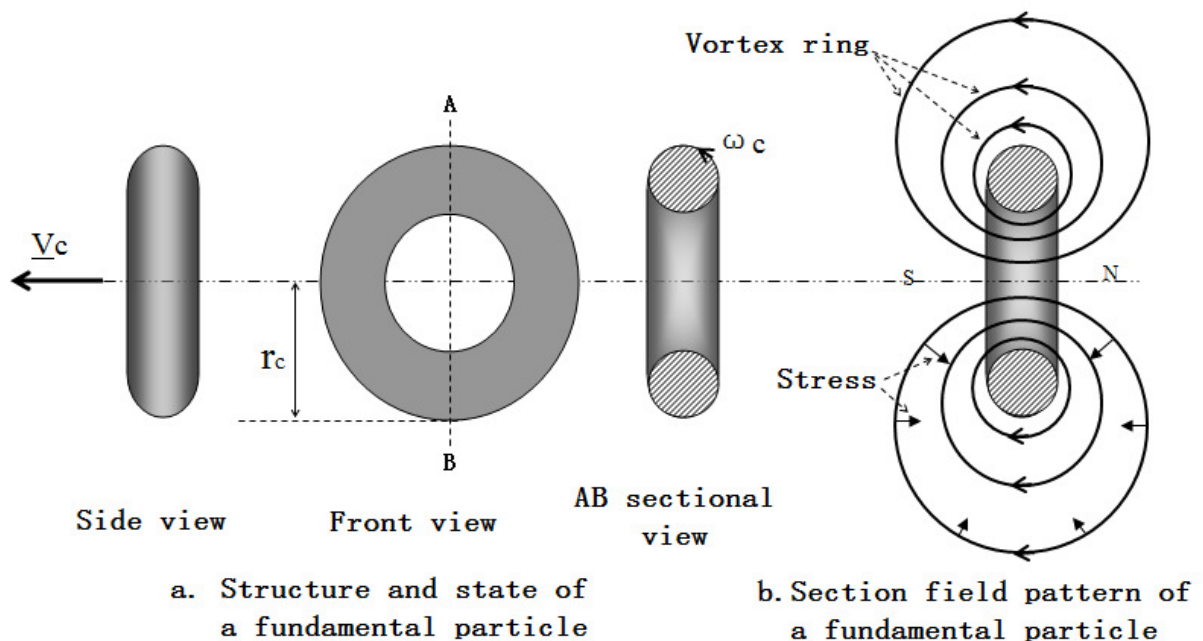

Figure 1. Structure and field of a fundamental particle cn

The rigid body form vortex ring formed through S saltus is called fundamental particle cn , as shown in figure 1.

The constant velocity \underline{v}_c of a fundamental particle cn is called cn 's **inherent velocity**. It can be known from the author's "Generality of Motion and Velocity of Light" (Published on P16-19 of periodical s2 of science edition of Journal of Shandong University, year 2011) that cn 's inherent velocity \underline{v}_c multiplied by the cube root of its surface space density ρ_c is a constant \underline{k}_v , i.e. :

$$\underline{v}_c \rho_c^{1/3} = \underline{k}_v \quad (1)$$

Due to the difference of the space densities of various objects (including various kinds of particles), their respective inherent speeds \underline{v} are different from each other. Suppose the space density on object surface is ρ_0 , then $\underline{v} \rho_0^{1/3} = \underline{v}_c \rho_c^{1/3} = \underline{k}_v$, i.e. :

$$\underline{v} = \underline{k}_v / \rho_0^{1/3} \quad (2)$$

This is the general formula on the inherent speed of objects, $\underline{k}_v = \underline{v}_c \rho_c^{1/3}$ is **absolute constant of motion**. It is easy to perceive that the inherent velocity of an object is inversely proportional to the cube root of its surface space density.

Obviously, **the inherent speed \underline{v} of an object is permanently greater than zero, therefore object movement has absoluteness**. Surely the inherent velocity refers to the relative velocity between rigid state substance (i.e., object) and fluid state substance (i.e., space or field), the relative velocity between various objects is ≥ 0 (please refer to *Generality of Motion and Velocity of Light* for detail). The movement generally mentioned by us refers to the relative movement between the various objects.

1.2 Time is the Concept Deriving from Movement

In system relativity, it is considered that the nature of an object is energy. It has the properties of volume (i.e., three-dimensional property) and movement (i.e., the relative movement between objects). The properties of energy and volume of an object exist independently without relying on the outside world, however, the movement property of an object is a form of existence shown with the external environment as background, therefore, the movement property of an object relies on the external environment, in other words, **the movement property of an object derives from the external environment**.

The movability of an object is shown by the endless movement and evolution process of

cosmic things, the process can be quantified into a series of “events”. During the observation on an event, the external periodical event (like sunrise or sunset) becomes a background for observation, the period of the background event naturally becomes a kind of gauge for us to measure the event being observed. The physical significance of the value acquired through the measurement on the event via the gauge is called **time** by us, the value magnitude indicates time span, the gauge is **time gauge**.

Just like what Wheeler says, physics should be rebuilt on a new basis, and in the new physical system, the formation of time will be through derivation^[4]. If there is no movement, there is no event, and therefore the periodicity of the “event” course does not exist, there is no certain background for our observation on the outside movement course, and naturally there is no the generation of the concept of time. Therefore, **time is the concept deriving from movement**, surely **time relies on the external environment for existence**.

2 Time and Universe State

It can be deduced from universe state that time has such properties as one dimension, irreversibility and infiniteness, etc.

2.1 One Dimension of Time

During the endless course of movement and evolution of cosmic things, each moment corresponds to a cosmic state called as **universe state** $\Psi_U(t)$ for short. The assembly of the universe states in various moments constitutes a universe state sequence:

$$\dots\dots, \Psi_U(t_{n-1}), \Psi_U(t_n), \Psi_U(t_{n+1}), \dots\dots$$

The one-dimension property of universe state sequence results in the **one-dimension property** of time. As shown in figure 2, if t_n is regarded as current moment, then t_{n-1} is the moment that has passed, and t_{n+1} is the moment that is to come. Therefore, **time is directional**, the directional time is called “**time arrow**” by Hawking.

2.2 Irreversibility of Time

The assembly of universe state sequences is called universe U, hence universe U can be expressed as:

$$U = \sum \Psi_U(t_n) \quad (\text{the value of } n \text{ ranges from } -\infty \text{ to } +\infty) \quad (3)$$

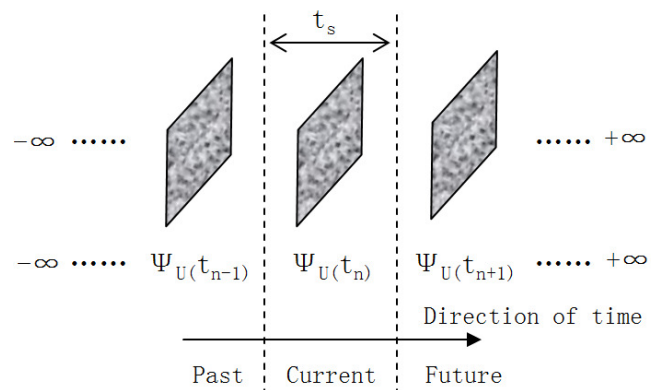

Figure 2. Universe state and time

Each universe state $\Psi_U(t)$ is the assembly of all the object states $\Psi(t)$ at moment t , i.e. :

$$\Psi_U(t) = \{\Psi_1(t), \Psi_2(t), \Psi_3(t), \dots\} \quad (4)$$

Substitute for $\Psi_U(t)$ from formula (4) into formula (3), then the following matrix expression on the universe U is acquired :

$$(5) \quad U = \begin{vmatrix} \Psi_1(t_{+\infty}) & \Psi_2(t_{+\infty}) & \Psi_3(t_{+\infty}) & \dots & \Psi_{\infty}(t_{+\infty}) \\ \vdots & \vdots & \vdots & \dots & \vdots \\ \Psi_1(t_{n-1}) & \Psi_2(t_{n-1}) & \Psi_3(t_{n-1}) & \dots & \Psi_{\infty}(t_{n-1}) \\ \Psi_1(t_n) & \Psi_2(t_n) & \Psi_3(t_n) & \dots & \Psi_{\infty}(t_n) \\ \Psi_1(t_{n+1}) & \Psi_2(t_{n+1}) & \Psi_3(t_{n+1}) & \dots & \Psi_{\infty}(t_{n+1}) \\ \vdots & \vdots & \vdots & \dots & \vdots \\ \Psi_1(t_{+\infty}) & \Psi_2(t_{+\infty}) & \Psi_3(t_{+\infty}) & \dots & \Psi_{\infty}(t_{+\infty}) \end{vmatrix}$$

We can acquire the definition on the universe from the above formula: **The universe is a general term meaning the past, present and future states of all the substances (objects).**

Actually, each object state $\Psi(t)$ is composed of its state of matter, state of motion, its relationship with the surrounding objects in terms of position, etc. Just like the ancient Greek philosopher Heraclitus said: "No one ever steps into the same river twice", it is more impossible for us to perceive the two universe states that are the same, this is determined by the movement character and infiniteness of objects. Therefore, although periodicity exists on partial object movement, any two universe states are different in the universe state sequence, i.e.:

$$\Psi_U(t_1) \neq \Psi_U(t_2) \quad (6)$$

This is the **non-repeatability** of universe state $\Psi_U(t)$. The non-repeatability of universe state results in the **irreversibility** of time. Obviously, the "time tunnel" leading to the past or future in Hawking's imagination does not exist.

2.3 Infiniteness of Time

The absoluteness of object movement and the infiniteness of substance indicate that universe state $\Psi_U(t)$ has the property of infiniteness, i.e., there is neither starting point nor finishing point in the universe, therefore **time has the property of infiniteness**, i.e., time has no beginning and end.

In accordance with Big Bang theory, the generation of our universe, accompanied by the simultaneous generation of time, originates from the big bang of a "singularity" with infinite great density and high temperature. Obviously, in accordance with Big

Bang theory, time has a starting point, which some scientists are suspicious of—what is outside the “singularity”? What had happened before the big bang of the “singularity”? And what mechanism had triggered off the big bang? In facing these queries, the theory supporters believe that all physical laws do not exist on the “singularity”. In the author’s opinion, requiring all the physical laws to exist at the designated time and place just for the purpose of catering for a theory seems to bring the God into the palace of science, which is unacceptable to the whole science community. Therefore the Big Bang Theory is questionable.

3 Time and Space

It can be known from system relativity that a fundamental particle cn has the constant vorticity Φ_c , please refer to figure 1. This means that the S number n_c passing through cn ring is constant. Therefore, the time t_s for each S to pass through cn ring can be expressed as:

$$t_s = 1/n_c = \text{constant} \quad (7)$$

t_s is a time portion owned by S , i.e., **space has time property**.

3.1 Non-uniformity of Time

In accordance with system relativity, space has density distribution ($\rho = \rho_0 r_0^3 / r^3$, in which ρ_0 stands for space density on the surface of a celestial body, r_0 stands for the radius of the celestial body, r stands for the distance to the celestial body, ρ stands for the space density at a place, the distance between the place and the celestial body is r), therefore time also has density distribution. Suppose space density is ρ , then **time density** ρ_t can be expressed as:

$$\rho_t = t_s \rho^{1/3} = t_s \rho_0^{1/3} r_0 / r \quad (8)$$

It can be perceived from the above formula that time density changes with the change of space density, and is inversely proportional to r — the distance to the celestial body. Therefore, **time is uneven**.

Suppose that a time scale is set up between the earth and the sun, then the mark gap at the earth side is about three times that of the sun side (deduced from gravity acceleration), and the maximum mark gap is located on the boundary of the earth field, as thrown in figure 3. That is the essence of “**time expansion**” effect.

Obviously, a length scale with even marks is

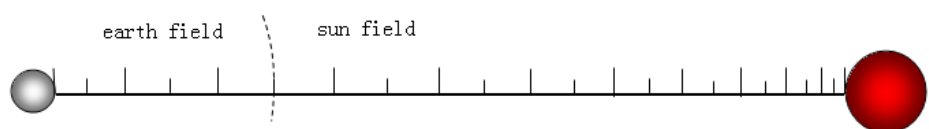

Figure 3. schematic diagram on the mark of the time scale between the earth and the sun

different from a time scale. If the marks on the length scale are determined on the basis of space density, its mark gaps will also be uneven, which is the essence of “**shortening of moving length scale**” effect.

Obviously, in earth surface environment, the space density is relatively constant, therefore, we feel that time passes by evenly.

3.2 Relativity of Time

As mentioned above, suppose an event A happens in the environment with space density ρ during the time span of t , then:

$$t = \rho_t \times A = t_s \rho^{1/3} A \quad (9)$$

The time span for event A is t_{\odot} during our general observation in the environment of earth surface (the space density is ρ_{\odot}), then such formula can be deduced: $t_{\odot} = \rho_t \times A = t_s \rho_{\odot}^{1/3} A$.

Get the formula divided by formula (9) and make arrangement, then :

$$t_{\odot} = (\rho_{\odot} / \rho)^{1/3} t \quad (10)$$

In the above formula, we refer to t as the **inherent time** of an event, and t_{\odot} as the event **observation time** on earth surface, and the above formula can be referred to as **time change equation**.

As to the events in micro environment, as the microenvironment space density $\rho \gg \rho_{\odot}$, the observation time in earth surface environment is extremely short; as to the events in space environment, as the space environment space density $\rho \ll \rho_{\odot}$, the observation time in earth surface environment is relatively pretty long, generating the illusion of space “time expansion”. Obviously, the so called Twin Paradox lodged by Einstein is impossible.

3.3 Inseparability between Time and Space

On the one hand, space has time property. On the other hand, the space made up of fluid-state substance is invisible. The movement we can see is that of objects. Furthermore, the movement of objects is the movement in space, and there is no movement and consequently no time without space. So **time and space are inseparable**.

According to special relativity, space and time are intertwined ^[5]. This view has greatly pushed forward Newton’s absolute time and space outlook. Einstein regarded time as an item independent of space, and called three-dimensional space and one-dimensional time jointly as four-dimensional space-time, i.e., Einstein did not acknowledge the inseparability between time and space. Therefore the author believes that the physical revolution launched by Einstein is not thoroughgoing, which is why he failed to establish the “unified field theory” regardless of his consumption of lifelong energy.

4 Time and Universe

A constant and stable universe model can derive from the infiniteness of time, and it can be deduced from the quantum property of substance that the so called universe “singularity” does not exist. Therefore the author believes that the Big Bang with the starting point of time has never occurred, however, there are continuous black hole big bangs in the galaxies or galaxy clusters spread over the universe. Therefore, the “standard universe model” accepted by most of the scientists is questionable.

4.1 Constant Cosmological Model in System Relativity

In the author’s view, the universe in which we live is a gigantic and extremely complicated system and can be regarded as a single body, i.e., a **universe body**. Just like an object having three-layer-field structure, a universe also has a three-layer-field structure, as shown in figure 4.

The core of the universe is a universe body made up of countless galaxies and galaxy clusters, it is a spherical, colorful visible world seen by us; The middle layer of the universe is an **atomic vacuum** filled with various kinds of photons and micro particles, it is the critical field of the universe body; The outer layer of the universe is the **photon vacuum** that cannot be reached even by fundamental particles, it is the external field of the universe body. It is in nihility state relative to objects but is filled with S.

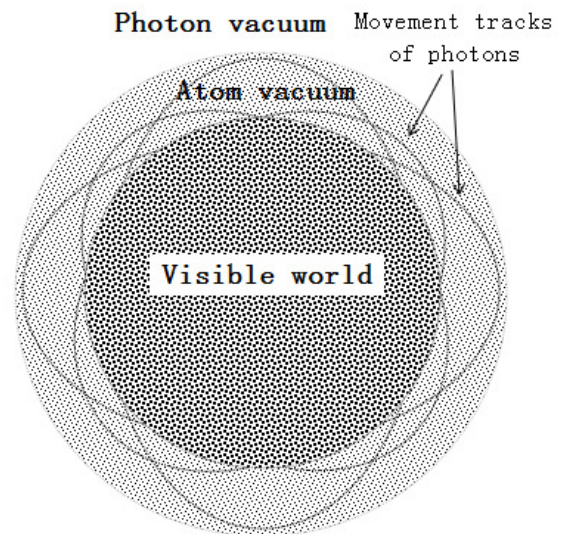

Figure 4. Schematic diagram of a steady and constant universe

In accordance with the principle of light’s convex lens effect (for detail, please refer to section 3 of *A Survey of Photons* by the author, published on natural science edition of Journal of Shandong Normal University, the 6th phase, 2012), at the critical field of an universe body, the photons sent out by the universe body turn back to the universe body due to total reflection. Therefore, the critical field of the universe body is also called light reflection layer. This is similar to the **visual field** of black holes. This is the reason for the isotropy of **cosmic background radiation**.

If a spaceship takes us to fly outward along the direction of the radial line of the universe body, we can observe the galaxies of our

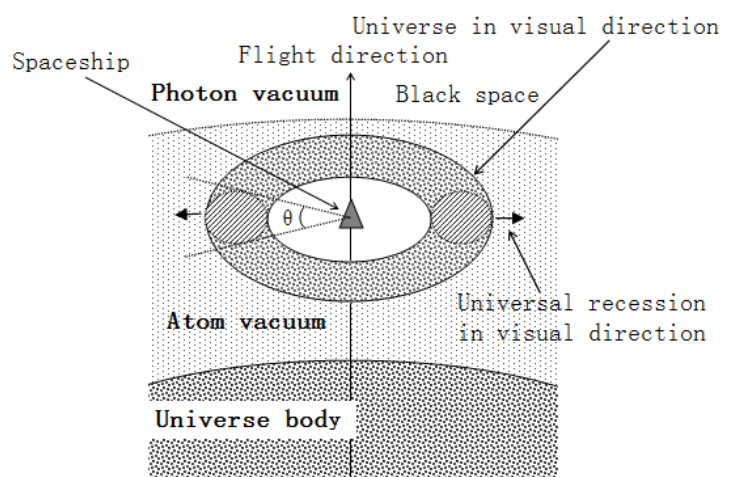

Figure 5. Schematic diagram of the ring like universe in visual direction

universe from any visual angle; after we have entered into the atomic vacuum, we can see that the visual angle θ of the universe begins to reduce from 180° if we observe along the direction perpendicular to the motion path, the ubiquitous universe is changing into a ring belt surrounding us, the further we fly outward, the smaller the visual angle θ . During the process, we feel the circular universe is retreating and we are in static state, as shown in figure 5; when we have reached the outer edge of the atomic vacuum, the ring-belt shaped universe changes into a remote loop line far from reaching. Once we have entered into the photon vacuum, that faintly visible universe loop line disappears, and we enter into the boundless and indistinct deep space, which is referred to as **black space** in system relativity.

In the black space, we are surrounded by darkness and can see nothing, we've lost all backgrounds. Although the roaring of spaceship motor still lingers around our ears, we are unable to tell whether the spaceship is moving. The disappearance of movement is accompanied by the disappearance of time, therefore it is not difficult to draw such a conclusion that **time does not exist without light**, which is the relationship between time and light and completely different from the light-time relationship described by Einstein.

Although inseparability exists between time and space, not all the spaces have time. Suppose the space density at the outer boundary of an atomic vacuum is ρ_γ , then the range of the density ρ of the time-existing space is:

$$\rho \geq \rho_\gamma \quad (11)$$

The space area with the space density $\rho < \rho_\gamma$ (i.e., black space) is the space where time does not exist and the pure space excluding objects that include various particles such as fundamental particle cn . From this it can be deduced that time does not exist without objects, **the existence of time depends on the existence of objects**. The space of the object-existing also called **time-dependent space**.

4.2 Multiple Universes and Time Islands

It can be known from section 1.1 that the vortex movement of space generates fundamental particles, which form photons, electrons, protons, atoms, common objects and celestial bodies, and then form a universe. However, it is impossible that the vast and boundless space happens to exist only in the sole **universe space vortex** we stay in, in other words, there should be many universe space vortex in space. Each universe space vortex is called a **subsidiary universe**, which is called **universe** for short; all the subsidiary universes jointly constitute an **ultimate universe**, also called **total universe**.

The total universe is the universal set of substances, it is the biggest and most complicated system and can be regarded as a single body, i.e., the **total universe body**. The total universe has no outer boundary, i.e., the outer field strength b of the total universe body equals 0, then in accordance with the formula on the field radius r_b , i.e., $r_b = (B_0/b)^{1/2} r_0$ (B_0 and

r_0 are the surface field strength and radius of the total universe body respectively), it can be known that the field radius of the total universe body is infinite, therefore **the volume of the total universe is infinite**. As the field strength b at the field boundary of a subsidiary universe is > 0 , **the values of the volume and energy of a subsidiary universe should be finite**.

As the photons (i.e., information) of a subsidiary universe is unable to run out, on the one hand, there is no information exchange between the subsidiary universes, i.e., each subsidiary universe is an information isolation island, which is referred to as **information island**; on the other hand, the dark space between the subsidiary universes is the world where time does not exist, and each subsidiary universe becomes a time isolation island referred to as **time island** floating in the black space, as shown in figure 6. While staying in the subsidiary universe where we live in, we are unable to observe the existence of other subsidiary universes, which is different from the content in M theory that a subsidiary universe cannot be observed just because it is located in different dimensionality.

It is worth mentioning that although invisibility exists among the subsidiary universes, interaction and relative motion exist among them. However, different from the syncretic property existing among the galaxies, the relationship among the subsidiary universes is more like the relationship among the particles in fluid, they are independent and keep a distance from each other and never keep in touch.

5 Dimensionality of Space and Time

In accordance with classical physics, space is three dimensional. Ever since the establishment of Einstein's special relativity, in view of the understanding that time and space are intertwined, time and space are jointly referred to as space-time, which has four dimensionalities, among which three dimensionalities correspond to empirical space, one dimensionality corresponds to time. In various editions of string theory in which various types of space dimensions, including 7 dimension theory, 10 dimension theory, 11 dimension theory, apart from the dimensionality of three-dimensional empirical space and the dimensionality of one-dimensional time, the remaining dimensionalities all curl up in inner space^[6].

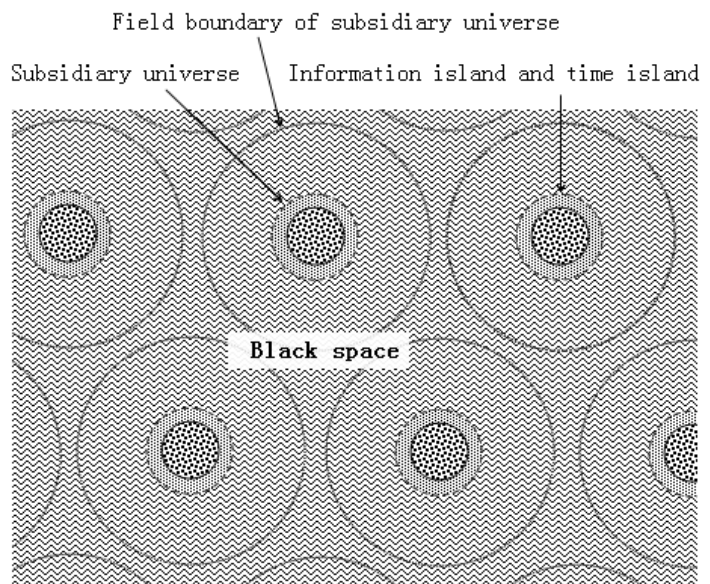

Figure 6. Schematic diagram of total universe and subsidiary universe

We all know that substance has the property of volume, a substance without volume does not exist, the volume property, if expressed in the form of space, means that space is three dimensional. In the frame of three-dimension space, we can see that a subsidiary universe is dynamic, there are movements and evolutionary processes of various objects and celestial bodies. Surely, the whole subsidiary universe serves as the observation background for the observation on any celestial body in it. If we try to make the whole subsidiary universe as the object for observation, we can only observe by standing in the dark space. As described in 4.1, the subsidiary universe at this time has disappeared.

In the early 17th century, both Descartes and Galileo made the most fantastic discovery: In a coordinate diagram in which horizontal axis represents space and vertical axis represents time, the movement passing through space becomes a curve on the diagram (as shown in figure 7). In this mode, time seems to have become the space of another dimension. Movement is frozen, the seemingly static course of movement and change is presented before us ^[7]. In terms of this discovery, L. Smolin thinks that it is wrong to express time in the form of space acquired through conversion.

The author thinks that two prerequisites, i.e., reference object and time scale, must be possessed in the observation of an object. A reference object is the specific object in observation background, on the basis of this specific object we can establish a three-dimensional location reference frame, also called **three-dimensional space frame**; a time scale derives from

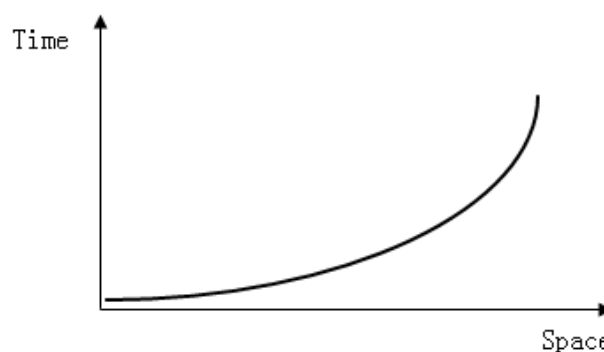

Figure 7. Schematic diagram of Space-time

the whole background, on the basis of which we can establish a one-dimensional **time reference frame**, also called **one-dimensional time frame**. We refer to the combination of the two reference frame as background reference frame, also called **time-dependent reference frame**, this is the so called four-dimensional space-time frame.

Obviously, time dimensionality is not another dimensionality of space. Relative to the observed object, the observer and observation instrument are also part of the background. As the observer isolates them from the background, he is unable to observe the movement of an object in a four-dimensional space-time frame, but can only make observation in three-dimensional space frame. In other words, observer and time exist in three-dimensional space frame, and there are no observer and time in four-dimensional space-time frame. Therefore, for an observer, four-dimensional space-time frame does not exist.

In four-dimensional space-time frame, time does not exist, and consequently movement is frozen, therefore movement and evolution process does not exist in the whole universe in four-dimensional space-time frame, this is the **static universe**---an eternal **existence** mentioned by Einstein. In accordance with the illustration in section 4, the absence of time means that the observer is in black space. This eternal existence becomes nonexistence due to invisibility.

In the various editions of M theory inclusive string theory, inner space is set up specifically for the purpose of resolving the problems we are confronted with. The number of space dimensions lies in our choice. If four-dimensional space-time does not exist, the existence of higher dimensional space will be more unlikely. Therefore, the author thinks that **space has and has only three dimensions**.

6 Ending Remarks

In conclusion, the author thinks that time is a kind of background, a kind of space. Time derives from movement, light and its existence relies on objects and observers. Time is the high degree of abstraction on nature, time is our universe. This is the outlook on time in system relativity.

References

- [1] L. Smolin, *The Trouble with Physics*, translated by Li Yong, Hunan Science and Technology Press, Changsha, 2008, PP. 252-253.
- [2] Liu Taixiang, *The System Relativity*, Beijing, Scientific and Technical Documentation Press, 2012.
- [3] Tong Binggang, Yin Xieyuan, Zhu Keqin, *Theory on Vortex Movement*, the second edition, Press of University of Science and Technology of China, Hefei, 2009, PP. 149-160.
- [4] Fang Lizhi, *Wheeler's Speeches Physics and Austerity*, Anhui Science and Technology Press, Hefei, 1982.
- [5] Einstein, *The Meaning of Relativity*, translated by Li Hao, Science Press, Beijing, 1979.
- [6] Stephen Hawking, Leonard Mlodinow, *The Grand Design*, translated by Wu Zhongchao, Hunan Science and Technology Press, Changsha, 2011, PP. 121-123.
- [7] L. Smolin, *The Trouble with Physics*, translated by Li Yong, Hunan Science and Technology Press, Changsha, 2008, PP. 252.

About the author: Liu Taixiang(1969~), male; hometown: Laiwu, Shandong province;
Senior engineer; Research area: Theoretical physics.

Address: Room 702, No. 13 building, Zhongrun Century Square, No. 13777, Jingshi Road,
Jinan City, Shandong Province.

E-mail: taixiang.l@126.com

Theory of Relativity does not solve the problem of experimental verification

Tu Runsheng

(Agency of Quality Products Supervision and Inspection of Huangshi City,
Huanshi435000, Hubei Province, P. R. China. E-mail: 2run3@sina.com)

Abstract: In a limited number of experiments that support Theory of Relativity, there also exist some points that are not supportive of the theory. Therefore, Theory of relativity does not solve the problem of experimental verification. Although the results of many experiments quantitatively conform to the predictions of Theory of Relativity, many of them are not supportive of the theory in one place or another. For example, *Jones experiment* confirms that: Observing in the system of the movement glass, the law of refraction is not established; from the observation with a moving frame of reference, the moving direction of a photon is actually related to the state of motion of the light source. According to this, the observer in the frame of reference can determine the speed of motion of himself. The principles of relativity are identical with Doppler shift, both requiring an identical emission frequency of the same type of light source in different state of motion. The atomic clock's bi-directional circumnavigation experiment proves that the same light source in different state of motion has different emission frequencies; the velocity sequence of atomic clocks in different systems is unique, and is independent of the state of motion of the observer. This proves the inequivalence of different inertial systems. The asymmetry in time for microwave transmitted back and forth to geostationary satellite and the results of Michelson's experiments conducted at different altitudes and Sagnac experiments proved that the resultant velocity of light velocity and velocity of earth's surface is not light velocity. This indicates that as for Theory of Relativity, we should be neither supportive nor non-supportive unconditionally. Instead, we should go back to its true features.

Keywords: *Jones* experiment, Sagnac experiment, the atomic clock's bi-directional circumnavigation experiment, Law of refraction, Relativity principle.

The experiments that are believed to be supportive of Theory of Relativity contain some parts that conform to Theory of Relativity. If the focus of attention is changed, one can find many places that are not in accordance with Theory of Relativity. In other words, except for one local experiment, almost all the experiments can be found consistent with Theory of Relativity in some places; however, if we change to another focus of attention, some parts of these experiments can be found inconsistent with Theory of Relativity. If an experiment is believed to have proven the Theory of Relativity, it is because the experiment is simply explained in a way that supports Theory of Relativity. For example, the results of *Jones*

experiment ^[1-3] conform quantitatively with the predictions of Theory of Relativity only in some parts, while qualitatively the results are not in accordance with the theory; the atomic clock's bi-directional circumnavigation experiment is consistent with the predictions of Theory of Relativity only quantitatively, while qualitatively it is not in accordance with Theory of Relativity. The results of Sagnac experiment are contrary to those of Michelson's experiment, and do not support Theory of Relativity. There are even more examples that support this point.

The fact that the experiment conducted by Miller et al. is not supportive of Theory of Relativity has long been reported. People tolerate these experiments because such experiments are few. That is to say, people do not feel pressured when “the blue sky is scattered with few clouds”. Only when the sky is full of rainy clouds can people feel the pressure. Now it has been found that a large quantity of experiments are a “double-edged sword” to Theory of Relativity, showing that the theory is reasonable in some places and have serious faults in other places. But the physicists can no longer stay indifferent.

1 With changed focus of attention, it is not hard to find that “the Jones experiment believed to support Theory of Relativity” actually goes contrary to it

To illustrate this point, let's take a look at two theoretical experiments in imagination. Then the situation proved by Jones experiment and the requirements of Theory of Relativity are demonstrated. The results of these two experiments can be used as the guidance, premise or basis for later discussion.

1.1 Photon shooting experiment and high-speed train searchlight experiment

Imaging that system *B* has a moving light source *S* which is connected to system *A*. An arch-shaped steel rod connects *S* and a target marked with point *C* and *D* (See Figure 1). The observer in system *A* emits a photon targeting at point *D* using line-of-sight geometry. If the absolutely stationary reference system does not exist and all inertial systems are equivalent, *S* will be a stationary light source if observed from system *A*. The emission direction of the photon defined by a paraboloid is the real emission direction

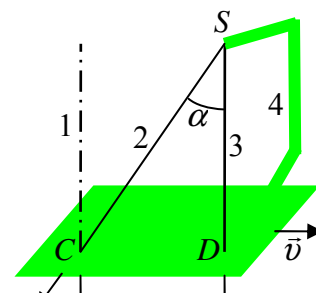

Figure 1. Schematic diagram of photon shooting experiment. If all systems are equivalent, the same photon will hit both point *C* and *D*.

(*i.e.* the point *D* that the photon should hit). Since the moving light source *S* cannot give a transverse initial velocity in a lateral direction, and a vacuum separates the light source and the target, the photon cannot be pulled transversely. If observed in system *B*, during the time that the photon moves from *S* to the target, the target has already moved vertically for a distance of \overline{DC} relative to the photon path. Therefore, the observer in system *B* will see the photon hitting point *C*. Since a photon cannot hit both point *C* and point *D* at the same time, this theoretical experiment in imagination reveals a paradox. In Figure 1, Line 1 is the real

transmission path of the photon observed by the observer in system B ; Line 2 is the apparent path of the photon observed by B ; Line 3 is the transmission path determined (predicted) by A geometrically; Line 4 is the steel rod connecting light source and the target. α is the angle of aberration.

The paradox above is caused by not distinguishing the space in different reference system. The principles of relativity require that when changing the observer, the vacuum space outside the objects should be changed correspondingly; as the reference system changes, the vacuum space should change with it. If there is a superior system, the space cannot be changed with the change of observer. Thus, the conclusion inferred according to space division in Theory of Relativity is paradoxical. *R. V. Jones* conducted the lateral pulling experiment in 1971 (hereafter referred to as *Jones experiment*). When the photon reaches the photon receiver after it passes through the glass, the photon shooting experiment is realized. In other words, the photon shooting experiment is realized in one part of *Jones experiment*. And *Jones experiment* proved that the photon hits point C instead of point D , and the system B is superior to system A .

Now we will analyze an example closely related to our daily life (high-speed train searchlight experiment). Imagine a high-speed train is travelling in a dark tunnel. A torch is mounted laterally to the train (considered as a searchlight). The extension direction of the torch (representing the emission direction of the photon) is vertical to the train and the internal wall of the tunnel. Quickly press the switch to emit a beam of light and then raise your hand. When observed in the reference system of the roadbed, the beam can only be vertical to the train

and the internal wall of the tunnel. This is because the space between the light source and the internal wall belongs to the roadbed reference system, and the train body is parallel with the internal wall of the tunnel. It would be contradictory to the mathematical principles if a beam of light is vertical to the train body but not vertical to the internal wall. In a general sense, when the space between the light source and the moving planar object is changed to vacuum, the conclusion still holds within the framework of Theory of Relativity. It has to be admitted according to the principles of relativity that the vacuum outside the objects belongs to the system where the observation is conducted (when observed in the moving planar object, the space between light source and the moving planar object belongs to the system in which the moving planar object is in, This is similar to the situation where “the space above the roadbed belongs to the roadbed reference system if observed in the roadbed reference system”). The high-speed train searchlight experiment shows that for the principles of relativity to hold, when the photon is emitted vertically to a moving planar object in a stationary reference system (the space between the light source and the moving planar object is vacuum) and is

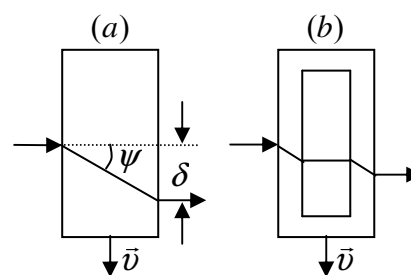

Figure 2. The pulling effect on the photon of hollow rotating disk and solid rotating disk in the experiment. (a) is a solid disk and (b) is a hollow disk. If observed inside the disk, a part of Figure 1(a) can be demonstrated in Figure 3.

observed in a system connected to the moving planar object, then the photon path is still vertical to this plane. If observed from the moving planar object, the photon emitted by the moving source travels in an oblique path towards the planar object, then the velocity of the photon is $\sqrt{c^2 + v^2}$, which is higher than the light velocity and the light velocity is relevant to the state of motion of the observer. Then the principle of constancy of light velocity cannot hold.

1.2 The transmission path of the photon proved by Jones experiment

Jones experiment proves the Theory of Relativity in quantitatively. However, a careful analysis shows that the experiment seems to prove that “ground laboratory reference system is superior to the moving glass reference system”.

The principle of *Jones* experiment is shown in Figure 2(a). According to the electrodynamics dominated by Maxwell's theory of electromagnetism and Lorentz transformation, the direction of the light passing through the medium is given by:

$$\tan\psi = nf_i\gamma, \quad (1)$$

Where Lorentz coefficient is γ : Lateral movement δ is given by:

$$\delta = nlf_i\gamma. \quad (2)$$

Where n is refractive index, $f_i = 1 - \frac{1}{n^2} + \frac{v_0}{n} \frac{dn}{dv_0}$ and l is the thickness of the

disk, $\gamma = \sqrt{1 - v^2/c^2}$. The experimental value was $\delta = 6.175nm$ (standard deviation was $\pm 0.016nm$). According to the theoretical prediction by equation (2), the value was 6.174nm.

From the equation (2) proven by *Jones* experiment it can be noted that the experiment demonstrated the “association between lateral movement and thickness of disk”. What does this represent? First of all, it shows that the pulling ends when the photon has passed through the glass and the light basically resumes the emission direction before entering the glass disk. Secondly, it shows that the pulling exerted by the glass medium cannot give a permanent lateral velocity component to the photon (apart from the refraction, when the photon passes through the interface, its lateral motion is inconsistent with inertial motion principle).

If observed in the glass reference system, the transmission path of the photon determined by *Jones* experiment is shown in Figure 3(a) (it can

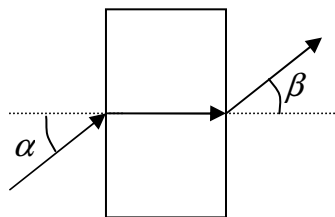

Figure 3(a). Jones experiment proves that when observed in a moving reference system, the law of refraction is not necessarily true. β is a deflection angle free from the restriction of the law of refraction, which is called aberration angle.

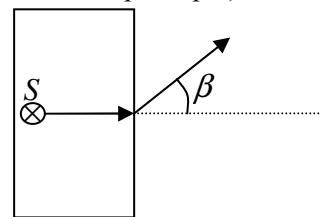

Figure 3(b). The light source buried in the moving glass emits photons at an incident angle of zero, while the deflection angle is not zero. β can only be the inner angle of aberration.

be obtained from Figure 2 by changing of the reference system of the observer; for detailed demonstration, see section 1.4). The lateral pulling efficiency of the glass on the photon is not 100%, which causes a very small angle of deflection upwards for the light inside the glass.

As long as observed in the laboratory system, the situation is shown in Figure 10.6, As long as observed in the system of moving glass, the situation certainly is shown in Figure 10.7. It can be seen clearly from Fig. 10.7 (b), the law of refraction is not established in the system of the moving glass - The incident angle α is not equal to the exit angle β , the refraction of $n=(\sin\alpha)/(\sin\beta)$ does not established.

1.3 Quantitative analysis on the law of refraction in Jones experiment

In Jones experiment, the thickness of the disk $l=0.02465m$, refractive index $n=1.524$, the distance between light spot to the rotating shaft is $0.1375m$, the perimeter of the disk at the light spot is $0.8635m$, and the number of rotation is $25.03sec^{-1}$. Thus, the linear velocity of the disk at the light spot is $v= 21.61 m/sec$. In Jones experiment, when observed in the glass reference system, the measured possible transmission path of the photon is shown in Figure 4.

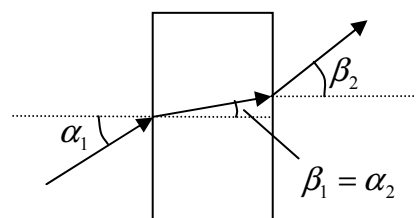

Figure 4. Schematic diagram for Section 1.3. If the pulling efficiency of the glass on the photon is not 100%, then when observed in the rotating disk system, the results of Jones experiment can be shown in the figure below.

α_1 represents the incident angle of light in the disk reference system; β_1 represents the angle of refraction. According to the Special Relativity, $\sin\alpha_1 = v/c = 7.203 \times 10^{-8}$. If the law of refraction holds, then $n = \sin\alpha_1 / \sin\beta_1$, $\sin\beta_1 = \sin\alpha_1 / n = 4.727 \times 10^{-8}$. Since β_1 is very small, we can obtain the relationship as below: $\sin\beta_1 \approx \tan\beta_1 \approx \beta_1 = 4.727 \times 10^{-8}$. This is the theoretical value of the angle of refraction β_1 corresponding to the incident angle α_1 when observed in the glass reference system. As for the measured value of β_1 in Jones experiment, there are two different ways of understanding. (1) Some believe that $\beta_1 \approx \tan\beta_1 = \delta/2l = (6.175\gamma/l)/2 = 1.252 \times 10^{-7}$. (2) In the laboratory reference system, since the angle ψ in Figure 2 is caused entirely by the lateral pulling exerted by the glass, the photon is moving in a stationary medium and the lateral pulling does not exist. β_1 should equal 0 (the experiment proves equation (2), and thus proves understanding (2)). The theoretical value that is in line with the law of refraction is not identical to the measured values by the two ways of understanding.

Conclusion: In the rotating disk reference system, the measured angle of refraction was not consistent with the theoretical value. The law of refraction is not true in the rotating disk reference system.

Inference: The laboratory reference system is the superior reference system.

From Figure 3 it can be observed directly that in Jones experiment, if observed in the glass reference system, the photon passing through the two interfaces does not conform to the law of refraction (because the light inside of the glass is travelling horizontally while the light

outside is travelling in an oblique line).

Some people may be doubtful of the quantitative analysis above, for the light source is moving when observed in the glass reference system. If the light transmits as shown in Figure 4, then the velocity and direction of the moving photon is relevant to the state of motion of the observer. Thus, the principle of the consistency of light velocity is violated. If we admit that the light velocity and its direction are relevant to the state of motion of the observer, then the transmission path of the photon can be shown by Line 3 in Figure 5. The law of refraction still applies in the glass reference system. However, to believe that “the transmission path of the photon can be exactly shown by Line 3 in Figure 5” is to admit that in Figure 2 the relationship between angle ψ and light velocity is $\tan\psi=nv/c$, and equals to $nf;\gamma$ on the right side of Equation (1). $nv/c \neq nf;\gamma$ indicates that the lateral pulling efficiency of the glass on the photon is not 100%. So long as the lateral pulling efficiency of the glass on the photon is not 100%, the transmission path of the photon in the glass is not horizontal if observed in the glass reference system (the target photon has a retrograde motion in the longitudinal direction); instead, the light is deflected upward (the lower the efficiency of the pulling, the larger the angle of deflection is). The law of refraction still does not hold in the glass reference system.

1.4 Comparison between the results of Jones experiment and the requirement of Theory of Relativity

If the pulling effects of a solid disk and a hollow disk are not the same, then the pulling is relevant only to the total thickness of the glass disk. Then, the transmission path of the photon in Jones experiment can be shown by Line 2 in Figure 5.

According to electromagnetic theory, for the transmission path of an electromagnetic wave, any point is always the source of electromagnetic wave of the preceding point. Thus, if a light source S is buried in the disk at the distance equaling to the disk radius and the incident angle is also 0, then the deflection angle will certainly be β (See Figure 3(b)). If the light source buried in the glass emits a photon towards the right and parallel with the normal, then the deflection angle of the emerging light does not necessarily contain the contribution of refraction but completely the angle of aberration β (See Figure 3(b)).

The equivalence of different inertial systems (the space belongs to the inertial system where the observer is) and the principle that “light velocity and its direction are irrelevant to the state of motion of the light source” require that “the transmission path of a horizontal incident and vertically emerging light is still horizontal in a stationary space and a stationary object” (for more details, see “high-speed train searchlight” experiment), When observed in the laboratory reference system, the normally incident light falls on a glass disk. This avoids the non-zero refraction of the light. The deflection of the light in the glass is caused entirely by the pulling of the medium. When observed in the glass reference system, the non-zero refraction does not happen. The light is still vertical to the glass disk (See “high-speed train

searchlight” experiment).

Within the framework of Theory of Relativity, when observed in the moving glass disk, the vacuum at both sides of the interface is stationary to the observer (if the vacuum outside the glass is believed to be moving and belongs to the laboratory reference system, the laboratory reference system is superior to the glass reference system. If the glass and the observer himself are believed to be moving, then the principles of relativity are violated). Only when the observation is made in the laboratory reference system, the medium on both sides of the glass-vacuum interface is “moving at one side and stationary at the other side”. The law of refraction does not apply

“Observe the light emitted by the torch on the high-speed train in the roadbed reference system” is entirely identical to “observe the light emitted by the light source in the glass reference system in *Jones* experiment”. Therefore, Theory of Relativity requires that the transmission path of the photon emitted from the light source in the laboratory reference system must be vertical to the glass disk before entering the glass when observed in the glass reference system (transmission path 3 of photon in Figure 5 is required by Theory of Relativity). That is to say, when observed in the glass reference system, the vacuum outside the glass in *Jones* experiment belongs to the glass reference system, not the laboratory reference system. A photon that enters horizontally but vertically passes through the interface should have the same transmission direction in the stationary space out of the glass and inside the stationary glass (taking into account that the results of the high-speed train searchlight experiment and the fact that the error caused by 100% pulling efficiency is very small and can be neglected).)

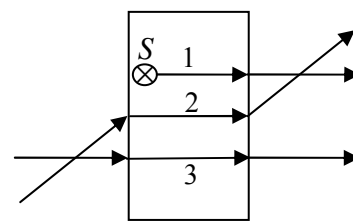

Figure5. When observed in the glass system, path 1 and path 3 are required by principles of relativity and the principle of consistency of light velocity. Path 2 is observed in *Jones* experiment. Therefore, the results of *Jones* experiment deny Theory of Relativity (the results show the superiority of the laboratory system over moving glass system).

As shown above, when observed in the glass reference system, path 1 and path 3 in Figure 5 are required by the Theory of Relativity (for specific reasons, see the results of “high-speed train searchlight” experiment and take into consideration of the requirement of “space division” in Theory of Relativity). Path 2 is the measured path in *Jones* experiment. Admitting the legitimacy of path 2 and path 3 at the same time is to admit that a photon can hit both point B and point C in the “photon shooting” experiment. This is a very serious mistake, but people refuse to correct this mistake.

1.5 *Jones* experiment proves that the observer in the glass reference system can feel his own motion, based on which optical speedometer can be developed

The angle β in Figure 3(b) is entirely an angle of aberration, rather than an angle of refraction. The so-called aberration is a visual effect caused by the relative movement of the source and the observer. Which movement actually results in the angle of aberration β in Figure 3(b)? It can only be the the motion of the observer relative to the laboratory reference system (because only one system exists in the scope of discussion of Figure 3(b) and the light source is stationary to the observer). In other words, angle β in Figure 3(b) is caused by the fact that the vacuum outside the glass still belongs to the laboratory reference system (i.e. the laboratory reference system is superior to the glass reference system). The transmission path of the photon in Figure 3(a) is proven by *Jones* experiment. Figure 6 is the schematic illustration of a geometricopticalspeedometer.

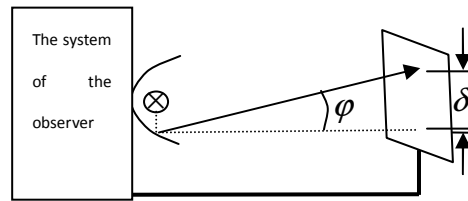

Figure 6. Principle of optical speedometer. From the comparison of the actual path and the path determined with geometrical methods of a photon, the inner aberration can be obtained. With the inner aberration angle ϕ , the velocity of the system itself can be calculated.

The analysis above indicates that to prove the that lateral movement is relevant to the thickness l is to prove that when observed in the glass reference system, the angle of incidence is 0, but the angle of refraction is not (considering only that the photon passes through the second interface). This denies that the law of refraction is covariant. Even though some readers believe that the law of refraction does not hold in a moving reference system, the angle β in Figure 5 is only relevant to the moving velocity of the observer, *Jones* experiment reveals another question-- the absolute moving velocity can be measured by the observer. The latter is also the question that “in an inertial system, one's movement can be perceived with optical experiment” (the admission of a superior reference system). Now the remaining question is how the observer measures the angle of aberration angle of the emerging light.

The light source in Figure 3(b) is moved to the surface of the disk and the target and the light source are connected by a steel rod (Figure 6). The point that the light hit is determined geometrically based on a paraboloid. *Jones* experiment shows that “lateral movement is relevant to the thickness l of the disk and the pulling ends when the photon emerges out of the glass”, resulting in the upward deflection of the light passing through the glass (a photon receiver and a counter are connected to the target). In this way, the target point determined by the geometrical method differs from the actual target point.

Theory of Relativity requires the equivalence of different inertial systems. The light emitted by the light source shown in Figure 3(b) is parallel with the normal to the interface after it passes through the glass; while the finding of *Jones* experiment that “the lateral movement is relevant to the thickness of the disk and the pulling ends when the light emerges out of the glass” seems to admit that the light passing through has a non-zero deflection (see Fig.6). The principle shown in Figure 6 is identical with “photon shooting experiment” of

Figure 1 (in Figure 6 it is not a box system without cover; at the bottom there is an extremely thin steel rod).

In the course of the transmission of electromagnetic wave, any point is the electromagnetic wave source of the preceding point. Therefore, when observed in the laboratory reference system, the situation (the transmission path of the photon) can be illustrated by Figure 2. When observed in the glass reference system, the situation will be exactly what is shown in Figure 3, which in turn, leads to the situation shown in Figure 6. Figure 3 and Figure 6 indicate: In a reference system moving at the velocity of v , the actual transmission path of the photon will deviate from the emission path of the photon determined by geometrical method (*i.e.* deviation from the geometrical direction). The angle of deviation can be called “inner angle of aberration”, an angle of aberration that can be observed inside the system without any exterior reference system. An electron gun and a photon gun simultaneously emit an electron and a photon in the same geometrical direction so as to find the “inner angle of aberration” more easily. The relationship between the “inner angle of aberration” and the velocity of the system is $\delta/l = \tan\varphi' = v/c$. If only the “inner angle of aberration” φ in one direction can be observed, the inner angles of aberration α , β and φ in the other three directions can also be observed. In this situation, the relationship of the velocity V of the system and the inner angle of aberration is:

$$V = c\sqrt{\tan^2 \alpha + \tan^2 \beta + \tan^2 \varphi}, \quad (3)$$

Where V is the absolute velocity of the system. Three pairs of mutually vertical electron gun and photon gun form a speedometer of inner aberration. The velocity calculated based on inner angle of aberration is not a velocity relative to any laboratory reference system, but the absolute velocity of the moving system. This is because the inner angle of aberration is measured by the observer inside the moving system, which requires no exterior reference system. In fact, the inner aberration has nothing to do with the state of motion of the observer outside the system; it is related only to the absolute state of motion of the investigated system.

1.6 The part that does not support the principle of consistency of light velocity in Jones experiment.

By assuming that the Theory of Relativity is true, the incident angle α on the left side of Figure 3(a) cannot be larger than 0. When observed in the laboratory reference system, the light at both sides of the glass disk is horizontal; when observed inside the glass reference system, the deflection angles of the light at both sides of the glass disk are symmetrical. When observed in the laboratory reference system, the incident light is vertical to the glass disk (the transmission path of the photon before it enters the glass is vertical to the glass disk). If we admit that different inertial systems are equivalent, when observed in the glass reference system, the space belongs to the glass reference system instead of the laboratory reference system. “The transmission path of the photon before it enters the glass” is stationary and

maintains its posture of being vertical to the glass disk (for specific reasons, see “high-speed train searchlight” experiment). In other words, the photon emitted from the moving light source has a stationary transmission path, and the space that contains the transmission path is also stationary. The direction is the original emission direction of the photon (vertical to the glass disk). It is simply that the light source is moving away from the photon's transmission path. We cannot assume that the stationary medium has a non-zero pulling effect on the photon passing through.

From the perspective of the principle of consistency of light velocity, when observed in the glass reference system, the idea that “the incident angle α at the left side of Figure 3(a) is larger than 0” is questionable: The design of *Jones* experiment is that the light enters vertically the first interface (observed in the laboratory reference system) and the incident angle is 0. If it is believed that “when observed in the laboratory reference system, the incidence is horizontal; when observed in the glass reference system, the incidence is oblique”, then in the glass reference system, the principle of consistency of light velocity implies that the velocity of the photon in the horizontal direction is c , and the velocity of obliquely incident light $\sqrt{1 - v^2/c^2}$ is $>c$. The direction of light velocity is no longer irrelevant to the state of motion of the light source (or it has to be admitted that even when observed inside the glass reference system, the vacuum outside the glass still belongs to the laboratory system). Therefore, within the framework of Theory of Relativity, the transmission path of the horizontal incident photon in a stationary medium has to be horizontal. *Jones* experiment proves that (observed in the glass reference system) the transmission path of the photon is not always horizontal (see Line 2 in Figure 5). This is to prove that the principle of consistency of light velocity does not hold if the photon travels in an oblique path (especially at the beginning of Line 2 in Figure 5).

Like *Jones* experiment, many other experiments also have some places which are not supportive of Theory of Relativity, but these places are quite hard to identify. The most important obstacle is the disbelief that “Theory of Relativity may have a problem”. Many people, not believing that Theory of Relativity is questionable, replace the concepts, to make the studied object conform to Theory of Relativity (especially the space division: They do not change the space when it is necessary; while they change the space when it is not supposed to do so). This phenomenon needs to be noted.

2 Atomic clock circumnavigation experiment which is believed to support the Theory of Relativity is qualitatively not supportive

Different inertial systems to be equivalent require that the emission frequencies of the same light-source in different inertial systems are the same (If the emission frequencies of the same light-source at different movement state do not the same, different inertial system are not equivalent), the effect of the slowdown of the movement atomic clock cannot be accumulated.

If we admit that the transmitting frequency of the movement light-source is also changeable, the observed spectroscopic redshift of galaxies is jointly contributed by the variation of the emission frequency of the light-source and the Doppler Effect. The calculated velocities by submitting the all redshift into Doppler formula don't always the velocity of galaxies away from the observer.

The requirement of the principles of relativity on the emission frequency of the same light source in different states of motion is view *A*. The emission frequencies of the same light source in different states of motion are completely the same. Theory of Relativity admits that Doppler shift is derived from Lorentz transformations, while the latter is the mathematical foundation of the special theory of relativity. Doppler shift refers to that the emission frequency of the light source does not change with the motion and only the receiving frequency changes. Therefore, the requirement of the principles of relativity on the inequivalence of different inertial systems is the same with that of Doppler shift: The emission frequency of the light source does not change with its motion; only the receiving frequency changes as the relative state of motion changes. The observation of the frequency shift of galaxies in astronomy and cosmology adopts view *A*. However, people sometimes also adopt view *B*: The emission frequencies of the same light source in different states of motion are different. The reason is that the principles of relativity allow of different opinions concerning time and emission frequency for observers in different states of motion. There are two situations relevant to view *B*. *B*₁: When observed in different reference systems, the clocks in different systems have the same velocity sequence and are slower than the clock in the system where the observer is; *B*₂: When observed in different systems, the clocks in different reference systems (including the clocks in the observer's system) have the same velocity sequence (in other words, the velocity sequence of clocks in all reference systems is irrelevant to the state of motion of the observer).

The speed of an atomic clock reflects the emission frequency of the light source in the clock. The velocity sequence of the clocks directly corresponds to the emission frequency sequence of the light source of the same type (because the inherent time of an inertial system corresponds to the inherent frequency of the stationary light source in the system; a standard clock records its inherent time, which reflects the inherent frequency of the light source). View *B*₁ is paradoxical: If the velocity sequence of the clocks in all the systems is irrelevant to the state of motion of the observer, then it cannot be guaranteed that the clock in the system where an observer is located is always faster than the clocks in other systems; if the clock in the observer's system must be excluded, then the "subject structure" is also changed for the observer. So we cannot say that "the velocity sequence of the clocks in all the systems is irrelevant to the state of motion of the observer". Therefore, view *B*₁ can only admit that the speed of clocks is only a visual effect instead of an accumulative effect that is real. It corresponds always to the change of the receiving frequency. For example, there are six systems in different states of motion, *a, b, c, d, e, f*. When observed in system *a*, the velocity

of f relative to a is the largest; according to view B_1 , the speed sequence of these clocks is $a > b > c > d > e > f$. Now, when observed in system f , according to view B_1 , the speed sequence of these clocks is only $f > b > c > d > e > a$. Logically, for the clock in the observer's system to be the fastest, the change of system will definitely result in a new velocity sequence of the clocks. Therefore, view B_1 is paradoxical. If view B_2 is adopted, it will be easy to find the system with the fastest clock, which is the superior system. View B_1 is usually adopted by the supporters of Theory of Relativity. View A and B are contradictory. For someone who adheres to rigorous scientific spirit, either A or B is right. One cannot consider view A correct at one time and consider that view B is also correct at another time. It is impossible that both view A and B conform to the Theory of Relativity.

Many people are familiar with the structure and working principle of Cesium clock—the emission frequency of the cesium atom determines the speed of the clock and there is no relative motion between the cesium light source and the frequency receiver. If the clock becomes slower, it means the emission frequency of the cesium light source has become lower. The reading on a moving atomic clock represents the inherent emission frequency of the light source in the clock (and not the received frequency in a stationary reference system). In the atomic clock's bi-directional circumnavigation experiment, the moving clock is compared with a stationary clock on the ground and the change of the emission frequency of the light source in the clocks is measured. It should be noted that it is not the change of frequency of light emitted by the moving light source and received by a stationary observer. Two pilots that fly the plane eastwards and westwards and the observer on the ground reach a consensus on the speed of the three clocks (i.e. the velocity sequence of the three clocks is irrelevant to the state of motion of the observer. Whatever the reference system, the clock flying westwards is the fastest while the clock flying eastwards is the slowest). Only by direct observation on the ground of the frequency of the photon in the clocks carried by the plane can we measure the received frequency. Therefore, the bi-directional circumnavigation experiment proves that the emission frequency of the light source in a moving system becomes lower (*i.e.* view B_2 is not right while view A is right). It is not the received frequency that becomes lower (if it is the received frequency that becomes lower and the same light source has the same emission frequency in different systems, then the moving atomic clock will not be substantially slower).

To put it simply, in the atomic clock's bi-directional circumnavigation experiment, the three clocks are calibrated at the same place and then placed in different moving systems. After a certain period, the three clocks are again compared at the same place (after the deduction of the acceleration effect). This method of clock calibration implies that the result is absolute (that can be admitted by the observers in all states of motion). For relative uniform motion, the result of the experiment is: The clock in the plane that flies westwards is faster

than the stationary clock on the ground, which is faster than the clock in the plane that flies eastwards. The result is absolute (i.e. the two pilots in the planes, the observer in the ground laboratory and the observers in other states of motion have to admit the velocity sequence of the three clocks measured this time. The velocity sequence of the clocks in different systems does not change with the state of motion of the observer). Thus, this measurement method can be extended to many other clocks, until the fastest clock is found and everybody can reach a consensus on this. The reference system of this clock is the superior reference system. Now we are certain that the result of the atomic clock's bi-directional circumnavigation experiment denies the Theory of Relativity. For a more intuitive expression, see Table 1.

Table 1. Analysis on whether the emission frequency of the light source reduces with the decrease in movement speed

View A	View B	The branches of View B	Current knowledge, application status and status proven by experiments
The same light source in different state of motion has exactly the same emission frequencies.	The same light source in different state of motion has different emission frequencies.	B1: When observed in different reference systems, the clocks in different systems have the same velocity sequence and are slower than the clock in the system where the observer is	B1 is the view held by supporters of Theory of Relativity. However, in astronomy, cosmology and other Doppler shift observations, people usually acknowledge view A.
		B2: When observed in different systems, the clocks in different reference systems (including the clocks in the observer's system) have the same velocity sequence (in other words, the velocity sequence of clocks in all reference systems is irrelevant to the state of motion of the observer).	If view A is right, then moving clocks will not have actual changes in their speed due to movement. Therefore, the atomic clock's bi-directional circumnavigation experiment that put the three clocks in one place for comparison proves view B2.
Note: The light source inside the atomic clock has no movement relative to the receiver. Therefore, the time indicated by the atomic clock reflects the emission frequency of the light source. The velocity sequence of clocks in different systems corresponds to the emission frequency sequence of the light sources of the same type.			

In addition, for the phenomenon that the clock flying westwards is faster than the stationary clock on the ground, it can be explained more thoroughly by the idea that “an absolutely stationary system exists and that the clock in absolute motion becomes lower”. Even Professor Zhang Zhongyuan, who supports Theory of Relativity, admits that the experiment proves that the slowing down of the clock is not relative. The atomic clock's bi-directional circumnavigation experiment quantitatively proves that “the moving clock slows

down”, but not qualitatively.

3 Sagnac experiment does not fully support the principle of consistency of light velocity.

Sagnac experiment confirms that the earth's gravitational field has a pulling effect on photons^[4]. Thus, Michelson-Morley experiment fails to prove the principle of consistency of light velocity. In this situation, the results of *Fizeau* experiment can be explained by the fact that water's pulling effect on photons is not 100%. However, it does not confirm the relativistic velocity composition formula. The principle of consistency of light velocity, like principles of relativity, has not been proven directly by any experiment. Many people believe that Sagnac experiment directly proves that the composition of light velocity with the system's velocity does not conform to the principle of consistency of light velocity. Some people avoid the interpretation of pulling in order to show that Michelson-Morley experiment has proven the principle of consistency of light velocity. However, in Sagnac experiment, there is no relative motion between the light source and the receiver, so it has nothing to do with Doppler shift. Some people want to explain the experimental results by the general theory of relativity. However, the gravitational potential difference in the experimental device can be neglected without compromising the precision. Therefore, the general theory of relativity cannot be applied here.

Li Huanxin *etal.* finished an experiment in 2000 on the microwave transmission between the synchronous satellites over Xi'an, China and Tokyo, showing that the earth's rotation has an impact on the transmission of light. The time that the light takes to transmit from Xi'an to Tokyo and to transmit from Tokyo to Xi'an had a difference of $95ns$ ^[5]. The environment in which the photon transmits between Xi'an and Tokyo remains constant and the gravitational effect can be ruled out. And there is no pulling frequency shift involved here either. Thus, the results can hardly support the Theory of Relativity: The resultant velocity of light velocity and the earth surface system is not constant. The result of this experiment is the same with that of Sagnac experiment, which can be explained by denying the consistency of light velocity.

4 Dayton C. Miller reproduced Michelson experiment and observed non-zero fringe movement.

Some people reproduced Michelson-Morley experiment and obtained two non-zero fringe movements: 0.33 and 1. The result of 0.33 was obtained by American physicist Miller in 1921-1925, which equals to ether wind of $10km/s$ ^[6-10]. The result of 1 was obtained by American Berkeley laboratory.

Dayton Miller reproduced the famous Michelson-Morley experiment in 1921 and obtained a result which did not support Theory of Relativity: The amount of the fringe movement was 0.33. He believed that this was a counterexample for Einstein's Theory of Relativity. He repeated this experiment for many times with the same results. He published dozens of papers in scientific journals and was convinced of the correctness of his experiment

until his death in 1941. Miller was a physicist of high qualifications. He was once an academician of National Academy of Sciences and chairman of American Physical Society. The results of his experiment made Einstein lose confidence in his Theory of Relativity. Yue Aiguo from Xiamen University who strongly supports Theory of Relativity admits that “this is a scientific problem that should be solved”.

In 1976-1977, Berkeley laboratory observed a fringe movement of $1^{[11]}$. They observed not only the movement of the earth at 30km/s, but also the extraordinary movement of the solar system in the galaxy at the speed of 300km/s and the movement of the galaxy in the space at the speed of 600km/s. This experiment was repeated for 10 times, all with the same results. The experiment also measured the speed of ether wind, which was contradictory to the results of Michelson's experiment. It denied the principle of consistency of light velocity and was supportive to Theory of Relativity.

Wang Lijun's experiment proved that light velocity c was not the fastest speed^[12].

5 Other experiments do not support Theory of Relativity in some places.

In Theory of Relativity, the transformation of velocity component by Lorentz transformation is:

$$u_x = \frac{u'_x}{1 - u'_x v / c^2}, u_y = \frac{u'_y \sqrt{1 - v^2 / c^2}}{1 - u'_x v / c^2}, u_z = \frac{u'_z \sqrt{1 - v^2 / c^2}}{1 - u'_x v / c^2} \quad (4)$$

(note: Sometimes V is used instead of u). The resultant velocity in x and y direction is:

$$\sqrt{u_x'^2 + u_y'^2} = \left[\frac{(u'_x + v)^2 + (u'_y)^2 (1 - v^2 / c^2)}{(1 - u'_x v / c^2)^2} \right]^{1/2}. \quad (5)$$

When $u'_y = c$ and $u'_x = v$, the direct resultant velocity $\sqrt{u_x'^2 + u_y'^2} = \sqrt{v^2 + c^2}$ and the

resultant velocity transformation $\sqrt{u_x^2 + u_y^2} = \sqrt{\frac{4v^2}{(1 - v^2 / c^2)^2} + \frac{c^2}{1 - v^2 / c^2}} =$

$\frac{2v}{1 - v^2 / c^2} \sqrt{1 + (1 - v^2 / c^2) \frac{c^2}{4v^2}}$, not equaling c (if the lateral velocity is v , the longitudinal

velocity is c and the resultant velocity in the oblique direction is still c , it is unimaginable).

One of the explanations for aberration is the visual disparity caused by relative motion between the stationary light source and the moving observer. The second explanation is that the visual disparity caused by a moving light source and the stationary observer. The former admits the movement of the observer himself and denies the equivalence of different inertial systems. If we admit the phenomenon of aberration, the latter will cause the fact that the resultant velocity of the photon moving in an oblique path is the vector sum of the velocities in two different directions, and that the resultant velocity will exceed light velocity c (note: The composition of velocities that does not conform to vector movement principle means the

composition of velocities under Lorentz transformation. This is the principle of composition of two parallel and anti-parallel velocities. It is not the principle of composition of velocities in two random directions). Therefore, aberration phenomenon does not support Theory of Relativity quantitatively or qualitatively. In aberration phenomenon, Theory of Relativity and principle of consistency of light velocity cannot be reconciled.

The light emitted from a star is bended when passing near the surface of the sun. This experiment is believed to be one of the three major verifications of the general theory of relativity. If observed from a straight space, the light is attracted by the sun and a longitudinal movement is composited to its horizontal movement. The measured angle of deflection of light is ϕ_1 in Figure 7. If the observer moves in the direction vertical to the light, $u'_y = c$ and $u'_x = v$ can be satisfied and the ultra-light velocity composition formula (5) can be applied.

Zhu Yongqiang from Fudan University invented “positive and negative speedometer of broken electromagnetic waves”. The measurement of the movement velocity of the system inside the system is realized based on the principle that the movement of the light source has no pulling effect on electromagnetic waves and the induction is generated when the device moves relative to electromagnetic waves^[13, 14]. Broken electromagnetic waves exist as “isotropic electromagnetic waves” and its speedometer is also a real object. Ji Hao repeated Bettozzi's experiment, and found the result conformed to the relativistic mass-energy relationship in low velocity; while in high velocity, the result did not conform to the relationship^[15-17].

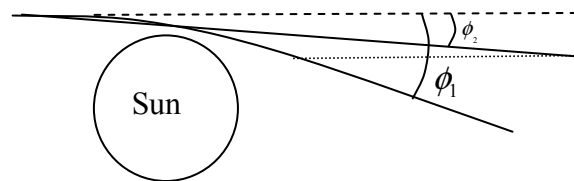

Figure 7. If the photon dragged by the sun has no inertia, then the deflection angle is ϕ_2 and it is relevant to the distance between the star and the observer; on the contrary, ϕ_1 is the angle observed and irrelevant to the distance between the star and the observer.

The places of other experiments that do not conform to Theory of Relativity are shown in Table 2.

Table 2 Experiments which support Theory of Relativity in some places but not in other places

No	Experiment	Parts and/or explanation in favor of Theory of Relativity	Parts and/or explanation against Theory of Relativity
1	JonesExperiment	Lateral movement is consistent with the predictions of Theory of Relativity	Lateral movement is relevant to the thickness of the disk, which proves the non-equivalence of different inertial systems.
2	Sagnac experiment	The experiment seems to be	It proves that the observer obtains different light velocity when he moves towards or

		explained by the general theory of Theory of Relativity	away from the photon.
3	Miller's Ether-drift experiment	---	It proves the existence of absolute stationary reference system or the inconsistency of light velocity
4	The atomic clock's bi-directional circumnavigation experiment	When observed in a system not rotating, the results confirm that the clock is slowed down.	It proves that the slowing-down of clocks is not relative. The atomic clock has no movement relative to the light source and the frequency receiver. The comparison between the moving clock with the stationary clock shows that it is the emission frequency of the light source used for recording time that is measured, and the emission frequency decreases. If the emission frequency of the light source is not the same in different systems, then different inertial systems are not equivalent. Therefore, this experiment denies the Theory of Relativity.
5	Muon life-span experiment	When observed on earth, the clock slows down.	It proves that the slowing down of the moving clock is not relative.
6	Ultra-light velocity experiment by Wang Lijun	---	It proves the existence of objects of ultra-light velocity.
7	Ji Hao's thermal measurement experiment	Within a certain scope, the results conform to Theory of Relativity.	It proves that when the energy reaches a certain order of magnitude, the relationship between energy and velocity does not conform to the prediction of Theory of Relativity.
8	Ji Hao's electron beam deflection experiment	Within a certain scope, the results conform to Theory of Relativity.	It proves that when the energy reaches a certain order of magnitude, the relationship between energy and velocity does not conform to the prediction of Theory of Relativity.
9	Fizeau experiment	Quantitatively it conforms to Theory of Relativity	It can be explained by the fact that the pulling efficiency on the photon of the water is not 100%. It can also be explained by the Fresnel drag effect.
10	Michelson-Morley experiment	It is believed to have proven the consistency of light velocity and the non-existence of absolutely stationary	It can be explained by the fact that the earth's strong gravitational field on has a 100% pulling efficiency on the photon; it can also be explained by Stokes Ether drag theory.

		system and ether.	
11	Light deflection experiment	It is believed to have proven the theory of general relativity.	When observed in a straight space, the velocity of photon that reaches the observer's retina is the resultant velocity of the horizontal and longitudinal velocities, which exceeds light velocity c .
12	Gravitational red-shift experiment	It is believed to have proven the theory of general relativity.	Red shift can also be explained by the mutual transformation of kinetic energy and potential energy in Newton's theory.
13	Aberration phenomenon	It is believed to have proven Lorentz transformation	When the observer and the light source have relative movement, if the light source's movement is denied while the existence of aberration is admitted, then the resultant velocity of photon moving in oblique path is certainly higher than light velocity. If the movement of the observer itself is admitted, then the equivalence of different inertial systems is denied.

It can be seen that people have been so careless when analyzing the results of an experiment.

6 Discussion and outlook

Many experiments partially conform to Theory of Relativity. This is a truth that no one can deny. However, the existing experiments provide neither qualitative proof for the principles of relativity nor for the second level micro-scale (*i.e.* high-order effect) and the length contraction effect. In fact, many experiments believed to have confirmed Theory of Relativity only support the theory in some places. If the focus of attention is changed, the places that do not support Theory of Relativity can be found. In other words, except for a local experiment, from nearly all the experiments can be found some places that conform to Theory of Relativity; however, with a changed focus of attention, places that do not support Theory of Relativity can also be found. When people believe a certain experiment has proven the Theory of Relativity, this is because they have explained in favor of the Theory of Relativity when analyzing the experimental results. For quite a long period in the past, people were careless when analyzing an experiment. It is irresponsible to say that "all the experiments have proven the Theory of Relativity without exception". The present paper aims to change the deeply rooted idea that "all the experiments have proven the Theory of Relativity without exception".

Many experiments have some places that support Theory of Relativity and also the places that do not (many experiments are a double-edged sword for the Theory of Relativity). This indicates that Theory of Relativity has its right sides and wrong sides. It is time to set to solve the significant doubts related to Theory of Relativity. Looking into the future, we can see that renewed and more correct theories will certainly contain the positive research results of Theory of Relativity.

One hundred years has passed since the birth of Theory of Relativity, but the arguments around it have never stopped and are becoming fiercer. The opposition sides insist on completely denying Theory of Relativity based on a few experiments, while the supporters believe that “all the experiments have proven the Theory of Relativity without exception”. The two sides demand the opposite side to provide new evidences (*i.e.* new and more experiments to approve or disapprove the Theory of Relativity). To satisfy these demands is a waste of research resources.

To search for points that support the Theory of Relativity and points that do not from the existing experiments is a new and low-cost research method. The conclusion that “except for a local experiment, all experiments are a double-edged sword to Theory of Relativity, which indicates that Theory of Relativity has reasonable parts and also problems to be solved” is more objective and more persuasive. It conforms to the law of development of scientific theories and can be easily accepted by the two sides. It can put an end to the long lasting argumentation about the Theory of Relativity, so that scientists can be devoted to solving the scientific problems related to the Theory of Relativity and the waste of research resources can be avoided.

The author has found the parts that support and do not support the Theory of Relativity in atomic clock's bi-directional circumnavigation experiment and the experiment conducted by Jones et al. The key to the method presented by the author is to change the focus of attention. The publication of the present paper is the turning point of “dialectical analysis of experimental results” and “new trend in fundamental research”.

Acknowledgement: In writing the present paper, I was challenged by Prof. Guo Chongwu, who also gave me many valuable suggestions. I would like to thank him for making the paper richer and more precise. After the finalization of the script, he examined the paper carefully. Again I'd like to extend my heartfelt gratitude to Prof. Guo Chongwu.

References

1. R. V. Jones (1971) Aberration of light in a moving medium. *J. Phys. A*, **4**: L1.
2. R. V. Jones (1972) *Proc. R. Soc., Lond*, **A328**: 337
3. R. V. Jones (1975) *Proc. R. Soc., Lond*, **A345**: 351
4. G. Sagnac (1913) *Comptes Rendus de l'Academie des Sciences (Paris)* 157: 708-710, 1410-1413.
5. Li Huanxin, Song Jin'an, Li Zhigang, Liang Shuangyou (2000) Two-Way Satellite Time Transfer via Geostationary Communication Satellite between China and Japan[J]. *Publications of Purple Mountain Observatory*.19(2): 121-126.
6. Dayton C. Miller (1933) The Ether-Drift Experiments and the Determination of the Absolute Motion of the Earth. *Reviews of Modern Physics*. 5(3): 203-242.

7. Dayton C. Miller (1926) Significance of Ether-drift Experiments of 1925 at Mount Wilson, Address of the President, American Physical Society, Science. 63: 433-443.
 8. Dayton C. Miller (1922) Ether-drift Experiments at Mount Wilson Solar Observatory, Physical Review , S2. 19(4): 407-408.
 9. Dayton C. Miller (1926) Ether-drift Experiments at Mount Wilson in February, National Academy of Sciences, Washington {Physical Review. S2, 27(6): 812}. Dayton C. Miller(1926)Ether-drift experiments at Mount Wilson in February 1926, Physical Review, xxvii: 812.
 10. George Joos & Dayton C. Miller (1934) Note on the Repetition of the Michelson-Morley Experiment, Physical Review. S2, 45(2): 114.
 11. Richard A. Muller (1978) The Cosmic Background Radiation and the new ether drift, SCIENTIFIC AMERICAN. 238(5): 64-74.
 12. Wang, L. J., Kuzmich A. & Dogariu A (2000) Gain-assisted superluminal light propagation. Nature. 406(6784): 277- 279.
 13. Zhu Yongqiang (1994) Chinese Patent, ZL94-1-14042.3. 1994-12-15.
 14. Yongqiang Zhu, Wang Yu, etc. (2001) The character and application of the smashed the electromagnetic wave. ACTA PHYSICS SINICA, , 50(5): 832 ~ 836.
 15. Ji Hao (2006) On Experiment that Measures the Momentum-Energy Relation of Moving Electrons. China Engineering Science. 8(10): 60-65.
 16. Fan Liangzao, Hua Di (2010) Two Experiments Challenging Traditional Electromagnetic Acceleration Theory and Einsteinian Mechanics. Frontier Science. 4(1): 56-64.
 17. Fan Liangzao (2009) Can the Mass of Microparticles in High-speed velocity Increase Indefinitely with the Increase of its Velocity? -- Comments on the Four Experiment Reports of Mr. Ji Hao which challenges relativistic Mass-velocity Relationship. Frontier Science. 3(4): 84-87.
-

Analysis of “singular point theorems”—Further Understanding of Relativistic Time View

Wu Fengming

China Aviation Industry Shanxi aero engine repair Co Ltd

Abstract :According to the “paradox of singularity theorem” proof of concept of time, the mathematical logic and the prerequisite conditions, based on successive analytical, logical argumentation about time singularity theorem proving the beginning and the end of the conclusions cannot be established: Since there is no from the material time, is not start from the material existence time and the end, so the “singularity” also cannot be regarded as the time of beginning and ending, “began the singularity theorem” cannot prove the and the end of time. Therefore, only a matter of existence and nonexistence can begin as time and the end, only the material existence and non-existence to express (or proof) began its time and end. This is the expression of the view of time.

Keywords:Singular point, singular point theorem, substances, concept of time

“Singularity theorem” is the Penrose and Hawking proved a mathematical theorem time. The theorem can be roughly expressed as: As long as the establishment of general relativity, the causal nature of good material there, on at least one physical process, the existence of its time to start or end there, or both the beginning and end. The substance of the theorem is: The establishment of causality, the general theory of relativity is correct, but also the existence of space-time material, the at least one of the physical processes can be achieved, which in a limited time before or after the end of the limited time available. In other words, at least one physical process, it’s time to start, or end, or both the beginning and end. In other words, the process of at least one time, it's one or two is limited.

Proof of the theorem can be summarized by the process: If there is a type of class-ray or geodesic in the direction of the future or the past, in the limited distance affine broken, cannot continue to extend, then, that the root geodesic line was considered to be a time when “The Hole”. If you do not fill this hole, it is the singular point. Penrose and Hawking proved: As

long as the general theory of relativity is correct, and the establishment of causality, then, any material time and space, at least there is a singular point.

Singular point of time and space are called space-time singularity. Singular time and space, even to undermine the singular point, it will not change the nature of space-time singularity. However, undermine the singular point will stay empty, so that a line any time and space through this often in this empty broken. Thus, Penrose and Hawking suggested that simply from the singular point in time and space “removed”, that it does not belong to time and space, or simply as a singular point of time and space to the “empty” (the hole is not patched). Accordingly, the Penrose and Hawking proved that the existence of space-time at least have the following properties of a category or type of light-time curve: Its limited distance will cut off, and place cut off any means of repair cannot be used to make the curve can be an extension of the past.

In accordance with the general theory of relativity, because the time curve of Central Asia, the speed of light (that is, when the geodesic-type) in length can be seen as a movement along the lines experienced by the material intrinsic time, this curve when empty (that is, the singular point) cut off, on can be seen as a process of broken this time. Accordingly, the Penrose and Hawking that the “singularity” is a place cut off time for the process, and thus to prove that their singularity theorems.

They prove that: In the strong cause and effect in time and space do not necessarily have the most long-term and, if so, then certainly there is no point conjugate geodesic;

Hyperbolic space and time in the overall, we have the most long-term, and must be non-conjugate geodesic points;

In general relativity is correct, the establishment of strong energy condition, and at least one space-time existence of the material point of time and space, the geodesic affine in a limited distance from the existence of conjugate points must.

Proved in accordance with their conclusions, that is, the causal conditions (including the hyperbolic space-time) are asking for the longest geodesic, and certainly there is no point conjugate geodesic; and energy conditions of general relativity and the existence of material requested in this geodesic line must be conjugate points, and in a limited distance on the emergence of affine conjugate points.

Clearly, this geodesic cannot be both at the same time satisfy the conjugate points, have no conjugate points, this condition, which is a contradiction of terms. To resolve this conflict the only way the conditions are: Do not let this geodesic unlimited extension of conjugation in the event of it before, in the limited distance affine singular point on the face (i.e., syringomyelia) and cut off. In other words, the geodesic will encounter singular point (i.e., syringomyelia) and the cut off time will be cut off the course, a certain limited time (the beginning and the end of time), there must be space-time singularity. In this way, they proved that the singular point theorem.

Only singular point of the above theorem to prove a brief overview of the process,

readers learn more about, if necessary, see “21th 100 cross-scientific problems • the beginning and the end of time” (Science Press • 2005 years 1 was published).

Now, we time the concept of mathematical logic and prerequisite conditions to resolve the singular point theorem.

1 Singular point of time the concept of analysis of theorem

From “On the time and the end of the beginning of what is” (see “cutting-edge science” • 2008 No. 1) a text, we know that time is the definition of the concept of the existence of expression and movement of material from beginning to end, as well as the process of continuous physical quantities. This means that time is only a physical, the physical expression of a material is used (such as a physical field or in kind) from the beginning only the end of the existence and movement and the movement has always been there, as well as the length of the continuous process of measuring. This measure does not have any sub-curve of the speed of light that it can, and there is no physical movement of the inherent time experienced that it can be. Therefore, it does not exist in any sub-light curve, there is no inherent time, there is no question of the so-called start and end time. That being the case, then the singular point is how to prove theorems of the time of the beginning and the end of it?

Singular point from the previous theorem, we prove that the process can be seen on: Singular point theorem is based on general relativity, the space-time in a sub-curve of the length of the speed of light along this line as a movement experienced by a substance inherent in time, thus, also to cut off a sub-curve is equivalent to the speed of light inherent in the process cut off time, and accordingly concluded that the time on the course of the broken, and the end of the beginning of time, time is so limited.

However, according to the definition of the concept of analysis of time we will be able to understand: Because time is the existence of expression and movement of material from beginning to end, as well as a continuous physical quantity, so the number of substances, expressed in this material there is a measure of the number of physical quantities, that is, material expression of this measure the number of time there. Therefore, any material and the existence of a specific process and campaign statements of the substance itself can only be experienced by the individual time course, the concept of the definition of time cannot be expressed at this time of the physical process. That is to say, cannot be any substance to a specific time course of individual experience, the concept of time as a physical definition of the process this time; the time nor the definition of the concept of the physical process of this time, as any experienced by a specific substance the time course of the individual.

However, in accordance with the theorem of singular point analysis of the concept of time, but a singular point theorem substances the time course of individual experience - for example, a particle along its sub-movement experienced by the speed of light curves of the time course of the inherent concept of time as defined physical process of this time, and the

speed of light curves of the sub-cut off time as a process inherent cut off, and then, again broken the course of this inherent time equivalent for the physical process of the time cut off. Then, you say that it is time this process has been broken, and the end of the beginning of time, time is limited. Clearly, this is not only inconsistent with the definition of the concept of time, nor the existence of every material and movement expressed by the significance of individual time, this argument is untenable. This is the theorem of singular point analysis of the time the conclusions of the concept.

2 The singular point theorem of mathematical logic

In accordance with the general theory of relativity, to any substances, because every other substances in the material quality of the bending of space along the short line (i.e. geodesic) movement, so the length of the short line as a movement along this line of a substance (such as a particle) experienced by the inherent definition of time is in line with the time and energy to meet the conditions for the existence of general relativity and material requirements for this short line is also set up broken. However, this raised a question: From the mathematical point of view because of this short-line and cut off when a singular point, but from the physical point of view along the line of movement of substances (such as a particle) do? Along new lines to continue to campaign so short? Or by the so-called singular point annihilation by the case?

We first considered that the material continues to campaign: In accordance with the logic of reasoning, this short line is because the movement of material existence, so as long as the material continues to campaign, this short-range line on the continued existence; and as long as the continued existence of this short-range line, the time process continued out on the inevitable. Thus, while the front line because when the short-range and cut off the singular point, but behind the short line because of the continued movement of the material and continue to exist. Here, we do not need to salvage the broken line to the short-range extension, we need to do is to let the substance to continue to campaign, this short-line will be able to continue to extend its inherent time rather than continuing the process will be able to cut off; and that the material continuous process to continue to campaign for how long, the short lines have continued to extend the length, the time is how long a continuous process. How to prove that this short broken lines, and its time course has been broken it? Clearly, the singularity theorems are not in line with the conclusions of the above logic, and therefore cannot be established.

We continue to think that the singular point the material was so-called annihilation: In accordance with the logic of reasoning, the short-broken line, and the annihilation of the material also, but this is because the annihilation of the substance which has been cut off short-range line only, and only a physical movement of the broken line of short-range - that is only broken by the time course of the individual, rather than the physical definition of the concept of time this time cut off the process. Because they cannot put a specific substance in

any of the individual time course of experience, the concept of time as a physical definition of the process this time, we cannot say that the time course of which has been broken, and the end of the beginning of time, time is so limited.

In accordance with the above logic, mathematics, regardless of whether the substance was annihilation, but also regardless of whether or not this short broken lines, we cannot prove that the definition of the concept of physical time to the time course of the broken, we cannot prove that the physical and the end of the beginning of time, and it cannot physical proof that time is limited. Singular point so that the conclusions of theorem proving in mathematical logic is not established.

3 The singular point theorem absurd precondition for

Singular point from the previous theorem, we prove that the process can be seen briefly in the singular point theorem to prove the process, in order to resolve this geodesic (that is, short-line) on both conjugate points (the energy conditions of general relativity and material the existence of requirements), have no conjugate points (causality requirements) the contradiction between the conclusions so that this geodesic conjugate points in the event before the cut off to meet the requirements of causality conditions. As a result, although this part is not broken geodesic which meets the requirements of causality, but can also satisfy the energy conditions for the existence of general relativity and material conditions required by it? Theorem quoted from the singular point of view a prerequisite, it is clear that the singular point theorem is considered to meet the conditions. Well, not broken geodesic of this part whether or not to meet the energy conditions of general relativity and the existence of the required material conditions? Next, we singularity theorem based on evidence of the process to answer the question.

Theorem from the singular point of view of the certification process because of this singular point theorem quoted a prerequisite geodesic is a geodesic a whole, that is, to meet the requirements of causality, and energy conditions for the existence of general relativity and material requirements of an overall test ground, so although the cutoff point conjugate containing part of the geodesic, but this does not affect this part is not broken geodesic as a whole continues to exist in the nature of geodesic. Therefore, this part is not cut off can still be seen as a geodesic is a geodesic a whole, that can still be seen as meeting the requirements of causality, and energy conditions for the existence of general relativity and material requirements of a whole geodesic. In practice, however, because there must be geodesic line is the energy conjugate conditions, general relativity and material required by the existence of a necessary condition, it contains the conjugate point to that part of the broken geodesic, it could mean the loss of the a necessary condition; and the loss of the necessary conditions, it could mean the loss of a geodesic as a whole the nature and preconditions. Therefore, not cut off this part of the nature of geodesic it is no longer seen as a prerequisite for a geodesic overall, of course, it can no longer satisfy the energy conditions for the existence of general

relativity and material conditions required, and causality is only required to meet the conditions of the.

However, the singularity theorems are considered to satisfy the energy conditions for the existence of general relativity and material conditions required. It is clear that the singular point theorem to satisfy the energy conditions for the existence of general relativity and material as a prerequisite for the existence of paradox. .

Further analysis can also be proven that the singularity theorems also cited the existence of the precondition paradox, because there was no singular point theorem of the assumption that the premise of whether the conditions to meet the energy conditions for the existence of general relativity and material conditions required, the conclusions are contradictory.

To sum up, we can have a base that the singular point theorem quoted as a prerequisite for the existence of paradox, the paradox which the singular point theorem to prove there is paradox, and paradox is a contradictory and untenable. This is the answer to the question of the singularity conditions of Theorem absurd premise.

4 The singular point of the re-interpretation of theorem

In accordance with the previous analysis, although the singularity theorems in the physical sense, this time cannot be established, but the time when we are seen as statements of material existence and movement as well as the process is always the physical continuity of the time, the singularity theorems of (singular point is expressed by) the beginning and the end of time as a substance that the individual start and end time, the singularity theorems of a particular material is expressed by the meaning of physical time it is obvious that the of. For example: The beginning of a physical presence and movement, we say that a substance that the individual time course began; the end of a physical presence and movement, we say that a material expressed by the end of the individual time course; a physical presence and movement from the beginning and the end of the existence and movement of the continuing process of how long, we say that a material expressed by the process of how long individual time. For example: View of building materials - we use several billion years to express their individual time continuous process; of macro-and micro-material substances - and we were year, month, day, hour, minute, second to express their continued individual time process and so on. .

In the above expression, since the only material that has the time of the physical, so we used this time to express their individual physical processes and the start time and end; also because there is no material from the specific time, therefore, cannot be used (not used) singular point of the so-called theorem proving and the end of the beginning of time to express their individual process and the beginning of time and the end. Here, the fundamental difference between the two is: Penrose and Hawking the “singularity” as the beginning and the end of time; and author of the existence of the material (the beginning of movement) and non-existence of (the end of movement) as the beginning of the individual time and the end.

According to this fundamental difference between, we can say that the singularity theorems and the end of the beginning of time, only for specific substances and movement and the process has always been expressed in continuing - individual time for the beginning and the end will only be meaningful ; and the definition of the concept of physical time this time is does not make sense, is simply not tenable. This is the singular point theorem for a particular material is expressed by the meaning of physical time.

Originally, the existence of any substance and the process for the movement - there is the end of the beginning, it started with the end of it there is a continuous process (i.e., duration), this is all material in their presence and movement shown by the process of natural law is not self-evident truth of nature. Problem only: How can we understand it correctly and accurately describe it? This is the title of the singular point of the re-interpretation theorem.

To sum up, because the proof of singularity theorems such as the time during the existence of the concept of mathematical logic and the premise of the absurd conditions, the singular point of the conclusions of theorem proving, in accordance with the definition of the concept of time is untenable. Although the singularity theorems on time for the beginning and end, but also that the existence of a specific material and process of the individual and the end of the beginning of time, but it is expressed as a physical, rather than as a singular point theorem the so-called start and end time expressed. In that case, the singular point theorem and its time and the end of the beginning of what they said, or what do they prove? To answer this question, please answer, what time is it !

References :

- 1 Edited by Li Xixian in twenty-first Century 100 cross scientific problems, Science Press, Beijing, 2005 January.
- 2 Einstein, the principle of relativity, Zhao Zhitian (Translated) Meng Zhaoying (school), Beijing, Science Press, 1980 February.

The Own Unresolved Issues of Einstein's Original Work on the Electrodynamics of Moving Body

Yang Shijia

Gansu Jinchang Secondary Specialized School of Science and Technology, 737100, China,
yashijia@163.com Mobile telephone : 13359306033

Abstract: I have studied Einstein's original “on the Electrodynamics of Moving Body” for many years, found its own 30 unsolved problems at least, Einstein's theory of relativity is a mistake from beginning to end. It can be said that the work is based on wrong assumptions, according some wrong derivation, and end up with some wrong conclusions. We argue that his paper is patterns of fabrication. Einstein tells a lot of lies, regard his image as science, you cannot believe him, Einstein's theory of relativity is a paper tiger actually , can be punctured easily. It is impossible for anyone in his right sense to understand his lies.

Keyword: 30 unsolved problems, a paper tiger

1 Introduction

Hua Di (retired), academician of Russian Academy of Astronautics, researcher of Stanford University , raised a lot of questions about the derivation of many major equation in Einstein's original Work on the Electrodynamics of Moving Body^[1] in his “Mechanics with Variable Speed of Light”^[2], I studied Hua Di's work patiently and carefully, I realized that the Hua Di's mathematical derivation is correct.

Dr. Ma Qing ping, researcher at London University, proposed a lot of question on Einstein's derivation, in his work 《Self-Consistency about the Theory of Relativity》 , he says: Einstein do not respect the basic rules of mathematics and logic, assign the moving coordinate system and rest coordinate system arbitrarily, casually set a transformation equations belongs to moving coordinate system on a rest coordinate system and a rest coordinate system equation on a moving coordinate system. Often play a trick of substituting concept and perpetrating a fraud.

I wrote a paper 《The theory of relativity is a self-contradictory sophistries》 in 1980, We argue that his paper is patterns of fabrication. Einstein tells a lot of lies, regard his imagine as science, you cannot believe him.

I have been studying Einstein's original Work 《On the Electrodynamics of Moving Body》 for many years, and have find out 30 unsolved problems of its own theory at least, Due to space limitation, in this can only give a few examples as follows:

2Six issues among thirty own unresolved issues of Einstein's original workon the Electrodynamics of Moving Body

2.1 Trying to cheat

In paragraph 10 of Einstein's original Work 《On the Electrodynamics of Moving Body》 , Einstein wrote:

$$\frac{1}{2} \left[\tau(0, 0, 0, t) + \tau\left(0, 0, 0, t + \frac{x'}{c-v} + \frac{x'}{c+v}\right) \right] = \tau\left(x', 0, 0, t + \frac{x'}{c-v}\right)$$

(1)

It x' is assumed to be infinitely small, then

$$\frac{1}{2} \left(\frac{1}{c-v} + \frac{1}{c+v} \right) \frac{\partial \tau}{\partial t} = \frac{\partial \tau}{\partial x'} + \frac{1}{c-v} \frac{\partial \tau}{\partial t} \quad (2)$$

It should be noted that we don't have to choose the origin of coordinates as the starting point of light; we can choose something else, thus the equations above is valid for all the values of x', y, z .

Unresolved Issues: Professor Hua Di says in his book: Then, Einstein substituted his wrong expressions of moment of τ_0, τ_1, τ_2 into the formula (1) which they cannot meet:

$$\frac{1}{2} \left[\tau(0,0,0,t) + \tau\left(0,0,0,t + \frac{x'}{V-v} + \frac{x'}{V+v}\right) \right] = \tau\left(x',0,0,t + \frac{x'}{V-v}\right)$$

And sets x' to be infinitely small, he gets:

$$\frac{1}{2} \left(\frac{1}{V-v} + \frac{1}{V+v} \right) \frac{\partial \tau}{\partial t} = \frac{\partial \tau}{\partial x'} + \frac{1}{V-v} \frac{\partial \tau}{\partial t} \quad or \quad \frac{\partial \tau}{\partial x'} + \frac{v}{V^2 - v^2} \frac{\partial \tau}{\partial t} = 0$$

According this wrong derivation, he got:

$$\tau = t - \frac{v}{V^2 - v^2} x'$$

In addition, I don't understand how did Einstein conclude (2) from (1)? I think that only if (1) is construed as

$$\frac{1}{2} \left[\tau(0, 0, 0, t_0) + \tau \left(0, 0, 0, t_0 + \frac{x'}{c-v} + \frac{x'}{c+v} \right) \right] = \tau \left(x', 0, 0, t_0 + \frac{x'}{c-v} \right)$$

(3)

Assumes x' to be infinitely small , for (3) , In addition to seeking partial derivative of x' , also seems to seeking partial derivative of t by the linkage rule to seek composite function derivation? , and we know that x' and t are not independent variables by $x' = x - vt$, as well as x' is constant or variable for the derivation process? In a word, it's not correct to get (2) from (1). Please pay attention here, in order to make his theory appears to be reasonable , Einstein mix up two concepts here, he replaced the distance x' by the x' set as the position of reflect mirror in the Coordinate system intentionally.

According to Einstein's theory: The equations are valid for all the values of x', y, z .

Which means, when $x' < 0, \tau_0 = 0$,

$$\frac{x'}{c-v} < 0, \frac{x'}{c+v} < 0, \tau_2 < \tau_1 < 0$$

May I ask Einstein, What it means when the time turned out to be negative? Is that the so-called back in time?

2.2 Inappropriate use of letters

In paragraph 21 of Einstein's original Work , Einstein says: Light (required by Constancy principle and the principle of relativity jointly) is spreading at speed c in the dynamic system. When time $\tau = 0$, Shoot out a light along the direction of ξ -increasing, its equation is

$$\xi = V\tau \quad \text{or} \quad \xi = aV \left(t - \frac{v}{c^2 - V^2} x' \right) \quad (4)$$

But, in static system, this light travels at speed $V - v$ relative to the origin k, so

$$\frac{x'}{c-v} = t$$

If we substitute this value t into the equation about ξ , we get

$$\xi = a \frac{c^2}{c^2 - V^2} x' \quad (5)$$

Unresolved Issues: Based on context, $V = c$ in (4) , then both (4) and (5) will lose their meaning. Otherwise, if we substitute this value t into the equation about ξ , we get

$$\xi = aV \left(\frac{x'}{c-v} - \frac{v}{c^2-v^2} x' \right) = aV \left(\frac{1}{c-v} - \frac{v}{c^2-v^2} \right) x' = aV \left(\frac{c+v}{c^2-v^2} - \frac{v}{c^2-v^2} \right) x' = a \frac{Vc}{c^2-v^2} x'$$

That is

$$\xi = a \frac{Vc}{c^2-v^2} x' \quad (6)$$

EQ (6) shows that, if Einstein's (5) is workable, $V = c$ is a must, this will cause a contradictory and lose their meaning.

First of all, I recommend that Einstein tries not to mess with the letters in the derivation process; Secondly, according to Einstein's theory: Light travels at speed c in dynamic system, but in the static system, light travels at speed $c - v$ relative to origin k , what is this constancy principle? So, Einstein changed the values on his will in order to get the result he wants during his derivation.

2.3 Playing magic

In Einstein's original Work 《On the Electrodynamics of Moving Body》 , chapter 4, the physical meaning of the equation resulting from moving rigid body and moving clock. He says: When we observe a rigid sphere of radius R , it is stationary relative to moving system K , its center locate at the origin of the coordinate K . This ball is moving at velocity v relative to the K , his spherical equation is

$$\xi^2 + \eta^2 + \zeta^2 = R^2$$

Represented with x, y, z , at the time $t = 0$, this spherical equation turns out to be

$$\frac{x^2}{\left(\sqrt{1 - \left(\frac{v}{c} \right)^2} \right)^2} + y^2 + z^2 = R^2 \quad (7)$$

Therefore

$$\tau = t \sqrt{1 - \left(\frac{v}{c} \right)^2} = t - \left(1 - \sqrt{1 - \left(\frac{v}{c} \right)^2} \right) t \quad (8)$$

So this clock, in the static system, indicate $1 - \sqrt{1 - \left(\frac{v}{c}\right)^2}$ second slow every second.

Unresolved Issues: EQ(7) is workable exactly when $t = 0$, once it starts move, $t \neq 0$, it's not workable anymore, So it cannot be generalized to any other time; Furthermore, there is no movement since $t=0$, β loses its meaning, EQ (7) loses its meaning, too. In addition, In order to get EQ (7) from the transformation $\xi = \varphi(v)\beta(x - vt)$ in chapter 3, Einstein says $t = 0$; but In order to get EQ (8) from the transformation $\tau = \varphi(v)\beta\left(t - \frac{v}{c^2}x\right)$ in chapter 3, Einstein says $t \neq 0$, Just as Dr. Ma Qing ping said, Einstein fails to comply with the logic of law of identity.

According to the requirements of logic same law, since, Einstein used $t = 0$ in the discussion of moving rigid body, and then $t = 0$ should be used in the discussion of motion clock, so EQ (8) turn out to be $\tau = 0$. Therefore, Einstein said: "This clock (in static system)

indicated $1 - \sqrt{1 - \left(\frac{v}{c}\right)^2}$ seconds slow every second" is totally nonsense. Till now, people

can realize how Einstein played Magic.

2.4 Absurd deduction of $U = \frac{0}{0}$

In Einstein's original Work 《On the Electrodynamics of Moving Body》, chapter 5, he says: K-system is moving along the X-axis of itself at velocity v, features a point in motion in accordance with the following equation:

$$\xi = w_{\xi}\tau, \quad \eta = w_{\eta}\tau, \quad \zeta = 0$$

Here both w_{ξ} and w_{η} represents a constant.

When studying the relative motion of this point to the K- system. By means of the conversion equation derived in chapter 3, introduce the value x, y, and z into the motion equations of this point, we get:

$$x = \frac{w_{\xi} + v}{1 + \frac{vw_{\xi}}{c^2}} t \quad y = \frac{\sqrt{1 - \left(\frac{v}{c}\right)^2}}{1 + \frac{vw_{\xi}}{c^2}} w_{\eta} t \quad z = 0$$

Thus, according to our theory, the parallelogram law of speed is workable only within the range of first stage. If we set:

$$U^2 = \left(\frac{dx}{dt}\right)^2 + \left(\frac{dy}{dt}\right)^2 \quad w^2 = w_{\xi}^2 + w_{\eta}^2 \quad \alpha = \arctg \frac{w_{\eta}}{w_{\xi}}$$

Angle α is the angle between two velocity v and w . After a simple calculation, we get:

$$U = \frac{\sqrt{(v^2 + w^2 + 2vw \cos \alpha) - \left(\frac{vw \sin \alpha}{c}\right)^2}}{1 + \frac{vw \cos \alpha}{c^2}}$$

Unresolved Issues: First of all, we have to derive the formula ourselves, according to Einstein's equation, we get

$$\begin{aligned} U^2 &= \left(\frac{dx}{dt}\right)^2 + \left(\frac{dy}{dt}\right)^2 = \left(\frac{w_{\xi} + v}{1 + \frac{vw_{\xi}}{c^2}}\right)^2 + \left(\frac{\sqrt{1 - \left(\frac{v}{c}\right)^2}}{1 + \frac{vw_{\xi}}{c^2}} w_{\eta}\right)^2 \\ &= \frac{w_{\xi}^2 + 2w_{\xi}v + v^2 + w_{\eta}^2 - \left(\frac{v}{c}\right)^2 w_{\eta}^2}{\left(1 + \frac{vw_{\xi}}{c^2}\right)^2} = \frac{v^2 + w^2 + 2w_{\xi}v - \left(\frac{vw_{\eta}}{c}\right)^2}{\left(1 + \frac{vw_{\xi}}{c^2}\right)^2} \end{aligned}$$

Angle α is the angle between velocity v and w , that is the angle between velocity v and axis w , so

$$w_{\xi} = w \cos \alpha, \quad w_{\eta} = w \sin \alpha$$

Substituted them into the formula above, we get

$$U^2 = \frac{\left(v^2 + w^2 + 2vw \cos \alpha \right) - \left(\frac{vw \sin \alpha}{c} \right)^2}{\left(1 + \frac{vw \cos \alpha}{c^2} \right)^2}$$

$$U = \frac{\sqrt{\left(v^2 + w^2 + 2vw \cos \alpha \right) - \left(\frac{vw \sin \alpha}{c} \right)^2}}{1 + \frac{vw \cos \alpha}{c^2}}$$

According to the Einstein, the formula can be launched, but U and v are value defined in K- system, but w defined in k- system. Using the velocity defined in different coordinate systems in velocity composition. That's funny. Secondly, when $v = w = c, \alpha = \pi$, substituted them into the equation above, we get $U = \frac{0}{0}$, the equation itself is meaningless, but it means some practical considerations, how to resolve this contradiction?

2.5 Self-contradiction between the derivation of $A'^2 = 0$ and “infinite strong”

In Einstein's original Work 《On the Electrodynamics of Moving Body》, chapter7, he says: You can know from the equation about w' : If an observer is moving at speed v relative to a light source at frequency ν at infinity, and referring to a still system relate to the light source,

The connect line between the light source and the observer and the velocity direction of the observer intersection into angle φ , we should also find the amplitude of these waves in dynamic system. If the amplitude of electric power (or magnetic power) measured in static system and dynamic system are defined as A and A' , then we get:

$$A'^2 = A^2 \frac{\left(1 - \frac{v}{c} \cos \varphi \right)^2}{1 - \left(\frac{v}{c} \right)^2}$$

If $\varphi = 0$, this equation reduces to:

$$A'^2 = A^2 \frac{1 - \frac{v}{c}}{1 + \frac{v}{c}} \quad (9)$$

From these obtained equations, we can know that for a viewer moving towards the light

source at velocity, the light source must appear to be infinite strong.

Unresolved Issues: First, “infinity” is not a determined place, there is no specific location, which means, and the position of the light source is not identified. Strictly speaking, there is no practical meaning for this kind of discussion; secondly, it is not clear enough that φ is constant or variable. However, they can be regarded as approximation. Thirdly, substituted $v = c$ into EQ (9) we get

$$A'^2 = A^2 \frac{1 - v/c}{1 + v/c} = A^2 \frac{1 - c/c}{1 + c/c} = 0$$

According to the equation above, it is ridiculous for Einstein to claim that for an observer moving towards the light source at velocity c , the light source must appear to infinite strong , is purely nonsense.

2.6 The derivation of $\epsilon X = \frac{1}{\mu\beta^3} \epsilon X$ is ridiculous

In chapter 10 (slowly accelerated) of Einstein's original Work 《On the Electrodynamics of Moving Body》 , he wrote: If an electron is stationary in a certain period, after this period, as long as the electron motion is slow, its movement will follow the following equation

$$\mu \frac{d^2 x}{dt^2} = \epsilon X \quad (10) \quad \mu \frac{d^2 y}{dt^2} = \epsilon Y \quad \mu \frac{d^2 z}{dt^2} = \epsilon Z$$

According to the assumptions above and the principle of relativity, it is clear that right after that period (for a really small value t), the electron movement (in k-system) following the equation below:

$$\mu \frac{d^2 \xi}{d\tau^2} = \epsilon X, \quad \mu \frac{d^2 \eta}{d\tau^2} = \epsilon Y, \quad \mu \frac{d^2 \zeta}{d\tau^2} = \epsilon Z \quad (11)$$

According to these equations, we transfer the aforementioned motion from k-system into the K-series, you get:

$$\frac{d^2 x}{dt^2} = \frac{\epsilon}{\mu \beta^3} X \quad (12) \quad \frac{d^2 y}{dt^2} = \frac{\epsilon}{\mu \beta} \left(Y - v/c N \right) \frac{d^2 z}{dt^2} = \frac{\epsilon}{\mu \beta} \left(Z + v/c M \right)$$

Unresolved Issues: In equations $\mu \frac{d^2 y}{dt^2} = \epsilon Y$ and $\mu \frac{d^2 z}{dt^2} = \epsilon Z$, If $Y = 0, Z = 0$ then

$\frac{d^2 y}{dt^2} = 0, \frac{d^2 z}{dt^2} = 0$, both of them turn out to be $0 = 0$, there is no practical research

value; If $Y \neq 0$, or $Z \neq 0$, then $\frac{d^2 y}{d t^2} \neq 0$, or $\frac{d^2 z}{d t^2} \neq 0$. Then the electron will not move

at along the x-axis in K-system at a constant velocity v , at this time, all Einstein's assumptions and derivation will become nonsense.

Substituted the inverse transform of corresponding transformation equations of § 3 and § 6 into the first formula of (10), we obtained $\mu \frac{d^2[\beta(v\tau + \xi)]}{d\left[\beta\left(\tau + \frac{v}{c^2}\xi\right)\right]^2} = \epsilon X$, What is “

$\frac{d^2[\beta(v\tau + \xi)]}{d\left[\beta\left(\tau + \frac{v}{c^2}\xi\right)\right]^2}$ ” in this formula? Has anyone seen it? How solve it?

According to Einstein, it's an assumption base on the principle of relativity, not a deduced one; Substituted the corresponding transformation equations of § 3 and § 6 into the first formula of (11), we obtained $\mu \frac{d^2[\beta(x - vt)]}{d\left[\beta\left(t - \frac{v}{c^2}x\right)\right]^2} = \epsilon X$, what is

“ $\mu \frac{d^2[\beta(x - vt)]}{d\left[\beta\left(t - \frac{v}{c^2}x\right)\right]^2}$ ” ? Has anyone seen it? How solve it? Could

$\mu \frac{d^2[\beta(x - vt)]}{d\left[\beta\left(t - \frac{v}{c^2}x\right)\right]^2} = \epsilon X$ be transformed into $\frac{d^2 x}{d t^2} = \frac{\epsilon}{\mu} \frac{1}{\beta^3} X$? If we can, then there is

$$\frac{d^2[\beta(x - vt)]}{d\left[\beta\left(t - \frac{v}{c^2}x\right)\right]^2} = \frac{\epsilon X}{u} = \beta^3 \frac{dx^2}{dt^2} \quad \text{namely} \quad \frac{d^2[\beta(x - vt)]}{d\left[\beta\left(t - \frac{v}{c^2}x\right)\right]^2} = \beta^3 \frac{dx^2}{dt^2}$$

What is it? A monster?

I really appreciate Dr. Ma Qingping's queries against Einstein, changed from the K-system to the k-system, then back to the k, each value should be the same, and the equation should be the same, too. But according to Einstein, it changes from

$$\frac{d^2 x}{d t^2} = \epsilon X \quad (10) \quad \text{to} \quad \frac{d^2 x}{d t^2} = \frac{\epsilon}{\mu} \frac{1}{\beta^3} X \quad (12) \quad \text{from} \quad \epsilon X \quad \text{to} \quad \frac{1}{\mu \beta^3} \epsilon X.$$

If we change on our will like Einstein, like a magician, any theory can be proven. This shows that, Einstein is certainly wrong.

3 Conclusion

Einstein's theory of relativity is a mistake from the start to the end, wrong assumptions, wrong derivation, wrong conclusions, Einstein's theory of relativity is a paper tiger actually, can be punctured easily. It is said that only two-and-a-half man can understand the theory of relativity back to his time, in fact, it's not surprising, because a wise man cannot understand fallacy. It now appears that the two-and-a-half men were certainly pretend. Einstein's theory of relativity has no scientific value, and it is messing up people's thinking, hindering the development of science, like scholars say, the theory of relativity is a bunch of garbage, should be early eradicated

References

[1]. Einstein, On the Electrodynamics of Moving Bodies, Einstein's Collected Works, Commercial Press, Volume 2, 83 (1977).

[2]. Hua De, Einstein Is Wrong, Mechanics with Variable Speed of Light (Electronic Books).

[3]. Ma Qingping, Self-Consistency about the Theory of Relativity, Shanghai Science and Technology Press, 2004.

About the Author: A male senior instructor, who was born in February 1963, has been studying the theory of relativity since 1980, and find out some problems of the experimental basis and mathematical logic of the theory of relativity, More than 10 papers are published in

USA Matter Regularity. Are: 《The Formula $\Delta m = \frac{c\Delta t - c\Delta t'}{\lambda}$ is Untenable to Michelson's

Experiment: Restore the Hypothesis “Ether” to Explain the Two Different Types of Dual Property of Wave and Particle from Different Sources, Restore the Hypothesis “Ether” to Establish a Model of the Magnetic Field, Query Einstein's Explanation of the Two Experimental Results, Query for Einstein's Original Work “on the Electrodynamics of Moving Body”, Etc. Two papers, The Key Formula Used in the Michelson-Morley Experiment is Untenable and Query on Einstein's Explanation of Two Experimental Results has been finalized by USA Galilean Electrodynamics, forthcoming. I won the Meng Qingtan's Challenge Prize of Relativity by Beijing Relativity Theory Research Federation, Hoff Lu Research Institute of Matter Regularity, Editorial Committee of Matter Regularity in December in 2008; I won the Zheng Quan's Excellent Paper Award by Beijing Relativity Theory Research Federation, Hoff Lu Research Institute of Matter Regularity, Editorial Committee of Matter Regularity in December in 2012.

The Theory of Relativity and Cosmology on the Finsler Space-time

CAO SHENGLIN

Department of Astronomy, Beijing Normal University, Beijing, 100875, P.R.China. Email caosl20@163.com

Abstract: Einstein's theory of special relativity and the principle of causality imply that the speed of any moving object cannot exceed that of light in a vacuum (c). Nevertheless, there exist various proposals for observing faster-than- c propagation of light pulses, using anomalous dispersion near an absorption line, nonlinear and linear gain lines, or tunneling barriers. However, in all previous experimental demonstrations, the light pulses experienced either very large absorption or severe reshaping, resulting in controversies over the interpretation. Recently, L.J. Wang, A. Kuzmich and A. Dogariu use gain-assisted linear anomalous dispersion to demonstrate superluminal light propagation in atomic caesium gas. The group velocity of a laser pulse in this region exceeds c and can even become negative, while the shape of the pulse is preserved. The textbooks say nothing can travel faster than light, not even light itself. New experiments show that this is no longer true, raising questions about the maximum speed at which we can send information. On the other hand, the light speed reduction to 17 meters per second in an ultra cold atomic gas.

This paper shows that if ones think of the possibility of the existence of the superluminal-speeds (the speeds faster than that of light) and re-describe the special theory of relativity following Einstein's way, it could be supposed that the physical space-time is a Finsler space-time, characterized by the metric

$$ds^4 = g_{ijkl} dx^i dx^j dx^k dx^l.$$

If so, a new space-time transformation could be found by invariant ds^4 and the theory of relativity is discussed on this transformation. It is possible that the Finsler space-time $F(x,y)$ may be endowed with a catastrophic nature. Based on the different properties between the ds^2 and ds^4 , it is discussed that the flat space-time will also have the catastrophe nature on the Finsler metric ds^4 . The space-time transformations and the physical quantities will suddenly change at the catastrophe set of the space-time, the light cone. It will be supposed that only the dual velocities of the superluminal-speeds could be observed. If so, a particle with the superluminal-speeds $v > c$ could be regarded as its anti-particle with the dual velocity $v_1 = c^2/v < c$. On the other hand, it could be assumed that the horizon of the field of the general relativity is also a catastrophic set. If so, a particle with the superluminal-speeds could be projected near the horizon of these fields, and the particle will move on the space-like curves. It is very interesting that, in the Schwarzschild fields, the theoretical calculation for the space-like curves should be in agreement with the data of the superluminal expansion of

extragalactic radio sources observed year after year. (see Cao,1992b)

The catastrophe of space-time has some deep cosmological means. According to the some interested subjects in the process of evolution of the universe the catastrophe nature of the Finsler space-time and its cosmological implications are discussed. It is shown that the nature of the universal evolution could be attributed to the geometric features of the Finsler space-time. (see Cao,1993)

Key words: Theory of Relativity, Cosmology, Finsler space-time

Introduction

It is known that in his first paper on the special theory of relativity: “On the Electrodynamics of Moving Bodies”, Einstein clearly states (cf. Einstein, 1923) that ‘Velocities greater than that of light have ..., no possibility of existence.’ But he neglected to point out the applicable range of Lorentz transformation. In fact, his whole description must be based on velocities smaller than that of light which we call subluminal-speed. So, the special theory of relativity cannot negate that real motion at a speed greater than the speed of light in vacuum which we call superluminal-speed could exist. In this paper, it is shown that if we think of the possibility of existence of the superluminal-speed and re-describe the special theory of relativity following Einstein's way, a new theory would be founded on the Finsler space-time. The new theory would retain all meaning of the special theory of relativity when matters move with subluminal-speed and would give new content when matters move with superluminal-speed. If we assume that the superluminal-speed will accord with the space-like curves in the general theory of relativity, calculations indicate that the superluminal expansion of extragalactic radio sources exactly corresponds with the space-like curves of the Schwarzschild geometry.

Our discussion is still based on the principle of relativity and on the principle of constancy of the velocity of light which have been defined by Einstein as follows:

1.The laws by which the states of physical systems undergo change are not affected, whether these changes of state be referred to the one or the other of two systems of coordinates in uniform translatory motion (see Einstein, 1923;p.41).

2.Any ray of light moves in the ‘stationary’ system of coordinates with the determined velocity c , whether the ray be emitted by stationary or by a moving body.

Note that these two postulates do not impose any constraint on the relative speed v of the two inertial observers.

1 The General Theory of the Transformation of Space-time

1-1 Definition of Simultaneity and Temporal Order

In his description about definition of simultaneity, Einstein stated: “Let us take a system of coordinates in which the equations of Newtonian mechanics hold good”...“Let a ray of light start at the ‘A time’ t_A from A towards B, let it at the B time’ t_B be reflected at B in the

direction of A, and arrive again at A at the ‘A time’ t_A ’”. In accordance with definition, the two clocks synchronize if (see Einstein, 1923; p.40)

$$t_B - t_A = t'_A - t_B. \quad (1.1)$$

“In agreement with experience we further assume the quantity

$$\frac{2AB}{t_B - t_A} = c, \quad (1.2)$$

to be a universal constant -- the velocity of light in empty space”.

“It is essential to have time defined by means of stationary clocks in the stationary system, and the time now defined being appropriate to the stationary system we call it ‘the time of the stationary system’”. In this way, Einstein finished his definition of simultaneity. But he did not consider the applicable condition of this definition, still less the temporal order and as it appears to me these discussions are essential too. Let us continue these discussions following Einstein's way.

First and foremost, let us assume if the point B is moving with velocity v relative to the point A, in agreement with experience we must use the following equations instead of Equation (1.2):

$$\frac{2AB}{t_A - t_B} = \begin{cases} c - v, & \text{when } B \text{ is leaving } A \quad (a) \\ c + v, & \text{when } B \text{ is approaching } A \quad (b) \end{cases} \quad (1.3)$$

Obviously, Equation (1.3a) is not always applicable, it must require $v < c$, but Equation (1.3b) is always applicable-i.e., for $v < c$ and $v > c$ Einstein's whole discussion is based on the following formula:

$$t_B - t_A = \frac{r_{AB}}{c - v} \quad \text{and} \quad t'_A - t_B = \frac{r_{AB}}{c + v}. \quad (1.4)$$

It must require $v < c$, because $t_B - t_A$ must be larger than zero. Particularly, in order to get the Lorentz transformation, Einstein was based on the following formula (see Einstein, 1923; p.44)

$$\frac{1}{2} [\tau(0,0,0,t) + \tau(0,0,0,t + \frac{x'}{c-v} + \frac{x'}{c+v})] = \tau(x',0,0,t + \frac{x'}{c-v}) \quad (1.5)$$

where $\frac{x'}{c-v}$ is just $t_B - t_A$, so must require $v < c$, i.e., B must be the motion with the subluminal-speed. Then the Lorentz transformation only could be applied to the motion with subluminal-speed. It could not presage anything about the motion with the superluminal-speed, i.e., the special theory of relativity could not negate that the superluminal-speed would exist.

In order for our discussion to be applied to the motion with the superluminal-speed, we will only use Equation (1.3b), i.e., let the point B approach A. Now, let another ray of light (it

must be distinguished from the first) start at the 'A time' t_{A1} from A towards B (when B will be at a new place B_1) let it at the 'B time' t_{B1} be reflected at B in the direction of A, and arrive again at A at the 'A time' t_{A1} .

According to the principle of relativity and the principle of the constancy of the velocity of light, we obtain the following formulas:

$$\frac{1}{2}(t'_{A1} - t_A) = t_B - t_A = \frac{AB}{c + v}, \quad (1.6)$$

$$\frac{1}{2}(t'_{A1} - t_{A1}) = t_{A1} - t_{B1} = \frac{AB_1}{c + v}, \quad (1.7)$$

$$AB - AB_1 = v(t_{A1} - t_A). \quad (1.8)$$

Let

$$\Delta t_A = t_{A1} - t_A, \Delta t_B = t_{B1} - t_B \quad \text{and} \quad \Delta t'_A = t'_{A1} - t'_A, \quad (1.9)$$

where $\Delta t_A, \Delta t_B$, and $\Delta t'_A$ represent the temporal intervals of the emission from A, the reflection from B, and arrival at A for two rays of light, respectively. The symbols of the temporal intervals describe the temporal orders. When $\Delta t > 0$ it will be called the forward order and when $\Delta t < 0$, the backward order.

From Equations (1.6) ~ (1.9) we can get

$$\Delta t_B = \frac{c}{c + v} \Delta t_A, \quad (1.10)$$

and

$$\Delta t'_A = \frac{c - v}{c + v} \Delta t_A. \quad (1.11)$$

Then we assume that, if $\Delta t_A > 0$ i.e., two rays of light were emitted from A, successively we must have $\Delta t_B > 0$ i.e., for the observer at system A these two rays of light were reflected by the forward order from B. But

$$\Delta t'_A \geq 0, \text{ if and only if } v \leq c;$$

and

$$\Delta t'_A < 0, \text{ if and only if } v > c.$$

It means that for the observer at system A these two rays of light arrived at A by the forward order only when the point B moves with subluminal-speed, and by the backward order only when with superluminal-speed. In other words, the temporal order is not always constant. It is constant only when $v < c$, and it is not constant when $v > c$.

Usually, one thinks that this is a backward flow of time. In fact, it is only a procedure of time in the system B with the superluminal-speed which gives the observer in the ‘stationary system’ A an inverse appearance of the procedure of the time. It is an inevitable outcome when the velocity of the moving body is faster than the transmission velocity of the signal. This outcome will be called the relativity of the temporal order. It is a new nature of the time when the moving body attains the supeluminal-speed. It is known that it is not space-time that impresses its form on things, but the things and their physical laws that determine space-time. So, the superluminal-speed need not be negated by the character of the space-time of the special theory of relativity, but will represent the new nature of the space-time, the relativity of the temporal order.

1-2 The Temporal Order and the Chain of Causation

In order to explain the disparity between the backward flow of time and the relativity of the temporal order, we will use space-time figure (as Figure 1-1) and take following definition:

1. The chain of the event, $t_{A0}, t_{A1}, \dots, t_{Ai}, \dots$. The i th ray of light will be started at t_{Ai} and $\Delta t_{Ai} = t_{A(i+1)} - t_{Ai} > 0$ It may or may not be chain of causality.

2. The chains of the transference of the light $t_{A0}, t_{B0}, t'_{A0}; t_{A1}, t_{B1}, t'_{A1}; \dots$. Every chain t_{Ai}, t_{Bi}, t'_{Ai} must be a chain of causality -i.e.

$$\frac{1}{2}(t'_{Ai} - t_{Ai}) = t_{Bi} - t_{Ai} = t'_{Ai} - t_{Bi} > 0. \quad (1.12)$$

If they take a negative sign it will be the backward flow of time and will violate the principle of causality.

3. The chains of the motion are the rays of the light, which will be reflected at B, but it will have different features when B moves with different velocity. Let us assume that:

- (a) $v > 0$ when B is approaching A;
- (b) $v < 0$ when B is leaving A;
- (c) $c > 0$ when the ray of light from A backwards B;
- (d) $c < 0$ when the ray of light from A towards B.

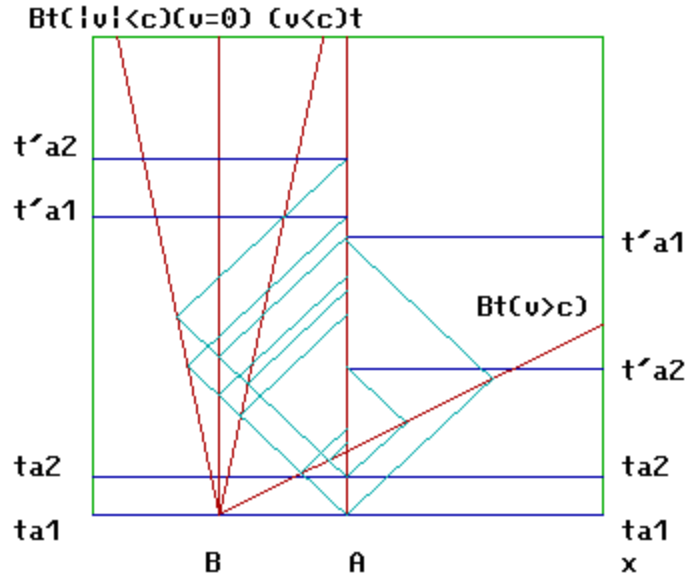

Figure 1-1 The space-time figure

So, if $v=0$, must have $c<0$ then

$$t_{A(i+1)} - t_{Ai} = t_{B(i+1)} - t_{Bi} = t'_{A(i+1)} - t'_{Ai}. \quad (1.13)$$

If $v<c$, must have $c<0$; and when $v>0$,

$$t_{A(i+1)} - t_{Ai} > t_{B(i+1)} - t_{Bi} > t'_{A(i+1)} - t'_{Ai} > 0. \quad (1.14)$$

But when $v<0$,

$$0 < t_{A(i+1)} - t_{Ai} < t_{B(i+1)} - t_{Bi} < t'_{A(i+1)} - t'_{Ai}. \quad (1.15)$$

Last of all, if $v>c$, must have $v>0$; and when $c<0$,

$$t_{A(i+1)} - t_{Ai} > t_{B(i+1)} - t_{Bi} > |t'_{A(i+1)} - t'_{Ai}| > 0. \quad (1.16)$$

but

$$t'_{A(i+1)} - t'_{Ai} < 0. \quad (1.17)$$

When $c>0$

$$0 < t_{A(i+1)} - t_{Ai} < |t_{B(i+1)} - t_{Bi}| < |t'_{A(i+1)} - t'_{Ai}| \quad (1.18)$$

and

$$t_{B(i+1)} - t_{Bi} < 0 \quad \text{and} \quad t'_{A(i+1)} - t'_{Ai} < 0. \quad (1.19)$$

These are rigid relations of causality.

4. The chains of the observation $t'_{A0}, t'_{A1}, \dots, t'_{Ai}, \dots$ and $t_{B0}, t_{B1}, \dots, t_{Bi}, \dots$ are not chains of causality. The relativity of temporal order is just that they could be a positive when $v<c$ or a negative when $v>c$ and the vector v and c have the same direction.

In (1.4) when $v > c$, $t_B - t_A < 0$ it does not mean that velocities greater than that of light have no possibility of existence but only that the ray of light cannot catch up with the body with superluminal-speed.

1-3. Theory of the Transformation of Coordinates

From equations (1.10) and (1.11) we can get

$$\Delta t_B = \frac{c}{c+v} \Delta t_A \quad (1.20)$$

and

$$\Delta t_B = \frac{c}{c-v} \Delta t'_A. \quad (1.21)$$

It has been pointed out that Δt_A and $\Delta t'_A$ are measurable by observer of the system A, but Δt_B is immeasurable. Accordingly, the observer must conjecture Δt_B from Δt_A or $\Delta t'_A$. In form, Δt_B in Equation (1.20) and Δt_B in (1.21) are different. If we can find a transformation of coordinates it will satisfy following equation:

$$\Delta \tau^2 = \Delta t_A \cdot \Delta t'_A \quad (1.22)$$

and, according to Equations (1.10) and (1.11), could get

$$\Delta \tau^2 = \begin{cases} > 0, & \text{iff } v < c, \\ = 0, & \text{iff } v = c, \\ < 0, & \text{iff } v > c. \end{cases} \quad (1.23)$$

Then, we get

$$\Delta t_B^2 = \frac{c^2}{c^2 - v^2} \Delta \tau^2$$

or

$$dt^2 = \frac{c^2}{c^2 - v^2} d\tau^2. \quad (1.24)$$

Let $ds^2 = c^2 d\tau^2$; we get

$$ds^2 = c^2 d\tau^2 = (c^2 - v^2) dt^2, \quad (1.25)$$

So

$$ds^2 = \begin{cases} > 0, & v < c & \text{timelike,} \\ = 0, & v = c & \text{lightlike,} \\ < 0, & v > c & \text{spacelike.} \end{cases} \quad (1.26)$$

what merits special attention is that $ds^2=(c^2 - v^2)dt^2$ and $ds^2=c^2dt^2 - dx^2 - dy^2 - dz^2$ are not identical. Usually, the special theory of relativity does not recognize their difference because motion with subluminal-speed does not involve the relative change of temporal orders, so the symbol of ds^2 remains unchanged when the inertial system changes.

Now let

$$ds^2 = ds_v^2 + ds_0^2 \quad (1.27)$$

where

$$ds_v^2 = (c^2 - v^2)dt^2, \quad (1.28)$$

$$ds_0^2 = dx^2 + dy^2 + dz^2 \quad (1.29)$$

then

$$ds^2 = \begin{cases} + ds_v^2 + ds_0^2, & v < c, \\ - ds_v^2 + ds_0^2, & v > c. \end{cases} \quad (1.30)$$

Between any two inertial systems

$$ds_v^2 + ds_0^2 = \begin{cases} + ds_v^2 + ds_0^2, & v < c, \\ - ds_v^2 + ds_0^2, & v > c. \end{cases} \quad (1.31)$$

According to classical mechanics, we can determine the state of a system with n degrees of freedom at time t by measuring the $2n$ position and momentum coordinates $q^i(t)$, $p_i(t)$, $i=1,2,\dots,n$. These quantities are commutative each other, i.e., $q^i(t)p_j(t)=p_j(t)q^i(t)$. But, in quantum mechanics the situation is entirely different. The operators Q_{op} and P_{op} corresponding to the classical observable position vector q and momentum vector p . These operators are non-commutative each other, i.e.,

$$QP \neq PQ.$$

So, ones doubt whether the quantum mechanics is not a good theory at first. But, ones discover that the non-commutability of operators is closely related to the uncertainty principle, it is just an essential distinction between the classical and quantum mechanics.

So, I doubt that whether the non-positive definite metrics ds^2 is just the best essential nature in the relativity theory? But, it was cast aside in Einstein's theory. Now, we could assume that

$$ds^4 = ds_v^4 + ds_0^4. \quad (1.32)$$

In general, we could let

$$ds^4 = g_{ijkl} dx^i dx^j dx^k dx^l, \quad i, j, k, l = 0,1,2,3. \quad (1.33)$$

Equations (1.32) and (1.33) which are defined as a Finsler metric are the base of the space-time transformations. From the physical point of view this means that a new symmetry

between the time-like and the space-like could exist.

In his memoir of 1854, Riemann discusses various possibilities by means of which an n-dimensional manifold may be endowed with a metric, and pays particular attention to a metric defined by the positive square root of positive definite quadratic differential form. Thus the foundations of Riemannian geometry are laid; nevertheless, it is also suggested that the positive fourth root of a fourth-order differential form might serve as metric function (see Rund, 1959; Introduction X).

In his book of 1977, Wolfgang Rindler stated: "Whenever the squared differential distance $d\sigma^2$ is given by a homogeneous quadratic differential form in the surface coordinates, as in (7.10), we say that $d\sigma^2$ is a Riemannian metric, and that the corresponding surface is Riemannian. It is, of course, not a foregone conclusion that all metrics must be of this form: One could define, for example, a non-Riemannian metric $d\sigma^2 = \sqrt{dx^4 + dy^4}$ for some two-dimensional space, and investigate the resulting geometry. (Such more general metrics give rise to 'Finsler' geometry.)" (see W. Rindler, 1997).

2 The Special Theory of Relativity on the Finsler Space-times ds^4

2-1 Space-time Transformation Group on the Finsler Metric ds^4

If $v=v_x$, then, between any two inertial systems we have

$$c^4 dt^4 + dx^4 - 2c^2 dt^2 dx^2 + dy^4 + dz^4 + 2dy^2 dz^2 = c^4 dt'^4 + dx'^4 - 2c^2 dt'^2 + dy'^4 + dz'^4 + 2dy'^2 dz'^2 \quad (2.1)$$

From (2.1) we could get transformations

$$t = \frac{t' + \frac{v}{c^2} x'}{\sqrt[4]{1 - 2\beta^2 + \beta^4}}, \quad x = \frac{x' + vt'}{\sqrt[4]{1 - 2\beta^2 + \beta^4}}, \quad y = y', \quad z = z'. \quad (2.2)$$

These transformations are called space-time transformations. All space-time transformations form into a group, called the space-time transformation group (The Lorentz transformations group is only subgroup of the space-time transformation group). The inverse transformations are of the form

$$\pm t' = \frac{t - \beta \frac{x}{c}}{\sqrt[4]{1 - 2\beta^2 + \beta^4}}, \quad \pm x' = \frac{x - vt}{\sqrt[4]{1 - 2\beta^2 + \beta^4}}, \quad y' = y, \quad z' = z. \quad (2.3)$$

where $\beta = \frac{v}{c}$. We could also use dual velocity $v_1 = \frac{c^2}{v}$ to represent the space-time transformations. In fact, the transformations (2.2) can be rewritten as

$$t = \frac{\beta_1 t' + \frac{x'}{c}}{\sqrt[4]{1 - 2\beta_1^2 + \beta_1^4}}, \quad x = \frac{\beta_1 x' + ct'}{\sqrt[4]{1 - 2\beta_1^2 + \beta_1^4}}, \quad y = y', \quad z = z'. \quad (2.4)$$

Their inverse transformations are of the form

$$\pm t' = \frac{\beta_1 t - \frac{x}{c}}{\sqrt[4]{1 - 2\beta_1^2 + \beta_1^4}}, \quad \pm x' = \frac{\beta_1 x - ct}{\sqrt{1 - 2\beta_1^2 + \beta_1^4}}, \quad y' = y, \quad z' = z. \quad (2.5)$$

where $\beta_1 = \frac{v_1}{c} = \frac{c}{v} = \frac{1}{\beta}$.

It is very interesting that all space-time transformations are applicable to both the subluminal-speed (i.e., $\beta < 1$ or $\beta_1 > 1$) and the superluminal-speed (i.e., $\beta > 1$ or $\beta_1 < 1$). Whether the velocity is superluminal- or subluminal-speed, it is characterized by minus or plus sign of their inverse transformations, respectively.

Lastly, all space-time transformations have the same singularity as the Lorentz transformation when the $\beta = \beta_1 = 1$.

2-2. Kinematics on the ds^4 Invariant

We shall now consider the question of the measurement of length and time increment. In order to find out the length of a moving body, we must simultaneously plot the coordinates of its ends in a fixed system. From Equation (2.2) and (2.4), an expression for the length of a moving scale $\Delta x'$ measured by a fixed observer follows as

$$\pm \Delta x' = \Delta x \sqrt[4]{1 - 2\beta^2 + \beta^4}, \quad (2.6)$$

and

$$\pm \Delta x' = c \Delta t \sqrt[4]{1 - 2\beta_1^2 + \beta_1^4}, \quad (2.7)$$

Einstein stated: "For $v=c$ all moving objects - viewed from the 'stationary' system - shrivel up into plain figures. For velocities greater than that of light our deliberations become meaningless". However, formula (2.6) can applied to the case for velocities greater than that of light. Figure 2.1 give the relation between the length of a moving scale L and the velocity.

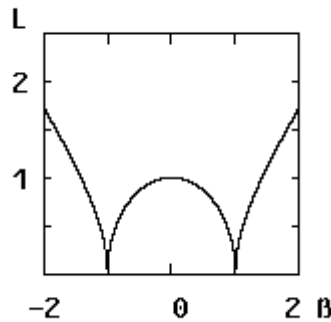

Figure 2.1. L - β curve

Let Δt be the time increment when the clock is at rest with respect to the stationary system, and $\Delta \tau$ be the time increment when the clock is at rest with respect to the moving system. Then

$$\pm \Delta \tau = \Delta t \sqrt[4]{1 - 2\beta^2 + \beta^4}, \quad (2.8)$$

and

$$\pm \Delta \tau = \frac{\Delta x}{c} \sqrt[4]{1 - 2\beta_1^2 + \beta_1^4}, \quad (2.9)$$

Differentiating (2.3) or (2.5) and dividing dx' by dt' we obtain

$$\frac{dx'}{dt'} = v'_x = \frac{\frac{dx}{dt} - v}{1 - v/c^2 \frac{dx}{dt}} = \frac{v_x - v}{1 - vv_x/c^2}, \quad (2.10)$$

Noting that $dy'=dy$, $dz'=dz$, we have a transformation of the velocity components perpendicular to v :

$$\frac{dy'}{dt'} = v'_y = \frac{v_y \sqrt[4]{1 - 2\beta^2 + \beta^4}}{1 - vv_x/c^2}, \quad \frac{dz'}{dt'} = v'_z = \frac{v_z \sqrt[4]{1 - 2\beta^2 + \beta^4}}{1 - vv_x/c^2}, \quad (2.11)$$

where

$$v^2 = v_x^2 + v_y^2 + v_z^2. \quad (2.12)$$

From Equation (2.8), we could see that the composition of velocities have four physical implications: i.e.,

1. A subluminal-speed and another subluminal-speed will be a subluminal-speed.
2. A superluminal-speed and a subluminal-speed will be a superluminal-speed.
3. The composition of two superluminal-speeds is a subluminal-speed.
4. The composition of light-speed with any other speed (subluminal-, light-, or superluminal-speed) still is the light-speed.

There are the essential natures of the space-time transformation group. The usual Lorentz transformation is only a subgroup of the space-time transformation group.

It is necessary to point out that if $1 - vv_x/c^2 = 0$, i.e.,

$$v_x = v/c^2, \quad (2.13)$$

then $v_x \rightarrow \infty$. It implies that if two velocities are dual to each other and in opposite directions, then their composition velocity is an infinitely great velocity. We guess that it may well become an effective way to make an appraisal of a particle with the superluminal-speed.

2-3. Dynamics on the ds^4 Invariant

The Lagrangian for a free particle with mass m is

$$L = -mc^2 \sqrt[4]{1 - 2\beta^2 + \beta^4}, \quad (2.14)$$

The momentum energy, and mass of motion of the particle are of the forms:

$$p = \frac{mv}{\sqrt[4]{1-2\beta^2+\beta^4}}, E = \frac{mc^2}{\sqrt[4]{1-2\beta^2+\beta^4}}, M = \frac{m}{\sqrt[4]{1-2\beta^2+\beta^4}}. \quad (2.15)$$

Those could also be represented by dual velocity v_1 :

$$p(v) = \frac{mv}{\sqrt[4]{1-2\beta^2+\beta^4}} = \frac{mc}{\sqrt[4]{1-2\beta_1^2+\beta_1^4}} = \frac{1}{c}E(v_1), \quad (2.16)$$

$$E(v) = \frac{mc^2}{\sqrt[4]{1-2\beta^2+\beta^4}} = \frac{mv_1c}{\sqrt[4]{1-2\beta_1^2+\beta_1^4}} = cp(v_1), \quad (2.17)$$

$$M(v) = \frac{m}{\sqrt[4]{1-2\beta^2+\beta^4}} = \frac{\beta_1 m}{\sqrt[4]{1-2\beta_1^2+\beta_1^4}} = \beta_1 M(v_1); \quad (2.18)$$

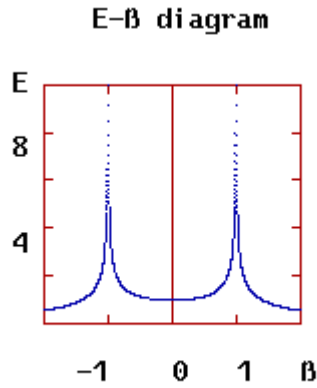

Figure 2.2. E-β diagram

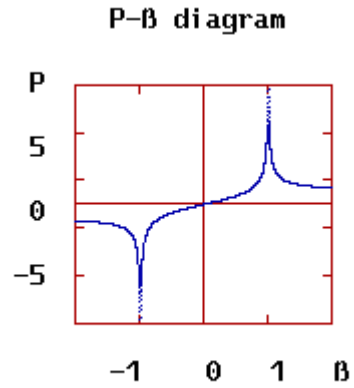

Figure 2.3. p-β diagram

Einstein stated: “Thus, when $v=c$, E becomes infinite, velocities greater than that of light have —as in our previous results—no possibility of existence”. But, formula (2.7) can also applied to the case for velocities greater than that of light. Figure 2.2 give the relation between the energy of a moving particle and its velocity, and Figure 2.3 give the relation between the momentum of a moving particle and its velocity.

It is very interesting that the momentum (or energy) in the v 's representation will change into the energy (or momentum) in the v_1 's representation. From (2.15) (or (2.16) and (2.17)), we could get the following relation between the momentum and energy of a free material particle:

$$p(v) = \frac{v}{c^2}E(v) \quad \text{or} \quad p(v_1) = \frac{v_1}{c^2}E(v_1), \quad (2.19)$$

where the relation (2.19) keeps up the same form as the special theory of relativity. But a new invariant will be obtained as

$$E^4 + c^4 p^4 - 2c^2 p^2 E^2 = m^4 c^8. \quad (2.20)$$

The relation (2.20) is correct for both of the v 's and the v_1 's representations. It is a new relation on the ds^4 invariant.

2.4. A Charged Particle in an Electromagnetic Field on the Finsler Space-timed s^4

Let us now turn to the equations of motion for a charged particle in an electromagnetic field, A, Φ, E_e and H_e . Their Lagrangian is

$$L = -mc^2 \sqrt[4]{1 - 2\beta^2 + \beta^4} + \frac{e}{c} Av - e\Phi. \quad (2.21)$$

The derivative $\partial L / \partial v$ is the generalized momentum of the particle; we denote it by P_e

$$p_e = mv \sqrt[4]{1 - 2\beta^2 + \beta^4} + \frac{e}{c} A = p + \frac{e}{c} A. \quad (2.22)$$

where P denotes momentum in the absence of a field.

From the Lagrangian we could find the Hamiltonian function for a particle in a field from the general formula

$$H = mc^2 \sqrt[4]{1 - 2\beta^2 + \beta^4} + e\Phi. \quad (2.23)$$

However, the Hamiltonian must be expressed not in terms of the velocity, but rather in terms of the generalized momentum of the particle. From equations (2.2) and (2.3), we can get the relation

$$\left[\left(\frac{H - e\Phi}{c} \right)^2 - \left(p - \frac{e}{c} A \right)^2 \right]^2 = m^4 c^4. \quad (2.24)$$

Now we write the Hamilton-Jacobi equation for a particle in an electromagnetic field in the Finsler space-time. It is obtained by replacing, in the equation for the Hamiltonian, P by $\partial S / \partial r$, and H by $-\partial S / \partial t$. Thus we get from (2.24)

$$\left[\left(\nabla S - \frac{e}{c} A \right)^2 - \frac{1}{c^2} \left(\frac{\partial S}{\partial t} + e\Phi \right)^2 \right]^2 - m^4 c^4 = 0. \quad (2.25)$$

Now we consider the equation of motion of a charge in an electromagnetic field. It could be written by Lagrangian (2.21) as

$$\frac{d}{dt} \frac{mv}{\sqrt[4]{1 - 2\beta^2 + \beta^4}} = eE_e + \frac{e}{c} v \times H_e. \quad (2.26)$$

where

$$E_e = -\frac{1}{c} \frac{\partial A}{\partial t} - \text{grad}\Phi, \quad H_e = \text{curl}A. \quad (2.27)$$

It is easy to check the $dE_e = v dP$ -i.e..

$$v \frac{d}{dt} \frac{mv}{\sqrt[4]{1-2\beta^2+\beta^4}} = mc^2 \frac{d}{dt} \frac{1}{\sqrt[4]{1-2\beta^2+\beta^4}}. \quad (2.28)$$

Then from (2.26) we have

$$\frac{dE}{dt} = eE_e v. \quad (2.29)$$

Integrate (2.29) and get

$$\frac{mc^2}{\sqrt[4]{1-2\beta^2+\beta^4}} - \frac{mc^2}{\sqrt[4]{1-2\beta_0^2+\beta_0^4}} = eU. \quad (2.30)$$

where

$$\beta_0 = \frac{v_0}{c}, \quad U = \int_{r_0}^r E_e dr. \quad (2.31)$$

From (2-26) and (2-29), if we write it in terms of components, it is easy to obtain the space-time transformation equations for the field components, and we could obtain the field transformation equation

$$\left\{ \begin{array}{ll} H'_x = H_x, & E'_x = E_x, \\ H'_y = \frac{H_y + \beta E_z}{\sqrt[4]{1-2\beta^2+\beta^4}}, & E'_y = \frac{E_y - \beta H_z}{\sqrt[4]{1-2\beta^2+\beta^4}}, \\ H'_z = \frac{H_z - \beta E_y}{\sqrt[4]{1-2\beta^2+\beta^4}}, & E'_z = \frac{E_z + \beta H_y}{\sqrt[4]{1-2\beta^2+\beta^4}}. \end{array} \right. \quad (2.32)$$

We could also use dual velocity v_1 to represent the field transformation equation

$$\left\{ \begin{array}{ll} H'_x = H_x, & E'_x = E_x, \\ H'_y = \frac{\beta_1 H_y + E_z}{\sqrt[4]{1-2\beta_1^2+\beta_1^4}}, & E'_y = \frac{\beta_1 E_y - H_z}{\sqrt[4]{1-2\beta_1^2+\beta_1^4}}, \\ H'_z = \frac{\beta_1 H_z - E_y}{\sqrt[4]{1-2\beta_1^2+\beta_1^4}}, & E'_z = \frac{\beta_1 E_z + H_y}{\sqrt[4]{1-2\beta_1^2+\beta_1^4}}. \end{array} \right. \quad (2.33)$$

An invariant will be obtained as

$$H_e^4 + E_e^4 - 2H_e^2 E_e^2 = \text{constant},$$

of new nature for the electromagnetic field in Finsler space-time.

3 The Catastrophe of the Space-time and Its Physical Meaning

3.1. Catastrophe of the Space-time on the Finsler Metric ds^4

The functions $y=x^2$ and $y=x^4$ are topologically equivalent in the theory of the singularities of differentiable maps (see Arnold et al.,1985). But the germ $y=x^2$ is topologically (and even differentially) stable at zero. the germ $y=x^4$ is differentially (and even topologically) unstable at zero. So, there is a great difference between the theories of relativity on the ds^2 and the ds^4 .

On the other hand, a great many of the most interesting macroscopic phenomena in nature involve discontinuities. The Newtonian theory and Einstein's relativity theory only consider smooth, continuous processes. The catastrophe theory, however, provides a universal method for the study of all jump transitions, discontinuities and sudden qualitative changes. The catastrophe theory is a program. The object of this program is to determine the change in the solutions to families of equations when the parameters that appear in these equations change.

In general, a small change in parameter values only has a small quantitative effect on the solutions of these equations. However, under certain conditions a small change in the value of some parameters has a very large quantitative effect on the solutions of these equations. Large quantitative changes in solutions describe qualitative changes in the behavior of the system modeled.

Catastrophe theory is, therefore, concerned with determining the parameter values at which there occur qualitative changes in solutions of families of equations described by parameters.

The double-cusp is the simplest non-simple in the sense of Arnold (see Arnold et al.,1985), but the double-cusp is unimodal.

The double-cusp is compact, in the sense that the sets $f \leq \text{constant}$ are compact. In Arnold's notation, the double-cusp belongs to the family X9 and in that family there are three real types of germ, according as to whether the germ has 0,2, or 4 real roots. For example representatives of the three types are: Type 1 x^4+y^4 , type $2x^4 - y^4$, type $3x^4+y^4 - 2\delta x^2y^2$, respectively, and only the type 1 is compact.

Compact germs play an important role in application (see Zeeman, 1977), because any perturbation of a compact germ has a minimum; therefore if minima represent the stable equilibria of some system, then for each point of the unfolding space there exists a stable state of the system.

3.2. Catastrophe of the space-time on the Finsler Metric ds^4

In accordance with the Finsler metric ds^4 of the space-time, we could

$$f(T, X, Y, Z) = T^4 + X^4 + Y^4 + Z^4 - 2T^2X^2 + 2Y^2Z^2, \quad (3.1)$$

here $T=ct$. Equation (3.1) that describes the behavior of the space-time is a smooth function.

As the catastrophe theory, first we must find the critical points of this function. Let $f=0$, and $f'=0$, here $f' = \partial f / \partial s$, $s=T,X,Y,Z$. i.e.,

$$\begin{aligned} f &= T^4 + X^4 + Y^4 + Z^4 - 2T^2X^2 + 2Y^2Z^2 = 0, \\ f'_T &= \partial f / \partial T = 4T(T^2 - X^2) = 0, \\ f'_X &= \partial f / \partial X = 4X(X^2 - T^2) = 0, \\ f'_Y &= \partial f / \partial Y = 4Y(Y^2 + Z^2) = 0, \\ f'_Z &= \partial f / \partial Z = 4Z(Z^2 + Y^2) = 0. \end{aligned}$$

So, the critical point are

$$X = \pm T, \quad T = X = Y = Z = 0.$$

Then, we form the stability matrix $(\partial^2 f / \partial x^i \partial x^j)$. It is of the form

$$H(T, X, Y, Z) = \begin{bmatrix} 12T^2 - 4x^2 & -8Tx & 0 & 0 \\ -8Tx & 12x^2 - 4T^2 & 0 & 0 \\ 0 & 0 & 12y^2 + 4z^2 & 8yz \\ 0 & 0 & 8yz & 12z^2 + 4y^2 \end{bmatrix}.$$

Obviously, for the sub matrix

$$H(Y, Z) = \begin{pmatrix} 12y^2 + 4z^2 & 8yz \\ 8yz & 12z^2 + 4y^2 \end{pmatrix}$$

its determinant does not vanish, unless $Y=Z=0$.

With the Thom theorem (splitting lemma), we could get

$$f_M(Y, Z) = Y^4 + Z^4 + 2Y^2Z^2, \quad (3.2)$$

$$f_{NM}(T, X) = T^4 + X^4 - 2T^2X^2; \quad (3.3)$$

where f_M Morse function, can be reduced to the Morse canonical form

$$M_0^2 = Y^2 + Z^2,$$

and f_{NM} , non-Morse function, is a degenerate form of the double-cusp catastrophe (see Zeeman, 1977). For another sub matrix of $H(T,X,Y,Z)$

$$H(T, X) = \begin{vmatrix} 12T^2 - 4X^2 & -8TX \\ -8XT & 12X^2 - 4T^2 \end{vmatrix} = -48(T^4 + X^4 - 2T^2X^2).$$

So, the space-time sub manifold $M(T,X)$ will be divided into four parts by the different values of the $H(T,X)$:

$$\begin{array}{lll}
H(T, X) \neq 0 & T^2 - X^2 < 0 & \text{spacelike state} \\
(\text{material states}) & T^2 - X^2 > 0 & \text{timelike state} \\
H(T, X) = 0 & T = \pm X & \text{lightlike state} \\
(\text{singularities}) & T = X = 0 & \text{the origin (in det er min ate)}.
\end{array} \quad (3.4)$$

It means that the light cone is just a catastrophe set on the space-time manifold, and both the time-like state and space-like state are possible states of moving particles.

So, from the point of view of the catastrophe theory, the light cone is just a set of degenerate critical points on the space-time manifold. The space-time is structurally unstable at the light cone. It means that a light like state could change suddenly into a time-like state and a space-like state. Also, a time-like state and a space-like state could change suddenly into a light like state. It very much resembles the fact that two photons with sufficient energy could change suddenly into a pair of a particle and an anti-particle and contrarily, a pair of a particle and an antiparticle could annihilate and change into two photons.

According to the nature of catastrophe of the space-time, the space-time transformations (2.2) could be resolved into two parts at the light cone:

$$t = \frac{t' + \frac{\beta}{c} x'}{\sqrt{1 - \beta^2}}, x = \frac{x' + vt'}{\sqrt{1 - \beta^2}}, y = y', z = z'; \quad \beta = \frac{v}{c} < 1. \quad (3.5)$$

and

$$t = \frac{t' + \frac{\beta}{c} x'}{\sqrt{\beta^2 - 1}}, x = \frac{x' + vt'}{\sqrt{\beta^2 - 1}}, y = y', z = z'; \quad \beta = \frac{v}{c} > 1. \quad (3.6)$$

In the same way, the transformation (2.4) could also be resolved into two parts at the light cone:

$$t = \frac{\beta_1 t' + \frac{1}{c} x'}{\sqrt{\beta_1^2 - 1}}, x = \frac{\beta_1 x' + ct'}{\sqrt{\beta_1^2 - 1}}, y = y', z = z'; \quad \beta_1 = \frac{v_1}{c} > 1. \quad (3.7)$$

and

$$t = \frac{\beta_1 t' + \frac{1}{c} x'}{\sqrt{1 - \beta_1^2}}, x = \frac{\beta_1 x' + ct'}{\sqrt{1 - \beta_1^2}}, y = y', z = z'; \quad \beta_1 = \frac{v_1}{c} < 1. \quad (3.8)$$

It is very interesting that transformations (3.5) and (3.7) have two major features: Firstly, they keep the same sign between the ds^2 and the ds'^2 ; i.e.:

$$ds_v^2 = ds'_v{}^2. \quad (3.9)$$

Secondly, their inverse transformations are of the form

$$t' = \frac{t - \frac{\beta}{c} x}{\sqrt{1 - \beta^2}}, x' = \frac{x - vt}{\sqrt{1 - \beta^2}}, y' = y, z' = z; \quad \beta < 1. \quad (3.10)$$

and

$$t' = \frac{\beta_1 t - \frac{1}{c}x}{\sqrt{\beta_1^2 - 1}}, x' = \frac{\beta_1 x - ct}{\sqrt{\beta_1^2 - 1}}, y' = y, z' = z; \quad \beta_1 > 1. \quad (3.11)$$

These transformations keep the same sign between x, t and x', t' . So, they will be called the time-like transformations and (3.5) will be called the time-like representation of the time-like transformation (TRTT), and (3-7) the space-like representation of time-like transformation (SRTT).

In the same manner, transformations (3.6) and (3.8) have two common major features, too. Firstly, they will change the sign between ds^2 and ds'^2 , i.e.:

$$-ds_v^2 = ds'_v{}^2. \quad (3.12)$$

Secondly, their inverse transformations are of the form

$$-t' = \frac{t - \frac{\beta}{c}x}{\sqrt{\beta^2 - 1}}, -x' = \frac{x - vt}{\sqrt{\beta^2 - 1}}, y' = y, z' = z; \quad \beta > 1. \quad (3.13)$$

and

$$-t' = \frac{\beta_1 t - \frac{1}{c}x}{\sqrt{1 - \beta_1^2}}, -x' = \frac{\beta_1 x - ct}{\sqrt{1 - \beta_1^2}}, y' = y, z' = z; \quad \beta_1 < 1. \quad (3.14)$$

These transformations will change the sign between x, t and x', t' . They will be called the space-like transformations and (3.6) will be called the space-like representation of space-like transformation (SRST); and (3.8) the time-like representation of space-like transformation (TRST).

Now, we have had four types of form of the space-time transformation under ds^2 :

Type I. TRTT, (3.5), it is just the Lorentz transformation;

Type II. SRTT, (3.7), it is the space-like representation of the Lorentz transformation with the dual velocity $v_1 = c^2/v$, it is larger than the velocity of light;

Type III. SRST, (3.6), it is just the superluminal Lorentz transformation (see Recami, 1986 and Sen Gupta, 1973);

Type IV. TRST, (3.8), it is the time-like representation of the superluminal Lorentz transformation with the dual velocity $v_1 = c^2/v$, but it is less than the velocity of light.

3.3. The Catastrophe of Physical Quantities on the Finsler Metric ds^4

Firstly, we shall consider the question of the catastrophe of the measurement of length and time increment. According to the nature of catastrophe of space-time, the expression for the length of a moving scale $\Delta x'$ measured by a fixed observer (2.6) ~ (2.9) could be resolved into two parts:

$$\Delta x' = \Delta x \sqrt{1 - \beta^2}, \quad \beta < 1. \quad (3.15)$$

$$-\Delta x' = \Delta x \sqrt{\beta^2 - 1}, \quad \beta > 1. \quad (3.16)$$

$$-\Delta x' = c \Delta t \sqrt{1 - \beta_1^2}, \quad \beta_1 < 1. \quad (3.17)$$

$$\Delta x' = c \Delta t \sqrt{\beta_1^2 - 1}, \quad \beta_1 > 1. \quad (3.18)$$

The expression for the time increment $\Delta \tau$ of the clock at rest with respect to the moving system could be resolved into two parts at the light cone:

$$\Delta \tau = \Delta t \sqrt{1 - \beta^2}, \quad \beta < 1; \quad (3.19)$$

$$-\Delta \tau = \Delta t \sqrt{\beta^2 - 1}, \quad \beta > 1. \quad (3.20)$$

$$-\Delta \tau = \frac{\Delta x}{c} \sqrt{1 - \beta_1^2}, \quad \beta_1 < 1; \quad (3.21)$$

$$\Delta \tau = \frac{\Delta x}{c} \sqrt{\beta_1^2 - 1}, \quad \beta_1 > 1; \quad (3.22)$$

It is very interesting that the $\Delta x'$ (or Δx) will exchange with Δt (or $\Delta \tau$) in the expressions (3.17),(3.18),(3.21), and (3.22).

If we let (see the formula (3.20))

$$f(E, P) = E^4 + c^4 P^4 - 2c^2 E^2 P^2 \quad (3.23)$$

as the catastrophe theory, we could find a catastrophe set

$$E = \pm P \quad (3.24)$$

and we could have four types of the representation for the momentum, the energy, and the mass of a moving particle with the rest mass m :

Type I. TRTT

$$P^T(v) = \frac{mv}{\sqrt{1 - \beta^2}}, E^T(v) = \frac{mc^2}{\sqrt{1 - \beta^2}}, M^T(v) = \frac{m}{\sqrt{1 - \beta^2}}; \quad \beta < 1. \quad (3.25)$$

Type II. SRTT

$$P^S\{v_1\} = \frac{mv_1}{\sqrt{\beta_1^2 - 1}}, E^S(v_1) = \frac{mc^2}{\sqrt{\beta_1^2 - 1}}, M^S(v_1) = \frac{m}{\sqrt{\beta_1^2 - 1}}; \quad \beta_1 > 1. \quad (3.26)$$

Type III. SRST

$$p^s \{v\} = \frac{-mv}{\sqrt{\beta^2 - 1}}, E^s(v) = \frac{-mc^2}{\sqrt{\beta^2 - 1}}, M^s(v) = \frac{-m}{\sqrt{\beta^2 - 1}}; \quad \beta > 1. \quad (3.27)$$

Type IV. TRST

$$p^s \{v_1\} = \frac{-mv_1}{\sqrt{1 - \beta_1^2}}, E^s(v_1) = \frac{-mc^2}{\sqrt{1 - \beta_1^2}}, M^s(v_1) = \frac{-m}{\sqrt{1 - \beta_1^2}}; \quad \beta_1 < 1. \quad (3.28)$$

The transformations between type I (or type II) and type III (or type IV) have the forms

$$p^T(v) = \frac{mv}{\sqrt{1 - \beta^2}} = \frac{mc}{\sqrt{\beta_1^2 - 1}} = \frac{1}{c} E^T(v_1). \quad (3.29)$$

$$E^T(v) = \frac{mc^2}{\sqrt{1 - \beta^2}} = \frac{mv_1 c}{\sqrt{\beta_1^2 - 1}} = cp^T(v_1). \quad (3.30)$$

$$M^T(v) = \frac{m}{\sqrt{1 - \beta^2}} = \frac{\beta_1 m}{\sqrt{\beta_1^2 - 1}} = \beta_1 M^T(v_1). \quad (3.31)$$

and

$$p^s(v) = \frac{-mv}{\sqrt{\beta^2 - 1}} = \frac{-mc}{\sqrt{1 - \beta_1^2}} = \frac{1}{c} E^s(v_1). \quad (3.32)$$

$$E^s(v) = \frac{-mc^2}{\sqrt{\beta^2 - 1}} = \frac{-mv_1 c}{\sqrt{1 - \beta_1^2}} = cp^s(v_1). \quad (3.33)$$

$$M^s(v) = \frac{-m}{\sqrt{\beta^2 - 1}} = \frac{-\beta_1 m}{\sqrt{1 - \beta_1^2}} = \beta_1 M^s(v_1). \quad (3.34)$$

With these forms above, we could get that when $\beta = \beta_1 = 1$,

$$cP(c) = E(c) = mc^2 \quad \text{and} \quad M(c) = m. \quad (3.35)$$

Note that although all through Einstein's relativistic physics there occur indications that mass and energy are equivalent according to the formula

$$E = mc^2.$$

But it is only an Einstein's hypothesis.

It is very interesting that from type I and type IV we could get

$$E^2 - c^2 p^2 = m^2 c^4, \quad v < c \quad \text{and} \quad v_1 < c \quad (\text{i.e., } v > c) \quad (3.36)$$

and from type II and type III

$$E^2 - c^2 p^2 = -m^2 c^4, \quad v > c \quad \text{and} \quad v_1 > c \quad (\text{i.e., } v < c) \quad (3.37)$$

Here, we have forgotten the indices for the types in Equations (3.35) to (3.37). If we let the

$H^2(E,P)=E^2 - c^2P^2$, then we could get

$$f(H, mc) = H^4 - (mc^2)^4.$$

It is a type II of the double-cusp catastrophe, we could also get (3.36) and (3.37) from it.

3.4. The Catastrophe a Charged Particle in an Electromagnetic Field on

The Finsler Space-time s^4

The Hamilton-Jacobi equation for a particle in an electromagnetic field in the Finsler space-time, formula (2.25) is a type II of the double-cusp catastrophe. We could get that

$$c^2 \left(\nabla S - \frac{e}{c} A \right)^2 - \left(\frac{\partial S}{\partial t} + c\Phi \right)^2 + m^2 c^4 = 0, \quad (3.39)$$

for type I and type IV of the space-time transformation.

$$c^2 \left(\nabla S - \frac{e}{c} A \right)^2 - \left(\frac{\partial S}{\partial t} + c\Phi \right)^2 - m^2 c^4 = 0, \quad (3.40)$$

for type II and type III of the space-time transformation.

Now, we consider the catastrophe change of the equation of a charge in an electromagnetic field. By equation (2.26), we could get

$$\frac{d}{dt} \frac{mv}{\sqrt{1-\beta^2}} = eE_e + \frac{e}{c} v \times H_e, \quad v < c \quad (3.41)$$

and

$$-\frac{d}{dt} \frac{mv}{\sqrt{\beta^2-1}} = eE_e + \frac{e}{c} v \times H_e, \quad v > c. \quad (3.42)$$

If we integrate (3.41) and (3.42), then

$$\frac{mc^2}{\sqrt{1-\beta^2}} - \frac{mc^2}{\sqrt{1-\beta_0^2}} = eU, \quad v_0 < c \quad (3.43)$$

and

$$\frac{mc^2}{\sqrt{\beta_0^2-1}} - \frac{mc^2}{\sqrt{\beta^2-1}} = eU, \quad v_0 > c. \quad (3.44)$$

So, the velocity v has

$$v = c \sqrt{1 - \left(\frac{eU}{mc} + 1/\sqrt{1-\beta_0^2} \right)^{-2}} < c, \quad \text{iff } v_0 < c, \quad (3.45)$$

and

$$v = c \sqrt{1 + \left(\frac{eU}{mc} - 1 / \sqrt{\beta_0^2 - 1} \right)^{-2}} > c, \quad \text{iff } v_0 > c. \quad (3.46)$$

The expressions (3.45) and (3.46) mean that if $v_0 < c$, then for the charged particle always $v < c$; and if $v_0 > c$, then $v > c$. The velocity of light will be a bilateral limit: I.e., it is both of the maximum for the subluminal-speeds and the minimum for the superluminal-speeds.

If we let

$$f(H_e, E_e) = H_e^4 + E_e^4 - 2H_e^2 E_e^2, \quad (3.47)$$

we will get that the catastrophe set is

$$H_e = \pm E_e \quad (3.48)$$

and we could obtain the space-time transformation equations for the electromagnetic field components: (by (2.31) and (2.32))

Type I. TRTT

$$\left\{ \begin{array}{ll} H'_x = H_x, & E'_x = E_x, \\ H'_y = \frac{H_y + \beta E_z}{\sqrt{1 - \beta^2}}, & E'_y = \frac{E_y - \beta H_z}{\sqrt{1 - \beta^2}}, \\ H'_z = \frac{H_z - \beta E_y}{\sqrt{1 - \beta^2}}, & E'_z = \frac{E_z + \beta H_y}{\sqrt{1 - \beta^2}}. \end{array} \right. \quad (3.49)$$

Type II. SRTT

$$\left\{ \begin{array}{ll} H'_x = H_x, & E'_x = E_x, \\ H'_y = \frac{\beta_1 H_y + E_z}{\sqrt{\beta_1^2 - 1}}, & E'_y = \frac{\beta_1 E_y - H_z}{\sqrt{\beta_1^2 - 1}}, \\ H'_z = \frac{\beta_1 H_z - E_y}{\sqrt{\beta_1^2 - 1}}, & E'_z = \frac{\beta_1 E_z + H_y}{\sqrt{\beta_1^2 - 1}}. \end{array} \right. \quad (3.50)$$

Type III. SRST

$$\left\{ \begin{array}{ll} H'_x = H_x, & E'_x = E_x, \\ -H'_y = \frac{H_y + \beta E_z}{\sqrt{\beta^2 - 1}}, & -E'_y = \frac{E_y - \beta H_z}{\sqrt{\beta^2 - 1}}, \\ -H'_z = \frac{H_z - \beta E_y}{\sqrt{\beta^2 - 1}}, & -E'_z = \frac{E_z + \beta H_y}{\sqrt{\beta^2 - 1}}. \end{array} \right. \quad (3.51)$$

Type IV. TRST

$$\left\{ \begin{array}{ll} H'_x = H_x, & E'_x = E_x, \\ -H'_y = \frac{\beta_1 H_y + E_z}{\sqrt{1 - \beta_1^2}}, & -E'_y = \frac{\beta_1 E_y - H_z}{\sqrt{1 - \beta_1^2}}, \\ -H'_z = \frac{\beta_1 H_z - E_y}{\sqrt{1 - \beta_1^2}}, & -E'_z = \frac{\beta_1 E_z + H_y}{\sqrt{1 - \beta_1^2}}. \end{array} \right. \quad (3.52)$$

3.5 The Interchange of the Forces Between the Attraction and the Rejection

Usually, because of the equivalence of energy and mass in the relativity theory, ones believe that an object has due to its motion will add to its mass. In other words, it will make it harder to increase its speed. This effect is only really significant for objects moving at speeds close to the speed of light. So, only light, or other waves that have no intrinsic mass, can move at the speed of light.

The mass is the measure of the gravitational and inertial properties of matter. Once thought to be conceivably different, gravitational mass and inertial mass have recently been shown to be the same to one part in 10^{11} .

Inertial mass is defined through Newton's second law, $F=ma$, in which m is mass of body. F is the force action upon it, and a is the acceleration of the body induced by the force. If two bodies are acted upon by the same force (as in the idealized case of connection with a massless spring), their instantaneous accelerations will be in inverse ratio to their masses.

Now, we need discuss the problem of defining mass m in terms of the force and acceleration. This, however, implies that force has already been independently defined, which is by no means the case.

3.5.1. Electromagnetic Mass and Electromagnetic Force

It is well known that the mass of the electron is about 2000 times smaller than that of the hydrogen atom. Hence the idea occurs that the electron has, perhaps, no “ordinary” mass at all, but is nothing other than an “atom of electricity”, and that its mass is entirely

electromagnetic in origin. Then, the theory found strong support in refined observations of cathode rays and of the β -rays of radioactive substances, which are also ejected electrons. If magnetic action on these rays allows us to determine the ratio of the charge to the mass, $\frac{e}{m_{el}}$,

and also their velocity v , and that at first a definite value for $\frac{e}{m_{el}}$ was obtained, which was

independent of v if $v \ll c$. But, on proceeding to higher velocities, a decrease of $\frac{e}{m_{el}}$ was

found. This effect was particularly clear and could be measured quantitatively in the case of the β -rays of radium, which are only slightly slower than light. The assumption that an electric charge should depend on the velocity is incompatible with the ideas of the electron theory. But, that the mass should depend on the velocity was certainly to be expected if the mass was to be electromagnetic in origin. To arrive at a quantitative theory, it is true, definite assumptions had to be made about the form of the electron and the distribution of the charge on it. M. Abraham (1903) regarded the electron as a rigid sphere, with a charge distributed on the one hand, uniformly over the interior, or, on the other, over the surface, and he showed that both assumptions lead to the same dependence of the electromagnetic mass on the velocity, namely, to an increase of mass with increasing velocity. The faster the electron travels, the more the electromagnetic field resists a further increase of velocity. The increase of m_{el} explains the observed decrease of $\frac{e}{m_{el}}$, and Abraham's theory agrees quantitatively

very well with the results of measurement of Kaufmann (1901) if it is assumed that there is no "ordinary" mass present. But, the electromagnetic force $F = e[E + \frac{1}{c}(v \times H)]$ was believed to be a constant and be independent of the velocity v .

Note that if we support that the mass m is independent of the velocity v , but the electromagnetic force $F = e[E + \frac{1}{c}(v \times H)]$ is dependent of the velocity v , it will be incompatible with neither the ideas of the electron theory nor the results of measurement of Kaufmann. One further matter needs attention: The E and H occurring in the formula for the force F are supposed to refer to that system in which the electron is momentarily at rest.

3.5.2. The Mass and the Force in the Einstein's Special Relativity

In the Einstein's special relativity, Lorentz's formula for the dependency of mass on velocity has a much more general significance than is the electromagnetic mass apparent. It must hold for every kind of mass, no matter whether it is of electrodynamic origin or not.

Experiments by Kaufmann (1901) and others who have deflected cathode rays by

electric and magnetic fields have shown very accurately that the mass of electrons grows with velocity according to Lorentz's formula (3.25). On the other hand, these measurements can no longer be regarded as a confirmation of the assumption that all mass is of electromagnetic origin. For Einstein's theory of relativity shows that mass as such, regardless of its origin, must depend on velocity in the way described by Lorentz's formula.

Up to now, if we support that all kinds of the mass, m , are independent of the velocity v , but all forces are dependent of the velocity v , it will be incompatible with neither the ideas of the physical theory nor the results of measurement of physics. Could make some new measurements of physics (or some observations of astrophysics) to support this viewed from another standpoint.

3.5.3. The Interchange of the Forces Between the Attraction and the Rejection

Let us return to the Newton's second law, $F=ma$, we can see that the product of mass and acceleration is a quantity anti-symmetric with respect to the two interaction particles B and C . We shall now make the hypothesis that the value of this quantity in any given case depends on the relative position of the particles and sometimes on their relative velocities as well as the time. We express this functional dependence by introducing a vector function $F_{BC}(r, \dot{r}, t)$, where r is the position vector of B with respect to C and \dot{r} is the relative velocity. We then write

$$m_B a_{BC} = F_{BC} . \quad (3.53)$$

and define the function F_{BC} as the force acting on the particle B due to the particle C . It is worthwhile to stress the significance of the definition of force presented here. It will be noted that no merely anthropomorphic notion of push or pull is involved. Eq.(3.53) states that the product of mass and acceleration, usually known as the *kinetic reaction*, is equal to the *force*.

Now, if we explain the experiments by Kaufmann (1901) with here point of view, then, we could say that the electromagnetic force $F = e[E + \frac{1}{c}(v \times H)]$ is a function dependent of the velocity v , $F=F(v)$.

From the above mentioned, the relativity theory provides for an increase of apparent inertial mass with increasing velocity according to the formula

$$m = \frac{m_0}{\sqrt{1 - \beta^2}}$$

could be understood equivalently as a decrease of the effective force of the fields with increasing relativistic velocity between the source of the field and the moving body according to the formula

$$F_{eff} = F \sqrt{1 - \beta^2} .$$

Further, the negative apparent inertial mass could be understood equivalently as the effective forces of the fields have occurred the interchange between the attraction and the rejection according to the formula.

$$F_{eff} = -F\sqrt{\beta^2 - 1}.$$

3.5.4. The Character Velocity and Effective Forces for a Force

Up to now, one common essential feature for forces is neglected— the character velocities for forces. Ones commonly believe that if the resistance on the wagon with precisely the same force with which the horse pulls forward on the wagon then the wagon will keep the right line moving with a constant velocity. However, we could ask that if the resistance on the wagon is zero force then will the wagon be continue accelerated by the horse? How high velocity could be got by the wagon? It is very easy understood that the maximum velocity of the wagon, v_{max} , will be the fastest running velocity of the horse, v_{fst} . The velocity v_{fst} is just the character velocity, v_c , for the pulling force of the horse. When the velocity of the wagon is zero velocity, the pulling force of the horse to the wagon has the largest effective value $F_{eff}=F$. We assume that a decrease of the effective force with increasing velocity of the wagon, and $F_{eff}=0$ if and only if $\beta = \frac{v_w}{v_c} = 1$. If $\beta = \frac{v_w}{v_c} > 1$ then $F_{eff}=-F$. It means that when the velocity of the wagon v_w is larger the character velocity v_c , not that the horse pulls the wagon, but that the wagon pushes the horse.

If the interactions of the fields traverse empty space with the velocity of light, c , then the velocity of light is just the character velocity for all kinds of the interactions of the fields. We guess that the principle of the constancy of the velocity of light is just a superficial phenomenon of the character of the interactions of the fields.

3.5.5. One Possible Experiment for Distinguish Between Moving Mass and Effective Force

The Newtonian law of universal gravitation assumes that, two bodies attract each other with a force that is proportional to the mass of each body and is inversely proportional to the square of their distance apart:

$$F = G \frac{m_1 m_2}{r^2}. \quad (3-54)$$

According as Einstein's special relativity, if the body₁ is moving with constant speed v with respect to the body₂, then the mass of the body₁ will become with respect to the body₂ that

$$M_1 = \frac{m_1}{\sqrt{1 - \frac{v^2}{c^2}}}. \quad (3.55)$$

According to the principle of equivalence the body's gravitational mass equal to its inertia mass. So, the force of gravitational interaction between the two bodies will be

$$F_{M.M.} = G \frac{m_1 m_2}{r^2 \sqrt{1 - \frac{v^2}{c^2}}}. \quad (3.56)$$

But, according as the theory of the effective force, the force of gravitational interaction between the two bodies will be

$$F_{E.F.} = G \frac{m_1 m_2}{r^2} \sqrt{1 - \frac{v^2}{c^2}}. \quad (3.57)$$

We hope that could design some new experiments to discover this deviation.

3.6. Decay of particles

On the Einstein's special relativity theory, consider the spontaneous decay of a body of mass M into two parts with masses m_1 and m_2 . The law of conservation of energy in the decay, applied in the system of reference in which the body is at rest, gives,

$$M = E_{10} + E_{20}. \quad (3.58)$$

where E_{10} and E_{20} are the energies of the emerging particles. Since $E_{10} > m_1$ and $E_{20} > m_2$, the equality (11.1) can be satisfied only if $M > m_1 + m_2$, i.e. a body can disintegrate spontaneously into parts the sum of whose masses is less than the mass of the body. On the other hand, if $M < m_1 + m_2$, the body is stable (with respect to the particular decay) and does not decay spontaneously. To cause the decay in this case, we would have to supply to the body from outside an amount of energy at least equal to its "binding energy" ($m_1 + m_2 - M$).

Usually, ones believe that momentum as well as energy must be conserved in the decay process. Since the initial momentum of the body was zero, the sum of the momenta of the emerging particles must be zero: $\mathbf{p}_{10} + \mathbf{p}_{20} = 0$ in the special relativity theory. Consequently $p_{10}^2 = p_{20}^2$, or

$$E_{10}^2 - m_1^2 = E_{20}^2 - m_2^2. \quad (3.59)$$

The two equations (3.58) and (3.59) uniquely determine the energies of the emerging particles:

$$E_{10} = \frac{M^2 + m_1^2 - m_2^2}{2M}, \quad E_{20} = \frac{M^2 - m_1^2 + m_2^2}{2M}. \quad (3.60)$$

In a certain sense the inverse of this problem is the calculation of the total energy M of two colliding particles in the system of reference in which their total momentum is zero. (This is abbreviated as the "system of the center of inertia" or the "C-system".) The computation of this quantity gives a criterion for the possible occurrence of various inelastic collision processes, accompanied by a change in state of the colliding particles, or the "creation" of new particles. A process of this type can occur only if the sum of the masses of the "reaction products" does not exceed M .

Suppose that in the initial reference system (the “laboratory” system) a particle with mass m_1 and energy E_1 collides with a particle of mass m_2 which is at rest. The total energy of the two particles is

$$E = E_1 + E_2 = E_1 + m_2,$$

and their total momentum is $\mathbf{p}=\mathbf{p}_1+\mathbf{p}_2=\mathbf{p}_1$. Considering the two particles together as a single composite system, we find the velocity of its motion as a whole from (2.19):

$$V = \frac{P}{E} = \frac{P_1}{E_1 + m_2}. \quad (3.61)$$

This quantity is the velocity of the C -system with respect to the laboratory system (the L -system).

However, in determining the mass M , there is no need to transform from one reference frame to the other. Instead we can make direct use of formula (3.36), which is applicable to the composite system just as it is to each particle individually. We thus have

$$M^2 = E^2 - p^2 = (E_1 + m_2)^2 - (E_1^2 - m_1^2),$$

from which

$$M^2 = m_1^2 + m_2^2 + 2m_2E_1. \quad (3.62)$$

4 Quantum Theory of a Particle on the Finsler Space-timed⁴

4.1. The Klein-Gordon Equation and The Dirac Equation on the Finsler Space-timed⁴

In the formula (2.20) let $E = i\hbar \frac{\partial}{\partial t}$, $P = i\hbar \nabla$, $m = \hbar \frac{k_0}{c}$, we could get

$$\left[\left(\nabla^2 - \frac{1}{c^2} \frac{\partial^2}{\partial t^2} \right)^2 - k_0^4 \right] \psi = 0 \quad (4.1)$$

let $p_4^2 = \nabla^2 - \frac{1}{c^2} \frac{\partial^2}{\partial t^2}$ then

$$(p_4^4 - k_0^4) \psi = 0. \quad (4.2)$$

The formula (4.2) has the catastrophe nature, it could be resolved two parts at the super-surface $p_4 - k_0 = 0$:

$$(p_4^2 - k_0^2) \psi = 0, \quad (4.3)$$

and

$$(p_4^2 + k_0^2) \psi = 0. \quad (4.4)$$

The formula (4.3) is just the Klein-Gordon equation for a free particle. Usually, it is believed

that the formula (4.3) describes a pair of a particle and an antiparticle for a meson field. But, we know from the formula (3.36) that it describes these cases for type I and type IV of the space-time transformation; i.e., it describes the time-like representation of a subluminal-speed particle and the time-like representation of a superluminal-speed particle. However, equation (4.4) is applicable to these cases for type II and type III of the space-time transformation; i.e., it describes the space-like representation of a subluminal-speed particle and the space-like representation of a superluminal-speed particle.

In formulas (3.39) and (3.40)

$$c^2(\nabla S - \frac{e}{c}A)^2 - (\frac{\partial S}{\partial t} + e\Phi)^2 \pm m^2c^4 = 0. \quad (4.5)$$

$\frac{\hbar}{i} \frac{\partial}{\partial t}$ was substituted in place of $\frac{\partial S}{\partial t}$, as is usual in quantum mechanics, and in place of ∇S , the operator $\frac{\hbar}{i} \nabla$. In this way a Klein-Gordon equation was obtained in relativistically invariant form in an electromagnetic field

$$c^2(\frac{\hbar}{i} \nabla - \frac{e}{c}A)^2 \psi - (\frac{\hbar}{i} \frac{\partial}{\partial t} + e\Phi)^2 \psi + m^2c^4 \psi = 0 \quad (4.6)$$

and

$$c^2(\frac{\hbar}{i} \nabla - \frac{e}{c}A)^2 \psi - (\frac{\hbar}{i} \frac{\partial}{\partial t} + e\Phi)^2 \psi - m^2c^4 \psi = 0, \quad (4.7)$$

which equation (4.6) is applicable to these cases for type I and type IV of the space-time transformation; i.e., it describes the time-like representation of a subluminal-speed particle and the time-like representation of a superluminal-speed particle. However, equation (4.7) is applicable to these cases for type II and type III of the space-time transformation; i.e., it describes the space-like representation of a subluminal-speed particle and the space-like representation of a superluminal-speed particle.

In the line of Dirac's argument, he began with the equation for a free electron. The starting relationship is (3.36). Now, we rewrite:

$$E = \sqrt{c^2(p_x^2 + p_y^2 + p_z^2) + m^2c^4}, \quad (4.8)$$

worthy of note is that it describes these cases for type I and type IV of the space-time transformation: i.e., it describes a time-like representation of subluminal-speed particle and a time-like representation of superluminal-speed particle in our theoretical system.

Modern quantum electrodynamics is based upon the quantum theory of the electromagnetic field and the Dirac electron theory, with account taken of direct and reverse transitions from negative energy to positive energy. The attitude towards the Dirac equation was somewhat suspicious before the discovery of the positron, while the idea of background was considered far-fetched and intended only to hide the defects of the theory. But ones forgot

those suspicions after the positron was discovered by Anderson. The Dirac's theory describes an electron and a positron in a completely symmetrical way, but positrons are observed very littler than the electrons there seem to be no this symmetry in nature. Whether the positron is just the time-like representation of a superluminal-speed electron?

We hope that theoretical physicists will be interested in the new possible explanation for antiparticles.

5 The Theory of Relativity on the Finsler Space-time $F(x,y)$

5.1.The Theory of Relativity and Catastrophe Theory

5.1.1. Three Theorems of Catastrophe Theory

Elementary catastrophe theory exists at the intersection of two lines of mathematical development. One is the program of catastrophe theory, which attempts to study the qualitative properties of solutions of equations. The other is a series of results in elementary calculus dealing with the canonical forms for functions. The first two landmarks in this sequence of results are the implicit function theorem and the Morse lemma. The implicit functions theorem deals with functions that have a good linear approximation. The Morse lemma deals with functions that can adequately be approximated by a quadratic form. The third in this sequence of developments is the Thom theorem. This theorem provides canonical forms of functions in neighborhoods where neither the linear approximation nor the quadratic approximation are adequate.

1.The implicit function theorem

Let $f(x)=f(x_1,\dots,x_n)$ be a function with nonzero gradient at a point x^0 :

$$\nabla f |_{x^0} \neq 0. \quad (5.1)$$

Then the implicit function theorem tells that it is possible to find a new coordinate system $y=y(x)$ such that

$$f = y_1. \quad (5.2)$$

That is, f is equal, after a smooth change of coordinates, to y_1 .

2.The Morse lemma

If $\nabla f=0$ at a point, then physicists are likely to say 'the implicit function theorem fails'. However, the Morse lemma states that if $\nabla f=0$ but the determinant of the matrix of mixed second partial derivatives is nonzero

$$\det \left(\frac{\partial^2 f}{\partial x_i \partial x_j} \right) \neq 0 \quad (5.3)$$

at the point. Then $f(x)$ has a canonical quadratic form, i.e., there is a smooth change of variables $x'=x'(x)$ such that

$$f = \sum_{i=1}^n (\lambda_i x'_i)^2 \quad (5.4)$$

where λ_i are the eigenvalues of the stability matrix $\left(\frac{\partial^2 f}{\partial x_i \partial x_j} \right)$.

By absorbing the nonzero eigenvalues into the length scale according to

$$y_i = \sqrt{\lambda_i} x'_i,$$

the quadratic form (5.4) is reduced to the Morse canonical form

$$\begin{aligned} f &= M_i^n, \\ M_i^n &= -y_1^2 - y_2^2 - \dots - y_i^2 + y_{i+1}^2 + \dots + y_n^2. \end{aligned} \quad (5.5)$$

The forms (5.5) are called Morse saddles. The Morse saddle M_0^n has a minimum at $y=0$. The

only stable Morse saddle is M_0^n .

3. The Thom theorem

Let $f(x)$ be a function with the properties

$$\begin{aligned} \nabla f &= 0, \\ \det \left(\frac{\partial^2 f}{\partial x_i \partial x_j} \right) &= 0, \end{aligned} \quad (5.6)$$

at a point. If the stability matrix $\left(\partial^2 f / \partial x_i \partial x_j \right)$ has k zero eigenvalues and i negative eigenvalues, then the Thom theorem (splitting lemma) tells that

$$f(x) = f_{NM}(x'_1, \dots, x'_k) + M_i^{n-k}(x'_{k+1}, \dots, x'_n), \quad (5.7)$$

where $f_{NM}(x', c)$ is a non-Morse function, derived from the splitting lemma, depending on s control parameters and k state variables. Then the Thom theorem (classification theorem) tells that

$$\begin{aligned} f_{NM}(x', c) &= Cat(k, s), \\ Cat(k, s) &= CG(k) + Pert(k, s), \end{aligned} \quad (5.8)$$

where $Cat(k, s)$, the catastrophe function, is a function of k canonical state variables y_1, \dots, y_k and s canonical control parameters a_1, \dots, a_s . The catastrophe function $Cat(k, s)$ has a further decomposition (another splitting) into two parts $CG(k)$ and $Pert(k, s)$. The catastrophe germ $CG(k)$ depends on only the k state variables. All of its mixed second partial derivatives vanish at the critical point. The perturbation $Pert(k, s)$, depends on the k state variables and on the s canonical control parameters.

5.1.2. The Signature and Catastrophe

It is known that the number of + and - signs occurring is called the signature of the metric in the theory of relativity. But, in ordinary differential geometry, one usually deals with positive definite metrics, i.e., metrics with signature $++\dots+$. On the other hand, the metric of space-time has a signature $-+++$ in the theory of relativity. So, the space-time metric is a Morse saddle M_1^4 , and it is must unstable by the Morse lemma. Therefore, we could say that the metrics of the space-time involved with the structural instability of the space-time in the Einstein's relativistic theory.

In general, ones hope that a small change in parameter values of some equations has only a small quantitative effect on the solutions of these equations. However, under certain conditions a small change in the value of some parameter has a very large quantitative effect on the solutions of these equations. Large quantitative changes in solutions describe qualitative change in solutions describe qualitative change in the behavior of the system modeled. The system will be called the structural unstable system.

Perhaps, the structural instability of the space-time is just an important nature of the space-time. However, it was deserted in the theory of relativity. Indeed, the Poincare-Lorentz transformations (the set of all possible transformations between global inertial coordinates) consist precisely of the linear transformations which leave signature of metric unchanged. But, as we pointed out, it is only a subgroup of the transformations group of the space-time (2.2).

5.2. The Space-time Structure of the Finsler $F(x,y)$

It is well known that is not space-time that is there and that impresses its form on things, but the things and their physical laws that determine space-time. So, we could not study the faster than the speeds of light by the theory of relativity as the theory of tachyons, but that the space-time structure of relativity theory must be replaced by a new space-time structure.

5.2.1. The Finsler Space-time $F(x,y)$

Let us discuss the Finsler geometry; it concerns a real N-dimensional differentiable manifold M which is endowed with a non-negative scalar function $F(x,y)$ of two sets of arguments: Namely, points x^i and contra variant vectors y^i tangent to M at x^i , or symbolically, $x^i \in M$ and $y^i \in M_x$. Our subsequent considerations will be local in nature so that, remaining within the framework of classical tensor calculus, we shall represent geometrical objects by their components with respect to a local coordinate system x^i carried by the background manifold M .

It will be sufficient for usual purposes to stipulate the smoothness of the function $F(x,y)$ by the following two conditions:

1. The function $F(x,y)$ is at least of class C^3 with respect to x^i , which makes us assume in

turn that the background manifold M itself is at least of class C^3 .

2. A region M_x^* exists in each tangent space M_x such that, first, M_x^* is conic in the sense that if M_x^* contains some vector y_1^i then M_x^* contains any other vector collinear with y_1^i , and second, the function $F(x,y)$ is at least of class C^5 with respect to all non-zero vectors $y^i \in M_x^*$ will be called admissible.

Furthermore, it will be assumed that the function $F(x,y)$ is to be positively homogeneous of degree one with respect to y^i -i.e.,

$$F(x,ky) = kF(x,y) \quad (5.9)$$

for any $k > 0$ and for all $y^i \in M_x^*$, and for any admissible y^i ,

$$f(x,y) > 0. \quad (5.10)$$

Besides this,

$$\det \left(\frac{\partial^2 F^2(x,y)}{\partial x^i \partial x^j} \right) \neq 0. \quad (5.11)$$

Under these conditions, the triple $(M, M_x^*, F(x,y))$ is called an N -dimensional Finsler space, and $F(x,y)$ is called a Finslerian metric function. The value of the metric function $F(x,y)$ is treated in Finsler geometry as the length of the tangent vector y^i attached to the point x^i . If a Finsler space allows a coordinate system x^i such that F does not depend on these x^i , the Finsler space and the metric function are called Minkowskian.

It will be noted that, in mathematical works devoted to the Finsler geometry, additional conditions are usually imposed on the metric function F which ensure the positive definiteness of the quadratic form $Z^i Z^j \partial^2 F^2(x,y) / \partial x^i \partial x^j$ at any point x^i and for any non-zero vector $y^i \in M_x$. However, it is clear already in the Riemannian formulation of general relativity theory that the metric structure of space-time cannot be positively definite, for the space-time metric tensor must be of the indefinite signature $(-+++)$. This reason alone makes one expect that it is indefinite metrics that may be of interest in a Finslerian extension of general relativity. Accordingly, we refrain deliberately from imposing the condition of positive definiteness, thereby admitting that the Finsler space under study can be indefinite.

As regards the homogeneity condition (5.9) it should be pointed out that the necessity of postulation (5.9) follows from the invariant notions inherent in any centroaffine space, the tangent space M_x being an example of such a space. Indeed, the ratio of the lengths of any two collinear vectors y_1^i and $y_2^i = ky_1^i$ of the centroaffine space may be invariantly defined to be

$$\frac{y_1^1}{y_2^1} = \frac{y_1^2}{y_2^2} = \dots = k,$$

which does not involve any metric function. Therefore, (5.9) is nothing but the requirement of consistence of the Finslerian definition of length with the centroaffine definition. The

Finslerian metric function is required in order to compare the lengths of non-collinear vectors.

If a fundamental function $F(x,y)$ is defined for all line-elements in the region $R(R \subset M)$, it would be natural to regard F as defining a distance in M , for instance the 'length' of the curve \bar{C} between the points P_1 and P_2 could well be defined by the integral

$$I = \int_{t_1}^{t_2} \left(x^i, \frac{dx^i}{dt} \right) dt. \quad (5.12)$$

More precisely, if $A(x^i)$ and $B(x^i + dx^i)$ are two neighboring points of R , the distance ds between them is defined by

$$ds = F(x^j, dx^j), \quad (5.13)$$

Since F is homogeneous of first degree in the dx^i , this would lead to the required integral. In this manner a metric is imposed on our M .

If, in particular, the function F is of the form

$$F(x^i, dx^j) = \sqrt{g_{ij}(x^k) dx^i dx^j}, \quad (5.14)$$

where the $g_{ij}(x^k)$ are coefficients independent of the y^i , the metric defined by F is the metric of a Riemannian space.

In this paper we will assume that

$$F(x^i, y^i) = [(e_{ijkl} g_{ijkl}(x^h) dx^i dx^j dx^k dx^l)]^{1/4}, \quad e_{ijkl} = \pm 1, \quad i, j, k, l = 0, 1, 2, 3 \quad (5.15)$$

An even function form for the dx^i is

$$F(x^i, dx^j) = \sqrt[e_{ij} g_{ij}(x^k) dx^i dx^j]{}, \quad (5.16)$$

where

$$e_{ij} = \begin{cases} +1, & i = j, \\ +\delta, & i \neq j, \quad i, \text{ and } j \neq 0, \quad 0 \leq \delta \leq 1, \\ -b, & i \neq j, \quad i, \text{ or } j = 0, \quad 0 \leq b \leq 1. \end{cases}$$

In particular, a degenerate form is

$$F(x^i) = \sqrt[e_{ij} g_{ij}(x^k) dx^i dx^j]{}, \quad \delta = 1, \quad (5.17)$$

where $ds^2 = g_{ij} dx^i dx^j$ is usual Riemannian metric in the general relativity.

It is natural to assume that all distances are positive; hence, we stipulate condition (5.10).

On the other hand, the homogeneity condition (5.9) plays an important constructive role in Finsler geometry, many Finslerian relations being based on identities ensuing from (5.9). To derive these identities, let us consider any function $Z(x,y)$ which is differentiable and positively homogeneous of degree r with respect to y^i ; that is, $Z(x,ky) = k^r Z(x,y)$ for any $k > 0$, where the degree r may be any real number. On differentiation the latter equality with respect

to k and put $k=1$, we find that

$$Z(x, ky) = k^r Z(x, y) \text{ implies } y^i \frac{\partial Z(x, y)}{\partial y^i} = rZ(x, y). \quad (5.18)$$

The assertion (5.18) is known in the literature as the Euler theorem on homogeneous functions.

The application of (5.18) to F^2 yields

$$F^2(x, y) = g_{ij}(x, y) y^i y^j, \quad (5.19)$$

where

$$g_{ij}(x, y) = \frac{1}{2} \frac{\partial^2 F^2(x, y)}{\partial y^i \partial y^j} \quad (5.20)$$

is called the Finslerian metric tensor, it is a quadratic form. It is very interesting that the condition (5.11) is just requisite of the Morse lemma.

5.2.2. The Catastrophe Change on the Finsler Space-time $F(x, y)$

Because the Finsler space-time under our study can be indefinite, it must have to make

$$\det\left(\frac{\partial^2 F^2}{\partial y^i \partial y^j}\right) = 0 \quad (5.21)$$

on some non-zero subset of the space-time manifold M . So, with the Thom theorem (splitting lemma), we could get

$$f(x, y) = F_{NM}(x, y^1, \dots, y^k) + M^{n-k}(x, y^{k+1}, \dots, y^n), \quad (5.22)$$

if the matrix $(\partial^2 F^2 / \partial y^i \partial y^j)$ has k zero eigenvalues and s negative eigenvalues. Then the

Thom theorem (classification theorem) tells that

$$\begin{aligned} F_{NM}(x, y) &= \text{Cat}(x, k), \\ \text{Cat}(x, k) &= CG(k) + \text{Pert}(x, k), \end{aligned} \quad (5.23)$$

where $\text{Cat}(x, k)$, the catastrophe function, is a function of k canonical state variables y^1, \dots, y^k and n canonical control parameters x_1, \dots, x_n . The catastrophe function $\text{Cat}(x, k)$ has a further decomposition (another splitting) into two parts $CG(k)$ and $\text{Pert}(x, k)$. The catastrophe germ, $CG(x)$, depends on only the k state variables. All of its mixed second partial derivatives vanish at the critical point. The perturbation, $\text{Pert}(x, k)$, depends on the k state variables and on the n canonical control parameters.

It is clear that if equation (5.21) is satisfied then as (5.20) it will be held that

$$\det(g_{ij})=0, \quad (5.24)$$

with the theory of the quadratic form we get

$$ds^2 = g_{ij} dx^i dx^j = 0, \quad (5.25)$$

it is known that (5.25) is just the light cone in the general relativity. On the other hand,

$$\det(g_{ij}) > 0 \text{ and } \det(g_{ij}) < 0, \quad (5.26)$$

with the theory of the quadratic form we get

$$ds^2 = g_{ij} dx^i dx^j > 0 \text{ and } ds^2 = g_{ij} dx^i dx^j < 0. \quad (5.27)$$

So, the space-time manifold M is divided into four parts by the different values of the $\det(\partial^2 F^2(x, y) / \partial y^i \partial y^i) = Det$:

$$\begin{cases} Det \neq 0 & ds^2 > 0 & \text{the timelike state,} \\ \text{(material states)} & ds^2 < 0 & \text{the spacelike state;} \\ Det = 0 & ds^2 = 0 & \text{the lightlike state} \\ \text{(singularities)} & dx^i = 0 & i = 0, 1, 2, 3; \text{the origin.} \end{cases} \quad (5.28)$$

From (5.21) and (5.28), it means that the light cone is still a catastrophe set on the curve space-time manifold M , and both the time-like state and the space-like state are possible states of moving particles as had been already pointed out in the flat space-time but, here the catastrophe function has

$Pert(x)$, it is only CG(k) in the flat space-time.

So, we expect that the catastrophe nature will be shown on the horizon of the fields of the general relativity.

5.3. The Catastrophe Nature in the Schwarzschild Field

5.3.1. The Geodesic Equations and Its Integrations of the Schwarzschild Field

By way of example, we will discuss the spherically symmetric and static metric which obeys the Einstein field equation

$$ds^2 = -\mu dt^2 + \mu^{-1} dr^2 + r^2 (d\theta^2 + \sin^2 \theta d\phi^2), \quad (5.29)$$

where $\mu = 1 - r_s/r = 1 - 2m/r$ ($r_s = 2m$ is called the Schwarzschild radius or gravitational radius). In this equation and thereafter in this paper, the geometric unit, $c = G = 1$, has been adopted. It is well known that the geodesic equations followed from (5.29) have three first integrations:

$$r^2 \frac{d\theta}{ds} = h, \quad (5.30)$$

$$\mu \frac{dr}{ds} = k, \quad (5.31)$$

$$\frac{1}{\mu} \left(\frac{dr}{ds} \right)^2 + \left(\frac{h}{r} \right)^2 - \frac{1}{\mu} = -E . \quad (5.32)$$

If we use t to replace s , we get

$$\frac{d\theta}{dt} = B \frac{1}{r^2} \left(1 - \frac{r_s}{r} \right), \quad B = \frac{h}{k}, \quad (5.33)$$

$$\frac{1}{\mu^3} \left(\frac{dr}{dt} \right)^2 + \left(\frac{B}{r} \right)^2 - \frac{1}{\mu} = -\frac{E}{k^2} = A, \quad (5.34)$$

We see that the constant A could be taken as different values:

$A < 0$ for subluminal-speeds (the time-like state),

$A = 0$ for light speed (the light like state),

$A > 0$ for superluminal-speeds (the space-like state).

In order to show clearly the catastrophe nature of the Schwarzschild field, we will consider a motion along radial direction. In equation (5.34) let $B=0$, we will get

$$v = \frac{dr}{dt} = \pm \mu \sqrt{A \mu + 1}. \quad (5.35)$$

The velocity v is the coordinate velocity obtained by a distant observer. In the general relativity, generally, a particle can move only with the velocity $0 < |v_0| < 1$. So, for a particle far from the gravitational center, we have

$$-\infty < \frac{1}{\mu} \left(\frac{v^2}{\mu^2} - 1 \right) = A < 0. \quad (5.36)$$

5.3.2. The Lightlike State——The Set of the Critical Points

When $A=0$, then

$$v = \mu = 1 - \frac{r_s}{r}, \quad (5.37)$$

it is the coordinate velocity of light observed by a distant observer. $v \rightarrow 0$ as $r \rightarrow r_s$, and $v=1$ (i.e., c) as $r \rightarrow \infty$. In Einstein's view, the velocity of light effected by the gravitation fields. But, in the catastrophe theory's view, the catastrophe set effected by the perturbation, $Pert(x,k)$, depends on the k state variables (here is just only r and t , because we consider only a motion along radial direction in a spherically symmetric and static metric) and on the 4 canonical control parameters, x^i (here is just A and r_s).

Integrating equation (5.37) yields

$$t - t_0 = r + r_s \ln(r - r_s), \quad A = 0 \quad (5.38)$$

(5.38) describes the motion for the photon. It shows that

5.3.3. The Radial Subluminal Expansions

If $A = -a$ ($a > 0$), then $v = \pm \mu \sqrt{1 - a\mu}$ and it has a maximum $v_{\max} = \frac{1}{\sqrt{3}} \frac{2}{3a}$ at $\mu = \frac{2}{3a}$,

or $r = \frac{3ar_s}{3a-2}$ (e.g., when $a=1$, $r = 3r_s$, and $a=2/3$, $r \rightarrow \infty$, etc.), and $v=0$ at $\mu=0$, or $r=r_s$, and

$\mu = \frac{1}{a}$, or $r = \frac{ar_s}{a-1}$ (e.g., when $a=1$, $r \rightarrow \infty$, and $a=2$, $r=2r_s$, etc.). They could produce a

subluminal expansion; it is the usual cases of general relativity.

Integrating equation (5.35) yields

$$t - t_0 = -\frac{\sqrt{arr_s - (a-1)r^2}}{a-1} + \frac{(3a-2)r_s}{2\sqrt{(a-1)^3}} \arcsin \frac{2(a-1)r - ar_s}{ar} +$$

$$r_s \ln \frac{r_s}{r - r_s} \left[(2-a)r + ar_s - 2\sqrt{(1-a)r^2 + arr_s} \right] \quad 1 < a < \infty, \quad r \leq \frac{a}{a-1} r_s. \quad (5.39)$$

It shows that the particle will stop at a finite distance $a \leq \frac{ar_s}{a-1}$ for $a > 1$;

$$t - t_0 = \frac{2}{3}(r_s + 4) - \sqrt{rr_s} \left(\frac{r}{r_s} + 3 \right) + r_s \ln \frac{\sqrt{r} - \sqrt{r_s}}{\sqrt{r} + \sqrt{r_s}}, \quad a = 1. \quad (5.40)$$

It shows that the particle will stop at an infinite distance for $a=1$.

$$t - t_0 = \frac{\sqrt{(1-a)r^2 + arr_s}}{a-1} + \frac{(2-3a)r_s}{2\sqrt{(1-a)^3}} \ln \left[\sqrt{(1-a)r^2 + arr_s} + r\sqrt{1-a} + \frac{ar_s}{2\sqrt{1-a}} \right]$$

$$+ r_s \ln \frac{r_s}{r - r_s} \left[(2-a)r + ar_s - 2\sqrt{(1-a)r^2 + arr_s} \right] \quad 0 < a < 1. \quad (5.41)$$

It shows that the particle with continuously move with a velocity $v = \sqrt{1-a} < 1$ at infinite distance for $0 < a < 1$.

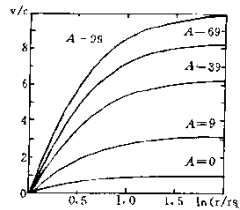

Fig. 5.1. The increasing process of the velocity

5.3.4. The Superluminal Expansions in the Schwarzschild field

It is very interesting in the case about $A>0$; it could be produced by the space-time catastrophe in reference to our theory. With the formula (5.35), if $A=99$, then $v=10c$ when $r\rightarrow\infty$. It is very interesting that a very small s_0 's perturbation could give an enough large A nearby the horizon. For instance, let $\mu_0=10^{-9}$, and $v_0=(1+5\times 10^{-8})\mu_0$, then $A=100$. So, a particle will move with a superluminal-speed $v=10c$ at infinity under this condition. We guess that the horizon is very like a chaotic state.

Figure 5.1 gives graphically the increasing of the particle velocity as a function of the $\ln(r/r_s)$, where r_s is the Schwarzschild radius, and r is the radial coordinate of the particle.

We can see from Figure 5.2 that a particle moving along a space-like curve will expand acceleratively with a superluminal-speed. When $r=10r_s$, the velocity of the particle achieves about 85% of the maximum velocity $v_{max}=\sqrt{A+1}$, the particle can be attended at infinity.

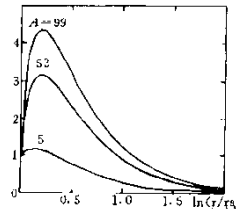

Fig. 5.2. Some repulsive force near the r_s

Figure 5.2 shows the $r_s \frac{dv}{dr}$ vs. $\ln\left(\frac{r}{r_s}\right)$ curve. From this curve we can see that the interaction between a gravitational center and a particle moving with superluminal-speed has the feature of repulsive interaction. At $r>100r_s$ the interaction varies according to the inverse-square law approximately, but it is repulsive, and at $r\leq 100r_s$ the inverse-square law is violated.

Integrating Equation (5.35) yields

$$t - t_0 = \frac{\sqrt{(A+1)r^2 - Arr_s}}{A+1} + \frac{(3A+2)r_s}{2\sqrt{(A+1)^3}} \ln \left[\sqrt{(A+1)r^2 - Arr_s} + \sqrt{A+1}r - \frac{Ar_s}{2\sqrt{A+1}} \right] + r_s \ln \frac{(A+2)rr_s - Ar_s^2 - 2r_s \sqrt{(A+1)r^2 - Arr_s}}{r - r_s} = F(A, r, r_s), \quad A > 0. \quad (5.42)$$

These results show that the motion of a particle is indeed very different when A has different values. In particular, from (5.42), we get the r vs. t diagram given in Figures 5.3 and 5.4. In Figure 5.3, we compare the r - t curves for particles with same gravitational mass ($r_s=1$ ly) but different A 's. From this comparison we find that particle with higher beginning velocity has higher limit velocity at infinity, longer delayed time before expansion and higher acceleration, and *vice versa*.

Taking $A=143$, i.e., $v_{max}=12$, but using different value of the gravitation mass at center,

$r_s=10^{-4}, 5, 10$ ly, we get diagram of Fig.5.4. It shows that if particles move out from place just outside the

Schwarzschild radius then the expansion will be slower for higher central mass. For example, if $r_s=10^{-4}$ ly, then a particle moves to $r=100$ ly from initial place near the r_s takes about 8.33 years. But, if $r_s=5$ ly, then it should take 45 years.

From equations (5.33) and (5.34) we could get several very interesting results when $A>0$ for the non-radial motions in the Schwarzschild fields:

1. From (5.33) we see that in the rate of revolution $\dot{\theta} = \frac{d\theta}{dt}$ as a function of r , when

$$r=r_m=1.5 \times r_s, \quad (5.43)$$

it will get a maximum. So, if the maximum had been found by the observations and from it determined r_m , then $r_s=r_m/1.5$.

2. From (5.33) and (5.34) we get

$$\frac{d\theta}{dr} = B \sqrt{r \left[(A+1)r^3 - Ar_s r^2 - B^2 r + B^2 r_s \right]}. \quad (5.44)$$

It is clear that formula (5.44) is a hyperbola when $A \gg 1$. And the solution of (5.44) may then be determined by elliptic integral

$$\begin{aligned} \theta - \theta_0 &= \frac{2B}{(r_1 - r_3)(r_2 - r_4)} \operatorname{sn}^{-1} \left(\sqrt{\frac{r_2 - r_4}{r_1 - r_4} \frac{r - r_1}{r - r_2}}, \sqrt{\frac{r_2 - r_3}{r_1 - r_3} \frac{r_1 - r_4}{r_2 - r_4}} \right) = \\ &= \theta(A, r_s, B, r), \quad (r_1 > r_2 > r_3 > r_4). \end{aligned} \quad (5.45)$$

§6. The Superluminal Expansion of the Extragalactic Radio Sources

6.1. The Observation of the Superluminal Phenomena

6.1.1. Radio Sources With Superluminal Velocities

Brightness distributions in some extragalactic radio sources have been seen to vary so rapidly transverse velocity of expansion is greater than the velocity of light (assuming a cosmological origin for the redshift). The term superluminal was used to describe this phenomenon.

The observations have all been obtained with very-long-baseline interferometry (VLBI) systems using two to five radio telescopes, spaced over thousands of kilometers, to form multi-element interferometers.

According to the standard model of cosmology, the angular size θ of an object with redshift z can be converted into a linear separation R ,

$$R = \frac{\theta}{H_0 q_0^2 (1+z)^2} \left[q_0 z + (q_0 - 1) \left(\sqrt{1 + 2q_0 z} - 1 \right) \right], \quad (6.1)$$

where $H_0=80 \text{ kms}^{-1}\text{Mpc}^{-1}$ is Hubble constant; q_0 is the deceleration parameter being taken to be 0.05 in following.

The derivations of θ or/and R with respect to t will give the expansion rate

$$\frac{d\theta}{dt} = (1+z) \frac{d\theta}{dt_0} \quad \text{or} \quad v = \frac{dR}{dt} = (1+z) \frac{dR}{dt_0}. \quad (6.2)$$

So far, over 65 objects are identified to be superluminal expansive (2 objects in the Galaxy). The observational data are given in Table 1.

Table 1. The Data of Superluminal Radio Sources

Source	Name	Redshift z	Component	B_{app}	Note
0016+731	Q,S5	1.781		8.3	
0106+013	Q,4C01.02	2.107	C2	8.2	
0108+388	G,OC314	0.669		<2.14	
0133+207	Q,3C47	0.425	K	3.69	
0153+744	Q,S5	2.34	C2 C3 C4	1.08 2.41 - 5.12	
0212+735	Q,S5	2.370		3.90	
0234+258	Q,CTD20	1.213		9.29	
0235+164	BL Lac	0.94		37 ~ 45	
0333+321	Q,NRAO140	1.258	B	4.77	
0415+379	G,3C111	0.049		3.42	
0421 - 014	Q	0.915		3.9	
0430+052	C,3C120	0.033	A B C D E	1.86 3.45 3.36 3.63 3.36	
0454+844	B,S5	0.3		>1.60	
0538+498	Q,3C147	0.545		1.30	
0552+398	Q,DA193	2.365		1.80	
0615+820	Q,S5	0.71		2.20	
0710+439	G,S4	0.518		<1.25	
0711+356	Q,O1318	1.620		5.50	
0716+714	B,S5	>0.3		2.30	
0723+679	Q,3C179	0.846		4.80	
0735+178	B,PKS	>0.424	B C0 D	1.68 7.20 <3.01	
0742+318	Q,2C31.30	0.462		2.48	
0833+654		1.112		- 2.2	

0835+580		1.534		- 4.4	
0836+710		2.170	B C D	10.40 4.53 5.79	
0850+581	Q,4C58.17	1.322		3.90	
0851+202	B,OJ287	0.306	SW1 SW2	<2.69 3.20	
0906+430	Q,3C216	0.670	A B	2.07 3.86	
0923+392	Q,4C39.25	0.699	A B	2.40 3.50	
1039+811	Q,S5	1.26		2.20	
1040+123	Q,3C345	1.029	A2	3.10	
1101+384	B,MKN421	0.031	C1 C2	1.90 1.34	
1137+660	Q,3C263	0.652		1.30	
1150+812	Q,S5	1.25	C2	<4.10	
1156+295	Q,4C29.45	0.729		26.1	
1222+216	Q,4C21.35	0.435	B	1.40	
1226+023	Q,3C373	0.158	C2 C3 C4 C5 C7 C7a C8 C9	8.0 5.03 6.60 7.99 4.33 5.06 6.13 5.47	
1253 - 055	Q,3C279	0.538	? C3	9.20 2.19	
1308+326	B,B2	0.996	K1 K2 K3	3.58 20.7 7.98	
1334 - 127		0.541		5.2	
1458+718	Q,3C309.1	0.905	B	6.53 1	
1618+177	Q,3C334	0.555		1.88	
1641+399	Q,3C345	0.595	C2 C3 C4 C5	9.50 5.87 6.07 4.50	non-radial non-radial
1642+690	Q,4C69.21	0.751		7.90	
1721+343	Q,4C34.47	0.2055	B C	1.35 2.30	
1749+701	B,S5	0.77		6.12	
1803+784	B,S5	0.684		3.9	
1807+698	3C371	0.05		5.9	

1823+568	B,4C56.27	0.664	K1	2.56	
1828+487	Q,3C380	0.691	A	8.32	
			B	5.01	
1830+285	Q,4C28.45	0.594	B	2.55	
			C	2.55	
1845+797	3C390.3	0.0569		1.68	
1901+319	Q,3C395	0.650	2	1	
			3	13.10	
1928+738	Q,4C73.18	0.302	A1	3.73	
			B	4.32	
			C	3.96	
			C2	5.94	
			C3	6.64	
			C4	4.66	
			C6	4.66	
			C7	7.00	
			C9	3.61	
1951+498	Q	0.4660		1.20	
2007+776	B,S5	0.342	C2	2.30	
2200+420	BL Lac	0.068	S1	3.70	
			S2	3.40	
			S3	3.48	
			S5	3.09	
				3.40	
2230+114	Q,CTA102	1.037		<14.20	
2251+158	Q,3C454.3	0.859	2	1.13	
			3	- 1.12	
			4	8.78	
			5	5.28	
2345 - 167	HPQ	0.576		5.0	
2352+495	G	0.237	A	<1.12	
			B2	<1.12	
1915+105	GPS	-		1.25	in the Galaxy
J1655 - 40	GRO				in the Galaxy

6.1.2 Is the Most Popular Model Correct ?

The superluminal story begins with the discovery by Sholomitsky in the Soviet Union and Demt of the U.S.A. of surprisingly rapid flux density changes in several quasars. Now, the situation is very much improved. Multi-element interferometer systems are used together with sophisticated image restoring algorithms, and there is now little doubt about the reality of superluminal motion. Specially, researchers using the Very Large Array have reported the two apparent superluminal motion ever detected in our Galaxy. Due to relativistic time dilation effects, the observed plasma clouds appear to be moving at 125% the speed of light in the

object GRS1915+105.

Many models had been considered to explain superluminal motion including:

1. Approximately phased intensity variations in fixed components—the so-called “Christmas Tree” or “Movie Marquee” model.
2. Non-cosmological red shifts.
3. Gravitational lenses or screens.
4. Variations in synchrotron opacity.
5. Synchrotron curvature radiation in a dipole magnetic field.
6. Light echoes.
7. Real tachyonic motion.
8. Geometric effects of relativistically moving sources.

At least a few superluminal sources, as 3C120, are found in relatively low red-shift galaxies. Several others are in nebulosity's with measured red shifts, and interpretations based on non-cosmological red shifts appear unsatisfactory to all but the most avid proponents of exotic cosmologies. Specially, two superluminal sources are found in our Galaxy. But in one way

or another, most other models also conflict with the observations.

During the past 20 years there has been increasing interest in the effect of the finite signal propagation time from a relativistically moving source, since simple relativistic models not only explain the observed superluminal motion, but the rapid flux density variations, and the absence of observed Compton scattered x rays as well. So, ones believe in that the model of relativistic jets is best for explain superluminal motion. So far, it is most popular model.

6.1.3. Relativistic Jets

If a source of radiation is moving with relativistic velocity at an angle θ with respect to the line of sight, then the apparent transverse velocity is given by

$$v_{app} = \frac{v \sin \theta}{1 - \beta \cos \theta} \quad (6.3)$$

which has a maximum value

$$v_{max} \approx \gamma c \quad (6.4)$$

that occurs at an angle

$$\theta_m \approx \sin^{-1}\left(\frac{1}{\gamma}\right), \quad \gamma = \sqrt{1 - \beta^2}, \quad \beta = \frac{v}{c}. \quad (6.5)$$

The probability that a randomly oriented beam is within an angle θ_m of the line of sight is $P(\theta_m) \approx \frac{1}{2\gamma^2}$. The radiation from a relativistically moving source is boosted in strength

along the

direction of motion by the factor

$$\delta = \gamma^{-n} (1 - \beta \cos \theta)^{-n} \quad (6.6)$$

where n depends on the spectral index and whether or not flow is continuous or in discrete components, but is approximately 3. When viewed head on, the flux density $S(\theta_m) \sim 8\gamma^3 S_0$, so the intrinsic luminosity appears enhanced by several orders of magnitude compared with the flux density, S_0 , if the source were at rest. For a typical value of $\gamma \sim 7$, $v \sim 7c$, $\theta_m \sim 8^\circ$, and $P(\theta_m) \sim 0.01$.

The idea of a relativistically moving source was first introduced by Rees in 1966 to avoid the inverse Compton catastrophe implied by the rapid flux variations. It seems that the model provided an obvious explanation of superluminal motion, but the model appears that it is not agree in the real observational process. As the picture the model of the relativistic jets means that a source O , on the one hand it radiation a radio ray with respect to the line of sight, on the other hand, a relativistic jet is moving with relativistic velocity v at an angle θ with respect to the line of sight. Then an observer will first receive a sign at point A , then receive another sign at point C . The distance between A and C is $\Delta r = vt \sin \theta$ and the time difference is $\Delta t = t(1 - \frac{v}{c} \cos \theta)$. So, an appearance speed is

$$v_{app} = \frac{\Delta r}{\Delta t} = \frac{v \sin \theta}{1 - \beta \cos \theta}.$$

As a sportsman ran the 100 meters with the shorter interval time his speed is the faster.

But, VLBI observation is that the distance between the two sub sources L_1 at the time t_1 , become L_2 at t_2 . Then the observational speed v_{ob} will be:

$$v_{ob} = \frac{L_2 - L_1}{(z + 1)(t_2 - t_1)}. \quad (6.7)$$

If ones use the model of the relativistic jets then have:

$$L_1 = vt_1 \sin \theta, \text{ and } L_2 = vt_2 \sin \theta, \quad (6.8)$$

so, the observational speed is:

$$v_{ob} = \frac{L_2 - L_1}{(1 + z)(t_2 - t_1)} = \frac{v \sin \theta}{z + 1}. \quad (6.9)$$

So, the relativistic jets model could not expound the superluminal motion.

6.1.4. Superluminal acceleration

3C273B was one of the first sources to be studied with VLBI and has been the subject of many subsequent observations. Changes in the visibility function were first observed in 1971. Although these observations were confined to single base line, it was immediately clear that

the changes could be explained by a simple expansion. The references (see Table 2) examined the visibilities function measured between 1970.83 ~ 1971.17, 1971.83 ~ 1976.46, 1972.33 ~ 1977.41 and 1977.56 ~ 1980.52, respectively, and found the apparent linear expansion rates between the double component of 3C273. However, it is very interesting that the expansion of 3C273 is an accelerated process (see Cao Shenglin & Liu Yongzhen, 1983).

Table 2. The apparent linear expansion rates of the quasar 3C273 at different epochs

Epoch t_0 (yr)	$\dot{\theta}$ '(mass yr ⁻¹)	v/c	References
1970.83 ~ 1971.17	0.23	3	Cohen et.al.,1971
1971.83 ~ 1976.41	0.32	4.2	Cohen et.al., 1977
1972.33 ~ 1977.41	0.43±0.04	5.2±0.5	Seieisted et.al.,1997
1977.56 ~ 1980.52	0.76±0.04	9.6±0.5	Pearson et.al., 1981

The superluminal acceleration was also directly observed by Biretta (see Biretta et.al., 1983) and Moore (Moore et.al.,1983) in 3C345.

We suggest that if the superluminal expansion is not apparent but is a real separation with superluminal-speed, then all observational data may be coincident with the predictions from the calculations given by (5.42) and (5.45).

To compare the observational data with the results given by calculation we must determine the parameters A (or v_{max}), M_g (or r_s), and $\dot{\theta}$ previously. The determination of A , r_s and $\dot{\theta}$ may use the following methods:

1. Determine the v_{max} , and a point r_i and its corresponding velocity v_i ;
- 2 Determine two points r_i and r_j and also determine the corresponding velocities v_i and v_j from measurement;
- 3 For non-radial expansion, determine r_m , then $r_s=r_m/1.5$.

After determining the parameters A , r_s , and $\dot{\theta}$, we may obtain the theoretical $r - t$ (or $r - \theta$ for the non-radial case) curves and compare it to observations.

Whether our suggestion is true or not will be tested by observation. All scientific ideas become valid and of worth only when calculated and measured numerical values agree.

6.1.5. Data and Fitting

To compare the observational data with the results given by the theoretical calculation, let $H_0=80$ km/sec.Mpc.

The quasar 3C345 ($z = 0.595$)

The quasar 3C345 was observed with VLBI networks at frequencies of 10.7 GHz and 22 GHz. It was made at four epochs between 1981.1 and 1983.1 at 10.7 GHz. Hybrid maps were made for all except the third epoch (see Biretta et al., 1983). It was made at three different epochs: 1981.25, and 1983.09 at 22 GHz. These data directly show a non-radial superluminal acceleration for a new jet component C_4 relative to D in 3C345. These data are tabulated in Table 3.

Epoch	1981.10	1982.10	1982.86	1983.10	1981.25	1982.42	1983.09
Radius(mas)	0.32±0.04	0.35±0.02	0.49±0.06	0.53±0.02	0.37±0.02	0.45±0.04	0.61±0.04
PA(deg)	- 132±6.0	- 115±2.0	- 97±6.00	- 94±4.0	- 128±8	- 103±3	- 93±2.5
$R_{ob}(ly)$	5.5±0.7	6.1±0.40	8.5±1.10	9.2±0.4	6.4±0.4	7.8±0.60	10.6±0.7
$\dot{\theta}'(r)(deg/yr)$	17±8.0		23.7±10	12.5±20	21.4±9		14.7±8
$\Theta(A,r_s,B,r)$	- 131	- 113	- 99	- 96	- 114	- 103	- 95
Frequencies	10.7 GHz				22 GHz		
References	Biretta et al.,1983				Moore et al.,1983		

Table 3. Data of the angular size and the position angle(PA) of quasar 3C345 at different epochs

It has been estimated by the observed data in Table 3, when $r=r_m=7.5 ly$ really has a maximum. Then, we get $r_s= 5 ly$ (or $M_g= 1.67 \times 10^{-13} M_{\odot}$). Then, let $B = 60$, $A = 499$ from (5.33) and (5.45) get

$$\dot{\theta} = \frac{60}{r^2} \left(1 - \frac{5}{r} \right), \quad (6.10)$$

$$\theta - \theta_0 = 1.0742 sn^{-1} \left(0.7739 \sqrt{\frac{r - 5.314}{r - 2.175}}, 0.7274 \right), \quad (6.11)$$

respectively. Equation (6.11) is a hyperbola.

Figures 6.1 and 6.2 give the theoretical curves (6.10) and (6.11), and correspond to their observed data respectively. It shows that the observations exactly correspond with the theoretical curve for all except 1982.42 epoch(at 22 GHz).

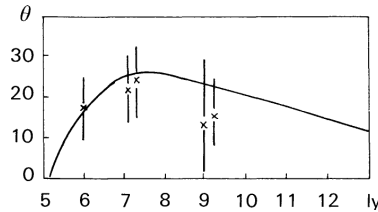

Fig. 6.1. θ - r diagram of sub source C_4 in 3C345

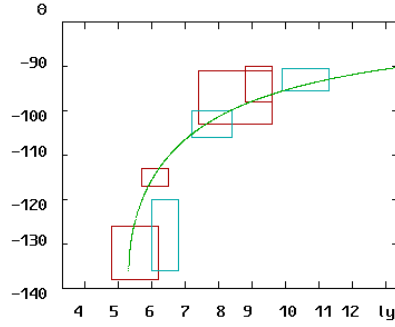

Fig. 6.2. θ - r diagram of the sub source C_4 in 3C345.

It is very interesting that if $r_s=5$ ly and let $A=48$ and 143 , from (5.42), we get three theoretical curves. They correspond with the observed data of C_1 , C_2 , and C_3 , respectively (see Shaffer et al.,1977; Schraml et al., 1981; and Cohen et al.,1983). These three sub sources made only radial expansion. They are shown in Figure 6.3.

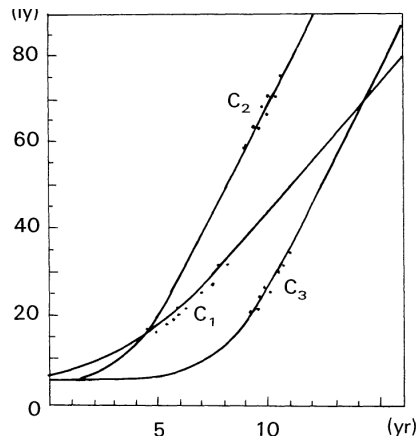

Fig. 6.3 ‘Size’ of the sub sources C_1 , C_2 , and C_3 in 3C345 ‘.’ The data of the observations—the theoretical curves; $C_1:t - t_0 = F(48,5,r)$; C_2 and $C_3: t - t_0 = F(143,5,r)$.

The quasar 3C273 ($z = 0.158$)

We took data of the angular size of 3C273 at different epochs. These data are tabulated in Table 4.

Table 4. Data of the angular size of quasar 3C273 at different epochs

Epoch (yr)	Frequency (GHz)	θ (mass)	r (yr)	Δt_k^a (yr)	F^b (yr)	References
1970.83	7.89	1.28 ± 0.02	9.6 ± 0.15	0.00	0.00	[1]
1971.17	7.89	1.45 ± 0.03	10.9 ± 0.23	0.29	0.56	[1]
1972.33	10.7	1.74 ± 0.24	13.1 ± 1.8	1.30	1.26	[2]
1972.82	10.7	2.08 ± 0.26	15.6 ± 2.0	1.72	1.88	[2]
1973.21	10.7	2.24 ± 0.23	16.8 ± 1.7	2.06	2.14	[2]
1974.50	10.7	2.70 ± 0.35	20.3 ± 2.6	3.17	2.82	[2]
1975.40	10.7	3.71 ± 0.48	27.8 ± 6.3	3.95	4.06	[2]
1976.38	10.7	4.13 ± 0.36	31.0 ± 0.48	4.76	4.56	[2]
1977.56	10.7	5.64 ± 0.12	42.3 ± 1.0	5.81	6.10	[3]
1978.24	10.7	6.19 ± 0.12	46.4 ± 1.0	6.40	6.65	[3]

1979.44	10.7	7.01±0.12	52.6±1.0	7.44	7.44	[3]
1980.52	10.7	8.01±0.12	60.1±1.0	8.37	8.38	[3]

a. $\Delta t_k = (t_{ob} - 1970.83)/(1+z)$, b. $F = F(90, 6.25, r) - F(90, 6.25, 9.6)$

[1]Cohen et al.,1971, [2]Seielstad et al., 1971,[3]Pearson et al., 1981.

Let $A=90$, $r_s=6.25$ ly (so $M_g = 2.09 \times 10^{13} M_\odot$) in (5.42), we will get the theoretical curve (see F in Table 4) and plot in Figure 6.4, the dots are the observed data from Table 4. The deviation between them is smaller than the observation error (correlation coefficient $r = 0.998$, and residual $\sigma = 0.185$ yr).

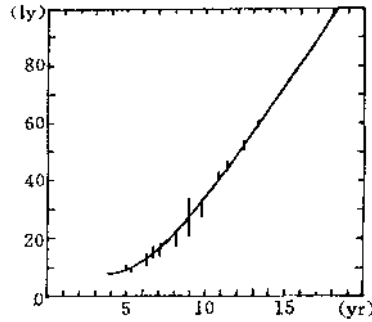

Fig. 6.4. ‘Size’ of 3C273

Seyfert galaxy 3C120 ($z = 0.033$)

We took data of the angular size of Seyfert galaxy 3C120 at different epochs. They are tabulated in Table 5, and plotted in Figure 6.5.

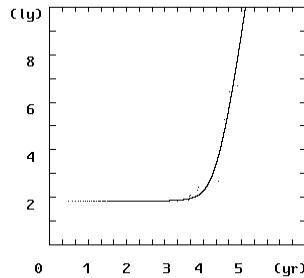

Fig. 6.5. ‘Size’ of 3C120

Let $A = 350$, $r_s = 1.830$ ly (or $M_g = 6.1 \times 10^{12} M_\odot$), we will get a theoretical curve. The observation data exactly correspond to the theoretical curve ($r=0.954$ and $\sigma=0.31$ yr).

Table 5. Data of the angular size of Seyfert 3C120 at different epochs

Epoch $T_{ob}(yr)$	Frequency (GHz)	Theta (mass)	r (ly)	Δt_k^a (yr)	F^b (yr)	References
1971.17	7.89	0.980	1.838	0.00	0.00	Shaffer et al.,1972
1972.44	7.89	0.984	1.845	1.23	0.66	Cohen et al.,1977 ^c
1972.84	7.89	0.988	1.853	1.65	1.04	Witteis et al.,1975
1973.17	7.89	1.004	1.883	1.94	1.60	Witteis et al.,1975
1973.21	7.89	1.100	2.063	1.97	2.24	Schilizzi et al.,1975
1973.25	7.89	1.112	2.085	2.01	2.27	Wittels et al.,1975

1973.42	7.89	1.230	2.306	2.18	2.45	Wittels et al.,1975
1973.46	7.89	1.300	2.438	2.22	2.52	Schilizzi et al.,1975
1974.00	7.89	2.500	4.688	2.74	2.93	Cohen et al.,1977 ^c
1974.17	7.89	2.800	5.250	2.90	2.99	Schilizzi et al.,1975
1974.30	7.89	3.430	6.431	3.03	3.10	Cohen et al.,1977 ^c
1974.50	7.89	3.560	6.675	3.22	3.13	Cohen et al.,1977 ^c

$$^a \Delta t_k = (t_{ob} - 1971.17)/(1+z). \quad ^b F = F(350, 1.830, r) - F(350, 1.830, 1.838).$$

^cThese data were obtained from Figure 5 of this paper.

NRAO 140 ($z = 1.258$)

Marscher and Broderick (1982) wrote that “We have obtained further VLBI observations of NRAO 140 at 2.8 cm in February 1981.... We find that these changes are modeled (both by hybrid mapping and by model fitting) very well by an increase in the separation of the compact components by 0.09 to 0.16 mas, which corresponds to an angular separation rate of 0.08 to 0.14 mas yr⁻¹” from which we may get $r_1=2.06$ ly, $v(r_1)=4.13$ and $r_2=3.66$ ly, $v(r_2)=7.23$, then we can determine its Schwarzschild radius and limit velocity. With equation (5.42) we obtain $r_s= 1.53$ ly, or equivalently $M_g=5.1 \times 10^{12} M_\odot$ and v_{max} may find from the maximum rate of angular

expansion which is 0.23 mas yr⁻¹, or $v_{max}=12$.

So, we had estimated the masses of the central gravitational objects by these fittings between observations and the calculations. Table 6 gives these estimated masses.

Table 6. Estimated masses of four objects

Name	3C273	3C120	3C345	NRAO140
$M_g(10^{12} M_\odot)$	20.9	4.44	16.7	5.10

7 The Evolution of the Universe on the Finsler Space-time

7.1. Introduction

The problems of singularity, horizon, and flatness are of a fundamental nature in standard cosmology. This somewhat restrictive nature of the early universe situation was first pointed out by Dicke and Peebles, but was highlighted in the context of GUTs by A. Guth (1981). Guth's resolution of these problems is through the 'inflationary universe'. Its basic idea is that there was an epoch when vacuum energy was the dominant component of the energy density of the universe, so that the scale factor grew exponentially. The new inflationary scenario was proposed by Linde (1982). In order to understand the Planck epoch and answer the simplest cosmological questions, one can ask 'How did the universe begin?'. Hawking (Hartle and Hawking, 1983) adopted what was called the Euclidean approach to quantum gravity. In that one performed a path integral over Euclidean i.e., positive definite

metrics rather than over metrics with Lorentzian signature (- +++) and then analytically continued the result to the Lorentzian regime.

From these ideas one could get some simple models for evolution of the early or very early universe. But, there are several problems:

1. There is not directly natural connection between the creation of the universe and the inflation.

2. GUTs themselves have not been confirmed in the particle physics.

3. In the wave function of the universe the space-time transforms from a positive definite metrics (+ + + +) to the Lorentzian regime (- + + +), it means that space is more natural than time.

It shall be shown that the creation of space-time and the inflation could be attributed to the geometric feature of the two evolutionary processes of the universe are a natural array and the time and the space have equal rights in this model.

Ya. B. Zel'dovich (1970) proposed an explanation of the formation of clusters of dust like material that is mathematically equivalent to the analysis of the formation of singularities of caustics. So, the formation and the large-scale distribution of the galaxies could be discussed by the theory of the singularities and bifurcation of caustics in the 3-dimensional space.

7.2. The Cosmological Implications of the Finsler Space-time

We assume that the metric of the space-time has the form

$$ds = \sqrt[4]{dT^4 + dX^4 + dY^4 + dZ^4 + 2hdY^2dZ^2 - 2hdT^2dX^2}. \quad (7.1)$$

For convenience, let us consider only the 2-dimensional case, and let

$$ds = \sqrt[4]{dT^4 + dR^4 - 2hdT^2dR^2}, \quad 0 \leq h \leq 1. \quad (7.2)$$

It is a type of the double cusp catastrophe, and has a different catastrophe feature when h takes different values. Now, we will discuss its cosmological implications.

7.3. The Creation of Space-time

First of all, let $h=0$, then

$$ds = \sqrt[4]{dT^4 + dR^4}. \quad (7.3)$$

According to the catastrophe theory, germ X^4+R^4 is compact. As the catastrophe theory, Compact germs play an important role, because any perturbation of compact germ has a minimum; therefore if minima represent the stable equilibria of some system, then for each point of the unfolding space

there exists a stable state of the system. On the other hand, the equation $T^4+R^4=0$ has zero real roots, so nothing will be observable in the space-time manifold, $M(T,R)=T^4+R^4$. But, $M(T,R)$

has evolution, and like the catastrophe theory, and it will be divided into four parts by different values of the stability matrix $H(T,R)$:

$$H(T, R) = \begin{vmatrix} 12T^2 & 0 \\ 0 & 12R^2 \end{vmatrix} = 144T^2R^2 \quad (7.4)$$

and

$$\begin{aligned} T^2R^2 < 0, & \text{ the seed of the time,} \\ T^2R^2 > 0, & \text{ the seed of the space,} \\ T^2R^2 = 0, & \text{ the catastrophe set,} \\ T = R = 0, & \text{ the origin.} \end{aligned} \quad (7.5)$$

Here, it shows that the creation of space-time has two natures on the Finsler space-time $ds^4 = dT^4 + dR^4$. On the one hand, the space and the time are created together, on the other hand, the space will be a stable state but the time will be an unstable state of the space-time manifold. So, ones could say that the space is a representation for the constant nature of materiality, and the time is a representation for the indeterminate variable nature of materiality.

7.4. The Inflation of the Universe

The metric of the space-time has the form after the creation of space-time

$$ds = \sqrt[4]{dT^4 + dR^4 - 2hdT^2dR^2}, \quad 0 < h < 1. \quad (7.6)$$

It is a type of the double cusp catastrophe too, and can describe the inflation of the universe. According to the four real roots of the stability matrix $H(T,R,h)$ the space-time manifold, $M(T,R)$, could be divided into nine parts.

7.5. The Geometry of Binary Quartic Forms

We consider now the general quartic form in two variables, which for algebraic convenience we take in the form

$$f(x, y) = ax^4 + 4bx^3y + 6cx^2y^2 + 4dxy^3 + ey^4 \quad (7.7)$$

for $(a,b,c,d,e) \in \mathbb{R}^5$ (In the old textbooks this form is called 'with binomial coefficients'.)

Let $G=GL_2(\mathbb{R})$, the natural left action of G on the variables induces a right action of G on

\mathbb{R}^5 , as follows: If f corresponds to the form (7.7), $g \in G$, and $v = \begin{pmatrix} x \\ y \end{pmatrix}$, then

$$(fg)v = f(gv). \quad (7.8)$$

What this means is that we change variables by g , expand the result, and collect up according to the terms in x^4, x^3y, \dots , etc. to get a new quartic form.

A polynomial p in (a,b,c,d,e) is said to be an invariant if

$$p(fg) = p(f) \cdot (\det g)^k$$

for a fixed positive integer k , where $\det g$ is the determinant of g . The integer k is the weight of the invariant. If p is a rational or algebraic invariants: k need no longer be a positive integer. Of especial importance are the absolute invariants for which $k=0$. The reason is that these are constant along G -orbits, so give us information on where the orbits lie.

The quartic form (7.7) has two basic invariants

$$\begin{aligned} S &= ae - 4bd + 3c^2 \\ T &= ace + 2bcd - ad^2 - b^2c - c^3 \end{aligned} \quad (7.9)$$

of weights 4,6 respectively. They are basic in the sense that every invariant can be expressed as a polynomial in S and T . For example the discriminant of (7.7) is the invariant

$$\Delta = S^3 - 27T^2 \quad (7.10)$$

of weight 12.

In terms of the complex variable

$$z=x+iy$$

the action of Γ is given by

$$zg_{\theta} = e^{i\theta}z. \quad (7.11)$$

Then, the form (7.7) can be expressed uniquely as

$$f(x, y) = \operatorname{Re}(\alpha z^4 + \beta z^3 \bar{z} + \gamma z^2 \bar{z}^2) \quad (7.12)$$

for $\alpha, \beta \in \mathbb{C}, \gamma \in \mathbb{R}$.

We could get explicit formulae for the change of coordinates from (a, b, c, d, e) to (α, β, γ) :

$$\begin{aligned} a &= \alpha_R + \beta_R + \gamma \\ b &= \alpha_I + \frac{1}{2}\beta_I \quad d = -\alpha_I + \frac{1}{2}\beta_I \\ c &= -\alpha_R + \frac{1}{3}\gamma \quad c = \alpha_R - \beta_R + \gamma \end{aligned} \quad (7.13)$$

$$\begin{aligned} \alpha_R &= \frac{1}{8}(a - 6c + e) \quad \alpha_I = \frac{1}{2}(b - d) \\ \beta_R &= \frac{1}{2}(a - e) \quad \beta_I = b + d \\ \gamma &= \frac{3}{8}(a + 2c + e) \end{aligned} \quad (7.14)$$

where $\alpha = \alpha_R + i\alpha_I, \beta = \beta_R + i\beta_I$, with $\alpha_R, \alpha_I, \beta_R, \beta_I \in \mathbb{R}$.

We could study the real algebraic set V in \mathbb{R}^5 given by

$$0 = \Delta = S^3 - 27T^2 \quad (7.15)$$

V is a cone with vertex the origin.

S^4 is the unit sphere in $\mathbb{R}^5 = \mathbb{C}^2 \times \mathbb{R}$ given by

$$|\alpha|^2 + |\beta|^2 + \gamma^2 = 1 \quad (7.16)$$

$$W = V \cap S^4$$

The Γ -action on $\mathbb{C}^2 \times \mathbb{R}$ is given by

$$(\alpha, \beta, \gamma) g_\theta = (e^{4i\theta} \alpha, e^{2i\theta} \beta, \gamma).$$

Hence, Γ -acts orthogonally, rotating the α -plane 4 times, the β -plane twice, and fixing γ .

We let P be the projection of W from the origin into the cylinder $K=S^1 \times R^3$ given by $\alpha=1$. The 2-sphere S^2 in S^4 given by

$$\alpha=0, |\beta|^2 + \gamma^2 = 1,$$

which the projection 'blows up' to infinity. We let

$$W_\infty = W \cap S^2, \quad W_1 = W - W_\infty.$$

Then W_1 is diffeomorphic to P , so we must describe P , W_∞ , and how the two fit together.

The cylinder K is invariant under Γ . We let H be the subset of K for which $\alpha=1$. Then $K=S^1 \times H$, where S^1 is the circle $|\alpha|=1, \beta=\gamma=0$. The group Γ acts by rotating S^1 four times, rotating the β -plane twice, and fixing the hyper planes $\gamma=\text{constant}$. Thus P is the orbit of $Q=P \cap H$ under Γ . In fact we need consider only the first half of Γ , where $0 \leq \theta \leq \pi$. This rotates once around S^1 and gives the β -plane in H a half-twist.

The set Q decomposes into a subset Q' , corresponding to coincident real roots of f , and a tiny extra piece corresponding to equal complex roots.

Q' is given parametrically by

$$\beta = \frac{1}{2} \left(-3 e^{i\varphi} + e^{-3i\varphi} - 2\gamma e^{-i\varphi} \right) \quad (7.17)$$

where φ is a parameter, $0 \leq \varphi < 2\pi$.

The equation (7.17) yields 'almost all' of Q .

When $\gamma=0$, (7.17) become

$$\beta = \frac{1}{2} \left(-3 e^{i\varphi} + e^{-3i\varphi} \right) \quad (7.18)$$

it represents the motion of a point obtained by superimposing an anticlockwise rotation in a circle of radius 3/2 and a clockwise rotation at three times the speed in a circle of radius 1/2.

For each γ_1 , the curve Q_γ is the locus of a point lying distance γ along the normal to the hypocycloid Q_0 , where γ is measured away from the origin at $\beta = -1$.

The evolute Q' of Q_0 is another 4-cusped hypocycloid, whose cusps lie at $\beta = \pm 4, \pm 4i$, and which passes through the four cusp points of Q_0 .

As γ increases from 0 to 1 the cusps move outwards in pairs along the evolute. As γ from 1 the point of tangency splits into two points of self-intersection on the real β -axis, which move outwards from the origin as the cusp-points and a self-intersection merge at swallowtail points (where $\beta = \pm 4$). For $\gamma > 3$ the curve Q_γ is a smooth oval, becoming more nearly circular as $\gamma \rightarrow \infty$, and with diameter asymptotic to 2γ .

There is a local diffeomorphism from H to R^3 which maps a neighborhood of $(4,0,3)$ to a neighborhood of $(0,0,0)$, and within those neighborhoods maps Q' to the bifurcation set of the

swallowtail catastrophe.

A point $(1, \beta, \gamma) \in H$ corresponds to a quartic with two equal pairs of roots if and only if either

(i) $\beta_R=0, \beta_I^2= - 8\gamma - 8,$

(ii) $\beta_I=0, \beta_R^2=8\gamma - 8.$

In case (i) the roots are real if $|\beta_I| \leq 4$, complex if $|\beta_I| > 4$. In case (ii) the roots are real if $|\beta_R| \leq 4$, complex if $|\beta_R| > 4$.

Q' is semi algebraic, whereas Q is algebraic. This presence of absence of whiskers is a common phenomenon in real algebraic geometry.

Table 6. The set of non-degenerate quartic forms in two variables has four connected components and the set of degenerate quartics divides into 12 G -orbits in open in R^5 .

type	representative	codim.	Region
4 real roots	$x^4 - 6x^2y^2 + y^4$	0	inside the tetrahedron
2 real roots, 2 complex	$x^4 - y^4$	0	outside both tetrahedron and bowls
0 real roots, positive definite	$x^4 + y^4$	0	inside the top bowl
0 real roots, negative definite	$x^4 - y^4$	0	inside the bottom bowl
2 equal real, 2 real positive	$x^2(x^2 - y^2)$	1	the two faces of the tetrahedron which have an edge in common with the top bowl
2 equal real, 2 real negative	$-x^2(x^2 - y^2)$	1	the two faces of the tetrahedron which have an edge in common with the lower bowl
2 equal real, 2 complex positive	$x^2(x^2 + y^2)$	1	the surface of the top bowl
2 equal real, 2 complex negative	$-x^2(x^2 + y^2)$	1	the surface of the lower bowl
3 equal real	x^2y	2	the cusp-lines forming four edges of the tetrahedron
2 pairs equal real positive	x^2y^2	2	the top line of self-intersection
2 pairs equal real negative	$-x^2y^2$	2	the lower line of self-intersection
2 pairs equal complex positive	$(x^2 + y^2)^2$	2	the top whiskers
2 pairs equal complex negative	$-(x^2 + y^2)^2$	2	the lower whiskers
4 equal real positive	x^4	3	the top two swallowtail points
4 equal real negative	$-x^4$	3	the bottom two swallowtail points
zero	0	5	this is not in Q : It is the vertex of the cone on

W

Conclusions

From the discussion in this paper, we could get the following conclusions:

(1) The special theory of relativity cannot negate the possibility of the existence of superluminal-speed.

(2) The essential nature of the superluminal-speed is the relativity of the temporal order. If one does not know how to distinguish the temporal orders, a particle moving with superluminal-speed could be taken for one moving with a subluminal-speed of some unusual nature.

(3) The special theory of relativity could be discussed in the Finsler space-time. The space-time transformation on the Finsler metric ds^4 contains a new symmetry between the time-like and space-like.

(4) Some new invariants describe the catastrophe nature of the Finsler space-time ds^4 . They obey the double-cusp catastrophe. The time-like state cannot change smoothly into the space-like state for a motion particle. But a light like state could change suddenly into a time-like state and space-like state. Also, a time-like state and a space-like state could change suddenly into a light like state.

(5) The length Δx will exchange the position with the time increment Δt between v 's representation and v 's representation. The momentum (or energy) in the time-like (or space-like) representation will be transformed into the energy (or momentum) in the space-like (or time-like) representation.

(6) The difference between the subluminal- and superluminal-speed would be described as follows: A particle with the subluminal-speed has positive momentum, energy, and moving mass, and a particle with the superluminal-speed has negative ones.

(7) Usually, it is believed that Tachyons have a space-like energy-momentum four-vector so that

$$E^2 < c^2 P^2 \quad (7.19)$$

Hence, the square of the rest mass m defined by

$$m^2 c^4 = E^2 - c^2 P^2 < 0. \quad (7.20)$$

requires the 'rest mass' to be imaginary' (see Hawking and Ellis, 1973).

As has been said in this paper, from the expressions (3.25) ~ (3.28) it is clear that, no matter whether a particle is moving with a subluminal- or superluminal-speed, in the time-like representation it will obey Equation (3.36), but, in the space-like representation it will obey Equation (3.37) (or (4.9) and (4.10)). So, for a particle with superluminal-speed its mass $M(v)$ (energy $E(v)$, and momentum $P(v)$) is negative rather than imaginary. As expression

(3.28)

$$E^S(v_1) = -mc^2 \quad (7.21)$$

when $\beta \rightarrow 0$.

So the particle with superluminal-speed, in the time-like representation, will remain a negative 'rest-mass'. We shall write:

$$E = \begin{cases} +mc^2 & \text{for subluminal-speed, i.e., } v < c \text{ (or } v_1 > c), \\ -mc^2 & \text{for superluminal-speed, i.e., } v > c \text{ (or } v_1 < c). \end{cases} \quad (7.22)$$

It was just analyzed by Dirac for the anti-particle. So, we guess that a particle with the superluminal-speed $v > c$ could be regarded as its anti-particle with the dual velocity $v_1 = c^2/v < c$.

(8) If we suppose that the usual space-time is the Finsler space $F(x,y)$, then space-time possesses a catastrophic nature. In particular, the space-like curves in the general theory of relativity will have some observational meaning.

(9) The model of relativistic jets could not to explain superluminal motion. But, the observed superluminal expansion by and large corresponds to the motion along the space-like curve in the Schwarzschild field. If so, we guess this expansion is a real motion with the superluminal-speeds; the results given by calculation coincide with observations very well.

(10) Under the same assumption, we may estimate the masses of central objects. The estimated values of these masses are in the range of $10^{12} \sim 10^{13} M_{\odot}$.

References

- [1] Arnold, V.I.:1986, Catastrophe Theory, Springer-Verlag, Berlin.
- [2] Asanov, G.S.: 1985, Finsler Geometry, Relativity and Gauge Theories, D.Reidel Publ.Co., Dordrecht, Holland.
- [3] Cao Shenglin:1988,Astrophys.Space Sci.145,299.
- [4] Cao Shenglin:1990,Astrophys.Space Sci.174,165.
- [5] Cao Shenglin:1992,Astrophys.Space Sci.190,303.
- [6] Cao Shenglin:1992b,Astrophys.Space Sci.193,123.
- [7] Cao Shenglin:1993,Astrophys.Space Sci.208,191.
- [8] Einstein, A.: 1923, in A.Sommerfeld(ed.), The Principle of Relativity, Dover ,New York.
- [9] Hawking, S.W. and Ellis, G.F.R.: 1973, The Large-Scale Structure of Space-Time, Cambridge University Press. Cambridge.
- [10] Recami, E.: 1986,Nuovo Cimento 9, 1.
- [11] Rindler,W.:1977, Essential Relativity, Springer-Verlag, Berlin.
- [12] Rund, H.:1959, Differential Geometry of Finsler Spaces, Springer-Verlag, Berlin.
- [13] Sen Gupta N.D.:1973,Indian J. Physics 47,385.
- [14] Zeeman, E.C.:1977, Catastrophe Theory, Selected Papers 1972 ~ 1977, Addison-Wesley.

About the Author: Cao Shenglin Professor of the Department of Astronomy, Beijing Normal University, Beijing, People's Republic of China. He was born in Chongqing, China, in June 1937. He worked on the Control Device Research Institute of the First Academy of China National Space Administration from 1959 to 1978. He has published over 80 papers in the fields of Gyroscope, QSOs, Cosmology, and the Relativistic Astrophysics.

New Explanation of Advance of Planetary Perihelion and Solar System's Vortex Motion

Fu Yuhua

(CNOOC Research Institute, E-mail:fuyh1945@sina.com)

Abstract: Although the explanation of general relativity for the advance of planetary perihelion is reasonably consistent with the observed data, because its orbit is not closed, whether or not it is consistent with the law of conservation of energy has not been verified. For this reason a new explanation is presented: The advance of planetary perihelion is the combined result of two motions. The first elliptical motion creates the perihelion, and the second vortex motion creates the advance of perihelion. In the motion of planet-sun system, under the action of gravity, the planetary orbit is a closed ellipse, and consistent with the law of conservation of energy. Meanwhile, the planet also participates in the vortex motion of solar system taking the sun as center; the long-term trend of the vortex is the further topic, but in the short-term may be considered that due to the inertia the planetary perihelion will run circular motion in vortex and lead to the advance of perihelion, thus also without acting against the law of conservation of energy. Based on the result of general relativity, the approximate angular velocity of advance of perihelion is given; based on accurate astronomical observation, the accurate angular velocity is given. Finally the approximate expression for circular velocity of solar system's vortex motion is presented. For ordinary vortex motion the circular velocity is inversely proportional to the radius r , but for solar system's vortex motion, it is inversely proportional to $r^{3/2}$.

Key words: Advance of planetary perihelion, new explanation, general relativity, angular velocity of advance, solar system's vortex motion

Introduction

Many scholars believe that general relativity does not end the studying for problem of advance of planetary perihelion, because there are many factors affecting the advance of planetary perihelion, it still needs to continue to study this issue. This paper presents a new explanation: The advance of planetary perihelion is the combined result of two motions. The first elliptical motion creates the perihelion, and the second vortex motion creates the advance of perihelion. Finally the approximate expression for circular velocity of solar system's vortex motion is presented. For ordinary vortex motion the circular velocity is inversely proportional to the radius r , but for solar system's vortex motion, it is inversely proportional to $r^{3/2}$.

1 Result of general relativity

According to general relativity, the value of advance of planetary perihelion reads ^[1]

$$\varepsilon = \frac{24\pi^3 a^2}{T^2 c^2 (1-e^2)} \quad (1)$$

where: c is the speed of light; T , a , and e are orbital period, semi-major axis and eccentricity respectively.

Although the explanation of general relativity for the advance of planetary perihelion is reasonably consistent with the observed data, because its orbit is not closed, whether or not it is consistent with the law of conservation of energy has not been verified. In fact, this verification is very difficult, so for many years it has been left without anybody to care for.

2 New explanation of combined motion

According to this new explanation, the advance of planetary perihelion is the combined result of two motions. The first elliptical motion creates the perihelion, and the second vortex motion creates the advance of perihelion.

In the first motion of planet-sun system, under the action of gravity, due to $F = GMm / r^2$, and without considering other factors such as the perturbation of other planets, the planetary orbit is a closed ellipse, and consistent with the law of conservation of energy.

Meanwhile, the planet also participates in the vortex motion of solar system taking the sun as center; the long-term trend of the vortex is the further topic, and we will not discuss it in this paper; but in the short-term may be considered that due to the inertia the planetary perihelion will run circular motion in vortex and lead to the advance of perihelion, thus also without acting against the law of conservation of energy.

In a word, the proposed new explanation of combined motion does not run counter to the law of conservation of energy from start to finish.

3 Angular velocity of advance of perihelion

According to Eq.(1), taking the sun as center, the angular velocity of advance of planetary perihelion is as follows

$$\omega = \frac{\varepsilon}{T} = \frac{24\pi^3 a^2}{T^3 c^2 (1-e^2)} \quad (2)$$

According to Kepler's third law, it gives

$$\frac{T^2}{a^3} = \frac{4\pi^2}{GM}$$

where: G is the gravitational constant, and M is the solar mass.

Then Eq. (2) can be rewritten as

$$\omega = \frac{3G^{3/2}M^{3/2}}{a^{5/2}c^2(1-e^2)} \quad (3)$$

According to this expression we can see that, the angular velocity of advance of planetary perihelion is inversely proportional to $a^{5/2}$, and the velocity of advance of planetary perihelion is inversely proportional to $a^{3/2}$.

For the results of Eq.(1), there are small differences compared with accurate astronomical observations, so we say that results of Eq.(2) and Eq.(3) are the approximate angular velocities of advance of perihelion based on the related results of general relativity.

If based on accurate astronomical observation, we can reach the accurate angular velocity of advance of perihelion as follows.

$$\omega' = \frac{\varepsilon'}{T}$$

where: ε' is the accurate astronomical observation of advance of perihelion.

Now the rotate transformation in Cartesian coordinate system is applied to derive the planetary orbit equation including the advance of perihelion.

In the planet-sun system, taking the solar center as the origin of coordinate, the planetary orbit equation reads

$$\frac{(x-k)^2}{a^2} + \frac{y^2}{b^2} = 1$$

where: k is the semi-focal length of ellipse.

According to the rotate transformation in Cartesian coordinate system, it gives

$$x = x' \cos \theta - y' \sin \theta$$

$$y = x' \sin \theta + y' \cos \theta$$

where: θ is the angle of rotation (namely the angle of advance), $\theta = \omega t$ or $\theta = \omega' t$.

Thus, after considering the vortex motion, the planetary rotation orbit equation is as follows

$$\frac{(x' \cos \theta - y' \sin \theta - k)^2}{a^2} + \frac{(x' \sin \theta + y' \cos \theta)^2}{b^2} = 1$$

4 The circular velocity of solar system's vortex motion

We already pointed out that, the reason for the advance of planetary perihelion is the vortex motion taking the sun as center. Now we discuss the circular velocity of this vortex motion at the position of radius r .

Assuming that the angular velocity of solar system's vortex motion is approximately equal to the angular velocity of advance of planetary perihelion, and in Eq.(3) the value of a is replaced by the radius r , moreover the eccentricity e is omitted, then apply the formula $v = r\omega$, it gives the circular velocity of this vortex motion at the position of radius r as follows

$$v \approx \frac{3G^{3/2}M^{3/2}}{r^{3/2}c^2} \quad (4)$$

From this expression we can see that, unlike the ordinary vortex motion (its circular velocity is inversely proportional to the radius r), for solar system's vortex motion, the circular velocity is inversely proportional to $r^{3/2}$.

Reference

- 1 A. Einstein, *Sitzungsber. Preuss. Akad. Wiss.* 1915, No.47, 831-839

RELATIVISTIC PROBLEMS IN THE UNITARY QUANTUM VIEW OF THE WORLD

Leo G. Sapogin

Department of Physics, Technical University (MADI)
64 Leningradsky pr., A-319, Moscow, 125319, Russia
Tel. 7-499-1550492 E-mail: sapogin@cnf.madi.ru

V. A. Dzhanibekov

Department of Cosmophysics, Tomsk State University,
36 Leninast., 634050, Tomsk, Russia.
Tel: +7-917-5300487, E-mail: vdzhan42@yandex.ru

Yu. A. Ryabov

Department of Mathematics, Technical University (MADI)
64 Leningradsky pr., A-319, 125319, Moscow, Russia
Tel. 7-499-1550326 E-mail: yuaryabov@gmail.com

Abstract: The present article discusses the problems of new unitary quantum view of the world in its applications to the different aspects of the reality. There are spectacular examples of the new Unitary Quantum world view considered in the applications for different aspects of reality.

Keywords: Unitary Quantum Theory, Standard Model, Quantum Electrodynamics, Maxwell Equations, Schrodinger Equation, Solid State Physics, Zone Theory, Semiconductors, Tunneling Effects, Spectrum Masses, Lorentz transformations.

Introduction

It seems that the majority of researches have absolutely forgotten the fact that one of the master-spirits of contemporary world, A. Einstein, till the end of his life had not adopted the standard quantum mechanics at all. Better to cite his well-known words: *“Great initial success of the quantum theory could not make me believe in a dice game being the basis of it...I do not believe this principal conception being an appropriate foundation for physics as a whole... Physicists think me an old fool, but I am convinced that the future development of physics will go in another direction than heretofore... I reject the main idea of modern statistical quantum theory... I’m quite sure that the existing statistical character of modern quantum theory should be ascribed to the fact that that theory operates with incomplete descriptions of physical systems only”*.A.Einstein (back translation).

At the first stage of quantum mechanics evolution in the frame of classical physics’

theory the mechanism of corpuscular-wave dualism was not discovered at all, as it was done later in the UQT (Sapogin,1979,1980,2011; Sapogin at all, 2003, 2005, 2008a). It's worth a surprise that the super abstract quantum ideology ad hoc designed by Niels Bohr was suitable in general for the description of quantum reality. An explorer did not contradict anything by strictly using new frequently paradoxical quantum rules, and any paradox could be removed by the simple prohibition of its analysis. Although many researches tried to solve these problems they were not successful. The outspoken interpretation of quantum theory had become out of any criticism. More over the determination of simulators describing one of the sides of quantum reality had been announced as the main target of quantum science, while the picture in figures and a-going had become simply an optional target.

Nevertheless one general philosophic problem had been remaining: the dual principles of the fundamental physics. There were particles – the points being the source of a field that could not be reduced to the field itself, the researches did not do their utmost, though. Introduction of this micro-particle had resulted in a wide range of different divergences - anybody knows that electric power of a point charge equals infinity. A lot of ideas had appeared, absolutely brilliant ideas from mathematical point of view, suitable for these appearing infinities abolishing. We can use as a cover the words of P.A.Dirac: *“...most physicists are completely satisfied with the existing situation. They consider relativistic quantum field theory and electrodynamics to be quite perfect theories and it is not necessary to be anxious about the situation. I should say that I do not like that at all, because according to such ‘perfect’ theory we have to neglect, without any reason, infinities that appear in the equations. It is just mathematical nonsense. Usually in mathematics the value can be rejected only in the case it were too small, but not because it is infinitely big and someone would like to get rid of it.”* Direction in Physics, New York, 1978(back translation).

The substantial success of the quantum mechanics (particularly in the stationary cases) was based on the simple correlation of de Broglie wave length and geometric properties of potential. Formally the particle was considered as a point; in other case it was difficult to add probability amplitude character to the wave function. But the point-character of a charge as well the principle of Complementarity did not allow to go ahead in the elementary particles structure and thus the further development of the quantum theory of the field in the frames of the assumed paradigm had resulted in total fiasco of the field quantum theory itself.

There is another concept in physics; it comes from W.Clifford, A.Einstein, E.Schrödinger and Louis de Broglie in which the particle is considered as a bunch (wave packet) of a certain unified field. The position of associates of the concept would be expressed the most clearly by the following words of A.Einstein: *“We could therefore regard matter as being constituted by the regions of space in which the field is extremely strong. A thrown stone is, from this point of view, a changing field in which the states of the greatest field intensity travel through space with the velocity of the stone... There is no place in this new kind of physics both for the field and the matter, for the Field is the only reality... and the laws of motion would automatically*

follow from the laws of field.” (back translation).By (M. Jemmer, 1961) definition if the particle is a wave packet, so this consideration is called unitary.

The first articles concerning this matter were published in (Sapogin,1973,1979,1980). The entire term unitary belongs to who has classified quantum waves' theories. The term unitary he correlated with the theories that represent particle as a wave packet. In Unique Quantum Theory a particle is described as a wave packet that in its movement is periodically spreading along the Metagalaxy and is gathering again. For such moving wave packet both the relativistic and the classical mechanics follow from these unitary quantum equations, probably the Maxwell equations and the gravitation follow from exact UQT equations (Sapogin at all,1984, 2005, 2008), but this has not been proved yet being the problem of the future. Nevertheless the UQT scalar equation (a telegraph type) in general makes it possible to obtain not only Schrödingerbut also Maxwell equations. But for this purpose for the derivation of the scalar unitary telegraph equation we should assume imaginary the resistance of derivation and shunt conductance that physically is not so clear.

The field of investigations of the Unified Unitary Quantum Theory (UUQT) is the most profound level of substance: the level of elementary particles and quantum effects.

As well known all particles have besides corpuscular properties wave properties too (particles can interfere with each other or with themselves), and their behavior is described by means of the wave function. In the case of a particle moved in the free space, the wave function is described as deBroglieplanewave which wavelength is inverse to the momentum of the particle. If the particle is slowing down or accelerating by applied fields then its wavelength is increasing or decreasing, respectively. The wave itself has no physical interpretation, but the squared value of its amplitude is proportional to the probability to find the particle in a defined place. That is why these waves are also called “waves of probability” or “waves of knowledge”, etc.

There is another problem: the particle has no exact value for coordinate and for momentum at the same time, although either value could be measured arbitrarily closely (uncertainty relation). That is why the definition of trajectory of a quantum particle has no sense.

As opposed to the laws of the classical physics with its determinism where one can predict results of the motion of separate particles, in the quantum theory one can only predict the probability of the behavior of separate particles. Even the nature does not know the way a particle goes by in the case of diffraction by two slits.

But it is not the most depressing. The Quantum Physics has wave-corpucle dualism as well as field dualism and matter dualism. All particles act as sources of field, but it appears that they are only points which have no relation to these fields, and one can't tell anything in concrete about them.

Let us continue to confuse the reader. We shall consider an extremely simple experiment with single particles in the terms of the modern quantum theory. It will allow us to understand what is going on and will be useful for us in the future.

Let single photons fall on a semitransparent mirror directed at the angle of 45 degrees to their stream. Semitransparent means that a half of the falling light is reflected and another one passes by. Photon counters are installed on the paths of reflected and passed rays – Fig. 1. In the terms of the wave theory everything is simple: an incident wave will be reflected and will be passed partially. But particles as they are indivisible have to be reflected or be passed by. If a counter of reflected beam's particles registers an event it's evidently to suppose that the second counter will register nothing. It is easy to see that if one will re-unite passed and reflected beams and sends them to the screen then...it's all about the way how we are going to argue. From the wave theory there will be an interference pattern, but from the corpuscular theory it will not occur. In fact, an interference pattern is observed in experiments even for single photons, and our suppositions are wrong to say the least. **In order to spare the doubts about how is it possible, it is better to forbid one to think about it.** And the principle of complementarity in the modern physics does it in any case. It allows to ask only the questions for which it's possible to give an answer by experimentally only. When one tries to find a particle it means that one rejects to observe the interference pattern and vice versa. As though we could know from experiment either a particle has passed by or has been reflected, we would realize the “real particle behavior”. But it's impossible to do by the means of macro-instruments.

The principle of complementarity makes the quantum physics descriptively inaccessible. *“There are many experiments, that we just cannot explain without considering the wave function as a wave that influences on the whole region and not as particles appearing “may be here, may be there”, as it is possible in the terms of the clearly probabilistic point of view”*(E.Schrödinger). In other words a wave acts in the whole area simultaneously, not *“may be here, may be there”*, otherwise there wouldn't be any diffraction or interference.

Eventually we have to admit that the prohibitions of the principle of complementarity respond to the weakness philosophy, and the role of this principle is obviously analogous to the role of a calorie, a phlogiston and other obsolete concepts.

Unified field theory approach

Let us ask the questions that are forbidden by the principle of complementarity. What is the wave of an electron? What is the behavior of an electron “indeed, when nobody looks at it?” (its natural behavior?) How does it manage to go through a potential barrier when its energy is less than the barrier height (tunneling effect)? How does it, as it is indivisible, go simultaneously by two slits which are divided by a great distance in comparison with its own size? How is an atom of hydrogen constructed at the lowest energy state (s-state)? How can the probabilistic consideration of a wave function result from the mathematical formalism of the theory? Why is the actual Quantum Mechanics reversible? This is a primary law, and the irreversibility has to follow from it for dispose the paradoxes in the statistical mechanics. Last but not least: how is the electron itself constructed, that point described in the terms of probability? This is a huge complex of mysteries. All (or almost all) physicists resigned and even prefers not to speak about it. But there is also someone who does speak. Paul Langevin even called the formalism of Quantum Mechanics with its principle of complementarity the “*intellectual debauch*”.

E. Schrödinger wrote that he “*was happy for three months*” when he had got the idea to consider the particle as the packet (bunch) of de Broglie waves – until the English mathematician Darwin proved that the packet would spread and vanish. But the trouble of all of these attempts (E. Schrödinger, Louis de Broglie, etc) was the fact that they always tried to construct it by means of de Broglie waves with such dispersion that any wave packet has to spread. The including of nonlinearity (Louis de Broglie) just extremely complicated the problem but didn’t solve it.

Unified Unitary Quantum Theory Interpretation

The critical feature of the Unified Unitary Quantum Theory (UUQT) is the fact that it describes the particle as a bunch (packet) of certain unified field, but not as a questionable structure of the de Broglie waves of probability.

For “spying upon” for what the particles do which we consider as very small bunch of the real field, let us consider a Hypothetic Observer (HO) which is able to measure the parameters of fields of tracing particles with the hypothetic microprobe, and dimensions of microprobe are much less than the dimensions of the particles. The result of these measurements will be a certain structure function that describes bunch of the real field. Obviously, this hypothetic HO and microprobe couldn’t exist, but our thought experiments will be as simple as possible.

If we choose the dispersion of these partial waves equal to linear, we could have an extremely curious process, which mathematical formulation never appears before. If we have dispersion, then harmonic components of partial waves propagated with different velocities will result in spreading of the wave packet over all space or over all Metagalaxy.

Mathematical investigations show that the spreading goes on without any changes of the form of the wave packet; but at the end, there is a moment when a wave packet vanishes at all. Where does its energy disappear to? It remains in the form of harmonic components that set up a certain background in any point in the space. As these waves are not damped and continue to propagate with velocity of their own, then afterawhile the wave packet begins to revive in another point, but its sign will be changed at that. During the motion, the packet will appear and disappear periodically – Fig. 2.

The envelope of this process is locus of points, locus of points of its maximum, it is a sinusoidal quantity and it rests in all reference frames; in other words, its phase velocity is equal zero in *any* reference frame, i.e. it's relativistically invariant (only by means of it the results of the relativistic dynamics are absolutely correct). If we change a reference frame, we will receive a different value of wavelength of the envelope, but it will be motionless as well. As the computing shows the wavelength of the envelope is exactly equal to de Broglie wavelength, and the dependence of this wavelength on packet velocity is the same! As you see, all the Unified Unitary Quantum Theory is occupied with the resolute exploiting of this basic idea.

It should be stressed that this periodical appearing and disappearing of particles doesn't refer to the Quantum Mechanics, as an immovable packet doesn't oscillate. The requirement of the relativistic invariance, that would be the main requirement for any theory, specifies the idea further. It states the following: when “Lord has excited in space continuum wave packet with his finger and then he has taken it away”, then the packet will go on oscillating as a membrane or a string after impact. The frequency of these free oscillations is very high: it is proportional to the rest energy of the particle and it is equal to the frequency of the so called Schrödinger's trembling (“zitter-bewegung”)

$$\omega_s = \frac{mc^2}{\hbar\gamma}, \gamma = \frac{1}{\sqrt{1-v^2/c^2}}$$

Within the motion there arising de Broglie vibrations with frequency $\omega_B = \frac{mv^2}{\hbar\gamma}$ due to dispersion. At small energies $\omega_f \gg \omega_B$ and in the presence of quick own oscillations have no influence on experiment and all quantum phenomena result from de Broglie oscillations. The value of frequency ω_B tends to ω_f with growth of energy and resonance phenomenon appears that result in oscillating amplitude increase and in mass growth. **Thus the well-known graph of particle mass dependence on the velocity Fig.3 approaching to light's velocity constitutes actually a half of usual resonance curve for forced oscillation of harmonic oscillator if energy dissipation is absent.** In the case when $v \rightarrow c$, frequency $\omega_B \rightarrow \omega_f$ (frequency resonance), $\gamma \rightarrow 0$ beats appear with difference frequency

$$\omega_d = \omega_f - \omega_B \approx \frac{mc^2\gamma}{\hbar},$$

and particle will obtain absolutely new low-frequency envelop with wave length

$$\Lambda = \frac{\hbar}{mc\gamma}.$$

This is a new wave. In ultra-relativistic limit case the value of Λ becomes much greater as typical dimension of quantum system it (new wave) interacts with. Now the length of new wave grows with energy contrary to de Broglie wave length slowly decreasing, and particle requires the form of quasi-stationary wave packet moving in accordance with classical laws.

That explains the success of hydrodynamics fluid theory concerning with numerous particle birth when the packet having extremely big amplitude is able to split into series of packets with smaller amplitudes. But such splitting processes characterize not only high-energy particles. Something like this takes place at small energies also, but overwhelming majority of arising wave packets are under the barrier and so will not be detected. It would be perfect to examine by experiments at future accelerators the appearance of such new wave with the length growing together with energy. (Sapogin, 1979, 1980, 2010, 2011; Sapogin at all, 2003, 2005, 2008).

If the HO places at the way of motion of the wave packet quite a number of his microprobes, then due to the dispersion spreading's and rebuilding's he can observe the envelope of this process, and all of this will not be at variance to the general

Quantum Mechanics, as this envelope corresponds with the wave function.

This figure, a sinusoidal envelope with a regular shape, can be seen by the HO in the only case: if the only single particle would exist in the world. But the real world consists of an enormous number of particles moving each other with different velocities. The partial waves (harmonic components) of those particles which have vanished at this moment can be summarized and emerge real fluctuations of the field or in other words the vacuum fluctuations that will act in a random manner. These fluctuations could destroy all idyllic character of measurements of our HO (Hypothetic Observer) for single particle in Universe– the sinusoidal envelope will be distorted by vacuum fluctuations and it will be difficult to separate it clearly.

Any wave packet that is described in the terms of the “becoming” structural function could be decomposed by means of Fourier transforming into plane sinusoidal (partial) waves. These waves are infinitely many, and their amplitude is infinitesimal. If we summarize them it will emerge zero everywhere except of the area occupied by the structure function. Thus the structure function could be represented either as a function of time (time representation) or as a function of an amplitude of harmonic components related to frequency (spectral representation). It is absolutely equivalent to mathematical representations.

Now there is no necessity in the principle of complementarity that was a very convenient view ad hoc. It is easy and clear how the synthesis of corpuscular and wave properties is realized. Corpuscular properties occur due to the localization of a wave packet in a small spatial region. The wave properties of the de Broglie waves can be explained in the following way: when the wave packet approaches to the diffraction system (for example Young’s experiment with two slits) then we have an ordinary diffraction of partial waves by splites, and the diffraction pattern of partial waves appears at the screen. HO could observe it with his microprobes. As these packets are not overlapped then everything is linear and the superposition of the partial waves creates a total diffraction pattern modulated by the de Broglie wave, although the plain de Broglie wave doesn’t exist at all. It should be stressed that de Broglie wave is a packet’s locus of points of maximum in his motion, and it is a superposition of partial waves, that is why it appears in any diffraction and interference experiment.

Quantum measurements

Let us try to consider real instruments, which are always macroscopic. Atomic nuclei and electron shells are situated very near to each other and form a very numerous, but

discrete series. A transition from the one such a state to another is a quantum jump. **That is why the absorption and emitting of energy between the atomic systems is carried out by means of the quanta.**

However, it doesn't mean that in the motion process the quantum or the particle propagates as something constant and indivisible. The energy of the particle can be divided or changed by vacuum fluctuations. The wave packet of a photon, for example, can, in the issue of the overlapping of vacuum fluctuation, turn into meson at short time, and photon can "disguise" oneself as a proton or as a neutron. It's assumed in the ordinary quantum field theory that a proton has "an atmosphere" mesons; it follows from the interpretation of the results of its collisions with another particles. There is no mesons atmosphere indeed. A proton appears and disappears during its motion constantly at the de Broglie wavelength, and its mass changes periodically from the double value of a proton's mass to zero, taken on the intermediate values of mesons masses.

Eventually, all of the quantum measurements are based on energy absorption and present inconvertible processes(Sapogin, 1979, 1980). For every instrument founded a particle will operate, a quantum of energy is needed at least, thus it is a threshold energy of instrument defining its responsivity. By the way, we would like to notice that our HO (Hypothetic Observer) uses the instruments with zero threshold energy that is why it can register even vacuum fluctuations.

Let us consider the process of interaction of a particle with a macro-instrument (Sapogin, 1982ab). As the particle is a wave packet then its energy is proportional to the intensity of the packet, but it can be changed because of periodic spreading's and appearances. Besides the packet itself can be divided during the interactions. For macro-instrument could register a particle it has to wait for a moment when the total energy of the particle and of the fluctuation of the atom would be more or equal to threshold energy. It is clear that the probability of the operation of the apparatus will be proportional to the amplitude of the wave packet, or more exactly, to the value of intensity of the envelope of the wave function. If the wave packet with a too low intensity in comparison with threshold energy of the macro-instrument approaches to the macro-instrument, the great fluctuation of vacuum is required, but the probability of such an event is too small, and it means that the probability to detect the particle is small too (Fig. 4).

The theory of the quantum measurements is developed in the Unified Unitary Quantum Theory (UUQT), and the statistical interpretation follows now from the theory, but not just postulated, as it was before in the conventional quantum theory.

This point of view requires automatically that the value of the dispersion of vacuum fluctuations is finite that, in another turn, requires the finiteness of the Universe.

Unitary quantum illustrations

The uncertainty relation arises because energy and impact are not constants, but they periodically change because of the dispersion disappearance and appearance of the particle(Sapogin at all, 2003,2005,2008a). Besides because of statistical laws of measurements with macro-instruments, there is no any way to measure anything accurately, because of the unpredictable fluctuations of the vacuum. HO (Hypothetic Observer) could predict the coordinate, the momentum or the energy of the packet, if he would be the only one in the Universe, i.e. in the case of absence of the vacuum fluctuations.

The presence of unpredictable vacuum fluctuations makes all of the laws of the micro-world principally static for any observer. An accurate prediction of expected events requires an accurate knowledge of the vacuum fluctuation in any moment of time, what is impossible, because it is necessary to have the information on the structure and the behavior of any packet (particle) in the universe and to control their motion. The mechanical determinism of Laplace went absolutely lost in the modern physics as well as in the future one. Maxwell was right when he told, "*the true logic of the universe is calculation of the probabilities.*"(back translation).

The envelope of partial waves, occurring due to linear transformations at the wave packet and being "in the ruins" of splitting of the packet corresponds to Huygens principle. It explains how the relating of a moving particle with a monochromatic de Broglie wave is formally possible, propagating in the direction of the motion, and with all wave properties. There are partial waves that we consider as participants of diffraction and interference, but due to the principle of superposition we get the same result as if it a de Broglie wave would participate at the process.

The new linear equations of the UUQT allow the time inversion with simultaneous replacingofthewavefunctionwitha conjugated one, with the formal reversibility. Actually this reversibility takes place just in the case if the Universe consisted of the only one particle, as in the real world the recovering of the previous vacuum fluctuation is also needed for the total reversibility of the process. But there is a simultaneous reversibility of all processes in the Universe required for it that is impossible. It doesn't mean that quantum processes are inconvertible, just the reversibility has a static character, butnow direction of the current of time defines entropy only.

The envelope, introduced before, is accurately monochromatic, but it doesn't exist as a traveling plane wave with such properties in the reality. Though it is related to the energy of the particle, the following definitions, such as “waves of the probability”, “waves of the knowledge”, could be related with it too. In contrast to the general quantum theory, now a very important phase is coming. It is the most easy to show it at the tunneling effect.

We would like to mention these established quantum phenomena to the reader. If we have a sufficiently narrow barrier with the height that is bigger than the energy of an incident particle, then it will never go through the barrier in the classical mechanics. In the general quantum theory, the incident wave reflects and passes by partially, and we have a finite quantity of the probability that the particle will be behind the barrier. In these cases the general Quantum Mechanics states that the particle makes a tunnel in the barrier for itself, hiding the “method of creation” of this tunnel.

Let us listen to what HO says of this process. If a particle is approaching closely to a potential barrier in the phase of an absolute collapse, then it easily goes through the barrier, not interacting with it because of linear of all of equations for the small amplitude of the field. It just appears behind the barrier, without interacting with it, if its width is much less than de Broglie wavelength. And there is no necessity for it to make a tunnel. However, if it approaches in the phase with the maximal value of the packet, then the particle would be reflected because of the nonlinear interaction of the waves with the field of the barrier.

Now let us return to the experiment with the semitransparent mirror, discussed above. In terms of the described point of view, the wave packet (particle) will be divided at the mirror and enter in every beam, that depends on the packet phase near the mirror and on the structure of the mirror in this place. We have, in general, two not equal wave packets – “fragments” with less values of the amplitude that can interfere. The changing of the parts of the fragments doesn't follow by because all process are linear, i.e. they are not dependants on amplitude. Besides the probability of detecting of the fragments is reduced, because an appreciable fluctuation of the vacuum is necessary for arising of threshold of detection of the counter. Consequently, in the results of the measurements the particles have to be lost or be observed as single particles in both of the beams simultaneously. The creation of two particles from a single is not a confusing fact, because the energy of the fragments will be reconstructed to the necessary level by means of the vacuum fluctuation.

Note, the statement of Standard Quantum Mechanics “A particle may be present simultaneously at many points of quantum world” being strange from the common sense and remained earlier without any understanding scientific explanations is correct in principle within bounds of UQT. At present we have an ambiguous situation

because too many of such experiments have been carried out, for example the classical experiments of Brown and Twiss and the variations of them (Fig. 1). It was found out that frequently both of the counters detect particles simultaneously, that is confirmed by the proposed mechanism. Furthermore, most of such experiments (including experiments with entangled photons) confirm directly this interpretation. The results of experiments with entangled particles become so simple and understanding within bounds of UQT, that the idea to seek some over light mystic relations between particles is fully meaningless.

In consequence, an increasing number of photon pairs is always observed in the beam of light. However, it was found out that we can carry out such experiments which effect remains also in the situation when there is no any way for any induced radiation.

If we will collide particles of any kind, and if in the colliding point one or two particles are vanished, then they have to go against another without any interaction. Indeed, in the proton-proton interactions 6% of the particles don't interact, but "go through" the others.

An analogous effect takes place in the atom of hydrogen in the state of minimum of energy. It is well known that this s-state is not rotational, and Bohr-Sommerfeld's atom model describes the spectrum strictly in the relativistic case. If we apply this model to the s-state of the electron, we will obtain that the paths of the electron pass through the nuclear, and they were early excepted as absolutely absurd. Today it is clear that an electron just oscillates along a straight, going through the proton. All this allowed one of the authors to consider the problem of deuteron-deuteron interaction in other respects and to predict the coldfusion (Sapogin, 1983; Sapogin at all, 1995,1996) already in 1983.

Quantum object is getting classical one with a simultaneous increasing of its mass, i.e. in the case of superposition of a large number of wave packets. The case when all of packets consisting a body will consolidate and spread simultaneously, is impossible in physics, as they have different velocities and masses. That is why such a combination seems as a stable and permanent object, moving according to the classical mechanics laws, though every packet is described in terms of the Quantum Mechanics. It looks like all particles in the Universe owe their existence to each other, and the **Universe itself is just a mathematical illusion, a trick.**

Injusticeto the adherents of the complementarity we have to say the following. They do not retract it, though they have to wriggle, they have to tell that particles always go to the mirror as correlated pairs, and one of them goes through, but the second is

reflected. Of course we need to consider the induced radiation effect, when the one atom's radiation is increasing the probability of emitting from another excited atom of the same source, but it does not always happen. Let us return to the principle of complementarity. It is clear, that if we would not be interested in the nature of the particle and consider it just as an indivisible point then the principle of complementarity is correct. It is a very curious principle and it is amazing how N. Bohr could invent it.

In recent years a numerous of experiments was carried out, which found out supraluminal speeds. Not debating if the special theory of relativity is right or not, let us show that in the Unified Unitary Quantum Theory (UUQT) any velocity is possible and the velocity of light is not maximum possible.

Let us consider Euclidean plain space, in which the photon propagates along the X -axis. According to the UUQT it is a wave packet and it could be presented as an infinite sum of harmonic components, that exist on the X -axis, figuratively speaking, placed at a distance of a million light years ahead and backwards. Now if we place on the X -axis arbitrarily far the specially device, creating an anomalistic high dispersion, then the photon could occur at the exit of the device, because the harmonic components shifted each other. The most interesting in this process is that nothing has moved between incident and reconstructed photons at this velocity! With other words, the **conventional definition of the velocity is getting obsolete.** (Sapogin,2010,2011)

Such experiments were carried out by some teams (in Berkeley, Vienna, Cologne, Florence, etc.) and they emerged the supraluminal speeds. The most interesting were LijunWang's investigations (Wang L.J. at all,2000) in which the velocity 310 times bigger than the speed of the light (Fig. 5) was found. Wang gives the same interpretation as ours but only for aimpulse of light. In this case it is a wrong interpretation, because in the experiment the envelope of the light pulse is not distorted absolutely, but it has to be obligatory, and he notices it amazed. Wang supposes that the special theory of relativity is absolutely destroyed. But it is not quite true.

Our idea that particles are wave packets is an absolutely original idea for the worldwide science. The waves at the Fig. 5 have to be realized as separated partial waves of the spectral decomposition of the wave packets of the separated photons, but not as a spectral decomposition of the light pulse. Then the form of the momentum's envelope will not be distorted.

The aspects of the Unitary Quantum Theory are confirmed by results of their practical applications to traditional tasks of physics. The UUQT allows firstly in the international science, not either to compute the electron charge and the fine structure constant ($1/137$) with the great precision (0.3%) (Sapogin at all, 1998,1991) but even to compute masses of many elementary particles (Sapogin at all, 2008a,2008b,2010) with the accuracy of 0.1-0.003%! It's amazing that in the calculated spectrum of masses there is a particle mass about 131.7 GeV that could be called Higgs boson (Sapogin, 2012). The Modern Standard Model and quantum theories of field couldn't even raise these problems mathematically. It should be stressed than when we will find the spectrum of masses and charges of electron, time won't be a part of the ultimate equations and it will stay Newtonian, in other words, **time exists only in our minds.**

In the Unified Unitary Quantum Theory all interactions and particle production (packet split) are considered as an effect of diffraction of the packets by each other because of the nonlinearity. An analytical solution of these tasks will require new mathematical methods, and it is not even clear how to start with it at presence.

Approximated equation with the oscillating charge

There are such hard rules in the modern theoretical physics. Any new theory has to include classical results. This is strictly satisfied because the Hamilton-Jacobi relativistic equation and Dirac equation follow from the UUQT, i.e. all modern basics of the fundamental quantum science. In the linear equations of the UUQT the mass was replaced by the rest energy divided to square speed of light, and then the system of 32 nonlinear integro-differential equations appears as a consequence. They were firstly found out by L. Sapogin and V. Boichenko (Sapogin at all, 1984) in 1984, and only in 1988 they solved the dimensionless scalar version of this equation that allows to get the fine structure constant – $1/137$ and electron charge with accuracy 0.3% (Sapogin at all, 1988,1991).

In this approximation of the UUQT, the wave packet is realized as a spatial divided electric charge that oscillates, its equation depends on time, coordinate and velocity and it could work in the rough model of the particle as oscillated charge, so we can exploit the Newton questions. It is becoming easy to see the tunneling effect: while the moving particle is approaching to the potential barrier, in the phase when the charge is extremely small, it is easy for it to go through the barrier, and when the quantity of the charge is large, the repulsion force is increasing, and the particle will be reflected. The numerical solution of these equations (Sapogin at all 2005, 2008a,

2011a) for the most common quantum tasks emerges approximately the same results as the calculation of the general Quantum Mechanics (QM). By the way, by means of the UUQT it is possible to get this equation from the Schrödinger's one with very low energies (Sapogin at all, 2003, 2005, 2008a). But there are though some interesting differences. The equations of motion of the oscillated charge were not treated in physics before and they have an important difference from the classical laws of motion – the invariance of the motion in the relation to invariance translations. **It means the absence of the great classical momentum and energy conservation laws.** They appear in the UUQT and then in the classical mechanics only with an averaging for all particles.

Now we obtain Uncertainty relations (Sapogin at all, 2003, 2005, 2008a, 2010, 2011). As far as the particle (wave packet) is periodically appearing and vanishing at de Broglie wave length (more precisely, the packet disappears twice, and the probability of its detecting is sufficiently big in maximum region only) the position of such a packet may be detected with error

$$\Delta x \geq \frac{\lambda}{2} \text{ and then } \Delta x \cdot P \geq \frac{h}{2}.$$

As at measuring of momentum module is inevitable the error $\Delta P = 2P$, then we have following inequality:

$$\Delta x \cdot \Delta P \geq h.$$

The statements of standard quantum mechanics that particles do not have a trajectory become more understandable. Of course, there is a lot of truth in those words. First, it is possible to say so about intermittent (dotted) motion of the particle with oscillating charge. Second, any packet (particle) is able during its motion to split into few parts. Each of that parts being summed with vacuum fluctuation may results, in principle, in few new particles. Or *visa versa* the broken particle may vanish at all and contribute to general fluctuating chaos of the vacuum. But in any case it is better to have more clear idea of particle concrete motion than operate with generally accepted nowadays-obscure sentence about lack of trajectory.

The consideration of the task on oscillations of particles with an oscillating charge in a parabolic well (harmonic oscillator) besides the common results of QM for stationary states results in two different solutions that are shown on Fig. 6. New amazing solutions appeared, one of them was called “Maternity home” and another was called “Crematorium”. In the first case the energy of the particle can increase indefinitely, furthermore if we proceed from a very low initial quantity in the equation, it results in the increasing of the energy of the particle – in the production of the matter, indeed. The second solution could due to collapse (disappear) of the matter-particle. These solutions are logically independent directly, and their appearance depends on initial phase. With other words, one solution describes the

matter (energy) production, and another one its collapse; and it may be said that the Unified Unitary Quantum Theory (UUQT) allows to describe the creation of the matter and the Universe, but not as a result of the Big Bang. The Universe wouldn't be given to us in the static form, it arose in some way and it continues to develop, and we could see that one of the basic features is the filling of space by matter.

New sources of energy

As well known, in all experiments the local law of energy conservation (LEC) and the law of conservation of momentum in individual quantum processes are correct only for high-energy states. For low energies we can't claim that, because of the uncertainty relation and the stochastic nature of QM's predictions. That is why the idea of the global, but not of local LEC exists invisibly in the QM and it's not a new one.

For the physics it only means that for the stationary solution with fixed discrete energy levels (the general QM) of the velocity of the particle reflected by a wall is equal to incident one. The UUQT allows to consider another ways too. Thus if the velocity of the particle for every reflection is decreasing then it is corresponding to the "crematorium" solution, but if it is increasing then it is corresponding to the "Maternity home". What scenario would turn to the reality depends on the initial phase of the wave function and on the energy of the particle. Besides the UUQT is fundamentally inapplicable for a closed system, because such systems are idealizations, which are very useful, but not according to the base of consideration used in the UUQT.

Anyway, the whole modern science, including the Quantum Mechanics (QM), is still based on the great LEC. However, there is a difficult situation in the Quantum Mechanics. It deals with the fact that the LEC follows only from the Newton mechanics. QM generalizes the facts of the classical mechanics including all of its laws, but its results have a sufficiently statistical nature, they are correct only for large amounts of particles. But how do we have to consider single particles, with their individual processes? It appears that for the single particles LEC does not follow from QM (!), thus individual events are absolutely incidental and do not follow this law. *To evade this question it was announced that Quantum Mechanics doesn't describe individual events (!?)*

Let us discuss a thought experiment. To make our reasons more simple let operate a certain quantum ball-particle. If the ball is approaching to the wall, then its velocity after reflection will always be equal to the incident velocity (here we neglect a

quantity of the friction force and consider that the ball and the wall are perfectly elastic). In the case of the quantum ball the velocity after the reflection would possess the whole arrange of the values, in different experiments under equal conditions. There would be some balls that would be reflected with velocities that are higher and some that are lower than the initial velocity, and some of them with velocities equal to the incident one, and every case would be considered statistically in the terms of the Quantum Mechanics.

Let us answer the following question: what would happen if we place another wall opposite the first, and would try to increase the velocity of the ball after every reflection? Then we would get increasing of energy of the ball without action of any external force. The energetic of the systems in the XXI century will treat the question of constructing of initial conditions for a numerous quantity of particles to realize only the “Maternity home” solution so that the “Crematorium” solution would be damped as far as possible. But it depends on the selection of initial phases and the geometry of the system.

Thus, if we use the aspects of the Unified Unitary Quantum Theory appropriately then there won't be a general prohibition for creating of a quantum perpetuum mobile. Formally there is no such a prohibition even in the general Quantum Mechanics, because there are no conservation laws for a single process under the low energy conditions, but it treats with probabilities instead of this. In other words, the Quantum Mechanics (QM) also offers opportunities for getting energy by collecting of random process someway, and today it seems that UUQT affords such an opportunity, it suggests the ways how to regulate the values of probabilities.

During the theoretical investigations, a numerous of calculations for the equation of oscillating charge was performed, thus moment of particles falling with different velocities were summarized and the result was compared to moment of reflected particles. It was found out that for different repulsive potentials, a total momentum of reflected particles is equal to momentum of the falling particles with a high accuracy, but for a single scattering particle the value of momentum could be either less or more than the momentum of the falling particle. This problem is very complicated and it requires subsequent researches as all this depends on initial conditions (velocity, phase, distance) complexly as well.

The prospects following from the UUQT are not even the most significant. Any flat bans as the impossibility of perpetuum mobile creation and any other confirmations of

the immovability of conservation laws are unacceptable in philosophy. No, these laws would never be neglected; but there would be such areas in science and technology, very limited in the beginning, so that these laws would be not enough.

The problem of existing of the global conservation laws (we have proved that they are not local laws) is left in abeyance. Nothing but the idleness and atavism of the human thinking lead to it. But this idleness of thinking – concerning the physics – manifests itself in the intuitive atavism for the Newton laws.

Yes, the conservation laws are incontestable in the classical mechanics and in terms of this theory a continuously operating machine is theoretically impossible. It should be stressed that the conservation laws were transferred to the Quantum Mechanics as an object of worship of the classical mechanics. But the Quantum Mechanics is more fundamental, Newton laws follow from it as a particular case. **And if in the terms of the Quantum Mechanics a possibility to get energy from nothing is theoretically possible, thus a quantum perpetuum mobile could be constructed.**

It is made possible by means of the equation with oscillating charge. It describes single particles; the difference in their behavior depends on the initial phase of the wave function, but there are no conservation laws for an individual particle at all, they appear only after an ensemble averaging. The equation with an oscillating charge is absolutely new type of motion equation (Sapogin, 1996; Sapogin at all, 2011a). For such equation energy and impulse conservation laws do not exist. It appears at terms of ensemble averaging. By the way Schrodinger mechanics also do not propose energy conservation laws for small energies (it can offer only a probability of this or that event happening) but it cannot advise how to combine processes and energy liberation while UQT can. A theorem on the circulation does not work in the equation with oscillating charge that allows to use different ways to move charge from the point *A* to the point *B*, but different ways operations will be diverse and this difference should be used. The authors are trying to design new power plant working at these principles. We think that such a plant will be able to produce energy with extremely small charges. If such power program would be fulfilled on our Planet with no doubt it will result in heat pollution of the environment. But UQT suggests a decision again: we can construct refrigerating plants with feasibility of “Crematorium” solution where Earth extra heat will disappear. Numerous experiments with the cold nuclear fusion (including the latest of Andrea Rossi - Italy) have shown that nuclear reactions do exist but the nuclear reactions’ products by themselves are not enough for the explanation of huge amount of heat being produced. It is the responsibility of the UQT solutions “Maternity home” (Sapogin at all, 2003, 2005, 2008a, 2011c). So it

looks like catalysis mechanism described above. Besides all the equation with oscillating charge is quite good in describing the wave properties of the particle. We predict that experiments on the diffraction reflection of electrons from the lattice (classical experiments of Davisson–Germer) can be simulated by supercomputer, but authors do not have such possibility.

Interestingly enough, there are apparatus called Testatik Machine M/L Converter from religious group “Methernitha”, they belong to a religious Christian commune, situated in Linden near Bern. Their maker is Swiss physicist Paul Baumann living in the commune. These fantastic devices, direct current generators, are made as a four dimensions type: with power value of 0.1, 0.3, 3 and 10 kW. Externally this device resembles an electrostatic machine with Leyden jars, so familiar from school physics laboratory. There are two acrylic discs with 36 narrow sectors of thin aluminium stuck to it. The discs rotate in different directions and their mechanical energy is hundreds times lower than produced energy – it accounts for about 100 mW in measurements. The largest device with the power value of 10 kW has disc diameters more than 2 m, and the smallest has 20 cm; the device with the power value of 3 kW has 20 kg in weight. There is no cooling or heating of the air during the long operation of the device, it just smells of ozone there. It was found out that the inventor doesn’t clearly understand the principle of operation of the device.

Professor S. Marinov (Austria), whom the commune had given as a present the device with the power value of 100 W wrote in his book called “Difficult way to the truth – documents on the violation of conservation laws”, issued in 1989 by International Publishers East-West: *“I can confirm without any doubt that this device is a classical perpetuum mobile. Without any initial impact, it could rotate an unlimited long period of time and generate electrical energy equal to 100 W... In that device, the motor and generator are connected... However, it is not clear how is it possible.”* (back translation).

The authors of the Unified Unitary Quantum Theory know approximately how this device is constructed, but in this article we are going to do only what is absolutely clear: we are going to show that the operation of this device completely corresponds with the UUQT. Evidently, it operates due to the charge separation concept. Let us consider two metallic spherical surfaces with a hole isolated from the Earth and from each other. If we carry a first electron from sphere A to the inner surface of sphere B through the hole by means of an isolated stick, then there appears a potential difference. Further, if we carry the second one and the subsequent electrons, sphere A

would attract the carried charge, and B – would repel it. It is clear that to move the charge we will have to spend energy. (Fig. 7).

In the Technical University – MADI (Moscow) professor V.I. Uchastkin gives lectures on the Unified Unitary Quantum Theory (UUQT) and new energy sources. In his explanations, he uses the figurative analogy: *“Let us consider a sack of potatoes which mass is m . If we carried it to the fourth floor (the height is h), then we spend the quantity of work opposite to the gravitational field which is equal to mgh . And if we throw it down we would get kinetic energy $mv^2/2$, and these quantities would be equal to each other. But we could also carry not the whole sack, but every potato one by one. The work of one quantum of a potato’s transfer depends on time, velocity and coordinate, and it must be carried in such way that the spent work would be minimal. If you carry the whole sack in this way, you can get the quantity $mv^2/2 > mgh$. So, there are no changes in the system, but the energy has appeared.”*

Prospects

Let us remember the problem about the maintenance of long-term flights to the outer space with electricity. The Prof. Uchastkin’s analogy describes precisely a theoretical approach for solving this problem. Of course, there is a great deal to do though, to understand what phenomenon will play the role of those “quantum potatoes” and how to construct an instrument that would be able to support a minimal energy to “bring them to the fourth floor”.

How can a spaceship be supplied with energy during many months of flight? Near the Earth, photovoltaic cells are used but the more the distance to the Sun is increasing, the more needless they are; using of a nuclear energy source is problematical for different causes. Today we can neither improve this situation considerably nor do we have even any theoretical conditions which could let us approach it. On the base of such a situation there are common ideas of the construction of matter and its properties. Now then, a new conception of physics is being proposed. Like many others as well. If we stay by the space technology, it’s over constructing of engines based on new principles of energy production, maintaining of real-time telecommunication on the distances in outer space, free of limits which are proper to the diffusion of electromagnetic waves... It follows from the foregoing that UUQT opens up a perspective of a solution for the communication problem on extremely wide distances in outer space for it excludes the limits of information exchange between Earth and spaceship. The theory also predicts the approaches to creating of

the new energy sources and of the new types of engines that would be almost ideal for creating of spaceships of the future.

Conventional jet propulsions transform the conducted energy in the kinetic energy of the beam of a working body flowing from the engine, and the reaction force of this beam – the pulling force – accelerate the spaceship. Therefore space flights to extremely wide distances will require huge stocks of working body.

A classical progression curve reflects the velocity increasing of a thrown-off mass of the working body. Though there is a possibility for creating of a very weak constant pulling – but! – without throwing off of mass.

Let us use the method of analogy again. Regard a classical trick problem in physics for universities' admission tests: there is a boat in motionless water and a man with a sandbag in this boat. Can he move the boat by performing any manipulations with the sandbag, for an endless time?

Correct answer: throw the sandbag from the front part of the boat to its back, then carry it back slowly, throw it again and so on. As the viscous friction force by Stocks is proportional to the velocity, the boat will perform swinging motions, over which some linear movement will be applied. Based on this idea, marsch buggies were constructed in Germany – there is heavy mass moving in there, in one direction quickly and back slowly. Many decades ago, the same effect (Dean's engine) was wide-ragingly discussed in the USSR in popular science magazines and on TV.

There is a similar phenomenon in the classical electrodynamics as well as in the quantum electrodynamics and it's related to the Lorentz radiative friction force. The appearance of Lorentz' force becomes evident by considering the interaction of the charge and the field caused by it. For a motionless charge the force of such an interaction – or “self-action” – is equal to zero, otherwise the free charge would experience a self-acceleration. The charge begins to move, but the electromagnetic field, as its spread's velocity is finite, can't reschedule immediately. The accelerated charge practically flies onto its own field; with other words, this effect can be described as appearance of energy flow which is directed upstream to the flow and slowing it down. It generates “electromagnetic viscosity” which value is related to the acceleration.

How can this phenomenon be used? If there is a charge cloud in flat capacitor, it is possible to make it swing between sheets with different values of acceleration forwards and backwards by applying a sawing motion to the sheets. Because of

different forces of radiation friction in the alternate and opposite direction, pulling force appears along the lines of electric field. The radiation of such accelerated charges is always perpendicular to their movement and can be screened, but the most important thing on it is the fact that it doesn't change its impulse in relation to the direction of the capacitor's field. It may be paradoxical, but it seems that we get a pulling force by spending energy for this process without throwing-off of any mass in the direction, which is opposite to the motion's one. The authors even published in the US-magazine "Journal of New Energy" vol.5, #1, 2000 an article, containing an exact analytical solution of this problem: the pulling of some micrograms appears in a flat capacitor, containing a cloud of 10^{19} electrons in which the distance between the sheets is many meters long, by applying of sawing potential of millions of volts. Of course, it is an insignificant result in relation to such a huge (hypothetical) instrument employment, and the using of electron cloud in a flat capacitor has practically no prospects. But if stable charged particles exist which mass is at least one-millionth of electron mass, then this idea becomes very interesting from the technical point of view. Do such stable charged leptons exist at all and how is it possible to generate them in a sufficiently large number? Today nobody can give an answer...

To generate pulling it is still possible to throw off the mass/ matter, "getting" it in a specially created potential hole, accelerating in it in the same time. UUQT allows such solution generally that is evident from the "Maternity home" solution.

Let us consider the results. UUQT will in future let us solve several basic problems of the worldwide energy supply and all problems in outer space: immediate information changing, the problem of energy supply and constructing of new engine types. It is absolutely precipitant to make technical plans for those solutions, but the foregoing should be considered not as a wanton imagination, but as a possible future programmer of fundamental research to transpose our civilization to new physical principles.

Evaluation of UQT ideas resulted in instinctively absolutely clear picture of quantum events in terms of figures and movements. And philosophical principal of Complementarity can be now hidden with well-deserved honors. In spite of mathematical complexity Unitary Quantum Theory will stop ordinary Quantum Mechanics paradox and consequently frank words of Richard Feynman: "*I can easily say that nobody understands quantum mechanics*" will become the property of history.

Moreover, by solving the QUT equations it became possible to obtain with the high precision an electron charge, as for scalar telegraph UQT equation it gave with appropriate precision mass spectrums of all elementary particles (Sapogin at all,

2008a, 2008b, 2010). The same spectrum was followed from the solution of the Schrödinger and Klein-Gordon integro-differential equations. The risk of computed mass spectrum being random is less than 10^{-60} . Of course such results cannot be obtained without sacrifice. What would we offered in sacrifice if replaced an Ordinary Quantum Mechanics by the Unitary Unified Quantum Field Theory Field (UUQFT)?

1. There are no in UUQFT strict principles of superposition. It is violated if wave packets are colliding.
2. There are no strict close systems in UUQFT and the Conservation Laws works for very big energies only. Note that the Conservation Laws forbid beginnings of the Universe.
3. The classical relativistic relation between energy and impulses is valid in UUQFT only after averaging of observed phenomena and Relativistic Invariance itself is not "the sacred cow".
4. The Space in UUQFT is non homogenous and non isotropic.
5. The particles and their interaction are not local.
6. The existing Standard Model Quantum Theory of Elementary Particles requires much alteration.
7. The velocity concept as quotient from division of the traversed path to some time interval is not quite appropriate in UQT. If a wave packet (particle) is spreading along the Megagalaxy and then appearing somewhere else, what should we do with the rate, if nothing moves between the points of disappearance and arrival, does it mean that particle has just simply disappeared and then appeared in a new place?

There was observed resembling crushing defeat of physics 50 years ago as "weak interaction" burst, so to say, into physics.

As soon UQT is nonlinear it automatically combines all four interactions that can pass from one into another at different distances.

Below we analyze the most important fields of science from UUQFT general physics positions.

Lorentz transformations.

It's quite complicated. The special relativity – is in fact Lorentz transformations (1904) derived by V.Vogt (1887) in the century before last. These transformations followed from the properties of Maxwell equations which are also proposed in the nineteenth century (1873). One of these equations connecting electrostatic field divergence and electric charge (Gauss' law of flux), in fact is just another mathematical notation of Coulomb's law for point charges.

But today anybody knows that Coulomb's law is valid for fixed point charges only. If charges are frequently moving Coulomb's law is not performed. Besides anybody knows that lasers beams are scattered in vacuum one over another, which is absolutely impossible in Maxwell equations. That means that Maxwell equations are approximate - and for the moving point charges experimental results essentially differs from the estimated ones in the case charges areas are overlapping.

Few people think about the shocking nonsense of presenting in any course of physics

of point charge electric field in the form of a certain “sun” with field lines symmetrically coming from the point. But electric field – is a vector, and what for is it directed? The total sum of such vectors is null, isn't it?

There are no attempts to talk about, but such idealization is not correct. We should note that Sir Isaak Newton did not use term of a point charge at all, but it's ridiculous to think that such simple idea had not come to him! As for Einstein, he considered “*electron is a stranger in electrodynamics*”. Maxwell equations are not ultimate truth and so we should forget, disavow the common statement about relativist invariance requirement being obligatory “permission” for any future theory.

To reassure severe critics we should note that UQT is relativistically invariant, it allows to obtain correct correlation between an energy and impulse, mass increases with a rate, as for relativistic invariance just follow of the fact that the envelope of moving packet is quiet in any (including non-inertial) reference systems. To be honest we should note that subwaves the particles consist of are relativistically abnormal, at the same time envelope wave function following from their movement confirms terms of Lorentz transformations.

The success of Maxwell equations in description of the prior-quantum view of world was very impressive. Its correlation of the classical mechanics in forms of requirement to correspond Lorentz transformations was perfectly confirmed by the experiments that all these had resulted in unreasoned statement of Maxwell equations being an ultimate truth...

Other reasons for this were later very carefully investigated by a disciple of one of the authors (L.S.), Professor Yu.L.Ratis. (S.Korolev Samara State Aero-Space University), who has formulated the modern spinor quantum electrodynamics from the UQT point of view:

1. Maxwell equations contain constant c , which is interpreted as phase velocity of a plane electromagnetic wave in the vacuum.
2. Michelson and Morley have never measured the dependence of the velocity of a plane electromagnetic wave in the vacuum on the reference system velocity as soon plane waves were mathematical abstraction and it was impossible to analyze their properties in the laboratory experiment in principle.
3. Electromagnetic waves cannot exist in vacuum by definition. A spatial domain where an electromagnetic wave is spreading – is no longer a vacuum. Once electromagnetic field arises in some spatial region at the same moment such domain acquires new characteristic – it became a material media. And such media possesses special material attributes including power and impulse.
4. Since electromagnetic wave while coming through the abstract vacuum (the mathematical vacuum) transforms it in a material media (physical vacuum) it will interact with this media.
5. The result of the electromagnetic wave and physical vacuum interaction are compact wave packets, called photons.
6. The group velocity of the wave packet (photon) spreading in the media with the normal dispersion is always less its phase velocity.

All abovementioned allows making unambiguous conclusion: *the main difficulties of*

the modern relativistic quantum theory of the field arise from deeply fallacious presuppositions in its base. The reason for this tragic global error was a tripe substitution of ideas – velocity of electromagnetic wave packets ‘c’ being transformed in numerous experiments physics have construed as constant ‘c’ appearing in Maxwell equations and Lorentz transformations. Such blind admiration of Maxwell and Einstein geniuses (authors in no case do not doubt in the genius of these persons) had led XX century physics up a blind alley. The way out was in the necessity of revision of the entire fundamental postulates underlying the modern physics. Exactly that was done by UUQFT.(Sapogin, 2010, 2011)

Some time ago CERN has conducted repeated experiments of the neutrino velocity measurement that appeared to be higher than velocity of the light. For UUQFT they were like a balm into the wounds. The administration of CERN renounced after sometimes these results considering them as the consequence of experimental errors. As far as the authors know, not all participants of this experiment agree to such renouncing. Besides, many astronomers detect superluminal velocities during observations of stars and galaxies. In fact the movements in excess of the light velocity were discovered earlier by numerous groups of researches. Nearly everybody disbelieved it. And now the neutrino movements exceeding the velocity of the light were disclosed in CERN. The importance of these experiments for UUQFT is settled in the article (Sapogin, 2011) where at the page 69 it is written that “*this should be considered as direct experimental proof of UUQFT principle*”.

Note, this question is terribly complicate and probably is to be leaved to next generations. From one side, the time in UQT exists, so to say, in our head only. From other side, the Lorenz Transformations describe correctly some experimental facts, for example, the mass growing with velocity. Otherwise, all atomic accelerators would be out of order. Thereafter, it is a big mistake to consider all Special Relativity Theory as erroneous.

There are also other ideas. For example, at «New Relativistic Paradoxes and Open Questions», by Florentin Smarandache, shows several paradoxes, inconsistencies, contradictions, and anomalies in the Theory of Relativity. According to the author, not all physical laws are the same in all inertial reference frames, and he gives several counter-examples. He also supports superluminal speeds, and he considers that the speed of light in vacuum is variable depending on the moving reference frame. The author explains that the red shift and blue shift are not entirely due to the Doppler Effect, but also to the medium composition (i.e. its physical elements, fields, density, heterogeneity, properties, etc.).

Professor Smarandache considers that the space is not curved and the light near massive cosmic bodies bends not because of the gravity only as the General Theory of Relativity asserts (Gravitational Lensing), but because of the Medium Lensing.

In order to make the distinction between “clock” and “time”, he suggests a first experiment with a different clock type for the GPS clocks, for proving that the resulted dilation and contraction factors are different from those obtained with the cesium atomic clock; and a second experiment with different medium compositions

for proving that different degrees of red shifts/blu shifts would result.

To regret, the authors today have no decisive position to these complicate questions.

Standard model

As soon relativistic invariance underlies every of the numerous quantum theories of the field, it leaves a devilish imprint at everything. Nevertheless relativistic ratio between energy and impulse although being absolutely correct in fact are not obligatory follow from relativistic invariance only and can result from another mathematical reasons that will be discovered in future. Nowadays Standard Model (SM) combines the most elegant mathematical miracles of researches which hands were tied with relativistic strait-jacket and it not so bad describes these experimental data. Amazing that it was possible to think it out at all.

Nowadays to confirm SM one should find a Higgs boson and for this purpose the governments of some countries assigned essential sums for the construction of Large Hadron Collider (LHC). For entire SM the interaction with Higgs field is extremely important, as soon without such a field other particles just will not have mass at all, and that till lead into the theory destruction.

To start with we should note that the Higgs field is material and can be identified with media (aether) as it was in former centuries. But SM authors as well as modern physics have carefully forgotten about it. We would not like to raise here once again the old discussion about it. It's a quite complicated problem and let us leaves it to the next generation.

But another problem of SM has never mentioned before: in the interaction with Higgs field any particle obtains mass. As for Higgs boson itself, it is totally falling out of this universal for every particle mechanism of mass generation! And that is not a mere trifle, such "mismatching" being fundamental fraught with certain consequences for SM.

After Higgs boson discovery nothing valuable for the world will happen except an immense banquet. Of course boson will justify the waste of tens billions of Euros... But even now some opinions in CERN are expressed that probably boson non-disclosure will reveal a series of new breath-taking prospects... and where were these voices before construction, we wonder? But that's not the point! If this elusive particle were the only weakness of SM!

To our regret today this theory cannot compute correctly the masses of elementary particles including the mass of Higgs boson. More worse, that SM contains from 20 to 60 adjusting – arbitrary! - parameters (there are different versions of SM). SM does not have theoretically proved algorithm for spectrum mass computation – and no ideas how to do it!

All these bear strong resemblance to the situation with Ptolemaic model of Solar system before appearance of Kepler's laws and Newton's mechanics. This earth-centered model of the planets movement in Solar system at the moment of appearance had required introduction of 40 epicycles, specially selected for the coordination of theoretical forecasts and observations. Its description of planets positions was quite good; but later to increase the forecasts accuracy it had required another 40 additional epicycles... Good mathematicians know that epicycles are in fact analogues of

Fourier coefficients in moment decomposition in accordance with Kepler's laws; so by adding epicycles the accuracy of the Ptolemaic model can be increased too. However that does not mean that the Ptolemaic model is adequately describing the reality. Quite the contrary...

The Unitary Quantum Theory allowed computing the mass spectrum of elementary particles without any adjusting parameters. By the way computed spectrum (Sapogin at all, 2008ab, 2010) has particle with mass 131.51711 GeV ($L=2$, $m=2$). Once desired it can be called Higgs boson, it lies within declared by the CERN+Tevatron mass interval 125-140 GeV expected to contain Higgs boson. CERN promises to obtain more precise mass value by December 2012.

Note the following remarkable fact: the standard theory allowed to detect spectra by using always the quantum equations with outer potential and as corollaries to geometric relations between de Broglie wave's length and characteristic dimension of potential function. The quantum equation of our theory do not contain the outer potential and describe a particle in empty free space; the mass quantization arises owing to the delicate balance of dispersion and non-linearity which provides the stability of some wave packets number. It is the first case when spectra are detected by using the quantum equations without outer potential.

Nuclear physics.

Nuclear physics as a part of quantum theory is very luckless. Thus the potential of the strong interactions is so complicated that no one even very bulky and intricate mathematical expression is able to describe with more or less veracity the experiments of two nucleons interaction. This interaction depends in very complicated manner from all parameters of the nucleons movement and their orientation towards vectors of velocity, acceleration, spin, magnetic movement, etc. Scarcely one can find a parameter which practice interaction does not depend on. From UQT point of view the strong interactions appear in the result of nucleons represented by the wave packets overlapping. Today the way of mathematical notation of the overlapping wave packets interaction is absolutely vague as soon nonlinear interaction in any space-time point of the waves is different due to different amplitudes.

It's a really complicated problem as soon there is only one nonlinear mathematical problem existing for each space-time point and even with the intuitive clearance of situation we do not expects its soon solution. The complete understanding of the nuclear structure hardly can be expected in the soonest time without exact expression for the potential of the strong interaction.

In general it should be noted that quantum world looks more clear and simple in UQT than in the general quantum mechanics, but we cannot repeat it while speaking about the mathematics used. The appearance of the exact analytical solution of the scalar problem of elementary particles mass spectrum can be considered as Fate gift (or God's help) for UQT. By the way the standard **Schrödinger** quantum mechanics has the same gift – the exact analytical decision of the Hydrogen atom.

The nuclear process in terms of small energies should be reviewed. Today the strict nuclear physics does not assume nuclear reactions at small energies that contradict experimental data. Here we should also note our skepticism towards the idea of

nuclear fusion in Tokamaks, we consider this way as hopeless. To justify these experiments we have to mention that the decision was made in the absence of other ideas and under the great pressure of the future power problems. But the use of the reactions of classical cold fusion for the power output is also difficult due to the complexity of colliding nuclei phasing. This phenomenon is well described by the equation with oscillating charge, while the cold nuclear fusion had been predicted in UQT 6 years before its real discovery (Sapogin, 1983).

Solid-state physics.

The band theory of solid is based at the point on the solution of the task of an electron movement in the field of two or more charges. But this problem does not have analytical solution yet, in practice a speculative quality solution is used only. The results are that electrons in the solid have quite specific allowed power bands. This field of the science is very successful and hardly will be revised. Any solution of the equations with the oscillating charge for the electron moving in the field of few nuclei also result in appearance of allowed and forbidden bands (Sapogin at all, 2003, 2005, 2008a, 2011a). Somewhat apart is classical tunneling effect. In UQT the probability of tunneling effect appearance depends on the phase of the wave function (in contrast to the ordinary quantum theory, where at the squaring of the wave function module its dependence on the wave phase totally disappears). It could be interesting to prove such dependence by the experiments. It can be easily done if creating a new transistor on the basis of absolutely new principle of the electron current control (Sapogin at all, 2011b).

We are not going to analyze the modern theory of superconductivity, but we are sure that the equation with oscillating charge will deepen our understanding of superconductivity as well as mysterious properties of quantum liquids.

Astrophysics and Cosmology.

The authors regret not being sympathized with the ideas of the Universe origin from one singular point. The most amazing in this theory is a detailed computation of events occurred in the first fractions of the second just after the Big Bang. Today when the fundamental physics is making only first shy steps towards the real understanding of the quantum processes we still do not have clear model of the particles, or understanding of a spin appearance, a charge and magnetic moments. According to UQT the processes of the multiple particle production at collision is a common result of the waves packets of big amplitudes diffraction in periodic structures one another, as for the multiple outgoing in different directions particles they correspond to the general diffraction maximums. But we do not assume the responsibility of the mechanism of the multiple particles production for the Universe appearance. To our opinion the complete understanding of the quantum world will arise only after solving of 32 nonlinear integro-differential equations of UQT (Sapogin at all, 1984, 2003, 2005, 2008a). To their regret the authors like castrates in a harem can only look at these equations.

And many cosmologists would like to use theories assuming existence Universe localities where the energy is coming into being and also other localities where the energy annihilates. For example, British astronomer Fred Hoyle has developed the

theory of Universe where it takes the place the continuous creation of matter. He wrote: "... *Different atoms constituting the matter do not exist at some given moment of time and then after instant they exist already. I must admit this idea may look as strange... But all our ideas about creation are strange. According to previous theories the whole quantity of matter in Universe was coming into being just as whole and all process of creation looks as super-gigantic instant explosion. As for me, such idea seems much stranger, than idea of continuous creation...*" F.Hoyle, *La nature de l'Universe*, 1952.

The official astronomical science does not accept the ideas of F.Hoyle and of some other astronomers (H.Bondi, T.Gold, and P.Jordan) about continuous creation of matter in Universe because the Conservation Laws are considered as infallible. But from the viewpoint of our UQT these ideas are quite not strange.

Our real 'world' continuum consists of an enormous quantity of particles moving with different velocities. Partial waves of the postulated vanishing particles create real vacuum fluctuations that change in a very random way. Certain particles randomly appear in such a system, owing to the harmonic component energy of other vanished particles. The number of such "dependant particles" changes, though; they suddenly appear and vanish forever, as the probability of their reappearance is negligibly small, and so we do expect that all particles are indebted to each other for their existence. Yet, if some particles are disappearing within an object, other particles are arising at the same moment in that object due to the contribution of those vanishing particles' harmonic components –and vice versa. The simultaneous presence of all of the particles within one discrete macroscopic object is unreal. Some constituent particles vanish within the object while others appear. In general, a mass object is extant overall, but is not instantaneously substantive and merely a 'false' image. It is clear that the number of particles according to such a theory is inconstant and all their ongoing processes are random, and their probability analysis will remain always on the agenda of future research.

In accordance with UQT there are another solutions for the quantum harmonic oscillator besides stationary, where the given tiny incipient fluctuation is growing, gaining power and finally becoming a particle. It is so called "Mathernity Home" solution. There are also other solutions where substance (power) is disappearing. Such solutions have been called "Crematorium". *May be Metagalaxy is simply entangled in searching the balance, isn't it?*

All this allows expecting that space continuum in the centers of Galaxies produces different particles, electrons, protons, neutrons, which are the sources of light atoms. Later thanks to the gravitation light atoms are transformed into gas nebulae where under gravity compression the stars are lighting. It's quite possible that the current theory of Stars evolution is correct in general while describing (via Supernova) the production of other atoms apart Hydrogen and Carbon the planets consist of. We do not think nuclear process at small energies (which are possible in UQT, but impossible in standard quantum theory) will essentially modify evolutionary view of the Galaxies development.

It is interesting that the state with the minimum quantum values $L=0, m=0$ belongs to

the very heavy neutral scalar particle (WIMP) with our name Dzhan and mass about 69.6 TeV, which in principle should purely interact with the others (Sapogin at all, 2005, 2008ab, 2010). With the growth of the quantum numbers the mass of the particle is diminishing. So there should be a lot of Dzhan-particles due to the small quantum numbers. And probably their existence is responsible for the dark matter in general, in accordance with some evaluations Metagalaxy consist of up to 80-90% of the dark matter.

Gravitational theory.

No doubt that Gravitational theory should follow from 32 nonlinear integro-differential equations of UQT and the authors are expecting that it can be done in future (Sapogin at all, 1984, 2005, 2008a). Nevertheless we will make now some conservative assertions. The current data regarding the Universe expansion can be interpreted as the change of the gravitational potential sign (gravity is replacing by repulsion) at great distances for the great masses. Probably the difference between absolute the values of electric charge of a proton and a electron, say in 15 – 20 signs, is responsible for his phenomena, but for us this idea is extremely unsympathetic. On the other hand there is an impression that the variation of the gravity potential is momentary and acts at the same time in all spatial domains (long-range action). Thus any attempts to propose lateness correction of the changes of gravitational potential in the planetary motion equation require the said changes to be occurred with velocities which are many times higher than the velocity of light. Apart there is the question of existence and velocities of the gravity waves, where is no clarity at all. It could be clarified between 16 and 22 of July 1994 when comet Shoemaker-Levy had collided with Jupiter, but humanity missed such possibility. At the moment of the comet huge cores collision with the Jupiter ball of gas its surface should started radial oscillations and created gravity waves, if they exist at all. It's astonishing but astronomers all over the world in every observatory were able to observe this phenomenon nearly in real time conditions (the light was coming from Jupiter to the Earth about an hour), as for the gravity specialists they had overslept such a chance to study gravity waves velocity at all as far as the authors are informed. At the same time according to the processed information (Hlistunov at all, 2011) from Russian Command-and-Measuring Complex for the monitoring and control of the space objects at the entire moment of collision geodesic satellites "Topex-Poceidon" and "GEO_IK" began swaying at their orbits. Normally the orbit of a geodesic satellite lies inside the tube with about 1 km diameter and the orbit can be control with the high accuracy – not more than one meter precision for the position data and centimeters per second for velocity. During the collision the sensors registered 5-8 times increase of the trajectory tube diameter. In the same article Hlistunov at all on the basis of correlation analysis of the position data measurements and information obtained from earthquake-detection station it was shown that the waves of gravitational potential variation were the trigger for earthquakes. To the authors' regret they do not have the similar information from NASA.

Chemical catalysis.

The process of chemical catalysis and the catalysts are the great mystery of the

modern science. The number of chemical catalysis theories equals the number of chemical catalytic processes. Specialist of chemical catalysis used to think that this or that reaction is not being processed only if a special catalyst has not been found. Even Michael Faraday studied these problems. He seems to say platinum black being the universal catalyst. Only this (while platinum practically does not react with anything) immediately suggests an idea that chemical processes are not enabled at all and we should look for the physical universal mechanism of reactions.

The UQT has such a process. The details are listed in the articles (Sapogin at all, 2003, 2005, 2008a, 2011c). The universal mechanism of heterogeneous catalysis for example in Ammonia synthesis consists of the following: Nitrogen molecular falls into a cavity (hole) of the catalyst few tens of Angstrom unit size. At some initial terms molecular starts oscillating with an energy augmentation implementing thus solution “Maternity home” like in a normal potential well. If the augmented energy exceeds the binding energy of molecular Nitrogen then atomic Nitrogen at the exit from the cavity will be caught by protons (Hydrogen), form Ammonia and then quit the game and free cavity for the new deeds.

We are sure that in such a way water can be decomposed for Oxygen and Hydrogen. At normal conditions the mixture of Oxygen and Hydrogen is stable. In other words two stable substances (water and gas mixture) are simply divided by a high energy barrier, that can be overcome (tunneling effect analogue) by using the exact catalyst and the UQT ideas. For today a lot of experiments of water decompositions are known, the energy evolved in the process of hydrogen combustion is ten times higher than necessary for decomposition. It makes possible to design an engine running from water.

Conclusion

It seems that if UQT were correctly describing the world properties the radical transformation of the civilization would be possible. In conclusion we should express our astonishment that UQT is incomprehensible for any thinking person, it's a mystery to us.

We are concluding by reminding of the prophetic words of the famous US science-fiction author Arthur Clarke: *“Something that is theoretically possible will be achieved practically independent of technical difficulties. It's enough to desire it.”* (back translation)- Profiles of the Future, 1963.

We would like to add the amazing phrase of A. de Saint-Exupéry: *“The truth is not something that could be proved, but something that makes all things easy and clear”* (back translation).

Acknowledgements:

The authors thank for discussions to professors F. Smarandache, V.A.Boichenko, A.S.Bogomolv, V.V.Graboshnikov, Yu.P.Savin, V.I.Uchastkin.

REFERENCES:

Jammer M. (1961). Concepts of mass in classical and modern physics. Harvard University Press.

- Sapogin L.G. (1973). «United Field and Quantum Mechanics», *System Researches (Physical Researches)* Acad. Science USSR, Vladivostok, 2, pp. 54-84, (Russian).
- Sapogin L.G. (1979). «On Unitary Quantum Mechanics». *NuovoCimento*, vol. 53A, No 2, p.251.
- Sapogin L.G. (1980). “A Unitary Quantum Field Theory”. *Annales de la Fondation Louis de Broglie*, vol.5, No 4, p.285-300.
- Sapogin L.G. (1982a). A Statistical Theory of Measurements in Unitary Quantum Mechanics. *NuovoCimento*, vol.70B, No.1, p.80.
- Sapogin L.G. (1982b). A Statistical Theory of the Detector in Unitary Quantum Mechanics. *NuovoCimento*, vol.71B, No.3, p.246.
- Sapogin L.G. (1983), *Journal «Technics for a young»*, No.1, page 41. (Russian).
- Sapogin L.G., Boichenko V.A., (1984). “On the Equation of the Unitary Quantum Theory”. *Annales de la Fondation Louis de Broglie*, vol. 9, No.3, p.221.
- Sapogin L.G., Boichenko V.A. (1988). “On the Solution of One Non-linear Equation”. *NuovoCimento*, vol.102B, No 4, p.433.
- Sapogin L.G., Boichenko V.A. (1991). “On the Charge and Mass of Particles in Unitary Quantum Theory”. *NuovoCimento*, vol.104A, No 10, p.1483.
- Sapogin, L.G., I.V. Kulikov (1995) “Cold Nuclear Fusion in the Unitary Quantum Theory», *Chinese Journal of Nuclear Physics*, vol.17, No 4, p.360-370,.
- Sapogin, L.G. (1996) “Cold Nuclear Fusion and Energy Generation Processes in Terms of the Schroedinger Equation”. *Chinese Journal of Nuclear Physics* vol.19,#2, p.115-120, 1996
- Sapogin L.G., Ryabov Yu.A., Utchastkin V.I. (2003). *Unitary Quantum Theory and a New Energy Sources*. Ed. MADI, Moscow, (Russian).
- Sapogin L.G., Ryabov Yu.A., Boichenko V.A. (2005). *Unitary Quantum Theory and a New Sources of Energy*, Archer Enterprises, Geneva, NY, USA.
- Sapogin L.G., Ryabov Yu. A., Boichenko V. A. (2008a). *Unitary Quantum Theory and a New Sources of Energy*, Ed. Science-Press, Moscow, (Russian, transl. from English).
- Sapogin L.G., Ryabov Yu. A. (2008b). «On the mass spectrum of elementary particles in Unitary Quantum Theory», *The Old and New Concepts of Physics*, Vol. 5, No 3 www.uni.lodz.pl/concepts
- Sapogin L.G., Dzhaniybekov V.A.(2008c), *Journal «Technics for a young»*, No.9,11, February (Russian).
- Sapogin L.G., Ryabov Yu. A. (2010). «New Theoretical Results about the Mass Spectrum of Elementary Particles». *Applied Physics Research*, vol. 2, No 1, p.86-98, May. www.ccsenet.org/apr
- Sapogin L.G.(2010),”About Unitary Quantum Field Theory” *Applied Physics Research*, vol. 2, No 2, p.114-140, November. www.ccsenet.org/apr
- Sapogin L.G., Ryabov Yu. A. (2011a). "Approximation Equations with oscillating charge in Unitary Quantum Theory and its applications to the analysis of some quantum problems." *International Journal of Applied Science and Technology*, Vol.1, No 5, September. www.ijastnet.com

Sapogin L.G, Dzhanibekov V.A., Sapogin V.G. (2011b).” A new approach to control electroncurrent in Unitary Quantum Theory”. *International Journal of Applied Science and Technology*, Vol.1, No.6, November. www.ijastnet.com

Sapogin L.G, Ryabov Yu. A. (2011c).”Unitary Quantum Theory and Catalytic Process Theory.” *International Journal of Pure and Applied Sciences and Technolodgy* 3(2),pp.93-120 www.ijopaasat.in

Sapogin L.G.(2011),”An Unitary Unified Quantum Field Theory” *Global Journal of Science Frontier Research*, vol.11, Issue 4, Version 1.0, July.

Sapogin L.G. (2012), *Journal «Technics for a young»*, No.2, page 2-11, February (Russian).

Sapogin L.G, Ryabov Yu. A.,Dzhanibekov V.A. (2012a),”Problems in the Unitary Quantum View of the World” *International Journal of Applied Science and Technology*, Vol.2, No .5, May. www.ijastnet.com

Sapogin L.G,Dzhanibekov V.A. (2012b),”Object Lessons of the Unitary Quantum Theory ” *Journal of Modern Physics and Applied* ,Vol., No .1 page 1-22, <http://scik.org>

Smarandach Florentin (2012) “*New Relativistic Paradoxes and Open Questions*”, Somipress.

Wang L.J. etc. (2000). “Gain-assisted superluminal light propagation”, *Nature*, 406, p.277-279.

W.Hlistunov,Poduvalcev V.V.,Mogilyuk J.G. (2011) ”Science and Education”-pub. electronic scientific and technical periodic #11,November.

Figures

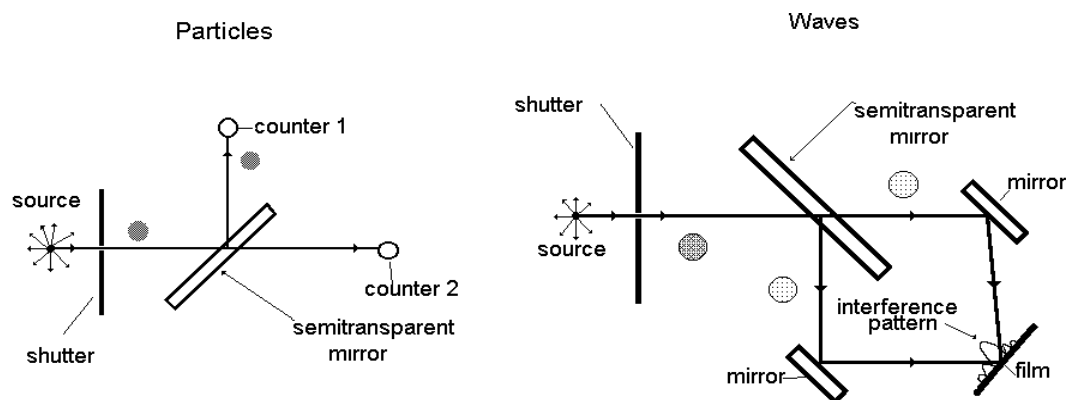

Figure 1. Experiments with individual photons on semitransparent mirror

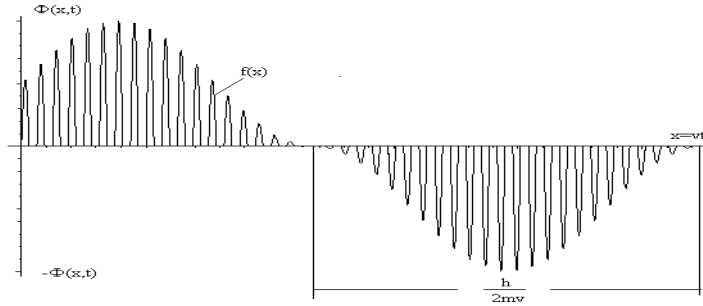
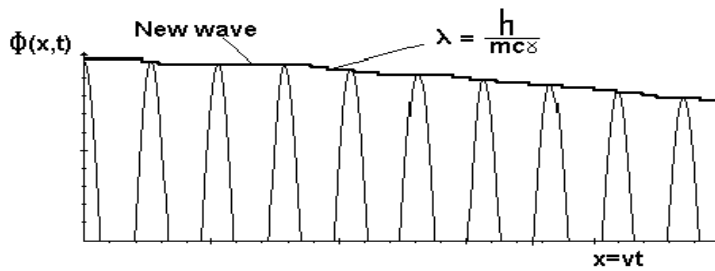
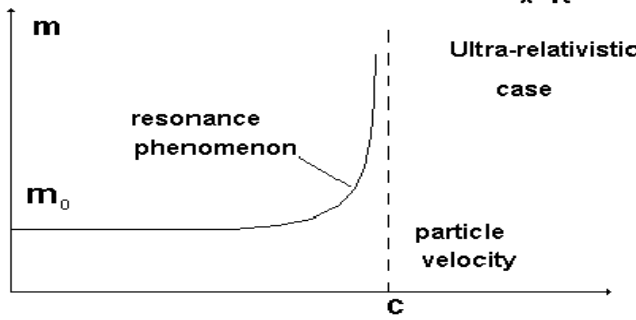

Figure 2. Behaviour of wave packet in linear dispersion medium (i.e., rather like a series of stroboscopic photographs).



Within the ultra-relativistic limit the wave length λ becomes much greater than the characteristic dimension of the quantum system with which it interacts. Therefore, the particle represented as a quasi-stationary wave packet moving in accordance with the classical laws.



$$v \rightarrow c, \gamma \rightarrow 0, \omega_d = \omega_s - \omega_b \approx \frac{mc^2}{\hbar}$$

Figure 3.

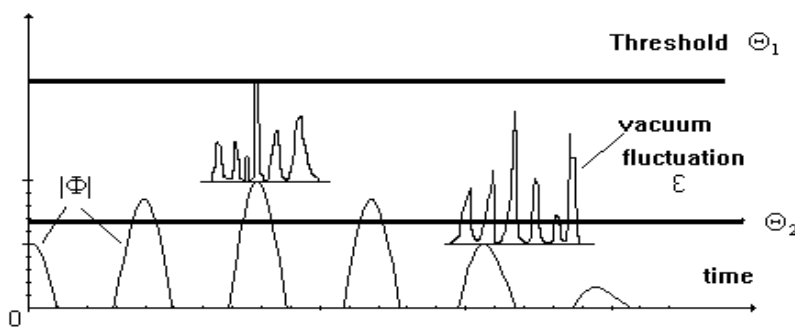

Figure 4.

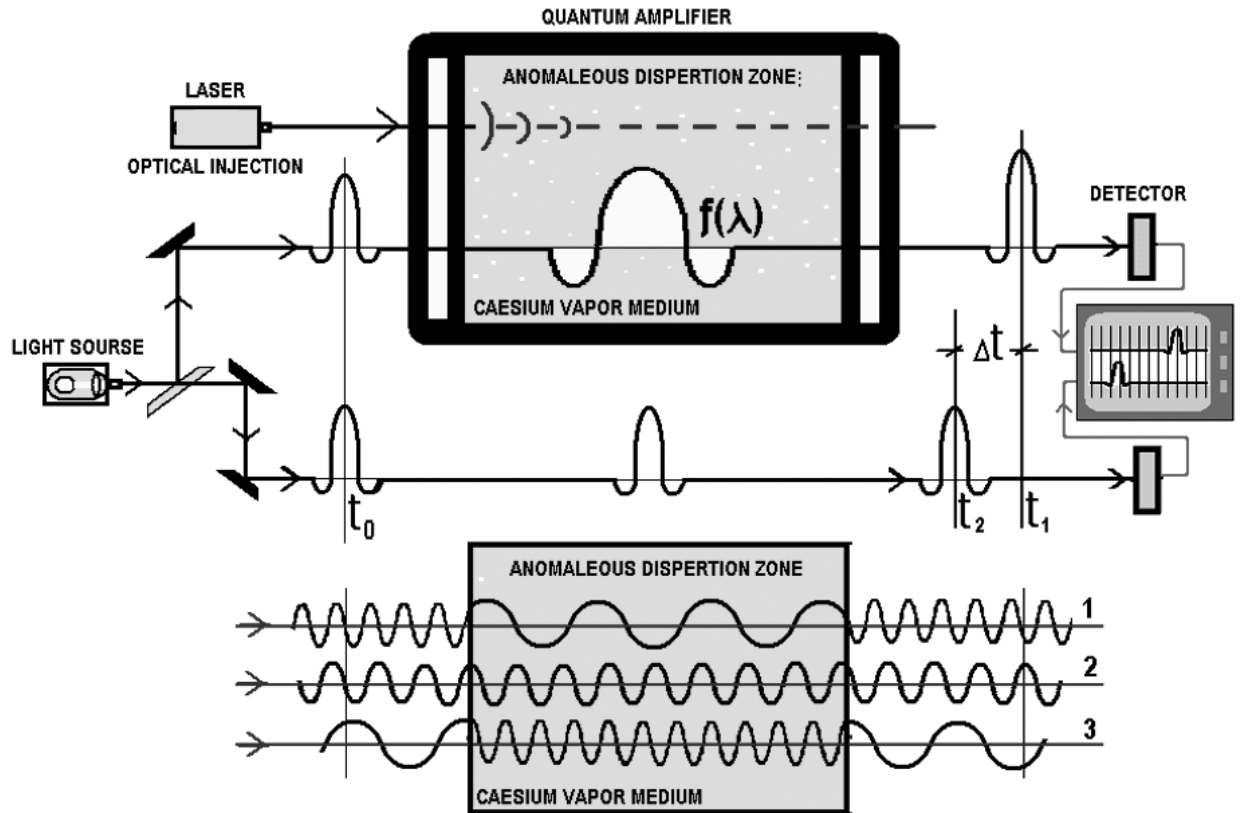

Figure 5. Experiments of L.Wang - superluminal light propagation.

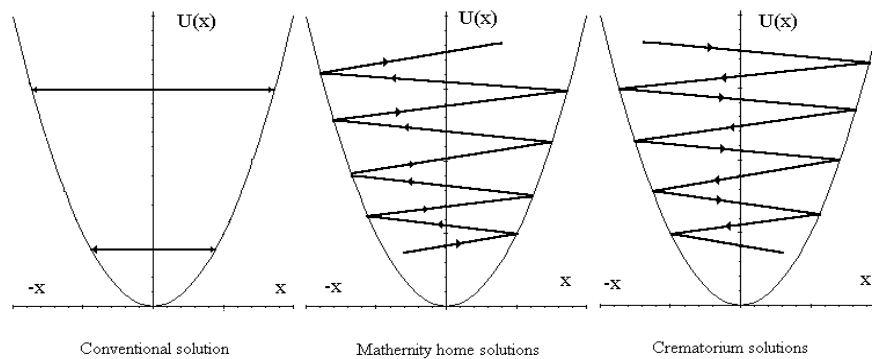

Figure 6.

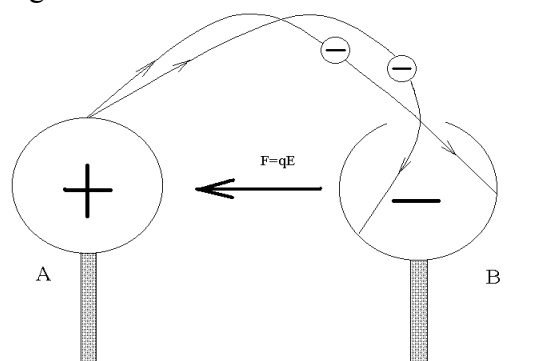

Figure 7. Work for transferring the charge depends on the mode of transferring and on the path.

Questioning the Special and General Relativity

Florentin Smarandache
University of New Mexico
705 Gurley Ave., Gallup, NM 87301, USA
smarand@unm.edu

Abstract. In this paper one revisits several paradoxes, inconsistencies, contradictions, and anomalies in the Special and General Theories of Relativity. Also, one re-proposes new types of Relativities and two physical experiments

1. Introduction.

We have published two books [1, 2] questioning the special and general theories of relativity.

- a) In the first book we presented our 1972 **hypothesis that there is no speed barrier in the universe and one can construct arbitrary speeds** -thus refuting the speed of light postulate.

While Einstein considered a relative space and relative time but the ultimate speed of light, we do the opposite: **we consider an absolute time and absolute space but no ultimate speed**, and we call it the Absolute Theory of Relativity (ATR). The ATR has no time dilation, no length contraction, no relativity of simultaneity, and no relativistic paradoxes.

We then **parameterize Einstein's thought experiment with atomic clocks**, supposing that we know neither if the space and time are relative or absolute, nor if the speed of light is ultimate speed or not. We obtain a Parameterized Special Theory of Relativity (PSTR). Our PSTR generalizes not only Einstein's Special Theory of Relativity, but also our ATR, and introduces three more possible Relativities to be studied in the future.

Afterwards, we extend our research considering not only constant velocities but constant accelerations too.

Eventually we proposed a **Noninertial Multirelativity** for the same thought experiment, i.e. considering non-constant accelerations and arbitrary 3D-curves.

- b) In the second book we considered that **not all physical laws are the same in all inertial reference frames**, and we gave several counter-examples. We also supported **superluminal speeds**, and we considered that **the speed of light in vacuum is variable** depending on the moving reference frame. **Space and time are absolute** (universal), and separated from each other. Lorentz contraction and Minkowski's metric are unrealistic.

We explained that the redshift and blueshift are not entirely due to the Doppler Effect, but rather to the **Medium Gradient and Refraction Index** (which are

determined by the medium composition: i.e. its physical elements, fields, density, heterogeneity, properties, etc.).

We considered that **the space is not curved** and the light near massive cosmic bodies bends not because of the gravity only as the General Theory of Relativity asserts (Gravitational Lensing), but because of the **Medium Lensing**.

In order to make the distinction between “clock” and “time”, we suggested a **first experiment** with a different clock type for the GPS clocks, for proving that the resulted dilation and contraction factors are different from those obtained with the cesium atomic clock; and a **second experiment** with different medium compositions for proving that different degrees of redshifts/blushifts and different degrees of medium lensing would result.

In the next sections we revisit several relativistic inconsistencies and we propose new research directions.

2. Multirelativity with Nonconstant Acceleration and 3D-Curves.

In a 3D-Euclidean space for location and in an $1D$ -oriented Euclidean space for time we consider a reference frame F_1 with respect to which a particle P_0 travels with a nonconstant acceleration a_0 on a 3D curve C_0 in an elapsed time Δt_0 .

Then we suppose the reference frame F_1 is moving with nonconstant acceleration a_1 on a 3D curve C_1 with respect to another reference frame F_2 . Similarly, the reference frame F_2 is moving with a nonconstant acceleration a_2 on a 3D curve C_2 with respect to another reference frame F_3 .

And so on: the reference frame F_{n-1} is moving with a nonconstant acceleration a_{n-1} on a 3D curve C_{n-1} with respect to another reference frame F_n (where $n \geq 2$).

We call this a Noninertial Multirelativity, i.e. the most general case.

2.1. Research Problems on Multirelativity.

- a) How would the particle's trajectory curve C_0 be seen by an observer in the reference frame F_n ?
- b) What would be the particle's speed (acceleration) as measured by the observer from the reference frame F_n ?
- c) What would be the elapsed time of the particle as seen by the observer in the reference frame F_n ?
- d) What are the transformation equations from a reference frame to another?
- e) Similar questions for rotating reference systems.

Particular cases would be helpful in starting such research, for example studying particles or reference frames travelling on linear curves, or on special curves, with constant speeds or constant accelerations, in reference frames that

have one, two, or three parallel coordinate axes. Then later trying to generalize the results.

2.2. Example in Multirelativity of Nonlinear 3D-Trajectories of Particle and Reference Frames.

Since each constant speed v can be considered a constant zero-acceleration with initial velocity v , we treat the general case (i.e. the constant acceleration). Let's consider in the reference frame F_1 a particle P_0 traveling on a curve C_0 from A to B :

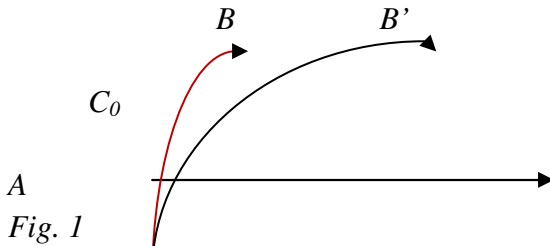

with a constant acceleration a_0 and initial velocity v_0 . Let's take into consideration the earth's gravity g too that influences the trajectory.

F_1 (which has the Cartesian system $X_1Y_1Z_1$) is moving with a constant acceleration a_1 with initial velocity v_1 in the positive direction of the X_1 -axis (the OY_1 - and OZ_1 -axes are parallel respectively with OY_2 and OZ_2) with respect to the frame F_2 (whose Cartesian system is $X_2Y_2Z_2$).

The arclength of AB is noted by d .

From an observer in F_2 the trajectory \vec{AB} of the particle P_0 in F_1 is seen as a 2D- or 3D-curve \vec{AB}' .

The curve AB' is described in F_2 by a function

$$f(a_0, v_0, a_1, v_1, g, C_0, A, B, \theta) = (x_2(t), y_2(t), z_2(t)) \quad (1)$$

i.e.

$$ArcLength(AB') = \int_0^{\Delta t} \sqrt{[x_2'(t)]^2 + [y_2'(t)]^2 + [z_2'(t)]^2} dt \equiv L(\Delta t', \Delta t) \quad (2)$$

where $x_2'(t)$, $y_2'(t)$, $z_2'(t)$ are respectively the derivatives of $x_2(t)$, $y_2(t)$, $z_2(t)$ with respect to t , and $L(\Delta t', \Delta t)$ is a notation to mean that the arclength L , from A to B' , depends on Δt and also on d , but d depends on $\Delta t'$.

The distance traveled by the reference frame F_1 in Δt elapsed time is

$$s_1 = v_1(\Delta t) + \frac{1}{2}a_1(\Delta t)^2 \quad (3)$$

Supposing that particle's traveling is seen as a constant acceleration by the observer in F_2 , then we have:

$$L(\Delta t', \Delta t) = x_{v_0}(\Delta t) + \frac{1}{2}x_{a_0}(\Delta t)^2 \quad (4)$$

where x_{v_0} = the initial particle's velocity as seen by the observer in F_2 ,

and x_{a_0} = the particle's constant acceleration as seen by the observer in F_2 .

We know that in F_1 : $|AB| = d = v_0(\Delta t') + \frac{1}{2}a_0(\Delta t')^2$. (5)

Depending on the suppositions regarding the connections between $\Delta t'$ and Δt (in an absolute time reference frame they are equal), or on the supposition about the acceleration of the particle x_{a_0} and x_{v_0} we get particular cases in formula (1).

The reader can repeat this thought experiment for the case when the accelerations a_0 and a_1 are not constant, and the reference frame F_1 is moving with respect to the reference frame F_2 on an arbitrary 3D-curve.

3. Length Contraction is Independent of Time

The length contraction is, according to the Theory of Relativity, along the direction of the motion. And if the length is perpendicular on the direction of motion there is no contraction (according to the same theory).

My question is this: it looks that the length contraction is independent of time (according to the Theory of Relativity)!... i.e. if a rocket flies one second, or the rocket flies one year the rocket's along-the-motion length contraction is the same, since the contraction factor

$$c(v) = \sqrt{1 - \frac{v^2}{c^2}} \quad (6)$$

depends on the rocket's speed (v) and on the light speed in vacuum (c) only. I find this as unfair, incomplete. It is logical that flying more and more should increase the length contraction.

What about the cosmic bodies that continuously travel, do they contract only once or are they continuously contracting?

4. Elasticity of Relativistic Rigid Bodies?

In the classical Twin Paradox, according to the Special Theory of Relativity, when the traveling twin blasts off from the Earth to a relative velocity $v =$ with respect to the Earth, his measuring stick and other physical objects in the direction of relative motion shrink to half their lengths.

How is that possible in the real physical world to have let's say a rigid rocket shrinking to half and then later elongated back to normal (as an elastic material)? It is more science fiction...

What is the explanation for the traveler's measuring stick and other physical objects, in effect, return to the same length to their original length in the Stay-At-Home, but there is no record of their having shrunk? Where this quantity of Joules of energy come from in order to shrink and then tacitly elongate back the stick?

If it's a rigid (not elastic) object, how can it shrink and then elongate back to normal? It might get broken in this situation. This is like a science game...

5. Relativistic Masses vs. Absolute Masses

Similarly, the relativistic masses are considered as increasing when traveling at a relativistic speed. But if the object is rigid, doesn't it break?

And, by the way, not all masses are variable, there exist absolute masses in the universe.

6. Miraculous Return to the Original Length!

A rocket has length L at rest, afterwards in flying the length shrinks to $L \cdot C(v)$, then suddenly stops. According to the Special Theory of Relativity the rocket's length $L \cdot C(v)$ tacitly returns to its original length! [As the rocket was made of... plasticizer!]

7. Miraculous Return to the Original Mass!

Similarly, assume the rigid rocket's mass at rest is M ; after flying this mass increases to $M/C(v)$. Then, when the rockets stops, according to the Special Theory of Relativity the mass tacitly... returns to its original value (as it was elastic... rocket!).

8. Symmetry and Asymmetry!

In some examples, the Special Theory of Relativity considers a symmetric time dilation of two inertial reference frames.

But in other examples, such as in the GPS position system where the satellite

clocks are slowed because of the satellite velocity, it considers an asymmetric time dilation of two inertial reference frames.

As in the cause of the Twin Paradox, the time dilation was simply... abandoned!
Again an auto-contradiction.

9. Physical and Non-Physical Time Dilation!

The proponents of the Special Theory of Relativity contradict themselves when for some examples they say there is a physical time dilation (e.g. for particle accelerators, *GPS*, *VBLI*, *NASA*), and for other examples there is a non-physical time dilation (for interpreting the Twin Paradox).

This is a self-contradiction.

In the Absolute Theory of Relativity [2] one considers an absolute space, absolute time, absolute observer, and superluminal speeds are allowed. Superluminal phenomena do not involve traveling in time, neither objects traveling at c to having infinite masses, nor objects at superluminal speeds to having imaginary masses.

The speed of light in vacuum is not " c " in all reference frames, but varies. It depends on the speed of its frame of reference and on the observer's frame of reference.

Simultaneity does exist and it is objective in nature.

ATR has no time dilation, no length contraction, no relativistic simultaneities, and all *STR* paradoxes disappear in *ATR*.

10. Density Increasing?

According to the Special Theory of Relativity the mass of a moving object increases with the speed of the object, but what really increases: the object density, the object volume, or both?

Because:

$$Mass = Volume \times Density \quad (7)$$

and since the object length decreases (in the direction of movement), then should we understand that the object volume also decreases?

- a) What is the *Mass-Increasing Factor* equal to?

Einstein himself disliked the concept of relativistic mass given by the formula:

$$M(v) = \frac{m}{\sqrt{1 - \frac{v^2}{c^2}}} \quad (8)$$

where m = rest mass,

and M = relativistic mass of the object moving at speed v .

- b) What is the *Volume-Increasing Factor* equal to?
- c) What is the *Density-Increasing Factor* equal to?

11. The Mass Paradox

The increasing in a moving frame of reference gives birth to another paradox. If there are $n \geq 2$ simultaneous observers, each one moving with a different speed v_1, v_2, \dots , and respectively v_n with respect to the body, then the mass of the body has simultaneously n different values, $M(v_1), M(v_2), \dots, M(v_n)$ respectively in the previous formula, which is impossible and ridiculous in practice, alike in the paradoxism movement.

12. Another Superluminal Thought Experiment

Suppose we have two particles A and B that fly in the opposite direction from the fixed point O , with the speeds v_1 and respectively v_2 with respect to an observer that stays in the point O , as in the below figure:

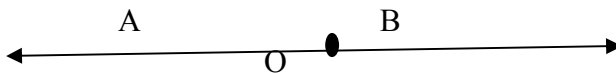

Fig. 2

Let's consider that $v_1 + v_2 \geq c$.

- A) But, an observer that travels with particle A (therefore he is at rest with particle A) measures the speed of particle B as being $v = v_1 + v_2 \geq c$.

Similarly for an observer that travels with particle B : he measures the speed of particle A as also being superluminal: $v = v_1 + v_2 \geq c$.

- B) If we suppose $v_1 = c$ and $v_2 > 0$, then for the observer that travels with particle A his speed with respect to observer in O is c . But, in the same time, for the observer that travels with particle A his speed with respect to particle B should be greater than c , otherwise it would result that particle B was stationary with respect to observer in O . It results that $c + v_2 > c$ for non-null v_2 , contrarily to the Special Theory of Relativity.

C) Let's recall several of Einstein's relativistic formulas:

a) *Time Dilation Formula* is:

$$\Delta t(v) = \frac{\Delta t'}{\sqrt{1 - \frac{v^2}{c^2}}} \tag{9}$$

where Δt = non-proper time,
and $\Delta t'$ = proper time.

b) *Length Contraction Formula* is:

$$L(v) = L' \cdot \sqrt{1 - \frac{v^2}{c^2}} \quad (10)$$

where L = non-proper length,
and L' = proper length.

c) *Relativistic Momentum Formula* of an object of mass m , moving with speed v , is:

$$p(v) = \frac{mv}{\sqrt{1 - \frac{v^2}{c^2}}} \quad (11)$$

d) *Energy Formula* of an object at rest, with rest mass m , is

$$E_0 = mc^2 \quad (12)$$

e) *The Total Energy Formula* of an object of mass m , moving at speed v , is:

$$E(v) = \frac{mc^2}{\sqrt{1 - \frac{v^2}{c^2}}} \quad (13)$$

f) *Kinetic Energy Formula* of an object of mass m , moving at speed v , is:

$$E(v) = mc^2 \left(\frac{1}{\sqrt{1 - \frac{v^2}{c^2}}} - 1 \right) \quad (14)$$

Let's consider instead of particles two objects A and B flying in opposite directions as above.

C1) Firstly, when a clock goes at speed c with respect to any observer frame, the Special Theory of Relativity breakdown (because time dilates to infinity, length contracts to zero, relativistic momentum is infinity, the total energy and the kinetic energy are also infinite)! One actually gets the indeterminacy $1/0$. Similarly in Lorentz Relativity for a clock going at speed c with respect to the Preferred Frame.

C2) Not talking about superluminal speeds for which, according to the Special Theory of Relativity, the non-proper time, non-proper length, relativistic momentum, total energy and kinetic energy becomes... imaginary!

D) We have hypothesized [2] that superluminal particles do exist and they do not necessitate infinite energy for

traveling since the above Einstein's 2.13.C a)-f) relativistic formulas are valid in an imaginary space, not in the real one.

13. Another Dilemma about Length Contraction

The distance between Earth and Alpha Centauri (which is the closest star to our solar system) is 4.3 light-years, as measured by an observer on our planet.

A particle travels from Alpha Centauri to Earth at speed $v = c$ (for example a photon) relative to the observer on Earth.

According to Einstein's Special Theory of Relativity:

$$\mathcal{C}(v) = \sqrt{1 - \frac{v^2}{c^2}} \in [0,1] \text{ for } v \in [0,c]. \quad (15)$$

$$L = L' \cdot \mathcal{C}(v), \quad (16)$$

where L' = proper length (which is the distance between two points measured by an observer at rest with respect to them);

L = non-proper length (distance between two points measured by an observer that is not at rest with respect to them);

v = constant speed of the moving reference frame;

c = speed of light in vacuum.

Therefore the contracted length:

$$L = (4.3 \text{ lightyears}) \cdot \sqrt{1 - \frac{c^2}{c^2}} = 0, \quad (17)$$

which is a contradictory result since the distance between Alpha Centauri and Earth is much far from zero, and even from the reference frame of the moving photon it takes to the photon 4.3 light-years to get to Earth.

14. The Paradox of Simultaneity: Who is the Killer?

We change Einstein's thought experiment on simultaneity in the following way. Let's consider a train moving as below from left to right:

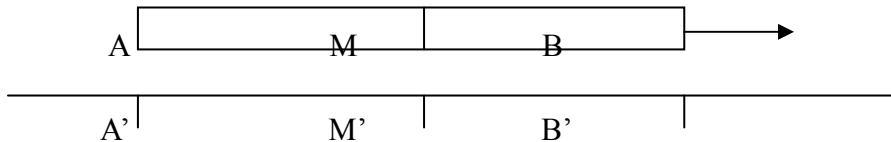

Fig. 3. The Paradox of Simultaneity

And a passenger Marcello in the middle point M of AB. A and B are the end and respectively the beginning of the train. Assume that in the train at the joints A and B there are Alex and respectively Barbara carrying each of them a gun of same caliber and bullet speed. Simultaneously, according to an observer O_t who stays at the midpoint M in the train, Alex and Barbara fatally shoot Marcello in the heart. Therefore according to observer in the train O_t , both Alex and Barbara are guilty of first degree murder, since both their bullets penetrate Marcello's heart in the same

time. Therefore Alex and Barbara are both killers.

Let's consider another observer O_e on the embankment, who sits at the midpoint M' which coincides with M . Similarly on the embankment the points A' and B' coincide respectively with A and B . According to the observer on the embankment, O_e , upon Einstein's Special Theory of Relativity because the train moves from left to right, Barbara's bullet penetrates Marcello's heart and kills him before Alex. Therefore Barbara is a killer.

But Alex is not a killer, since his bullet arrives later than Barbara's, therefore Alex's bullet penetrates a dead body (not a living body). According to the observer on embankment, O_e , it's Barbara who fired the gun before Alex did.

Contradiction.

14.1. The Dilemma of Simultaneity

Let's consider two entangled particles A and B flying in the opposite directions. Let's assume they are so far away that light needs much time to travel from A to B .

If A is in state s , it instantaneously causes B to be in state s too.

We disagree with Theory of Relativity's statement that there are no influences that travel faster than light.

According to the Special Theory of Relativity we have:

- A) For an observer O_1 , traveling with particle A at time t , the event "A is in state s " occurs before the event "B is in state s ".
- B) For another observer O_2 , traveling with particle B at time t , the event "A is in state s " occurs after the event "B is in state s ".
- C) But these two observers are in contradiction with a quantum observer O_3 , which sits in the point M , where the particles started to fly from. O_3 , measuring particle A to be in state s at time t , will automatically know that particle B is in state s as well. Therefore, for the quantum experimenter O_3 the particles A and B are simultaneously in the state s .



Fig. 4

14.2. Relativity of Simultaneity is Just an Appearance

In general let's consider two simultaneous events in a reference frame at rest with respect to the events.

In a moving reference frame, the same events don't look simultaneous, but this is only an appearance, a subjective impression.

In our Absolute Theory of Relativity we have no relativity of simultaneity.

15. Minowski's Spacetime in Heterogeneous Medium

In general, let's consider two simultaneous events in a reference frame at rest with respect to the events. In a moving reference frame the same events don't look simultaneous, but this is only an appearance.

Let's consider the locations $L_1(x_1, y_1, z_1)$ and $L_2(x_2, y_2, z_2)$ and times $t_1 < t_2$. The spacetime distance between the events $E_1 = \{I \text{ bread}\}$ at (x_1, y_1, z_1, t_1) , and $E_2 = \{I \text{ bread}\}$ at (x_2, y_2, z_2, t_2) gives the answer:

$$d^2(E_1, E_2) = c^2(t_2 - t_1)^2 - [(x_2 - x_1)^2 + (y_2 - y_1)^2 + (z_2 - z_1)^2] \quad (18)$$

Let's say that $d(E_1, E_2) = 0$, then $d(E_1, E_2)$ means that light has travelled in vacuum from location L_1 to location L_2 in the period of time $t_2 - t_1$.



But we see no connection between the fact that “I bread” and the fact that “light travels in vacuum on a distance equals to $|L_1L_2|$ ”!

Let's change this thought experiment and suppose that both locations $L_1(x_1, y_1, z_1)$ and $L_2(x_2, y_2, z_2)$ are under water, somewhere in the Pacific Ocean. Now light in the water has a smaller speed (c_w) than in vacuum, i.e. $c_w < c$. Therefore within the same interval of time $t_2 - t_1$, light travels in the water a lesser distance than L_1L_2 . Thus $d(E_1, E_2)$ has a different representation now L_1L :

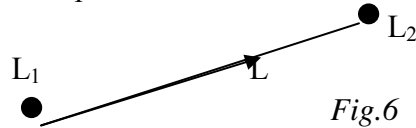

And, if instead of water we consider another liquid, then $d(E_1, E_2)$ would give another new result.

Therefore, if we straightforwardly extend Minkowski's spacetime for an aquatic only medium, i.e. all locations $L_i(x_i, y_i, z_i)$ are under water, but we still refer to the light speed but in the water (c_w) then the coordinates of underwater events E_w would be $E_w(x_i, y_i, z_i, c_w, t_i)$ and Minkowski underwater distance would be:

$$d_w^2(E_{w1}, E_{w2}) = c_w^2(t_2 - t_1)^2 - [(x_2 - x_1)^2 + (y_2 - y_1)^2 + (z_2 - z_1)^2] \quad (19)$$

But if the underwater medium is completely dark it might be better to consider the speed of sound as aquatic animals used in order to communicate (similarly as submarines use sonar). Let's denote by s_w the underwater speed of sound. Then the underwater events $E_{ws}(x_i, y_i, z_i, s_w, t_i)$ with respect to the speed of sound would have the Minkowski underwater distance:

$$d_{ws}^2(E_{ws1}, E_{ws2}) = s_w^2(t_2 - t_1)^2 - [(x_2 - x_1)^2 + (y_2 - y_1)^2 + (z_2 - z_1)^2] \quad (20)$$

Similarly for any medium M where all locations $L_i(x_i, y_i, z_i)$ are settled in, and for speed of any waves W that can travel from a location to another location in this

medium.

15.1. Spacetime Diagram Didn't Take into Account the Medium Composition

The problem becomes more complex when one has a heterogeneous medium and the waves travel with a speed v_1 in a part and another speed v_2 in another part, and so on [we mean the speed of light in liquids, in plastic, in glass, in quartz, in non-vacuum space in general]...

15.2. The Spacetime-Interval does not Distinguish Between Events' Nature.

If an event E_1 occurs at location $L_1(x_1, y_1, z_1)$ and time t_1 , and another event E_2 occurs at the location $L_2(x_2, y_2, z_2)$ and time t_2 , with $t_1 \leq t_2$, in the Minkowski spacetime, the squared distance $d^2(E_1, E_2)$ between them is the same and equal to:

$$\Delta s^2 = c^2(t_2 - t_1)^2 - [(x_2 - x_1)^2 + (y_2 - y_1)^2 + (z_2 - z_1)^2] \quad (21)$$

no matter what kind of events we have!

For example, if one has the event $E_1 = \{John\ drinks\}$ and the event $E_2 = \{George\ eats\}$, there is no connection between these two events. Or if one has two connected events: $E_1 = \{Arthur\ is\ born\}$ and $E_2 = \{Arthur\ dies\}$. There

should be at least one parameter [let's call it "N"] in the above (Δs^2) spacetime coordinate formula representing the event's nature.

15.3. The Real Meaning of the Spacetime-Interval

The spacetime interval is measured in light-meters. One light-meter means the time it takes the light to go one meter, i.e. 3×10^{-9} seconds. One can rewrite the spacetime interval as :

$$\Delta s^2 = c^2(\Delta t)^2 - [(\Delta x)^2 + (\Delta y)^2 + (\Delta z)^2] \quad (22)$$

There are three possibilities:

a) $\Delta s^2 = 0$ means that the Euclidean distance $L_1 L_2$ between locations L_1 and L_2 is travelled by light in exactly the elapsed time Δt . The events of coordinates (x, y, z, t) in this case form the so-called light cone.

b) $\Delta s^2 > 0$ means that light travels an Euclidean distance greater than $L_1 L_2$ in the elapsed time Δt . The below quantity in meters:

$$\Delta s = \sqrt{c^2(\Delta t)^2 - [(\Delta x)^2 + (\Delta y)^2 + (\Delta z)^2]} \quad (23)$$

means that light travels further than L_2 in the prolongation of the straight line L_1L_2 within the elapsed time Δt .

The events in this second case form the time-like region.

c) $\Delta s^2 < 0$ means that light travels less on the straight line L_1L_2 . The below quantity, in meters:

$$-\Delta s = \sqrt{-c^2(\Delta t)^2 + [(\Delta x)^2 + (\Delta y)^2 + (\Delta z)^2]} \quad (24)$$

means how much Euclidean distance is missing to the travelling light on straight line L_1L_2 , starting from L_1 in order to reach L_2 .

The events in this third case form the space-like region. We consider a diagram with the location represented by a horizontal axis (L) on $[0, +\infty)$, the time represented by a vertical axis (t) on $[0, +\infty)$ perpendicular on (L), and the spacetime distance represented by an axis (Δs) perpendicular on the plane of the previous two axes. Axis (Δs) from $[0, +\infty)$ is extended down as $(-\Delta s)$ on $[0, -\infty)$.

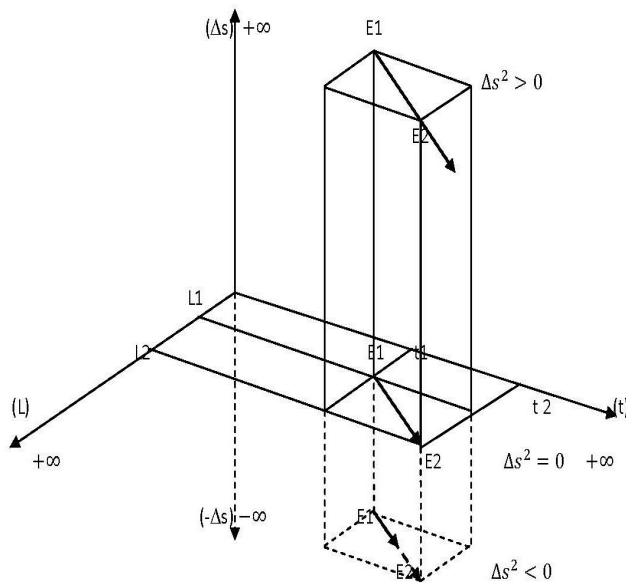

Fig. 7

16. Relative or Absolute?

It is strange the fact that the space is considered relative and time also relative in the Theory of Relativity, but the so-called spacetime is absolute; this is an oxymoron. Transforming time into space, or reciprocally, is just a funny concoction, but unreal. Since the spacetime is absolute, it is not clear if anything is relative in the Theory of Relativity or not?

17. Controller is not Aware

Let's assume that the controller is not aware of the flying rocket. Then does it still exist a time dilation for the controller and space contraction for the astronaut? The relativists again say that it is "meaningless" (undecidable). But what kind of theories give birth to undecidable propositions? Incomplete or inconsistent theories.

18. Distorted Bodies

By space contraction, the bodies are distorted, i.e. the proportions are not kept and angles in general are not invariant (only the right angles formed by body's edges perpendicular on other body edges along the motion are invariant). For the right triangle:

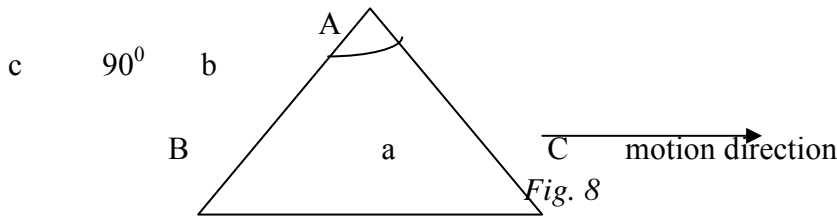

$a^2 = b^2 + c^2$ with $\angle A = 90^\circ$, but after lengths' contraction, the edges become:

$$a' = a \cdot C(v) \tag{25}$$

$$b' = b \cdot OC(v, \theta) \tag{26}$$

$$c' = c \cdot OC(v, 90^\circ - \theta) \tag{27}$$

But in general

$$(a')^2 \neq (b')^2 + (c')^2, \text{ so } \angle A' \neq 90^\circ, \text{ or } \angle A' \neq \angle A. \tag{28}$$

19. Pure Gravitational Field?20

The General Theory of Relativity asserts that it is possible to have a pure gravitational field, without any matter at all, which acts as a source for itself.

Then the following questions arise: What does happen to the cosmic travelling small, medium and massive objects to the atomic and sub-atomic particles in this pure

gravitational field? Do they fall to the bottom of the pure gravitational field, and do they eventually form a compact cosmic body whose own gravitational field is this pure gravitational field?

Does it exist any experiment proving that gravity influences light speed or light trajectory? Does indeed gravity attract light?

{The light escaping or not a gravitational field in General Theory of Relativity or in a Black Hole can be considered if it has been experimentally proven that light is influenced by gravity.}

Also, if *mass produces gravity* and *gravity produces mass*, then it results that pure gravitational field will produce/generate some mass. How? Will objects, dust, particles be attracted in and condensed into a compact body inside of this pure gravitational field?

20. Other Pure Fields?

As a generalization of the previous Pure Gravitational Field, is it possible to have a Pure Magnetic Field, or Pure Electric Field, or Pure Electromagnetic Field, etc. without matter in its proximity?

21. Conservation Law for Gravity?

A) If a planet explodes or is destroyed, what does happen to the planet gravitational field? Does it disappear? Does there exist a conservation law for gravity?

For example: If a planet is split into $n \geq 2$ parts, will the planet gravitational field be also split among these n parts?

Is the gravitational field conserved or transformed? If transformed, would it be into energy?

22. What Happens to the Curved Space around a Massive Object that has been Destroyed?

A) According to the General Theory of Relativity the space is curved around a massive object. Then, after the planet explodes (due to internal forces) or destroyed (because of external forces) does the space around it still remain curved or does it straighten back to flat?

How would the disappearance of a planet impact the other planets? Will its orbit be occupied by another cosmic object that might be forming from residues that fall into this orbit?

B) If space is curved around a star and forms tracks that planets travel following these tracks as rail-roads, why not other (small, or medium, or massive) objects are falling into these tracks and traveling around the star on the same orbits?

23. What Happens to the Planets that Orbit a Star that has Died?

If a star explodes or is destroyed or dies, what happens to the planets that orbit it? Will they continue to orbit by inertia the point where the star used to be? For how long time?

24. Is Time an Entity without Beginning and Ending?

Is there a beginning and ending of time? Or is the time an entity without ending or beginning?

We doubt the Big Bang Theory that asserts a *creatio ex nihilo* of the Universe...

If it was a point in the Big Bang that exploded, where did this point come from? What was before that point?

25. Creating Gravity

Massive cosmic bodies create gravity. Is there a bound for such cosmic bodies (depending on mass, volume, density, and may be position) starting from which cosmic bodies create gravity, while below that bound they don't create gravity?

26. Not All Physical Laws are the Same in All Inertial Reference Frames

A. Different Inertial Values for a Moving Object.

The laws of physics are not the same in all directions for a moving object according to the Special Theory of Relativity,

since lengths which are oblique to the direction motion are contracted with the oblique-factor $OC(v,\theta)$,

while the lengths along the motion direction are contracted with a different factor $C(v)$,

but lengths that are perpendicular to the direction motion are not contracted at all;

which require different inertia values for the moving object.

B. There are universal constants that are not quite "constant" throughout the universe.

C. Would it be possible to get physical systems where the energy conservation law doesn't hold?

D. Would it be possible to get physical systems where the Earth's physical laws are invalid?

Maybe our laws are only local, but non-local laws may apply in other galaxies.

We believe on other planets, or in other solar systems, galaxies the laws of physics are not the same.

The Laws of Physics are influenced by the medium composition, velocity, etc. of the frame of reference.

27. Back in Time?

If the time runs faster at the top of a gravitational field than at the bottom of a gravitational field, then sending a signal from top down could be like a message sent

back in time, which is unrealistic!

28. Wormholes do not Exist in a Real World

The Wormholes were predicted by the Theory of Relativity [through Hermann Weyl in 1921 and John Archibald Wheeler in 1957], but the Wormholes permit time travel (that is unrealistic) and violate the causality.

The Wormholes can be valid in an imaginary space only.

29. Newton's Physics or Einstein's Metaphysics?

Is it any threshold of the speeds, let's say $\alpha \cdot c$, with $\alpha \in [0,1]$, such that for the speeds $0 \leq v \leq \alpha \cdot c$ we apply Newton's Physics, and for the speeds $v > \alpha \cdot c$ we apply Einstein's Special Relativity?

The proponents of Special Relativity say that Einstein's Velocity Addition Formula

$$v_1 + v_2 = \frac{v_1 + v_2}{1 + \frac{v_1 \cdot v_2}{c^2}} \quad (29)$$

prevails for any speeds. But this formula fails for superluminal speeds.

30. Neither $2c$ is a Speed Limit

We do not agree with the *Lorentz Relativity* and the *Lorentz Ether Relativity* that support superluminal speeds up to a limit of $2c$, although the absolute velocities are added using normal arithmetic in these two Relativities. We think there can be constructed speeds that overpass $2c$ as well.

31. Subjective Dilation-Time

For two observers, in two moving referential frames, each one sees a time dilation for the other (time-dilation symmetry). But this is clearly a *subjective time dilation*, not an *objective time dilation*.

These symmetric time dilations cannot be simultaneously done in practice; it is absurd.

32. Subjective Local Time vs. Objective Global Time

The proponents of the Theory of Relativity assert that the so-called black hole is so powerful, that even the time itself is brought to a stop. But this looks very much as science fiction, since the objective time goes on anyway.

33. Relative vs. Absolute Space and Time

Einstein says that there is no absolute space or absolute time. But we argue that we can mathematically consider an absolute space and absolute time, in order to eliminate all paradoxes and anomalies from Theory of Relativity.

Relative Space and Time are referring to Subjective Theory of Relativities, while Absolute Space and Time are referring to Objective Theory of Relativity {see the

Absolute Theory of Relativity [2]}.

The observers are relative, subjective indeed, but mathematically there can be considered an *Absolute Observer*. {There are things which are absolute.}

34. Contraction of the Universe?

If the Universe is expanding (therefore moving), according to the Special Theory of Relativity it should be contracting along the moving direction.

Continuously moving bringing continuously contracting?... therefore until getting back to a point (as the supposed original Big Bang)?

35. The Michelson-Morley Null Experiment was not quite Null

While the establishment interpreted the result of Michelson-Morley Experiment as null, many other researchers considered it as not quite null.

The supposed Michelson-Morley *Null* Experiment instigated the physical theorists to invent Relativity Theories with abnormal/non-practical length contraction, time dilation, mass increase, etc.

36. Variable Speed of Light in Vacuum

The speed of light in vacuum is not invariant as seen by different frame of reference observers. It depends on the light source and its frame of reference.

Its addition with other speeds follows the classical law of velocity addition.

37. Instantaneous Acceleration?

In all paradoxes involving movement it is supposed that something goes at a constant uniform speed. One assumes a so-called "instantaneous acceleration": it is considered the ideal case when jumping from zero velocity directly to velocity v , and similarly jumping back from v to zero velocity when stopping. Therefore, many Thought Experiments are just approximations, no matter how large is the segment of constant speed with respect to the acceleration segment, because one cannot get to the constant speed without starting from zero speed.

38. Where the Extra-Mass Comes from?

Relativistic Mass increases with speed according to the Theory of Relativity. But an elementary question arises: where the extra-mass comes from?

Also, how the extra-mass was produced? Where did the extra-energy come from?

Assuming that the initial mass has a charge, then does the increased mass have the same charge?

39. Space is Not Curved

For a $1D$ (one-dimensional)-curve one can see its curvature in a $2D$ -space.

For a $2D$ -surface one can see its curvature in a $3D$ -space.

But how to see the curvature of a $3D$ -body, since there is no $4D$ -space in the real world? {We do not talk about the spacetime which has dimension four, since the spacetime is unreal.}

Some physicists assume the possibility of hidden dimension(s), but such things have

not yet been found.

Since there is no $4D$ -space in the real world (time is not taken into consideration since it is an independent entity), the $3D$ -space cannot be curved.

40. Black Hole is an Imaginary Cosmic Body

Since the Black Hole purely aroused from the mathematical solution by Schwarzschild (and Hilbert) to the Einstein's Field Equations, and because Einstein's Field Equations do not describe the real universe, the Black Hole is so far just an imaginary cosmic body (or the notion of "black hole" has to be redefined).

While the Black Body, for example, is a theoretical ideal (not entirely realized in practice, but only approximated...), which has not at all the power of reflecting light, the relativists consider the Black Hole as a physical object (!)

41. Fact or Mathematical Artifact?

Interestingly, even the Black Hole's center, which is a point of infinite density and zero volume (which looks fantastic!), is considered a real physical entity, although clearly it is a mathematical artifact.

42. What is the Maximum Discovered Density in the Universe?

Since no experiment has ever shown a density being infinite for a physical object in the universe, our question is what would be the maximum discovered density in the universe? Would it be possible to create any given density?

43. Maximum Strongest Fields?

- a) What is the strongest gravitational field in the universe?

What would be the maximum gravitational field to be produced in the laboratory?

- b) Similarly, what is the strongest electric field in the universe?

What would be the maximum electric field to be produced in the laboratory?

- c) Similarly, what is the strongest magnetic field in the universe?

What would be the maximum magnetic field to be produced in the laboratory?

44. How to Compute the Mass of a Singularity Point?

Let's consider the Black Hole's singularity that occurs for $r = 0$ in

$$g_{00} = \left(1 - \frac{2Gm}{c^2 r}\right)^{1/2} \quad (30)$$

where

m = mass of the spherically cosmic body;

G = gravitational constant of the body;

r = distance from the cosmic body to the clock;

c = speed of light in vacuum;

and represents, according to the relativists, an *infinitely dense point-mass* that is at the center of the Black Hole.

It is not clear how to compute the mass of this singularity, since

$$\begin{aligned} \text{Mass} &= \text{Volume} \times \text{Density} = \\ &= 0 \times \infty = 0, \infty, \text{ or another value?} \end{aligned} \quad (31)$$

Another singularity occurs for

$$r = \frac{2Gm}{c^2} \quad (32)$$

in

$$g_{11} = \frac{-1}{\left(1 - \frac{2Gm}{c^2 r}\right)^{1/2}} \quad (33)$$

And it is considered by relativists as Schwarzschild radius of a Black Hole, or the radius of the event horizon.

45. Mute Body

What about a cosmic body whose escape speed would be greater than the speed of sound (instead of the speed of light)? Therefore, no sound would come out from that body, so it would be labeled as “mute body”!

46. Travel in Time is Science Fiction

Relativists also support the travel to the past and travel to the future. But these are not possible in reality (see the *traveling time paradoxes*, where travelers change the past or the future). Because, for example, if somebody has changed the past, we don't know which one was the real past, the original one or the changed one? It is not possible to have two or pasts!

Relativists conclude that it is possible to travel in the future in the real world, because when we board an aircraft, for example, we are moving with respect to those who remain behind, therefore our time will pass slowly compared to those who remain behind. But this is an illusion since according to the absolute observer time is the same in moving or staying reference frame. Maybe the biological or subjective time changes, but not the objective time.

47. Time Coming to a Halt?

According to the relativists, when

$$\left(1 - \frac{2Gm}{c^2 r}\right)^{1/2} = 0 \quad (34)$$

the time would come to a halt, because Schwarzschild's solution to Einstein's Field Equations for a spherically symmetric body shows that the rate of the clock is reduced by the factor

$$\left(1 - \frac{2Gm}{c^2 r}\right)^{1/2} . \quad (35)$$

But in the real world this is fantasy!

48. No Wormholes

Therefore, Einstein-Rosen Bridge, as a solution to Einstein's Field Equations, which allegedly connects different regions of the universe and just could be used as a time machine, is just fictitious.

49. Escape Velocity

The escape velocity from an alleged Black Hole is

$$c = \sqrt{2Gm / r} . \quad (36)$$

But in the future technology, it would be able to accelerate a photon inside of a Black Hole's event horizon to have it travel at a speed greater than c . Also the superluminal particles would escape.

Thus the Black Hole would not be black any longer.

50. What about more Cosmic Bodies?

Schwarzschild considered only one cosmic spherical body when solving Einstein's Field Equations. But, what about more cosmic bodies (or more Black Holes)?

51. No Universe Expansion since Earth is not the Center of the Universe

Hubble's Law (1929) says that all galaxies are moving away from Earth at a velocity which is directly proportional to their distances from Earth. It presumes that, due only to the velocity at which the galaxies are moving away from the Earth, one has the redshift.

Yet, it looks that Hubble's Law is not followed by the *quasars*, which have big redshifts, emit large amounts of energy and lie behind our Milky Galaxy.

According to Hubble's Law, the *universe is expanding*, and the velocity of a receding galaxy with respect to our Earth is

$$v = H_0 \cdot D \quad (37)$$

where H_0 = Hubble's Constant, and H_0 is between 50-100 (typically 70) km/sec per megaparsec (3.26 million light-years);

and D = distance from the galaxy to the Earth.

But, if the galaxies recede with respect to the Earth at a velocity proportional to their distances from Earth, it involves that our Earth is, or is becoming, the center of the universe.

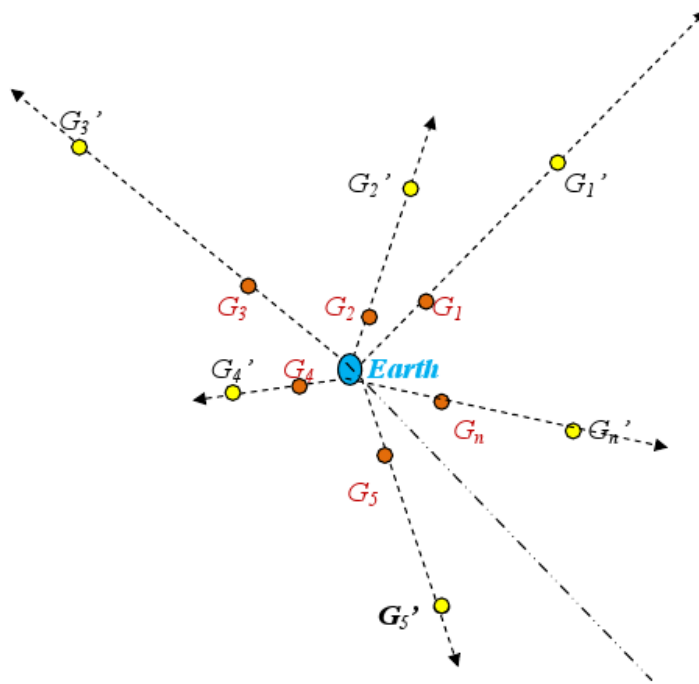

Fig. 9. Diagram of Allegedly Expansion Universe

In the above diagram, the Earth stays in the expansion center, and $G_1, G_2, \dots, G_n, \dots$ are galaxies, while $G_1', G_2', \dots, G_n', \dots$ are respectively their expansion positions after a certain t_1 . The diagram is continuously extended in all directions, according to Hubble's Law, and after times t_2, t_3, \dots the corresponding new positions of the galaxies would respectively be $G_1'', G_2'', \dots, G_n'', \dots$ at time t_2 , then $G_1''', G_2''', \dots, G_n''', \dots$ at time t_3 , etc. the galaxies getting further and further from the Earth, i.e. pushing the Earth closer and closer to the center of all galaxies.

Even if Earth was not the center of the universe at the alleged Big Bang, after such permanent expansion of the universe with respect to the Earth, it would result that the Earth is in process of becoming the center of the universe... But the experiments do not show that.

52. Photon's Wavelength Stretching and Shrinking?

The photon is considered of having a dual form: wave and particle.

If the photon is a wave, it has been asserted that the photon's wavelength is stretched inside the intergalactic space, because of the expansion of the universe. But what happens with the photon's wavelength when the photon enters a galactic space (which is not expanding), and afterwards it exists the galactic space and enters an intergalactic space (which is expanding), and so on?

But, when the wavelength increases the wave frequency decreases (redshift); therefore the wave's momentum and energy are diminished in the expansion of the universe. It seems to be an antithesis between the quantum mechanics (Copenhagen style) and the universe expansion.

If the photon is a particle, similarly because of the so-called expansion of the universe, does its pathlength increases inside the intergalactic space (which is expanding) and decreases inside the galactic space (which is not expanding)? Thus, what happens with its pathlength when the photon passes from an intergalactic space to a galactic space, then again to intergalactic space, and so on?

53. White Holes?

From Einstein's Field Equations one can also deduce the so-called White Holes, which are opposite to the Black Holes, and their property is that things are spewing out from the White Holes. But then if all matter is spewing out, as in antigravity, then the White Hole would contain no matter at all. Will it then remain only as a pure antigravity field? Very strange cosmic object...

54. Scientific Perversity

If data obtained from any experiment or application matches the Theory of Relativity, then that type of data is considered covered by and supporting the Theory of Relativity.

But, if such data does not match the Theory of Relativity predictions, then it is considered as not covered by the Theory of Relativity, and therefore (!) not contradicting the Theory of Relativity.

All pretended tests of General Relativity can be solved without using the General Relativity.

That's why it became a break in the developing of science since every experiment and theory has not to be in conflict with Einstein's Theory of Relativity, which became a fictitious theory producing confusions, ambiguities and self-contradictions. Unfortunately the optical illusions were taken for realities...

An untrue hypothesis that "the speed of light is constant in vacuum in all reference frames (no matter with what uniformly moving speeds!) in all directions" generates a theory whose consequences are weird, non-common sense, even anti-logical and unrealistic. From invalid postulates one gets ridiculous conclusions like in comic stories.

The physicists dream too much and suddenly they invent fantasy theories and require us to take them for granted.

Theories that produce fantastic consequences are fantastic themselves.

Einstein's Relativity is more a science game than reality.

Lorentz Transformation is just a distortion factor of the reality.

The *Gravitational Waves* have not been discovered.

Einstein's Field Equations and *Pseudotensor* are valid in an imaginary space only. There is no proof that Einstein's Field Equations do not violate the common law of conservation of energy and momentum.

Other times, in order to bridge the gap between the Theory of Relativity and experimentally found data, all kind of strange things and ideas are invented.

Instead of fitting the theory to better describe the reality, the reality is distorted in

order to fit into the theory!

References:

1. Smarandache, Florentin, *Absolute Theory of Relativity & Parameterized Special Theory of Relativity & Noninertial Multirelativity*, 92 p., 1982, Somipress, Fès, Morocco.
2. Smarandache, Florentin, *New Relativistic Paradoxes and Open Questions*, 126 p., 1983, Somipress, Fès, Morocco.
3. Bell, J. S., *On the Einstein-Podolsky-Rosen Paradox*, *Physics* 1, pp. 195-200, 1964.
4. Bohm, D., *The Paradox of Einstein, Rosen, and Podolsky*, *Quantum Th.*, pp. 611-623, 1951.
5. Einstein, A.; Podolsky, B.; and Rosen, N., *Can Quantum-Mechanical Description of Physical Reality Be Considered Complete?*, *Phys. Rev.* 47, pp. 777-780, 1935.
6. Smarandache, F., *There is No Speed Barrier in the Universe*, mss., Liceul Pedagogic Rm. Valcea, Physics Prof. Elena Albu, 1972.
7. Rindler, W., *Length Contraction Paradox*, *Am. J. Phys.*, 29(6), 1961.
8. Einstein, A., *Zur Elektrodynamik bewegter Körper*, *Annalen der Physik*, Vol. 17, pp. 891-921, 1905.
9. A. Einstein, *On the Electrodynamics of Moving Bodies*, *Annalen der Physik*, **17**, 891-921, 1905.

Unsolved Problems in Special and General Relativity

This book includes 21 papers written by 23 authors and co-authors. All papers included herein are produced by scholars from People's Republic of China, except two papers written by Prof. L. Sapogin, V.A. Dzhani­bekov, Yu. A. Ryabov from Russia, and by Prof. Florentin Smarandache from USA. The editors hope that the papers included here will contribute to advance scholarly research on some aspects of Special and General Relativity. This book is suitable for students and scholars interested in studies on physics.

Contributors:

Hua Di
Li Zifeng
Li Wen-Xiu

Hu Chang-Wei
Jiang Chun-Xuan
Liu Taixiang

Shi Yong-Cheng
Xu Jianmin

Tu Runsheng
Wu Fengming

Dong Jingfeng
Duan Zhongxiao
Fu Yuhua
Guo Kaizhe

Yang Shijia
Cao Shenglin
Leo G. Sapogin

Guo Chongwu
Guo Ying-Huan
Guo Zhen-Hua

V.A. Dzhani­bekov
Yu. A. Ryabov
Florentin Smarandache

ISBN 9781599732206



9 781599 732206