

The Splitting Dark Matter- Black Hole- Big Bang and the Cyclic Multiverse.

**Leo Vuyk,
Architect,
the Netherlands.**

Abstract,

According to Quantum FFF Theory, the FORM and MICROSTRUCTURE of elementary particles, is supposed to be the origin of FUNCTIONAL differences between Higgs- Graviton- Photon- and Fermion particles.

As a result, a NEW paradigm of splitting-, accelerating- and pairing Black Hole seems to be able to accelerate itself by a -Zero Point Energy driven-self created plasma tails (by a new Quantum Fluctuation process), to form dumbbell systems, of two or even more black holes. Inside Nebula these dumbbell systems are called Herbig Haro systems.

Inside the early universe however these systems are observed as dumbbell shaped radio lobes at both sides of early galaxies (Faint B3 radio galaxies).

Recent cosmic observations of the infra red and x-ray background radiation of the universe by Chandra and Spitzer space telescopes (CIB and CXB), suggest that even direct after the big bang ABUNDANT black holes already existed.

This can be interpreted as a support for a Black Hole splitting Big Bang and a Black Hole pairing Big Crunch before, thus there is reason to propose a cyclic Universe.

In Quantum FFF theory, the chirality of the universal vacuum lattice is proposed to be the origin of negative- or positive charged black holes and the origin of the formation of matter over anti-matter around negative charged black holes as in our universe seems to be the case.

The chirality of the oscillating Higgs vacuum is supposed to be the origin of preferred Positron attachment with three different shaped monopole Gluon/photons for easy Quark formation without a lot of particle annihilation back into the Higgs vacuum.

At the same time, the possibility of a chiral universal vacuum is reason to support the idea of a super symmetric raspberry shaped multiverse, with multiversal copy universes, instant entangled down to all quantum systems.

Introduction.

Quantum FFF (Function Follows Form) theory states, that the vacuum is seeded with fast oscillating massless Higgs particles (dark energy) , oscillating along a complex chiral tetrahedral vacuum lattice, which has the ability to transfer Photon and Graviton FORM information in bunches of oscillations (in wave form) , through the vacuum lattice with the local speed of light.

As a consequence there are no attraction forces on propeller shaped Fermions. Gravity seems to be the result of two different impulse arrays: the massless Higgs impulse array and the (less effective) massless Graviton impulse array.

As a consequence, new paradigm Dark Matter Black holes suffer only from the gravitational influence of Higgs vacuum (photon) impulses also coined Casimir push-gravity, because no gravitons can escape from the Black hole. The Black hole is supposed to be a super dense knot of Higgs particles floating inside (and compressed by) the oscillating Higgs vacuum frame. (Fig. 1)

No photons like gravitons can escape from inside the Black hole. However, in Q-FFF theory, the vacuum is constantly “eaten” by these NEW Black hole nucleus and the origin of the Casimir gravity effect of Black holes..(fig 19)

In the Q-FFF model, Fermions are assumed to have a propeller shape equipped with a left- or right hand “pitch” Quarks and some leptons are compound particles (with photonic gluons) however, electrons and positrons are singular.

Only the statistical sum of the different kinds of vacuum impulses (in the form of butterfly shaped vector arrays) by real collisions from all directions on Fermions are responsible for all (energetic) phenomena in the universe. (Fig 2,3)

The polarisation and so called spin flip of Fermions around Black holes is the origin that Black holes are equipped with a narrow Fermion repelling globular horizon.

As a result, Black holes are Zero Point Energy driven electric generators with negative charge at the outside and positive charge at the inside.

The Fermion repelling horizon of Black holes (fig.7,8,9) is supposed to be the origin of vacuum polarisation between pairing Black holes leading to the fast creation of Stars by Stellar Anchor Black Holes (SABHs), Galaxies, (Cygnus A: fig 5) Herbig Haro objects, the pairing of Sunspots Alfven circuits and Birkeland currents.

The accelerating plasma tail of NEW paradigm Black holes (fig 10), and the splitting Black holes into smaller pairing Black holes is supposed to be the origin of a smooth proliferation of Black holes and downsizing after the big bang of star magnitudes.

The Eagle Spire Nebula, (fig. 4) in the Carina and other nebulas, are examples of a smooth proliferation of down sizing by splitting Black holes through Galaxies and Nebula.

We observe in these nebulas the pairing and splitting of Black holes ending up into multiple Herbig Haro objects (double stellar anchor Black hole systems) generating Hydrogen gas around the two black holes in addition with Birkeland Current systems as accelerating origin of fast new star formation and the start of open star clusters.

Consequently the electric energy production of Stellar Anchor Black Holes (SABHs), seem to be able to explain quick Star- and Galaxy formation, by Birkeland Currents, Alfvén Circuits. However, smaller (new paradigm) Black holes (created by magnetic interference and Radio Frequency currents) are supposed to be responsible for Sunspots, micro-Comets, Ball Lightning and even as multiple so called Quantum Knots inside Plasma Balls in the laboratory.

The Dark Matter Black Holes are supposed to EAT the Dark Energy Higgs Vacuum lattice, which is supposed to have an unstable influence on the Universal vacuum bubble and as a result, the Universe is supposed to be cyclic, super symmetric in the form of a raspberry shaped pulsating symmetric Multiverse with finite cycle time. (fig. 13-14)

The vacuum consumption of Dark matter black holes is also supposed to be the origin of the Hubble redshift in the universe, pointing into the direction of an accelerating expansion of the universe.

However the opposite is supposed to be the case in Quantum FFF theory, the universe is supposed to contract direct after the inflation epoch (fig 13).



A ball of Stringy particles compressed by the oscillation energy of the NEW Higgs vacuum Lattice= DARK ENERGY. The BH Nucleus itself is DARK MATTER.

Figure 1, Impression of a Quantum Knot based nucleus of the new Black Hole.

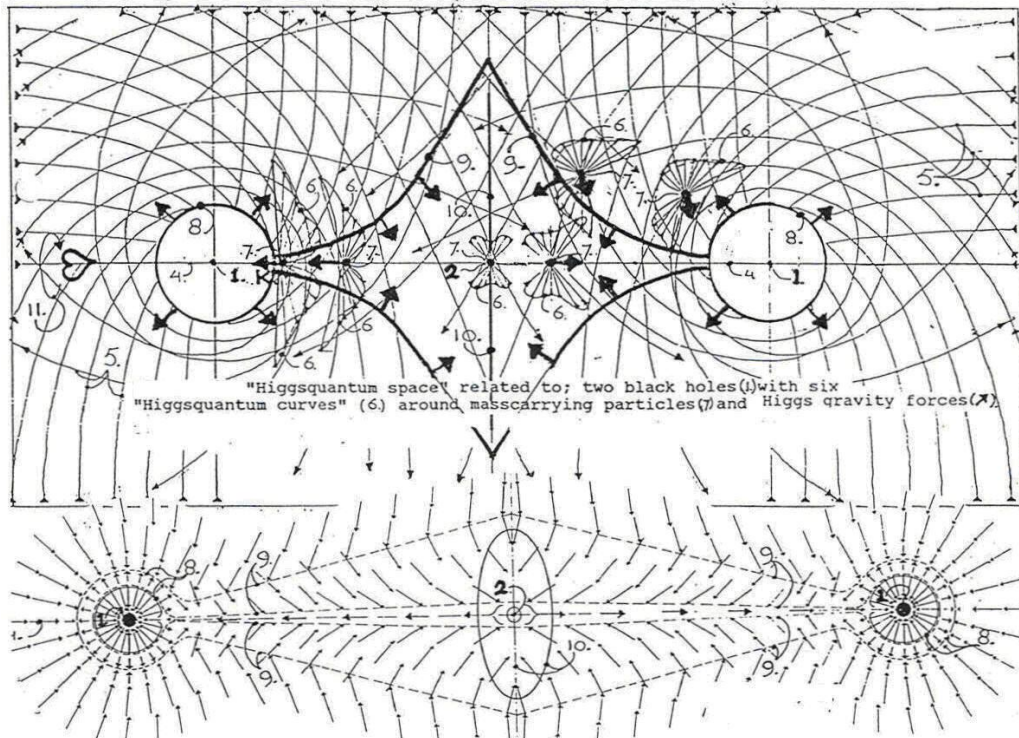

Figure 2, impression of the Higgs Vacuum structure around a set of two Black holes, as is found to be present around some Planetary nebula, early Galaxies and Herbig Haro objects. The negative charged particle jets is the result of the Black hole based electric potential combined with the vacuum polarisation (acceleration) effect on light Fermions like electrons and the origin of Birkeland currents and Alfvén circuits.

Dumbbell systems of new paradigm Black holes kept apart by two Herbig Haro electron-ion particle jets. Zero Point energy pressure effects around test masses are depicted as butterfly shaped vacuum pressure vector array curves. In Q-FFF theory, the vacuum gravity pressure is interpreted as Dark energy and Black holes as Dark matter. The central “White-Grey hole” is always the place for gas concentration by electric Birkeland current pressure of all open star clusters and Spiral Galaxies. Only Globular star clusters and some Dwarf elliptical Galaxies will show central massive Black holes

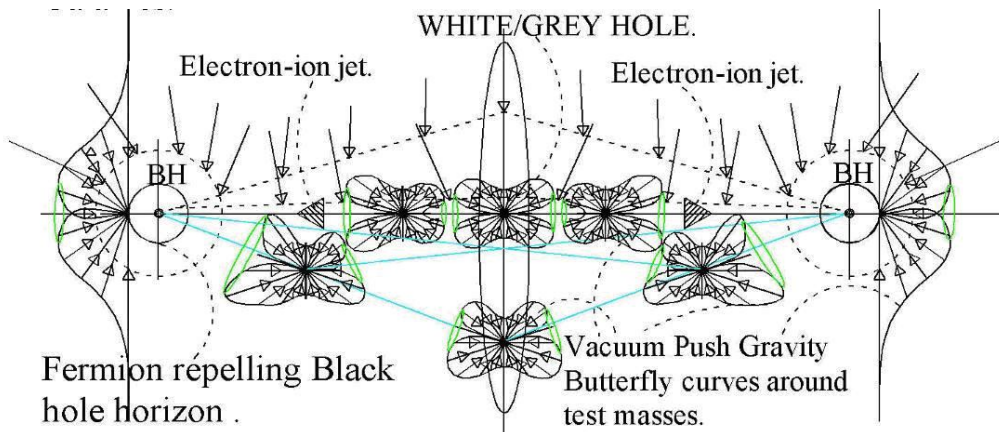

Figure 3, The same Birkeland current system as figure 2 with butterfly vector arrays at different locations around the Black holes. In the middle the vacuum has less density (larger Planck lengths) by the absorption of the dual Black holes.

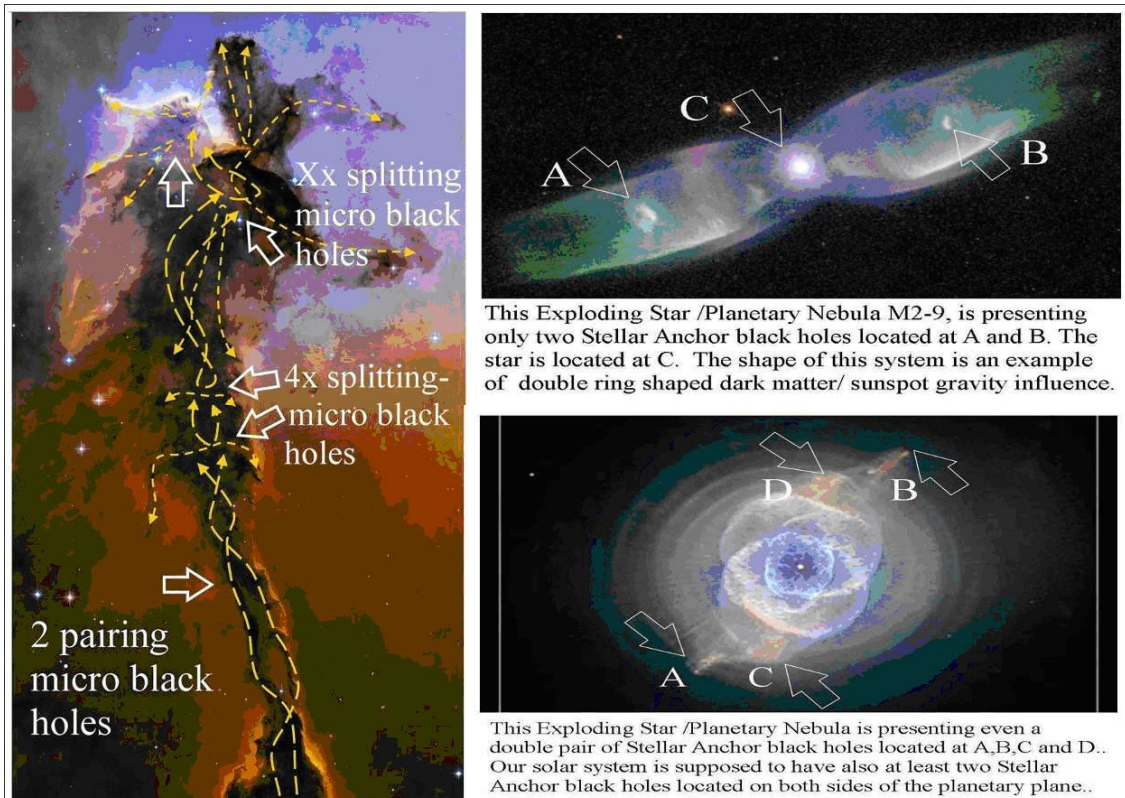

Figure 4, Examples of stellar anchor black holes and the formation of Herbig Haro systems inside the Spire nebula (left) by migrating and pairing black hole systems.

The origine of Double MWC922 interference rings

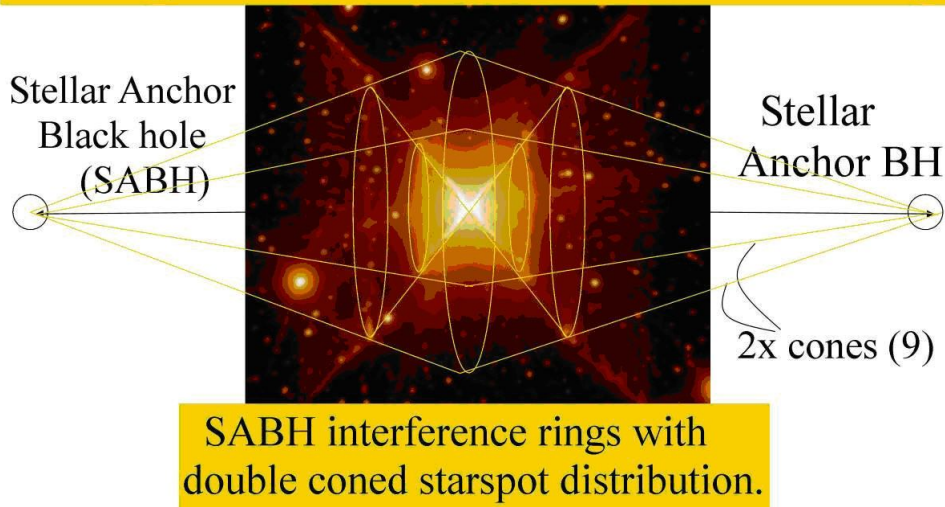

Figure 5, Star spots are supposed to be micro black holes and able to form interferenced double cone patterns after stellar explosion. The Red Square Planetary nebula MWC922, equipped with double cone structure of expelled material including trailing starspots (Micro Black Holes). There are FOUR cones of interferences observed, originated by the two Stellar Anchor Black holes (SABHs). These four cones seem to interfere with the TWO cones of expelled material of the star, leading to FOUR rings of interference.

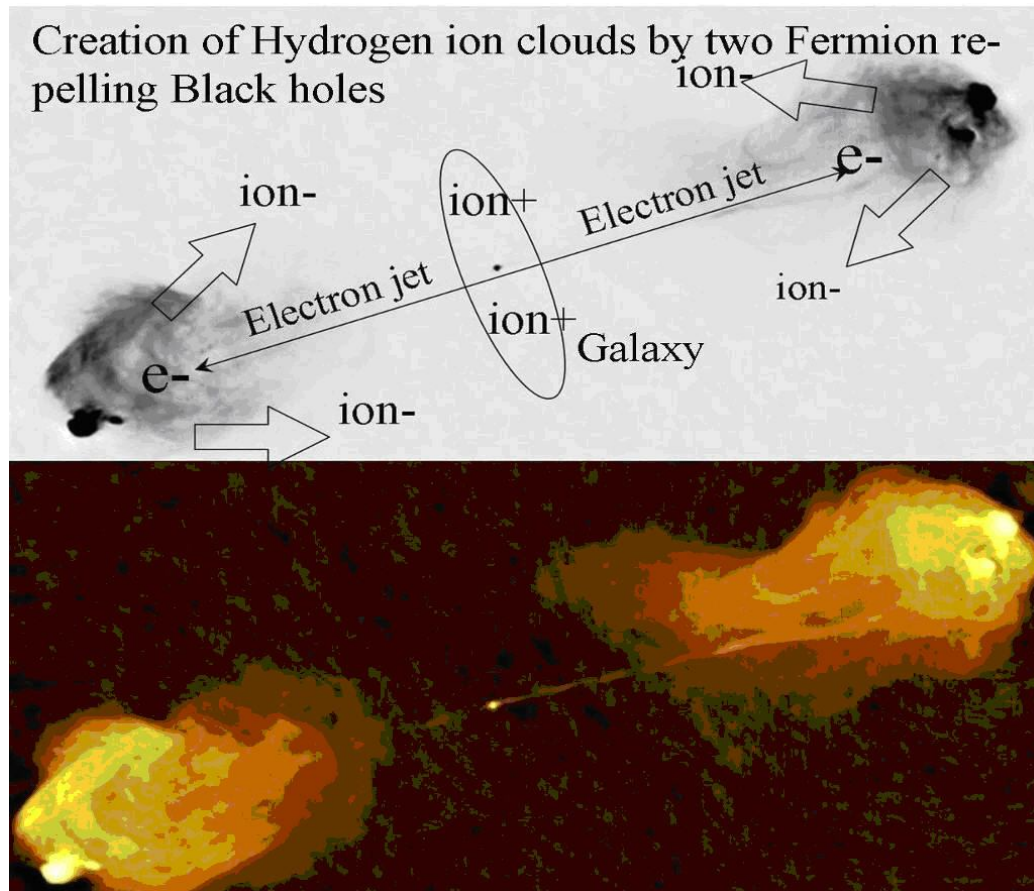

Figure 6 Cygnus A equipped with dual hotspots with gas production and electron jet including Birkeland currents and gas transportation by Alfvén circuits.

The OLD and NEW Black Hole differences.

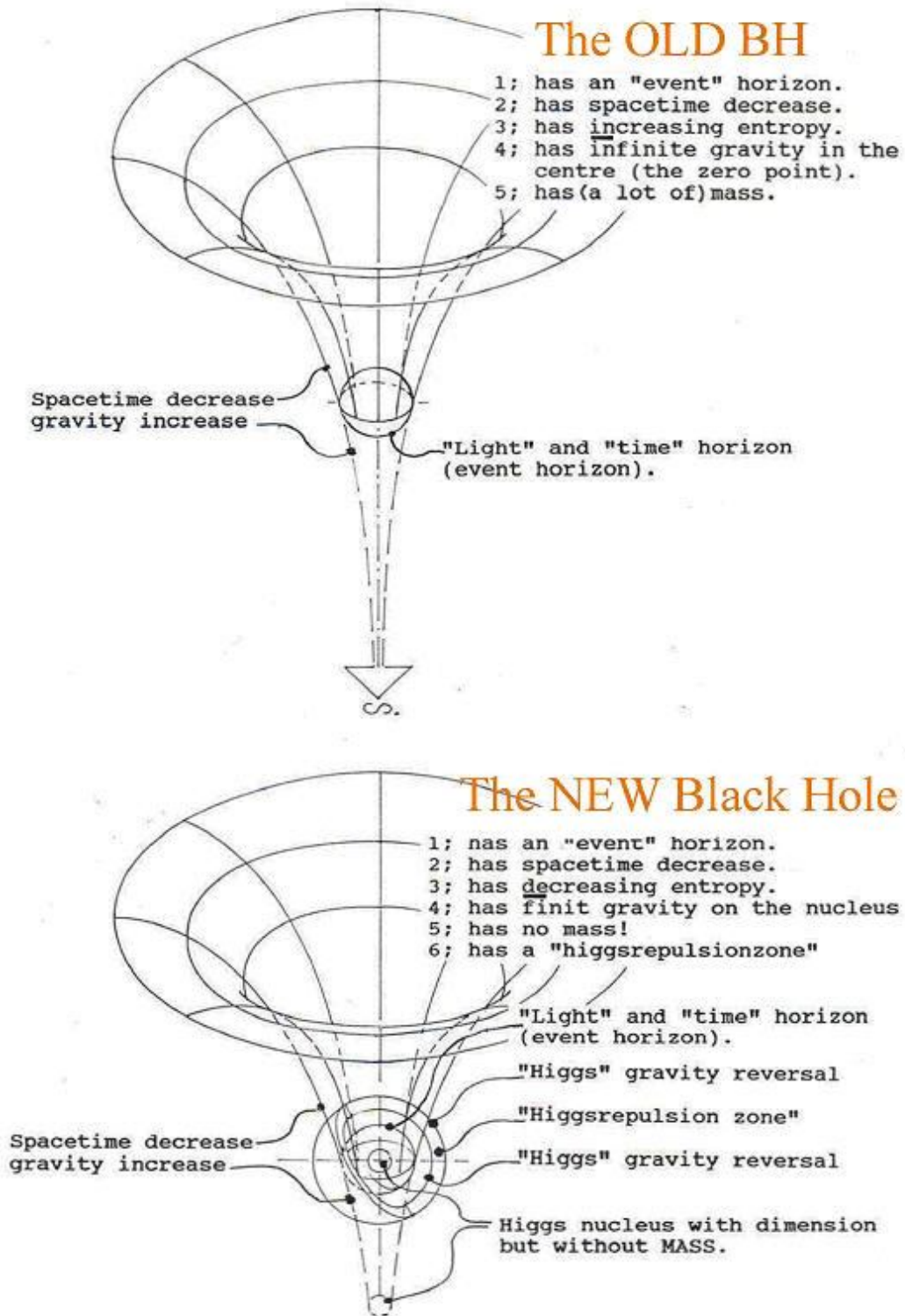
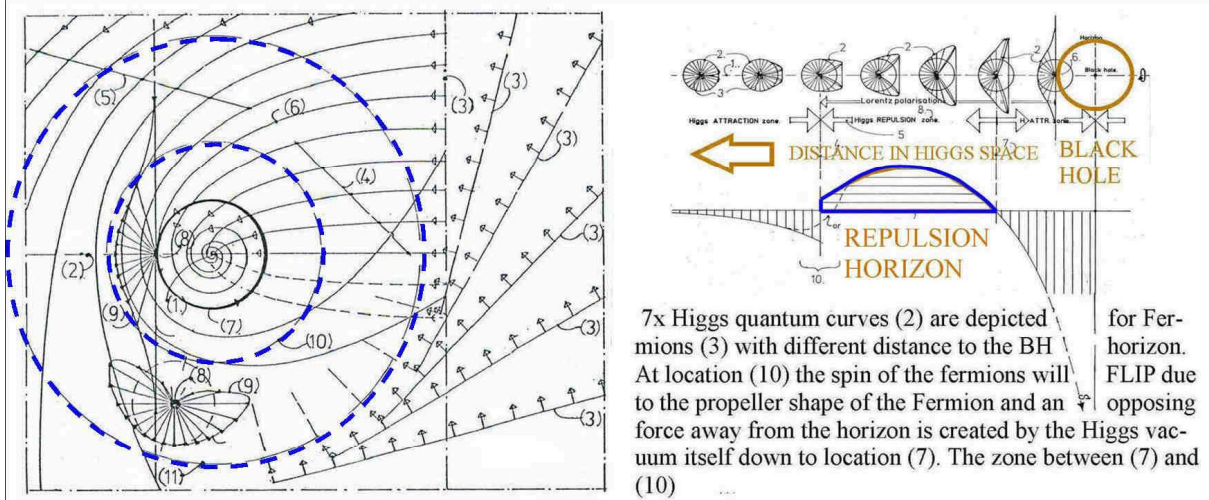

Figure 7, The difference between the old and new paradigm Black hole according to Quantum FFF Theory .

Fermion repulsion zone 10-11 around a Black hole, with Photon and Higgs trajectories around a NEW paradigm Black Holes.(Quantum-FFF Theory)



- 1: Non rotating Black hole nucleus (in 2D cross section).
- 2: Reference axis for trajectories 4,5 and 6.
- 3: Other incoming photonic/Higgs fronts (without depicted trajectories)
- 7: High photon energy collider globular shell, with intense Quantum effects like pair production (e^-e^+). 8: test masses.
- 9: Butterfly shaped Higgs/photon Fermion pushing curves in 2D.
- 10 and 11: Fermion repulsion zone. Due to the propeller shape of the Fermions, they will experience a so called "Spin Flip" in this zone.

Figure 8, Principle of Fermion repulsion around a Black hole according to Quantum FFF theory..

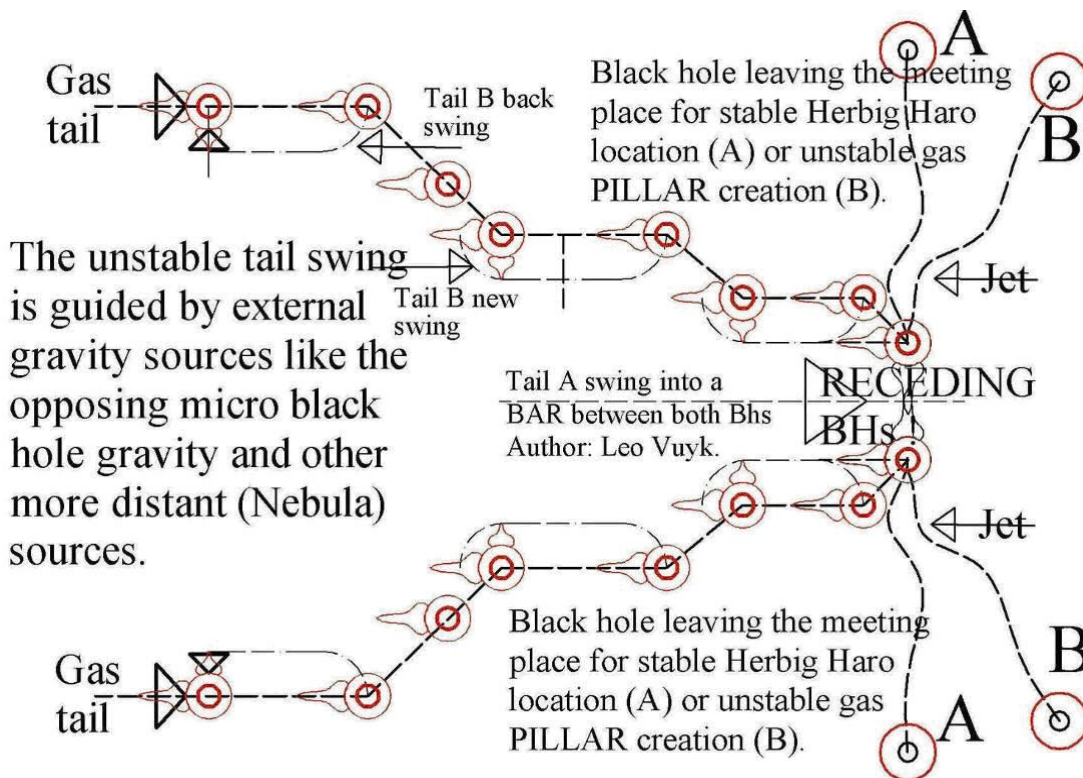
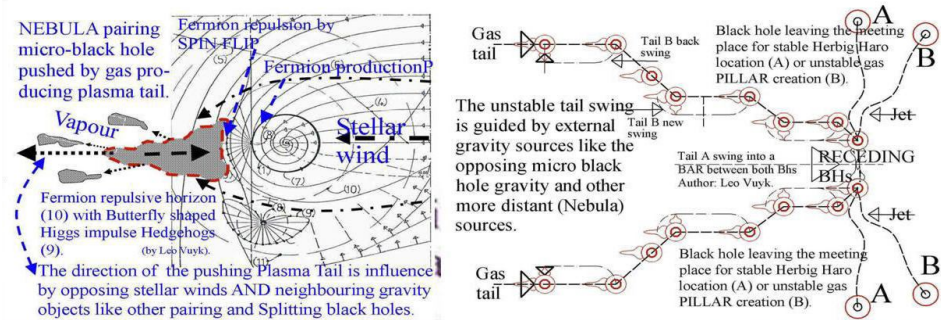

Figure 9, New Black hole propulsion principle by a self produced plasma-dust tail, also responsible for dust Pillar creation and the pairing and spitting effect as observed in nebula like the Eagle and Carina nebula.



Several accelerating pairing and receding micro black holes, as the start of HH objects, in the Carina nebula, with temporary meeting place (A) and ionised plasma tail.(Quantum-FFF Theory)

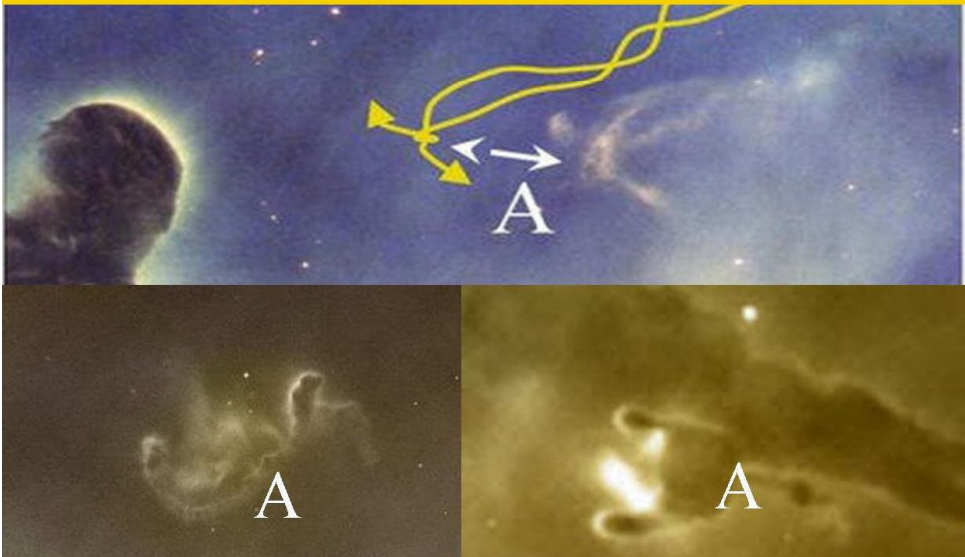
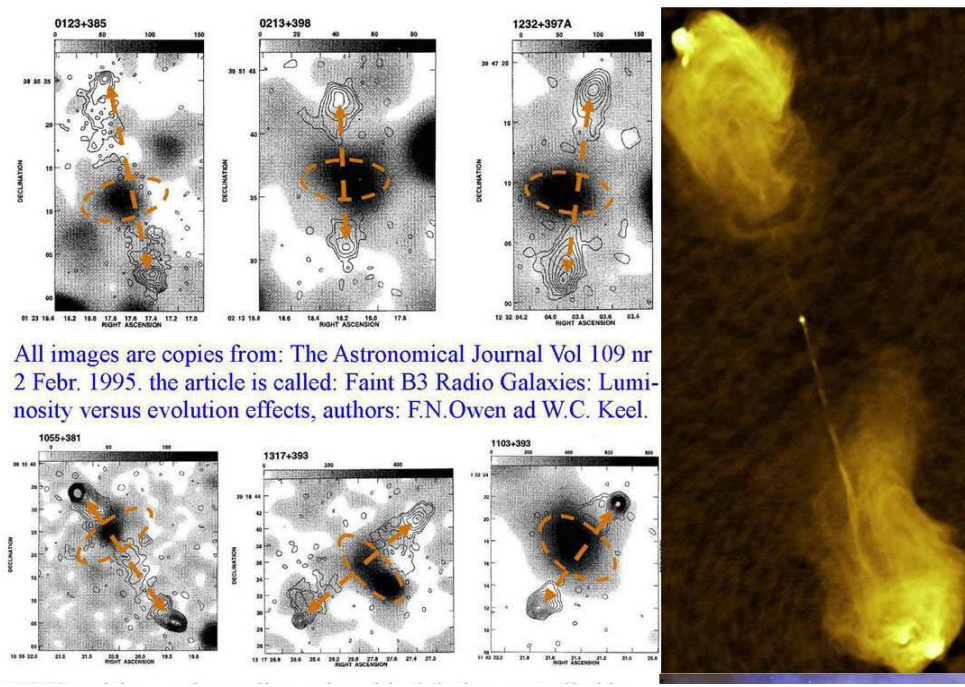

Figure 10, Three examples of ZPE accelerated Black Holes, plasma producing, pairing and splitting inside the Carina nebula.



All images are copies from: The Astronomical Journal Vol 109 nr 2 Febr. 1995. the article is called: Faint B3 Radio Galaxies: Luminosity versus evolution effects, authors: F.N.Owen ad W.C. Keel.

Figure 11, Cygnus A (right) is one of the best examples of Birkeland current driven gas concentration between dark matter Galaxy Anchor Black Holes (GaBHs) . Even in the early universe these dumbbell structures have been found like the “Faint B3 Radio Galaxies” (Owen and Keel)

Recent observed Black Hole abundance (left) in the CIB Cosmic Infra Red Background (right) and X-ray: CXB, is a strong support for Quantum-FFF theory Black Hole splitting Big Bang- and Contracting Big Crunch cycle,

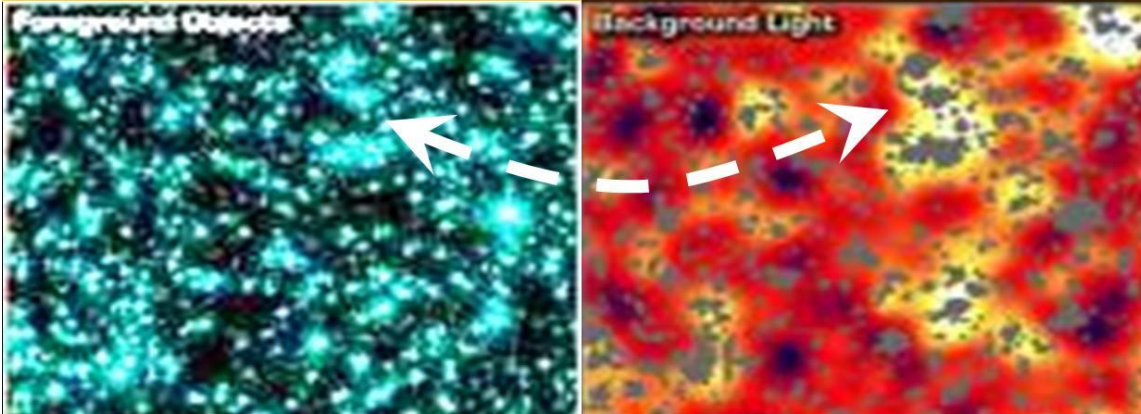

The CPT SYMMETRIC MULTIVERSE CYCLE.

The Inflation epoch starts if the decreasing vacuum pressure equals the increasing Higgs tension of the Big Crunch black hole nucleus. Inflation epoch ends if all splintered black hole nuclei are evaporated, or left behind as Galaxy Anchor Black Holes.

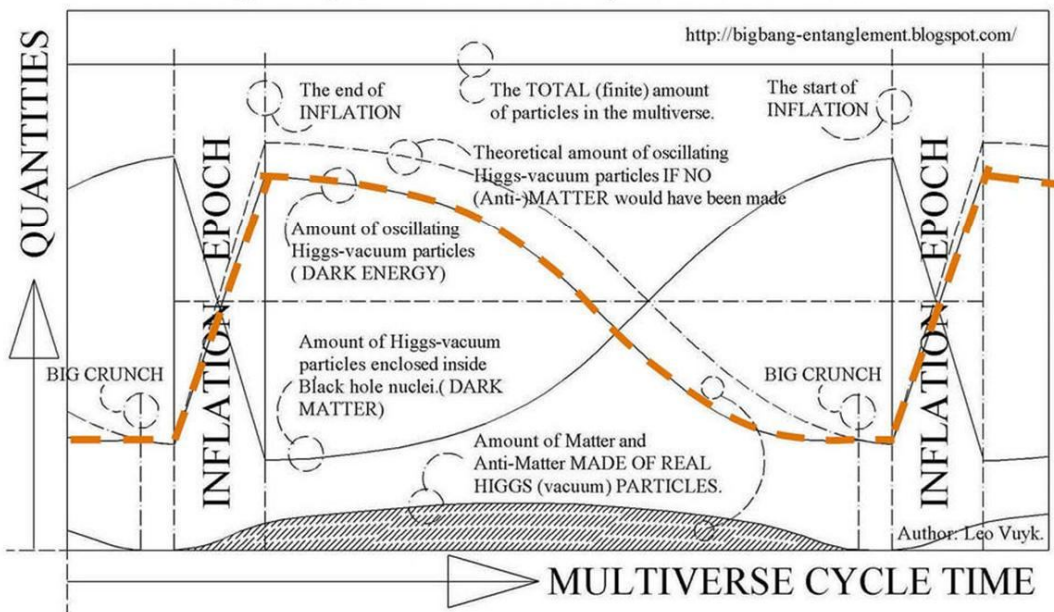

The Pulsating Multiverse depicted as a continuous flow of increasing and decreasing numbers free oscillating- and Black hole condensed Higgs particles and the amount of Quarks and leptons. The size of the pulsating multiverse vacuum is given in orange.

Figure 13, Abundant Black Holes observed in the early universe by the CIB and CXB of Chandra and Spitzer space telescopes (2013). A strong support for the Quantum FFF theory based Black Hole splitting Big Bang and contracting Big Crunch Cycle of the Multiverse.

Comparison of the Final ESA CMB Planck map with a cross section through the Raspberry Multiverse according to Quantum Function Follows Form theory. Compare the Cold Spot with the Void and the Warmer and Colder Hemisphere of the Plack CMB (left) with observation boundaries (right)

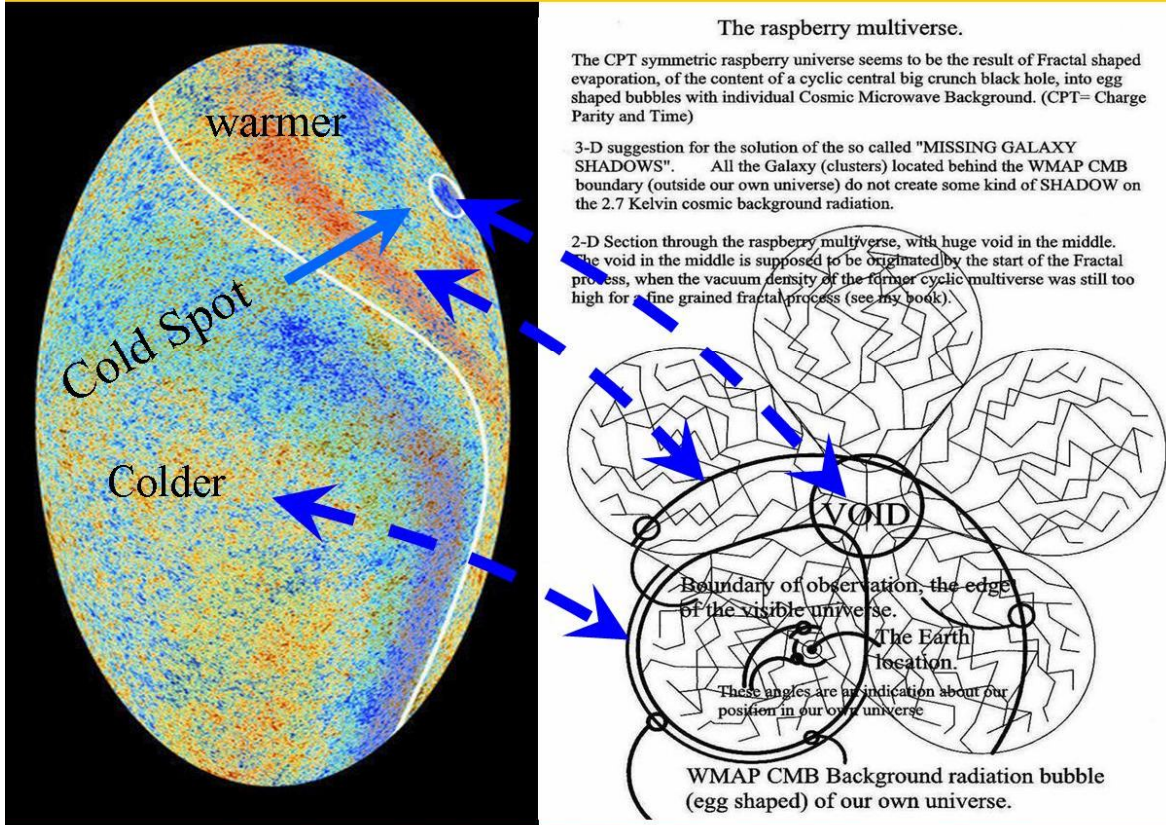

Quantum FFF theory is a combination of a holistic and a reductionist approach of nature. Holistic by the introduction of complexity into the sub quantum geometry or microstructure of elementary particles and fields and reductionist, by reducing that complexity into single elements and monopole forces.

However all these particles and fields are supposed to be connected by continuous active information fields called instant entanglement, between one or even more symmetrical anti matter universes at a long distant.

If particles combine together into simple knots they form quarks and some leptons.

If these knots become more complex (more than 6 particles) they are supposed to form ball lightning alike Casimir energy producing systems called micro black holes..

If stars explode into supernovas they for also quantum knots based on the remaining particles left over from the star's interior and form black holes.

All black hole nuclei are supposed to be based on such quantum knots.

The big bang is supposed to be the evaporation and explosion of the one and only big crunch black hole.

As a consequence we live inside a cyclic symmetric multiverse interconnected by instant entanglement between these anti-copy universe at the quantum scale.

Consciousness should also be subject of this active information system, and my thoughts are continuous competing with my brothers over there.... (Leo Vuyk)

Figure 14, The Pulsating Raspberry shaped Multiverse also to be observed from the Planck Cosmic Background Radiation image.

Addendum of some Quantum FFF theoretical principles

The NEW Black Hole Paradigm

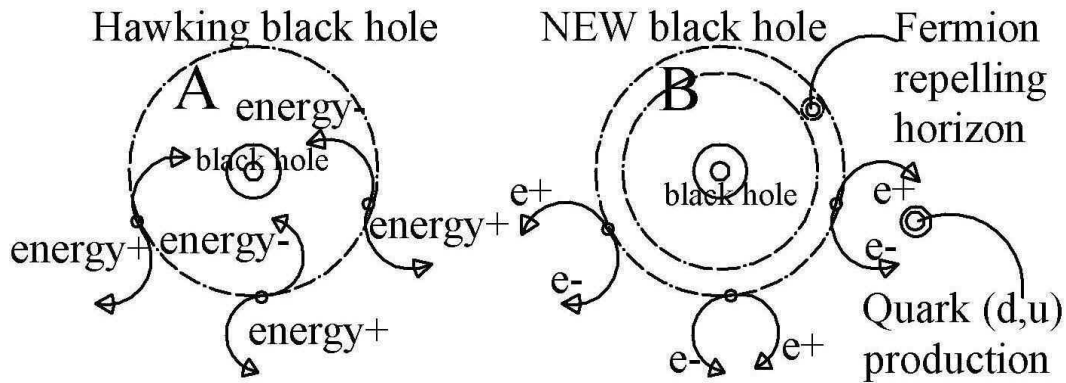

The standard Hawking Radiation postulate is: that all matter (NOT all energy) is drawn into the Black hole.

My NEW postulate is that matter is created (and pushed outside) at the Black hole horizon by QUANTUM FLUTUATIONS producing electrons and positrons.

Some electrons and positrons will annihilate, but the rest will form Quarks and plasma, because the Higgs vacuum lattice is CHIRAL and prefer to link gluons to positrons. Thus more electrons will stay single and form atom shells!

Due to the propeller shape of the particles all the plasma is repelled away from the black hole!! The black hole will not evaporate !

This is the base for NEW Physics and a support for a new explanation of Cometary X-rays, Hydrogen and AMINO ACID production. Even Gas Pillar and Herbig Haro formations inside Nebula become a logic base. Author Leo Vuyk.

Figure 15, Quantum Fluctuations as the origin of Plasma creation around Dark Matter Black Holes.

M82 Starburst Galaxy (2x merging spirals) shows only medium Central located Black Holes [A] (No Giant BHs) and TWO double cone ordering of "Galaxy Anchor Black Holes"(GABHs) [B], according to Quantum FFF theory. (Chandra images)

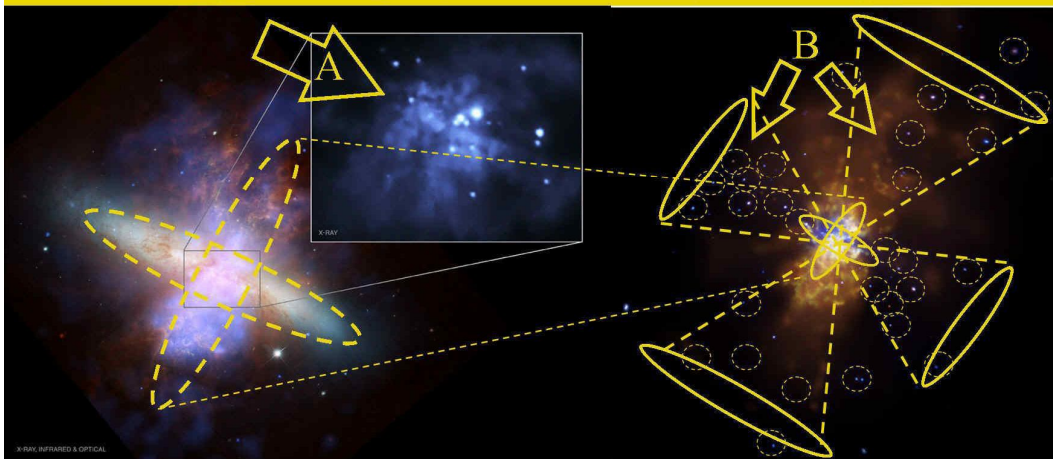

Figure 16, M82 Starburst Galaxy with a complex galaxy anchor black hole system

Electric Current processing between dual Dark Matter Black Hole systems around the Sun and Spiral Galaxies, according to Quantum FFF Theory

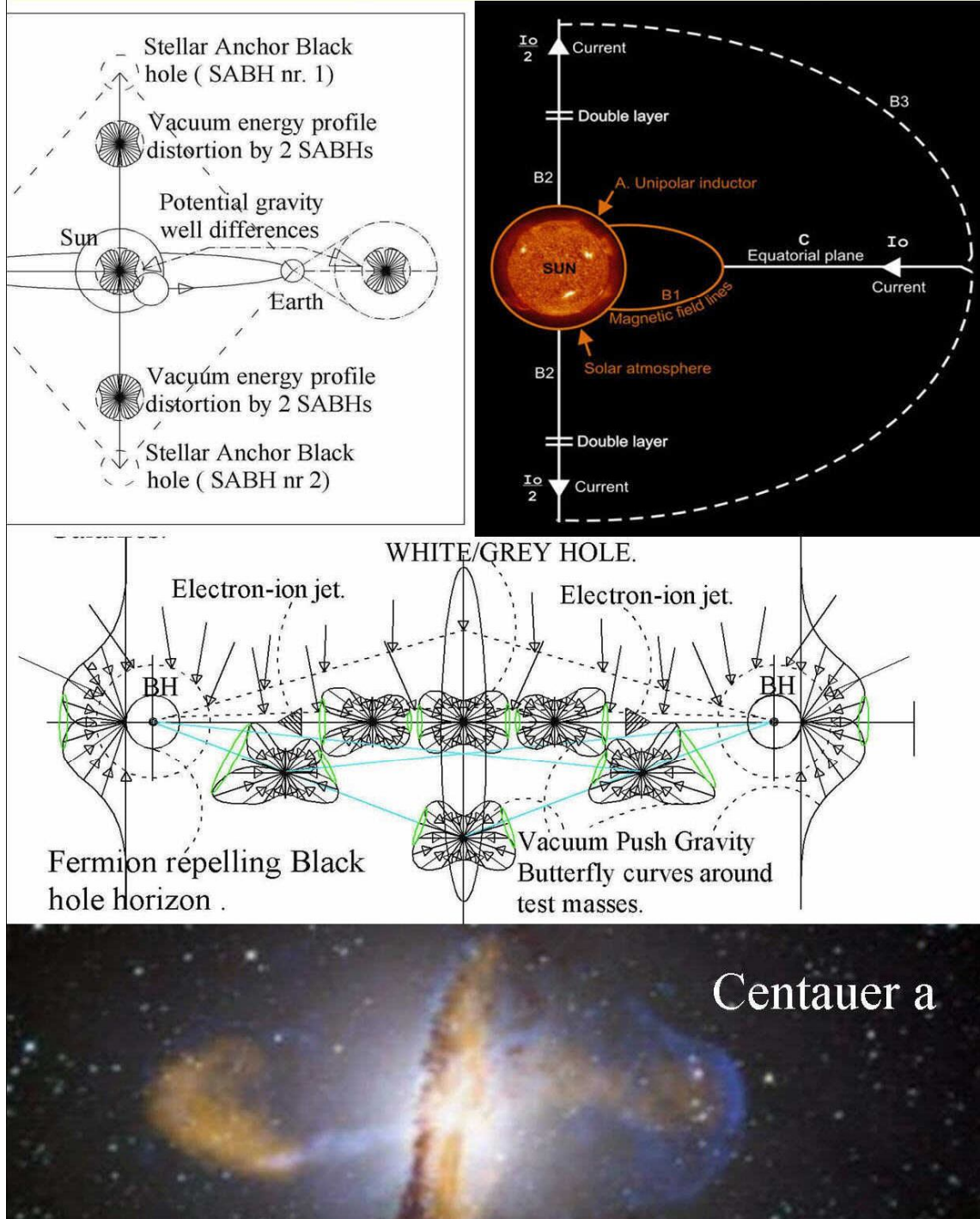

Figure 17, Birkeland current systems around stars and galaxies.

DWARF Galaxy formation (15) in between (2 +) Galaxy Anchor Black Holes (1) (GABHs= Clumpy Dark Matter) after Galaxy merging according to Quantum FFF- Theory.

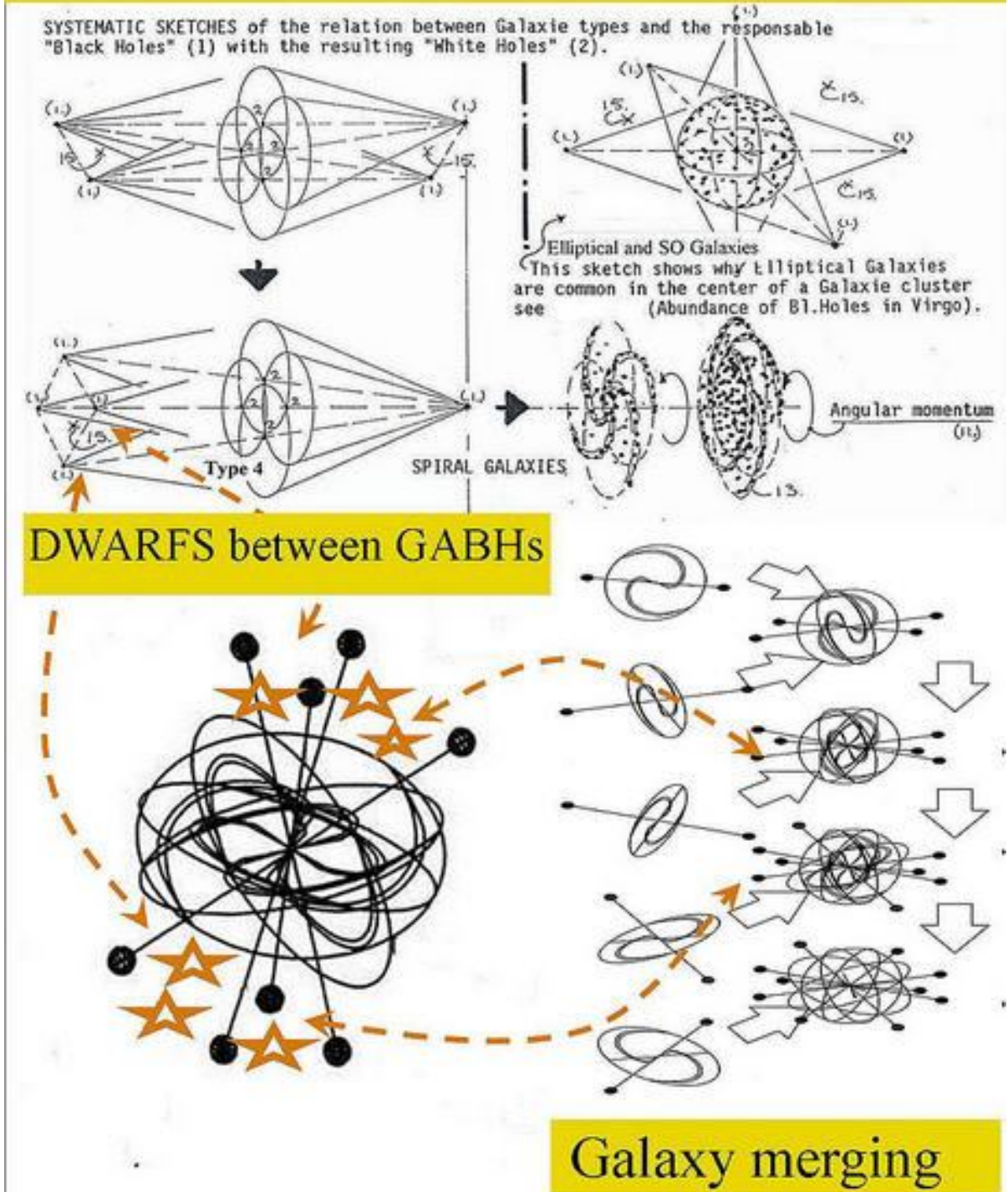
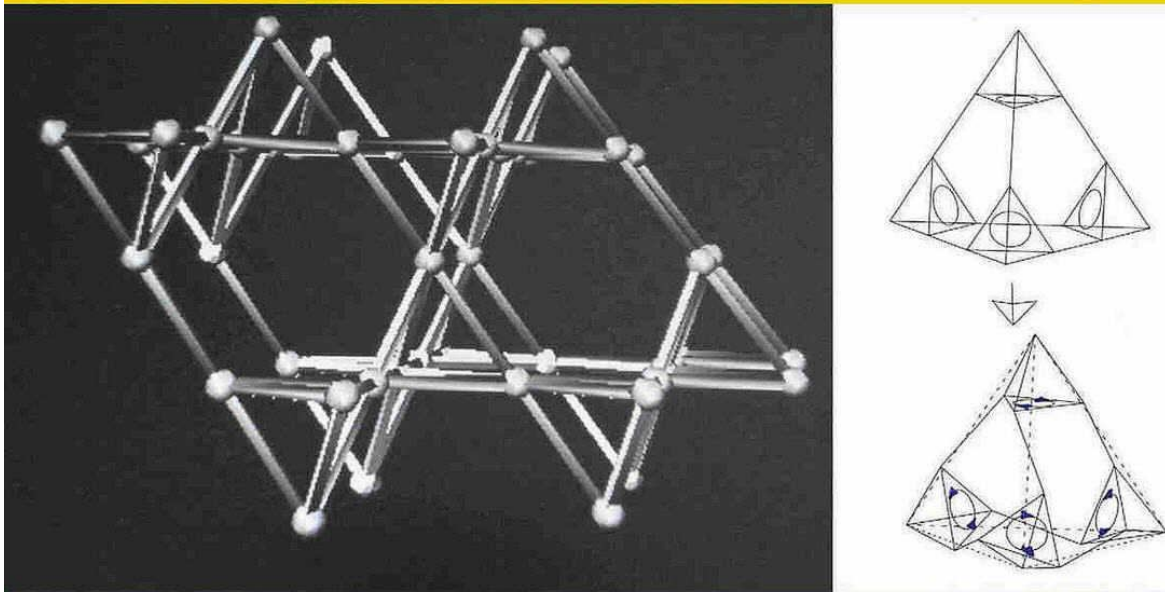
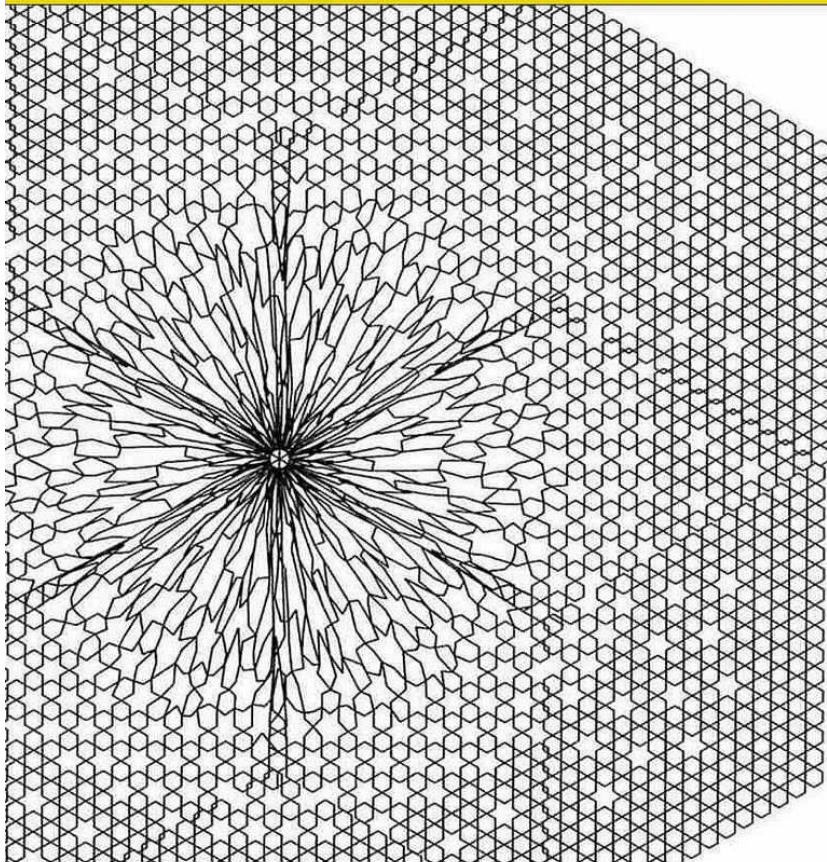

Figure 18, Dwarf galaxy formation between GABHs (Galaxy Anchor black Holes). TWO GABHs are able to form spiral galaxies in between. After merging with other spirals they can form more complex galaxies (even elliptical galaxies) , surrounded by more complex systems of GABHs. In between these GABHs there will automatically form DWARF GALAXIES.

New Dark Matter Black Hole, “Eat” the chiral oscillating Higgs vacuum.(Quantum-FFF Theory)



Simplified tetrahedral vacuum lattice structure (left), constructed by complex chiral tetrahedral building blocks (right). Each universe has to choose between a left- or righthanded rotation of its tetrahedral building blocks. Each chiral lattice has the Planck length and is supposed to be equipped with at least two oscillating massless new Higgs particles.



Black holes EAT the vacuum lattice with the oscillating Higgs particles.

So, the vacuum lattice structure around a black hole could be represented like this.

As a result, the near vacuum is thinner or diluted, it has holes, which could be the origin of the Universal HUBBLE redshift.

By contrast, my new black hole paradigm says: the origin of universal redshift is Dark matter.

Dark matter is the proliferation of vast numbers of Black holes around Galaxies. Conclusion, based on Hubble redshift, we don't know anything about expansion or contraction of the universe. (Author Leo Vuyk)

Figure 19, The Chirality and structure of the oscillating Dark Energy Higgs vacuum lattice

Quantum Function Follows Form Model

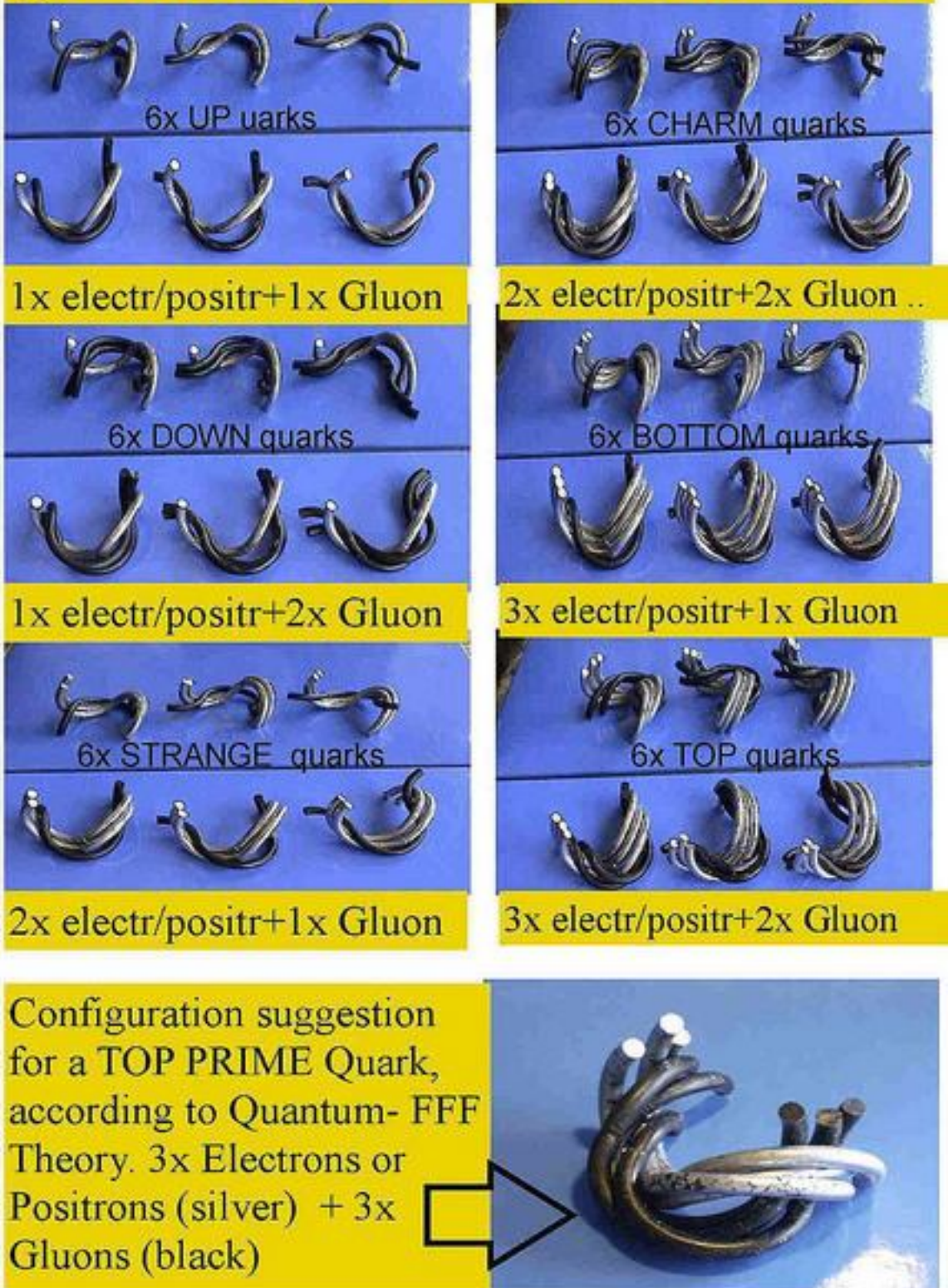

Figure 20, 5x different shaped Photon/Gluons can combine with the two propeller shapes of the electron and Positron to form all coloured (QCD) Quarks and even more!!

Synchrotron radiation by Polarized Fermion spin combined with high speed motion through the resistive oscillating Higgs vacuum (according to Quantum FFF theory)

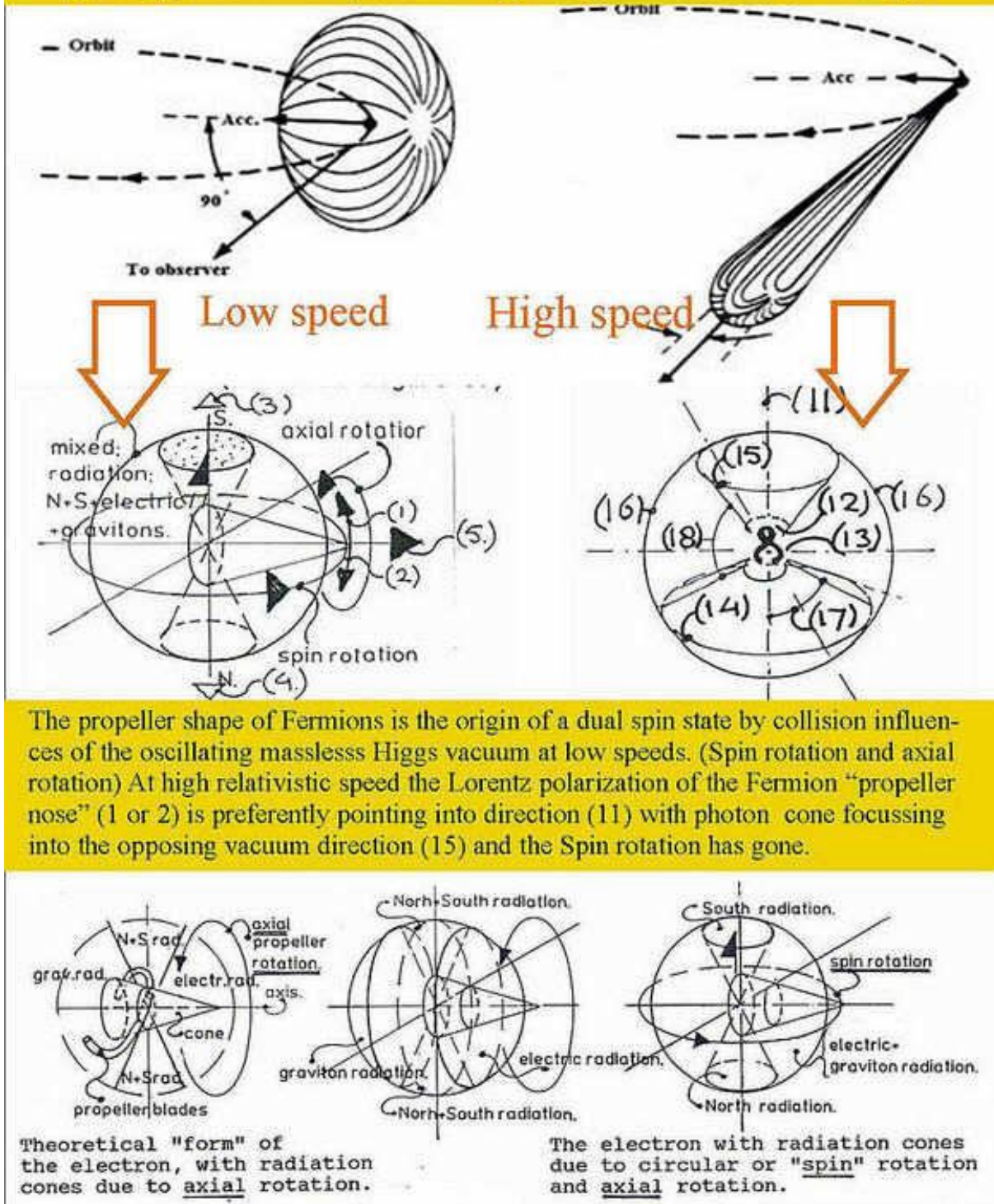
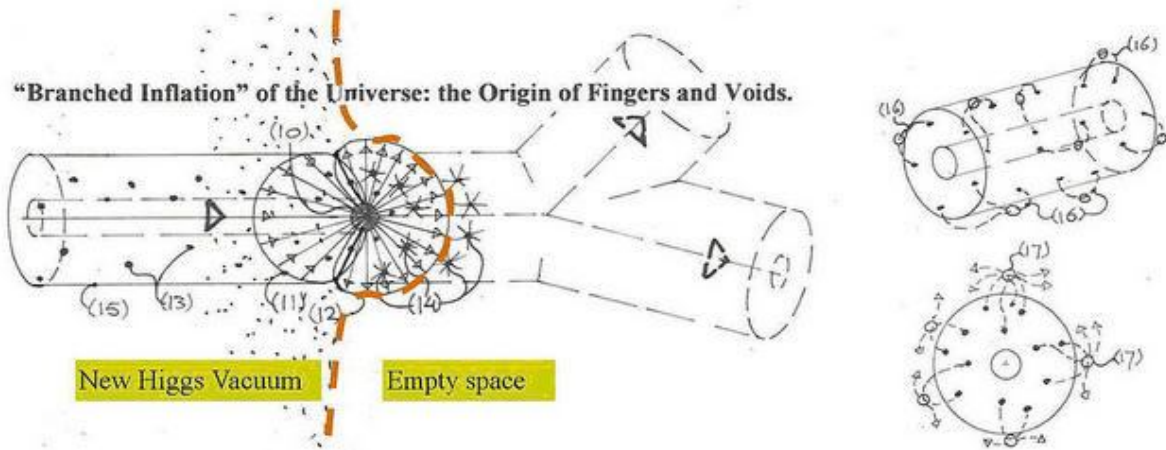

Figure 21, The polarisation of the double spinning propeller shape of fermions is the origin of all radiation differences.



The origin of the Lyman Alpha Forest (15) and Higgs vacuum, by the splitting of the Big Bang Black Hole (BBBH) into smaller Splinter BHs (10). The splinter BHs (10) evaporate into smaller evaporating black holes at the Front (14) which compensate the pressure from the Backside splinter BHs (11). The BHs (11) are assumed to partly evaporate like BHs (14) also into a newly formed oscillating Higgs vacuum until the Higgs vacuum pressure stops the evaporation and leave Galaxy Forming BHs (13) behind. However single BH will pair (16) with the nearest other BHs to form Dumbbell systems, which efficiently form Giant Stars and Galaxies (17) in between. (author: Leo vuyk)

Figure 22, How the Lyman Alpha structure of the universe and the vacuum lattice was formed, by the splitting and evaporation of the Big Bang Black hole.

Magnetic field variations by the “Curl” of Magnetic Monopole (N and South) Radiation around a wire and the earth.

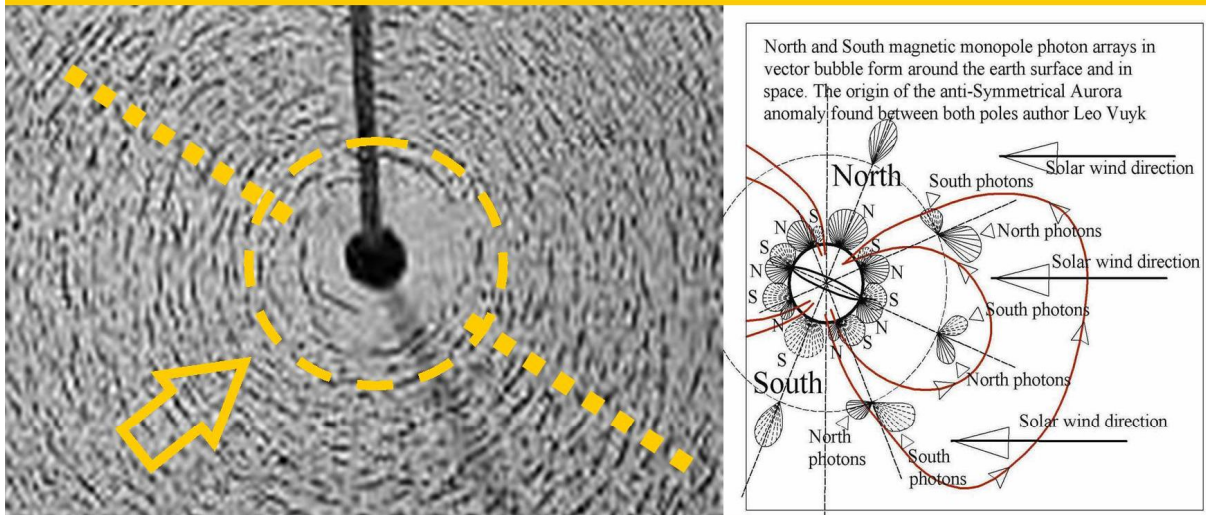

According to Quantum FFF theory, all magnetic fields can be presented as CURLED Magnetic Monopole Photon Vector Arrays. As a result, the magnetic field intensity is (away from polar positions) NOT dropping as the inverse cube of the distance from the source!! (See images). Also: direct around the current in a wire- equipped with iron powder on paper- the magnetic field strength seem to be even less than at some distance.

Figure 23, Monopole magnetic radiation explained.

Alternative standard particle model

All SINGLE (non-compound) elementary particles suggested by Quantum FFF Theory. OLO, ORO have "click-on potential" to form compound quark particles with only 5 different shaped Gluons/Photons. In yellow colour: Quantum-FFF suggestions for NEW PHYSICS particles. The Majoranas: (OUO+ mirroring Majoranas RUR+ LUL) and 4x extra neutrinos (RLU+ RRU+ LLU and LRU) (author:Leo Vuyk)

Explanation of the codes:
 U= Up rotation (180 degrees)
 O= Unchanged circle.
 L= Left rotation (90 degrees)
 R= Right rotation (90 degrees)

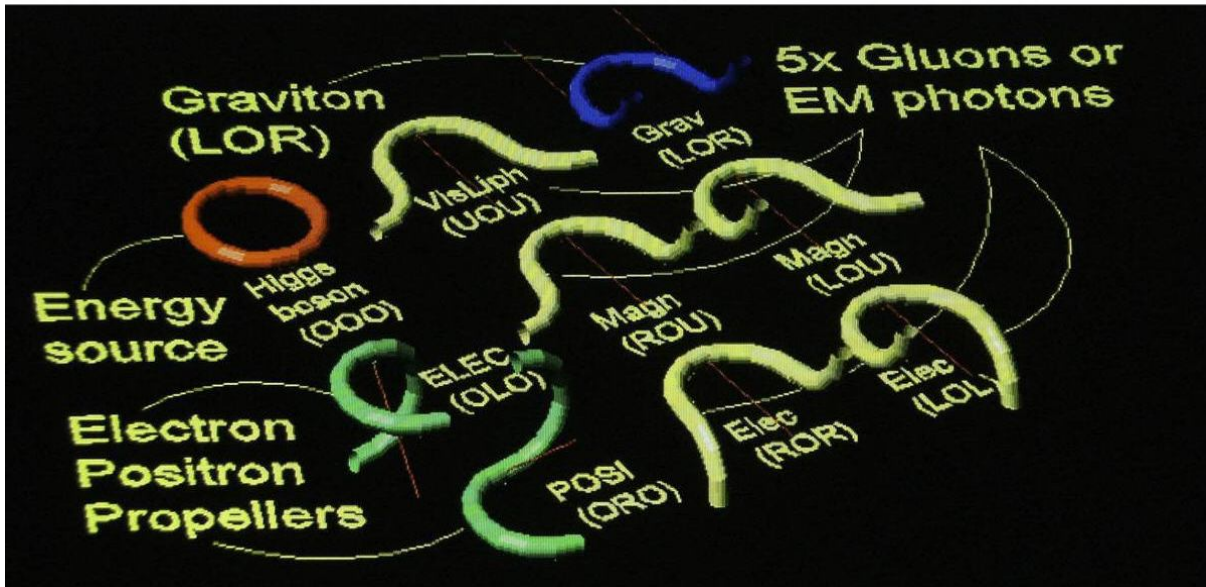
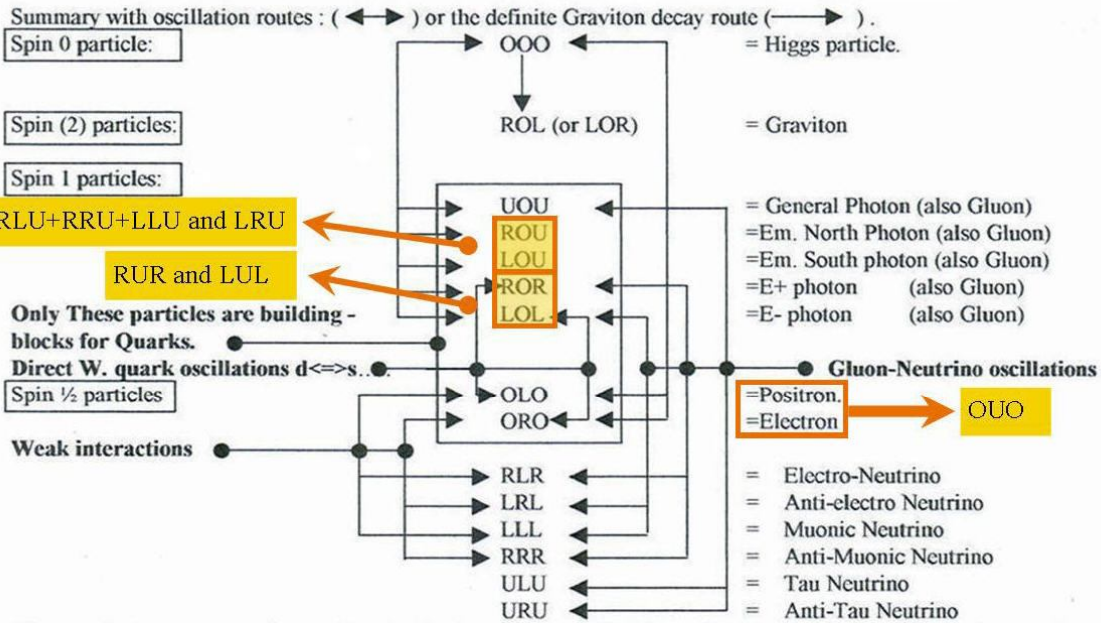
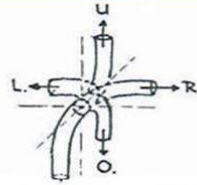

Figure 24, The particle zoo of single ELEMENTARY particles.

Characteristics of Quantum FFF Theory.

- 1: The clear MICROSTRUCTURE or the 3D FORM of elementary particles, (also called 3D-Preons) made out of convertible Higgs particles, is responsible for “Bound states of Fermions” and composite Quarks.
- 2: The Higgs is supposed to be energetic oscillating, it is the origin all particle motion and spin states and Dark energy (125 GeV) inside a truncated tetrahedron shaped chiral vacuum lattice. The lattice chirality (left or right handed) is the origin of our material universe. Higgs particles are zero point “Planck Oscillators” the origin of the Casimir force, waiting to be harnessed as free energy.
- 3: NOTHING SUCKS IN PHYSICS, Gravitons act with less pressure on Fermions than the Higgs vacuum (dark energy) and everything is ENTANGLED by INSTANT communication between at least two anti-copy UNIVERSES or MULTIVERSE, being entangled since the big bang.
- 4: Black holes of all sizes (down to ball lightning) do not emit gravitons, they feel only Casimir Gravity of the vacuum oscillations so they are massless but counter intuitively the origin of dark matter and producers of all Hydrogen by Electron and Positron pairs as horizon fluctuations and repel all Fermions even positrons at the double BH horizon.
- 5: Black Holes are supposed to have a negative surface charge in a material based universe and positive charged inside an ANTI-material universe, due to the chirality (left or right handed vacuum lattice spiralling) of the oscillating dark energy Higgs vacuum..
- 6: The Multiverse is Pulsating by two phenomena, A; vacuum (Higgs) eating new paradigm dark matter black holes (causing the Hubble redshift) and B: by universal expansion caused by the oscillation force (Dark energy) of the Higgs vacuum lattice.

FUNCTION FOLLOWS FORM in Quantum FFF-Theory. The Microstructure of elementary particles, is supposed to be the origin of FUNCTIONAL differences between Higgs- Photon- and propeller shaped Fermion particles. Something SMALL is missing in mainstream physics: a NEW splitting and pairing MASSLESS BLACK HOLE, the origin of all dark matter, Ball Lightning Micro Comets , Comets, Sunspots up to Galaxy external Anchor Black Holes and the Big Crunch of the CP symmetric pulsating raspberry shaped multiverse.

The multiverse is a collection of huge entangled pinball machines, with dark energy in the form of linear oscillating double Higgs pins as the origin of photonic collision products with the propeller shaped Fermions running and spinning as balls.

All forces are the result of this entangled Pin-Ball interaction. The 125GeV Boson recently found in the LHC is not a single but a double massless 3rd generation Higgs boson linear oscillating in tandem as opposing boxer engine pistons in a chiral truncated tetrahedron lattice.

The 126GeV energy is the base for universal dark energy, the frequency is the base for local time and the length a base for the Planck scale. (Twin Higgs, Dual Higgs, Duplex Higgs, or Tandem Higgs).

AS A RESULT, Free energy devices and electron-muon decay levitation is proposed. An unstable Higgs vacuum seems to be present around all black hole horizons by observed H2

production and annihilation radiation created by pair production of positrons and electrons.
(Instability of the Higgs field)

The main difference with mainstream physics is in short as follows:

A: That a "black hole" has no mass- it does not emit gravitons-, but is the origin of all "dark matter" in the universe and can exist at all scales from Quantum Knots (or Ball lightning) up to Comets, Sunspots, external Galaxy Anchor Black Holes, up to the Big Crunch- or Big Bang Black Hole.

B: That "dark energy" is based on microcopic massless vacuum (non SM) Higgs particles, energetic oscillating in opposing pairs and able to convert into pairs of electrons and positrons, e.g. at the horizon of black holes.

C: That the 126 GeV mass of the Higgs particle (found by the LHC in Geneva) could be translated into 126 GeV energy of the paired vacuum particles. (alternative non SM Higgs)
(And is consequently THE FIRST SIGN OF "DARK ENERGY") The LHC found a first sign of Dark Energy!!

D: That as a result, the Universe is cyclic, super symmetric and has the form of a raspberry shaped pulsating symmetric Multiverse with finite cycle time.

E: That all matter and humans have their instant entangled copy symmetric counterpart living inside the opposing super symmetric lobes of the raspberry multiverse. which is supposed to be the base for consciousness.

F: That Humans and higher animals have the ability to influence conscious acts by a small retardation or lagging effect (300 msec) in decision making. This lagging effect phenomenon is already found and described for humans by Benjamin Libet, called RPI and RPII (Readiness Potential 1 and 2) see: "Wavefunction Collapse and Human Choice-Making Inside an Entangled Mirror Symmetrical Multiverse." (Ref. 16)

References:

[1] The New God Particle and Free Will.
Author: Leo Vuyk, **LuLu publishers, 2008.**
ISBN number 978-1-4092-1031-3

[2] Quantum FFF Theory is also published in the form of POSTERS at the Flickr site:
<http://www.flickr.com/photos/93308747@N05/>

[3] Numbered listing of Vixra essays by Leo Vuyk.

viXra:1305.0041

The Shnoll Effect Explained by Quantum FFF Theory.

viXra:1304.0022

The Self Organizing Universe in the Carina Nebula.

viXra:1303.0211

Hubble Redshift Combined with Universal Contraction is Possible.

viXra:1303.0053

Micro Birkeland Currents Between Two RF Generated Plasma Balls in the Laboratory.

viXra:1302.0172

Silicon Based Ball Lightning Globule Structures and Signs for Accumulation and Retarded Decrease of Tunneling Energy Bullets.

viXra:1301.0088

Two or Three Large Quasar Groups (LQGs) Located at the Start of Two or Three Lyman Alpha Systems and a Part of the Raspberry Multiverse?

viXra:1301.0050

Dwarf Galaxies and Their Relation with Dark Matter Based Galaxy Anchor Black Holes (Gabhs).

viXra:1210.0177

Instant Broglie Bohm Pilot Waves, the Origin of All Entanglement Effects in the Lab and Wavefunction Collapses in Our Universe as Related to Our Opposing Anti-Copy Universe(s) According to Quantum FFF Theory.

viXra:1209.0092

New Dark Matter Black Holes and a New Dark Energy Higgs Field, Lead to a Bouncing CP Symmetrical Multiverse, and New Experiments.

viXra:1209.0061

Birkeland Currents, Sunspots, Comets and Ball Lightning Originated by New Paradigm Dark Matter Black Holes.

viXra:1209.0030

Majorana and Sterile Neutrino Solutions in the Quantum-FFF Model.

viXra:1208.0031

Clumpy Dark Matter Around Dwarf Galaxies a Support for an Alternative Black Hole Theory According to the Quantum Function Follows Form Model.

viXra:1202.0091
Earth Magnetic Monopole Array Field Interaction with Cyclotron –Synchrotron Electrons and Muon Conversion Used for Levitation Systems.

viXra:1201.0092
Earth Magnetic Monopole Array Field Interaction with Cyclotron Electrons used for Levitation Systems.

viXra:1112.0065
LHC Signals Between 121-130 Gev Interpreted with Quantum-FFF Theory

viXra:1111.0096
Reconciliation of QM and GR and the Need for a Pulsating Entangled CPT Symmetric Raspberry Shaped Multiverse.

viXra:1111.0061
Black Hole Horizon Curvature Dependent Balance Between Plasma Creation and e-e+ Annihilation in Quantum FFF Theory.

viXra:1108.0036
Artificial Ball Lightning Production and Exploitation Device for Zero Point Electric Energy Usage.

viXra:1108.0006
Mass in Motion in Quantum FFF Theory

viXra:1104.0083
Quantum FFF Theory in Posters.

viXra:1104.0044
Ball Lightning, Micro Comets, Sprite-Fireballs and X-Ray/gamma Flashes According to Quantum FFF Theory.

viXra:1104.0002
Stellar Anchor Black Holes as the Remnants of Former Herbig Haro Objects

viXra:1103.0097
ZPE Zero Point Energy Examples Around Black Holes.

viXra:1103.0068
Funktion Follows Form, at the Quantum Scale and Beyond.

viXra:1103.0024
Quantum Gravity and Electro Magnetic Forces in FFF Theory

viXra:1103.0015
Wavefunction Collapse and Human Choice-Making Inside an Entangled Mirror Symmetrical Multiverse.

viXra:1103.0011
An Alternative Black Hole, Provided with Entropy Decrease and Plasma Creation

viXra:1103.0002
3 Dimensional String Based Alternative Particles Model

viXra:1102.0056
Experiments to Determine the Mass Related Lightspeed Extinction Volume

viXra:1102.0054
Atomic Nuclear Geometry Based on Magic Number Logic.

viXra:1102.0052
Construction Principles for Chiral “atoms of Spacetime Geometry