

Evidencing ‘Tight Bound States’ in the Hydrogen Atom: Empirical Manipulation of Large-Scale XD in Violation of QED

RICHARD L. AMOROSO

*Noetic Advanced Studies Institute,
Escalante Desert, Beryl, UT 84714-5104 USA
amoroso@noeticadvancedstudies.us; www.noeticadvancedstudies.us*

JEAN-PIERRE VIGIER (Posthumous)

*Department of Theoretical Physics
Empyrean Mobile, Kolob, Kokauvim
vigier@noeticadvancedstudies.us*

In this work we extend Vigier’s recent theory of ‘tight bound state’ (TBS) physics and propose empirical protocols to test not only for their putative existence, but also that their existence if demonstrated provides the 1st empirical evidence of string theory because it occurs in the context of large-scale extra dimensionality (LSXD) cast in a unique M-Theoretic vacuum corresponding to the new Holographic Anthropic Multiverse (HAM) cosmological paradigm. Physicists generally consider spacetime as a stochastic foam containing a zero-point field (ZPF) from which virtual particles restricted by the quantum uncertainty principle (to the Planck time) wink in and out of existence. According to the extended de Broglie-Bohm-Vigier causal stochastic interpretation of quantum theory spacetime and the matter embedded within it is created annihilated and recreated as a virtual locus of reality with a continuous quantum evolution (de Broglie matter waves) governed by a pilot wave - a ‘super quantum potential’ extended in HAM cosmology to be synonymous with the a ‘force of coherence’ inherent in the Unified Field, U_F . We consider this backcloth to be a covariant polarized vacuum of the (generally ignored by contemporary physicists) Dirac type. We discuss open questions of the physics of point particles (fermionic nilpotent singularities). We propose a new set of experiments to test for TBS in a Dirac covariant polarized vacuum LSXD hyperspace suggestive of a recently tested special case of the Lorentz Transformation put forth by Kowalski and Vigier. These protocols reach far beyond the recent battery of atomic spectral violations of QED performed through NIST.

Keywords: Bohr orbit, Dirac vacuum, Large scale extra dimensions, M-Theory, Multiverse, Tight bound states, QED Violation

1. Introduction - Tight Bound State Modeling

Recently Tight Bound States (TBS) due to electromagnetic interactions at small distances below the lowest Bohr orbit have been postulated for the Hydrogen atom [1,2]. We begin summarizing this seminal work of Vigier - In the usual understanding of atomic physics spin-orbit and spin-spin coupling perturbations for example give rise to only small corrections to classic Bohr energy levels. However with distances in the $1/r^3$ and $1/r^4$ range these interaction terms, until now overlooked, can be much higher than the Coulomb term at distances much less than the Bohr radius - predicting new physics [1,2]. Corben [3] was first to notice that motion of a point charge in a magnetic dipole field at rest is highly relativistic with orbits of nuclear dimensions. Further investigation undertaken by [1,2,4] in a model representing an extension of the Pauli equation to a two-body system as defined by the Hamiltonian

$$H = \frac{1}{2m_1} (P_1 - e_1 A(r_1))^2 + \frac{1}{2m_2} (P_2 - e_2 A(r_2))^2 + \frac{1}{4\pi\epsilon_0} \frac{e_1 e_2}{|r_1 - r_2|} + V_{dd} \quad (1)$$

where, m_i is the mass, P_i the momentum, e_i the charge, r_i the position of the particles ($i = 1,2$), A is electromagnetic vector potential and V_{dd} the dipole-dipole interaction term:

$$V_{dd} = - \left(\frac{\mu_0}{4\pi} \right) \mu_1 \mu_2 \delta(r_1 - r_2) + \left(\frac{\mu_0}{4\pi} \right) \left[\frac{\mu_1 \mu_2}{|r_1 - r_2|^3} - \frac{3 [\mu_1(r_1 - r_2)] \cdot [\mu_2(r_1 - r_2)]}{|r_1 - r_2|^5} \right] \quad (2)$$

In the center-of-mass frame and with a normal magnetic moment, $\mu = (e/m)s$ the Hamiltonian (1) becomes:

$$\begin{aligned}
 H = & \frac{1}{2m_1} p^2 - \left(\frac{\mu_0}{4\pi} \right) \frac{e_1 e_2}{m_1 m_2} \frac{SL}{r^3} \\
 & + \left(\frac{\mu_0}{4\pi} \right)^2 \frac{e_1^2 e_2^2 \hbar^2}{4m_1 m_2 m} \frac{1}{r^4} \quad (3) \\
 & + \frac{1}{4\pi\epsilon_0} \frac{e_1 e_2}{r} - \left(\frac{\mu_0}{4\pi} \right) \frac{e_1 e_2}{m_1 m_2} s_1 s_2 \delta(r) \\
 & + \left(\frac{\mu_0}{4\pi} \right) \frac{e_1 e_2}{m_1 m_2} \left[\frac{s_1 s_2}{r^3} - \frac{3(s_1 r) \cdot (s_2 r)}{r^5} \right]
 \end{aligned}$$

Continuing to follow Vigier [1], the possibility of TBS physics as derived from Hamiltonian (3) is shown in simplified form when limited to spherically symmetric terms by the radial Schrödinger equation:

$$\frac{d^2 X}{dr^2} + \frac{2m}{\hbar^2} [E - V(r)] X = 0 \quad (4)$$

and contains a form for the effective potential in the inverse power law:

$$V(r) = \frac{A}{r^4} + \frac{B}{r^3} + \frac{C}{r^2} + \frac{D}{r} \quad (5)$$

At large distances this potential is an attractive Coulomb tail with a repulsive core at small distances due to the A/r^4 term [1]. For proper values of potential (5) its coefficients could have another potential well in addition to the one at distances of the order of the Bohr radius where new physics is suggested to be 'located'. Additional theoretical details on the seminal development of TBS by Vigier can be found in [1-4].

2. Ongoing Trouble with Point Particles and Singularities

In the standard model of particle physics an elementary particle has no known composite subparticles. A mathematical idealization of an elementary particle is often called a point particle or point charge that lacks spatial extension (0D) which perhaps arose because in a mathematical coordinate context its size can be considered to be irrelevant. The nature of a point particle has remained an open question in physics. Recent *avant-garde* work by Rowlands (this volume) has extended our understanding of this conundrum:

Physics at the fundamental level can be effectively reduced to an explanation of the structures and interactions of fermions. Fermions appear to be singularities rather than extended objects, but there is no obvious way of creating such structures within the 3-dimensional space of observation. However, the algebra associated with the Dirac equation appears to suggest that the fermion requires a double, rather than a single, vector space, and this would seem to be confirmed by the double rotation required by spin $\frac{1}{2}$ objects, and the associated effects of *zitterbewegung* and Berry phase shift. Further investigation of the second 'space' reveals that it is, in effect, an 'antispaces', which contains the same information as real space but in a less accessible form. The two spaces effectively cancel to produce a norm 0 (nilpotent) object which has exactly the mathematical structure required to be a fermionic singularity [5].

Continuing to follow Rowlands we further note that the fermion as a singularity exists in its own multiply-connected space requiring a double rotation to return to its starting position. Fermions also undergo the quantum process of *zitterbewegung* continually switching between real space and complex vacuum space. The double circuit in real space is required because a fermion only exists in this space for half its existence. It is not coincidental that fermion algebra (gamma matrices) requires a commutative combination of two vector spaces for a full mathematical representation. Thus it becomes obvious that constructing a physical 'singularity' requires a dual space [5,6].

While the Rowlands' nilpotent space-antispaces model brilliantly extends our understanding of the nature of a fermionic singularity in terms of the standard model, elegant quaternionic algebra is not necessarily tantamount to a penultimate description of nature. What we mean by that barb is even though the theoretical elements of Rowlands' model are *avant garde* to the standard model they are not sufficiently radical to satisfy the needs of HAM cosmology [7,8] and the associated Noetic Field Theory (NFT): The Quantization of Mind [9-11] that requires Unified Field Mechanics, U_F [12]; but it does provide an inspired basis for making correspondence to the profoundly unique 'singularity' under development in HAM cosmology [7-13].

Before we define the HAM singularity let's briefly review some discrepancies in contemporary theory: Interactions of extended objects can appear point-like. A spherical object in Euclidean space described by the inverse square law can behave like its mass was concentrated in a geometric center. According to Coulomb's law the electric field associated with a classical point charge increases to infinity as the distance from the point charge decreases towards zero making energy-mass of point charge

infinite. In Newtonian gravity and classical electromagnetism a field outside a spherical object is identical to a point particle located at the center of the sphere. In quantum mechanics, the nature of a point particle is complicated by the Heisenberg uncertainty principle where neither elementary nor composite particles are spatially localized, i.e. elementary particles with no internal structure occupy a nonzero volume. A point charge is an idealized model of a particle with no dimensions. However the particle wavepacket always occupies a nonzero volume. For example the electron is an elementary particle, but its quantum states form 3D patterns. Good reason remains to call an elementary particle a point particle. Even if an elementary particle has a delocalized wavepacket, the wavepacket is in a quantum superposition of quantum states localizing the particle. For example, a 1s electron in a hydrogen atom occupies a volume of $\sim 10^{-30} \text{ m}^3$.

3. The Nature of Space

Vigier postulated a 4D model of TBS in hydrogen extending QED [1,2]. The theory seemed incomplete (see forward this volume) until it was extended to a 12D M-Theoretic model with correspondence to the newly postulated LSXD regime of the Unified Field, U_F [12,14] in conjunction with HAM cosmology [7,8]. It remains difficult to know the fundamental polyhedron (topology/geometry) of our cosmology made from observations within it; and astrophysicists continue to struggle with this problem [15-17]. Preliminary data from WMAP has supported an Anti de Sitter ($AdS_5 \times S^5$) Poincaré Dodecahedral ‘wrap-around’ model but more precise Planck satellite data will take several more years as the 2013 data released was not taken at the required frequencies.

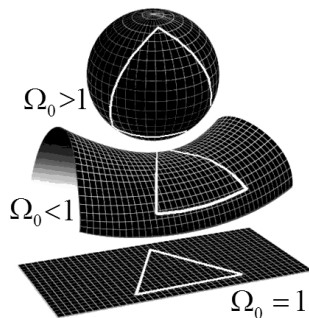

Figure 1. Topologies with positive, negative and zero curvature. Preliminary WMAP data suggests $\Omega_0 > 1$ for our Hubble universe.

For example space appears infinitely flat or Euclidean, but there are numerous observationally flat topologies that are not actually flat. The simplest shape for our reality is a 3-sphere with positive curvature. When we draw tori they appear curved only because

we embed them in 3-space. A flat torus can be made from a square with its edges wrapped around to join seamlessly. The criterion is that the angles of a triangle add up to 180° . If our observed Hubble sphere, H_R is a flat torus observations in certain directions allow one to see oneself in the distance [15-17].

This is compatible with the topology of a Big Bang 3-sphere postulated to be like a 3D expanding balloon; one with a 12 to 15 billion light year radius where light hasn't had sufficient time to cross yet. If the symmetry of curvature is not broken there are three possibilities - 3-sphere topologies with positive, negative and zero curvature as in Fig. 1. But a 3D flat torus (cube with opposite faces joined) has zero curvature. There are also hyperbolic 3D spaces with negative curvature. In a finite 3-space like the H_R purported self-observations in various directions would allow us to work out the curvature and shape of our H_R which is considered closed and finite in HAM cosmology; but open and infinite in the LSXD it is embedded in.

The spatial region observed from any local point is a circular disk that increases in size with time. When it grows to the same size as the H_R it begins to overlap. At this moment because of relativity it would be possible to observe the same object in many directions in the overlapping portions of space. Age of the universe predictions from Big Bang cosmology suggest that if the H_R is a 3-sphere overlapping should have begun and that these overlaps would form large circles in the sky, circles because the intersection of two 3-spheres is a circle [18]. Recent WMAP and Planck satellite observations have observed these putative circles in initial support of Poincaré Dodecahedral Space (PDS) [19-21].

3.1 New Background Conditions of a Dirac Vacuum

If one assumes in conjunction with the de Broglie-Bohm-Vigier Causal Stochastic Interpretation (CSI) of quantum theory [22] that de Broglie matter-waves describe a wave-particle duality built up with real extended space structures with internal oscillations of particle-like spin, it is possible to justify Bohr's physical assumptions and predict new properties of a real Dirac covariant polarized vacuum [23-26]. Bohr's major contribution to modern physics was the model of photon emission-absorption in Hydrogen in terms of random energy jumps between stable quantum states and atomic nuclei. This discovery was one of the starting points for the Copenhagen Interpretation of quantum theory. We suggest this structural-phenomenology by general covariance applies equally as well to the symmetry conditions of a LSXD Dirac vacuum backcloth also; but as one knows the purely random description of quantum jumps suggested by Bohr is obviated by CSI quantum mechanics [22,26,27]

suggesting this interaction is piloted. We feel the CSI model is required for our LCU exciplex gating mechanism to work because it is the internal motion of a massive photon, m_γ that enables (periodic) coupling to the polarized Dirac vacuum and the rf-resonance hierarchy to operate [29,30].

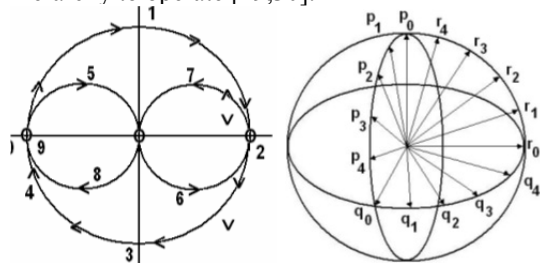

Figure 2 a) 2D simplistic view of 3D Dirac rotation map. b) 2D rendition of 4D view of Dirac hyperspherical rotation for raising and lowering Dirac-type topological advanced-retarded annihilation-creation vectors.

Some experimental evidence has been found to support this view showing the possibility that the interaction of these extended structures in space involve real physical vacuum couplings by resonance with the subquantum Dirac ether. Because of photon mass the CSI model, any causal description implies that for photons carrying energy and momentum one must add to the restoring force of the harmonic oscillator an additional radiation (decelerating) resistance derived from the em (force) field of the emitted photon by the action-equal-reaction law.

Kowalski has shown that emission and absorption between atomic states take place within a time interval equal to one period of the emitted or absorbed photon wave. The corresponding transition time corresponds to the time required to travel one full orbit around the nucleus [31,32]. Individual photons are extended spacetime structures containing two opposite point-like charges rotating at a velocity near c , at the opposite sides of a rotating diameter with a mass, $m \cdot 10^{-65}g$; and with an internal oscillation $E = mc^2 = h\nu$. Thus a new causal description implies the addition of a new component to the Coulomb force acting randomly and may be related to quantum fluctuations. We believe this new relationship has some significance for our model of vacuum C-QED blackbody absorption/emission equilibrium [33]. The result from real causal interactions between the perturbed local background “ether” and its apparently independent moving collective perturbations imply absolute total local momentum and angular momentum conservation.

4. Pertinence of the New Cosmological Paradigm

Utilizing the earlier hadronic form of string theory

based on the original Stoney (precursor to \hbar) instead of Planck’s constant the quaternionic Fermionic ‘singularity’ is allowed to oscillate from a virtual Plank radius (asymptote never reached) to the Lamoure radius of the hydrogen atom. Fortunately for parameters of HAM cosmology this scenario provides a much better footing for understanding the cyclic operation of tight bound states in the Hydrogen atom. We will show how a new form of the Lorentz transformation applicable to our TBS experimental protocol requires these oscillations.

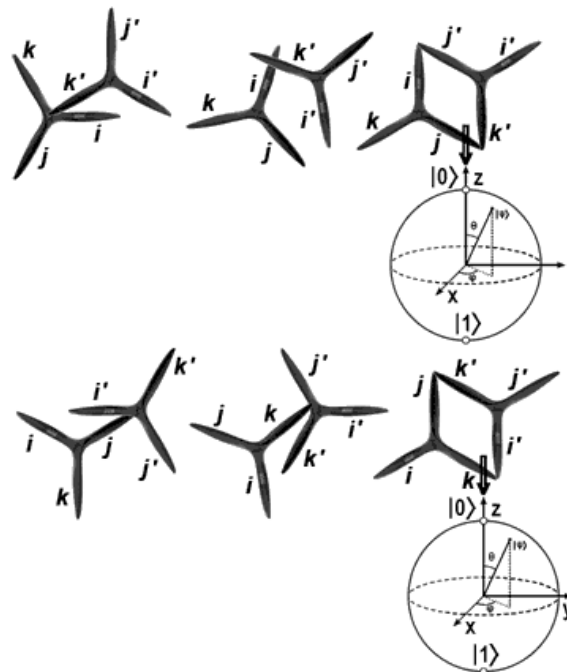

Figure 3. Alternative rendition of Fig. 4 in quaternionic form. Locus of HD mirror symmetric Calabi-Yau 3-tori here depicted as dual quaternion trefoil knots spinning relativistically and evolving quantum mechanically in time. Nodes in the cycle are sometimes chaotic (degenerate) and sometimes periodically couple coherently into resultant quantum states in Euclidean 3-space depicted in the figure as faces of a 3-cube that reduce further to the Riemann Bloch 2-sphere at the bottom.

This horrendous concatenation occurs as the basis for the arrow of time because our temporal virtual reality surfs as it were of the face of the LSXD eternal realm hidden behind it. (The discrete frames of spacetime film in Fig. 3 producing the continuous virtual image of reality relativistically on the screen) These parameters are essential to the LCU as an exciplex gating mechanism - This is how each point (LCU open-closed singularity - like a rotating light house beacon) is created in the temporal locus and allows the U_F ’s ‘force of coherence’ to modulate complex self-organized living systems (SOLS) as the organizing principle itself and likewise mediate the physical basis of qualia [9-11]. We will do our best to

clarify this scenario in the text and figures in sections following.

We are not yet finished outlining the required battery of new physical parameters; recall that NFT represents a whole paradigm shift. (why it hasn't been easy this past 1,000 years) WE MUST also utilize the parameters of another well established and generally ignored aspect of contemporary physics called Extended Electromagnetic Theory [34-36] in conjunction with a covariant Dirac polarized vacuum (ignored also) [23-26]; both because physicists erroneously believe they conflict with Gauge Theory which has been eminently successful for decades. Now we are finally be set up with enough parameters to putatively manipulate the spacetime backcloth (Einstein energy dependent spacetime metric) [37].

Metaphorically if one throws a stone in water concentric ripples occur. If one throws two stones regions of destructive and constructive interference occur. We will utilize an M-Theoretic Calabi-Yau symmetric version of this model to set up an rf-pulsed spacetime resonance hierarchy to access the 'hidden' regime of the U_F [12]. In the next series of several figures (Figs. 5-8) we will attempt to clarify the continuous-state structure of LSXD as it applies to HAM cosmology.

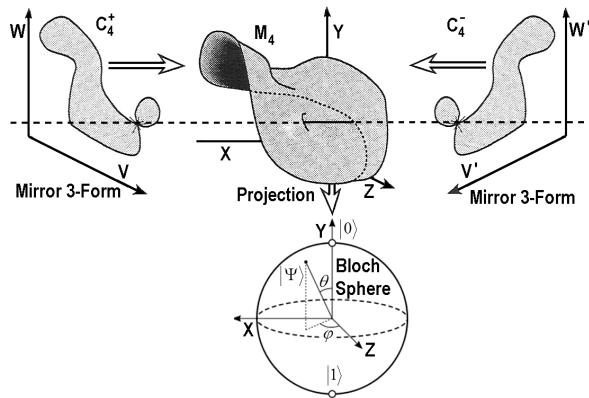

Figure 4. Complex Calabi-Yau mirror symmetric 3-form potentia, C_4 become an embedded quantum resultant in Minkowski space, M_4 . This resultant projection entails a continuous quantum state evolution represented as a Bloch 2-Sphere. This represents the lower portion that embeds in local spacetime; there is an additional 5D dodecahedral duality above this projection embedded in the infinite potentia of the U_F from which it arises.

5. Required New Particle physics - Cosmology

In contrast to the standard model of particle physics and cosmology we utilize a continuous-state [7] hypothesis and follow an extended form of the de Broglie-Bohm causal interpretation of QT in conjunction with Cramer's Transactional Interpretation where matter is created - annihilated - and recreated

with a beat frequency in conjunction with a 'least cosmological unit' (LCU) tiling the spacetime backcloth [7,13].

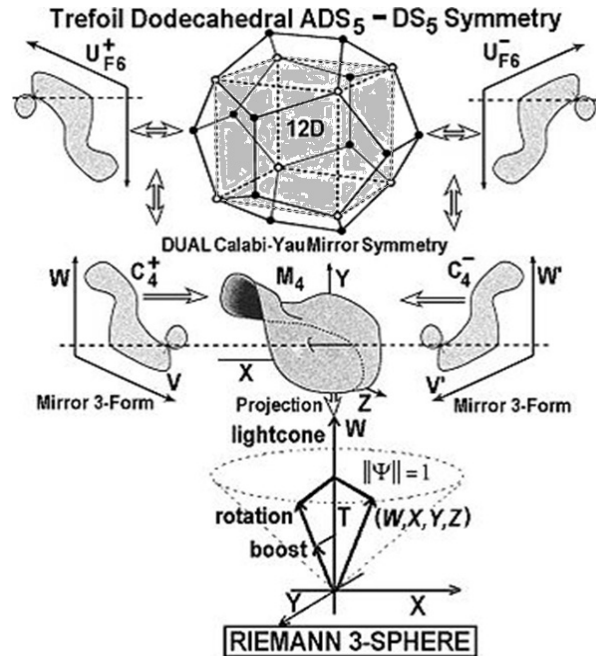

Figure 5. Complete LSXD regime of HAM cosmology illustrating the hierarchy of its geometric topology. Dodecahedral involute properties, as well as the continuous-state exciplex 'hysteresis loop' of noone injection not shown. It represents a unique M-Theoretic model of 'Continuous-State' U_F dynamics as it relates to NFT and its putative exchange quanta of the U_F called the noone.

This is a nilpotent condition, $Z \cdot Z' = 0$ [5,6] where matter and the spacetime in which it is embedded arise from an HD infinite potentia. Some GUT theories postulate proton decay with a half-life of 10^{36} years according to $p \rightarrow e^+ + \pi^0$; $\pi^0 \rightarrow 2\gamma$. The conundrum is that this lends some support to the Copenhagen/Big Bang scenario of nucleosynthesis occurring near the time of the putative original singularity. But the lifetime of a proton is not the concern; it is its true quantum nature in terms of a continuous-state M-Theoretic Calabi-Yau mirror symmetric relativistic topological quantum field theory.

However what we need to do is extend the de Broglie-Bohm point of view that suggests matter is a form of HD complex standing-wave that is continuously annihilated and recreated with the quantum wave function piloted by a unitary anthropic action principle tantamount to a 'super-quantum potential.

In addition to the spacetime vacuum being considered as a form of a Dirac covariant polarized vacuum, this framework has parameters of hyperspherical rotation (condition usually described by the Dirac equation for properties of the electron)

relative to the topology of the HD Calabi-Yau mirror symmetry or dual 3-torus. In terms of the continuous-state hypothesis and large scale XD a 'cootie catcher'-like gating mechanism is an inherent structure mediating local 3-space and HD space transformations that constitute a varying spacetime cavity volume. The putative existence of this hysteresis loop volume is suggested as an empirical proof of TBS and LSXD.

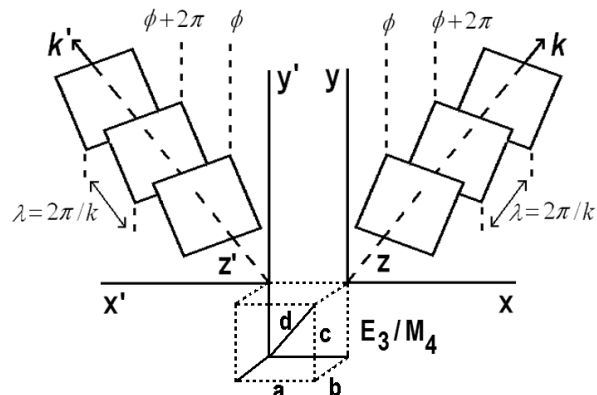

Figure 6. Calabi-Yau future-past mirror symmetry potentia shown as tiered surfaces (additional dimensionality suppressed) of constant phase, in this case to represent cyclic components of evenly spaced orthogonal standing reality waves with the E_3/M_4 cubic resultant localized at the bottom. The resultant locked in 4D by the uncertainty principle. The resultant Euclidean cube is locked in 4D by the uncertainty principle keeping the HD parameters inaccessible to the empirical tools available to the Copenhagen framework. k & k' topologically infolds into an HD continuous-state torus.

The noeton mediating the U_F does not imply the usual phenomenological exchange of energy as in a standard field interaction such as the photon of the electromagnetic field; but constitutes an ontological exchange (without energy transfer). This is achieved by a process called 'topological switching' and implies instead a 'force of coherence' inherent in the action of the U_F . This process also allows the quantum uncertainty principle defined by the Copenhagen Interpretation of quantum theory to be surmounted [7]. Figure 8 illustrates a nilpotent continuous-state regime cycling from a 12D dodecahedral de Sitter space [15-20] through an intermediate Calabi-Yau mirror symmetry to a virtual 'standing-wave' nilpotent 3D Euclidean space resultant.

We extend Vigiér's original model of TBS in hydrogen [1,2] to include a unique 12D M-Theoretic perspective [7] with a Calabi-Yau : Dodecahedral involute mirror symmetry in Continuous-State HD space [8,11] elevating Cramer's Transactional model and wave-particle duality to principles of cosmology. The 4-Space nilpotent resultant of the E_3/M_4 virtual present which is a standing-wave of the future-past is shown in Figs. 2-9. M_4 being 'locked' into place cyclically by the uncertainty principle [7].

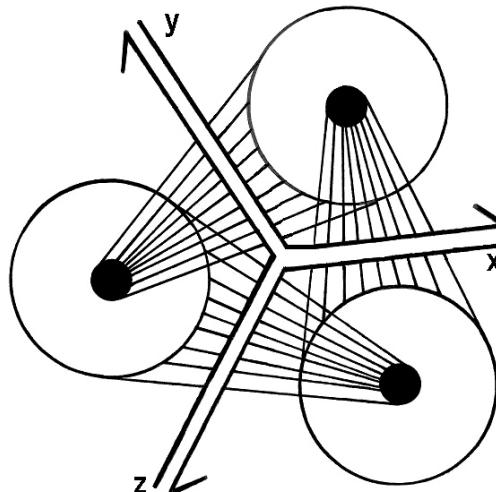

Figure 7. Triune structure of a solitary least unit that like an isolated quark does not exist in nature. The central parallel lines are the Witten string vertex with properties of a complex Riemann sphere able to continuously rotate from zero to infinity. The field lines represent the 'super quantum potential' of the unified field, U_F .

The HD are not curled up at the Planck scale because they are invisible; they are Large-scale XD (LSXD) because of subtractive interferometry as it were of the $C_4^+ - M_4 - C_4^-$ standing-wave modes that operates like a movie theatre where discrete frames of film moving through the projector at a few cm/sec appear continuous on the screen. For our virtual reality exchange quanta of the U_F is relativistically 'pumped' through discrete holographic-like LCU tiling the raster of spacetime to produce virtual images of a Minkowski space present. Behind the virtual veil is a continuous-state cycle from $0 \leftrightarrow \infty$ as shown in Fig. 3.

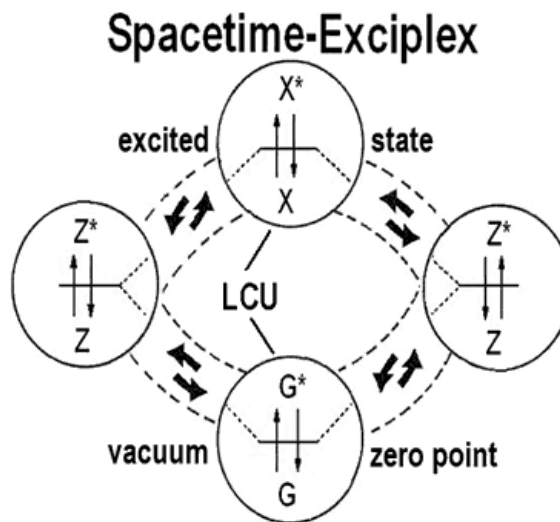

Figure 8. Least Unit Exciplex Composite. The spacetime exciplex complex is comprised of an array of least cosmological units that act as a gating mechanism for entry of unified field control parameters to operate on Minkowski 4-space.

5.1 Possibility of Cavity QED Emission From Continuous Spacetime Compactification

Exciplex properties of spacetime and matter also suggest that further development of the C-QED model of CMBR emission could be extended to include spontaneous emission from the continuous dimensional reduction process of compactification. This would follow from modeling spacetime cavity dynamics in a manner similar to that in atomic theory for Bohr orbitals. As well-known photon emission results from electromagnetic dipole oscillations in boundary transitions of atomic Bohr orbitals. Bohr's quantization of atomic energy levels is applied to the topology of Spacetime C-QED boundary conditions in accordance with equation (37) where spacetime QED cavities of energy, E_i undergo continuous harmonic transition to a higher state, $E_j (> E_{iH})$ (redshift-absorption mode).

The general equations for a putative LCU spacetime exciplex are:

$$\begin{aligned} G^* + G^* &\Leftrightarrow Z^*; \quad Z^* + m_\gamma \Leftrightarrow X^* \\ X^* - m_\gamma &\xrightarrow{\text{emission}} Z^* \quad \text{or} \quad G^* \\ X^* + m_\gamma &\rightarrow Z^* \quad \text{or} \quad G^* \end{aligned} \quad (37)$$

where G is the ZPF ground, Z black body cavity excited states and X the spacetime C-QED exciplex coupling. The numerous configurations plus the large variety of photon frequencies absorbed allow for a full black body absorption-emission equilibrium spectrum. We believe the spacetime exciplex model also has sufficient parameters to allow for the spontaneous emission of protons by a process similar to the photoelectric effect but from spacetime C-QED spallation rather than from metallic surfaces.

A torus is generated by rotating a circle about an extended line in its plane where the circles become a continuous ring. According to the equation for a torus, $\left[\left(\sqrt{x^2 + y^2} \right) - R \right]^2 + z^2 = r^2$, where r is the radius of the rotating circle and R is the distance between the center of the circle and the axis of rotation. The volume of the torus is $2\pi^2 Rr^2$ and the surface area is $4\pi^2 Rr$, in the above Cartesian formula the z axis is the axis of rotation.

Electron charged particle spherical domains fill the toroidal volume of the atomic orbit by their wave motion. If a photon of specific quanta is emitted while an electron is resident in an upper more excited Bohr orbit, the radius of the orbit drops back down to the

next lower energy level decreasing the volume of the torus in the emission process.

We suggest that these toroidal orbital domains have properties similar to QED cavities and apply this structure to *topological switching* during dimensional reduction in the continuous-state universe (HAM) model [7]. To summarize pertinent aspects of HAM cosmology:

- Compactification did not occur immediately after a big bang singularity, but is a continuous process of dimensional reduction by *topological switching* in view of the Wheeler-Feynman absorber model where the present is continuously recreated out of the *future-past*. Singularities in the HAM are not point like, but dynamic wormhole like objects able to translate extension, time and energy.
- The higher or compactified dimensions are not a subspace of our Minkowski 3(4)D reality, but our reality is a subspace of a higher 12D multiverse of three 3(4)D Minkowski spacetime packages.

During the spin-exchange process of dimensional reduction by topological switching two things pertinent to the discussion at hand:

- There is a transmutation of dimensional form from *extension to time to energy*; in a sense like squeezing out a sponge as the current Minkowski spacetime package recedes into the past down to the Planck scale; or like an accordion in terms of the *future-past* recreating the present.
- A tension in this process (string tension, T_0 in superstring theory) allows only specific loci or pathways to the dimensional reduction process during creation of the transient Planck scale domain. Even though there are discrete aspects to this process it appears continuous from the macroscopic level (like the film of a movie); the dynamics of which are like a harmonic oscillator.

With the brief outline of HAM parameters in mind, the theory proposes that at specific modes in the periodicity of the Planck scale pinch effect, cavities of specific volume reminiscent of Bohr toroidal atomic orbits occur. It is proposed rather speculatively at present that these cavities, when energized by stochastically driven modes in the Dirac ether or during the *torque moment* of excess energy during the continuous-state compactification process, or a combination of the two as in standard C-QED theory of Rabi/Rydberg spontaneous emission, microwave photons of the CMBR type could be emitted spontaneously from the vacuum during *exciplex* torque moments. This obviously suggests that Bohr atomic

orbital state reduction is not the only process of photon emission; (or spacetime modes are more fundamental) but that the process is also possible within toroidal boundary conditions in spacetime itself when in a phase-locked mode acting like an atomic volume. A conceptualization of a Planck scale cavity during photon emission is represented in figure 7.1c with nine dimensions suppressed.

LSXD Hydrogen Exciplex

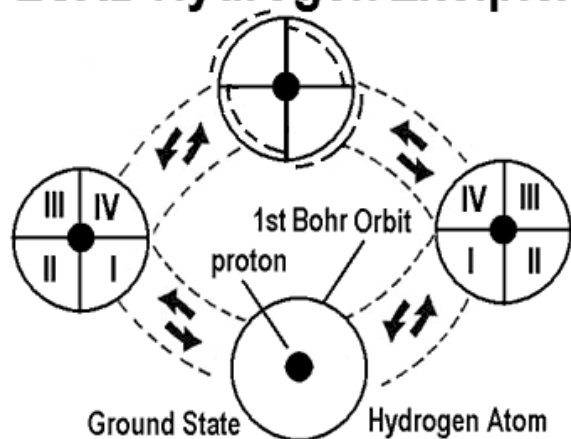

Figure 9. LSXD Exciplex complex with conformal scale-invariant properties revealing operation of TBS cyclicity in the hydrogen atom mediated by the fluctuating form of Planck's constant varying from asymptotic virtual Planck to the Larmor radius of the hydrogen atom. This is a variable cavity-QED representation whereby new spectral lines will appear at various nodes in the continuous-state LSXD cycle.

In early spectroscopy the orbital series associated with Rydberg states was proportional to the difference between the two terms of an energy level transition which became known as sharp, principle, diffuse and Fundamental, so the designators *s*, *p*, *d*, *f* were used to represent orbital angular momentum states of an atom.

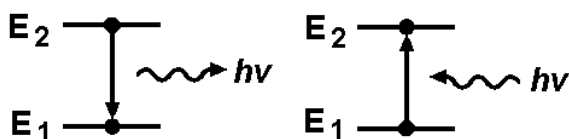

Figure 10. Usual geometric consideration of absorption/emission from an atomic orbital. a) Decrease in energy level E_2 to E_1 resulting in photon emission (squiggle arrow) with energy, $h\nu$. b) An increase in energy level from E_1 to E_2 resulting from absorption of a photon (squiggle arrow) with energy, $h\nu$.

Quantized energy levels result from the relation between a particle's energy and its wavelength. For a confined particle such as an electron in an atom, the wave function has the form of standing waves. Only stationary states with energies corresponding to integral numbers of wavelengths can exist; for other

states the waves interfere destructively, resulting in zero probability density. Elementary examples that show mathematically how energy levels come about are the particle in a box and the quantum harmonic oscillator.

Figures 3-5 represent a conceptualized view of the continuous-state evolution of 6D Calabi-Yau mirror symmetry. The cycle goes from chaotic-uncertain to coherent-certain perhaps cycling from noncommutative to commutative. This is like the Dirac string trick or a Philippine wine dance [38].

The energies of Rydberg states are sensitive to the geometrical structure of the molecular ion core. Rydberg states with low quantum numbers are conveniently accessed using multi-photon excitation via valence states, providing spectra with intensity distributions that depend sensitively on the molecular isomeric form. This discovery opens up the possibility of using Rydberg states to fingerprint the shapes of molecules. Because of the large size of the Rydberg orbitals, the Rydberg fingerprint methodology can have applications in the characterization of biological and nanoscale structures [39].

6. Atomic Theory - Elements of Atomic Structure

Atoms and molecules have Intrinsic orbital state energy levels - specifically, here for the case of a hydrogen atom with a single proton nucleus and a one electron orbital, the energy of state is primarily determined by the electrostatic interaction of the negatively charged electron with the positively charged proton. The energy levels of an electron around a nucleus are given by $E_n = -\hbar c R_\infty (Z^2 / n^2)$ where R_∞ is the Rydberg constant, Z the atomic number and n the principle quantum number. For the hydrogen atom Rydberg levels depend only on the principal quantum number, n (the only Bohr model quantum number).

- Electron Energy, The 1st term is kinetic and the 2nd potential

$$E = \frac{1}{2}mv^2 - \frac{e^2}{r}$$

- Bohr Radius

$$r = \alpha_0 n^2$$

- Centripetal Force

$$F^2 = \frac{e^2}{mr} \Rightarrow$$

$$E = \frac{1}{2}m \left(\frac{e^2}{mr} \right) - \frac{e^2}{r} = -\frac{e^2}{2r} = -\frac{e^2}{2\alpha_0 n^2}$$

- Rydberg Energy

$$E_R = \frac{e^2}{2\alpha_0} \Rightarrow E = -\frac{E_R}{n^2}$$

$$\text{for } \begin{cases} n=1 & E = -E_R \\ n=\infty & E = 0 \end{cases}$$

For our process the periodic presence of a larger continuous-state QED cavity (LSXD) will shift the energy level structure in the TBS hydrogen atom, thereby altering the frequency of the emitted radiation. According to atomic theory the duration of this influence is much longer than the lifetime of the emission process thus providing a sufficient period for the putative experimental effect to occur. The Zeeman and Stark effects could help explain or act as an aid in setting up the LSXD TBS experiments.

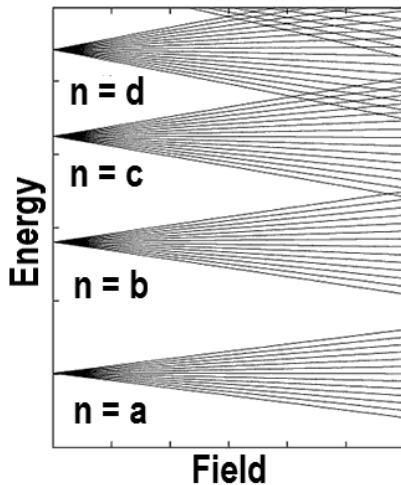

Figure 11. Rydberg atomic energy level spectra for hydrogen in an electric field. If the TBS experiment proves successful the position and ‘volume’ of these QED orbital cavities will be different than the historical spectral lines of hydrogen.

The Zeeman Effect describes splitting a spectral line into a number of components in the presence of a static magnetic field. It is analogous to the Stark effect, the shifting and splitting of spectral lines of atoms and molecules into several components in the presence of an external electric field. When the spectral lines are absorption lines, the effect is called inverse Zeeman Effect. The Stark effect can lead to splitting of degenerate energy levels. For example, in the Bohr model, an electron has the same energy whether it is in the 2s state or any of the 2p states. However, in an electric field, there will be quantum superpositions of the 2s and 2p states. Where the electron tends to be to the left it will acquire a lower energy; in other hybrid

orbitals where the electron tends to be to the right it will acquire a higher energy. Therefore, the formerly degenerate energy levels will split into slightly lower and slightly higher energy levels. Since an atom is a collection of point charges (electrons and nuclei) dipole conditions apply. The interaction of atom or molecule with a uniform external field is described by the operator, $V_{\text{int}} = -F \cdot \mu$.

7. TBS Experimental Theory

Traditionally spectral emission/absorption lines provide information characteristic of the internal structure of an atom by, $E = \hbar\nu = \hbar c / \lambda$ or by the wave number, $\sigma \equiv 1/\lambda = E/\hbar c$ such that each atom has discrete characteristic wavelengths confirmed by monochromatic x-ray bombardment. Every atom has a variety of possible energy levels; the lowest called the ground state. From the excited state of energy, E_2 decay may occur to a lower state, E_1 with the energy difference occurring as a photon of energy, $E_2 - E_1$ with frequency, ν , wavelength, λ and wave number,

$$E_2 - E_1 = \hbar\nu = \frac{\hbar c}{\lambda} = \hbar c \sigma$$

with a perfectly definite value for a monochromatic spectrum [40].

The Born-Oppenheimer (BO) approximation [41,42] which is based on the fact that within molecular systems fast-moving electrons can be distinguished from slow-moving nuclei allows the wavefunction of a molecule to be broken into its electronic and nuclear (vibrational, rotational)

$$\Psi_{\text{Total}} = \Psi_{\text{Electronic}} \times \Psi_{\text{Nuclear}}$$

components for easier calculation. The assumption is made that if non-adiabatic coupling terms are negligibly small then the upper electronic surfaces have no effect on the nuclear wave function of the lower surface. This assumption is not considered dependent on the systems energy.

However, the ordinary BO approximation was also employed for cases where these coupling terms are not necessarily small, assuming that the energy can be made as low as required. The justification for applying the approximation in such a case is that for a low enough energy the upper adiabatic surfaces are classically forbidden, implying that the components of the total wave function related to these states are negligibly small. As a result the terms that contain the product of these components with the nonadiabatic coupling terms are also small, and will have a minor effect on the dynamical process.

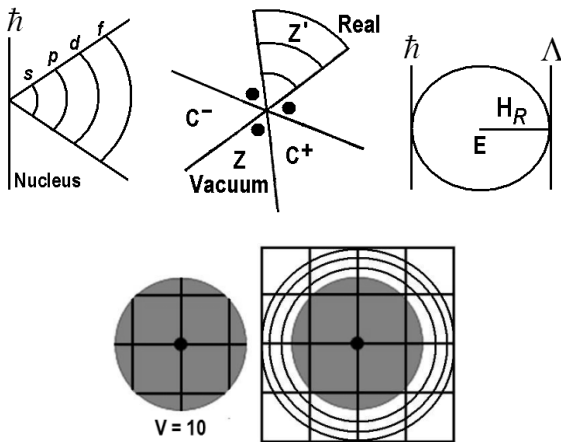

Figure 12. Historical evolution of atomic concepts. a) 2D representation of 3D reduction cone of standard Bohr orbits. b) Z' Real is same as (a), Z Vacuum is the Rowland's nilpotent doubling, C^+ & C^- complex Calabi-Yau mirror symmetric generators & the 3 dots represent continuous-state control elements. c) Wave function domain of the Hubble Universe, $H = \Psi$ with a 1st and 2nd quantization, \hbar , Λ respectively of the Hubble radius, H_R with the Earth observer, E in center. d) Conceptualized area, $V = 10$; (central dot is proton) for the usual representation of the s Bohr orbital in a hydrogen atom. e) Same as (d) but with additional LSXD complex TBS space area represented. In reality the square would be folded up into a 3-torus or HD Klein bottle. The additional three concentric circles beyond the $V = 10$ volume of the gray circle representing the hydrogen atom s orbital are meant to represent the added TBS periodic LSXD 12-14-16 energy volume cycles of the continuous-state matter-wave annihilation-creation process.

The protocol will test for both the existence of TBS and also for large scale XD. HAM Cosmology predicts novel HD cavities in the brane topology of Calabi-Yau mirror symmetry. Simplistically a tunable NMR device acts on a vial of hydrogen over a range of de Broglie wavelengths set for specific Cavity-QED resonances to probe the lowest Bohr orbit for TBS. If our cosmological model is correct there will be novel resonances that cannot correspond to either classical wave mechanics or Copenhagen modes. One might suspect C-QED to detect nodes in the Dirac spherical rotation of the electron (cyclical pattern of Klein bottle open-closed modes). Critics might say this is just a 4D effect Dirac effect of the putative Klein bottle symmetries in the electron's spinor rotation. But our XD cosmology predicts a much richer Calabi-Yau mirror symmetry within the higher 9D brane topology so there "should" be a cycle of novel TBS resonances in the Calabi-Yau symmetry. Likewise these resonance nodes would have de Broglie wavelengths different than any higher Bohr orbit excitation in Hydrogen. It may be possible to predict the de Broglie wavelengths in the resonance hierarchy if the topology can be determined or if a clear C-QED resonance hierarchy appears the topological structure of higher dimensions

may be revealed. Vigiér discussed using deuterium; it is an open question if that would make a qualitative difference in success or results in such an experiment.

In an earlier work [8,43] we designed a tachyon measurement experiment by initially considering Bohr's starting point for the development of quantum theory, i.e. the emission of photons by atoms from quantum jumps between stable Bohr orbits. We did this from the point of view of the de Broglie-Bohm causal stochastic interpretation in order to take into consideration new laser experimental results described by Kowalski [31,32]. As one knows light emitted from atoms during transitions of electrons from higher to lower energy states takes the form of photon quanta carrying energy and angular momentum. Any causal description of such a process implies that one adds to the restoring force of the harmonic oscillator an additional radiation (decelerating) resistance associated (derived from) with the electromagnetic (force) field of the emitted photon by the action equal reaction law. Any new causal condition thus implies that one must add a new force to the Coulomb force acting at random and which we suggest is related to ZPF vacuum resonant coupling and motions of the polarized Dirac aether. We assume that the wave and particle aspects of electrons and photons are built with real extended spacetime structures containing internal oscillations of point-like electromagnetic topological charges, e^\pm within an extended form of the causal stochastic interpretation of quantum mechanics. Kowalski's interpretation drawn from recent laser experiments [31,32] showing that emission and absorption between Bohr atomic states take place within a time interval equal to one period of the emitted-absorbed photon wave, the corresponding transition time is the time needed for the orbiting electron to travel one full orbit around the nucleus. We note that the same Lorentz conditions denoted in the tachyon measurement experiment apply directly to the TBS experiment with slight phase control alterations in the Cramer-like standing-wave oscillation of the HD Calabi-Yau mirror symmetries.

- This suggests that electrons (like all massive particles) are not point-like but must be considered as extended spacetime topological structures imbedded in a real physical Dirac aether [23-26].
- These structures contain internal oscillations of point-like quantum mechanical charges around corresponding gravitational centers of mass, Y_μ so that individual electrons have different centers of mass and electromagnetic charge in the particle's and piloting fields.
- The Compton radius of mass is much larger than the radius of the charge distribution [1,2].

- The centers of charge, X_μ rotates around the center of mass, Y_μ with velocity near the velocity of light, c so that individual electrons are real oscillators with Broglian internal oscillations [7].
- Individual photons are also extended spacetime structures containing two opposite point-like charges, e^\pm rotating with the nearly the velocity of light, $v \simeq c$ at opposite sides of a rotating diameter, with a mass, $m_\gamma = 10^{-65}$ gm. and an internal oscillation, $E = mc^2 = \hbar$. (Fig. 13)
- The real aether is a covariant polarized Dirac-type stochastic distribution of such extended photons which carry electromagnetic waves built with sets of such extended photons beating in phase and thus constituting subluminal and superluminal collective electromagnetic fields detected in the Casimir Effect so that a Bohr transition with one photon absorption occurs when a non-radiating Bohr orbital electron collides and beats in phase with an aether photon. In that case a photon is emitted and Bohr electron's charge e^- spirals in one rotation towards the lower level (Excepion)

7.1 Lorentz Condition in Complex 8-Space and Tachyonic Signaling

In order to examine as the consequences of the relativity hypothesis that time is the fourth dimension of space, and that we have a particular form of transformation called the Lorentz transformation, we must define velocity in the complex space. That is, the Lorentz transformation and its consequences, the Lorentz contradiction and mass dilation, etc., are a consequence of time as the fourth dimension of space and are observed in three spaces [8]. These attributes of 4-space in 3-space are expressed in terms of velocity, as in the form $\gamma = (1 - \beta^2)^{-1/2}$ for $\beta \equiv v_{\text{Re}} / c$ where c is always taken as real.

If complex 8-space can be projected into 4-space, what are the consequences? We can also consider a 4D slice through the complex 8D space. Each approach has its advantages and disadvantages. In projective geometries information about the space is lost. What is the comparison of a subset geometry formed from a projected geometry or a subspace formed as a slice through an XD geometry? What does a generalized Lorentz transformation "look like"? We will define complex derivatives and therefore we can define velocity in a complex plane [8].

Consider the generalized Lorentz transformation in the system of x_{Re} and t_{Im} for the real time remote

connectedness case in the $x_{\text{Re}}, t_{\text{Im}}$ plane. We define our substitutions from 4-to 8-space before us,

$$\begin{aligned} x &\rightarrow x' = x_{\text{Re}} + ix_{\text{Im}} \\ t &\rightarrow t' = t_{\text{Re}} + it_{\text{Im}} \end{aligned} \quad (15)$$

and we represented the case for no imaginary component of x_{Re} or $x_{\text{Im}} = 0$ where the $x_{\text{Re}}, t_{\text{Re}}$ plane comprises the ordinary 4-space plane.

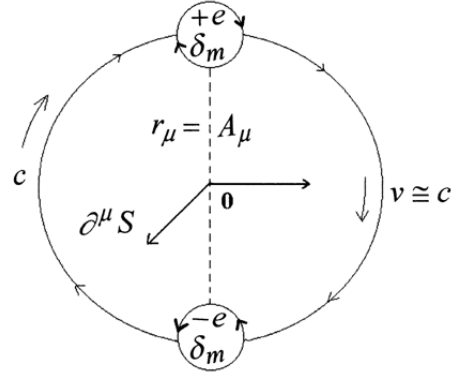

Figure 13. Diagram conceptualizing two oppositely charged sub-elements rotating at $v \cong c$ around a central point 0 behaving like a dipole bump and hole on the topological surface of the covariant polarized Dirac vacuum.

Let us recall that the usual Lorentz transformation conditions defined in four real space. Consider two frames of reference, Σ , at rest and Σ' moving at relative uniform velocity v . We call v the velocity of the origin of Σ' moving relative to Σ . A light signal along the x direction is transmitted by $x = ct$ or $x - ct = 0$ and also in Σ' as $x' = ct'$ or $x' - ct' = 0$, since the velocity of light in vacuo is constant in any frame of reference in 4-space. For the usual 4D Lorentz transformation, we have as shown in Eq. (16), $x = x_{\text{Re}}, t = t_{\text{Re}}$ and $v_{\text{Re}} = x_{\text{Re}} / t_{\text{Re}}$.

$$\begin{aligned} x' &= \frac{x - vt}{\sqrt{1 - v^2 / c^2}} = \gamma(x - vt) \\ y' &= y \\ z' &= z \end{aligned} \quad (16)$$

$$t' = \frac{t - (v/c^2)x}{\sqrt{1 - v^2 / c^2}} = \gamma \left(t - \left(\frac{v}{c^2} x \right) \right)$$

for $\gamma = (1 - \beta^2)^{-1/2}$ and $\beta = v / c$. Here x and t stand for x_{Re} and t_{Re} and v is the real velocity.

We consider the $x_{\text{Re}}, t_{\text{Im}}$ plane and write the expression for the Lorentz conditions for this plane

(Fig. 2.1). Since again t_{lm} like t_{Re} is orthogonal to x_{lm} and t'_{lm} is orthogonal to x'_{lm} we can write

$$\begin{aligned} x' &= \frac{x - i v t_{lm}}{\sqrt{1 - v^2 / c^2}} = \gamma_v (x - v t_{lm}) \\ y' &= y \\ z' &= z \end{aligned} \tag{17}$$

$$t' = \frac{t - (v / c^2) x}{\sqrt{1 - v^2 / c^2}} = \gamma_v \left(t - \left(\frac{v}{c^2} x \right) \right)$$

where γ_v represents the definition of γ in terms of the velocity v ; also $\beta_{v_{lm}} \equiv v_{lm} / c$ where c is always taken as real [19] where v can be real or imaginary.

In Eq. (17) for simplicity we let x', x, t' and t denote x'_{Re}, x_{Re}, t'_{Re} and t_{Re} and we denote script v as v_{lm} . For velocity, v is $v_{Re} = x_{Re} / t_{Re}$ and $v = v_{lm} = i_{lm} / i t_{lm}$; where the i drops out so that $v = v_{lm} = x_{lm} / t_{lm}$ is a real value function. In all cases the velocity of light c is c . We use this alternative notation here for simplicity in the complex Lorentz transformation.

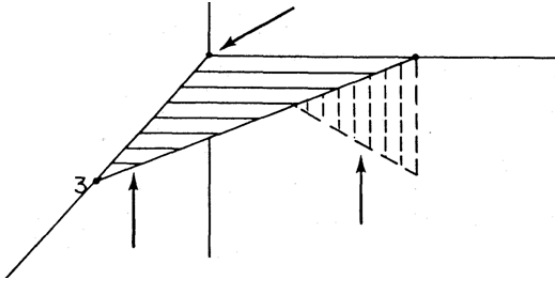

Figure 14. We illustrate an example in which a real space-like separation of events P_1 and P_2 appears to be contiguous by the introduction of the complex time, $t_{x_{Re}} + i t_{x_{Im}}$ such that from the point of view of event P_3 , the time-like separation between $(x_2(P_2) - x_1(P_1))$ appears to be zero.

The symmetry properties of the topology of the complex 8-space gives us the properties that allow Lorentz conditions in 4D, 8D and ultimately 12D space. The example we consider here is a subspace of the 8-space of x_{Re}, t_{Re}, x_{Im} and t_{Im} . In some cases we let $x_{Im} = 0$ and just consider temporal remote connectedness; but likewise we can follow the anticipatory calculation and formulate remote, nonlocal solutions for $x_{Im} \neq 0$ and $t_{Im} = 0$ or $t_{Im} \neq 0$. The

anticipatory case for $x_{Im} = 0$ is a 5D space as the space for $x_{Im} \neq 0$ and $t_{Im} = 0$ is a 7D space and for $t_{Im} \neq 0$ as well as the other real and imaginary spacetime dimensions, we have our complex 8D space.

It is important to define the complex derivative in order to define velocity, v_{lm} . In the $x_{Re} t_{lm}$ plane then, we define a velocity of $v_{lm} = dx / dt_{lm}$. In the next section we detail the velocity expression for v_{lm} and define the derivative of a complex function in detail [8].

For $v_{lm} = dx / dt_{lm} = -i dx / dt_{Re} = -i v_{Re}$ for v_{Re} as a real quantity, we substitute into our x_{Re}, t_{lm} plane Lorentz transformation conditions as

$$\begin{aligned} x' &= \frac{x_{Re} - v_{Re} t_{lm}}{\sqrt{1 + v_{Re}^2 / c^2}} \\ y' &= y \\ z' &= z \end{aligned} \tag{18}$$

$$t'_{lm} = \frac{t_{Re} - v_{Re} x_{Re}}{\sqrt{1 + v_{Re}^2 / c^2}}$$

These conditions are valid for any velocity, $v_{Re} = -v$.

Let us examine the way this form of the Lorentz transformation relates to the properties of mass dilation. We will compare this case to the ordinary mass dilation formula and the tachyonic mass formula of Feinberg [8] which nicely results from the complex 8-space.

In the ordinary $x_{Re} t_{Re}$ plane then, we have the usual Einstein mass relationship of

$$m = \frac{m_0}{\sqrt{1 - v_{Re}^2 / c^2}} \quad \text{for } v_{Re} \leq c \tag{19}$$

and we can compare this to the tachyonic mass relationship in the xt plane

$$m = \frac{m_0^*}{\sqrt{1 - v_{Re}^2 / c^2}} = \frac{i m_0}{\sqrt{1 - v_{Re}^2 / c^2}} = \frac{m_0}{\sqrt{v_{Re}^2 / c^2 - 1}} \tag{20}$$

for v_{Re} now $v_{Re} \geq c$ and where m^* or m_{Im} stands for $m^* = i m$ and we define m as m_{Re} ,

$$m = \frac{m_0}{\sqrt{1 + v^2 / c^2}} \tag{21}$$

For m real (m_{Re}), we can examine two cases on v as $v < c$ or $v > c$, so we will let v be any value from $-\infty < v < \infty$, where the velocity, v , is taken as real, or v_{Re} .

Consider the case of v as imaginary (or v_{Im}) and examine the consequences of this assumption. Also we examine the consequences for both v and m imaginary and compare to the above cases. If we choose v imaginary or $v^* = iv$ (which we can term v_{Im}) the $v^{*2} / c^2 = -v^2 / c^2$ and $\sqrt{1 + v^{*2} / c^2}$ becomes $\sqrt{1 - v^2 / c^2}$ or

$$m = \frac{m_0}{\sqrt{1 - v_{\text{Re}}^2 / c^2}} \quad (22)$$

We get the form of this normal Lorentz transformation if v is imaginary ($v^* = v_{\text{Im}}$)

If both v and m are imaginary, as $v^* = iv$ and $m^* = im$, then we have

$$m = \frac{m_0^*}{\sqrt{1 + v^{*2} / c^2}} = \frac{im_0}{\sqrt{1 - v^2 / c^2}} = \frac{m_0}{\sqrt{v^2 / c^2 - 1}} \quad (23)$$

or the tachyonic condition.

If we go "off" into $x_{\text{Re}} t_{\text{Re}} t_{\text{Im}}$ planes, then we have to define a velocity "cutting across" these planes, and it is much more complicated to define the complex derivative for the velocities. For subluminal relative systems Σ and Σ' we can use vector addition such as $W = v_{\text{Re}} + iv_{\text{Im}}$ for $v_{\text{Re}} < c$, $v_{\text{Im}} < c$ and $W < c$. In general there will be four complex velocities. The relationship of these four velocities is given by the Cauchy-Riemann relations in the next section.

These two are equivalent. The actual magnitude of v may be expressed as $v = [v v^*]^{1/2} \hat{v}$ (where \hat{v} is the unit vector velocity) which can be formed using either of the Cauchy-Riemann equations. It is important that a detailed analysis not predict any extraneous consequences of the theory. Any new phenomenon that is hypothesized should be formulated in such a manner as to be easily experimentally testable.

Feinberg suggests several experiments to test for the existence of tachyons [8]. He describes the following experiment – consider in the laboratory, atom A , at time, t_0 is in an excited state at rest at x_1 and atom B is in its ground state at x_2 . At time t_1 atom A descends to the ground state and emits a tachyon in the direction of B . Let E_1 be this event at t_1, x_1 . Subsequently, at $t_2 > t_1$ atom B absorbs the tachyon and ascends to an excited state; this is event E_2 , at t_2, x_2 . Then at $t_3 > t_2$ atom B is excited and A is in its ground state. For an observer traveling at an appropriate velocity, $v < c$ relative to the laboratory frame, the events E_1 and E_2 appear to occur in the opposite order

in time. Feinberg describes the experiment by stating that at t_2 atom B spontaneously ascends from the ground state to an excited state, emitting a tachyon which travels toward A . Subsequently, at t_1 , atom A absorbs the tachyon and drops to the ground state.

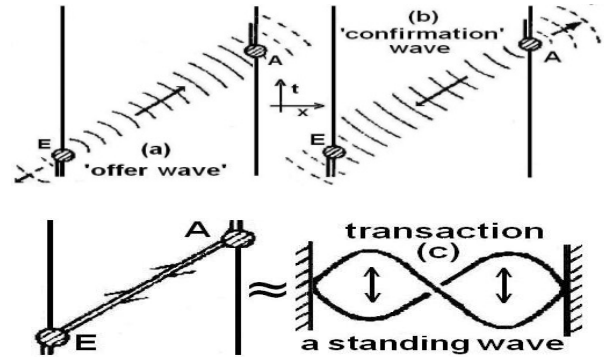

Figure 15. Transactional model. a) Offer-wave, b) confirmation-wave combined into the resultant transaction c) which takes the form of an HD future-past advanced-retarded standing or stationary wave. Figs. Adapted from Cramer [21].

It is clear from this that what is absorption for one observer is spontaneous emission for another. But if quantum mechanics is to remain intact so that we are able to detect such particles, then there must be an observable difference between them: The first depends on a controllable density of tachyons, the second does not. In order to elucidate this point, we should repeat the above experiment many times over. The possibility of reversing the temporal order of causality, sometimes termed 'sending a signal backwards in time' must be addressed [8]. Is this cause-effect statistical in nature? In the case of Bell's Theorem, these correlations are extremely strong whether explained by $v > c$ or $v = c$ signaling.

Bilaniuk, et al formulated the interpretation of the association of negative energy states with tachyonic signaling [8]. From the different frames of reference, thus to one observer absorption is observed and to another emission is observed. These states do not violate special relativity. Acausal experiments in particle physics have been suggested by a number of researchers [8]. Another approach is through the detection of Cerenkov radiation, which is emitted by charged particles moving through a substance traveling at a velocity, $v > c$. For a tachyon traveling in free space with velocity, $v > c$ Cerenkov radiation may occur in a vacuum cause the tachyon to lose energy and become a tardon [8].

In prior joint volumes [7,8] in discussions on the arrow of time we have developed an extended model of a polarized Dirac vacuum in complex form that makes correspondence to both Calabi-Yau mirror symmetry

conditions which extends Cramer's Transactional Interpretation [7] of quantum theory to cosmology. Simplistically Cramer models a transaction as a standing wave of the future-past (offer wave-confirmation wave).

Hierarchical Harmonic Oscillator Parameters	
classical	$X = A \cos(\omega t)$
quantum	$\frac{\hbar^2}{2m} \frac{d^2\psi}{dx^2} + \left(E - \frac{kx^2}{2} \right) \psi = 0$
annihilation creation	$x(t) = x_0 \left[a \exp(-i\omega t) + a^\dagger \exp(i\omega t) \right]$
future-past retarded- advanced	$F_1 = F_0 e^{-ikx} e^{-2\pi i f t}, F_2 = F_0 e^{ikx} e^{-2\pi i f t},$ $F_3 = F_0 e^{-ikx} e^{2\pi i f t}, F_4 = F_0 e^{ikx} e^{2\pi i f t}$
incursive	$\frac{dx(t+\Delta t)}{dt} - v(t) = 0, \frac{dv(t+\Delta t)}{dt} + \omega^2 = 0$

Figure 16. Basic mathematical components of the applied harmonic oscillator: classical, quantum, relativistic, transactional and incursive are required in order to achieve coherent control of the cumulative resonance coupling hierarchy in order to produce harmonic nodes of destructive and constructive interference in the spacetime backcloth.

However in the broader context of the new paradigm of Holographic Anthropic Multiverse (HAM) cosmology it appears theoretically straight forward to 'program the vacuum' The coherent control of a Cramer transaction can be resonantly programmed with alternating nodes of constructive and destructive interference of the standing-wave present. It should be noted that in HAM cosmology the de Broglie-Bohm quantum potential becomes an eternity-wave, \aleph or super pilot wave or force of coherence associated with the unified field ordering the reality of the observer or the locus of the spacetime arrow of time.

To perform a simple experiment to test for the existence of Tachyons and Tardons and atom would be placed in a QED cavity or photonic crystal. Utilizing the resonant hierarchy through interference the reduced eternity wave, \aleph is focused constructively or destructively as the experimental mode may be and according to the parameters illustrated by Feinberg above temporal measurements of emission are taken.

7.2 Velocity of Propagation in Complex 8-Space

In this section we utilize the Cauchy-Riemann relations to formulate the hyperdimensional velocities of propagation in the complex plane in various slices through the hyperdimensional complex 8-space. In this model finite limit velocities, $v > c$ can be considered. In some Lorentz frames of reference, instantaneous signaling can be considered. It is the velocity

connection between remote nonlocal events, and temporal separated events or anticipatory and real time event relations.

It is important to define the complex derivative so that we can define the velocity, $v_{y_{lm}}$. In the xit plane then, we define a velocity of $v = dx / d(it\tau)$. We now examine in some detail the velocity of this expression. In defining the derivative of a complex function we have two cases in terms of a choice in terms of the differential increment considered. Consider the orthogonal coordinates x and it_{lm} ; then we have the generalized function, $f(x, t_{lm}) = f(z)$ for $z = x + it_{lm}$ and $f(z) = u(x, t_{lm}) + iv(x, t_{lm})$ where $u(x, t_{lm})$ and $v(x_{lm}, t_{lm})$ are real functions of the rectangular coordinates x and t_{lm} of a point in space, $P(x, t_{lm})$. Choose a case such as the origin $z_0 = x_0 + it_{0lm}$ and consider two cases, one for real increments $h = \Delta x$ and imaginary increments $h = i\Delta t_{lm}$. For the real increments $h = \Delta t_{lm}$ we form the derivative $f'(z_0) \equiv df(z) / dz_{z_0}$ which is evaluated at z_0 a

$$f' = \lim \Delta x \rightarrow 0 \left\{ \frac{u(x_0 + \Delta x, t_{0lm}) - u(x_0, t_{0lm})}{\Delta x} + i \frac{v(x_0 + \Delta x, t_{0lm}) - v(x_0, t_{0lm})}{\Delta x} \right\} \quad (24a)$$

or

$$f'(z_0) = u_x(x_0, t_{0lm}) + iv_x(x_0, t_{0lm}) \quad \text{for} \quad (24b)$$

$$u_x \equiv \frac{\partial u}{\partial x} \quad \text{and} \quad v_x \equiv \frac{\partial v}{\partial x}.$$

Again $x = x_{Re}$, $x_0 = x_{0Re}$ and $v_x = v_{xRe}$.

Now for the purely imaginary increment, $h = i\Delta t_{lm}$ we have

$$f'(z_0) = \lim \Delta t_{lm} \rightarrow 0 \left\{ \frac{1}{i} \frac{u(x_0, t_{0lm} + \Delta t_{lm}) - u(x_0, t_{0lm})}{\Delta t_{lm}} + \frac{v(x_0, t_{0lm} + \Delta t_{lm}) - v(x_0, t_{0lm})}{\Delta t_{lm}} \right\} \quad (25a)$$

and

$$f'(z_0) = -iu_{t_{lm}}(x_0, t_{0lm}) + v_{t_{lm}}(x_0, t_{0lm}) \quad (25b)$$

for $u_{t_{lm}} = u_{t_{lm}}$ and $v_{t_{lm}} = v_{t_{lm}}$ then

$$u_{t_{lm}} \equiv \frac{\partial u}{\partial t_{lm}} \quad \text{and} \quad v_{t_{lm}} \equiv \frac{\partial v}{\partial t_{lm}}. \quad (25c)$$

Using the Cauchy-Riemann equations

$$\frac{\partial u}{\partial x} = \frac{\partial v}{\partial t_{\text{Im}}} \quad \text{and} \quad \frac{\partial u}{\partial t_{\text{Im}}} = -\frac{\partial v}{\partial x} \quad (26)$$

and assuming all principle derivations are definable on the manifold and letting $h = \Delta x + i\Delta t_{\text{Im}}$ we can use

$$f'(z_0) = \lim_{h \rightarrow 0} \frac{f(z_0 + h) - f(z_0)}{h} = \left. \frac{df(z)}{dz} \right|_{z_0} \quad (27a)$$

and

$$u_x(x_0, t_{0\text{Im}}) + i v_x(x_0, t_{0\text{Im}}) = \frac{\partial u(x_0, t_{0\text{Im}})}{\partial x} + i \frac{\partial v(x_0, t_{0\text{Im}})}{\partial x} \quad (27b)$$

with v_x for x and t_{Re} that is $u_{\text{Re}} = u_{x_{\text{Re}}}$, with the derivative form of the charge of the real space increment with complex time, we can define a complex velocity as,

$$f'(z_0) = \frac{dx}{d(it_{\text{Im}})} = \frac{1}{i} \frac{dx}{dt_{\text{Im}}} \quad (28a)$$

we can have $x(t_{\text{Im}})$ where x_{Re} is a function of t_{Im} and $f(z)$ and using $h = i\Delta t_{\text{Im}}$, then

$$f'(z_0) = x'(t_{\text{Im}}) = \frac{dx}{dh} = \frac{dx}{idt_{\text{Im}}}. \quad (28b)$$

Then we can define a velocity where the differential increment is in terms of $h = i\Delta t_{\text{Im}}$. Using the first case as $u(x_0, t_{0\text{Im}})$ and obtaining $dt_{0\text{Im}} / \Delta x$ (with i 's) we take the inverse. If u_x which is v_x in the $h \rightarrow i\Delta t_{\text{Im}}$ case have both u_x and v_x , one can be zero. Like the complex 8D space, the 5D Kaluza-Klein geometries are subsets of the supersymmetry models. The complex 8-space deals in extended dimensions, but like the TOE models, Kaluza-Klein models also treat $n > 4D$ as compactified on the scale of the Planck length, 10^{-33} cm [8].

In 4D space event point, P_1 and P_2 are spatially separated on the real space axis as $x_{0\text{Re}}$ at point P_1 and $x_{1\text{Re}}$ at point P_2 with separation $\Delta x_{\text{Re}} = x_{1\text{Re}} - x_{0\text{Re}}$. From the event point P_3 on the t_{Im} axis we move in complex space from event P_1 to event P_3 . From the origin, $t_{0\text{Im}}$ we move to an imaginary temporal separation of $t_{1\text{Im}}$ to $t_{2\text{Im}}$ of $\Delta t_{\text{Im}} = t_{2\text{Im}} - t_{0\text{Im}}$. The distance in real space and imaginary time can be set so that measurement along the t_{Im} axis yields an imaginary temporal separation Δt_{Im} subtracts out, from the spacetime metric, the temporal separation Δx_{Re} . In this case occurrence of events P_1 and P_2 can occur

simultaneous, that is, the apparent velocity of propagation is instantaneous.

For the example of Bell's Theorem, the two photons leave a source nearly simultaneously at time, $t_{0\text{Re}}$ and their spin states are correlated at two real spatially separated locations, $x_{1\text{Re}}$ and $x_{2\text{Re}}$ separated by $\Delta x_{\text{Re}} = x_{2\text{Re}} - x_{1\text{Re}}$. This separation is a space-like separation, which is forbidden by special relativity; however, in complex space, the points $x_{1\text{Re}}$ and $x_{2\text{Re}}$ appear to be contiguous for the proper path 'travelled' to the point.

7.3 Possible New Consequences of the Model

Since such models evidently imply new testable properties of electromagnetic and gravitational phenomena we shall conclude this work with a brief discussion of the points where it differs from the usual interpretations and implies new possible experimental tests.

If one considers gravitational and electromagnetic phenomena as reflecting different behaviors of the same real physical field i.e. as different collective behavior, propagating within a real medium (the aether) [23-26] one must start with a description of some of its properties.

We thus assume that this aether is built (i.e. describable) by a chaotic distribution $\rho(x_\mu)$ of small extended structures represented by four-vectors $A_\mu(x_\alpha)$ round each absolute point in I_0 . This implies

- the existence of a basic local high density of extended sub-elements in vacuum
- the existence of small density variations $\delta\rho(x_\mu) A_\alpha(x_\mu)$ above $\delta\rho > 0$ for light and below ($\delta\rho < 0$) for gravity density at x_μ .
- the possibility to propagate such field variations within the vacuum as first suggested by Dirac [25].

One can have internal variations: i.e. motions within these sub-elements characterized by internal motions associated with the internal behavior of average points (i.e. internal center of mass, centers of charge, internal rotations: and external motions associated with the stochastic behavior, within the aether, of individual sub-elements. As well known the latter can be analyzed at each point in terms of average drift and osmotic motions and A_μ distribution. It implies the introduction of non-linear terms.

To describe individual non-dispersive sub-elements within I_0 , where the scalar density is locally constant and the average A_μ equal to zero, one introduces at its central point $Y_\mu(\theta)$ a space-like radial four-vector

$A_\mu = r_\mu \exp(iS/\hbar)$ (with $r_\mu r^\mu = a^2 = \text{constant}$) which rotates around Y_μ with a frequency $\nu = m_\gamma c^2 / h$. At both extremities of a diameter we shall locate two opposite electric charges e^+ and e^- (so that the sub-element behaves like a dipole). The opposite charges attract and rotate around Y_μ with a velocity $\cong c$. The $+e$ and $-e$ electromagnetic pointlike charges correspond to opposite rotations (i.e. $\pm \hbar/2$) and A_μ rotates around an axis perpendicular to A_μ located at Y_μ , and parallel to the individual sub-element's four momentum $\partial_\mu S$.

Assuming electric charge distributions correspond to $\delta m > 0$ and gravitation to $\delta m < 0$ one can describe such sub-elements as holes ($\delta m < 0$) around a point 0 around which rotate two point-like charges rotating in opposite directions as shown in Figure 6.1 below.

These charges themselves rotate with a velocity c at a distance $r_\mu = A_\mu$ (with $r_\mu r^\mu = \text{Const.}$). From 0 one can describe this by the equation

$$\square A_\mu - \frac{m_\gamma^2 c^2}{\hbar^2} \cdot A_\mu = \frac{[\square(A_\alpha^* A_\alpha)]^{1/2}}{(A_\alpha^* A_\alpha)^{1/2}} \cdot A_\mu \quad (29)$$

with $A_\mu = r_\mu \cdot \exp[iS(x_\alpha)/\hbar]$ along with the orbit equations for e^+ and e^- we get the force equation

$$m \cdot \omega^2 \cdot r = e^2 / 4\pi r^2 \quad (30)$$

and the angular momentum equation:

$$m_\gamma \cdot r^2 \cdot \omega = \hbar / 2 \quad (31)$$

Eliminating the mass term between (31) and (33) this yields

$$\hbar \omega = e^2 / 2r \quad (32)$$

where $e^2/2r$ is the electrostatic energy of the rotating pair. We then introduce a soliton-type solution

$$A_\mu^0 = \frac{\sin \cdot K \cdot r}{K \cdot r} \cdot \exp[i(\cot - K_0 x)] \quad (33)$$

where

$$K = mc/\hbar, \quad \omega = mc^2/\hbar \quad \text{and} \quad K_0 = mv/\hbar \quad (34)$$

satisfies the relation (31) with

$$r = ((x-vt)^2 \cdot (1-v^2/c^2)^{-1} + y^2 + z^2)^{1/2} \quad \text{i.e.}$$

$$\square A_\mu^0 = 0 : \quad (35)$$

so that one can add to A_μ^0 a linear wave, A_μ (satisfying $\square A_\mu = (m_\gamma^2 c^2 / \hbar^2) A_\mu$) which describes the new average paths of the extended wave elements and piloted solitons. Within this model the question of the interactions of a moving body (considered as excess or defect of field density, above or below the aether's neighboring average density) with a real aether appears immediately. According to Newton massive bodies move in the vacuum with constant directional velocities, i.e. no directional acceleration, without any apparent relative friction or drag term. This is not true for accelerated forces (the equality of inertial and gravitational masses are a mystery) and apparent absolute motions proposed by Newton were later contested by Mach.

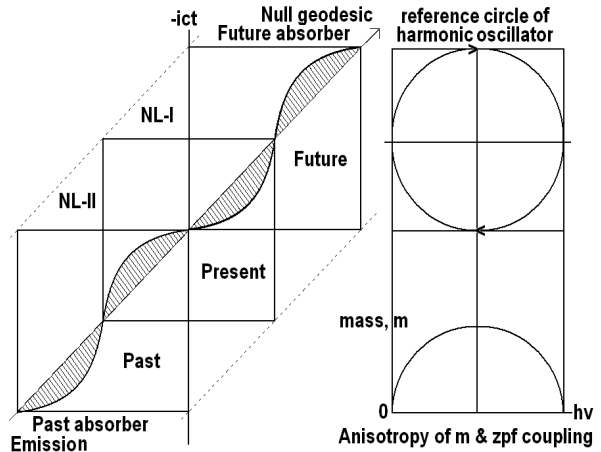

Figure 17. a) 2D drawing of a 3D view of a 4D hyperstructure. A Minkowski spacetime diagram of the electric vector only in terms of a present moment of 'tiled' Planck units utilizing the Wheeler-Feynman theory of radiation. The vertices represent absorption & emission. The observable present is represented by bold lines, and nonlocal components by standard line. Each event is a hyperstructure of Past, Present, and Future interactions, ultimately governed by the quantum potential. b) In the reference circle photon mass and energy fluctuate harmonically during propagation of the wave envelope (wave) and internal rotation of the ZPF during coupling (particle).

As well known, as time went by, observations established the existence of unexplained behavior of light and some new astronomical phenomena which led to discovery of the Theory of Relativity.

In this work we shall follow a different line of interpretation and assume that if one considers particles, and fields, as perturbations within a real medium filling flat space time, then the observed deviations of Newton's law reflect the interactions of the associated perturbations (i.e. observed particles and fields) with the perturbed average background medium in flat space-time. In other terms we shall present the argument (already presented by Ghosh et al. [8]) that

the small deviations of Newton's laws reflect all known consequences of General Relativity.

The result from real causal interactions between the perturbed local background aether and its apparently independent moving collective perturbations imply absolute total local momentum and angular momentum conservation resulting from the preceding description of vacuum elements as extended rigid structures.

Retarded:

$$F_1 = F_0 e^{-ikx} e^{-2\pi ift}, \quad F_2 = F_0 e^{ikx} e^{-2\pi ift} \quad (36a)$$

Advanced:

$$F_3 = F_0 e^{-ikx} e^{2\pi ift}, \quad F_4 = F_0 e^{ikx} e^{2\pi ift} \quad (36b)$$

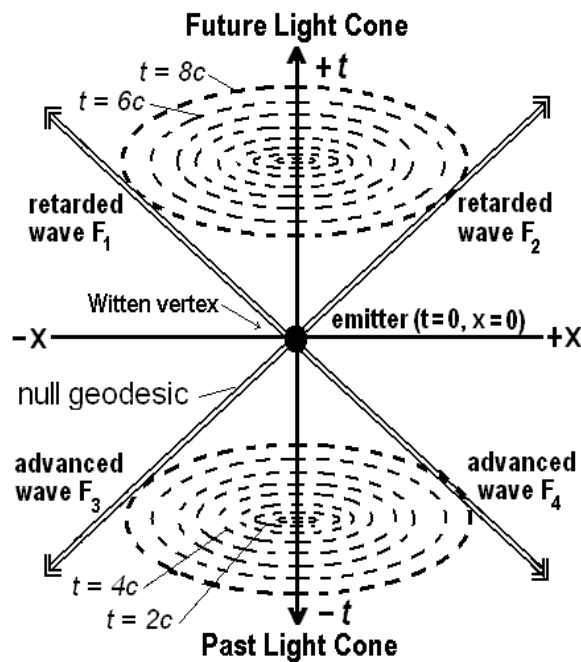

Figure 18. 4D Minkowski light-cone of advanced and retarded waves (Eq. 1) emitted from a locus at $(x,t) = (0,0)$. Adapted from concepts of Cramer [21].

As part of the symmetry breaking process the continuous-state spin-exchange compactification dynamics of the vacuum hyperstructure is shown to give rise naturally to a $2.735^\circ K$ degree Hawking type radiation from the topology of Planck scale (albeit a whole new consideration of how the Planck regime operates) micro-black hole hypersurfaces. All prior considerations of 'tired-light mechanisms have been considered from the perspective of 4D Minkowski space. This new process arises from a richer *open* (non-compactified) Kaluza-Klein dimensional structure of a continuous-state cosmology in an M-Theory context with duality-mirror symmetry; also supporting the complex standing-wave postulate of the model.

or to a lower state $E_k (< E_{iL})$ (CMBR-emission) according to the relation

$$h\nu = E_j - E_{iL} = E_{iH} - E_k.$$

Thus we postulate that boundary conditions inherent in continuous standing-wave spacetime spin exchange cavity compactification dynamics of vacuum topology also satisfy the requirements for photon emission. In metaphorical terms, periodic phases or modes in the continuous spacetime transformation occur where *future-past exciplex states* act as *torque moments* of CMBR/Redshift BB emission/absorption equilibrium. An exciplex (a form of excimer- short for excited dimer), usually chemistry nomenclature, used to describe an excited, transient, combined state, of two different atomic species (like XeCl) that dissociate back into the constituent atoms rather than reversion to a ground state after photon emission.

An excimer is defined as a short-lived dimeric or heterodimeric molecule formed from two species, at least one of which is in an electronic excited state. Excimers are often diatomic and are formed between two atoms or molecules that would not bond if both were in the ground state. The lifetime of an excimer is very short, on the order of nanoseconds. Binding of a larger number of excited atoms form Rydberg matter clusters the lifetime of which can exceed many seconds.

An Exciplex is an electronically excited complex of definite stoichiometry, 'non-bonding' in the ground state. For example, a complex formed by the interaction of an excited molecular entity with a ground state counterpart of a different structure. When it emits photon emitted Quasiparticle soliton.

In reviewing atomic theory Bohm states:

Inside an atom, in a state of definite energy, the wave function is large only in a *toroidal region* surrounding the radius predicted by the Bohr orbit for that energy level. Of course the toroid is not sharply bounded, but ψ reaches maximum in this region and rapidly becomes negligible outside it. The next Bohr orbit would appear the same but would have a larger radius confining ψ and propagated with wave vector $k = \rho / h$ with the probability of finding a particle at a given region proportional to $|\psi|^2 = |f(x, y, z)|^2$. Since f is uniform in value over the toroid it is highly probable to find the particle where the Bohr orbit says it should be [44].

8. Experimental Design and Procedure

Some experimental evidence has been found to support this view showing the possibility that the interaction of these extended structures in space involve real physical vacuum couplings by resonance with the subquantum Dirac ether. Because of photon mass the CSI model, any causal description implies that for photons carrying energy and momentum one must add to the restoring force of the harmonic oscillator an additional radiation (decelerating) resistance derived from the em (force) field of the emitted photon by the action-equal-reaction law. Kowalski showed that emission and absorption between atomic states take place within a time interval equal to one period of the emitted or absorbed photon wave.

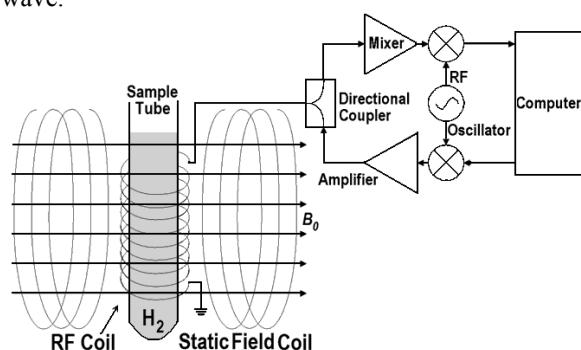

Figure 19. NMR apparatus designed to manipulate TBS in Hydrogen. The Fig. only shows possible details for rf-modulating TBS QED resonance, not the spectrographic recording and analysis components.

The corresponding transition time corresponds to the time required to travel one full orbit around the nucleus. Individual photons are extended spacetime structures containing two opposite point-like charges rotating at a velocity near c , at the opposite sides of a rotating diameter with a mass, $m = 10^{-65}$ g and with an internal oscillation $E = m^2 = hv$. Thus a new causal description implies the addition of a new component to the Coulomb force acting randomly and may be related to quantum fluctuations. We believe this new relationship has some significance for our model of vacuum C-QED blackbody absorption/emission equilibrium.

The purpose of this simple experiment is to empirically demonstrate the existence of LSXD utilizing a new model of TBS in the hydrogen atom until now hidden behind the veil of the uncertainty principle. If for the sake of illustration we arbitrarily assume the s orbital of a hydrogen atom has a volume of 10 and the p orbital a volume of 20, to discover TBS we will investigate the possibility of heretofore unknown volume possibilities arising from cyclical fluctuations in large XD Calabi-Yau mirror symmetry dynamics. This is in addition to the Vigier TBS model.

As in the perspective of rows of seats in an auditorium, rows of trees in an orchard or rows of headstones in a cemetery, from certain positions the line of sight is open to infinity or block. This is the assumption we make about the continuous-state cyclicity of HD space. Then if the theory has a basis in physical reality and we are able to measure it propose that at certain nodes in the cycle we would discover cavity volumes of say 12, 14, and 16. We propose the possibility of three XD cavity modes like 'phase locked loops' depending the cycle position - maximal, intermediate and minimal. Perfect rolling motion

9. TBS Testing

The 'couple-punch' is done in conjunction with a 'couple-suck' in certain spin-spin coupling modes of the putative TBS of the Hydrogen atom as postulated for an HD Calab-Yau mirror symmetric cavity and for LSXD. In the Vigier internal motion we mentioned briefly Kowalski's Lorentz transform and in the Tachyon paper [43] further utility of Kowalski's model.

TABLE I

KICK	PULL	P + K	K + P
R	R	R + A	R + A
A	A	A + R	A + R
R + A	R + A	A = R	
A + R	A + R		
A = R	A = R		

Table I. Possible TBS experimental Kick-Pull (K - P) coupling mode parameters. R signifies a retarded K or K coupling, A respectively of advanced K coupling. The plus (+) sign signifies sequential order and the equals sign (=) means simultaneous action for a total of 15 experimental KP coupling options.

HAM cosmology suggests that there is an Feynman synchronization backbone with an inherent beat frequency in the spacetime backcloth of empty space. If we trap a hydrogen atom in a specific continuous-state CQED mode we may manipulate it with an rf-pulsed resonance hierarchy in the context of Kowalski's Lorentz transform according to the regimen in Table 1.

References

- [1] Dragic', A. Maric', Z. Vigier, J-P (2000) New quantum mechanical tight bound states and 'cold fusion' experiments, Physics Letters A: 265;163-167.
- [2] Vigier, J-P (1993) New Hydrogen (Deuterium) Bohr Orbits, Proceedings ICCF4, Hawaii, Vol 4, p. 7.
- [3] Bhabha, H. J., & Corben, H. C. (1941) General classical theory of spinning particles in a Maxwell field, Proceedings

- of the Royal Society of London Series A: Mathematical, Physical & Engineering Sciences, 178:974, 273-314.
- [4] Barut, A.O. (1980) *Surv. High Energy Phys.* 1, 113.
- [5] Rowlands, P. (2013) Space and antispacetime, in R.L. Amoroso, P. Rowlands & L.H. Kauffman (eds.) *Physics of Reality: Space, Time, Matter, Cosmos*, London: World Sci.
- [6] Rowlands, P. (2007) *Zero to infinity: the foundations of physics*, Singapore: World Scientific.
- [7] Amoroso, R. L. & Rauscher, E.A. (2009) *The Holographic Anthropic Multiverse: Formalizing the Ultimate Geometry of Reality*, Singapore: World Scientific.
- [8] Rauscher, E.A. & Amoroso, R. L. (2011) *Orbiting the Moons of Pluto: Complex Solutions to the Einstein, Maxwell, Schrödinger, and Dirac Equations*, Singapore: World Scientific.
- [9] Amoroso, R. L. (2010) (ed.) *Complementarity of mind and body: Realizing the dream of Descartes, Einstein and Eccles*, New York: Nova Science Publishers.
- [10] Amoroso, R. L. (2014) *Through the Looking Glass: Discovery of the Mind*, Hackensack: World Scientific.
- [11] Amoroso, R. L. (2012) Physical parameters of mind-body interaction: breaking the 1st person 3rd person barrier, *J Nonlocality*, 1,1, <http://journals.sfu.ca/jnonlocality/index.php/jnonlocality/article/view/5>
- [12] Amoroso, R. L., Kauffman, L.H., Rowlands, P. & Rauscher, E.A. *Introduction to Unified Field Mechanics*, in process.
- [13] Amoroso, R. L. (2003) Awareness: physical cosmology of the fundamental least unit, *Noetic Journal*, 4(1), 7-23.
- [14] Amoroso, R. L., Kauffman, L.H. & Giandinoto, S. (2013) *Universal Quantum Computing; 3rd Gen Prototyping Utilizing Relativistic 'Trivector' R-Qubit Modeling Surmounting Uncertainty*, in R.L. Amoroso, P. Rowlands & L.H. Kauffman (eds.) *The Physics of Reality: Space, Time, Matter, Cosmos*: Singapore: World Scientific.
- [15] Luminet, J-P, Weeks, J. R., Riazuelo, A., Lehoucq, R., & Uzan, J. P. (2003) Dodecahedral space topology as an explanation for weak wide-angle temperature correlations in the cosmic microwave background, *Nature*, 425:6958, 593.
- [16] Luminet, J-P (2005) A cosmic hall of mirrors, arXiv preprint physics/0509171.
- [17] Luminet, J-P (2008) *The Wraparound Universe*, Wellesley: AK Peters.
- [18] Stewart, I. (2001) *Flatterland: like Flatland only more so*, Basic Books.
- [19] Martins, C. J. A. P., Melchiorri, A., Rocha, G., Trotta, R., Avelino, P. P., & Viana, P.T.P. (2004) WMAP constraints on varying α and the promise of reionization. *Physics Letters B*, 585:1, 29-34.
- [20] Bull, P., & Kamionkowski, M. (2013). What if Planck's Universe isn't flat?. arXiv preprint arXiv:1302.1617.
- [21] Lehnert, J. L., & Steinhardt, P. J. (2013) Planck 2013 results support the simplest cyclic models. arXiv preprint arXiv:1304.3122.
- [22] Holland, P. R. (1995). *The quantum theory of motion: an account of the de Broglie-Bohm causal interpretation of quantum mechanics*. Cambridge university press.
- [23] Hainzl, C., Lewin, M., & Séré, É. (2005) Existence of a stable polarized vacuum in the Bogoliubov-Dirac-Fock approximation., *Communications in mathematical physics*, 257:3, 515-562.
- [24] Amoroso, R.L., Kauffman, L.H., Rauscher, E.A., Rowlands, P., & Vigier, J-P (2010) "Hidden" Parameters Describing Internal Motion Within Extended Particle Elements, in AIP Conference Proceedings, 1316, p. 1.
- [25] Dirac, P.A.M. (1952) *Nature (London)* 169, 702.
- [26] Petroni, N.C & Vigier, J-P (1983) Dirac's aether in relativistic quantum mechanics, *Foundations of Physics*, 13:2; 253-285.
- [27] de Broglie, L. (1960) *Non-linear wave mechanics: A causal interpretation*. Elsevier Pub. Co..
- [28] Bohm, D. J., & Hiley, B. J. (1982) The de Broglie pilot wave theory and the further development of new insights arising out of it, *Foundations of Physics*, 12:10, 1001-1016.
- [29] Amoroso, R. L., Kafatos, M., & Ecmimovic, P. (1998) The origin of cosmological redshift in spin exchange between Planck scale vacuum compactification and nonzero rest mass photon anisotropy, in *Causality and Locality in Modern Physics*, Dordrecht: Kluwer.
- [30] Vigier, J. P. (1997) New non-zero photon mass interpretation of the Sagnac effect as direct experimental justification of the Langevin paradox, *Physics Letters A*, 234:2, 75-85.
- [31] Kowalski, M. (1999) Photon Emission from Atomic Hydrogen, *Physics Essays*, Vol.12, 312-331.
- [32] Kowalski, M. (2003) The process of photon emission from atomic hydrogen, in Amoroso, R. L., Hunter, G., Kafatos, M., & Vigier, J. P. (eds.) *Gravitation and cosmology: From the Hubble radius to the Planck scale*, Vol. 126, New York: Springer, 207-222.
- [33] Amoroso, R. L., & Vigier, J-P (2003) The origin of CMBR as intrinsic blackbody cavity-QED resonance inherent in the dynamics of the continuous state topology of the Dirac vacuum, in *Gravitation and Cosmology: From the Hubble Radius to the Planck Scale*, Dordrecht: Kluwer. 27-38.
- [34] Lehnert, B. & Roy, S. (1998) *Extended Electromagnetic Theory*, Singapore: World Scientific.
- [35] Lehnert, B. (2002) Photon wave and particle concepts of an extended electromagnetic theory, *Phys. Scripta*, 66:2, 105.
- [36] Lehnert, B. (1994) Basic concepts of an extended electromagnetic field theory, *Speculations in Science and Technology-Complete Edition*, 17:4, 259-266.
- [37] Barcelo, C., Visser, M., & Liberati, S. (2001) Einstein gravity as an emergent phenomenon?. *International Journal of Modern Physics D*, 10:06, 799-806.
- [38] <http://www.evl.uic.edu/hypercomplex/html/dirac.html>.
- [39] Rydberg states: sensitive probes of molecular structure, *Chemical Physics Letters Volume 378, Issues 5-6, 12, 2003, Pages 647-653*, Narayanan Kuthirummal, Peter M Weber.
- [40] Cowan, R.D. (1981) *The Theory of Atomic Structure and Spectra*, Berkeley: Univ. of CA Press.
- [41] Baer, M., Lin, S. H., Alijah, A., Adhikari, S., & Billing, G. D. (2000) Extended approximated Born-Oppenheimer equation. I. Theory, *Physical Review A*, 62(3), 032506.
- [42] M. Born and J. R. Oppenheimer, *Ann. Phys. (Leipzig)* 84, 457 (1927).
- [43] Amoroso, R.L. & Rauscher, E.A. (2010) Empirical Protocol for Measuring Virtual Tachyon/Tardon Interactions in a Dirac Vacuum, in AIP Conf. Proceed. 1316, p. 199.
- [44] Bohm, D. (1951) *Quantum theory*, New York: Dover.