

# Quantum Gravity and Electro Magnetic forces in FFF-theory.

Leo Vuyk,  
Architect,  
Rotterdam, the Netherlands.  
[LeoVuyk@Gmail.com](mailto:LeoVuyk@Gmail.com)

## Abstract,

Quantum FFF theory states, that the vacuum is seeded with fast oscillating massless Higgs particles, oscillating along a complex chiral tetrahedral vacuum lattice, which has the ability to transfer Photon and Graviton information in bunches of oscillations, through the vacuum lattice with the local speed of light. As a consequence there are no attraction forces on propeller shaped Fermions. Only the sum of the different kinds of vacuum impulses from all directions on Fermions are responsible for all energetic phenomena in the universe.

## Introduction.

According to Le Sage gravity the vacuum is seeded with fast travelling corpuscles, impinging on mass carrying particles present inside massive bodies. The deflection of these vacuum particles after the impulse on the first body, should lead to a decline in vacuum pressure on a second object, tending to drive two bodies together.

However, we suggest, that the vacuum is seeded with fast oscillating energetic but massless Higgs particles, oscillating along a complex chiral tetrahedral vacuum lattice, which has the ability to transfer Photon and Graviton information in bunches of oscillations, through the vacuum lattice with the local speed of light.

As a consequence there are no attraction forces on the propeller shaped spinning Fermions. Only the sum of the different kinds of vacuum impulses from all directions on Fermions coined: “**Double Vector Hedgehogs**”, are responsible for all energetic phenomena in the universe.

Thus we could give such a gravity model the name: “**Double Le Sage gravity**”.

Fermions are assumed to be fast spinning 3 Dimensional propeller shaped strings, able to deform impinging Higgs particles into 5 different shaped 3-Dimensional Photon/Gluon particles and Gravitons. (Figure 1,2 and Ref. 3,4).

**In contrast with the contemporary “standard model”**, we count two Gluon/Photons (coded: LOL+ROR) for the electric quantum force, two Gluon/Photons (LOU+ROU) for the magnetic quantum force and one Gluon/Photon (UOU) as general particle for the x-ray, gamma ray and different light frequencies.

The 5 different shaped Gluon particles (Ref.3,4) are in contrast with Gravitons, supposed to be able to merge with Fermions into more complex compound Fermion particles (Quarks, including Muons and Tau Fermions). However if no Fermions are hit, then after a very short (Planck) distance the Gluon information is picked up and transferred as 5 different coded Photon information or as a Graviton encoded information, by the Higgs system simultaneous along different Lattice routes in the form of a bunch of entangled Higgs oscillations. (figure: 3) This is our proposal for the explanation of the so called particle-wave duality.

The bunch of Higgs oscillations can impinge somewhere on a new Fermion and then the Photonic bunched wave function will COLLAPSE and change back into one Gluon particle, able to merge with the Fermion and originate measurable atomic change.

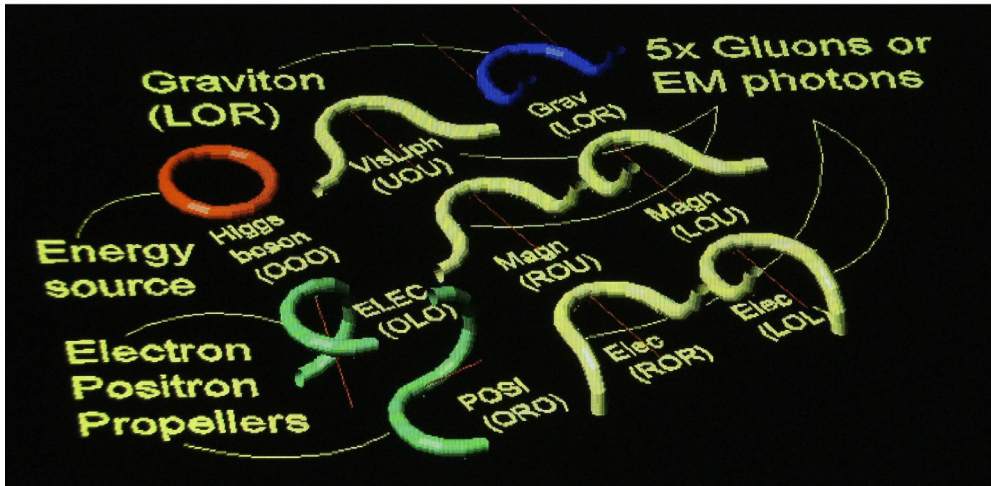
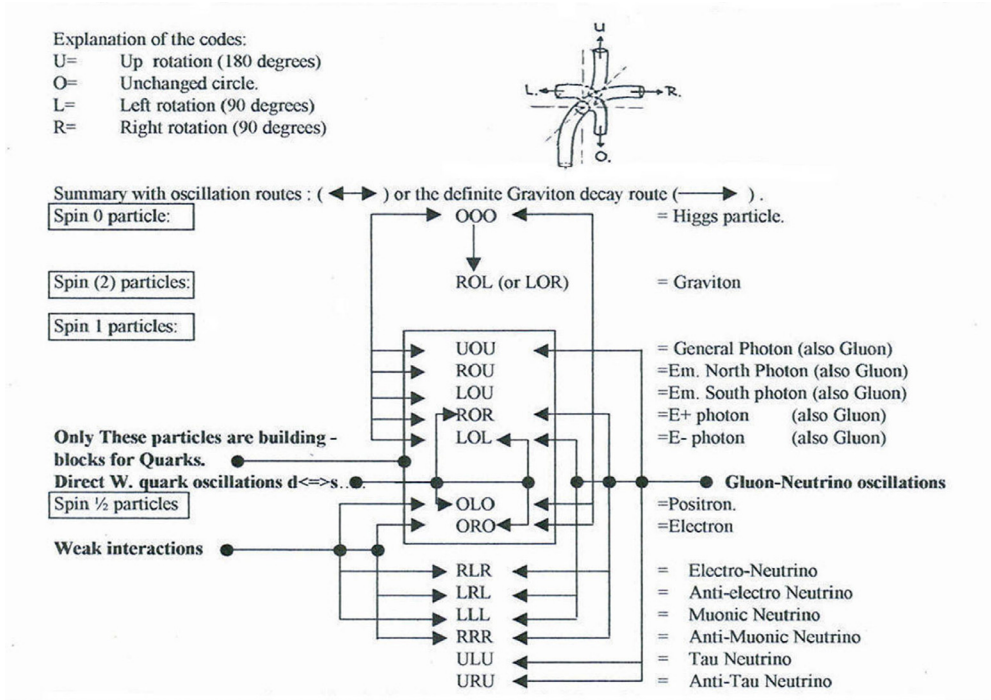

Figure 1, 3-Dimensional String Based Alternative Particle Model. (Ref. 3)

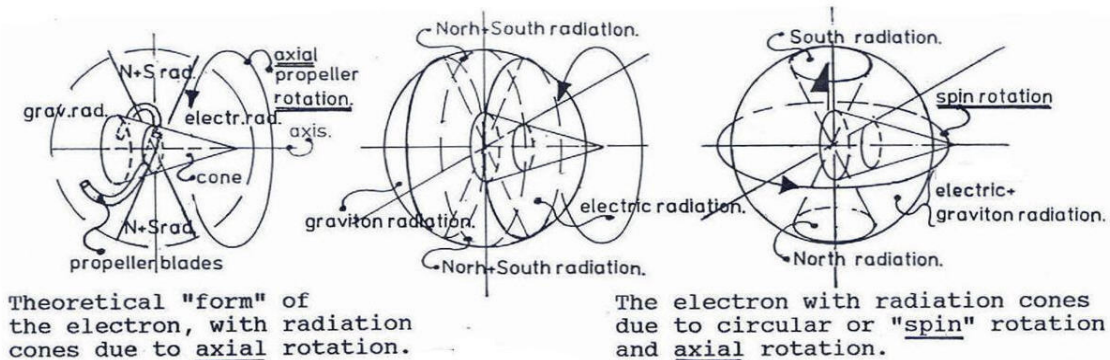
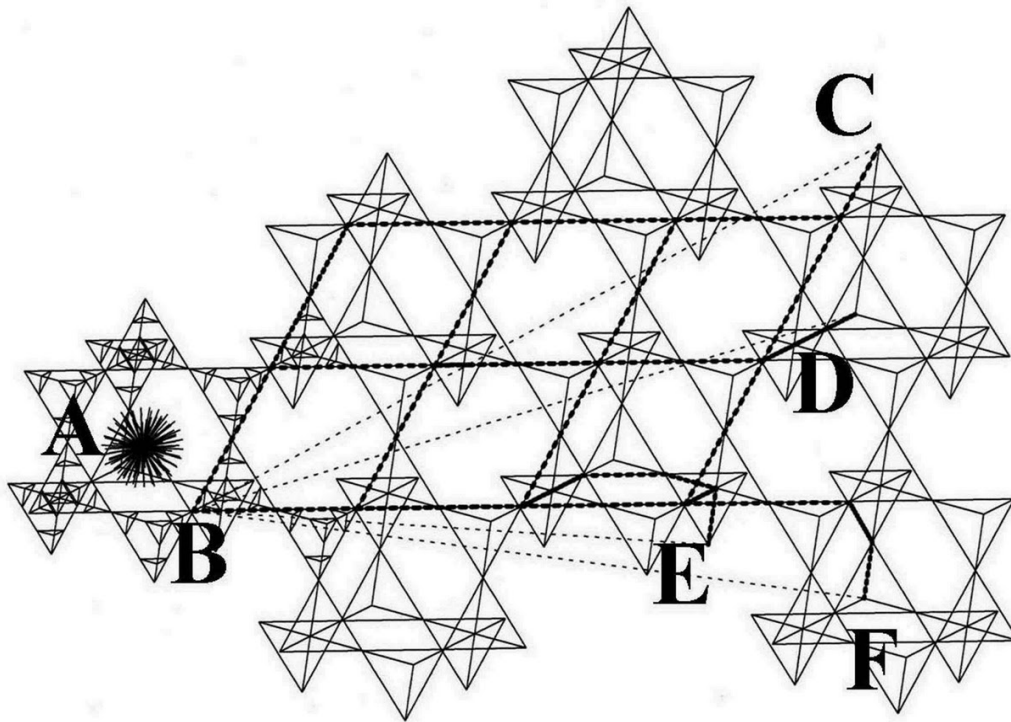

Figure 2, Double axial spin of Fermions with monopole Gluon- Graviton radiation cones. (Ref.3) After a short distance the 5 string shaped Gluons (2 Electric, 2 Magnetic and one general) can merge with Fermions into compound Quarks, or become a photonic wave, just like the Graviton.



**Photon trajectories through the tetrahedral Chiral vacuum lattice.**

A photon is created as a deformed Higgs particle at position (A), thus as a single (Photon/Gluon) particle which after some distance changes form back into a Higgs particle (B).

The photon energy is transferred into the oscillating Higgs system and travelling through the vacuum lattice in the form of a BUNCH of entangled energetic Higgs oscillations with the local speed of light.

(To match the single photon double slit experiment)

After collision with a second Fermion, at locations C,D,E,F. the BUNCH of energy collapses and change the FORM of a local Higgs particle into the shape of the original Photon.

Five different shaped Gluons after some distance are called Photons.

Thus five different shaped Photons start their journey as Gluon. Author: Leo Vuyk.

**Figure 3,** Photon (bunch shaped) trajectories, through the Higgs vacuum lattice. (Ref. 4)

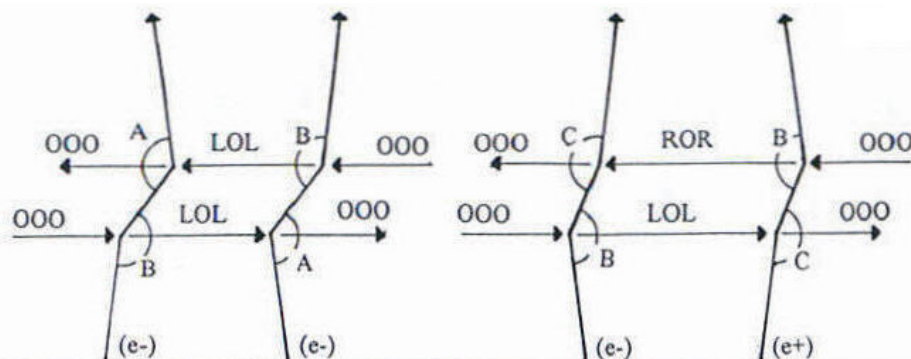

**Figure 4,** The principle of electric field force transfer by two monopole electric Photons (LOL and ROR) pushing Fermions with different impulses between two equal charged Fermions and different charged Fermions. The impulse of the Higgs particles is supposed to play an important role in combination with the monopole Photons to deflect the Fermions out of their trajectory.

A comparable system is supposed to be active for Gravitons. (Figure 5)

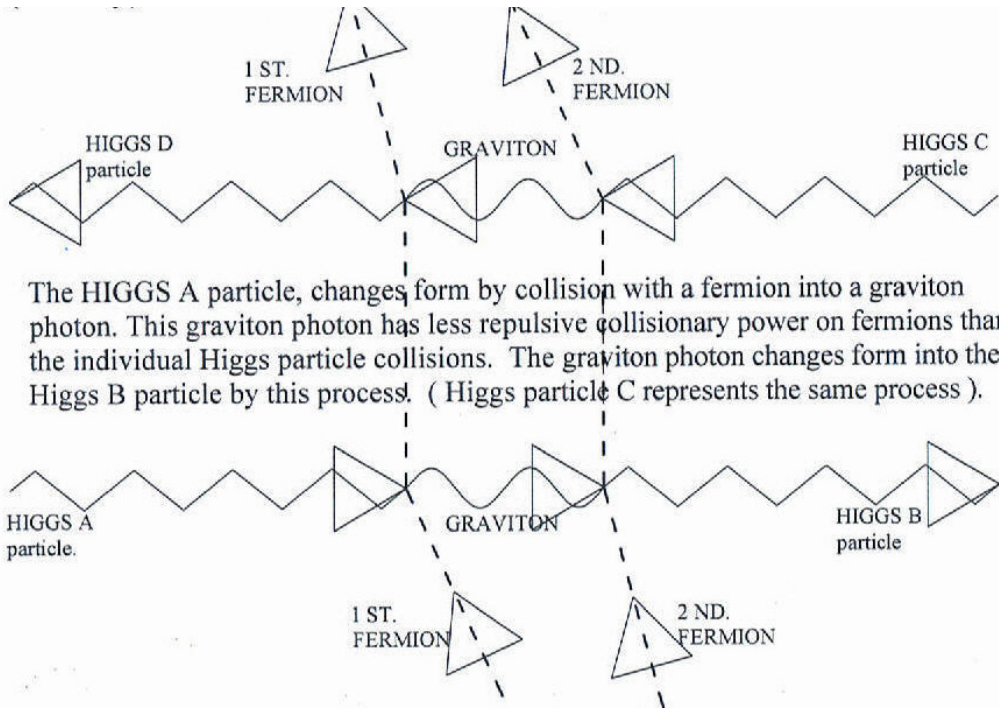

**Figure 5,** The principle of the Double Le Sage gravity force transfer between two Fermions.

The impulse of the Higgs particles is supposed to be larger than the Graviton Impulse.

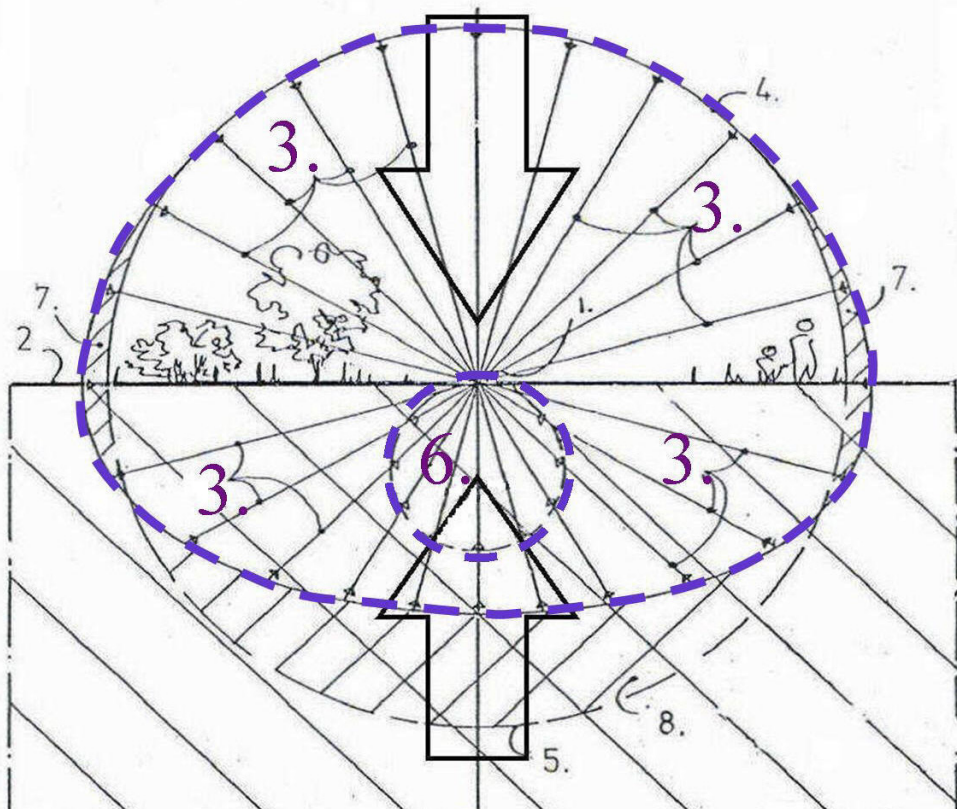

**Figure 6,** Cross section of the “Double Vector Hedgehog” of pushing forces around Fermions. The difference between Higgs vacuum pressure (3) and less effective Graviton pressure (6) on Fermions are the basic elements of Double Le Sage gravity.

Higgs/Graviton pressure vector hedgehogs acting on a mass carrying Quantum particle. The irregular distribution of mass inside the earth is supposed to influence the 3D pressure vector hedgehog according to the new Double LeSage gravity paradigm, see image below.

Author Leo Vuyk.

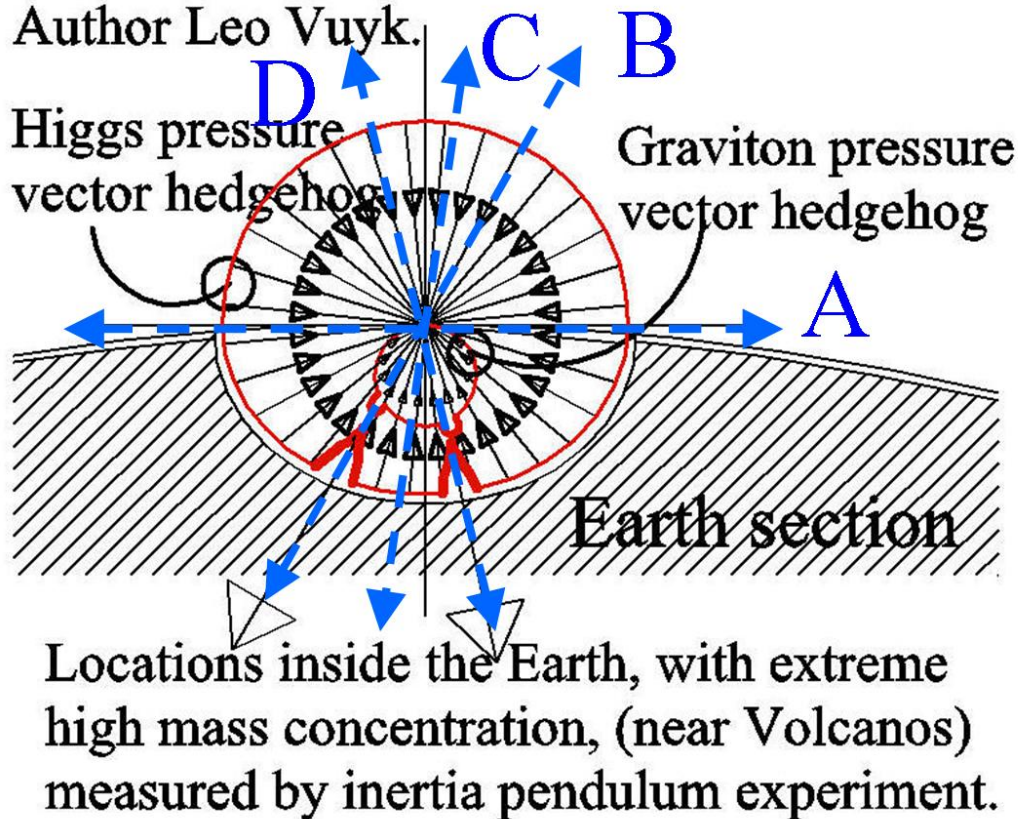

**Figure 7,**  
 The “Double Vector Hedgehog” related to mass concentrations in the earth.  
 Oscillation directions: A,B,C and D will give larger damping differences as expected by Newtonian gravity rules, if we use a new Inertia oscillator device, presented in figure (8).

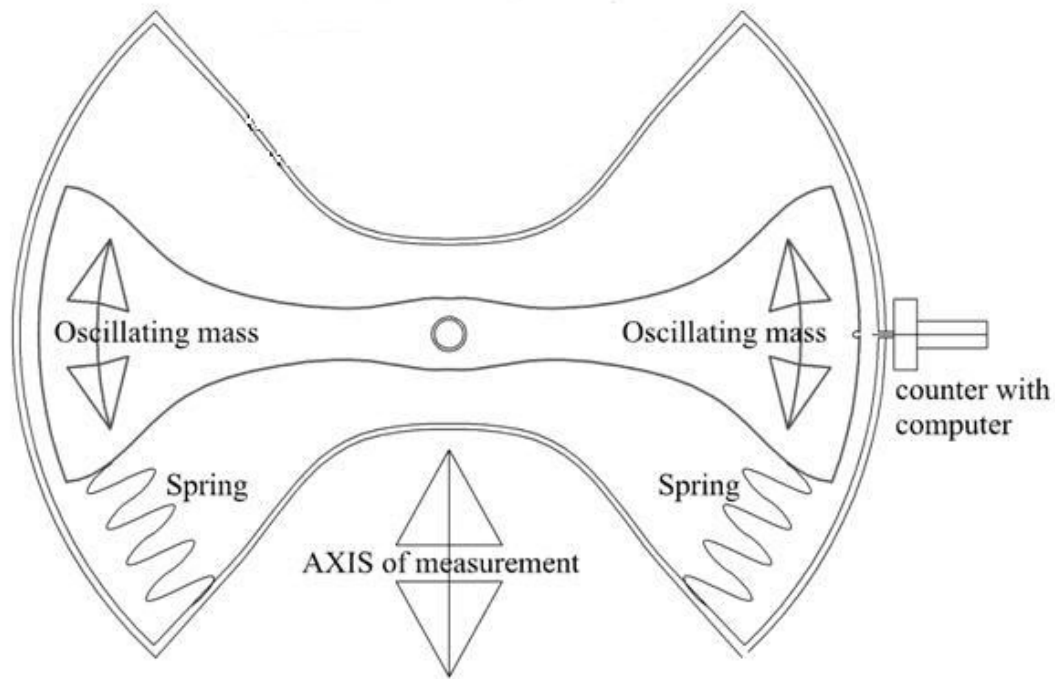

**Figure 8**, Cross section through the inertia oscillator for the search of mass concentrations inside the near earth and as a test for double Le Sage gravity.

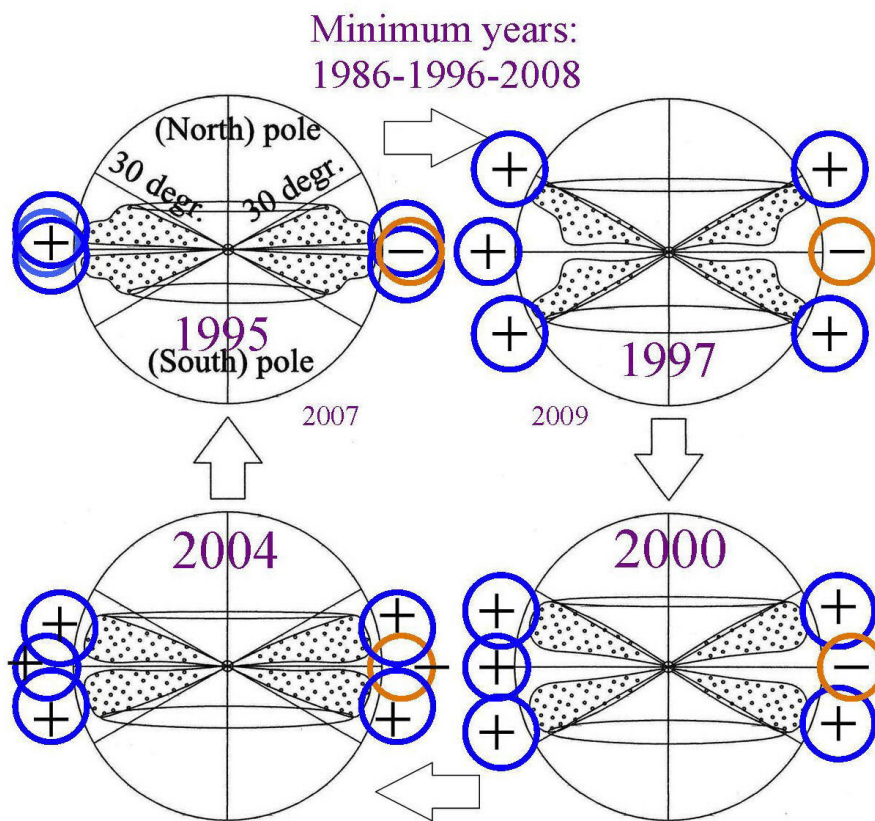

**Figure 9**, Cross section through the sun with the sunspot (micro black hole) distribution in two mirror symmetrical double cones, changing shape with the 11 year sunspot cycle. The gravity influence of the double cones together with the solar rotation (blue and yellow ring area) is supposed to be the origin of Solar eclipse gravity variation of the measurements.

Well documented solar eclipse gravity variation measurements are made by different scientists in the past years. After years of measurement, it seems to be impossible to find a scientific base for the different results.

However if we assume that Sunspots are micro black holes, **(Ref. 2)** able to drag and influence the Higgs vacuum pressure distribution around the sun, then we may have a clue.

We assume that the sunspot distribution has a double cone shape inside the sun, as depicted in figure 9.

### ALTERNATIVE MAGNETIC FIELD INTERPRETATION.

If magnetic field lines have a quantum mechanical origin, based on alternative magnetic monopole photons (with a North or South characteristic and a slight "photonic trajectory CURL") then the picture below could represent the origin of a "Magnetic vector potential (A)" around an electric current e.g. in a wire.

This magnetic CURL is supposed to have the same origin as assumed for the DIFFRACTION process (of light): "Settlement" of photonic information routing inside the local microscopic Higgs vacuum lattice.

It is assumed that the photonic CURL in the photonic vector field will change due to wire bending.

The Curl will be able to decrease down to zero curl, at the outside turn of a bended wire, (e.g. see position: a) If this is the case, the magnetic field (called the B field) will vanish completely around a long small solenoid. Inside a wire bending however, the Curl will consequently increase.

Conclusion, the proposed two force carriers (photons: North and South) are able to explain the peculiar qualities of the so called Magnetic Vector Potential field (A). (Author L.Vuyk)

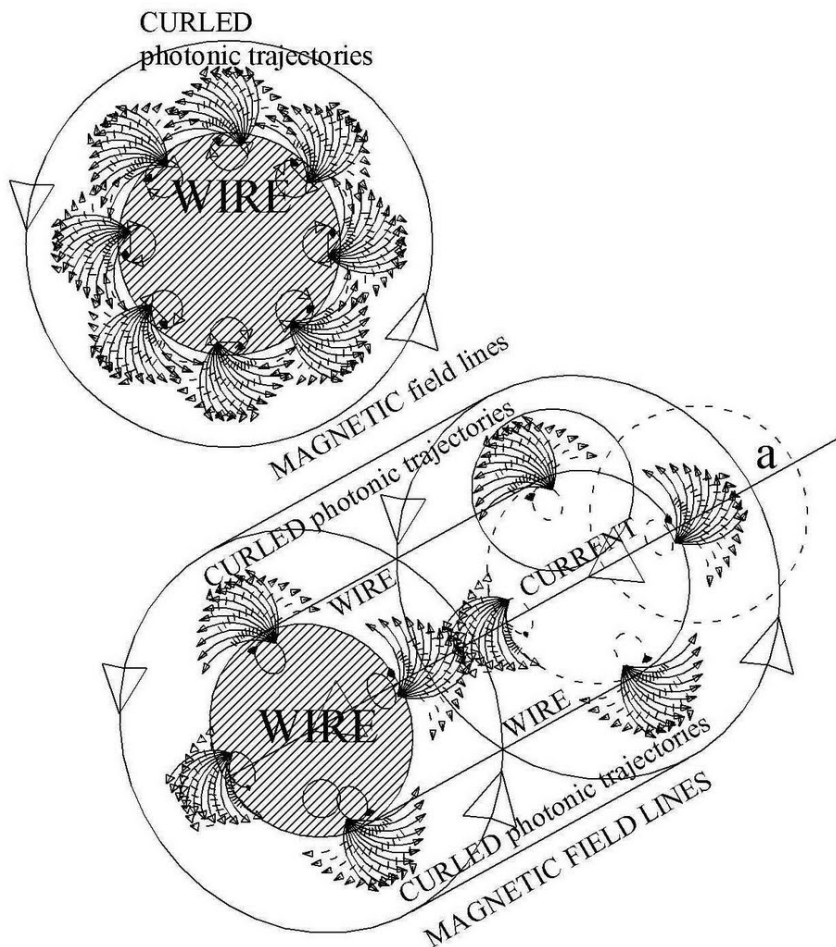
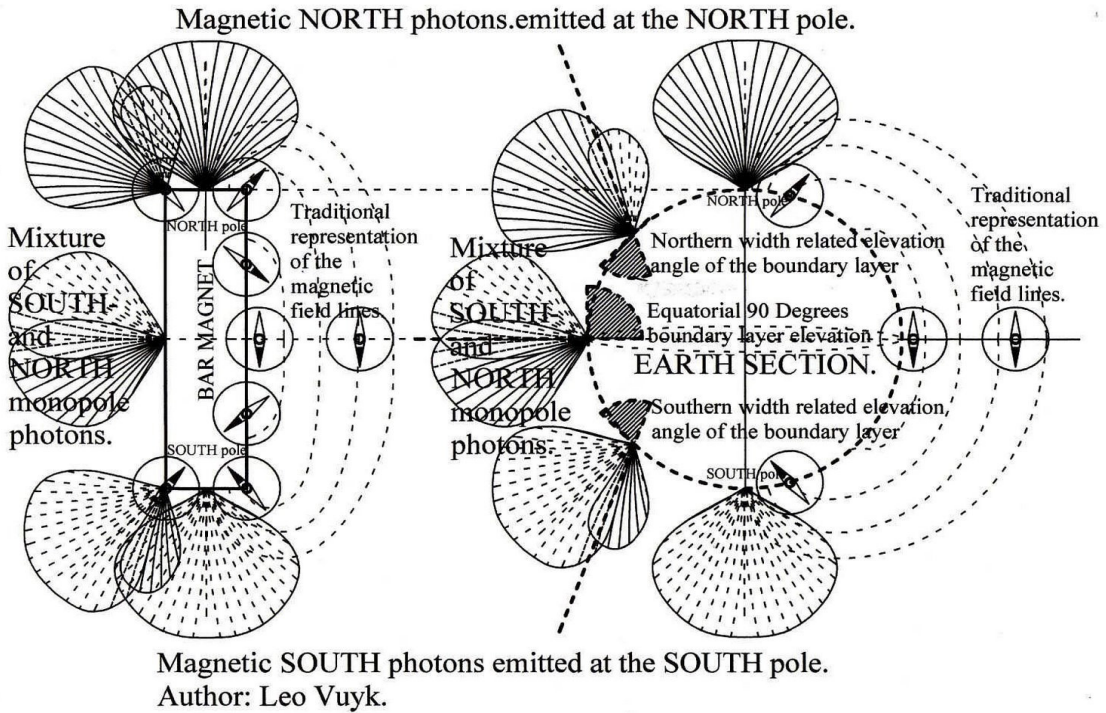

Figure 10, Alternative magnetic field by "curled Photonic monopole information" around an electric wire under current.

**ALTERNATIVE magnetic field interpretation based on two different magnetic photons ( N and S) with boundary layer elevation indication.**

If magnetic field lines have a quantum mechanical origin, based on alternative magnetic monopole photons (with a North or South characteristic and a slight "CURL") then the picture below represents the differences with the traditional view.



**Figure 11,**

Alternative magnetic field interpretation , based on two different magnetic Photon/Gluons ( North and South) with different boundary Layer elevation indications.

The 5 Gluons ( Fig.1) are supposed to be the same as Photons however with different appearances.

Gluons are supposed to be real 3-Dimensional strings, able to “click-on” to Fermions and form Quarks.

Photons are supposed to come only in wave form, as monopole information bunches travelling with the local speed of light along the mass-less oscillating Higgs vacuum lattice.

The are transformed Gluons



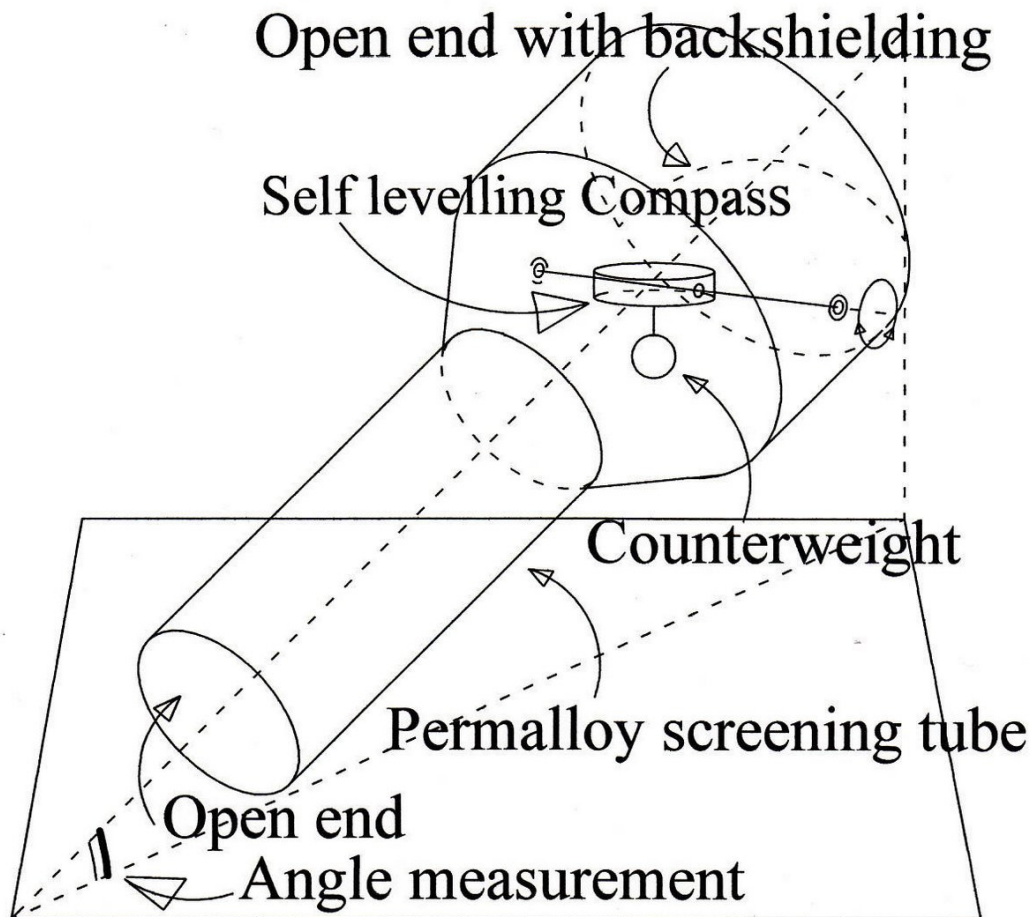
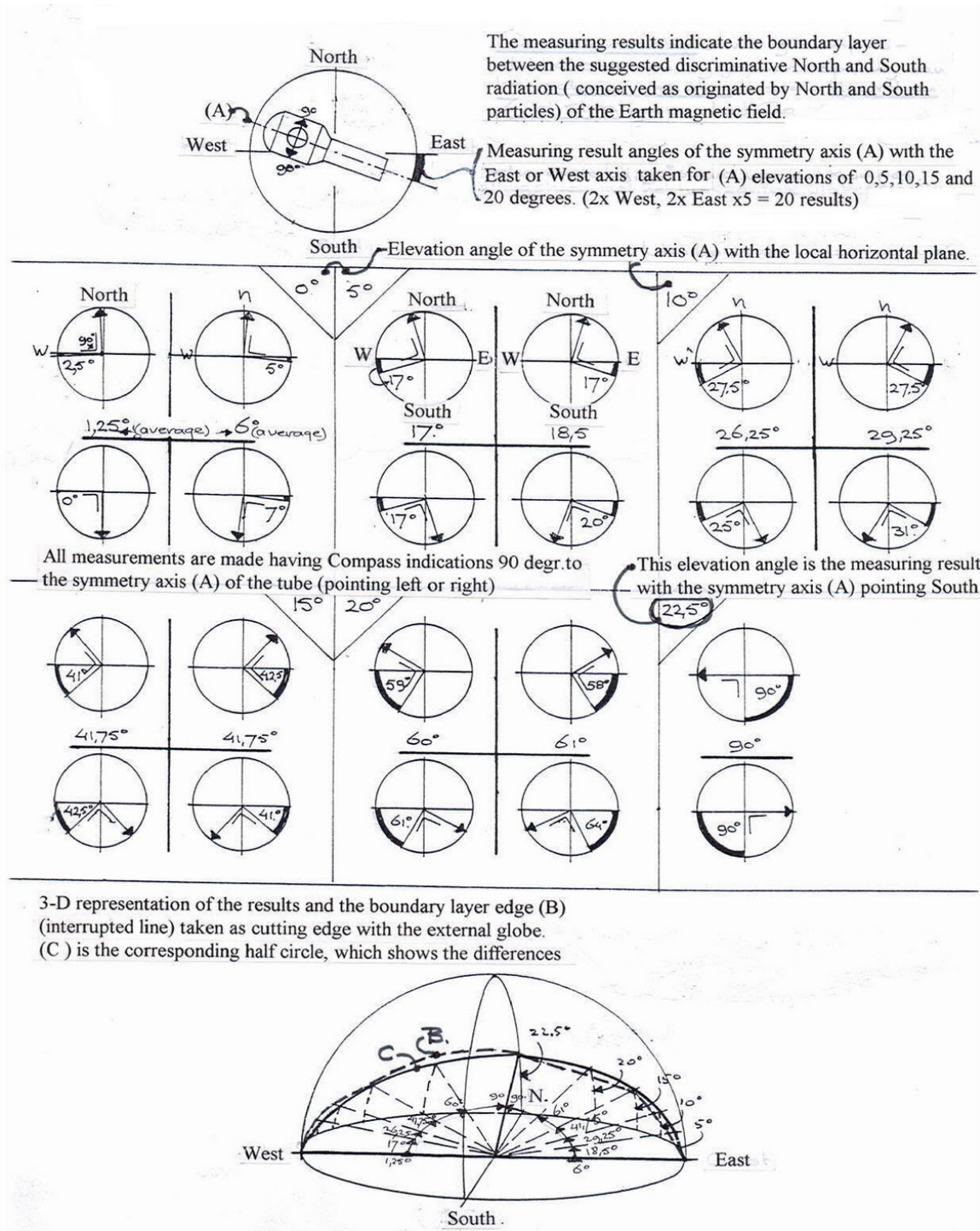

**Figure 12,**

3-Dimensional representation of the magnetic monopole telescope, able to show differences in the monopole Photon trajectories (with North or South characteristic) around the earth.

The screening tube with back shielding, is made of permalloy or mu-metal. The compass is a simple hobby compass balancing on copper bolts.

Angle measurement is done, only if the compass needle points into a heading perpendicular to the axial symmetry axis of the tube. See the result on figure 13.



**Figure 13,**  
3-Dimensional representation of the “boundary layer” B, between the North and South monopole radiation of the earth, is the result of multiple measurements by the magnetic telescope at location, Latitude: 52,18 degr. North and Longitude degr. 5,2 East.(see: figure 12).

It is assumed that every location on earth has its individual **boundary layer Curve B.**

It is also assumed that **animals like Pigeons and sea Turtles are able to identify these specific curves (B) for different locations by the small amount of permalloy alike metals already found in their bodies, to explain the extraordinary qualities of animal orientation.**

## References:

[1] [viXra:1103.0015](#) submitted on 5 Mar 2011

**Wavefunction Collapse and Human Choice-Making Inside an Entangled Mirror Symmetrical Multiverse.**

Authors: Leo Vuyk.

Category: [High Energy Particle Physics](#)

[2] [viXra:1103.0011](#) submitted on 3 Mar 2011

**An Alternative Black Hole, Provided with Entropy Decrease and Plasma Creation.**

Authors: Leo Vuyk

Category: [High Energy Particle Physics](#)

[3] [viXra:1103.0002](#) submitted on 1 Mar 2011

**3-Dimensional String Based Alternative Particle Model.**

Authors: Leo Vuyk.

Category: [High Energy Particle Physics](#)

[4] [viXra:1102.0052](#) 27 Feb 2011

**Construction Principles for Chiral "atoms of Spacetime Geometry".**

Authors: Leo Vuyk

Category: [Quantum Physics](#)

[5] [viXra:1102.0054](#) 27 Feb 2011

**Atomic Nuclear Geometry Based on Magic Number Logic.**

Authors: Leo Vuyk.

Category: [Nuclear and Atomic Physics](#)

[6] [viXra:1102.0056](#) 28 Feb 2011

**Experiments to Determine the Mass Related Lightspeed Extinction Volume Around the Earth and Around Spinning Objects in the Lab.**

Authors: Leo Vuyk.

Category: [Relativity and Cosmology](#)

[7] **The New God Particle and Free Will.**

By Leo Vuyk, LuLu publishers, 2008.

ISBN number 978-1-4092-1031-3