

LINFAN MAO

COMBINATORIAL GEOMETRY

WITH APPLICATIONS TO FIELD THEORY

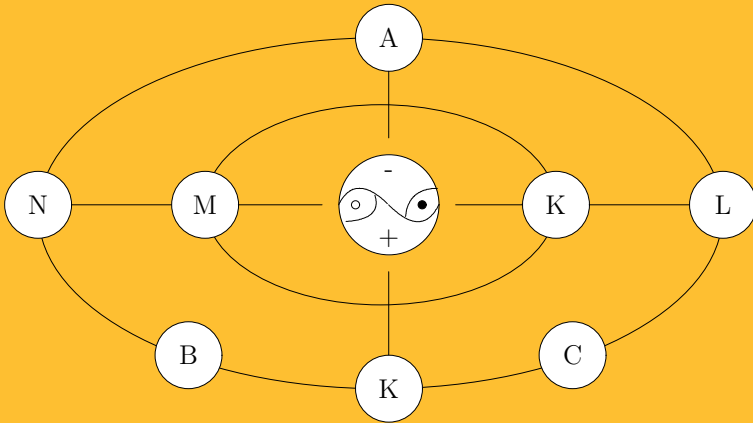

InfoQuest

2009

Linfan MAO

Academy of Mathematics and Systems
Chinese Academy of Sciences
Beijing 100080, P.R.China
Email: maolinfan@163.com

Combinatorial Geometry
with Applications to Field Theory

InfoQuest

2009

This book can be ordered in a paper bound reprint from:

Books on Demand

ProQuest Information & Learning
(University of Microfilm International)
300 N.Zeeb Road
P.O.Box 1346, Ann Arbor
MI 48106-1346, USA
Tel:1-800-521-0600(Customer Service)
<http://wwwlib.umi.com/bod>

Peer Reviewers:

F.Tian, Academy of Mathematics and Systems, Chinese Academy of Sciences, Beijing 100080, P.R.China.

J.Y.Yan, Graduate Student College, Chinese Academy of Sciences, Beijing 100083, P.R.China.

R.X.Hao, Department of Applied Mathematics, Beijing Jiaotong University, Beijing 100044, P.R.China.

W.L.He, Department of Applied Mathematics, Beijing Jiaotong University, Beijing 100044, P.R.China.

Copyright 2009 by InfoQuest and Linfan Mao

Many books can be downloaded from the following **Digital Library of Science**:

<http://www.gallup.unm.edu/~smarandache/eBooks-otherformats.htm>

ISBN: 978-1-59973-100-1

Printed in America

Preface

Anyone maybe once heard the proverb of the six blind men with an elephant, in which these blind men were asked to determine what an elephant looks like by touch different parts of the elephant's body. The man touched its leg, tail, trunk, ear, belly or tusk claims that the elephant is like a pillar, a rope, a tree branch, a hand fan, a wall or a solid pipe, respectively. Each of them insisted his view right. They entered into an endless argument. *All of you are right!* A wise man explains to them: *why are you telling it differently is because each one of you touched the different part of the elephant. So, actually the elephant has all those features what you all said.*

After read this meaningful proverb, we should ask ourself two questions:

What is its implication in philosophy?

What is its meaning for understanding of the WORLD?

One interesting implication of this proverb is that *an elephant is nothing but a union of those claims of the six blind men, i.e., a Smarandache multi-space underlying a combinatorial structures.* The situation for one realizing behaviors of the WORLD is analogous to the blind men determining what an elephant looks like. The multi-laterality of the WORLD implies that human beings can only determine lateral feature of the WORLD by our technology, and the WORLD should be a Smarandache multi-space underlying a combinatorial structure in theory.

In *The 2nd Conference on Combinatorics and Graph Theory of China* (Aug. 16-19, 2006, Tianjing), I formally presented a combinatorial conjecture (CC) on mathematical sciences, i.e., *a mathematical science can be reconstructed from or made by combinatorialization.* This conjecture is essentially a philosophic notion for developing mathematical sciences. It is this notion that motivates me to research

mathematics and physics by combinatorics, i.e., *mathematical combinatorics* beginning in 2004 when I was a post-doctor of Chinese Academy of Mathematics and System Science. Now, it finally bring about this self-contained book -*Combinatorial Geometry with Applications to Field Theory*, includes combinatorics with graphs, algebraic combinatorics, differential Smarandache manifolds, combinatorial differential geometry, quantum fields with dynamics, combinatorial fields with applications, and so on.

Contents in this book are outlined following.

Chapters 1 and 2 are the fundamental of this book. In Chapter 1, we briefly introduce combinatorics with graphs, such as those of Boolean algebra, multi-sets, partially ordered or countable sets, graphs and combinatorial enumeration, which are useful in following chapters.

Chapter 2 is the fundamental of mathematical combinatorics, also an application of combinatorial notion to mathematical systems, i.e., combinatorial systems, particularly algebraic systems. These groups, rings and modules were generalized to a combinatorial one. We also consider actions of multi-groups on finite sets, which extends a few well-known results in classical permutation groups.

Chapter 3 is a survey of Smarandache geometries. For introducing differential Smarandache manifolds, we first present topological spaces with fundamental groups, covering space and simplicial homology group, Euclidean spaces, differential forms in \mathbf{R}^n and the Stokes theorem on simplicial complexes. Then we discuss Smarandache geometries, map geometries and pseudo-Euclidean spaces. By introducing differential structure on Smarandache manifolds, we discuss Smarandache manifold, principal fiber bundles and geometrical inclusions in differential Smarandache geometries.

Chapters 4 – 6 are on combinatorial manifolds motivated by the combinatorial notion on topological or smooth manifolds. In Chapter 4, we discuss topological behaviors of combinatorial manifolds with characteristics, such as Euclidean spaces and their combinatorial characteristics, topology on combinatorial manifolds, vertex-edge labeled graphs, Euler-Poincaré characteristic, fundamental groups, singular homology groups on combinatorial manifolds and regular covering of combinatorial manifold by voltage assignment. Some well-known results in topology, for example, the Mayer-Vietoris theorem on singular homology groups can be found in this

chapter.

Chapters 5 and 6 form the main parts of combinatorial differential geometry, which provides the fundamental for applying it to physics and other sciences. Chapter 5 discuss tangent and cotangent vector space, tensor fields and exterior differentiation on combinatorial manifolds, connections and curvatures on tensors or combinatorial Riemannian manifolds, integrations and the generalization of Stokes' and Gauss' theorem, and so on. Chapter 6 contains three parts. The first concentrates on combinatorial submanifold of smooth combinatorial manifolds with fundamental equations. The second generalizes topological groups to multiple one, for example Lie multi-groups. The third is a combinatorial generalization of principal fiber bundled to combinatorial manifolds by voltage assignment technique, which provides the mathematical fundamental for discussing combinatorial gauge fields in Chapter 8.

Chapters 7 and 8 introduce the applications of combinatorial manifolds to fields. For this objective, variational principle, Lagrange equations and Euler-Lagrange equations in mechanical fields, Einstein's general relativity with gravitational field, Maxwell field and Abelian or Yang-Mills gauge fields are introduced in Chapter 7. Applying combinatorial geometry discussed in Chapters 4 – 6, we then generalize fields to combinatorial fields under the *projective principle*, i.e., *a physics law in a combinatorial field is invariant under a projection on its a field* in Chapter 8. Then, we show how to determine equations of combinatorial fields by Lagrange density, to solve equations of combinatorial gravitational fields and how to construct combinatorial gauge basis and fields, ...

This book was began to write in October, 2006. Many colleagues and friends of mine have given me enthusiastic support and endless helps in preparing this book. Without their help, this book will never appears today. Here I must mention some of them. On the first, I would like to give my sincerely thanks to Dr.Perze for his encourage and endless help. Without his encourage and suggestion, I would do some else works, can not investigate mathematical combinatorics for years and finish this book. Second, I would like to thank Professors Feng Tian, Yanpei Liu, Mingyao Xu, Jiyi Yan, Wenpeng Zhang and Fuji Zhang for them interested in my research works. Their encourage and warmhearted support advance this book. Thanks are also given to Professors Xiaodong Hu, Yanxun Chang, Han Ren, Yanqiu Huang,

Junliang Cai, Rongxia Hao, Wenguang Zai, Goudong Liu, Weili He and Erling Wei for their kindly helps and often discussing problems in mathematics altogether. Partially research results of mine were reported at Chinese Academy of Mathematics & System Sciences, Beijing Jiaotong University, East-China Normal University and Hunan Normal University in past years. Some of them were also reported at *The 2nd* and *3rd Conference on Combinatorics and Graph Theory of China* in 2006 and 2008, *The 3rd* and *4th International Conference on Number Theory and Smarandache's Problems of Northwest of China* in 2007 and 2008. My sincerely thanks are also give to these audiences discussing mathematical topics with me in these periods.

Of course, I am responsible for the correctness all of these materials presented here. Any suggestions for improving this book and solutions for open problems in this book are welcome.

L.F.Mao
AMSS, Beijing
July, 2009

Contents

Preface	i
Chapter 1. Combinatorics with Graphs	1
§1.1 Sets with operations	2
1.1.1 Set	2
1.1.2 Operations	3
1.1.3 Boolean algebra	5
1.1.4 Multi-set	9
§1.2 Partially ordered sets	12
1.2.1 Partially ordered set	12
1.2.2 Multi-poset	14
§1.3 Countable sets	16
1.3.1 Mapping	16
1.3.2 Countable set	18
§1.4 Graphs	19
1.4.1 Graph	19
1.4.2 Subgraph	22
1.4.3 Labeled graph	23
1.4.4 Graph families	23
1.4.5 Operations on graphs	25
§1.5 Enumeration	27

1.5.1	Enumeration principle	27
1.5.2	Inclusion-exclusion principle.....	27
1.5.3	Enumerating mappings.....	29
1.5.4	Enumerating labeled graphs.....	31
§1.6	Remarks.....	35
Chapter 2. Fundamental of Mathematical Combinatorics		38
§2.1	Combinatorial systems	39
2.1.1	Proposition in lgic	39
2.1.2	Mathematical system	41
2.1.3	Combinatorial system.....	43
§2.2	Algebraic systems.....	46
2.2.1	Algebraic system.....	46
2.2.2	Associative and commutative law	46
2.2.3	Group.....	48
2.2.4	Isomorphism of Systems	49
2.2.5	Homomorphism theorem.....	49
§2.3	Multi-operation systems	53
2.3.1	Multi-operation systems.....	53
2.3.2	Isomorphism of multi-systems.....	54
2.3.3	Distribute law	57
2.3.4	Multi-group and multi-ring.....	58
2.3.5	Multi-ideal.....	60
§2.4	Multi-modules	61
2.4.1	Multi-module	61
2.4.2	Finite dimensional multi-module	64
§2.5	Action of multi-groups	67
2.5.1	Construction of permutation multi-group.....	67
2.5.2	Action of multi-group.....	70

§2.6	Combinatorial algebraic systems	78
2.6.1	Algebraic multi-system	78
2.6.2	Diagram of multi-system	80
2.6.3	Cayley diagram	85
§2.7	Remarks	86
Chapter 3. Smarandache manifolds		88
§3.1	Topological spaces	89
3.1.1	Topological space	89
3.1.2	Metric space	92
3.1.3	Fundamental group	94
3.1.4	Covering space	99
3.1.5	Simplicial homology group	103
3.1.6	Topological manifold	108
§3.2	Euclidean geometry	111
3.2.1	Euclidean space	111
3.2.2	Linear mapping	115
3.2.3	Differential calculus on \mathbf{R}^n	118
3.2.4	Differential form	121
3.2.5	Stokes' theorem on simplicial complex	123
§3.3	Smarandache manifolds	126
3.3.1	Smarandache geometry	126
3.3.2	Map geometry	128
3.3.3	Pseudo-Euclidean space	133
3.3.4	Smarandache manifold	138
§3.4	Differential Smarandache manifolds	140
3.4.1	Differential manifold	140
3.4.2	Differential Smarandache manifold	141
3.4.3	Tangent space on Smarandache manifold	141

§3.5	Pseudo-manifold geometry	145
§3.6	Remarks	150
Chapter 4.	Combinatorial Manifolds	154
§4.1	Combinatorial space	155
4.1.1	Combinatorial Euclidean space	155
4.1.2	Combinatorial fan-space	166
4.1.3	Decomposition space into combinatorial one	169
§4.2	Combinatorial manifolds	172
4.2.1	Combinatorial manifold	172
4.2.2	Combinatorial submanifold	178
4.2.3	Combinatorial equivalence	181
4.2.4	Homotopy class	183
4.2.5	Euler-Poincaré characteristic	185
§4.3	Fundamental groups of combinatorial manifolds	187
4.3.1	Retraction	187
4.3.2	Fundamental d -group	189
4.3.3	Homotopy equivalence	195
§4.4	Homology groups of combinatorial manifolds	196
4.4.1	Singular homology group	196
4.4.2	Relative homology group	200
4.4.3	Exact chain	201
4.4.5	Homology group of combinatorial manifold	207
§4.5	Regular covering of combinatorial manifolds by voltage assignment	208
4.5.1	Action of fundamental group on covering space	208
4.5.2	Regular covering of labeled graph	209
4.5.3	Lifting automorphism of voltage labeled graph	212
4.5.4	Regular covering of combinatorial manifold	215
§4.6	Remarks	219

Chapter 5. Combinatorial Differential Geometry	222
§5.1 Differentiable combinatorial manifolds	223
5.1.1 Smoothly combinatorial manifold	223
5.1.2 Tangent vector space	226
5.1.3 Cotangent vector space	230
§5.2 Tensor fields on combinatorial manifolds	231
5.2.1 Tensor on combinatorial manifold	231
5.2.2 Tensor field on combinatorial manifold	232
5.2.3 Exterior differentiation	235
§5.3 Connections on tensors	238
5.3.1 Connection on tensor	238
5.3.2 Torsion-free tensor	241
5.3.3 Combinatorial Riemannian manifold	241
§5.4 Curvatures on connection spaces	243
5.4.1 Combinatorial curvature operator	243
5.4.2 Curvature tensor on combinatorial manifold	247
5.4.3 Structural equation	249
5.4.4 Local form of curvature tensor	250
§5.5 Curvatures on Riemannian manifolds	252
5.5.1 Combinatorial Riemannian curvature tensor	252
5.5.2 Structural equation in Riemannian manifold	255
5.5.3 Local form of Riemannian curvature tensor	256
§5.6 Integration on combinatorial manifolds	257
5.6.1 Determining $\mathcal{H}(n, m)$	257
5.6.2 Partition of unity	259
5.6.3 Integration on combinatorial manifold	261
§5.7 Combinatorial Stokes' and Gauss' theorem	266
5.7.1 Combinatorial Stokes' theorem	266

5.7.2	Combinatorial Gauss' theorem	271
§5.8	Combinatorial Finsler geometry	276
5.8.1	Combinatorial Minkowskian norm	276
5.8.2	Combinatorial Finsler geometry	276
5.8.3	Geometrical inclusion	277
§5.9	Remarks	278
Chapter 6. Combinatorial Riemannian Submanifolds		
with Principal Fiber Bundles		
		282
§6.1	Combinatorial Riemannian submanifolds	283
6.1.1	Fundamental formulae of submanifold	283
6.1.2	Local form of fundamental formulae	288
§6.2	Fundamental equations on combinatorial submanifolds	290
6.2.1	Gauss equation	290
6.2.2	Codazzi equaton	291
6.2.3	Ricci equation	292
6.2.4	Local form of fundamental equation	292
§6.3	Embedded combinatorial submanifolds	294
6.3.1	Embedded combinatorial submanifold	294
6.3.2	Embedded in combinatorial Euclidean space	297
§6.4	Topological multi-groups	303
6.4.1	Topological multi-group	303
6.4.2	Lie multi-group	310
6.4.3	Homomorphism on lie multi-group	317
6.4.4	Adjoint representation	318
6.4.5	Lie multi-subgroup	319
6.4.6	Exponential mapping	319
6.4.7	Action of Lie multi-group	324
§6.5	Principal fiber bundles	328

6.5.1	Principal fiber bundle	328
6.5.2	Combinatorial Principal fiber bundle	330
6.5.3	Automorphism of principal fiber bundle	332
6.5.4	Gauge transformation	334
6.5.5	Connection on principal fiber bundle	336
6.5.6	Curvature form on principal fiber bundle	342
§6.6	Remarks	344
Chapter 7. Fields with Dynamics		347
§7.1	Mechanical Fields	348
7.1.1	Particle Dynamic	348
7.1.2	Variational Principle	351
7.1.3	Hamiltonian principle	354
7.1.4	Lagrange Field	355
7.1.5	Hamiltonian Field	357
7.1.6	Conservation Law	360
7.1.7	Euler-Lagrange Equation	361
§7.2	Gravitational Field	362
7.2.1	Newtonian Gravitational Field	362
7.2.2	Einstein' s Spacetime	364
7.2.3	Einstein Gravitational Field	366
7.2.4	Limitation of Einstein' s Equation	369
7.2.5	Schwarzschild Metric	370
7.2.6	Schwarzschild Singularity	375
7.2.7	Kruskal Coordinate	376
§7.3	Electromagnetic Field	378
7.3.1	Electrostatic Field	378
7.3.2	Magnetostatic Field	380
7.3.3	Electromagnetic Field	378
7.3.4	Maxwell Equation	385
7.3.5	Electromagnetic Field with Gravitation	389

§7.4	Gauge Field	392
7.4.1	Gauge Scalar Field	392
7.4.2	Maxwell Field	394
7.4.3	Weyl Field	395
7.4.4	Dirac Field	398
7.4.5	Yang-Mills Field	400
7.4.6	Higgs Mechanism	403
7.4.7	Geometry of Gauge Field	407
§7.5	Remarks	410
Chapter 8. Combinatorial Fields with Applications		413
§8.1	Combinatorial Fields	414
8.1.1	Combinatorial Field	414
8.1.2	Combinatorial Configuration Space	416
8.1.3	Geometry on Combinatorial Field	419
8.1.4	Covariance Principle in Combinatorial Field	420
§8.2	Equation of Combinatorial Field	422
8.2.1	Lagrangian on Combinatorial Field	422
8.2.2	Hamiltonian on Combinatorial Field	425
8.2.3	Equation of Combinatorial Field	429
8.2.4	Tensor Equation on Combinatorial Field	435
§8.3	Combinatorial Gravitational Fields	438
8.3.1	Combinatorial Metric	438
8.3.2	Combinatorial Schwarzschild Metric	440
8.3.3	Combinatorial Reissner-Nordström Metric	443
8.3.4	Multi-Time System	447
8.3.5	Physical Condition	449
§8.4	Combinatorial Gauge Fields	452
8.4.1	Gauge Multi-Basis	452
8.4.2	Combinatorial Gauge Basis	454

8.4.3 Combinatorial Gauge Field	456
8.4.4 Geometry on Combinatorial Gauge Field.....	458
8.4.5 Higgs Mechanism on Combinatorial Gauge Field.....	460
§8.5 Applications	462
8.5.1 Many-Body Mechanics.....	462
8.5.2 Cosmology.....	463
8.5.3 Physical Structure	465
8.5.4 Economical Field	466
References	468
Indexes	477

No object is mysterious. The mystery is our eyes.

By Elizabeth, a British female writer.

CHAPTER 1.

Combinatorics with Graphs

For catering the need of computer science, combinatorics have mushroomed with many important results produced in the past century. Then *what is the essence of combinatorics?* In fact, it is in a combinatorial speculation, namely, *combining different fields into a unifying one without metrics*. That is why only abstract notations are considered in combinatorics. In this chapter, we introduce main ideas and techniques in combinatorics motivating the *mathematical combinatorics* in the follow-up chapters. Certainly, it can be also viewed as a brief introduction to combinatorics and graphs.

§1.1 SETS WITH OPERATIONS

1.1.1 Set. A *set* \mathfrak{S} is a collection of objects with properties $P_i, 1 \leq i \leq s$, denoted by

$$\mathfrak{S} = \{x | x \text{ posses properties } P_i, 1 \leq i \leq s\}.$$

For examples,

$$A = \{\text{natural numbers diviable by a prime } p\},$$

$$B = \{\text{cities with persons more than 10 million in the world}\}$$

are two sets by definition. In philosophy, a SET is a category consisting of parts. That is why we use conceptions of SET or PROPERTY without distinction, or distinguish them just by context in mathematics sometimes.

An element x possessing properties $P_i, 1 \leq i \leq s$ is said an element of the set \mathfrak{S} , denoted by $x \in \mathfrak{S}$. Conversely, an element y without all properties $P_i, 1 \leq i \leq s$ is not an element of \mathfrak{S} , denoted $y \notin \mathfrak{S}$. Denoted by $|\mathfrak{S}|$ the *cardinality* of a set \mathfrak{S} . In the case of finite set, $|\mathfrak{S}|$ is the number of elements in \mathfrak{S} .

Let \mathfrak{S}_1 and \mathfrak{S}_2 be two sets. If for $\forall x \in \mathfrak{S}_1$, there must be $x \in \mathfrak{S}_2$, then we say that \mathfrak{S}_1 is a *subset* of \mathfrak{S}_2 or \mathfrak{S}_1 is *included* in \mathfrak{S}_2 , denoted by $\mathfrak{S}_1 \subseteq \mathfrak{S}_2$. A subset \mathfrak{S}_1 of \mathfrak{S}_2 is *proper*, denoted by $\mathfrak{S}_1 \subset \mathfrak{S}_2$ if there exists an element $y \in \mathfrak{S}_2$ with $y \notin \mathfrak{S}_1$ hold. Further, the void (empty) set \emptyset , i.e., $|\emptyset| = 0$ is a subset of all sets by definition.

There sets $\mathfrak{S}_1, \mathfrak{S}_2$ are said to be *equal*, denoted by $\mathfrak{S}_1 = \mathfrak{S}_2$ if $x \in \mathfrak{S}_1$ implies $x \in \mathfrak{S}_2$, and vice versa. Applying subsets, we know a fundamental criterion on isomorphic sets.

Theorem 1.1.1 *Two sets \mathfrak{S}_1 and \mathfrak{S}_2 are equal if and only if $\mathfrak{S}_1 \subseteq \mathfrak{S}_2$ and $\mathfrak{S}_2 \subseteq \mathfrak{S}_1$.*

This criterion can simplifies a presentation of a set sometimes. For example, for a given prime p the set A can be presented by

$$A = \{pn \mid n \geq 1\}.$$

Notice that the relation of inclusion \subseteq is reflexive, also transitive, but not symmetric. Otherwise, by Theorem 1.1, if $\mathfrak{S}_1 \subseteq \mathfrak{S}_2$ and $\mathfrak{S}_2 \subseteq \mathfrak{S}_1$, then we must find that $\mathfrak{S}_1 = \mathfrak{S}_2$. In summary, the inclusion relation \subseteq for subsets shares with following properties:

Reflexive: For any \mathfrak{S} , $\mathfrak{S} \subseteq \mathfrak{S}$;

Antisymmetric: If $\mathfrak{S}_1 \subseteq \mathfrak{S}_2$ and $\mathfrak{S}_2 \subseteq \mathfrak{S}_1$, then $\mathfrak{S}_1 = \mathfrak{S}_2$;

Transitive: If $\mathfrak{S}_1 \subseteq \mathfrak{S}_2$ and $\mathfrak{S}_2 \subseteq \mathfrak{S}_3$, then $\mathfrak{S}_1 \subseteq \mathfrak{S}_3$.

A set of cardinality i is called an i -set. All subsets of a set \mathfrak{S} naturally form a set $\mathcal{P}(\mathfrak{S})$, called the *power set* of \mathfrak{S} . For a finite set \mathfrak{S} , we know the number of its subsets.

Theorem 1.1.2 *Let \mathfrak{S} be a finite set. Then*

$$|\mathcal{P}(\mathfrak{S})| = 2^{|\mathfrak{S}|}.$$

Proof Notice that for any integer $i, 1 \leq i \leq |\mathfrak{S}|$, there are $\binom{|\mathfrak{S}|}{i}$ non-isomorphic subsets of cardinality i in \mathfrak{S} . Therefore, we find that

$$|\mathcal{P}(\mathfrak{S})| = \sum_{i=1}^{|\mathfrak{S}|} \binom{|\mathfrak{S}|}{i} = 2^{|\mathfrak{S}|}. \quad \square$$

1.1.2 Operations. For subsets S, T in a power set $\mathcal{P}(\mathfrak{S})$, binary operations on them can be introduced as follows.

The *union* $S \cup T$ and *intersection* $S \cap T$ of sets S and T are respective defined by

$$S \cup T = \{x | x \in S \text{ or } x \in T\},$$

$$S \cap T = \{x | x \in S \text{ and } x \in T\}.$$

These operations \cup, \cap have analogy with ordinary operations $\cdot, +$ in a real field \mathbf{R} , such as those of described in the following laws.

Idempotent: $X \cup X = X$ and $X \cap X = X$;

Commutative: $X \cup T = T \cup X$ and $X \cap T = T \cap X$;

Associative: $X \cup (T \cup R) = (X \cup T) \cup R$ and $X \cap (T \cap R) = (X \cap T) \cap R$;

Distributive: $X \cup (T \cap R) = (X \cup T) \cap (X \cup R)$ and
 $X \cap (T \cup R) = (X \cap T) \cup (X \cap R)$.

These idempotent, commutative and associative laws can be verified immediately by definition. For the distributive law, let $x \in X \cup (T \cap R) = (X \cup T) \cap (X \cup R)$. Then $x \in X$ or $x \in T \cap R$, i.e., $x \in T$ and $x \in R$. Now if $x \in X$, we know that $x \in X \cup T$ and $x \in X \cup R$. Whence, we get that $x \in (X \cup T) \cap (X \cup R)$. Otherwise, $x \in T \cap R$, i.e., $x \in T$ and $x \in R$. We also get that $x \in (X \cup T) \cap (X \cup R)$.

Conversely, for $\forall x \in (X \cup T) \cap (X \cup R)$, we know that $x \in X \cup T$ and $x \in X \cup R$, i.e., $x \in X$ or $x \in T$ and $x \in R$. If $x \in X$, we get that $x \in X \cup (T \cap R)$. If $x \in T$ and $x \in R$, we also get that $x \in X \cup (T \cap R)$. Therefore, $X \cup (T \cap R) = (X \cup T) \cap (X \cup R)$ by definition.

Similar discussion can also verifies the law $X \cap (T \cup R) = (X \cap T) \cup (X \cap R)$.

Theorem 1.1.3 *Let \mathfrak{S} be a set and $X, T \in \mathcal{P}(\mathfrak{S})$. Then conditions following are equivalent.*

- (i) $X \subseteq T$;
- (ii) $X \cap T = X$;
- (iii) $X \cup T = T$.

Proof The conditions (1) \Rightarrow (2) and (1) \Rightarrow (3) are obvious. Now if $X \cap T = X$ or $X \cup T = T$, then for $\forall x \in X$, there must be $x \in T$, namely, $X \subseteq T$. Whence, these conditions (2) \Rightarrow (1) and (3) \Rightarrow (1). \square

For the empty set \emptyset and \mathfrak{S} itself, we also have special properties following.

Universal bounds: $\emptyset \subseteq X \subseteq \mathfrak{S}$ for $X \in \mathcal{P}(\mathfrak{S})$;

Union: $\emptyset \cup X = X$ and $\mathfrak{S} \cup X = \mathfrak{S}$;

Intersection: $\emptyset \cap X = \emptyset$ and $\mathfrak{S} \cap X = X$.

Let \mathfrak{S} be a set and $X \in \mathcal{P}(\mathfrak{S})$. Define the complement \overline{X} of X in \mathfrak{S} to be

$$\overline{X} = \{ y \mid y \in \mathfrak{S} \text{ but } y \notin X \}.$$

Then we know three laws on complementation of a set following related to union and intersection.

Complementarity: $X \cap \overline{X} = \emptyset$ and $X \cup \overline{X} = \mathfrak{S}$;

Involution: $\overline{\overline{X}} = X$;

Dualization: $\overline{X \cup T} = \overline{X} \cap \overline{T}$ and $\overline{X \cap T} = \overline{X} \cup \overline{T}$.

These complementarity and involution laws can be immediately found by definition. For the dualization, let $x \in \overline{X \cup T}$. Then $x \in \mathfrak{S}$ but $x \notin X \cup T$, i.e., $x \notin X$ and $x \notin T$. Whence, $x \in \overline{X}$ and $x \in \overline{T}$. Therefore, $x \in \overline{X} \cap \overline{T}$. Now for $\forall x \in \overline{X} \cap \overline{T}$, there must be $x \in \overline{X}$ and $x \in \overline{T}$, i.e., $x \in \mathfrak{S}$ but $x \notin X$ and $x \notin T$. Hence, $x \notin X \cup T$. This fact implies that $x \in \overline{X \cup T}$. By definition, we find that $\overline{X \cup T} = \overline{X} \cap \overline{T}$. Similarly, we can also get the law $\overline{X \cap T} = \overline{X} \cup \overline{T}$.

For two sets S and T , the *Cartesian product* $S \times T$ of S and T is defined to be all ordered pairs of elements (a, b) for $\forall a \in S$ and $\forall b \in T$, i.e.,

$$S \times T = \{(a, b) \mid a \in S, b \in T\}.$$

A *binary operation* \circ on a set S is an injection mapping $\circ : S \times S \rightarrow S$. Generally, a subset R of $S \times S$ is called a *binary relation* on S , and for $\forall (a, b) \in R$, denoted by aRb that a has relation R with b in S . A relation R on S is *equivalent* if it is

Reflexive: aRa for $\forall a \in S$;

Symmetric: aRb implies bRa for $\forall a, b \in S$;

Transitive: aRb and bRc imply aRc for $\forall a, b, c \in S$.

1.1.3 Boolean Algebra. A *Boolean algebra* is a set \mathcal{B} with two operations \vee and \wedge , such that for $\forall a, b, c \in \mathcal{B}$ properties following hold.

(i) The idempotent laws

$$a \vee a = a \wedge a = a,$$

the commutative laws

$$a \vee b = b \vee a, \quad a \wedge b = b \wedge a,$$

and the associative laws

$$a \vee (b \vee c) = (a \vee b) \vee c, \quad a \wedge (b \wedge c) = (a \wedge b) \wedge c.$$

(ii) The absorption laws

$$a \vee (a \wedge b) = a \wedge (a \vee b) = a.$$

(iii) The distributive laws, i.e.,

$$a \vee (b \wedge c) = (a \vee b) \wedge (a \vee c), \quad a \wedge (b \vee c) = (a \wedge b) \vee (a \wedge c).$$

(iv) There exist two universal bound elements O, I in \mathcal{B} such that

$$O \vee a = a, \quad O \wedge a = O, \quad I \vee a = I, \quad I \wedge a = a.$$

(v) There is a 1 – 1 mapping $\varsigma : a \rightarrow \bar{a}$ obeyed laws

$$a \vee \bar{a} = I, \quad a \wedge \bar{a} = O.$$

Now choose operations $\cup = \vee, \cap = \wedge$ and universal bounds $I = \mathfrak{S}, O = \emptyset$ in $\mathcal{P}(\mathfrak{S})$. We know that

Theorem 1.1.4 *Let \mathfrak{S} be a set. Then the power set $\mathcal{P}(\mathfrak{S})$ forms a Boolean algebra under these union, intersection and complement operations. \square*

For an abstractly Boolean algebra \mathcal{B} , some basic laws can be immediately found by its definition. For instance, we know each of laws following.

Law B1 *Each of these identities $a \vee x = x$ and $a \wedge x = a$ for all $x \in \mathcal{B}$ implies that $a = O$, and dually, each of these identities $a \vee x = a$ and $a \wedge x = x$ implies that $a = I$.*

For example, if $a \vee x = x$ for all $x \in \mathcal{B}$, then $a \vee O = O$ in particular. But $a \vee O = a$ by the axiom (iv). Hence $a = O$. Similarly, we can get $a = O$ or $a = I$ from all other identities.

Law B2 For $\forall a, b \in \mathcal{B}$, $a \vee b = b$ if and only if $a \wedge b = a$.

In fact, if $a \vee b = b$, then $a \wedge b = a \wedge (a \vee b) = a$ by the absorption law (ii). Conversely, if $a \wedge b = a$, then $a \vee b = (a \wedge b) \vee b = b$ by the commutative and absorption laws.

Law B3 These equations $a \vee x = a \vee y$ and $a \wedge x = a \wedge y$ together imply that $x = y$.

Certainly, by the absorption, distributive and commutative laws we have

$$\begin{aligned} x &= x \wedge (a \vee x) = x \wedge (a \vee y) \\ &= (x \wedge a) \vee (x \vee y) = (y \wedge x) \vee (y \vee a) \\ &= y \wedge (x \vee a) = y \wedge (y \vee a) = y. \end{aligned}$$

Law B4 For $\forall x, y \in \mathcal{B}$,

$$\overline{\overline{x}} = x, \quad \overline{(x \wedge y)} = \overline{x} \vee \overline{y} \quad \text{and} \quad \overline{(x \vee y)} = \overline{x} \wedge \overline{y}.$$

Notice that $\overline{x} \wedge x = x \wedge \overline{x} = O$ and $\overline{x} \vee x = x \vee \overline{x} = I$. By Law B3, the complement \overline{a} is unique for $\forall a \in \mathcal{B}$. We know that $\overline{\overline{x}} = x$. Now by distributive, associative laws, we find that

$$\begin{aligned} (x \wedge y) \wedge (\overline{x} \vee \overline{y}) &= (x \wedge y \wedge \overline{x}) \vee (x \wedge y \wedge \overline{y}) \\ &= ((x \wedge \overline{x}) \wedge y) \vee (x \wedge (y \wedge \overline{y})) \\ &= (O \wedge y) \vee (x \wedge O) = O \vee O = O \end{aligned}$$

and

$$\begin{aligned} (x \wedge y) \vee (\overline{x} \vee \overline{y}) &= (x \vee \overline{x} \vee \overline{y}) \wedge (y \vee \overline{x} \vee \overline{y}) \\ &= (x \vee \overline{x} \vee \overline{y}) \wedge (y \vee \overline{y} \vee \overline{x}) \\ &= (I \vee \overline{y}) \wedge (I \vee \overline{x}) = I \vee I = I. \end{aligned}$$

Therefore, again by the uniqueness of complements, we get that $\overline{(x \wedge y)} = \overline{x} \vee \overline{y}$. The identity $\overline{(x \vee y)} = \overline{x} \wedge \overline{y}$ can be found similarly.

For variables x_1, x_2, \dots, x_n in \mathcal{B} , polynomials $f(x_1, x_2, \dots, x_n)$ built up from operations \vee and \wedge are called *Boolean polynomials*. Each Boolean polynomial has a canonical form ensured in the next result.

Theorem 1.1.5 *Any Boolean polynomial in x_1, x_2, \dots, x_n can be reduced either to O or to join of some canonical forms*

$$p_1 \wedge p_2 \wedge \dots \wedge p_n,$$

where each $p_i = x_i$ or \bar{x}_i .

Proof According to the definition of Boolean algebra and laws B1–B4, a canonical form for a Boolean polynomial, for example, $f(x_1, x_2, x_3) = x_1 \vee x_3 \vee \overline{x_2 \vee x_3} \vee (x_2 \vee x_1)$, can be gotten by programming following.

STEP 1. *If any complement occurs outside any parenthesis in the polynomial, moved it inside by Law B4.*

After all these complements have been moved all the way inside, the polynomial involving only vees and wedges action on complement and uncomplement letters. Thus, in our example: $f(x_1, x_2, x_3) = [\bar{x}_1 \wedge \bar{x}_3 \wedge (x_2 \vee x_3)] \vee (x_2 \wedge x_1)$.

STEP 2. *If any \wedge stands outside a parenthesis which contains a \vee , then the \wedge can be moved inside by applying the distributive law.*

There result a polynomial in which all meets \wedge are formed before any join \vee , i.e., a join of terms in which each term is a meet of complement and uncomplement letters. In the above example, $f(x_1, x_2, x_3) = (\bar{x}_1 \wedge \bar{x}_3 \wedge x_2) \vee (\bar{x}_1 \wedge \bar{x}_3 \wedge x_3) \vee (x_2 \wedge x_1)$.

STEP 3. *If a letter y appears twice in one term, omit one occurrence by $y \wedge y = y$. If y appears both complement and uncomplement, omit the whole term since $y \wedge a \wedge \bar{y} = O$ and $O \vee b = b$ for all $a, b \in \mathcal{B}$.*

Thus in our example, we know that $f(x_1, x_2, x_3) = (\bar{x}_1 \wedge \bar{x}_3 \wedge x_2) \vee (x_2 \wedge x_1)$.

STEP 4. *If some term T fail to contain just a letter z by STEP 3, then replace it by $(T \wedge z) \vee (T \wedge \bar{z})$, in each of which z occurs exactly once.*

By this step, our Boolean polynomial transfers to $f(x_1, x_2, x_3) = (\bar{x}_1 \wedge \bar{x}_3 \wedge x_2) \vee (x_2 \wedge x_1 \wedge x_3) \vee (x_2 \wedge x_1 \wedge \bar{x}_3)$.

STEP 5. *Rearrange letters appearing in each term in their natural order.*

Thus in our example, we finally get its canonical form $f(x_1, x_2, x_3) = (\bar{x}_1 \wedge x_2 \wedge \bar{x}_3) \vee (x_1 \wedge x_2 \wedge x_3) \vee (x_1 \wedge x_2 \wedge \bar{x}_3)$.

This completes the proof. □

Corollary 1.1.1 There are 2^n canonical forms and 2^{2^n} Boolean polynomials in variable x_1, x_2, \dots, x_n in a Boolean algebra \mathcal{B} with $|\mathcal{B}| \geq n$.

Defining a mapping $\eta : \mathcal{B} \rightarrow \{0, 1\}$ by $\eta(x_i) = 1$ or 0 according to $p_i = x_i$ or $p_i = \bar{x}_i$ in Theorem 1.1.5, we get a bijection between these Boolean polynomials in variable x_1, x_2, \dots, x_n and the set of all 2^n n-digit binary numbers. For the example in the proof of Theorem 1.5, we have

$$\eta(f(x_1, x_2, x_3)) = 010, 111, 110.$$

1.1.4 Multi-Set. Considering the importance of Smarandache multi-spaces for modern sciences, we discuss multi-sets as a preparing step in this subsection.

For an integer $n \geq 1$, a *multi-set* \tilde{X} is a union of sets X_1, X_2, \dots, X_n distinct two by two. Examples of multi-sets can be found in the following.

$$\mathcal{L} = R \cup T,$$

where $R = \{\text{integers}\}$, $T = \{\text{polyhedrons}\}$.

$$\mathcal{G} = G_1 \cup G_2 \cup G_3,$$

where $G_1 = \{\text{gravitational field}\}$, $G_2 = \{\text{electric field}\}$ and $G_3 = \{\text{magnetic field}\}$. By definition, a multi-set is also a set only with a union structure. The inverse of this statement is also true shown in the next.

Theorem 1.1.6 Any set X with $|X| \geq 2$ is a multi-set.

Proof Let $a, b \in X$ be two different elements in X . Define $X_1 = X \setminus \{a\}$, $X_2 = X \setminus \{b\}$. Then we know that

$$X = X_1 \cup X_2,$$

i.e., X is a multi-set. □

According to Theorem 1.5, we find that an equality following.

{sets with cardinality ≥ 2 } = {multi – sets}.

This equality can be characterized more accurately by introducing some important parameters.

Theorem 1.1.7 For a set \mathcal{R} with cardinality ≥ 2 and integers $k \geq 1, s \geq 0$, there exist k sets R_1, R_2, \dots, R_k distinct two by two such that

$$\mathcal{R} = \bigcup_{i=1}^k R_i$$

with

$$|\bigcap_{i=1}^k R_i| = s$$

if and only if

$$|\mathcal{R}| \geq k + s.$$

Proof Assume there are sets k sets R_1, R_2, \dots, R_k distinct two by two such that $\mathcal{R} = \bigcup_{i=1}^k R_i$ and $|\bigcap_{i=1}^k R_i| = s$. Notice that for any sets X and Y with $X \cap Y = \emptyset$

$$|X \cup Y| = |X| + |Y|$$

and there is a subset

$$\bigcup_{i=1}^k (R_i \setminus (\bigcup_{t=1}^k R_t \setminus R_i)) \cup \bigcap_{i=1}^k R_i \subseteq \bigcup_{i=1}^k R_i$$

with

$$R_i \setminus (\bigcup_{t=1}^k R_t \setminus R_i) \cap (\bigcap_{i=1}^k R_i) = \emptyset,$$

we find that

$$|\mathcal{R}| = \bigcup_{i=1}^k R_i \geq |\bigcup_{i=1}^k (R_i \setminus (\bigcup_{t=1}^k R_t \setminus R_i)) \cup \bigcap_{i=1}^k R_i|$$

$$\begin{aligned}
 &= \left| \bigcup_{i=1}^k (R_i \setminus (\bigcup_{t=1}^k R_t \setminus R_i)) \right| + \left| \bigcap_{i=1}^k R_i \right| \\
 &\geq k + s.
 \end{aligned}$$

Now if $|\mathcal{R}| \geq k + s$, let

$$\{a_1, a_2, \dots, a_k, b_1, b_2, \dots, b_s\} \subseteq \mathcal{R}$$

with $a_i \neq a_j, b_i \neq b_j$ if $i \neq j$. Construct sets

$$R_1 = \{a_2, \dots, a_k, b_1, b_2, \dots, b_s\},$$

$$R_2 = \mathcal{R} \setminus \{a_2\},$$

$$R_3 = \mathcal{R} \setminus \{a_3\},$$

.....,

$$R_k = \mathcal{R} \setminus \{a_k\}.$$

Then we get that

$$\mathcal{R} = \bigcup_{i=1}^k R_i$$

and

$$\bigcap_{i=1}^k R_i = \{b_1, b_2, \dots, b_s\}.$$

This completes the proof. □

Corollary 1.1.2 *For a set \mathcal{R} with cardinality ≥ 2 and an integer $k \geq 1$, there exist k sets R_1, R_2, \dots, R_k distinct two by two such that*

$$\mathcal{R} = \bigcup_{i=1}^k R_i$$

if and only if

$$|\mathcal{R}| \geq k.$$

§1.2 PARTIALLY ORDERED SETS

1.2.1 Partially Ordered Set. A *partially ordered set* (X, P) , or *poset* in short, consists of a non-empty set X and a binary relation P on X which is reflexive, anti-symmetric and transitive. For convenience, $x \leq y$ are used to denote $(x, y) \in P$. In addition, let $x < y$ denote that $x \leq y$ but $x \neq y$. If $x < y$ and there are no elements $z \in X$ such that $x < z < y$, then y is said to *cover* x .

A common example of posets is the power set $\mathcal{P}(S)$ with the binary operation \cup on a set S . Another is (X, P) , where X and P is defined in the following:

$$X = \{e, a, b, c, d\},$$

$$P = \{(a, a), (b, b), (c, c), (d, d), (e, e), (a, b), (a, c), (d, c), (e, a), (e, d), (e, c), (e, b)\}.$$

Partially ordered sets with a finite number of elements can be conveniently represented by *Hasse diagrams*. A Hasse diagram of a poset (X, P) is drawing in which the elements of X are placed on the Euclid plane \mathbf{R}^2 so that if y covers x , then y is placed at a higher level than x and joined to x by a line segment. For the second example above, its Hasse diagram is shown in Fig.1.2.1.

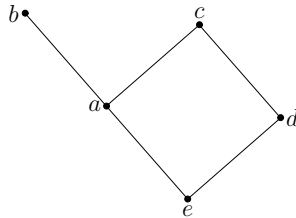

Fig.1.2.1

Two distinct elements x any y in a poset (X, P) are called comparable if either $x < y$ or $y < x$, and incomparable otherwise. A poset in which any two elements are comparable is called a *chain* or *ordered set*, and one in which no two elements are comparable is called an *antichain* or *unordered set*.

A *subposet* of a poset (X, P) is a poset (Y, Q) in which $Y \subseteq X$ and Q is the restriction of P to $Y \times Y$. Two posets (X, P) and (X', P') are called *isomorphic* if there is a one-to-one correspondence $\tau : X \rightarrow X'$ such that $x \leq y$ in P if and only if $\tau(x) \leq \tau(y)$ in P' . A poset (Y, Q) is said to be embedded in (X, P) , denoted by $(Y, Q) \subseteq (X, P)$ if (Y, Q) is isomorphic to a subposet of (X, P) . For two partial orders P and Q on a set X , we call Q an *extension* of P if $P \subseteq Q$ and a *linear extension* of P if Q is a chain. It is obvious that *any poset (X, P) has a linear extension and the intersection of all linear extension of P is P itself*. This fact can be restated as follows:

for any two incomparable elements x and y in a poset (X, P) , there is one linear extension of P in which $x < y$, and another in which $y < x$.

Denote a linear order $L : x_1 \leq x_2 \leq \dots \leq x_n$ by $L : [x_1, x_2, \dots, x_n]$. For a given poset (X, P) , a *realizer* $\{L_1, L_2, \dots, L_t\}$ of P is a collection R of linear extension whose intersection is P , i.e., $x < y$ in P if and only if $x < y$ in every $L_i, 1 \leq i \leq t$. The it dimension $\dim(X, P)$ of a poset (X, P) is defined to be the minimum order of realters R of P and the *rank* $\text{rank}(X, P)$ of (X, P) to be the maximum order of realizers R in which there are no proper subset of R is again a realizer of (X, P) . For example, $\dim(X, P) = 1$ or $\text{rank}(X, P) = 1$ if and only if it is a chain and $\dim(X, P) = 2$ if it is an n -element antichain for $n \geq 2$. For $n \geq 3$, we construct a infinite family, called the *standard n -dimensional poset \mathbf{S}_n^0* with dimension and rank n .

For $n \geq 3$, the poset \mathbf{S}_n^0 consists of n maximal elements a_1, a_2, \dots, a_n and n minimal elements b_1, b_2, \dots, b_n with $b_i < a_j$ for any integers $1 \leq i, j \leq n$ with $i \neq j$. Then we know the next result.

Theorem 1.2.1 *For any integer $n \geq 3$, $\dim \mathbf{S}_n^0 = \text{rank} \mathbf{S}_n^0 = n$.*

Proof Consider the set $R = \{L_1, L_2, \dots, L_n\}$ of linear extensions of \mathbf{S}_n^0 with

$$L_k : [b_1, \dots, b_{k-1}, b_{k+1}, \dots, b_n, a_k, b_k, a_1, \dots, a_{k-1}, a_{k+1}, \dots, a_n].$$

Notice that if $i \neq j$, then $b_j < a_i < b_i < a_j$ in L_i , and $b_i < a_j < b_j < a_i$ in L_j for any integers $i, j, 1 \leq i, j \leq n$. Whence, R is a realizer of \mathbf{S}_n^0 . We know that $\dim \mathbf{S}_n^0 \leq n$.

Now if R^* is any realizer of \mathbf{S}_n^0 , then for each $k = 1, 2, \dots, n$, by definition some elements of R^* must have $a_k < b_k$, and furthermore, we can easily find that there are no linear extensions L of \mathbf{S}_n^0 such that $a_i < b_i$ and $a_j < b_j$ for two integers $i, j, i \neq j$. This fact enables us to get that $\dim \mathbf{S}_n^0 \geq n$.

Therefore, we have $\dim \mathbf{S}_n^0 = n$.

For $\text{rank} \mathbf{S}_n^0 = n$, notice that $\text{rank} \mathbf{S}_n^0 \geq \dim \mathbf{S}_n^0 \geq n$. Now observe that a family R of linear extension of \mathbf{S}_n^0 is a realizer if and only if, for $i = 1, 2, \dots, n$, there exists a $L_i \in R$ at least such that $a_i < b_i$. Hence, n is also an upper bound of $\text{rank} \mathbf{S}_n^0$. \square

1.2.2 Multi-Poset. A *multi-poset* (\tilde{X}, \tilde{P}) is a union of posets $(X_1, P_1), (X_2, P_2), \dots, (X_s, P_s)$ distinct two by two for an integer $s \geq 2$, i.e.,

$$(\tilde{X}, \tilde{P}) = \bigcup_{i=1}^s (X_i, P_i),$$

also call it an s -poset. If each (X_i, P_i) is a chain for any integers $1 \leq i \leq s$, we call it an s -chain. For a finite poset, we know the next result.

Theorem 1.2.2 *Any finite poset (X, P) is a multi-chain.*

Proof Applying the induction on the cardinality $|X|$. If $|X| = 1$, the assertion is obvious. Now assume the assertion is true for any integer $|X| \leq k$. Consider the case of $|X| = k + 1$.

Choose a maximal element $a_1 \in X$. If there are no elements a_2 in X such that $a_2 \leq a_1$, then the element a_1 is incomparable with all other elements in X . Whence, $(X \setminus \{a_1\}, P)$ is also a poset. We know that $(X \setminus \{a_1\}, P)$ is a multi-chain by the induction assumption. Therefore, $(X, P) = (X \setminus \{a_1\}, P) \cup L_1$ is also a multi-chain, where $L_1 = [a_1]$.

If there is an element a_2 in X covered by a_1 , consider the element a_2 in X again. Similarly, if there are no elements a_3 in X covered by a_2 , then $L_2 = [a_2, a_1]$ is itself a chain. By the induction assumption, $X \setminus \{a_1, a_2\}$ is a multi-chain. Whence, $(X, P) = (X \setminus \{a_1, a_2\}, P) \cup L_2$ is a multi-chain.

Otherwise, there are elements a_3 in X covered by a_2 . Assume $a_t, a_{t-1}, \dots, a_2, a_1$

is a maximal sequence such that a_{i+1} is covered by a_i in (X, P) , then $L_t = [a_t, a_{t-1}, \dots, a_2, a_1]$ is a chain. Consider $(X \setminus \{a_1, a_2, \dots, a_{t-1}, a_t\}, P)$. It is still a poset with $|X \setminus \{a_1, a_2, \dots, a_{t-1}, a_t\}| \leq k$. By the induction assumption, it is a multi-chain. Whence,

$$(X, P) = (X \setminus \{a_1, a_2, \dots, a_{t-1}, a_t\}, P) \bigcup L_t$$

is also a multi-chain. In conclusion, we get that (X, P) is a multi-chain in the case of $|X| = k + 1$. By the induction principle, we get that (X, P) is a multi-chain for any X with $|X| \geq 1$. \square

Now consider the inverse problem, i.e., *when is a multi-poset a poset?* We find conditions in the following result.

Theorem 1.2.3 *An s -poset $(\tilde{X}, \tilde{P}) = \bigcup_{i=1}^s (X_i, P_i)$ is a poset if and only if for any integer $i, j, 1 \leq i, j \leq s$, $(x, y) \in P_i$ and $(y, z) \in P_j$ imply that $(x, z) \in \tilde{P}$.*

Proof Let (\tilde{X}, \tilde{P}) be a poset. For any integer $i, j, 1 \leq i, j \leq s$, since $(x, y) \in P_i$ and $(y, z) \in P_j$ also imply $(x, y), (y, z) \in \tilde{P}$. By the transitive laws in (\tilde{X}, \tilde{P}) , we know that $(x, z) \in \tilde{P}$.

On the other hand, for any integer $i, j, 1 \leq i, j \leq s$, if $(x, y) \in P_i$ and $(y, z) \in P_j$ imply that $(x, z) \in \tilde{P}$, we prove (\tilde{X}, \tilde{P}) is a poset. Certainly, we only need to check these reflexive laws, antisymmetric laws and transitive laws hold in (\tilde{X}, \tilde{P}) , which is divided into three discussions.

(i) For $\forall x \in \tilde{X}$, there must exist an integer $i, 1 \leq i \leq s$ such that $x \in X_i$ by definition. Whence, $(x, x) \in P_i$. Hence, $(x, x) \in \tilde{P}$, i.e., the reflexive laws is hold in (\tilde{X}, \tilde{P}) .

(ii) Choose two elements $x, y \in \tilde{X}$. If $(x, y) \in \tilde{P}$ and $(y, x) \in \tilde{P}$, then there are integers $i, j, 1 \leq i, j \leq s$ such that $(x, y) \in P_i$ and $(y, x) \in P_j$ by definition. According to the assumption, we know that $(x, x) \in \tilde{P}$, which is the antisymmetric laws in (\tilde{X}, \tilde{P}) .

(iii) The transitive laws are implied by the assumption. For if $(x, y) \in \tilde{P}$ and $(y, x) \in \tilde{P}$ for two elements $x, y \in \tilde{X}$, by definition there must exist integers $i, j, 1 \leq i, j \leq s$ such that $(x, y) \in P_i$ and $(y, z) \in P_j$. Whence, $(x, z) \in \tilde{P}$ by the assumption.

Combining these discussions, we know that (\tilde{X}, \tilde{P}) is a poset. \square

Certainly, we can also find more properties for multi-posets under particular conditions. For example, construct different posets by introducing new partially orders in a multi-poset. All these are referred to these readers interested on this topics.

§1.3 COUNTABLE SETS

1.3.1 Mapping. A *mapping* f from a set X to Y is a subset of $X \times Y$ such that for $\forall x \in X$, $|f \cap (\{x\} \times Y)| = 1$, i.e., $f \cap (\{x\} \times Y)$ only has one element. Usually, we denote a mapping f from X to Y by $f : X \rightarrow Y$ and $f(x)$ the second component of the unique element of $f \cap (\{x\} \times Y)$, called the *image* of x under f . Usually, we denote all mappings from X to Y by Y^X .

Let $f : X \rightarrow Y$ be a mapping. For any subsets $U \subseteq X$ and $V \subseteq Y$, define the *image* $f(U)$ of U under f to be

$$f(U) = \{f(u) \mid \text{for } \forall u \in U\}$$

and the *inverse* $f^{-1}(V)$ of V under f to be

$$f^{-1}(V) = \{u \in X \mid f(u) \in V\}.$$

Generally, for $U \subseteq X$, we have

$$U \subseteq f^{-1}(f(U))$$

by definition. A mapping $f : X \rightarrow Y$ is called *injection* if for $\forall y \in Y$, $|f \cap (X \times \{y\})| \leq 1$ and *surjection* if $|f \cap (X \times \{y\})| \geq 1$. If it is both injection and surjection, i.e., $|f \cap (X \times \{y\})| = 1$, then it is called a *bijection* or a *1 - 1 mapping*.

A bijection $f : X \rightarrow X$ is called a *permutation* of X . In the case of finite, there is a useful way for representing a permutation τ on X , $|X| = n$ by a $2 \times n$ table following,

$$\tau = \begin{pmatrix} x_1 & x_2 & \cdots & x_n \\ y_1 & y_2 & \cdots & y_n \end{pmatrix},$$

where, $x_i, y_i \in X$ and $x_i \neq x_j, y_i \neq y_j$ if $i \neq j$ for $1 \leq i, j \leq n$. For instance, let $X = \{1, 2, 3, 4, 5, 6\}$. Then

$$\begin{pmatrix} 1 & 2 & 3 & 4 & 5 & 6 & 7 & 8 \\ 2 & 3 & 5 & 6 & 1 & 4 & 8 & 7 \end{pmatrix}$$

is a permutation. All permutations of X form a set, denoted by $\prod(X)$. The *identity* on X is a particular permutation $\mathbf{1}_X \in \prod(X)$ given by $\mathbf{1}_X(x) = x$ for all $x \in X$.

For three sets X, Y and Z , let $f : X \rightarrow Y$ and $h : Y \rightarrow Z$ be mapping. Define a mapping $h \circ f : X \rightarrow Z$, called the *composition of f and h* by

$$h \circ f(x) = h(f(x))$$

for $\forall x \in X$. It can be verified immediately that

$$(h \circ f)^{-1} = f^{-1} \circ h^{-1}$$

by definition. We have a characteristic for bijections from X to Y by composition operations.

Theorem 1.3.1 *A mapping $f : X \rightarrow Y$ is a bijection if and only if there exists a mapping $h : Y \rightarrow X$ such that $f \circ h = \mathbf{1}_Y$ and $h \circ f = \mathbf{1}_X$.*

Proof If f is a bijection, then for $\forall y \in Y$, there is a unique $x \in X$ such that $f(x) = y$. Define a mapping $h : Y \rightarrow X$ by $h(y) = x$ for $\forall y \in Y$ and its correspondent x . Then it can be verified immediately that

$$f \circ h = \mathbf{1}_Y \text{ and } h \circ f = \mathbf{1}_X.$$

Now if there exists a mapping $h : Y \rightarrow X$ such that $f \circ h = \mathbf{1}_Y$ and $h \circ f = \mathbf{1}_X$, we claim that f is surjective and injective. Otherwise, if f is not surjective, then there exists an element $y \in Y$ such that $f^{-1}(y) = \emptyset$. Thereafter, for any mapping $h : Y \rightarrow X$, there must be

$$(f \circ h)(y) = f(h(y)) \neq y.$$

Contradicts the assumption $f \circ h = \mathbf{1}_Y$. If f is not injective, then there are elements $x_1, x_2 \in X, x_1 \neq x_2$ such that $f(x_1) = f(x_2) = y$. Then for any mapping $h : Y \rightarrow X$, we get that

$$(h \circ f)(x_1) = h(y) = (h \circ f)(x_2).$$

Whence, $h \circ f \neq \mathbf{1}_X$. Contradicts the assumption again.

This completes the proof. \square

1.3.2 Countable Set. For two sets X and Y , the equality $|X| = |Y|$, i.e., X and Y have the same cardinality means that there is a bijection f from X to Y . A set X is said to be *countable* if it is bijective with the set \mathbf{Z} of natural numbers. We know properties of countable sets and infinite sets following.

Theorem 1.3.2(Paradox of Galileo) *Any countable set X has a bijection onto a proper subset of itself, i.e., the cardinal of a set may be equal to its a subset.*

Proof Since X is countable, we can represent the set X by

$$X = \{x_i | 1 \leq i \leq +\infty\}.$$

Now choose a proper subset $X' = X \setminus \{x_1\}$ and define a bijection $f : X \rightarrow X \setminus \{x_1\}$ by

$$f(x_i) = x_{i+1}$$

for any integer $i, 1 \leq i \leq +\infty$. Whence, $|X \setminus \{x_1\}| = |X|$. \square

Theorem 1.3.3 *Any infinite set X contains a countable subset.*

Proof First, choose any element $x_1 \in X$. From $X \setminus \{x_1\}$, then choose a second element x_2 and from $X \setminus \{x_1, x_2\}$ a third element x_3 , and so on. Since X is infinite, for any integer n , $X \setminus \{x_1, x_2, \dots, x_n\}$ can never be empty. Whence, we can always choose an new element x_{n+1} in the set $X \setminus \{x_1, x_2, \dots, x_n\}$. This process can be never stop until we have constructed a subset $X' = \{x_i | 1 \leq i \leq +\infty\} \subseteq X$, i.e., a countable subset X' of X . \square

Corollary 1.3.1(Dedekind-Peirce) *A set X is infinite if and only if it has a bijection with a proper subset of itself.*

Proof If X is a finite set of cardinal number n , then there is a bijection $f : X \rightarrow \{1, 2, \dots, n\}$. If there is a bijection h from X to its a proper subset Y with cardinal number k , then by definition we deduce that $k = |Y| = |X| = n$. By assumption, Y is a proper subset of a finite set X . Whence, there must be $k < n$, a contradiction. This means that there are no bijection from a finite set to its a proper subset.

Conversely, let X be an infinite set. According to Theorem 1.3.3, X contains a

countable subset $X' = \{x_1, x_2, \dots\}$. Now define a bijection f from X to its a proper subset $X' \setminus \{x_1\}$ by

$$f(x) = \begin{cases} x_{i+1}, & \text{if } x = x_i \in X', \\ x, & \text{if } x \in X \setminus X'. \end{cases}$$

Whence, X has a bijection with a proper subset $X' \setminus \{x_1\}$ of itself. □

§1.4 GRAPHS

1.4.1 Graph. A *graph* G is an ordered 3-tuple $(V, E; I)$, where V, E are finite sets, $V \neq \emptyset$ and $I : E \rightarrow V \times V$. Call V the *vertex set* and E the *edge set* of G , denoted by $V(G)$ and $E(G)$, respectively. An elements $v \in V(G)$ is *incident* with an element $e \in E(G)$ if $I(e) = (v, x)$ or (x, v) for an $x \in V(G)$. Usually, if $(u, v) = (v, u)$ for $\forall u, v \in V$, G is called a graph, otherwise, a directed graph with an orientation $u \rightarrow v$ on each edge (u, v) .

The cardinal numbers of $|V(G)|$ and $|E(G)|$ are called its *order* and *size* of a graph G , denoted by $|G|$ and $\varepsilon(G)$, respectively.

Let G be a graph. It can be represented by locating each vertex u of G by a point $p(u)$, $p(u) \neq p(v)$ if $u \neq v$ and an edge (u, v) by a curve connecting points $p(u)$ and $p(v)$ on a plane \mathbf{R}^2 , where $p : G \rightarrow P$ is a mapping from the $V(G)$ to \mathbf{R}^2 .

For example, a graph $G = (V, E; I)$ with $V = \{v_1, v_2, v_3, v_4\}$, $E = \{e_1, e_2, e_3, e_4, e_5, e_6, e_7, e_8, e_9, e_{10}\}$ and $I(e_i) = (v_i, v_i), 1 \leq i \leq 4; I(e_5) = (v_1, v_2) = (v_2, v_1), I(e_8) = (v_3, v_4) = (v_4, v_3), I(e_6) = I(e_7) = (v_2, v_3) = (v_3, v_2), I(e_9) = I(e_{10}) = (v_1, v_4)$ can be drawn on a plane as shown in Fig.1.4.1

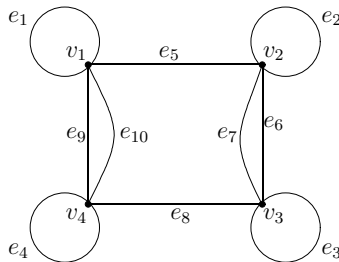

Fig. 1.4.1

Let $G = (V, E; I)$ be a graph. For $\forall e \in E$, if $I(e) = (u, u)$, $u \in V$, then e is called a *loop*. For non-loop edges $e_1, e_2 \in E$, if $I(e_1) = I(e_2)$, then e_1, e_2 are called *multiple edges* of G . A graph is *simple* if it is loopless without multiple edges, i.e., $I(e) = (u, v)$ implies that $u \neq v$, and $I(e_1) \neq I(e_2)$ if $e_1 \neq e_2$ for $\forall e_1, e_2 \in E(G)$. In the case of simple graphs, an edge (u, v) is commonly abbreviated to uv .

A *walk* of a graph G is an alternating sequence of vertices and edges $u_1, e_1, u_2, e_2, \dots, e_n, u_{n+1}$ with $e_i = (u_i, u_{i+1})$ for $1 \leq i \leq n$. The number n is called the *length of the walk*. A walk is *closed* if $u_1 = u_{n+1}$, and *opened*, otherwise. For example, the sequence $v_1e_1v_1e_5v_2e_6v_3e_3v_3e_7v_2e_2v_2$ is a walk in Fig.1.3.1. A walk is a *trail* if all its edges are distinct and a *path* if all the vertices are distinct also. A closed path is called a *circuit* usually.

A graph $G = (V, E; I)$ is *connected* if there is a path connecting any two vertices in this graph. In a graph, a maximal connected subgraph is called a *component*. A graph G is *k-connected* if removing vertices less than k from G still remains a connected graph. Let G be a graph. For $\forall u \in V(G)$, the neighborhood $N_G(u)$ of the vertex u in G is defined by $N_G(u) = \{v | \forall (u, v) \in E(G)\}$. The cardinal number $|N_G(u)|$ is called the *valency of vertex u* in G and denoted by $\rho_G(u)$. A vertex v with $\rho_G(v) = 0$ is an *isolated vertex* and $\rho_G(v) = 1$ a *pendent vertex*. Now we arrange all vertices valency of G as a sequence $\rho_G(u) \geq \rho_G(v) \geq \dots \geq \rho_G(w)$. Call this sequence the *valency sequence of G* . By enumerating edges in $E(G)$, the following equality is obvious.

$$\sum_{u \in V(G)} \rho_G(u) = 2|E(G)|.$$

A graph G with a vertex set $V(G) = \{v_1, v_2, \dots, v_p\}$ and an edge set $E(G) = \{e_1, e_2, \dots, e_q\}$ can be also described by means of matrixes. One such matrix is a $p \times q$ *adjacency matrix* $A(G) = [a_{ij}]_{p \times q}$, where $a_{ij} = |I^{-1}(v_i, v_j)|$. Thus, the adjacency matrix of a graph G is symmetric and is a 0, 1-matrix having 0 entries on its main diagonal if G is simple. For example, the matrix $A(G)$ of the graph in Fig.4.1 is

$$A(G) = \begin{bmatrix} 1 & 1 & 0 & 2 \\ 1 & 1 & 2 & 0 \\ 0 & 2 & 1 & 1 \\ 2 & 0 & 1 & 1 \end{bmatrix}$$

Let $G_1 = (V_1, E_1; I_1)$ and $G_2 = (V_2, E_2; I_2)$ be two graphs. They are *identical*, denoted by $G_1 = G_2$ if $V_1 = V_2, E_1 = E_2$ and $I_1 = I_2$. If there exists a 1 – 1 mapping $\phi : E_1 \rightarrow E_2$ and $\phi : V_1 \rightarrow V_2$ such that $\phi I_1(e) = I_2\phi(e)$ for $\forall e \in E_1$ with the convention that $\phi(u, v) = (\phi(u), \phi(v))$, then we say that G_1 is *isomorphic* to G_2 , denoted by $G_1 \cong G_2$ and ϕ an *isomorphism* between G_1 and G_2 . For simple graphs H_1, H_2 , this definition can be simplified by $(u, v) \in I_1(E_1)$ if and only if $(\phi(u), \phi(v)) \in I_2(E_2)$ for $\forall u, v \in V_1$.

For example, let $G_1 = (V_1, E_1; I_1)$ and $G_2 = (V_2, E_2; I_2)$ be two graphs with

$$V_1 = \{v_1, v_2, v_3\},$$

$$E_1 = \{e_1, e_2, e_3, e_4\},$$

$$I_1(e_1) = (v_1, v_2), I_1(e_2) = (v_2, v_3), I_1(e_3) = (v_3, v_1), I_1(e_4) = (v_1, v_1)$$

and

$$V_2 = \{u_1, u_2, u_3\},$$

$$E_2 = \{f_1, f_2, f_3, f_4\},$$

$$I_2(f_1) = (u_1, u_2), I_2(f_2) = (u_2, u_3), I_2(f_3) = (u_3, u_1), I_2(f_4) = (u_2, u_2),$$

i.e., those graphs shown in Fig.1.4.2.

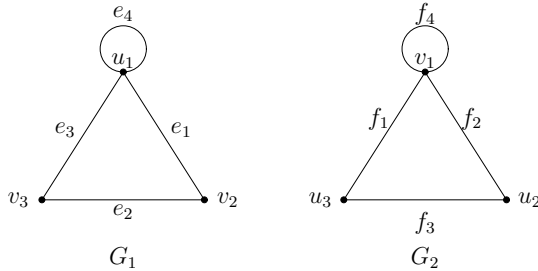

Fig. 1.4.2

Define a mapping $\phi : E_1 \cup V_1 \rightarrow E_2 \cup V_2$ by

$$\phi(e_1) = f_2, \phi(e_2) = f_3, \phi(e_3) = f_1, \phi(e_4) = f_4$$

and $\phi(v_i) = u_i$ for $1 \leq i \leq 3$. It can be verified immediately that $\phi I_1(e) = I_2\phi(e)$

for $\forall e \in E_1$. Therefore, ϕ is an isomorphism between G_1 and G_2 , i.e., G_1 and G_2 are isomorphic.

If $G_1 = G_2 = G$, an isomorphism between G_1 and G_2 is called an *automorphism of G* . All automorphisms of a graph G form a group under the composition operation, i.e., $\phi\theta(x) = \phi(\theta(x))$, where $x \in E(G) \cup V(G)$. We denote this automorphism group by $\text{Aut}G$.

For a simple graph G of n vertices, it can be verified that $\text{Aut}G \leq S_n$, the symmetry group action on n vertices of G . But for non-simple graph, the situation is more complex. For example, the automorphism groups of graphs K_m and B_n shown in Fig.1.4.3, respectively called *complete graphs* and *bouquets*, are $\text{Aut}K_m = S_m$ and $\text{Aut}B_n = S_n$, where $m = |V(K_m)|$ and $n = |E(B_n)|$.

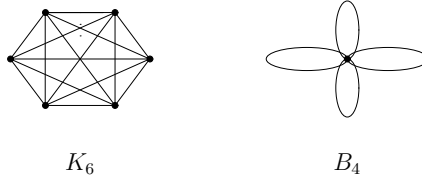

Fig. 1.4.3

1.4.2 Subgraph. A graph $H = (V_1, E_1; I_1)$ is a *subgraph* of a graph $G = (V, E; I)$ if $V_1 \subseteq V$, $E_1 \subseteq E$ and $I_1 : E_1 \rightarrow V_1 \times V_1$. We use $H \subset G$ to denote that H is a subgraph of G . For example, graphs G_1, G_2, G_3 are subgraphs of the graph G in Fig.1.4.4.

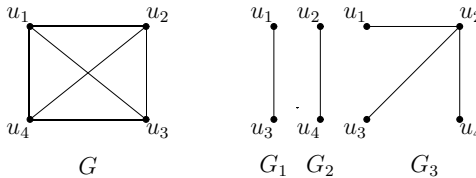

Fig. 1.4.4

For a nonempty subset U of the vertex set $V(G)$ of a graph G , the subgraph $\langle U \rangle$ of G *induced* by U is a graph having vertex set U and whose edge set consists of these edges of G incident with elements of U . A subgraph H of G is called *vertex-*

induced if $H \cong \langle U \rangle$ for some subset U of $V(G)$. Similarly, for a nonempty subset F of $E(G)$, the subgraph $\langle F \rangle$ induced by F in G is a graph having edge set F and whose vertex set consists of vertices of G incident with at least one edge of F . A subgraph H of G is *edge-induced* if $H \cong \langle F \rangle$ for some subset F of $E(G)$. In Fig.3.6, subgraphs G_1 and G_2 are both vertex-induced subgraphs $\langle \{u_1, u_4\} \rangle, \langle \{u_2, u_3\} \rangle$ and edge-induced subgraphs $\langle \{(u_1, u_4)\} \rangle, \langle \{(u_2, u_3)\} \rangle$.

For a subgraph H of G , if $|V(H)| = |V(G)|$, then H is called a *spanning subgraph* of G . In Fig.4.6, the subgraph G_3 is a spanning subgraph of the graph G .

A complete subgraph of a graph is called a *clique*, and its a k -regular vertex-spanning subgraph also called a *k-factor*.

1.4.3 Labeled Graph. A *labeled graph* on a graph $G = (V, E; I)$ is a mapping $\theta_L : V \cup E \rightarrow L$ for a label set L , denoted by G^L . If $\theta_L : E \rightarrow \emptyset$ or $\theta_L : V \rightarrow \emptyset$, then G^L is called a *vertex labeled graph* or an *edge labeled graph*, denoted by G^V or G^E , respectively. Otherwise, it is called a *vertex-edge labeled graph*. For example, two vertex-edge labeled graphs on K_4 are shown in Fig.1.4.5.

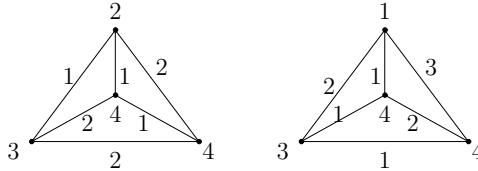

Fig.1.4.5

Two labeled graphs $G_1^{L_1}, G_2^{L_2}$ are *equivalent*, denoted by $G_1^{L_1} \cong G_2^{L_2}$ if there is an isomorphism $\tau : G_1 \rightarrow G_2$ such that $\tau\theta_{L_1}(x) = \theta_{L_2}\tau(x)$ for $\forall x \in V(G_1) \cup E(G_1)$. Whence, we usually consider non-equivalently labeled graphs on a given graph G .

1.4.4 Graph Families. Some important graph families are introduced in the following.

C1 Forest. A graph without circuits is called a *forest*, and a *tree* if it is connected. A vertex u in a forest F is called a *pendent vertex* if $\rho_F(u) = 1$. The following characteristic for trees is well-known and can be checked by definition.

Theorem 1.4.1 *A graph G is a tree if and only if G is connected and $E(G) = |V(G)| - 1$.*

C2. Hamiltonian graph. A graph G is *hamiltonian* if it has a circuit, called a *hamiltonian circuit* containing all vertices of G . Similarly, a path containing all vertices of a graph G is called a *hamiltonian path*.

C3. Bouquet and dipole. A graph $B_n = (V_b, E_b; I_b)$ with $V_b = \{O\}$, $E_b = \{e_1, e_2, \dots, e_n\}$ and $I_b(e_i) = (O, O)$ for any integer $i, 1 \leq i \leq n$ is called a *bouquet* of n edges. Similarly, a graph $D_{s,l,t} = (V_d, E_d; I_d)$ is called a *dipole* if $V_d = \{O_1, O_2\}$, $E_d = \{e_1, e_2, \dots, e_s, e_{s+1}, \dots, e_{s+l}, e_{s+l+1}, \dots, e_{s+l+t}\}$ and

$$I_d(e_i) = \begin{cases} (O_1, O_1), & \text{if } 1 \leq i \leq s, \\ (O_1, O_2), & \text{if } s+1 \leq i \leq s+l, \\ (O_2, O_2), & \text{if } s+l+1 \leq i \leq s+l+t. \end{cases}$$

For example, B_3 and $D_{2,3,2}$ are shown in Fig.1.4.6.

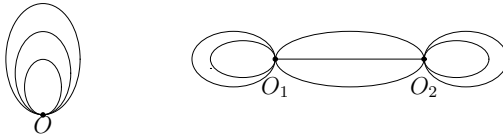

Fig. 1.4.6

The behavior of bouquets on surfaces fascinated many mathematicians attention. By a combinatorial view, these connected sums of tori, or these connected sums of projective planes used in topology are just bouquets on surfaces with one face.

C4. Complete graph. A *complete graph* $K_n = (V_c, E_c; I_c)$ is a simple graph with $V_c = \{v_1, v_2, \dots, v_n\}$, $E_c = \{e_{ij}, 1 \leq i, j \leq n, i \neq j\}$ and $I_c(e_{ij}) = (v_i, v_j)$. Since K_n is simple, it can be also defined by a pair (V, E) with $V = \{v_1, v_2, \dots, v_n\}$ and $E = \{v_i v_j, 1 \leq i, j \leq n, i \neq j\}$. The one edge graph K_2 and the triangle graph K_3 are both complete graphs. An example K_6 is shown in Fig.4.3.

C5. Multi-partite graph. A simple graph $G = (V, E; I)$ is *r-partite* for an integer $r \geq 1$ if it is possible to partition V into r subsets V_1, V_2, \dots, V_r such that for $\forall e \in E, I(e) = (v_i, v_j)$ for $v_i \in V_i, v_j \in V_j$ and $i \neq j, 1 \leq i, j \leq r$.

For $n = 2$, a 2-partite graph is also called a *bipartite graph*. It can be shown that a graph is bipartite if and only if there are no odd circuits in this graph. As a

consequence, a tree or a forest is a bipartite graph since both of them are circuit-free.

Let $G = (V, E; I)$ be an r -partite graph and V_1, V_2, \dots, V_r its r -partite vertex subsets. If there is an edge $e_{ij} \in E$ for $\forall v_i \in V_i$ and $\forall v_j \in V_j$, where $1 \leq i, j \leq r, i \neq j$ such that $I(e) = (v_i, v_j)$, then G is called a *complete r -partite graph*, denoted by $G = K(|V_1|, |V_2|, \dots, |V_r|)$. By this definition, a complete graph is nothing but a complete 1-partite graph.

C6. Regular graph. A graph G is *regular of valency k* if $\rho_G(u) = k$ for $\forall u \in V(G)$. These graphs are also called *k -regular*. A 3-regular graph is often referred to a *cubic graph*.

C7. Planar graph. A graph is *planar* if it can be drawn on the plane in such a way that edges are disjoint except possibly for endpoints. When we remove vertices and edges of a planar graph G from the plane, each remained connected region is called a *face* of G . The length of the boundary of a face is called its *valency*. Two planar graphs are shown in Fig.1.4.7.

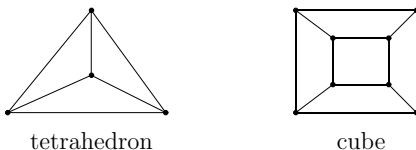

Fig. 1.4.7

C8. Embedded graph. A graph G is embeddable into a topological space \mathcal{R} if there is a one-to-one continuous mapping $f : G \rightarrow \mathcal{R}$ in such a way that edges are disjoint except possibly on endpoints. A *embedded graph on a topological space \mathcal{R}* is a graph embeddable on this space.

Many research works are concentrated on graphs on surfaces, which brings about two trends, i.e., *topological graph theory* and *combinatorial map theory*. Readers can find more information in references [GrT1], [Liu1]-[Liu3], [Mao1], [MoT1], [Tut1] and [Whi1].

1.4.5 Operations on Graphs. A *union* $G_1 \cup G_2$ of graphs G_1 with G_2 is defined by

$$V(G_1 \cup G_2) = V_1 \cup V_2, E(G_1 \cup G_2) = E_1 \cup E_2, I(E_1 \cup E_2) = I_1(E_1) \cup I_2(E_2).$$

A graph consists of k disjoint copies of a graph H , $k \geq 1$ is denoted by $G = kH$. As an example, we find that

$$K_6 = \bigcup_{i=1}^5 S_{1,i}$$

for graphs shown in Fig.1.4.8 following

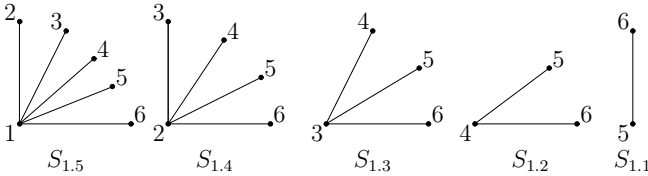

Fig. 1.4.8

and generally, $K_n = \bigcup_{i=1}^{n-1} S_{1,i}$. Notice that kG is a multigraph with edge multiple k for any integer $k, k \geq 2$ and a simple graph G .

A complement \overline{G} of a graph G is a graph with vertex set $V(G)$ such that vertices are adjacent in \overline{G} if and only if these are not adjacent in G . A join $G_1 + G_2$ of G_1 with G_2 is defined by

$$V(G_1 + G_2) = V(G_1) \cup V(G_2),$$

$$E(G_1 + G_2) = E(G_1) \cup E(G_2) \cup \{(u, v) | u \in V(G_1), v \in V(G_2)\}$$

and

$$I(G_1 + G_2) = I(G_1) \cup I(G_2) \cup \{I(u, v) = (u, v) | u \in V(G_1), v \in V(G_2)\}.$$

Applying the join operation, we know that

$$K(m, n) \cong \overline{K_m} + \overline{K_n}.$$

A cartesian product $G_1 \times G_2$ of graphs G_1 with G_2 is defined by $V(G_1 \times G_2) = V(G_1) \times V(G_2)$ and two vertices (u_1, u_2) and (v_1, v_2) of $G_1 \times G_2$ are adjacent if and only if either $u_1 = v_1$ and $(u_2, v_2) \in E(G_2)$ or $u_2 = v_2$ and $(u_1, v_1) \in E(G_1)$.

§1.5 ENUMERATION

1.5.1 Enumeration Principle. The *enumeration problem* on a finite set is to count and find closed formula for elements in this set. A fundamental principle for solving this problem in general is on account of the enumeration principle:

for finite sets X and Y , the equality $|X| = |Y|$ holds if and only if there is a bijection $f : X \rightarrow Y$.

Certainly, if the set Y can be easily countable, then we can find a closed formula for elements in X .

1.5.2 Inclusion-exclusion principle. By definition, the following equalities on sets X and Y are known.

$$|X \times Y| = |X||Y|,$$

$$|X \cup Y| = |X| + |Y| - |X \cap Y|.$$

Usually, the first equality is called the *product principle* and the second, *inclusion-exclusion principle* can be generalized to n sets X_1, X_2, \dots, X_n .

Theorem 1.5.1 *Let X_1, X_2, \dots, X_n be finite sets. Then*

$$\left| \bigcup_{i=1}^n X_i \right| = \sum_{s=1}^n (-1)^{s+1} \sum_{\{i_1, \dots, i_s\} \subseteq \{1, 2, \dots, n\}} |X_{i_1} \cap X_{i_2} \cap \dots \cap X_{i_s}|.$$

Proof To prove this equality, assume an element $x \in \bigcup_{i=1}^n X_i$ is exactly appearing in s sets $X_{i_1}, X_{i_2}, \dots, X_{i_s}$. Then it is counted s times in $\sum_{j=1}^s |X_{i_j}|$, and $\binom{s}{2}$ times in $\sum_{l_1, l_2 \in \{i_1, \dots, i_s\}} |X_{l_1} \cap X_{l_2}|$, \dots , etc.. Generally, for any integers $k \leq s$, it is counted $\binom{s}{k}$ times in

$$\sum_{l_1, \dots, l_k \in \{i_1, \dots, i_s\}} |X_{l_1} \cap X_{l_2} \cap \dots \cap X_{l_k}|.$$

To sum up, it is counted

$$\binom{s}{1} - \binom{s}{2} + \cdots + (-1)^s \binom{s}{s} = 1 - (1-1)^s = 1$$

times in

$$\sum_{s=1}^n (-1)^{s+1} \sum_{\{i_1, \dots, i_s\} \subseteq \{1, 2, \dots, n\}} |X_{i_1} \cap X_{i_2} \cap \cdots \cap X_{i_s}|.$$

Whence, we get

$$\left| \bigcup_{i=1}^n X_i \right| = \sum_{s=1}^n (-1)^s \sum_{\{i_1, \dots, i_s\} \subseteq \{1, 2, \dots, n\}} |X_{i_1} \cap X_{i_2} \cap \cdots \cap X_{i_s}|$$

by the enumeration principle. \square

The inclusion-exclusion principle is very useful in dealing with enumeration problems. For example, an Euler function φ is an mapping $\varphi : \mathbf{Z}^+ \rightarrow \mathbf{Z}$ on the integer set \mathbf{Z}^+ given by

$$\varphi(n) = |\{k \in \mathbf{Z} | 0 < k \leq n \text{ and } (k, n) = 1\}|,$$

for any integer $n \in \mathbf{Z}^n$, where (k, n) is the maximum common divisor of k and n .

Assume all prime divisors in n are p_1, p_2, \dots, p_l and define

$$X_i = \{k \in \mathbf{Z} | 0 < k \leq n \text{ and } (k, n) = p_i\},$$

for any integer $i, 1 \leq i \leq l$. Then by the inclusion-exclusion principle, we find that

$$\begin{aligned} \varphi(n) &= |\{k \in \mathbf{Z} | 0 < k \leq n \text{ and } (k, n) = 1\}| \\ &= |\{1, 2, \dots, n\} \setminus \left(\bigcup_i X_i \right)| \\ &= n - \sum_{s=1}^n (-1)^s \sum_{\{i_1, \dots, i_s\} \subseteq \{1, 2, \dots, l\}} |X_{i_1} \cap X_{i_2} \cap \cdots \cap X_{i_s}| \\ &= n \left[1 - \sum_{1 \leq i \leq l} \frac{1}{p_i} + \sum_{1 \leq i, j \leq l} \frac{1}{p_i p_j} - \cdots + (-1)^l \frac{1}{p_1 p_2 \cdots p_l} \right] \\ &= n \left(1 - \frac{1}{p_1} \right) \left(1 - \frac{1}{p_2} \right) \cdots \left(1 - \frac{1}{p_l} \right) \end{aligned}$$

$$= n \prod_{i=1}^l \left(1 - \frac{1}{p_i}\right).$$

1.5.3 Enumerating Mappings. This subsection concentrates on the enumeration of bijections, injections and surjections from a given set X to Y . For convenience, define three sets

$$Bij(Y^X) = \{f \in Y^X | f \text{ is an bijection}\},$$

$$Inj(Y^X) = \{f \in Y^X | f \text{ is an injection}\},$$

$$Sur(Y^X) = \{f \in Y^X | f \text{ is an surjection}\}.$$

Then, we immediately get

Theorem 1.5.2 *Let X and Y be finite sets. Then*

$$|Bij(Y^X)| = \begin{cases} 0 & \text{if } |X| \neq |Y|, \\ |Y|! & \text{if } |X| = |Y| \end{cases}$$

and

$$|Inj(Y^X)| = \begin{cases} 0 & \text{if } |X| > |Y|, \\ \frac{|Y|!}{(|Y|-|X|)!} & \text{if } |X| \leq |Y|. \end{cases}$$

Proof If $|X| \neq |Y|$, there are no bijections from X to Y by definition. Whence, we only need to consider the case of $|X| = |Y|$. Let $X = \{x_1, x_2, \dots, x_n\}$ and $Y = \{y_1, y_2, \dots, y_n\}$. For any permutation p on y_1, y_2, \dots, y_n , the mapping determined by

$$\begin{pmatrix} x_1 & x_2 & \cdots & x_n \\ p(y_1) & p(y_2) & \cdots & p(y_n) \end{pmatrix}$$

is a bijection from X to Y , and vice versa. Whence,

$$|Bij(Y^X)| = \begin{cases} 0 & \text{if } |X| \neq |Y|, \\ n! = |Y|! & \text{if } |X| = |Y| \end{cases}$$

Similarly, if $|X| > |Y|$, there are no injections from X to Y by definition. Whence, we only need to consider the case of $|X| \leq |Y|$. For any subset $Y' \subseteq Y$ with $|Y'| = |X|$, notice that there are $|Y'|! = |X|!$ bijections from X to Y' , i.e., $|X|!$

surjections from X to Y . Now there are $\binom{|Y|}{|X|}$ ways choosing the subset Y' in Y . Therefore, the number $|Inj(Y^X)|$ of surjections from X to Y is

$$\binom{|Y|}{|X|} |X|^{|Y|} = \frac{|Y|^{|X|}}{(|Y|^{|Y|} - |X|^{|Y|})}.$$

This completes the proof. \square

The situation for $|Sur(Y^X)|$ is more complicated than these cases of determining $|Bij(Y^X)|$ and $|Inj(Y^X)|$, which need to apply the inclusion-exclusion principle with techniques.

Theorem 1.5.3 *Let X and Y be finite sets. Then*

$$|Sur(Y^X)| = (-1)^{|Y|} \sum_{i=0}^{|Y|} (-1)^i \binom{|Y|}{i} i^{|X|}.$$

Proof For any sets $X = \{x_1, x_2, \dots, x_n\}$ and Y , by the product principle we know that

$$\begin{aligned} |Y^X| &= |Y^{\{x_1\}} \times Y^{\{x_2\}} \times \dots \times Y^{\{x_n\}}| \\ &= |Y^{\{x_1\}}| |Y^{\{x_2\}}| \dots |Y^{\{x_n\}}| = |Y|^{|X|}. \end{aligned}$$

Now let $\Phi : Y^X \rightarrow \mathcal{P}(Y)$ be a mapping defined by

$$\Phi(f) = Y \cup f(X) - Y \cap f(X).$$

Notice that $f \in Sur(Y^X)$ is a surjection if and only if $\Phi(f) = \emptyset$. For any subset $S \subseteq Y$, let

$$X_S = \{f \in Y^X | S \subseteq \Phi(f)\}.$$

Then calculation shows that

$$\begin{aligned} |X_S| &= |\{f \in Y^X | S \subseteq \Phi(f)\}| \\ &= |\{f \in Y^X | f(X) \subseteq Y \cup S - Y \cap S\}| \\ &= |Y \cup S - Y \cap S|^{|X|} = (|Y| - |S|)^{|X|}. \end{aligned}$$

Applying the inclusion-exclusion principle, we find that

$$\begin{aligned}
 |Sur(Y^X)| &= |Y^X \setminus \bigcup_{\emptyset \neq S \subseteq Y} X_S| \\
 &= |Y^X| - \sum_{i=1}^{|Y|} (-1)^{|S|} (|Y| - |S|)^{|X|} \\
 &= \sum_{i=0}^{|Y|} (-1)^i \sum_{|S|=i} (|Y| - i)^{|X|} \\
 &= \sum_{i=0}^{|Y|} (-1)^i \binom{|Y|}{i} (|Y| - i)^{|X|} \\
 &= (-1)^{|Y|} \sum_{i=0}^{|Y|} (-1)^i \binom{|Y|}{i} i^{|X|}.
 \end{aligned}$$

The last equality applies the fact $\binom{|Y|}{i} = \binom{|Y|}{|Y| - i}$ on binomial coefficients. □

1.5.4 Enumerating Labeled Graphs. For a given graph G and a labeled set L , can how many non-equivalent labeled graphs G^L be obtained? We know the result following.

Theorem 1.5.4 *Let G be a graph and L a finite labeled set. Then there are*

$$\frac{|L|^{|V(G)|+|E(G)|}}{|\text{Aut}G|^2}$$

non-equivalent labeled graphs by labeling $\theta_L : V(G) \cup E(G) \rightarrow L$.

Proof A vertex-edge labeled graph on a graph can be obtained in two steps. The first is labeling its vertices. The second is labeling its edges on its vertex labeled graph. Notice there are $|L|^{|V(G)|}$ vertex labelings $\theta_L : V(G) \rightarrow L$. If there is an automorphism $f \in \text{Aut}G$ such that $(G^V)^f = G^V$, then it can show easily that $f = 1_{\text{Aut}G}$, i.e., $|(\text{Aut}G)_{G^V}| = 1$. Applying a famous result in permutation groups, i.e., $|\Gamma_x||x^\Gamma| = |\Gamma|$ for any finite permutation group Γ and $x \in \Gamma$, we know that the orbital length of G^V under the action of $\text{Aut}G$ is $|\text{Aut}G|$. Therefore, there are

$$\frac{|L|^{|V(G)|}}{|\text{Aut}G|}$$

non-equivalent vertex labeled graphs by labeling $\theta_L : V(G) \rightarrow L$ on vertices in G .

Similarly, for a given vertex labeled graph G^V , there are

$$\frac{|L|^{|V(G)|}}{|\text{Aut}G|}$$

non-equivalent edge labeled graphs by labeling $\theta_L : E(G) \rightarrow L$ on edges in G .

Whence, applying the product principle for enumeration, we find there are

$$\frac{|L|^{|V(G)|+|E(G)|}}{|\text{Aut}G|^2}$$

non-equivalent labeled graphs by labeling $\theta_L : V(G) \cup E(G) \rightarrow L$. □

If each element in L appears one times at most, i.e. $|\theta_L(x) \cap L| \leq 1$ for $\forall x \in V(G) \cup E(G)$, then $|L| \geq |V(G)| + |E(G)|$ if there exist such labeling. In this case, there are

$$\binom{|L|}{|V(G)| + |E(G)|}$$

labelings $\theta_L : V(G) \cup E(G) \rightarrow L$ with $|\theta_L(x) \cap L| \leq 1$. Particularly, choose $|L| = |V(G)| + |E(G)|$ as usual, then there are $(|V(G)| + |E(G)|)!$ such labelings. Similar to Theorem 1.5.4, we know the result following.

Theorem 1.5.5 *Let G be a graph and L a finite labeled set with $|L| \geq |V(G)| + |E(G)|$. Then there are*

$$\frac{\binom{|L|}{|V(G)| + |E(G)|}}{|\text{Aut}G|^2}$$

non-equivalent labeled graphs by labeling $\theta_L : V(G) \cup E(G) \rightarrow L$ with $|\theta_L(x) \cap L| \leq 1$, and particularly

$$\frac{(|V(G)| + |E(G)|)!}{|\text{Aut}G|^2}$$

non-equivalent labeled graphs if $|L| = |V(G)| + |E(G)|$. □

For vertex or edge labeled graphs,i.e., $|L| = |V(G)|$ or $|L| = |E(G)|$, we can get similar results on the numbers of non-equivalent such labeled graphs shown in the following.

Corollary 1.5.1 *Let G be a graph. Then there are*

$$\frac{|V(G)|!}{|\text{Aut}G|} \quad \text{or} \quad \frac{|E(G)|!}{|\text{Aut}G|}$$

non-equivalent vertex or edge labeled graphs.

There is a closed formula for the number of non-equivalent vertex-edge labeled trees with a given order, shown in the following.

Theorem 1.5.6 *Let T be a tree of order p . Then there are*

$$(2p - 1)^{p-2}(p + 1)!$$

non-equivalent vertex-edge labeled trees.

Proof Let T be a vertex-edge labeled tree with a label set $L = \{1, 2, \dots, 2p-1\}$. Remove the pendent vertex having the smallest label a_1 and the incident edge with label c_1 . Assume that b_1 was the vertex adjacent to a_1 . Among the remaining $p - 1$ vertices let a_2 be the pendent vertex with the smallest label and b_2 the vertex adjacent to a_2 . Remove the edge (a_2, b_2) with label c_2 . Repeated this programming on the remaining $p-2$ vertices, and then on $p-3$ vertices, and so on. It is terminated after $p - 2$ steps as only two vertices are left. Then the vertex-edge labeled tree uniquely defines two sequences

$$(b_1, b_2, \dots, b_{p-2}), \tag{5.1}$$

$$(c_1, c_2, \dots, c_{p-2}, c_{p-1}), \tag{5.2}$$

where c_{p-1} is the label on the edge connecting the last two vertices. For example, the sequences (5.1) and (5.2) are respective $(1, 1, 4)$ and $(6, 7, 8, 9)$ for the tree shown in Fig.1.5.1.

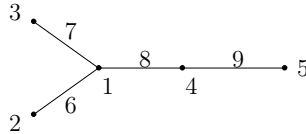

Fig.1.5.1

Conversely, given sequences $(b_1, b_2, \dots, b_{p-2})$ and $(c_1, c_2, \dots, c_{p-1})$ of $2p - 3$ labels, a vertex-edge labeled tree of order p can be uniquely constructed as follows.

First, determine the first number in $1, 2, 3, \dots, 2p - 1$ that does not appear in $(b_1, b_2, \dots, b_{p-2})$, say a_1 and define an edge (a_1, b_1) with a label c_1 . Removing b_1, c_1 from these sequences. Find a smallest number not appearing in the remaining sequence $(b_2, c_2, \dots, b_{p-2}, c_{p-2})$, say a_2 and define an edge (a_2, b_2) with a label c_2 . This construction is continued until there are no element left. At the final, the last two elements remaining in L are connected with the label c_{p-1} .

For each of the $p - 2$ elements in the sequence $(5 - 1)$, we can choose any one of numbers in L , thus

$$(2p - 1)^{p-2}$$

$(p - 2)$ -tuples. For the remained two vertices and elements in the sequence $(5 - 2)$, we have

$$\binom{p + 1}{p - 1} 2! = (p + 1)!$$

choices. Therefore, there are

$$(2p - 1)^{p-2}(p + 1)!$$

such different pairs $(5 - 1)$ and $(5 - 2)$. Notice that each of them defines a district vertex-edge labeled tree of p vertices. Since each vertex-edge labeled tree uniquely defines a pair of there sequences and vice versa. We find the number of vertex-edge labeled trees of order p asserted in this theorem. \square

Similarly, for vertex labeled tress we can also get the number of such trees of order p , which was firstly gotten by Cayley in 1889 shown in the next result.

Theorem 1.5.6(Cayley, 1889) *Let T be a tree of order p . Then there are p^{p-2} non-equivalent vertex labeled trees.* \square

These enumerating results in Theorems 1.5.5 – 1.5.6 can be rewritten in equalities combining with Theorem 5.4 and Corollary 1.5.1.

Corollary 1.5.2 *Let $\mathcal{T}(p-1)$ be a set of trees of order p . Then*

$$\sum_{T \in \mathcal{T}(p-1)} \frac{1}{|\text{Aut}T|} = \frac{p^{p-2}}{p!}$$

and

$$\sum_{T \in \mathcal{T}(p-1)} \frac{1}{|\text{Aut}T|^2} = \frac{(2p-1)^{p-2}(p+1)!}{(2p-1)!}.$$

These equalities are interesting, which present closed formulae for automorphism groups of trees with given size. The first equality in Corollary 1.5.2 was first noted by Babai in 1974.

§1.6 REMARKS

1.6.1. Combinatorics has made great progress in the 20th century with many important results found. Essentially, it can be seen as an extending subject on sets or a branch of algebra with some one’s intuition, such as these graphs. But it is indeed come into being under the logic, namely, a subject of mathematics. For materials in Sections 1.1 – 1.3, further information and results can be found in references [BiM1], [Hua1] and [NiD1]. The concept of *multi-set* and *multi-poset* are introduced here by Smarandache’s notion in [Sma1]. Sections 1.4 – 1.5 are a brief introduction to graphs and enumerating techniques. More results and techniques can be found in reference [BoM1], [CaM1], [ChL1], [GrW1] and [Tut1], etc. for readers interesting in combinatorics with applications.

1.6.2 The research on multi-poset proposed in Section 3 is an application of the combinatorial notion, i.e., combining different fields into a unifying one. It needs both of the knowledge of posets and combinatorics, namely, posets with combina-

torial structure. Further research on multi-poset will enrich one's knowledge on posets.

1.6.3 These graph families enumerated in Section 4 is not complete. It only presents common families or frequently met in papers on graphs. But for $C8$, i.e., embedded graphs, more words should be added in here. Generally, an *embedded graph on a topological space* \mathcal{R} is a one-to-one continuous mapping $f : G \rightarrow \mathcal{R}$ in such a way that edges are disjoint except possibly on endpoints, namely, a 1-CW complex embedded in a topological space [Grü1]. In last century, many researches are concentrated on the case of \mathcal{R} being a surface, i.e., a closed 2-manifold. In fact, the terminology *embedded graph* is usually means a graph embedded on a surface, not in a general topological space. For this spacial case, more and more techniques beyond combinatorics are applied, for example, [GrT1], [Whi1] and [Mao1] apply topology with algebra, particularly, automorphism groups, [Liu1]-[Liu3] use topology with algebra, algorithm, mathematical analysis, particularly, functional equations and [MoT1] adopts combinatorial topology. Certainly, there are many open problems in this field. Beyond embedded graphs on surfaces, few results are observable on publications for embedded graphs in a topological space, not these surfaces.

1.6.4 The identity of automorphism groups of trees

$$\sum_{T \in \mathcal{T}_{(p-1)}} \frac{1}{|\text{Aut}T|^2} = \frac{(2p-1)^{p-2}(p+1)!}{(2p-1)!}$$

in Corollary 1.5.2 is a new identity. Generally, two different ways of enumeration on a given configuration induce a combinatorial identity. In [MaL1], we also know an identity of automorphism groups of trees different from these in Corollary 1.5.2, i.e.,

$$\sum_{T \in \mathcal{T}(n)} \frac{\prod_{d \in D(T)} (d-1)!}{|\text{Aut}T|} = \frac{(2n-1)!}{n!(n+1)!},$$

where $\mathcal{T}(n)$, $D(T)$ denote the set of trees of order n and the valency sequence of a tree T , respectively.

1.6.5 It should be noted that all objects in combinatorics are without metrics, which enables its results concise and formulae with mathematical beauty. But this

is only beneficial for pure or classical combinatorics, not the entirety of mathematics or sciences for its lack of metrics. The goal of combinatorics is to find combinatorial counterpart in mathematics, not just these results only with purely combinatorial importance. For its contribution to the entire science, a good idea is pull-back these metrics ignored in classical combinatorics to construct the *mathematical combinatorics* suggested by the author in [Mao1]. The reference [Mao2] is such a monograph with Smarandache multi-spaces. In fact, the material in the following chapters is on mathematical combinatorics, particularly on *combinatorial differential geometry* and its application, i.e., *combinatorial fields* in theoretical physics.

CHAPTER 2.

Fundamental of Mathematical Combinatorics

One increasingly realizes that our world is not an individual but a multiple or combinatorial one, which enables modern sciences overlap and hybrid, i.e., with a combinatorial structure. To be consistency with the science development, the mathematics should be also combinatorial, not just the classical combinatorics without metrics, but the *mathematical combinatorics* resulting in the combinatorial conjecture for mathematics, i.e., *mathematical science can be reconstructed from or made by combinatorialization* presented by the author in 2005. The importance of this conjecture is not in it being an open problem, but in its role for advancing mathematics. For introducing more readers known this heartening combinatorial notion for mathematical sciences, this chapter introduces the *combinatorial algebraic theory*. Other fields followed from this notion, such as those of *Smarandache geometries* and *combinatorial differential geometry* are shown in the following chapters.

§2.1 COMBINATORIAL SYSTEMS

2.1.1 Proposition in Logic. The multi-laterality of our WORLD implies multi-systems to be its best candidate model for ones cognition on the WORLD. This is also included in a well-known Chinese ancient book *TAO TEH KING* written by *LAO ZI*. In this book we can find many sentences for cognition of our WORLD, such as those of the following ([Luj1]-[Luj2],[Sim1]).

SENTENCE 1. *All things that we can acknowledge is determined by our eyes, or ears, or nose, or tongue, or body or passions, i.e., these six organs.* Such as those shown in Fig.2.1.1.

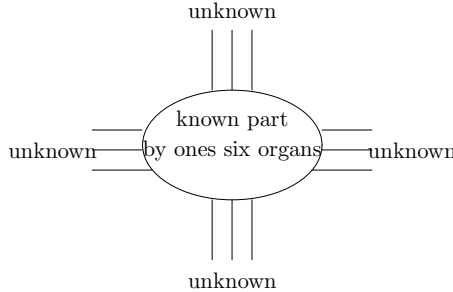

Fig.2.1.1

SENTENCE 2. *The Tao gives birth to One. One gives birth to Two. Two gives birth to Three. Three gives birth to all things. All things have their backs to the female and stand facing the male. When male and female combine, all things achieve harmony.* Shown in Fig.2.1.2.

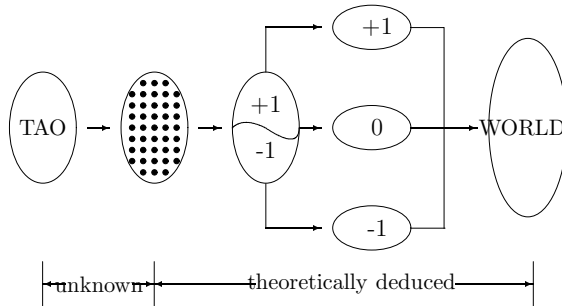

Fig.2.1.2

SENTENCE 3. *Mankind follows the earth. Earth follows the universe. The universe follows the Tao. The Tao follows only itself.* Such as those shown in Fig.2.1.3.

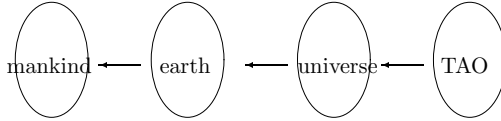

Fig.2.1.3

SENTENCE 4. *Have and Not have exist jointly ahead of the birth of the earth and the sky.* This means that any thing have two sides. One is the positive. Another is the negative. We can not say a thing existing or not just by our six organs because its existence independent on our living.

What can we learn from these words? All these sentences mean that our world is a multi-one. For characterizing its behavior, We should construct a multi-system model for the WORLD, also called parallel universes ([Mao3], [Teg1]), such as those shown in Fig.2.1.4.

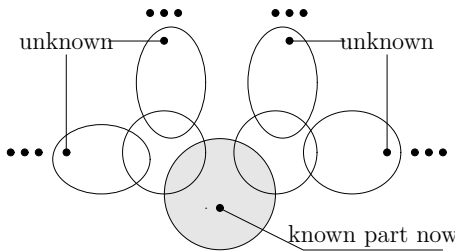

Fig.2.1.4

How can we apply these sentences in mathematics of the 21st century? We make some analysis on this question by mathematical logic following.

A *proposition* p on a set Σ is a declarative sentence on elements in Σ that is either true or false but not both. The statements *it is not the case that* p and *it is the opposite case that* p are still propositions, called the *negation* or *anti-proposition* of p , denoted by $\text{non-}p$ or $\text{anti-}p$, respectively. Generally, $\text{non-}p \neq \text{anti-}p$. The structure of $\text{anti-}p$ is very clear, but $\text{non-}p$ is not. An oppositive or negation of a

proposition are shown in Fig.2.1.5.

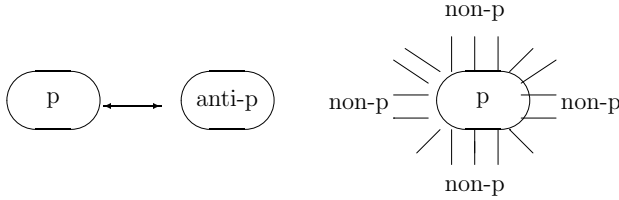

Fig.2.1.5

For a given proposition, *what can we say it is true or false?* A proposition and its non-proposition jointly exist in the world. Its truth or false can be only decided by logic inference, independent on one knowing it or not.

A norm inference is called implication. An *implication* $p \rightarrow q$, i.e., *if p then q*, is a proposition that is false when p is true but q false and true otherwise. There are three propositions related with $p \rightarrow q$, namely, $q \rightarrow p$, $\neg q \rightarrow \neg p$ and $\neg p \rightarrow \neg q$, called the *converse*, *contrapositive* and *inverse* of $p \rightarrow q$. Two propositions are called *equivalent* if they have the same truth value. It can be shown immediately that *an implication and its contrapositive are equivalent*. This fact is commonly used in mathematical proofs, i.e., we can either prove the proposition $p \rightarrow q$ or $\neg q \rightarrow \neg p$ in the proof of $p \rightarrow q$, not the both.

2.1.2 Mathematical System. A *rule* on a set Σ is a mapping

$$\underbrace{\Sigma \times \Sigma \cdots \times \Sigma}_n \rightarrow \Sigma$$

for some integers n . A *mathematical system* is a pair $(\Sigma; \mathcal{R})$, where Σ is a set consisting mathematical objects, infinite or finite and \mathcal{R} is a collection of rules on Σ by logic providing all these resultants are still in Σ , i.e., elements in Σ is closed under rules in \mathcal{R} .

Two mathematical systems $(\Sigma_1; \mathcal{R}_1)$ and $(\Sigma_2; \mathcal{R}_2)$ are *isomorphic* if there is a 1 – 1 mapping $\omega : \Sigma_1 \rightarrow \Sigma_2$ such that for elements $a, b, \dots, c \in \Sigma_1$,

$$\omega(\mathcal{R}_1(a, b, \dots, c)) = \mathcal{R}_2(\omega(a), \omega(b), \dots, \omega(c)) \in \Sigma_2.$$

Generally, we do not distinguish isomorphic systems in mathematics. Examples

for mathematical systems are shown in the following.

Example 2.1.1 A group $(G; \circ)$ in classical algebra is a mathematical system $(\Sigma_G; \mathcal{R}_G)$, where $\Sigma_G = G$ and

$$\mathcal{R}_G = \{R_1^G; R_2^G, R_3^G\},$$

with

$$R_1^G: (x \circ y) \circ z = x \circ (y \circ z) \text{ for } \forall x, y, z \in G;$$

$$R_2^G: \text{there is an element } 1_G \in G \text{ such that } x \circ 1_G = x \text{ for } \forall x \in G;$$

$$R_3^G: \text{for } \forall x \in G, \text{ there is an element } y, y \in G, \text{ such that } x \circ y = 1_G.$$

Example 2.1.2 A ring $(R; +, \circ)$ with two binary closed operations “+”, “ \circ ” is a mathematical system $(\Sigma; \mathcal{R})$, where $\Sigma = R$ and $\mathcal{R} = \{R_1; R_2, R_3, R_4\}$ with

$$R_1: x + y, x \circ y \in R \text{ for } \forall x, y \in R;$$

$$R_2: (R; +) \text{ is a commutative group, i.e., } x + y = y + x \text{ for } \forall x, y \in R;$$

$$R_3: (R; \circ) \text{ is a semigroup};$$

$$R_4: x \circ (y + z) = x \circ y + x \circ z \text{ and } (x + y) \circ z = x \circ z + y \circ z \text{ for } \forall x, y, z \in R.$$

Example 2.1.3 a Euclidean geometry on the plane \mathbf{R}^2 is a mathematical system $(\Sigma_E; \mathcal{R}_E)$, where $\Sigma_E = \{\text{points and lines on } \mathbf{R}^2\}$ and $\mathcal{R}_E = \{\text{Hilbert's 21 axioms on Euclidean geometry}\}$.

A mathematical $(\Sigma; \mathcal{R})$ can be constructed dependent on the set Σ or on rules \mathcal{R} . The former requires each rule in \mathcal{R} closed in Σ . But the later requires that $\mathcal{R}(a, b, \dots, c)$ in the final set $\widehat{\Sigma}$, which means that $\widehat{\Sigma}$ maybe an extended of the set Σ . In this case, we say $\widehat{\Sigma}$ is generated by Σ under rules \mathcal{R} , denoted by $\langle \Sigma; \mathcal{R} \rangle$.

Combining mathematical systems with the view of *LAO ZHI* in Subsection 2.1.1, we should construct these mathematical systems $(\Sigma; \mathcal{R})$ in which a proposition with its non-proposition validated turn up in the set Σ , or invalidated but in multiple ways in Σ .

Definition 2.1.1 A rule in a mathematical system $(\Sigma; \mathcal{R})$ is said to be *Smarandachely denied* if it behaves in at least two different ways within the same set Σ , i.e., validated and invalidated, or only invalidated but in multiple distinct ways.

A *Smarandache system* $(\Sigma; \mathcal{R})$ is a mathematical system which has at least one *Smarandachely denied* rule in \mathcal{R} .

Definition 2.1.2 For an integer $m \geq 2$, let $(\Sigma_1; \mathcal{R}_1), (\Sigma_2; \mathcal{R}_2), \dots, (\Sigma_m; \mathcal{R}_m)$ be m mathematical systems different two by two. A Smarandache multi-space is a pair $(\tilde{\Sigma}; \tilde{\mathcal{R}})$ with

$$\tilde{\Sigma} = \bigcup_{i=1}^m \Sigma_i, \quad \text{and} \quad \tilde{\mathcal{R}} = \bigcup_{i=1}^m \mathcal{R}_i.$$

Certainly, we can construct Smarandache systems by applying Smarandache multi-spaces, particularly, Smarandache geometries appeared in the next chapter.

2.1.3 Combinatorial System. These Smarandache systems $(\Sigma; \mathcal{R})$ defined in Definition 2.1.1 consider the behavior of a proposition and its non-proposition in the same set Σ without distinguishing the guises of these non-propositions. In fact, there are many appearing ways for non-propositions of a proposition in Σ . For describing their behavior, we need combinatorial systems.

Definition 2.1.3 A combinatorial system \mathcal{C}_G is a union of mathematical systems $(\Sigma_1; \mathcal{R}_1), (\Sigma_2; \mathcal{R}_2), \dots, (\Sigma_m; \mathcal{R}_m)$ for an integer m , i.e.,

$$\mathcal{C}_G = \left(\bigcup_{i=1}^m \Sigma_i; \bigcup_{i=1}^m \mathcal{R}_i \right)$$

with an underlying connected graph structure G , where

$$V(G) = \{\Sigma_1, \Sigma_2, \dots, \Sigma_m\},$$

$$E(G) = \{ (\Sigma_i, \Sigma_j) \mid \Sigma_i \cap \Sigma_j \neq \emptyset, 1 \leq i, j \leq m \}.$$

Unless its combinatorial structure G , these cardinalities $|\Sigma_i \cap \Sigma_j|$, called the *coupling constants* in a combinatorial system \mathcal{C}_G also determine its structure if $\Sigma_i \cap \Sigma_j \neq \emptyset$ for integers $1 \leq i, j \leq m$. For emphasizing its coupling constants, we denote a combinatorial system \mathcal{C}_G by $\mathcal{C}_G(l_{ij}, 1 \leq i, j \leq m)$ if $l_{ij} = |\Sigma_i \cap \Sigma_j| \neq 0$.

Let $\mathcal{C}_G^{(1)}$ and $\mathcal{C}_G^{(2)}$ be two combinatorial systems with

$$\mathcal{C}_G^{(1)} = \left(\bigcup_{i=1}^m \Sigma_i^{(1)}; \bigcup_{i=1}^m \mathcal{R}_i^{(1)} \right), \quad \mathcal{C}_G^{(2)} = \left(\bigcup_{i=1}^n \Sigma_i^{(2)}; \bigcup_{i=1}^n \mathcal{R}_i^{(2)} \right).$$

A homomorphism $\varpi : \mathcal{C}_G^{(1)} \rightarrow \mathcal{C}_G^{(2)}$ is a mapping $\varpi : \bigcup_{i=1}^m \Sigma_i^{(1)} \rightarrow \bigcup_{i=1}^n \Sigma_i^{(2)}$ and $\varpi :$

$\bigcup_{i=1}^m \mathcal{R}_i^{(1)} \rightarrow \bigcup_{i=1}^n \mathcal{R}_i^{(2)}$ such that

$$\varpi|_{\Sigma_i}(a\mathcal{R}_i^{(1)}b) = \varpi|_{\Sigma_i}(a)\varpi|_{\Sigma_i}(\mathcal{R}_i^{(1)})\varpi|_{\Sigma_i}(b)$$

for $\forall a, b \in \Sigma_i^{(1)}$, $1 \leq i \leq m$, where $\varpi|_{\Sigma_i}$ denotes the constraint mapping of ϖ on the mathematical system $(\Sigma_i, \mathcal{R}_i)$. Further more, if $\varpi : \mathcal{C}_G^{(1)} \rightarrow \mathcal{C}_G^{(2)}$ is a 1-1 mapping, then we say these $\mathcal{C}_G^{(1)}$ and $\mathcal{C}_G^{(2)}$ are *isomorphic* with an isomorphism ϖ between them.

A homomorphism $\varpi : \mathcal{C}_G^{(1)} \rightarrow \mathcal{C}_G^{(2)}$ naturally induces a mappings $\varpi|_G$ on the graph G_1 and G_2 by

$$\varpi|_G : V(G_1) \rightarrow \varpi(V(G_1)) \subset V(G_2) \text{ and}$$

$$\varpi|_G : (\Sigma_i, \Sigma_j) \in E(G_1) \rightarrow (\varpi(\Sigma_i), \varpi(\Sigma_j)) \in E(G_2), 1 \leq i, j \leq m.$$

With these notations, a criterion for isomorphic combinatorial systems is presented in the following.

Theorem 2.1.1 *Two combinatorial systems $\mathcal{C}_G^{(1)}$ and $\mathcal{C}_G^{(2)}$ are isomorphic if and only if there is a 1-1 mapping $\varpi : \mathcal{C}_G^{(1)} \rightarrow \mathcal{C}_G^{(2)}$ such that*

(i) $\varpi|_{\Sigma_i^{(1)}}$ is an isomorphism and $\varpi|_{\Sigma_i^{(1)}}(x) = \varpi|_{\Sigma_j^{(1)}}(x)$ for $\forall x \in \Sigma_i^{(1)} \cap \Sigma_j^{(1)}$, $1 \leq i, j \leq m$;

(ii) $\varpi|_G : G_1 \rightarrow G_2$ is an isomorphism.

Proof If $\varpi : \mathcal{C}_G^{(1)} \rightarrow \mathcal{C}_G^{(2)}$ is an isomorphism, considering the constraint mappings of ϖ on the mathematical system $(\Sigma_i, \mathcal{R}_i)$ for an integer $i, 1 \leq i \leq m$ and the graph $G_1^{(1)}$, then we find isomorphisms $\varpi|_{\Sigma_i^{(1)}}$ and $\varpi|_G$.

Conversely, if these isomorphism $\varpi|_{\Sigma_i^{(1)}}, 1 \leq i \leq m$ and $\varpi|_G$ exist, we can construct a mapping $\varpi : \mathcal{C}_G^{(1)} \rightarrow \mathcal{C}_G^{(2)}$ by

$$\varpi(a) = \varpi|_{\Sigma_1}(a) \text{ if } a \in \Sigma_i \text{ and } \varpi(o) = \varpi|_{\Sigma_1}(o) \text{ if } o \in \mathcal{R}_i, 1 \leq i \leq m.$$

Then we know that

$$\varpi|_{\Sigma_i}(a\mathcal{R}_i^{(1)}b) = \varpi|_{\Sigma_i}(a)\varpi|_{\Sigma_i}(\mathcal{R}_i^{(1)})\varpi|_{\Sigma_i}(b)$$

for $\forall a, b \in \Sigma_i^{(1)}$, $1 \leq i \leq m$ by definition. Whence, $\varpi : \mathcal{C}_G^{(1)} \rightarrow \mathcal{C}_G^{(2)}$ is a homomorphism. Similarly, we can know that $\varpi^{-1} : \mathcal{C}_G^{(2)} \rightarrow \mathcal{C}_G^{(1)}$ is also an homomorphism. Therefore, ϖ is an isomorphism between $\mathcal{C}_G^{(1)}$ and $\mathcal{C}_G^{(2)}$. \square

For understanding well the multiple behavior of world, a combinatorial system should be constructed. Then *what is its relation with classical mathematical sciences? What is its developing way for mathematical sciences?* I presented an idea of combinatorial notion in Chapter 5 of [Mao1], then formally as the *combinatorial conjecture for mathematics* in [Mao4] and [Mao10], the later is reported at *the 2nd Conference on Combinatorics and Graph Theory of China* in 2006.

Combinatorial Conjecture *Any mathematical system $(\Sigma; \mathcal{R})$ is a combinatorial system $\mathcal{C}_G(l_{ij}, 1 \leq i, j \leq m)$.*

This conjecture is not just an open problem, but more likes a deeply thought, which opens a entirely way for advancing the modern mathematics and theoretical physics. In fact, it is an extending of *TAO TEH KING*, Smarandache's notion by combinatorics, but with more delicateness.

Here, we need further clarification for this conjecture. In fact, it indeed means a *combinatorial notion* on mathematical objects following for researchers.

(i) There is a combinatorial structure and finite rules for a classical mathematical system, which means one can make combinatorialization for all classical mathematical subjects.

(ii) One can generalizes a classical mathematical system by this combinatorial notion such that it is a particular case in this generalization.

(iii) One can make one combination of different branches in mathematics and find new results after then.

(iv) One can understand our WORLD by this combinatorial notion, establish combinatorial models for it and then find its behavior, for example,

what is true colors of the Universe, for instance its dimension?

This combinatorial notion enables ones to establish a combinatorial model for the WORLD, i.e., *combinatorial Euclidean spaces* (see Chapter 4 of this book) characterizing the WORLD, not like the classical physics by applying an isolated sphere model or a Euclidean space model.

Whence, researching on a mathematical system can not be ended if it has not been combinatorialization and all mathematical systems can not be ended if its combinatorialization has not completed yet.

§2.2 ALGEBRAIC SYSTEMS

2.2.1 Algebraic System. Let \mathcal{A} be a set and \circ an operation on \mathcal{A} . If $\circ : \mathcal{A} \times \mathcal{A} \rightarrow \mathcal{A}$, i.e., closed then we call \mathcal{A} an *algebraic system under the operation* \circ , denoted by $(\mathcal{A}; \circ)$. For example, let $\mathcal{A} = \{1, 2, 3\}$. Define operations \times_1, \times_2 on \mathcal{A} by following tables.

\times_1	1	2	3
1	1	2	3
2	2	3	1
3	3	1	2

\times_2	1	2	3
1	1	2	3
2	3	1	2
3	2	3	1

table 2.2.1

Then we get two algebraic systems $(\mathcal{A}; \times_1)$ and $(\mathcal{A}; \times_2)$. Notice that in an algebraic system $(\mathcal{A}; \circ)$, we can get an unique element $a \circ b \in \mathcal{A}$ for $\forall a, b \in \mathcal{A}$.

2.2.2 Associative and Commutative Law. We introduce the associative and commutative laws in the following definition.

Definition 2.2.1 *An algebraic system $(\mathcal{A}; \circ)$ is associative if*

$$(a \circ b) \circ c = a \circ (b \circ c)$$

for $\forall a, b, c \in \mathcal{A}$.

Definition 2.2.2 *An algebraic system $(\mathcal{A}; \circ)$ is commutative if*

$$a \circ b = b \circ a$$

for $\forall a, b \in \mathcal{A}$.

We know results for associative and commutative systems following.

Theorem 2.2.1 *Let $(\mathcal{A}; \circ)$ be an associative system. Then for $a_1, a_2, \dots, a_n \in \mathcal{A}$, the product $a_1 \circ a_2 \circ \dots \circ a_n$ is uniquely determined and independent on the calculating order.*

Proof The proof is by induction. For convenience, let $a_1 \circ a_2 \circ \dots \circ a_n$ denote the calculating order

$$(\cdots((a_1 \circ a_2) \circ a_3) \circ \cdots) \circ a_n.$$

If $n = 3$, the claim is true by definition. Assume the claim is true for any integers $n \leq k$. We consider the case of $n = k + 1$. By definition, the last step for any calculating order \prod must be a result of two elements, i.e.,

$$\prod = \prod_1 \circ \prod_2.$$

Apply the inductive assumption, we can assume that

$$\prod_1 = (\cdots((a_1 \circ a_2) \circ a_3) \circ \cdots) \circ a_l$$

and

$$\prod_2 = (\cdots((a_{l+1} \circ a_{l+2}) \circ a_{l+3}) \circ \cdots) \circ a_{k+1}.$$

Therefore, we get that

$$\begin{aligned} \prod &= \prod_1 \circ \prod_2 \\ &= (\cdots(a_1 \circ a_2) \circ \cdots) \circ a_l \circ (\cdots(a_{l+1} \circ a_{l+2}) \circ \cdots) \circ a_{k+1} \\ &= (\cdots(a_1 \circ a_2) \circ \cdots) \circ a_l \circ ((\cdots(a_{l+1} \circ a_{l+2}) \circ \cdots \circ a_k) \circ a_{k+1}) \\ &= ((\cdots(a_1 \circ a_2) \circ \cdots) \circ a_l \circ (\cdots(a_{l+1} \circ a_{l+2}) \circ \cdots \circ a_k)) \circ a_{k+1} \\ &= (\cdots((a_1 \circ a_2) \circ a_3) \circ \cdots) \circ a_{k+1} \end{aligned}$$

by the inductive assumption. Applying the inductive principle, the proof is completed. \square

Theorem 2.2.2 *Let $(\mathcal{A}; \circ)$ be an associative and commutative system, $a_1, a_2, \cdots, a_n \in \mathcal{A}$. Then for any permutation π on indexes $1, 2, \cdots, n$,*

$$a_{\pi(1)} \circ a_{\pi(2)} \circ \cdots \circ a_{\pi(n)} = a_1 \circ a_2 \circ \cdots \circ a_n.$$

Proof We prove this result by induction on n . The claim is obvious for cases of $n \leq 2$. Now assume the claim is true for any integer $l \leq n - 1$, i.e.,

$$a_{\pi(1)} \circ a_{\pi(2)} \circ \cdots \circ a_{\pi(l)} = a_1 \circ a_2 \circ \cdots \circ a_l.$$

Not loss of generality, let $\pi(k) = n$. Then we know that

$$\begin{aligned} a_{\pi(1)} \circ a_{\pi(2)} \circ \cdots \circ a_{\pi(n)} &= (a_{\pi(1)} \circ a_{\pi(2)} \circ \cdots \circ a_{\pi(k-1)}) \\ &\quad \circ a_n \circ (a_{\pi(k+1)} \circ a_{\pi(k+2)} \circ \cdots \circ a_{\pi(n)}) \\ &= (a_{\pi(1)} \circ a_{\pi(2)} \circ \cdots \circ a_{\pi(k-1)}) \\ &\quad \circ ((a_{\pi(k+1)} \circ a_{\pi(k+2)} \circ \cdots \circ a_{\pi(n)}) \circ a_n) \\ &= ((a_{\pi(1)} \circ a_{\pi(2)} \circ \cdots \circ a_{\pi(k-1)}) \\ &\quad \circ (a_{\pi(k+1)} \circ a_{\pi(k+2)} \circ \cdots \circ a_{\pi(n)})) \circ a_n \\ &= a_1 \circ a_2 \circ \cdots \circ a_n \end{aligned}$$

by the inductive assumption. \square

Let $(\mathcal{A}; \circ)$ be an algebraic system. If there exists an element 1_o^l (or 1_o^r) such that

$$1_o^l \circ a = a \quad \text{or} \quad a \circ 1_o^r = a$$

for $\forall a \in \mathcal{A}$, then 1_o^l (1_o^r) is called a *left unit* (or *right unit*) in $(\mathcal{A}; \circ)$. If 1_o^l and 1_o^r exist simultaneously, then there must be

$$1_o^l = 1_o^l \circ 1_o^r = 1_o^r = 1_o,$$

i.e., a *unit* 1_o in $(\mathcal{A}; \circ)$. For example, the algebraic system $(\mathcal{A}; \times_1)$ on $\{1, 2, 3\}$ in previous examples is a such algebraic system, but $(\mathcal{A}; \times_2)$ only posses a left unit $1_{\times_2} = 1$.

For $a \in \mathcal{A}$ in an algebraic system $(\mathcal{A}; \circ)$ with a unit 1_o , if there exists an element $b \in \mathcal{A}$ such that

$$a \circ b = 1_o \quad \text{or} \quad b \circ a = 1_o,$$

then we call b a *right inverse element* (or a *left inverse element*) of a . If $a \circ b = b \circ a = 1_o$, then b is called an inverse element of a in $(\mathcal{A}; \circ)$, denoted by $b = a^{-1}$. For example, $2^{-1} = 3$ and $3^{-1} = 2$ in $(\mathcal{A}; \times_1)$.

2.2.3 Group. An algebraic system $(\mathcal{A}; \circ)$ is a *group* if it is associative with a unit 1_o and inverse element a^{-1} for $\forall a \in \mathcal{A}$, denoted by \mathcal{A} usually. A group is

called *finite* (or *infinite*) if $|\mathcal{A}|$ is finite (or infinite). For examples, the sets \mathcal{A} , permutations $\Pi(X)$ under operations \times_1 , composition on a finite set X form finite groups $(\mathcal{A}; \times_1)$ and $Sym(X)$ respectively.

2.2.4 Isomorphism of Systems. Two algebraic systems $(\mathcal{A}_1; \circ_1)$ and $(\mathcal{A}_2; \circ_2)$ are called homomorphic if there exists a mapping $\zeta : \mathcal{A}_1 \rightarrow \mathcal{A}_2$ such that $\zeta(a \circ_1 b) = \zeta(a) \circ_2 \zeta(b)$ for $\forall a, b \in \mathcal{A}_1$. If this mapping is a bijection, then these algebraic systems are called *isomorphic*. In the case of $\mathcal{A}_1 = \mathcal{A}_2 = \mathcal{A}$ and $\circ_1 = \circ_2 = \circ$, an isomorphism between $(\mathcal{A}_1; \circ_1)$ and $(\mathcal{A}_2; \circ_2)$ is called an *automorphism on* $(\mathcal{A}; \circ)$.

Theorem 2.2.3 *Let $(\mathcal{A}; \circ)$ be an algebraic system. Then all automorphisms on $(\mathcal{A}; \circ)$ form a group under the composition operation, denoted by $Aut(\mathcal{A}; \circ)$.*

Proof For two automorphisms ζ_1 and ζ_2 on $(\mathcal{A}; \circ)$, It is obvious that

$$\zeta_1 \zeta_2(a \circ b) = \zeta_1 \zeta_2(a) \circ \zeta_1 \zeta_2(b)$$

for $\forall a, b \in \mathcal{A}$ by definition, i.e., $Aut(\mathcal{A}; \circ)$ is an algebraic system. Define an automorphism I_{fix} by $I_{fix}(a) = a$ and an automorphism ζ^{-1} by $\zeta^{-1}(b) = a$ if $\zeta(a) = b$ for $\forall a, b \in \mathcal{A}$. Then I_{fix} is the unit and ζ^{-1} is the inverse element of ζ in $Aut(\mathcal{A}; \circ)$. By definition, $Aut(\mathcal{A}; \circ)$ is a group under the composition operation. \square

2.2.5 Homomorphism Theorem. Now let $(\mathcal{A}; \circ)$ be an algebraic system and $\mathcal{B} \subset \mathcal{A}$, if $(\mathcal{B}; \circ)$ is still an algebraic system, then we call it an *algebraic sub-system of* $(\mathcal{A}; \circ)$, denoted by $\mathcal{B} \prec \mathcal{A}$. Similarly, an algebraic sub-system is called a *subgroup* if it is group itself.

Let $(\mathcal{A}; \circ)$ be an algebraic system and $\mathcal{B} \prec \mathcal{A}$. For $\forall a \in \mathcal{A}$, define a coset $a \circ \mathcal{B}$ of \mathcal{B} in \mathcal{A} by

$$a \circ \mathcal{B} = \{a \circ b | \forall b \in \mathcal{B}\}.$$

Define a *quotient set* $\mathfrak{S} = \mathcal{A} / \mathcal{B}$ consists of all cosets of \mathcal{B} in \mathcal{A} and let R be a minimal set with $\mathfrak{S} = \{r \circ \mathcal{B} | r \in R\}$, called a *representation of* \mathfrak{S} . Then

Theorem 2.2.4 *If $(\mathcal{B}; \circ)$ is a subgroup of an associative system $(\mathcal{A}; \circ)$, then*

(i) *for $\forall a, b \in \mathcal{A}$, $(a \circ \mathcal{B}) \cap (b \circ \mathcal{B}) = \emptyset$ or $a \circ \mathcal{B} = b \circ \mathcal{B}$, i.e., \mathfrak{S} is a partition of \mathcal{A} ;*

(ii) *define an operation \bullet on \mathfrak{S} by*

$$(a \circ \mathcal{B}) \bullet (b \circ \mathcal{B}) = (a \circ b) \circ \mathcal{B},$$

then $(\mathfrak{S}; \bullet)$ is an associative algebraic system, called a quotient system of \mathcal{A} to \mathcal{B} . Particularly, if there is a representation R whose each element has an inverse in $(\mathcal{A}; \circ)$ with unit $1_{\mathcal{A}}$, then $(\mathfrak{S}; \bullet)$ is a group, called a quotient group of \mathcal{A} to \mathcal{B} .

Proof For (i), notice that if

$$(a \circ \mathcal{B}) \cap (b \circ \mathcal{B}) \neq \emptyset$$

for $a, b \in \mathcal{A}$, then there are elements $c_1, c_2 \in \mathcal{B}$ such that $a \circ c_1 = b \circ c_2$. By assumption, $(\mathcal{B}; \circ)$ is a subgroup of $(\mathcal{A}; \circ)$, we know that there exists an inverse element $c_1^{-1} \in \mathcal{B}$, i.e., $a = b \circ c_2 \circ c_1^{-1}$. Therefore, we get that

$$\begin{aligned} a \circ \mathcal{B} &= (b \circ c_2 \circ c_1^{-1}) \circ \mathcal{B} \\ &= \{(b \circ c_2 \circ c_1^{-1}) \circ c \mid \forall c \in \mathcal{B}\} \\ &= \{b \circ c \mid \forall c \in \mathcal{B}\} \\ &= b \circ \mathcal{B} \end{aligned}$$

by the associative law and $(\mathcal{B}; \circ)$ is a group gain, i.e., $(a \circ \mathcal{B}) \cap (b \circ \mathcal{B}) = \emptyset$ or $a \circ \mathcal{B} = b \circ \mathcal{B}$.

By definition of \bullet on \mathfrak{S} and (i), we know that $(\mathfrak{S}; \bullet)$ is an algebraic system. For $\forall a, b, c \in \mathcal{A}$, by the associative laws in $(\mathcal{A}; \circ)$, we find that

$$\begin{aligned} ((a \circ \mathcal{B}) \bullet (b \circ \mathcal{B})) \bullet (c \circ \mathcal{B}) &= ((a \circ b) \circ \mathcal{B}) \bullet (c \circ \mathcal{B}) \\ &= ((a \circ b) \circ c) \circ \mathcal{B} = (a \circ (b \circ c)) \circ \mathcal{B} \\ &= (a \circ \mathcal{B}) \circ ((b \circ c) \circ \mathcal{B}) \\ &= (a \circ \mathcal{B}) \bullet ((b \circ \mathcal{B}) \bullet (c \circ \mathcal{B})). \end{aligned}$$

Now if there is a representation R whose each element has an inverse in $(\mathcal{A}; \circ)$ with unit $1_{\mathcal{A}}$, then it is easy to know that $1_{\mathcal{A}} \circ \mathcal{B}$ is the unit and $a^{-1} \circ \mathcal{B}$ the inverse element of $a \circ \mathcal{B}$ in \mathfrak{S} . Whence, $(\mathfrak{S}; \bullet)$ is a group. \square

Corollary 2.2.1 For a subgroup $(\mathcal{B}; \circ)$ of a group $(\mathcal{A}; \circ)$, $(\mathfrak{S}; \bullet)$ is a group.

Corollary 2.2.2(Lagrange theorem) *For a subgroup $(\mathcal{B}; \circ)$ of a group $(\mathcal{A}; \circ)$,*

$$|\mathcal{B}| \mid |\mathcal{A}|.$$

Proof Since $a \circ c_1 = a \circ c_2$ implies that $c_1 = c_2$ in this case, we know that

$$|a \circ \mathcal{B}| = |\mathcal{B}|$$

for $\forall a \in \mathcal{A}$. Applying Theorem 2.2.4(i), we find that

$$|\mathcal{A}| = \sum_{r \in R} |r \circ \mathcal{B}| = |R| |\mathcal{B}|,$$

for a representation R , i.e., $|\mathcal{B}| \mid |\mathcal{A}|$. □

Although the operation \bullet in \mathfrak{S} is introduced by the operation \circ in \mathcal{A} , it may be $\bullet \neq \circ$. Now if $\bullet = \circ$, i.e.,

$$(a \circ \mathcal{B}) \circ (b \circ \mathcal{B}) = (a \circ b) \circ \mathcal{B}, \quad (2.2.1)$$

the subgroup $(\mathcal{B}; \circ)$ is called a *normal subgroup of $(\mathcal{B}; \circ)$* , denoted by $\mathcal{B} \trianglelefteq \mathcal{A}$. In this case, if there exist inverses of a, b , we know that

$$\mathcal{B} \circ b \circ \mathcal{B} = b \circ \mathcal{B}$$

by product a^{-1} from the left on both side of (2.2.1). Now since $(\mathcal{B}; \circ)$ is a subgroup, we get that

$$b^{-1} \circ \mathcal{B} \circ b = \mathcal{B},$$

which is the usually definition for a normal subgroup of a group. Certainly, we can also get

$$b \circ \mathcal{B} = \mathcal{B} \circ b$$

by this equality, which can be used to define a *normal subgroup of a algebraic system* with or without inverse element for an element in this system.

Now let $\varpi : \mathcal{A}_1 \rightarrow \mathcal{A}_2$ be a homomorphism from an algebraic system $(\mathcal{A}_1; \circ_1)$ with unit $1_{\mathcal{A}_1}$ to $(\mathcal{A}_2; \circ_2)$ with unit $1_{\mathcal{A}_2}$. Define the *inverse set* $\varpi^{-1}(a_2)$ for an element $a_2 \in \mathcal{A}_2$ by

$$\varpi^{-1}(a_2) = \{a_1 \in \mathcal{A}_1 \mid \varpi(a_1) = a_2\}.$$

Particularly, if $a_2 = 1_{\mathcal{A}_2}$, the inverse set $\varpi^{-1}(1_{\mathcal{A}_2})$ is important in algebra and called the *kernel of ϖ* and denoted by $\text{Ker}(\varpi)$, which is a normal subgroup of $(\mathcal{A}_1; \circ_1)$ if it is associative and each element in $\text{Ker}(\varpi)$ has inverse element in $(\mathcal{A}_1; \circ_1)$. In fact, by definition, for $\forall a, b, c \in \mathcal{A}_1$, we know that

- (1) $(a \circ b) \circ c = a \circ (b \circ c) \in \text{Ker}(\varpi)$ for $\varpi((a \circ b) \circ c) = \varpi(a \circ (b \circ c)) = 1_{\mathcal{A}_2}$;
- (2) $1_{\mathcal{A}_2} \in \text{Ker}(\varpi)$ for $\varpi(1_{\mathcal{A}_1}) = 1_{\mathcal{A}_2}$;
- (3) $a^{-1} \in \text{Ker}(\varpi)$ for $\forall a \in \text{Ker}(\varpi)$ if a^{-1} exists in $(\mathcal{A}_1; \circ_1)$ since $\varpi(a^{-1}) = \varpi^{-1}(a) = 1_{\mathcal{A}_2}$;
- (4) $a \circ \text{Ker}(\varpi) = \text{Ker}(\varpi) \circ a$ for

$$\varpi(a \circ \text{Ker}(\varpi)) = \varpi(\text{Ker}(\varpi) \circ a) = \varpi^{-1}(\varpi(a))$$

by definition. Whence, $\text{Ker}(\varpi)$ is a normal subgroup of $(\mathcal{A}_1; \circ_1)$.

Theorem 2.2.5 *Let $\varpi : \mathcal{A}_1 \rightarrow \mathcal{A}_2$ be an onto homomorphism from associative systems $(\mathcal{A}_1; \circ_1)$ to $(\mathcal{A}_2; \circ_2)$ with units $1_{\mathcal{A}_1}, 1_{\mathcal{A}_2}$. Then*

$$\mathcal{A}_1/\text{Ker}(\varpi) \cong (\mathcal{A}_2; \circ_2)$$

if each element of $\text{Ker}(\varpi)$ has an inverse in $(\mathcal{A}_1; \circ_1)$.

Proof We have known that $\text{Ker}(\varpi)$ is a subgroup of $(\mathcal{A}_1; \circ_1)$. Whence $\mathcal{A}_1/\text{Ker}(\varpi)$ is a quotient system. Define a mapping $\varsigma : \mathcal{A}_1/\text{Ker}(\varpi) \rightarrow \mathcal{A}_2$ by

$$\varsigma(a \circ_1 \text{Ker}(\varpi)) = \varpi(a).$$

We prove this mapping is an isomorphism. Notice that ς is onto by that ϖ is an onto homomorphism. Now if $a \circ_1 \text{Ker}(\varpi) \neq b \circ_1 \text{Ker}(\varpi)$, then $\varpi(a) \neq \varpi(b)$. Otherwise, we find that $a \circ_1 \text{Ker}(\varpi) = b \circ_1 \text{Ker}(\varpi)$, a contradiction. Whence, $\varsigma(a \circ_1 \text{Ker}(\varpi)) \neq \varsigma(b \circ_1 \text{Ker}(\varpi))$, i.e., ς is a bijection from $\mathcal{A}_1/\text{Ker}(\varpi)$ to \mathcal{A}_2 .

Since ϖ is a homomorphism, we get that

$$\begin{aligned} & \varsigma((a \circ_1 \text{Ker}(\varpi)) \circ_1 (b \circ_1 \text{Ker}(\varpi))) \\ &= \varsigma(a \circ_1 \text{Ker}(\varpi)) \circ_2 \varsigma(b \circ_1 \text{Ker}(\varpi)) \end{aligned}$$

$$= \varpi(a) \circ_2 \varpi(b),$$

i.e., ς is an isomorphism from $\mathcal{A}_1/\text{Ker}(\varpi)$ to $(\mathcal{A}_2; \circ_2)$. □

Corollary 2.2.3 *Let $\varpi : \mathcal{A}_1 \rightarrow \mathcal{A}_2$ be an onto homomorphism from groups $(\mathcal{A}_1; \circ_1)$ to $(\mathcal{A}_2; \circ_2)$. Then*

$$\mathcal{A}_1/\text{Ker}(\varpi) \cong (\mathcal{A}_2; \circ_2).$$

§2.3 MULTI-OPERATION SYSTEMS

2.3.1 Multi-Operation System. A *multi-operation system* is a pair $(\mathcal{H}; \tilde{O})$ with a set \mathcal{H} and an operation set

$$\tilde{O} = \{\circ_i \mid 1 \leq i \leq l\}$$

on \mathcal{H} such that each pair $(\mathcal{H}; \circ_i)$ is an algebraic system. We also call $(\mathcal{H}; \tilde{O})$ an *l-operation system on \mathcal{H}* .

A multi-operation system $(\mathcal{H}; \tilde{O})$ is *associative* if for $\forall a, b, c \in \mathcal{H}, \forall \circ_1, \circ_2 \in \tilde{O}$, there is

$$(a \circ_1 b) \circ_2 c = a \circ_1 (b \circ_2 c).$$

Such a system is called an *associative multi-operation system*.

Let (\mathcal{H}, \tilde{O}) be a multi-operation system and $\mathcal{G} \subset \mathcal{H}, \tilde{Q} \subset \tilde{O}$. If $(\mathcal{G}; \tilde{Q})$ is itself a multi-operation system, we call $(\mathcal{G}; \tilde{Q})$ a *multi-operation subsystem of (\mathcal{H}, \tilde{O})* , denoted by $(\mathcal{G}; \tilde{Q}) \prec (\mathcal{H}, \tilde{O})$. In those of subsystems, the $(\mathcal{G}; \tilde{O})$ is taking over an important position in the following.

Assume $(\mathcal{G}; \tilde{O}) \prec (\mathcal{H}, \tilde{O})$. For $\forall a \in \mathcal{H}$ and $\circ_i \in \tilde{O}$, where $1 \leq i \leq l$, define a coset $a \circ_i \mathcal{G}$ by

$$a \circ_i \mathcal{G} = \{a \circ_i b \mid \forall b \in \mathcal{G}\},$$

and let

$$\mathcal{H} = \bigcup_{a \in R, \circ \in \tilde{P} \subset \tilde{O}} a \circ \mathcal{G}.$$

Then the set

$$\mathcal{Q} = \{a \circ \mathcal{G} | a \in R, \circ \in \tilde{P} \subset \tilde{O}\}$$

is called a *quotient set of \mathcal{G} in \mathcal{H} with a representation pair (R, \tilde{P})* , denoted by $\frac{\mathcal{H}}{\mathcal{G}}|_{(R, \tilde{P})}$. Similar to Theorem 2.4, we get the following result.

2.3.2 Isomorphism of Multi-Systems. Two multi-operation systems $(\mathcal{H}_1; \tilde{O}_1)$ and $(\mathcal{H}_2; \tilde{O}_2)$ are called *homomorphic* if there is a mapping $\omega : \mathcal{H}_1 \rightarrow \mathcal{H}_2$ with $\omega : \tilde{O}_1 \rightarrow \tilde{O}_2$ such that for $a_1, b_1 \in \mathcal{H}_1$ and $\circ_1 \in \tilde{O}_1$, there exists an operation $\circ_2 = \omega(\circ_1) \in \tilde{O}_2$ enables that

$$\omega(a_1 \circ_1 b_1) = \omega(a_1) \circ_2 \omega(b_1).$$

Similarly, if ω is a bijection, $(\mathcal{H}_1; \tilde{O}_1)$ and $(\mathcal{H}_2; \tilde{O}_2)$ are called *isomorphic*, and if $\mathcal{H}_1 = \mathcal{H}_2 = \mathcal{H}$, ω is called an *automorphism on \mathcal{H}* .

Theorem 2.3.1 *Let (\mathcal{H}, \tilde{O}) be an associative multi-operation system with a unit 1_\circ for $\forall \circ \in \tilde{O}$ and $\mathcal{G} \subset \mathcal{H}$.*

(i) *If \mathcal{G} is closed for operations in \tilde{O} and for $\forall a \in \mathcal{G}, \circ \in \tilde{O}$, there exists an inverse element a_\circ^{-1} in $(\mathcal{G}; \circ)$, then there is a representation pair (R, \tilde{P}) such that the quotient set $\frac{\mathcal{H}}{\mathcal{G}}|_{(R, \tilde{P})}$ is a partition of \mathcal{H} , i.e., for $a, b \in \mathcal{H}, \forall \circ_1, \circ_2 \in \tilde{O}$, $(a \circ_1 \mathcal{G}) \cap (b \circ_2 \mathcal{G}) = \emptyset$ or $a \circ_1 \mathcal{G} = b \circ_2 \mathcal{G}$.*

(ii) *For $\forall \circ \in \tilde{O}$, define an operation \circ on $\frac{\mathcal{H}}{\mathcal{G}}|_{(R, \tilde{P})}$ by*

$$(a \circ_1 \mathcal{G}) \circ (b \circ_2 \mathcal{G}) = (a \circ b) \circ_1 \mathcal{G}.$$

Then $(\frac{\mathcal{H}}{\mathcal{G}}|_{(R, \tilde{P})}; \tilde{O})$ is an associative multi-operation system. Particularly, if there is a representation pair (R, \tilde{P}) such that for $\circ' \in \tilde{P}$, any element in R has an inverse in $(\mathcal{H}; \circ')$, then $(\frac{\mathcal{H}}{\mathcal{G}}|_{(R, \tilde{P})}, \circ')$ is a group.

Proof For $a, b \in \mathcal{H}$, if there are operations $\circ_1, \circ_2 \in \tilde{O}$ with $(a \circ_1 \mathcal{G}) \cap (b \circ_2 \mathcal{G}) \neq \emptyset$, then there must exist $g_1, g_2 \in \mathcal{G}$ such that $a \circ_1 g_1 = b \circ_2 g_2$. By assumption, there is an inverse element c_1^{-1} in the system $(\mathcal{G}; \circ_1)$. We find that

$$a \circ_1 \mathcal{G} = (b \circ_2 g_2 \circ_1 c_1^{-1}) \circ_1 \mathcal{G}$$

$$= b \circ_2 (g_2 \circ_1 c_1^{-1} \circ_1 \mathcal{G}) = b \circ_2 \mathcal{G}$$

by the associative law. This implies that $\frac{\mathcal{H}}{\mathcal{G}}|_{(R, \tilde{P})}$ is a partition of \mathcal{H} .

Notice that $\frac{\mathcal{H}}{\mathcal{G}}|_{(R, \tilde{P})}$ is closed under operations in \tilde{P} by definition. It is a multi-operation system. For $\forall a, b, c \in R$ and operations $\circ_1, \circ_2, \circ_3, \circ^1, \circ^2 \in \tilde{P}$ we know that

$$\begin{aligned} ((a \circ_1 \mathcal{G}) \circ^1 (b \circ_2 \mathcal{G})) \circ^2 (c \circ_3 \mathcal{G}) &= ((a \circ^1 b) \circ_1 \mathcal{G}) \circ^2 (c \circ_3 \mathcal{G}) \\ &= ((a \circ^1 b) \circ^2 c) \circ_1 \mathcal{G} \end{aligned}$$

and

$$\begin{aligned} (a \circ_1 \mathcal{G}) \circ^1 ((b \circ_2 \mathcal{G}) \circ^2 (c \circ_3 \mathcal{G})) &= (a \circ_1 \mathcal{G}) \circ_1 ((b \circ^2 c) \circ_2 \mathcal{G}) \\ &= (a \circ^1 (b \circ^2 c)) \circ_1 \mathcal{G}. \end{aligned}$$

by definition. Since (\mathcal{H}, \tilde{O}) is associative, we have $(a \circ^1 b) \circ^2 c = a \circ^1 (b \circ^2 c)$. Whence, we get that

$$((a \circ_1 \mathcal{G}) \circ^1 (b \circ_2 \mathcal{G})) \circ^2 (c \circ_3 \mathcal{G}) = (a \circ_1 \mathcal{G}) \circ^1 ((b \circ_2 \mathcal{G}) \circ^2 (c \circ_3 \mathcal{G})),$$

i.e., $(\frac{\mathcal{H}}{\mathcal{G}}|_{(R, \tilde{P})}; \tilde{O})$ is an associative multi-operation system.

If any element in R has an inverse in $(\mathcal{H}; \circ')$, then we know that \mathcal{G} is a unit and $a^{-1} \circ' \mathcal{G}$ is the inverse element of $a \circ' \mathcal{G}$ in the system $(\frac{\mathcal{H}}{\mathcal{G}}|_{(R, \tilde{P})}, \circ')$, namely, it is a group again. \square

Let $\mathcal{I}(\tilde{O})$ be the set of all units $1_{\circ}, \circ \in \tilde{O}$ in a multi-operation system $(\mathcal{H}; \tilde{O})$. Define a *multi-kernel* $\widetilde{\text{Ker}}\omega$ of a homomorphism $\omega : (\mathcal{H}_1; \tilde{O}_1) \rightarrow (\mathcal{H}_2; \tilde{O}_2)$ by

$$\widetilde{\text{Ker}}\omega = \{ a \in \mathcal{H}_1 \mid \omega(a) = 1_{\circ} \in \mathcal{I}(\tilde{O}_2) \}.$$

Then we know the homomorphism theorem for multi-operation systems in the following.

Theorem 2.3.2 *Let ω be an onto homomorphism from associative systems $(\mathcal{H}_1; \tilde{O}_1)$ to $(\mathcal{H}_2; \tilde{O}_2)$ with $(\mathcal{I}(\tilde{O}_2); \tilde{O}_2)$ an algebraic system with unit 1_{\circ^-} for $\forall \circ^- \in \tilde{O}_2$ and*

inverse x^{-1} for $\forall x \in (\mathcal{I}(\tilde{\mathcal{O}}_2)$ in $((\mathcal{I}(\tilde{\mathcal{O}}_2); \circ^-)$. Then there are representation pairs (R_1, \tilde{P}_1) and (R_2, \tilde{P}_2) , where $\tilde{P}_1 \subset \tilde{\mathcal{O}}, \tilde{P}_2 \subset \tilde{\mathcal{O}}_2$ such that

$$\frac{(\mathcal{H}_1; \tilde{\mathcal{O}}_1)}{(\widetilde{\text{Ker}\omega}; \tilde{\mathcal{O}}_1)}|_{(R_1, \tilde{P}_1)} \cong \frac{(\mathcal{H}_2; \tilde{\mathcal{O}}_2)}{(\mathcal{I}(\tilde{\mathcal{O}}_2); \tilde{\mathcal{O}}_2)}|_{(R_2, \tilde{P}_2)}$$

if each element of $\widetilde{\text{Ker}\omega}$ has an inverse in $(\mathcal{H}_1; \circ)$ for $\circ \in \tilde{\mathcal{O}}_1$.

Proof Notice that $\widetilde{\text{Ker}\omega}$ is an associative subsystem of $(\mathcal{H}_1; \tilde{\mathcal{O}}_1)$. In fact, for $\forall k_1, k_2 \in \widetilde{\text{Ker}\omega}$ and $\forall \circ \in \tilde{\mathcal{O}}_1$, there is an operation $\circ^- \in \tilde{\mathcal{O}}_2$ such that

$$\omega(k_1 \circ k_2) = \omega(k_1) \circ^- \omega(k_2) \in \mathcal{I}(\tilde{\mathcal{O}}_2)$$

since $\mathcal{I}(\tilde{\mathcal{O}}_2)$ is an algebraic system. Whence, $\widetilde{\text{Ker}\omega}$ is an associative subsystem of $(\mathcal{H}_1; \tilde{\mathcal{O}}_1)$. By assumption, for any operation $\circ \in \tilde{\mathcal{O}}_1$ each element $a \in \widetilde{\text{Ker}\omega}$ has an inverse a^{-1} in $(\mathcal{H}_1; \circ)$. Let $\omega : (\mathcal{H}_1; \circ) \rightarrow (\mathcal{H}_2; \circ^-)$. We know that

$$\omega(a \circ a^{-1}) = \omega(a) \circ^- \omega(a^{-1}) = 1_{\circ^-},$$

i.e., $\omega(a^{-1}) = \omega(a)^{-1}$ in $(\mathcal{H}_2; \circ^-)$. Because $\mathcal{I}(\tilde{\mathcal{O}}_2)$ is an algebraic system with an inverse x^{-1} for $\forall x \in \mathcal{I}(\tilde{\mathcal{O}}_2)$ in $((\mathcal{I}(\tilde{\mathcal{O}}_2); \circ^-)$, we find that $\omega(a^{-1}) \in \mathcal{I}(\tilde{\mathcal{O}}_2)$, namely, $a^{-1} \in \widetilde{\text{Ker}\omega}$.

Define a mapping $\sigma : \frac{(\mathcal{H}_1; \tilde{\mathcal{O}}_1)}{(\widetilde{\text{Ker}\omega}; \tilde{\mathcal{O}}_1)}|_{(R_1, \tilde{P}_1)} \rightarrow \frac{(\mathcal{H}_2; \tilde{\mathcal{O}}_2)}{(\mathcal{I}(\tilde{\mathcal{O}}_2); \tilde{\mathcal{O}}_2)}|_{(R_2, \tilde{P}_2)}$ by

$$\sigma(a \circ \text{Ker}\omega) = \sigma(a) \circ^- \mathcal{I}(\tilde{\mathcal{O}}_2)$$

for $\forall a \in R_1, \circ \in \tilde{P}_1$, where $\omega : (\mathcal{H}_1; \circ) \rightarrow (\mathcal{H}_2; \circ^-)$. We prove σ is an isomorphism. Notice that σ is onto by that ω is an onto homomorphism. Now if $a \circ_1 \widetilde{\text{Ker}\omega} \neq b \circ_2 \text{Ker}(\varpi)$ for $a, b \in R_1$ and $\circ_1, \circ_2 \in \tilde{P}_1$, then $\omega(a) \circ_1^- \mathcal{I}(\tilde{\mathcal{O}}_2) \neq \omega(b) \circ_2^- \mathcal{I}(\tilde{\mathcal{O}}_2)$. Otherwise, we find that $a \circ_1 \widetilde{\text{Ker}\omega} = b \circ_2 \widetilde{\text{Ker}\omega}$, a contradiction. Whence, $\sigma(a \circ_1 \widetilde{\text{Ker}\omega}) \neq \sigma(b \circ_2 \widetilde{\text{Ker}\omega})$, i.e., σ is a bijection from $\frac{(\mathcal{H}_1; \tilde{\mathcal{O}}_1)}{(\widetilde{\text{Ker}\omega}; \tilde{\mathcal{O}}_1)}|_{(R_1, \tilde{P}_1)}$ to $\frac{(\mathcal{H}_2; \tilde{\mathcal{O}}_2)}{(\mathcal{I}(\tilde{\mathcal{O}}_2); \tilde{\mathcal{O}}_2)}|_{(R_2, \tilde{P}_2)}$.

Since ω is a homomorphism, we get that

$$\begin{aligned} \sigma((a \circ_1 \widetilde{\text{Ker}\omega}) \circ (b \circ_2 \widetilde{\text{Ker}\omega})) &= \sigma(a \circ_1 \widetilde{\text{Ker}\omega}) \circ^- \sigma(b \circ_2 \widetilde{\text{Ker}\omega}) \\ &= (\omega(a) \circ_1^- \mathcal{I}(\tilde{\mathcal{O}}_2)) \circ^- (\omega(b) \circ_2^- \mathcal{I}(\tilde{\mathcal{O}}_2)) \\ &= \sigma((a \circ_1 \widetilde{\text{Ker}\omega}) \circ^- \sigma(b \circ_2 \widetilde{\text{Ker}\omega})), \end{aligned}$$

i.e., σ is an isomorphism from $\frac{(\mathcal{H}_1; \tilde{\mathcal{O}}_1)}{(\text{Ker}\omega; \tilde{\mathcal{O}}_1)}|_{(R_1, \tilde{P}_1)}$ to $\frac{(\mathcal{H}_2; \tilde{\mathcal{O}}_2)}{(\mathcal{I}(\tilde{\mathcal{O}}_2); \tilde{\mathcal{O}}_2)}|_{(R_2, \tilde{P}_2)}$. \square

Corollary 2.3.1 *Let $(\mathcal{H}_1; \tilde{\mathcal{O}}_1)$, $(\mathcal{H}_2; \tilde{\mathcal{O}}_2)$ be multi-operation systems with groups $(\mathcal{H}_2; \circ_1)$, $(\mathcal{H}_2; \circ_2)$ for $\forall \circ_1 \in \tilde{\mathcal{O}}_1$, $\forall \circ_2 \in \tilde{\mathcal{O}}_2$ and $\omega : (\mathcal{H}_1; \tilde{\mathcal{O}}_1) \rightarrow (\mathcal{H}_2; \tilde{\mathcal{O}}_2)$ a homomorphism. Then there are representation pairs (R_1, \tilde{P}_1) and (R_2, \tilde{P}_2) , where $\tilde{P}_1 \subset \tilde{\mathcal{O}}_1$, $\tilde{P}_2 \subset \tilde{\mathcal{O}}_2$ such that*

$$\frac{(\mathcal{H}_1; \tilde{\mathcal{O}}_1)}{(\text{Ker}\omega; \tilde{\mathcal{O}}_1)}|_{(R_1, \tilde{P}_1)} \cong \frac{(\mathcal{H}_2; \tilde{\mathcal{O}}_2)}{(\mathcal{I}(\tilde{\mathcal{O}}_2); \tilde{\mathcal{O}}_2)}|_{(R_2, \tilde{P}_2)}.$$

Particularly, if $(\mathcal{H}_2; \tilde{\mathcal{O}}_2)$ is a group, we get an interesting result following.

Corollary 2.3.2 *Let $(\mathcal{H}; \tilde{\mathcal{O}})$ be a multi-operation system and $\omega : (\mathcal{H}; \tilde{\mathcal{O}}) \rightarrow (\mathcal{A}; \circ)$ a onto homomorphism from $(\mathcal{H}; \tilde{\mathcal{O}})$ to a group $(\mathcal{A}; \circ)$. Then there are representation pairs (R, \tilde{P}) , $\tilde{P} \subset \tilde{\mathcal{O}}$ such that*

$$\frac{(\mathcal{H}; \tilde{\mathcal{O}})}{(\text{Ker}\omega; \tilde{\mathcal{O}})}|_{(R, \tilde{P})} \cong (\mathcal{A}; \circ).$$

2.3.3 Distribute Law. A multi-operation system $(\mathcal{H}; \tilde{\mathcal{O}})$ is *distributive* if $\tilde{\mathcal{O}} = \mathcal{O}_1 \cup \mathcal{O}_2$ with $\mathcal{O}_1 \cap \mathcal{O}_2 = \emptyset$ such that

$$a \circ_1 (b \circ_2 c) = (a \circ_1 b) \circ_2 (a \circ_1 c) \text{ and } (b \circ_2 c) \circ_1 a = (b \circ_1 a) \circ_2 (c \circ_1 a)$$

for $\forall a, b, c \in \mathcal{H}$ and $\forall \circ_1 \in \mathcal{O}_1$, $\circ_2 \in \mathcal{O}_2$. Denoted such a system by $(\mathcal{H}; \mathcal{O}_1 \leftrightarrow \mathcal{O}_2)$. In this case, the *associative* means that systems $(\mathcal{H}; \mathcal{O}_1)$ and $(\mathcal{H}; \mathcal{O}_2)$ are associative, respectively.

Similar to Theorems 2.2.1 and 2.2.2, we can also obtain the next result for distributive laws in a multi-operation system.

Theorem 2.3.3 *Let $(\mathcal{H}; \mathcal{O}_1 \leftrightarrow \mathcal{O}_2)$ be an associative system for operations in \mathcal{O}_2 , $a, b_1, b_2, \dots, b_n \in \mathcal{H}$ and $\circ \in \mathcal{O}_1$, $\circ_i \in \mathcal{O}_2$ for $1 \leq i \leq n-1$. Then*

$$a \circ (b_1 \circ_1 b_2 \circ_2 \dots \circ_{n-1} b_n) = (a \circ b_1) \circ_1 (a \circ b_2) \circ_2 \dots \circ_{n-1} (a \circ b_n),$$

$$(b_1 \circ_1 b_2 \circ_2 \dots \circ_{n-1} b_n) \circ a = (b_1 \circ a) \circ_1 (b_2 \circ a) \circ_2 \dots \circ_{n-1} (b_n \circ a).$$

Proof For the case of $n = 2$, these equalities are hold by definition. Now assume that they are hold for any integer $n \leq k$. Then we find that

$$\begin{aligned} a \circ (b_1 \circ_1 b_2 \circ_2 \cdots \circ_k b_{k+1}) &= (a \circ b_1) \circ_1 (a \circ b_2) \circ_2 \cdots \circ_{k-1} (a \circ (b_k \circ_{k+1} b_{k+1})) \\ &= (a \circ b_1) \circ_1 (a \circ b_2) \circ_2 \cdots \circ_{k-1} (a \circ b_k) \circ_{k+1} (a \circ b_{k+1}) \end{aligned}$$

by the inductive assumption. Therefore,

$$a \circ (b_1 \circ_1 b_2 \circ_2 \cdots \circ_{n-1} b_n) = (a \circ b_1) \circ_1 (a \circ b_2) \circ_2 \cdots \circ_{n-1} (a \circ b_n)$$

is hold for any integer $n \geq 2$. Similarly, we can also prove that

$$(b_1 \circ_1 b_2 \circ_2 \cdots \circ_{n-1} b_n) \circ a = (b_1 \circ a) \circ_1 (b_2 \circ a) \circ_2 \cdots \circ_{n-1} (b_n \circ a).$$

□

2.3.4 Multi-Group and Multi-Ring. An associative multi-operation system $(\mathcal{H}; \mathcal{O}_1 \hookrightarrow \mathcal{O}_2)$ is said to be a *multi-group* if $(\mathcal{H}; \circ)$ is a group for $\forall \circ \in \mathcal{O}_1 \cup \mathcal{O}_2$, a *multi-ring* (or *multi-field*) if $\mathcal{O}_1 = \{\cdot_i | 1 \leq i \leq l\}$, $\mathcal{O}_2 = \{+_i | 1 \leq i \leq l\}$ with rings (or multi-field) $(\mathcal{H}; +_i, \cdot_i)$ for $1 \leq i \leq l$. We call them *l-group*, *l-ring* or *l-field* for abbreviation. It is obvious that a multi-group is a group if $|\mathcal{O}_1 \cup \mathcal{O}_2| = 1$ and a ring or field if $|\mathcal{O}_1| = |\mathcal{O}_2| = 1$ in classical algebra. Likewise, We also denote these units of a *l-ring* $(\mathcal{H}; \mathcal{O}_1 \hookrightarrow \mathcal{O}_2)$ by 1_{\cdot_i} and 0_{+_i} in the ring $(\mathcal{H}; +_i, \cdot_i)$. Notice that for $\forall a \in \mathcal{H}$, by these distribute laws we find that

$$\begin{aligned} a \cdot_i b &= a \cdot_i (b +_i 0_{+_i}) = a \cdot_i b +_i a \cdot_i 0_{+_i}, \\ b \cdot_i a &= (b +_i 0_{+_i}) \cdot_i a = b \cdot_i a +_i 0_{+_i} \cdot_i a \end{aligned}$$

for $\forall b \in \mathcal{H}$. Whence,

$$a \cdot_i 0_{+_i} = 0_{+_i} \text{ and } 0_{+_i} \cdot_i a = 0_{+_i}.$$

Similarly, a multi-operation subsystem of $(\mathcal{H}; \mathcal{O}_1 \hookrightarrow \mathcal{O}_2)$ is said a *multi-subgroup*, *multi-subring* or *multi-subfield* if it is a *multi-group*, *multi-ring* or *multi-field* itself.

Now let $(\mathcal{H}; \mathcal{O}_1 \hookrightarrow \mathcal{O}_2)$ be an associative multi-operation system. We find these criterions for multi-subgroups and multi-subrings of $(\mathcal{H}; \mathcal{O}_1 \hookrightarrow \mathcal{O}_2)$ in the following.

Theorem 2.3.4 *Let $(\mathcal{H}; \mathcal{O}_1 \hookrightarrow \mathcal{O}_2)$ be a multi-group, $\mathcal{H} \subset \mathcal{H}$. Then $(\mathcal{H}; \mathcal{O}_1 \hookrightarrow \mathcal{O}_2)$ is a*

(i) multi-subgroup if and only if for $\forall a, b \in \mathcal{H}$, $\circ \in \mathcal{O}_1 \cup \mathcal{O}_2$, $a \circ b_{\circ}^{-1} \in \mathcal{H}$;

(ii) multi-subring if and only if for $\forall a, b \in \mathcal{H}$, $\cdot_i \in \mathcal{O}_1$ and $\forall +_i \in \mathcal{O}_2$, $a \cdot_i b$, $a +_i b_{+_i}^{-1} \in \mathcal{H}$, particularly, a multi-field if $a \cdot_i b_{\cdot_i}^{-1}$, $a +_i b_{+_i}^{-1} \in \mathcal{H}$, where, $\mathcal{O}_1 = \{\cdot_i | 1 \leq i \leq l\}$, $\mathcal{O}_2 = \{+_i | 1 \leq i \leq l\}$.

Proof The necessity of conditions (i) and (ii) is obvious. Now we consider their sufficiency.

For (i), we only need to prove that $(\mathcal{H}; \circ)$ is a group for $\forall \circ \in \mathcal{O}_1 \cup \mathcal{O}_2$. In fact, it is associative by the definition of multi-groups. For $\forall a \in \mathcal{H}$, we get that $1_{\circ} = a \circ a_{\circ}^{-1} \in \mathcal{H}$ and $1_{\circ} \circ a_{\circ}^{-1} \in \mathcal{H}$. Whence, $(\mathcal{H}; \circ)$ is a group.

Similarly for (ii), the conditions $a \cdot_i b$, $a +_i b_{+_i}^{-1} \in \mathcal{H}$ imply that $(\mathcal{H}; +_i)$ is a group and closed in operation $\cdot_i \in \mathcal{O}_1$. These associative or distributive laws are hold by $(\mathcal{H}; +_i, \cdot_i)$ being a ring for any integer $i, 1 \leq i \leq l$. Particularly, $a \cdot_i b_{\cdot_i}^{-1} \in \mathcal{H}$ imply that $(\mathcal{H}; \cdot_i)$ is also a group. Whence, $(\mathcal{H}; +_i, \cdot_i)$ is a field for any integer $i, 1 \leq i \leq l$ in this case. \square

A multi-ring $(\mathcal{H}; \mathcal{O}_1 \hookrightarrow \mathcal{O}_2)$ with $\mathcal{O}_1 = \{\cdot_i | 1 \leq i \leq l\}$, $\mathcal{O}_2 = \{+_i | 1 \leq i \leq l\}$ is *integral* if for $\forall a, b \in \mathcal{H}$ and an integer $i, 1 \leq i \leq l$, $a \circ_i b = b \circ_i a$, $1_{\circ_i} \neq 0_{+_i}$ and $a \circ_i b = 0_{+_i}$ implies that $a = 0_{+_i}$ or $b = 0_{+_i}$. If $l = 1$, an integral l -ring is the integral ring by definition. For the case of multi-rings with finite elements, an integral multi-ring is nothing but a multi-field. See the next result.

Theorem 2.3.5 *A finitely integral multi-ring is a multi-field.*

Proof Let $(\mathcal{H}; \mathcal{O}_1 \hookrightarrow \mathcal{O}_2)$ be a finitely integral multi-ring with $\mathcal{H} = \{a_1, a_2 \cdots, a_n\}$, where $\mathcal{O}_1 = \{\cdot_i | 1 \leq i \leq l\}$, $\mathcal{O}_2 = \{+_i | 1 \leq i \leq l\}$. For any integer $i, 1 \leq i \leq l$, choose an element $a \in \mathcal{H}$ and $a \neq 0_{+_i}$. Then

$$a \circ_i a_1, a \circ_i a_2, \cdots, a \circ_i a_n$$

are n elements. If $a \circ_i a_s = a \circ_i a_t$, i.e., $a \circ_i (a_s +_i a_t^{-1}) = 0_{+_i}$. By definition, we know that $a_s +_i a_t^{-1} = 0_{+_i}$, namely, $a_s = a_t$. That is, these $a \circ_i a_1, a \circ_i a_2, \cdots, a \circ_i a_n$ are different two by two. Whence,

$$\mathcal{H} = \{ a \circ_i a_1, a \circ_i a_2, \cdots, a \circ_i a_n \}.$$

Now assume $a \circ_i a_s = 1_{\cdot_i}$, then $a^{-1} = a_s$, i.e., each element of \mathcal{H} has an inverse

in $(\mathcal{H}; \cdot_i)$, which implies it is a commutative group. Therefore, $(\mathcal{H}; +_i, \cdot_i)$ is a field for any integer $i, 1 \leq i \leq l$. \square

Corollary 2.3.3 *Any finitely integral domain is a field.*

2.3.5 Multi-Ideal. Let $(\mathcal{H}; \mathcal{O}_1^1 \hookrightarrow \mathcal{O}_1^1)$, $(\mathcal{H}; \mathcal{O}_1^2 \hookrightarrow \mathcal{O}_2^2)$ be multi-rings with $\mathcal{O}_1^k = \{ \cdot_i^k | 1 \leq i \leq l_k \}$, $\mathcal{O}_2^k = \{ +_i^k | 1 \leq i \leq l_k \}$ for $k = 1, 2$ and $\varrho : (\mathcal{H}; \mathcal{O}_1^1 \hookrightarrow \mathcal{O}_2^1) \rightarrow (\mathcal{H}; \mathcal{O}_1^2 \hookrightarrow \mathcal{O}_2^2)$ a homomorphism. Define a zero kernel $\widetilde{\text{Ker}}_0 \varrho$ of ϱ by

$$\widetilde{\text{Ker}}_0 \varrho = \{ a \in \mathcal{H} | \varrho(a) = 0_{+_i^2}, 1 \leq i \leq l_2 \}.$$

Then, for $\forall h \in \mathcal{H}$ and $a \in \widetilde{\text{Ker}}_0 \varrho$, $\varrho(a \cdot_i^1 h) = 0_{+_i^2} \varrho(\cdot_i^1 h) = 0_{+_i^2}$, i.e., $a \cdot_i h \in \widetilde{\text{Ker}}_0 \varrho$. Similarly, $h \cdot_i a \in \widetilde{\text{Ker}}_0 \varrho$. These properties imply the conception of multi-ideals of a multi-ring introduced following.

Choose a subset $\mathcal{I} \subset \mathcal{H}$. For $\forall h \in \mathcal{H}$, $a \in \mathcal{I}$, if there are

$$h \circ_i a \in \mathcal{I} \quad \text{and} \quad a \circ_i h \in \mathcal{H},$$

then \mathcal{I} is said a *multi-ideal*. Previous discussion shows that the zero kernel $\widetilde{\text{Ker}}_0 \varrho$ of a homomorphism ϱ on a multi-ring is a multi-ideal. Now let \mathcal{I} be a multi-ideal of $(\mathcal{H}; \mathcal{O}_1 \hookrightarrow \mathcal{O}_2)$. According to Corollary 2.3.1, we know that there is a representation pair (R_2, P_2) such that

$$\widetilde{\mathcal{I}} = \{ a +_i \mathcal{I} \mid a \in R_2, +_i \in P_2 \}$$

is a commutative multi-group. By the distributive laws, we find that

$$\begin{aligned} (a +_i \mathcal{I}) \cdot_j (b +_k \mathcal{I}) &= a \cdot_j b +_k a \cdot_j \mathcal{I} +_i \mathcal{I} b +_k \mathcal{I} \cdot_j \mathcal{I} \\ &= a \cdot_j b +_k \mathcal{I}. \end{aligned}$$

Similar to the proof of Theorem 2.3.1, we also know these associative and distributive laws follow in $(\widetilde{\mathcal{I}}; \mathcal{O}_1 \hookrightarrow \mathcal{O}_2)$. Whence, $(\widetilde{\mathcal{I}}; \mathcal{O}_1 \hookrightarrow \mathcal{O}_2)$ is also a multi-ring, called the *quotient multi-ring of $(\mathcal{H}; \mathcal{O}_1 \hookrightarrow \mathcal{O}_2)$* , denoted by $(\mathcal{H} : \mathcal{I})$.

Define a mapping $\varrho : (\mathcal{H}; \mathcal{O}_1 \hookrightarrow \mathcal{O}_2) \rightarrow (\mathcal{H} : \mathcal{I})$ by $\varrho(a) = a +_i \mathcal{I}$ for $\forall a \in \mathcal{H}$ if $a \in a +_i \mathcal{I}$. Then it can be checked immediately that it is a homomorphism with

$$\widetilde{\text{Ker}}_0 \varrho = \mathcal{I}.$$

Therefore, we conclude that *any multi-ideal is a zero kernel of a homomorphism on a multi-ring*. The following result is a special case of Theorem 2.3.2.

Theorem 2.3.6 *Let $(\mathcal{H}_1; \mathcal{O}_1^1 \hookrightarrow \mathcal{O}_2^1)$ and $(\mathcal{H}_2; \mathcal{O}_1^2 \hookrightarrow \mathcal{O}_2^2)$ be multi-rings and $\omega : (\mathcal{H}_1; \mathcal{O}_2^1) \rightarrow (\mathcal{H}_2; \mathcal{O}_2^2)$ be an onto homomorphism with $(\mathcal{I}(\mathcal{O}_2^2); \mathcal{O}_2^2)$ be a multi-operation system, where $\mathcal{I}(\mathcal{O}_2^2)$ denotes all units in $(\mathcal{H}_2; \mathcal{O}_2^2)$. Then there exist representation pairs $(R_1, \tilde{P}_1), (R_2, \tilde{P}_2)$ such that*

$$(\mathcal{H} : \mathcal{I})|_{(R_1, \tilde{P}_1)} \cong \frac{(\mathcal{H}_2; \mathcal{O}_1^2 \hookrightarrow \mathcal{O}_2^2)}{(\mathcal{I}(\mathcal{O}_2^2); \mathcal{O}_2^2)}|_{(R_2, \tilde{P}_2)}.$$

Particularly, if $(\mathcal{H}_2; \mathcal{O}_1^2 \hookrightarrow \mathcal{O}_2^2)$ is a ring, we get an interesting result following.

Corollary 2.3.4 *Let $(\mathcal{H}; \mathcal{O}_1 \hookrightarrow \mathcal{O}_2)$ be a multi-ring, $(R; +, \cdot)$ a ring and $\omega : (\mathcal{H}; \mathcal{O}_2) \rightarrow (R; +)$ be an onto homomorphism. Then there exists a representation pair (R, \tilde{P}) such that*

$$(\mathcal{H} : \mathcal{I})|_{(R, \tilde{P})} \cong (R; +, \cdot).$$

§2.4 MULTI-MODULES

2.4.1 Multi-Module. There multi-modules are generalization of linear spaces in linear algebra by applying results in last section. Let $\mathcal{O} = \{+_i \mid 1 \leq i \leq m\}$, $\mathcal{O}_1 = \{\cdot_i \mid 1 \leq i \leq m\}$ and $\mathcal{O}_2 = \{\dot{+}_i \mid 1 \leq i \leq m\}$ be operation sets, $(\mathcal{M}; \mathcal{O})$ a commutative m -group with units 0_{+_i} and $(\mathcal{R}; \mathcal{O}_1 \hookrightarrow \mathcal{O}_2)$ a multi-ring with a unit 1. for $\forall \cdot \in \mathcal{O}_1$. For any integer i , $1 \leq i \leq m$, define a binary operation $\times_i : \mathcal{R} \times \mathcal{M} \rightarrow \mathcal{M}$ by $a \times_i x$ for $a \in \mathcal{R}, x \in \mathcal{M}$ such that for $\forall a, b \in \mathcal{R}, \forall x, y \in \mathcal{M}$, conditions following hold:

- (i) $a \times_i (x +_i y) = a \times_i x +_i a \times_i y$;
- (ii) $(a \dot{+}_i b) \times_i x = a \times_i x +_i b \times_i x$;
- (iii) $(a \cdot_i b) \times_i x = a \times_i (b \times_i x)$;
- (iv) $1_{\cdot_i} \times_i x = x$.

Then $(\mathcal{M}; \mathcal{O})$ is said an *algebraic multi-module over $(\mathcal{R}; \mathcal{O}_1 \hookrightarrow \mathcal{O}_2)$* abbreviated to an *$m$ -module* and denoted by $\mathbf{Mod}(\mathcal{M}(\mathcal{O}) : \mathcal{R}(\mathcal{O}_1 \hookrightarrow \mathcal{O}_2))$. In the case of

$m = 1$, It is obvious that $\mathbf{Mod}(\mathcal{M}(\mathcal{O}) : \mathcal{R}(\mathcal{O}_1 \hookrightarrow \mathcal{O}_2))$ is a *module*, particularly, if $(\mathcal{R}; \mathcal{O}_1 \hookrightarrow \mathcal{O}_2)$ is a field, then $\mathbf{Mod}(\mathcal{M}(\mathcal{O}) : \mathcal{R}(\mathcal{O}_1 \hookrightarrow \mathcal{O}_2))$ is a *linear space* in classical algebra.

For any integer k , $a_i \in \mathcal{R}$ and $x_i \in \mathcal{M}$, where $1 \leq i$, $k \leq s$, equalities following are hold by induction on the definition of m -modules.

$$\begin{aligned} a \times_k (x_1 +_k x_2 +_k \cdots +_k x_s) &= a \times_k x_1 +_k a \times_k x_2 +_k \cdots +_k a_s \times_k x, \\ (a_1 \dot{+}_k a_2 \dot{+}_k \cdots \dot{+}_k a_s) \times_k x &= a_1 \times_k x +_k a_2 \times_k x +_k \cdots +_k a_s \times_k x, \\ (a_1 \cdot_k a_2 \cdot_k \cdots \cdot_k a_s) \times_k x &= a_1 \times_k (a_2 \times_k \cdots \times_k (a_s \times_k x) \cdots) \end{aligned}$$

and

$$1_{i_1} \times_{i_1} (1_{i_2} \times_{i_2} \cdots \times_{i_{s-1}} (1_{i_s} \times_{i_s} x) \cdots) = x$$

for integers $i_1, i_2, \dots, i_s \in \{1, 2, \dots, m\}$.

Notice that for $\forall a, x \in \mathcal{M}$, $1 \leq i \leq m$,

$$a \times_i x = a \times_i (x +_i 0_{+i}) = a \times_i x +_i a \times_i 0_{+i},$$

we find that $a \times_i 0_{+i} = 0_{+i}$. Similarly, $0_{+i} \times_i a = 0_{+i}$. Applying this fact, we know that

$$a \times_i x +_i a_{+i}^- \times_i x = (a \dot{+}_i a_{+i}^-) \times_i x = 0_{+i} \times_i x = 0_{+i}$$

and

$$a \times_i x +_i a \times_i x_{+i}^- = a \times_i (x +_i x_{+i}^-) = a \times_i 0_{+i} = 0_{+i}.$$

We know that

$$(a \times_i x)_{+i}^- = a_{+i}^- \times_i x = a \times_i x_{+i}^-.$$

Notice that $a \times_i x = 0_{+i}$ does not always mean $a = 0_{+i}$ or $x = 0_{+i}$ in an m -module $\mathbf{Mod}(\mathcal{M}(\mathcal{O}) : \mathcal{R}(\mathcal{O}_1 \hookrightarrow \mathcal{O}_2))$ unless a_{+i}^- is existing in $(\mathcal{R}; \dot{+}_i, \cdot_i)$ if $x \neq 0_{+i}$.

Now choose $\mathbf{Mod}(\mathcal{M}_1(\mathcal{O}_1) : \mathcal{R}_1(\mathcal{O}_1^1 \hookrightarrow \mathcal{O}_2^1))$ an m -module with operation sets $\mathcal{O}_1 = \{+_i^1 \mid 1 \leq i \leq m\}$, $\mathcal{O}_1^1 = \{\dot{+}_i^1 \mid 1 \leq i \leq m\}$, $\mathcal{O}_2^1 = \{\dot{+}_i^1 \mid 1 \leq i \leq m\}$ and $\mathbf{Mod}(\mathcal{M}_2(\mathcal{O}_2) : \mathcal{R}_2(\mathcal{O}_2^1 \hookrightarrow \mathcal{O}_2^2))$ an n -module with operation sets $\mathcal{O}_2 = \{+_i^2 \mid 1 \leq i \leq n\}$, $\mathcal{O}_1^2 = \{\dot{+}_i^2 \mid 1 \leq i \leq n\}$, $\mathcal{O}_2^2 = \{\dot{+}_i^2 \mid 1 \leq i \leq n\}$. They are said *homomorphic* if there is a mapping $\iota : \mathcal{M}_1 \rightarrow \mathcal{M}_2$ such that for any integer i , $1 \leq i \leq m$,

- (i) $\iota(x +'_i y) = \iota(x) +'' \iota(y)$ for $\forall x, y \in \mathcal{M}_1$, where $\iota(+'_i) = +'' \in \mathcal{O}_2$;
- (ii) $\iota(a \times_i x) = a \times_i \iota(x)$ for $\forall x \in \mathcal{M}_1$.

If ι is a bijection, these modules $\mathbf{Mod}(\mathcal{M}_1(\mathcal{O}_1) : \mathcal{R}_1(\mathcal{O}_1^1 \hookrightarrow \mathcal{O}_2^1))$ and $\mathbf{Mod}(\mathcal{M}_2(\mathcal{O}_2) : \mathcal{R}_2(\mathcal{O}_1^2 \hookrightarrow \mathcal{O}_2^2))$ are said to be *isomorphic*, denoted by

$$\mathbf{Mod}(\mathcal{M}_1(\mathcal{O}_1) : \mathcal{R}_1(\mathcal{O}_1^1 \hookrightarrow \mathcal{O}_2^1)) \cong \mathbf{Mod}(\mathcal{M}_2(\mathcal{O}_2) : \mathcal{R}_2(\mathcal{O}_1^2 \hookrightarrow \mathcal{O}_2^2)).$$

Let $\mathbf{Mod}(\mathcal{M}(\mathcal{O}) : \mathcal{R}(\mathcal{O}_1 \hookrightarrow \mathcal{O}_2))$ be an m -module. For a multi-subgroup $(\mathcal{N}; \mathcal{O})$ of $(\mathcal{M}; \mathcal{O})$, if for any integer i , $1 \leq i \leq m$, $a \times_i x \in \mathcal{N}$ for $\forall a \in \mathcal{R}$ and $x \in \mathcal{N}$, then by definition it is itself an m -module, called a multi-submodule of $\mathbf{Mod}(\mathcal{M}(\mathcal{O}) : \mathcal{R}(\mathcal{O}_1 \hookrightarrow \mathcal{O}_2))$.

Now if $\mathbf{Mod}(\mathcal{N}(\mathcal{O}) : \mathcal{R}(\mathcal{O}_1 \hookrightarrow \mathcal{O}_2))$ is a multi-submodule of $\mathbf{Mod}(\mathcal{M}(\mathcal{O}) : \mathcal{R}(\mathcal{O}_1 \hookrightarrow \mathcal{O}_2))$, by Theorem 2.3.2, we can get a quotient multi-group $\frac{\mathcal{N}}{\mathcal{N}}|_{(R, \tilde{P})}$ with a representation pair (R, \tilde{P}) under operations

$$(a +_i \mathcal{N}) + (b +_j \mathcal{N}) = (a + b) +_i \mathcal{N}$$

for $\forall a, b \in R, + \in \mathcal{O}$. For convenience, we denote elements $x +_i \mathcal{N}$ in $\frac{\mathcal{N}}{\mathcal{N}}|_{(R, \tilde{P})}$ by $\overline{x^{(i)}}$. For an integer i , $1 \leq i \leq m$ and $\forall a \in \mathcal{R}$, define

$$a \times_i \overline{x^{(i)}} = \overline{(a \times_i x)^{(i)}}.$$

Then it can be shown immediately that

- (i) $a \times_i (\overline{x^{(i)}} +_i \overline{y^{(i)}}) = \overline{(a \times_i x +_i y)^{(i)}}$;
- (ii) $(a +_i b) \times_i \overline{x^{(i)}} = \overline{(a +_i x)^{(i)}} +_i \overline{(b \times_i x)^{(i)}}$;
- (iii) $(a \cdot_i b) \times_i \overline{x^{(i)}} = \overline{(a \times_i (b \times_i x)^{(i)})}$;
- (iv) $1 \cdot_i \times_i \overline{x^{(i)}} = \overline{x^{(i)}}$,

i.e., $(\frac{\mathcal{N}}{\mathcal{N}}|_{(R, \tilde{P})} : \mathcal{R})$ is also an m -module, called a quotient module of $\mathbf{Mod}(\mathcal{M}(\mathcal{O}) : \mathcal{R}(\mathcal{O}_1 \hookrightarrow \mathcal{O}_2))$ to $\mathbf{Mod}(\mathcal{N}(\mathcal{O}) : \mathcal{R}(\mathcal{O}_1 \hookrightarrow \mathcal{O}_2))$. Denoted by $\mathbf{Mod}(\mathcal{M}/\mathcal{N})$.

The result on homomorphisms of m -modules following is an immediately consequence of Theorem 2.3.6.

Theorem 2.4.1 *Let $\mathbf{Mod}(\mathcal{M}_1(\mathcal{O}_1) : \mathcal{R}_1(\mathcal{O}_1^1 \hookrightarrow \mathcal{O}_2^1))$, $\mathbf{Mod}(\mathcal{M}_2(\mathcal{O}_2) : \mathcal{R}_2(\mathcal{O}_1^2 \hookrightarrow \mathcal{O}_2^2))$ be multi-modules with $\mathcal{O}_1 = \{ +'_i \mid 1 \leq i \leq m \}$, $\mathcal{O}_2 = \{ +''_i \mid 1 \leq i \leq n \}$, $\mathcal{O}_1^1 = \{ \cdot^1_i \mid 1 \leq i \leq m \}$, $\mathcal{O}_2^1 = \{ \cdot^1_i \mid 1 \leq i \leq m \}$, $\mathcal{O}_1^2 = \{ \cdot^2_i \mid 1 \leq i \leq n \}$, $\mathcal{O}_2^2 = \{ \cdot^2_i \mid 1 \leq i \leq n \}$*

$i \leq n\}$ and $\iota : \mathbf{Mod}(\mathcal{M}_1(\mathcal{O}_1) : \mathcal{R}_1(\mathcal{O}_1^1 \hookrightarrow \mathcal{O}_2^1)) \rightarrow \mathbf{Mod}(\mathcal{M}_2(\mathcal{O}_2) : \mathcal{R}_2(\mathcal{O}_1^2 \hookrightarrow \mathcal{O}_2^2))$ be a onto homomorphism with $(\mathcal{I}(\mathcal{O}_2); \mathcal{O}_2)$ a multi-group, where $\mathcal{I}(\mathcal{O}_2^2)$ denotes all units in the commutative multi-group $(\mathcal{M}_2; \mathcal{O}_2)$. Then there exist representation pairs $(R_1, \tilde{P}_1), (R_2, \tilde{P}_2)$ such that

$$\mathbf{Mod}(\mathcal{M}/\mathcal{N})|_{(R_1, \tilde{P}_1)} \cong \mathbf{Mod}(\mathcal{M}_2(\mathcal{O}_2)/\mathcal{I}(\mathcal{O}_2))|_{(R_2, \tilde{P}_2)},$$

where $\mathcal{N} = \text{Ker}\iota$ is the kernel of ι . Particularly, if $(\mathcal{I}(\mathcal{O}_2); \mathcal{O}_2)$ is trivial, i.e., $|\mathcal{I}(\mathcal{O}_2)| = 1$, then

$$\mathbf{Mod}(\mathcal{M}/\mathcal{N})|_{(R_1, \tilde{P}_1)} \cong \mathbf{Mod}(\mathcal{M}_2(\mathcal{O}_2) : \mathcal{R}_2(\mathcal{O}_1^2 \hookrightarrow \mathcal{O}_2^2))|_{(R_2, \tilde{P}_2)}.$$

Proof Notice that $(\mathcal{I}(\mathcal{O}_2); \mathcal{O}_2)$ is a commutative multi-group. We can certainly construct a quotient module $\mathbf{Mod}(\mathcal{M}_2(\mathcal{O}_2)/\mathcal{I}(\mathcal{O}_2))$. Applying Theorem 2.3.6, we find that

$$\mathbf{Mod}(\mathcal{M}/\mathcal{N})|_{(R_1, \tilde{P}_1)} \cong \mathbf{Mod}(\mathcal{M}_2(\mathcal{O}_2)/\mathcal{I}(\mathcal{O}_2))|_{(R_2, \tilde{P}_2)}.$$

Notice that $\mathbf{Mod}(\mathcal{M}_2(\mathcal{O}_2)/\mathcal{I}(\mathcal{O}_2)) = \mathbf{Mod}(\mathcal{M}_2(\mathcal{O}_2) : \mathcal{R}_2(\mathcal{O}_1^2 \hookrightarrow \mathcal{O}_2^2))$ in the case of $|\mathcal{I}(\mathcal{O}_2)| = 1$. We get the isomorphism as desired. \square

Corollary 2.4.1 *Let $\mathbf{Mod}(\mathcal{M}(\mathcal{O}) : \mathcal{R}(\mathcal{O}_1 \hookrightarrow \mathcal{O}_2))$ be an m -module with $\mathcal{O} = \{+_i \mid 1 \leq i \leq m\}$, $\mathcal{O}_1 = \{ \cdot_i \mid 1 \leq i \leq m\}$, $\mathcal{O}_2 = \{ \dot{+}_i \mid 1 \leq i \leq m\}$, M a module on a ring $(R; +, \cdot)$ and $\iota : \mathbf{Mod}(\mathcal{M}_1(\mathcal{O}_1) : \mathcal{R}_1(\mathcal{O}_1^1 \hookrightarrow \mathcal{O}_2^1)) \rightarrow M$ a onto homomorphism with $\text{Ker}\iota = \mathcal{N}$. Then there exists a representation pair (R', \tilde{P}) such that*

$$\mathbf{Mod}(\mathcal{M}/\mathcal{N})|_{(R', \tilde{P})} \cong M,$$

particularly, if $\mathbf{Mod}(\mathcal{M}(\mathcal{O}) : \mathcal{R}(\mathcal{O}_1 \hookrightarrow \mathcal{O}_2))$ is a module \mathcal{M} , then

$$\mathcal{M}/\mathcal{N} \cong M.$$

2.4.2 Finite Dimensional Multi-Module. For constructing multi-submodules of an m -module $\mathbf{Mod}(\mathcal{M}(\mathcal{O}) : \mathcal{R}(\mathcal{O}_1 \hookrightarrow \mathcal{O}_2))$ with $\mathcal{O} = \{+_i \mid 1 \leq i \leq m\}$, $\mathcal{O}_1 = \{ \cdot_i \mid 1 \leq i \leq m\}$, $\mathcal{O}_2 = \{ \dot{+}_i \mid 1 \leq i \leq m\}$, a general way is described in the following.

Let $\widehat{S} \subset \mathcal{M}$ with $|\widehat{S}| = n$. Define its *linearly spanning set* $\langle \widehat{S} | \mathcal{R} \rangle$ in $\mathbf{Mod}(\mathcal{M}(\mathcal{O}) : \mathcal{R}(\mathcal{O}_1 \hookrightarrow \mathcal{O}_2))$ to be

$$\langle \widehat{S} | \mathcal{R} \rangle = \left\{ \bigoplus_{i=1}^m \bigoplus_{j=1}^n \alpha_{ij} \times_i x_{ij} \mid \alpha_{ij} \in \mathcal{R}, x_{ij} \in \widehat{S} \right\},$$

where

$$\begin{aligned} \bigoplus_{i=1}^m \bigoplus_{j=1}^n a_{ij} \times_{ij} x_i &= a_{11} \times_1 x_{11} +_1 \cdots +_1 a_{1n} \times_1 x_{1n} \\ &+^{(1)} a_{21} \times_2 x_{21} +_2 \cdots +_2 a_{2n} \times_2 x_{2n} \\ &+^{(2)} \dots \dots \dots +^{(3)} \\ &a_{m1} \times_m x_{m1} +_m \cdots +_m a_{mn} \times_m x_{mn} \end{aligned}$$

with $+^{(1)}, +^{(2)}, +^{(3)} \in \mathcal{O}$ and particularly, if $+_1 = +_2 = \cdots = +_m$, it is denoted by $\sum_{i=1}^m x_i$ as usual. It can be checked easily that $\langle \widehat{S} | \mathcal{R} \rangle$ is a multi-submodule of $\mathbf{Mod}(\mathcal{M}(\mathcal{O}) : \mathcal{R}(\mathcal{O}_1 \hookrightarrow \mathcal{O}_2))$, call it *generated by \widehat{S} in $\mathbf{Mod}(\mathcal{M}(\mathcal{O}) : \mathcal{R}(\mathcal{O}_1 \hookrightarrow \mathcal{O}_2))$* . If \widehat{S} is finite, we also say that $\langle \widehat{S} | \mathcal{R} \rangle$ is *finitely generated*. Particularly, if $\widehat{S} = \{x\}$, then $\langle \widehat{S} | \mathcal{R} \rangle$ is called a *cyclic multi-submodule of $\mathbf{Mod}(\mathcal{M}(\mathcal{O}) : \mathcal{R}(\mathcal{O}_1 \hookrightarrow \mathcal{O}_2))$* , denoted by $\mathcal{R}x$. Notice that

$$\mathcal{R}x = \left\{ \bigoplus_{i=1}^m a_i \times_i x \mid a_i \in \mathcal{R} \right\}$$

by definition. For any finite set \widehat{S} , if for any integer $s, 1 \leq s \leq m$,

$$\bigoplus_{i=1}^m \bigoplus_{j=1}^{s_i} \alpha_{ij} \times_i x_{ij} = 0_{+_s}$$

implies that $\alpha_{ij} = 0_{+_s}$ for $1 \leq i \leq m, 1 \leq j \leq n$, then we say that $\{x_{ij} \mid 1 \leq i \leq m, 1 \leq j \leq n\}$ is independent and \widehat{S} a *basis of the multi-module $\mathbf{Mod}(\mathcal{M}(\mathcal{O}) : \mathcal{R}(\mathcal{O}_1 \hookrightarrow \mathcal{O}_2))$* , denoted by $\langle \widehat{S} | \mathcal{R} \rangle = \mathbf{Mod}(\mathcal{M}(\mathcal{O}) : \mathcal{R}(\mathcal{O}_1 \hookrightarrow \mathcal{O}_2))$.

For a multi-ring $(\mathcal{R}; \mathcal{O}_1 \hookrightarrow \mathcal{O}_2)$ with a unit 1, for $\forall \cdot \in \mathcal{O}_1$, where $\mathcal{O}_1 = \{\cdot_i \mid 1 \leq i \leq m\}$ and $\mathcal{O}_2 = \{\cdot_i \mid 1 \leq i \leq m\}$, let

$$\mathcal{R}^{(n)} = \{(x_1, x_2, \dots, x_n) \mid x_i \in \mathcal{R}, 1 \leq i \leq n\}.$$

Define operations

$$(x_1, x_2, \dots, x_n) +_i (y_1, y_2, \dots, y_n) = (x_1 +_i y_1, x_2 +_i y_2, \dots, x_n +_i y_n)$$

and

$$a \times_i (x_1, x_2, \dots, x_n) = (a \cdot_i x_1, a \cdot_i x_2, \dots, a \cdot_i x_n)$$

for $\forall a \in \mathcal{R}$ and integers $1 \leq i \leq m$. Then it can be immediately known that $\mathcal{R}^{(n)}$ is a multi-module $\mathbf{Mod}(\mathcal{R}^{(n)} : \mathcal{R}(\mathcal{O}_1 \hookrightarrow \mathcal{O}_2))$. We construct a basis of this special multi-module in the following.

For any integer $k, 1 \leq k \leq n$, let

$$\begin{aligned} \mathbf{e}_1 &= (1_{\cdot k}, 0_{+k}, \dots, 0_{+k}); \\ \mathbf{e}_2 &= (0_{+k}, 1_{\cdot k}, \dots, 0_{+k}); \\ &\dots\dots\dots; \\ \mathbf{e}_n &= (0_{+k}, \dots, 0_{+k}, 1_{\cdot k}). \end{aligned}$$

Notice that

$$(x_1, x_2, \dots, x_n) = x_1 \times_k \mathbf{e}_1 +_k x_2 \times_k \mathbf{e}_2 +_k \dots +_k x_n \times_k \mathbf{e}_n.$$

We find that each element in $\mathcal{R}^{(n)}$ is generated by $\mathbf{e}_1, \mathbf{e}_2, \dots, \mathbf{e}_n$. Now since

$$(x_1, x_2, \dots, x_n) = (0_{+k}, 0_{+k}, \dots, 0_{+k})$$

implies that $x_i = 0_{+k}$ for any integer $i, 1 \leq i \leq n$. Whence, $\{\mathbf{e}_1, \mathbf{e}_2, \dots, \mathbf{e}_n\}$ is a basis of $\mathbf{Mod}(\mathcal{R}^{(n)} : \mathcal{R}(\mathcal{O}_1 \hookrightarrow \mathcal{O}_2))$.

Theorem 2.4.2 *Let $\mathbf{Mod}(\mathcal{M}(\mathcal{O}) : \mathcal{R}(\mathcal{O}_1 \hookrightarrow \mathcal{O}_2)) = \langle \widehat{S} | \mathcal{R} \rangle$ be a finitely generated multi-module with $\widehat{S} = \{u_1, u_2, \dots, u_n\}$. Then*

$$\mathbf{Mod}(\mathcal{M}(\mathcal{O}) : \mathcal{R}(\mathcal{O}_1 \hookrightarrow \mathcal{O}_2)) \cong \mathbf{Mod}(\mathcal{R}^{(n)} : \mathcal{R}(\mathcal{O}_1 \hookrightarrow \mathcal{O}_2)).$$

Proof Define a mapping $\vartheta : \mathcal{M}(\mathcal{O}) \rightarrow \mathcal{R}^{(n)}$ by $\vartheta(u_i) = \mathbf{e}_i, \vartheta(a \times_j u_i) = a \times_j \mathbf{e}_j$ and $\vartheta(u_i +_k u_j) = \mathbf{e}_i +_k \mathbf{e}_j$ for any integers i, j, k , where $1 \leq i, j, k \leq n$. Then we know that

$$\vartheta\left(\bigoplus_{i=1}^m \bigoplus_{j=1}^n a_{ij} \times_i u_i\right) = \bigoplus_{i=1}^m \bigoplus_{j=1}^n a_{ij} \times_i \mathbf{e}_i.$$

Whence, ϑ is a homomorphism. Notice that it is also 1 – 1 and onto. We know that ϑ is an isomorphism between $\mathbf{Mod}(\mathcal{M}(\mathcal{O}) : \mathcal{R}(\mathcal{O}_1 \hookrightarrow \mathcal{O}_2))$ and $\mathbf{Mod}(\mathcal{R}^{(n)} : \mathcal{R}(\mathcal{O}_1 \hookrightarrow \mathcal{O}_2))$. □

§2.5 ACTIONS OF MULTI-GROUPS

2.5.1 Construction of Permutation Multi-Group. Let $X = \{x_1, x_2, \dots\}$ be a finite set. As defined in Subsection 1.3.1, a *composition operation on two permutations*

$$\tau = \begin{pmatrix} x_1 & x_2 & \cdots & x_n \\ y_1 & y_2 & \cdots & y_n, \end{pmatrix},$$

and

$$\varsigma = \begin{pmatrix} y_1 & y_2 & \cdots & y_n \\ z_1 & z_2 & \cdots & z_n, \end{pmatrix},$$

are defined to be

$$\sigma = \begin{pmatrix} x_1 & x_2 & \cdots & x_n \\ y_1 & y_2 & \cdots & y_n, \end{pmatrix} \begin{pmatrix} y_1 & y_2 & \cdots & y_n \\ z_1 & z_2 & \cdots & z_n, \end{pmatrix} = \begin{pmatrix} x_1 & x_2 & \cdots & x_n \\ z_1 & z_2 & \cdots & z_n, \end{pmatrix}.$$

As we have pointed out in Section 2.2.3, all permutations form a group $\Pi(X)$ under the composition operation.

For $\forall p \in \Pi(X)$, define an operation $\circ_p : \Pi(X) \times \Pi(X) \rightarrow \Pi(X)$ by

$$\sigma \circ_p \varsigma = \sigma p \varsigma, \quad \text{for } \forall \sigma, \varsigma \in \Pi(X).$$

Then we have

Theorem 2.5.1 $(\Pi(X); \circ_p)$ is a group.

Proof We check these conditions for a group hold in $(\Pi(X); \circ_p)$. In fact, for $\forall \tau, \sigma, \varsigma \in \Pi(X)$,

$$\begin{aligned} (\tau \circ_p \sigma) \circ_p \varsigma &= (\tau p \sigma) \circ_p \varsigma = \tau p \sigma p \varsigma \\ &= \tau p (\sigma \circ_p \varsigma) = \tau \circ_p (\sigma \circ_p \varsigma). \end{aligned}$$

The unit in $(\Pi(X); \circ_p)$ is $1_{\circ_p} = p^{-1}$. In fact, for $\forall \theta \in \Pi(X)$, we have that $p^{-1} \circ_p \theta = \theta \circ_p p^{-1} = \theta$.

For an element $\sigma \in \Pi(X)$, $\sigma_{\circ_p}^{-1} = p^{-1} \sigma^{-1} p^{-1} = (p\sigma p)^{-1}$. In fact,

$$\sigma \circ_p (p\sigma p)^{-1} = \sigma p p^{-1} \sigma^{-1} p^{-1} = p^{-1} = 1_{\circ_p},$$

$$(p\sigma p)^{-1} \circ_p \sigma = p^{-1} \sigma^{-1} p^{-1} p \sigma = p^{-1} = 1_{\circ_p}.$$

By definition, we know that $(\Pi(X); \circ_p)$ is a group. \square

Notice that if $p = \mathbf{1}_X$, the operation \circ_p is just the composition operation and $(\Pi(X); \circ_p)$ is the symmetric group $Sym(X)$ on X . Furthermore, Theorem 2.5.1 opens a general way for constructing multi-groups on permutations, which enables us to find the next result.

Theorem 2.5.2 *Let Γ be a permutation group on X , i.e., $\Gamma \prec Sim(X)$. For given m permutations $p_1, p_2, \dots, p_m \in \Gamma$, $(\Gamma; \mathcal{O}_P)$ with $\mathcal{O}_P = \{\circ_p, p \in P\}$, $P = \{p_i, 1 \leq i \leq m\}$ is a permutation multi-group, denoted by \mathcal{G}_X^P .*

Proof First, we check that $(\Gamma; \{\circ_{p_i}, 1 \leq i \leq m\})$ is an associative system. Actually, for $\forall \sigma, \varsigma, \tau \in \mathcal{G}$ and $p, q \in \{p_1, p_2, \dots, p_m\}$, we know that

$$\begin{aligned} (\tau \circ_p \sigma) \circ_q \varsigma &= (\tau p \sigma) \circ_q \varsigma = \tau p \sigma q \varsigma \\ &= \tau p (\sigma \circ_q \varsigma) = \tau \circ_p (\sigma \circ_q \varsigma). \end{aligned}$$

Similar to the proof of Theorem 2.5.1, we know that $(\Gamma; \circ_{p_i})$ is a group for any integer $i, 1 \leq i \leq m$. In fact, $1_{\circ_{p_i}} = p_i^{-1}$ and $\sigma_{\circ_{p_i}}^{-1} = (p_i \sigma p_i)^{-1}$ in $(\mathcal{G}; \circ_{p_i})$. \square

The construction for permutation multi-groups shown in Theorems 2.5.1–2.5.2 can be also transferred to permutations on vector as follows, which is useful in some circumstances.

Choose m permutations p_1, p_2, \dots, p_m on X . An m -permutation on $x \in X$ is defined by

$$p^{(m)} : x \rightarrow (p_1(x), p_2(x), \dots, p_m(x)),$$

i.e., an m -vector on x .

Denoted by $\Pi^{(s)}(X)$ all such s -vectors $p^{(m)}$. Let \circ be an operation on X . Define a *bullet operation of two m -permutations*

$$P^{(m)} = (p_1, p_2, \dots, p_m),$$

$$Q^{(sm)} = (q_1, q_2, \dots, q_m)$$

on \circ by

$$P^{(s)} \bullet Q^{(s)} = (p_1 \circ q_1, p_2 \circ q_2, \dots, p_m \circ q_m).$$

Whence, if there are l -operations $\circ_i, 1 \leq i \leq l$ on X , we obtain an s -permutation system $\Pi^{(s)}(X)$ under these l bullet operations $\bullet_i, 1 \leq i \leq l$, denoted by $(\Pi^{(s)}(X); \odot_1^l)$, where $\odot_1^l = \{\bullet_i | 1 \leq i \leq l\}$.

Theorem 2.5.3 Any s -operation system (\mathcal{H}, \tilde{O}) on \mathcal{H} with units 1_{\circ_i} for each operation $\circ_i, 1 \leq i \leq s$ in \tilde{O} is isomorphic to an s -permutation system $(\Pi^{(s)}(\mathcal{H}); \odot_1^s)$.

Proof For $a \in \mathcal{H}$, define an s -permutation $\sigma_a \in \Pi^{(s)}(\mathcal{H})$ by

$$\sigma_a(x) = (a \circ_1 x, a \circ_2 x, \dots, a \circ_s x)$$

for $\forall x \in \mathcal{H}$.

Now let $\pi : \mathcal{H} \rightarrow \Pi^{(s)}(\mathcal{H})$ be determined by $\pi(a) = \sigma_a^{(s)}$ for $\forall a \in \mathcal{H}$. Since

$$\sigma_a(1_{\circ_i}) = (a \circ_1 1_{\circ_i}, \dots, a \circ_{i-1} 1_{\circ_i}, a, a \circ_{i+1} 1_{\circ_i}, \dots, a \circ_s 1_{\circ_i}),$$

we know that for $a, b \in \mathcal{H}$, $\sigma_a \neq \sigma_b$ if $a \neq b$. Hence, π is a 1-1 and onto mapping. For $\forall i, 1 \leq i \leq s$ and $\forall x \in \mathcal{H}$, we find that

$$\begin{aligned} \pi(a \circ_i b)(x) &= \sigma_{a \circ_i b}(x) \\ &= (a \circ_i b \circ_1 x, a \circ_i b \circ_2 x, \dots, a \circ_i b \circ_s x) \\ &= (a \circ_1 x, a \circ_2 x, \dots, a \circ_s x) \bullet_i (b \circ_1 x, b \circ_2 x, \dots, b \circ_s x) \\ &= \sigma_a(x) \bullet_i \sigma_b(x) = \pi(a) \bullet_i \pi(b)(x). \end{aligned}$$

Therefore, $\pi(a \circ_i b) = \pi(a) \bullet_i \pi(b)$, which implies that π is an isomorphism from (\mathcal{H}, \tilde{O}) to $(\Pi^{(s)}(\mathcal{H}); \odot_1^s)$. \square

According to Theorem 2.5.3, these algebraic multi-systems are the same as permutation multi-systems, particularly for multi-groups.

Corollary 2.5.1 Any s -group (\mathcal{H}, \tilde{O}) with $\tilde{O} = \{\circ_i | 1 \leq i \leq s\}$ is isomorphic to an s -permutation multi-group $(\Pi^{(s)}(\mathcal{H}); \odot_1^s)$.

Proof It can be shown easily that $(\Pi^{(s)}(\mathcal{H}); \odot_1^s)$ is a multi-group if (\mathcal{H}, \tilde{O}) is a multi-group. \square

For the special case of $s = 1$ in Corollary 2.5.1, we get the well-known Cayley result on groups.

Corollary 2.5.2(Cayley) A group G is isomorphic to a permutation group.

As shown in Theorem 2.5.2, many operations can be defined on a permutation group G , which enables it to be a permutation multi-group, and generally, these operations $\circ_i, 1 \leq i \leq s$ on permutations in Theorem 2.5.3 need not to be the composition of permutations. If we choose all $\circ_i, 1 \leq i \leq s$ to be just the composition of permutation, then all bullet operations in \odot_1^s is the same, denoted by \odot . We find an interesting result following which also implies the Cayley's result on groups, i.e., Corollary 2.5.2.

Theorem 2.5.4 $(\Pi^{(s)}(\mathcal{H}); \odot)$ is a group of order $\frac{(n!)!}{(n!-s)!}$.

Proof By definition, we know that

$$P^{(s)}(x) \odot Q^{(s)}(x) = (P_1 Q_1(x), P_2 Q_2(x), \dots, P_s Q_s(x))$$

for $\forall P^{(s)}, Q^{(s)} \in \Pi^{(s)}(\mathcal{H})$ and $\forall x \in \mathcal{H}$. Whence, $(1, 1, \dots, 1)$ (l entries 1) is the unit and $(P^{-s}) = (P_1^{-1}, P_2^{-1}, \dots, P_s^{-1})$ the inverse of $P^{(s)} = (P_1, P_2, \dots, P_s)$ in $(\Pi^{(s)}(\mathcal{H}); \odot)$. Therefore, $(\Pi^{(s)}(\mathcal{H}); \odot)$ is a group.

Calculation shows that the order of $\Pi^{(s)}(\mathcal{H})$ is

$$\binom{n!}{s} s! = \frac{(n!)!}{(n!-s)!},$$

which completes the proof. \square

2.5.2 Action of Multi-group. Let $(\tilde{\mathcal{A}}; \tilde{\mathcal{O}})$ be a multi-group, where $\tilde{\mathcal{A}} = \bigcup_{i=1}^m \mathcal{H}_i$, $\tilde{\mathcal{O}} = \bigcup_{i=1}^m \mathcal{O}_i$, and $\tilde{X} = \bigcup_{i=1}^m X_i$ a multi-set. An action φ of $(\tilde{\mathcal{A}}; \tilde{\mathcal{O}})$ on \tilde{X} is defined to

be a homomorphism

$$\varphi : (\widetilde{\mathcal{A}}; \widetilde{\mathcal{O}}) \rightarrow \bigcup_{i=1}^m \mathcal{G}_{X_i}^{P_i}$$

for sets $P_1, P_2, \dots, P_m \geq 1$ of permutations, i.e., for $\forall h \in \mathcal{H}_i, 1 \leq i \leq m$, there is a permutation $\varphi(h) : x \rightarrow x^h$ with conditions following hold,

$$\varphi(h \circ g) = \varphi(h)\varphi(\circ)\varphi(g), \text{ for } h, g \in \mathcal{H}_i \text{ and } \circ \in \mathcal{O}_i.$$

Whence, we only need to consider the action of permutation multi-groups on multi-sets. Let $(\widetilde{\mathcal{A}}; \widetilde{\mathcal{O}})$ be a multi-group action on a multi-set \widetilde{X} , denoted by \mathcal{G} . For a subset $\Delta \subset \widetilde{X}, x \in \Delta$, we define

$$x^{\mathcal{G}} = \{ x^g \mid \forall g \in \mathcal{G} \} \text{ and } \mathcal{G}_x = \{ g \mid x^g = x, g \in \mathcal{G} \},$$

called the *orbit* and *stabilizer* of x under the action of \mathcal{G} and sets

$$\mathcal{G}_\Delta = \{ g \mid x^g = x, g \in \mathcal{G} \text{ for } \forall x \in \Delta \},$$

$$\mathcal{G}(\Delta) = \{ g \mid \Delta^g = \Delta, g \in \mathcal{G} \text{ for } \forall x \in \Delta \},$$

respectively. Then we know the result following.

Theorem 2.5.5 *Let Γ be a permutation group action on X and \mathcal{G}_X^P a permutation multi-group $(\Gamma; \mathcal{O}_P)$ with $P = \{p_1, p_2, \dots, p_m\}$ and $p_i \in \Gamma$ for integers $1 \leq i \leq m$. Then*

$$(i) \quad |\mathcal{G}_X^P| = |(\mathcal{G}_X^P)_x| |x^{\mathcal{G}_X^P}|, \forall x \in X;$$

(ii) *for $\forall \Delta \subset X, ((\mathcal{G}_X^P)_\Delta, \mathcal{O}_P)$ is a permutation multi-group if and only if $p_i \in P$ for $1 \leq i \leq m$.*

Proof By definition, we know that

$$(\mathcal{G}_X^P)_x = \Gamma_x, \text{ and } x^{\mathcal{G}_X^P} = x^\Gamma$$

for $x \in X$ and $\Delta \subset X$. Assume that $x^\Gamma = \{x_1, x_2, \dots, x_l\}$ with $x^{g_i} = x_i$. Then we must have

$$\Gamma = \bigcup_{i=1}^l g_i \Gamma_x.$$

In fact, for $\forall h \in \Gamma$, let $x^h = x_k, 1 \leq k \leq m$. Then $x^h = x^{g^k}$, i.e., $x^{hg_k^{-1}} = x$. Whence, we get that $hg_k^{-1} \in \Gamma_x$, namely, $h \in g_k\Gamma_x$.

For integers $i, j, i \neq j$, there are must be $g_i\Gamma_x \cap g_j\Gamma_x = \emptyset$. Otherwise, there exist $h_1, h_2 \in \Gamma_x$ such that $g_i h_1 = g_j h_2$. We get that $x_i = x^{g_i} = x^{g_j h_2 h_1^{-1}} = x^{g_j} = x_j$, a contradiction.

Therefore, we find that

$$|\mathcal{G}_X^P| = |\Gamma| = |\Gamma_x||x^\Gamma| = |(\mathcal{G}_X^P)_x||x^{\mathcal{G}_X^P}|.$$

This is the assertion (i). For (ii), notice that $(\mathcal{G}_X^P)_\Delta = \Gamma_\Delta$ and Γ_Δ is itself a permutation group. Applying Theorem 2.5.2, we find it. \square

Particularly, for a permutation group Γ action on Ω , i.e., all $p_i = \mathbf{1}_X$ for $1 \leq i \leq m$, we get a consequence of Theorem 2.5.5.

Corollary 2.5.3 *Let Γ be a permutation group action on Ω . Then*

- (i) $|\Gamma| = |\Gamma_x||x^\Gamma|, \forall x \in \Omega;$
- (ii) *for $\forall \Delta \subset \Omega, \Gamma_\Delta$ is a permutation group.*

Theorem 2.5.6 *Let Γ be a permutation group action on X and \mathcal{G}_X^P a permutation multi-group $(\Gamma; \mathcal{O}_P)$ with $P = \{p_1, p_2, \dots, p_m\}, p_i \in \Gamma$ for integers $1 \leq i \leq m$ and $Orb(X)$ the orbital sets of \mathcal{G}_X^P action on X . Then*

$$|Orb(X)| = \frac{1}{|\mathcal{G}_X^P|} \sum_{p \in \mathcal{G}_X^P} |\Phi(p)|,$$

where $\Phi(p)$ is the fixed set of p , i.e., $\Phi(p) = \{x \in X | x^p = x\}$.

Proof Consider a set $E = \{(p, x) \in \mathcal{G}_X^P \times X | x^p = x\}$. Then we know that $E(p, *) = \Phi(p)$ and $E(*, x) = (\mathcal{G}_X^P)_x$. Counting these elements in E , we find that

$$\sum_{p \in \mathcal{G}_X^P} |\Phi(p)| = \sum_{x \in X} (\mathcal{G}_X^P)_x.$$

Now let $x_i, 1 \leq i \leq |Orb(X)|$ be representations of different orbits in $Orb(X)$. For an element y in $x_i^{\mathcal{G}_X^P}$, let $y = x_i^g$ for an element $g \in \mathcal{G}_X^P$. Now if $h \in (\mathcal{G}_X^P)_y$, i.e., $y^h = y$, then we find that $(x_i^g)^h = x_i^g$. Whence, $x_i^{ghg^{-1}} = x_i$. We obtain that $ghg^{-1} \in (\mathcal{G}_X^P)_{x_i}$, namely, $h \in g^{-1}(\mathcal{G}_X^P)_{x_i}g$. Therefore, $(\mathcal{G}_X^P)_y \subset g^{-1}(\mathcal{G}_X^P)_{x_i}g$. Similarly, we get that $(\mathcal{G}_X^P)_{x_i} \subset g(\mathcal{G}_X^P)_y g^{-1}$, i.e., $(\mathcal{G}_X^P)_y = g^{-1}(\mathcal{G}_X^P)_{x_i}g$. We know

that $|(\mathcal{G}_X^P)_y| = |(\mathcal{G}_X^P)_{x_i}|$ for any element in $x_i^{\mathcal{G}_X^P}$, $1 \leq i \leq |Orb(X)|$. This enables us to obtain that

$$\begin{aligned} \sum_{p \in \mathcal{G}_X^P} |\Phi(p)| &= \sum_{x \in X} (\mathcal{G}_X^P)_x = \sum_{i=1}^{|Orb(X)|} \sum_{y \in x_i^{\mathcal{G}_X^P}} |(\mathcal{G}_X^P)_{x_i}| \\ &= \sum_{i=1}^{|Orb(X)|} |x_i^{\mathcal{G}_X^P}| |(\mathcal{G}_X^P)_{x_i}| = \sum_{i=1}^{|Orb(X)|} |\mathcal{G}_X^P| \\ &= |Orb(X)| |\mathcal{G}_X^P| \end{aligned}$$

by applying Theorem 2.5.5. This completes the proof. \square

For a permutation group Γ action on Ω , i.e., all $p_i = \mathbf{1}_X$ for $1 \leq i \leq m$, we get the famous *Burnside's Lemma* by Theorem 2.5.6.

Corollary 2.5.4(Burnside's Lemma) *Let Γ be a permutation group action on Ω . Then*

$$|Orb(\Omega)| = \frac{1}{|\Gamma|} \sum_{g \in \Gamma} |\Phi(g)|.$$

A permutation multi-group \mathcal{G}_X^P is *transitive* on X if $|Orb(X)| = 1$, i.e., for any elements $x, y \in X$, there is an element $g \in \mathcal{G}_X^P$ such that $x^g = y$. In this case, we know formulae following by Theorems 2.5.5 and 2.5.6.

$$|\mathcal{G}_X^P| = |X| |(\mathcal{G}_X^P)_x| \quad \text{and} \quad |\mathcal{G}_X^P| = \sum_{p \in \mathcal{G}_X^P} |\Phi(p)|$$

Similarly, a permutation multi-group \mathcal{G}_X^P is *k-transitive* on X if for any two k -tuples (x_1, x_2, \dots, x_k) and (y_1, y_2, \dots, y_k) , there is an element $g \in \mathcal{G}_X^P$ such that $x_i^g = y_i$ for any integer $i, 1 \leq i \leq k$. It is well-known that $Sym(X)$ is $|X|$ -transitive on a finite set X .

Theorem 2.5.7 *Let Γ be a transitive group action on X and \mathcal{G}_X^P a permutation multi-group $(\Gamma; \mathcal{O}_P)$ with $P = \{p_1, p_2, \dots, p_m\}$ and $p_i \in \Gamma$ for integers $1 \leq i \leq m$. Then for an integer k ,*

- (i) $(\Gamma; X)$ is *k-transitive* if and only if $(\Gamma_x; X \setminus \{x\})$ is *(k - 1)-transitive*;

(ii) \mathcal{G}_X^P is k -transitive on X if and only if $(\mathcal{G}_X^P)_x$ is $(k-1)$ -transitive on $X \setminus \{x\}$.

Proof If Γ is k -transitive on X , it is obvious that Γ is $(k-1)$ -transitive on X itself. Conversely, if Γ_x is $(k-1)$ -transitive on $X \setminus \{x\}$, then for two k -tuples (x_1, x_2, \dots, x_k) and (y_1, y_2, \dots, y_k) , there are elements $g_1, g_2 \in \Gamma$ and $h \in \Gamma_x$ such that

$$x_1^{g_1} = x, \quad y_1^{g_2} = x \quad \text{and} \quad (x_i^{g_1})^h = y_i^{g_2}$$

for any integer $i, 2 \leq i \leq k$. Therefore,

$$x_i^{g_1 h g_2^{-1}} = y_i, \quad 1 \leq i \leq k.$$

We know that Γ is ' k -transitive on X . This is the assertion of (i).

By definition, \mathcal{G}_X^P is k -transitive on X if and only if Γ is k -transitive, i.e., $(\mathcal{G}_X^P)_x$ is $(k-1)$ -transitive on $X \setminus \{x\}$ by (i), which is the assertion of (ii). \square

Applying Theorems 2.5.5 and 2.5.7 repeatedly, we get an interesting consequence for k -transitive multi-groups.

Theorem 2.5.8 *Let \mathcal{G}_X^P be a k -transitive multi-group and $\Delta \subset X$ with $|\Delta| = k$. Then*

$$|\mathcal{G}_X^P| = |X|(|X| - 1) \cdots (|X| - k + 1) |(\mathcal{G}_X^P)_\Delta|. \quad \square$$

Particularly, a k -transitive multi-group \mathcal{G}_X^P with $|\mathcal{G}_X^P| = |X|(|X| - 1) \cdots (|X| - k + 1)$ is called a *sharply k -transitive multi-group*. For example, choose $\Gamma = \text{Sym}(X)$ with $|X| = n$, i.e., the symmetric group S_n and permutations $p_i \in S_n, 1 \leq i \leq m$, we get an n -transitive multi-group $(S_n; \mathcal{O}_P)$ with $P = \{p_1, p_2, \dots, p_m\}$.

Let Γ be a transitive group action on X and \mathcal{G}_X^P a permutation multi-group $(\Gamma; \mathcal{O}_P)$ with $P = \{p_1, p_2, \dots, p_m\}, p_i \in \Gamma$ for integers $1 \leq i \leq m$. An equivalent relation R on X is \mathcal{G}_X^P -admissible if for $\forall (x, y) \in R$, there is $(x^g, y^g) \in R$ for $\forall g \in \mathcal{G}_X^P$. For a given set X and permutation multi-group \mathcal{G}_X^P , it can be shown easily by definition that

$$R = X \times X \quad \text{or} \quad R = \{(x, x) | x \in X\}$$

are \mathcal{G}_X^P -admissible, called *trivially \mathcal{G}_X^P -admissible relations*. A transitive multi-group

\mathcal{G}_X^P is *primitive* if there are no \mathcal{G}_X^P -admissible relations R on X unless $R = X \times X$ or $R = \{(x, x)|x \in X\}$, i.e., the trivially relations. The next result shows the existence of primitive multi-groups.

Theorem 2.5.9 *Every k -transitive multi-group \mathcal{G}_X^P is primitive if $k \geq 2$.*

Proof Otherwise, there is a \mathcal{G}_X^P -admissible relations R on X such that $R \neq X \times X$ and $R \neq \{(x, x)|x \in X\}$. Whence, there must exists $(x, y) \in R$, $x, y \in X$ and $x \neq y$. By assumption, \mathcal{G}_X^P is k -transitive on X , $k \geq 2$. For $\forall z \in X$, there is an element $g \in \mathcal{G}_X^P$ such that $x^g = x$ and $y^g = z$. This fact implies that $(x, z) \in R$ for $\forall z \in X$ by definition. Notice that R is an equivalence relation on X . For $\forall z_1, z_2 \in X$, we get $(z_1, x), (x, z_2) \in R$. Thereafter, $(z_1, z_2) \in R$, namely, $R = X \times X$, a contradiction. \square

There is a simple criterion for determining which permutation multi-group is primitive by maximal stabilizers following.

Theorem 2.5.10 *A transitive multi-group \mathcal{G}_X^P is primitive if and only if there is an element $x \in X$ such that $p \in (\mathcal{G}_X^P)_x$ for $\forall p \in P$ and if there is a permutation multi-group $(\mathcal{H}; \mathcal{O}_P)$ enabling $((\mathcal{G}_X^P)_x; \mathcal{O}_P) \prec (\mathcal{H}; \mathcal{O}_P) \prec \mathcal{G}_X^P$, then $(\mathcal{H}; \mathcal{O}_P) = ((\mathcal{G}_X^P)_x; \mathcal{O}_P)$ or \mathcal{G}_X^P .*

Proof If $(\mathcal{H}; \mathcal{O}_P)$ be a multi-group with $((\mathcal{G}_X^P)_x; \mathcal{O}_P) \prec (\mathcal{H}; \mathcal{O}_P) \prec \mathcal{G}_X^P$ for an element $x \in X$, define a relation

$$R = \{ (x^g, x^{g^{oh}}) \mid g \in \mathcal{G}_X^P, h \in \mathcal{H} \}.$$

for a chosen operation $\circ \in \mathcal{O}_P$. Then R is a \mathcal{G}_X^P -admissible equivalent relation. In fact, it is \mathcal{G}_X^P -admissible, reflexive and symmetric by definition. For its transitive-ness, let $(s, t) \in R$, $(t, u) \in R$. Then there are elements $g_1, g_2 \in \mathcal{G}_X^P$ and $h_1, h_2 \in \mathcal{H}$ such that

$$s = x^{g_1}, t = x^{g_1 \circ h_1}, t = x^{g_2}, u = x^{g_2 \circ h_2}.$$

Hence, $x^{g_2^{-1} \circ g_1 \circ h_1} = x$, i.e., $g_2^{-1} \circ g_1 \circ h_1 \in \mathcal{H}$. Whence, $g_2^{-1} \circ g_1, g_1^{-1} \circ g_2 \in \mathcal{H}$. Let $g^* = g_1, h^* = g_1^{-1} \circ g_2 \circ h_2$. We find that $s = x^{g^*}, u = x^{g^* \circ h^*}$. Therefore, $(s, u) \in R$. This concludes that R is an equivalent relation.

Now if \mathcal{G}_X^P is primitive, then $R = \{(x, x)|x \in X\}$ or $R = X \times X$ by definition. Assume $R = \{(x, x)|x \in X\}$. Then $s = x^g$ and $t = x^{g^{oh}}$ implies that $s = t$ for

$\forall g \in \mathcal{G}_X^P$ and $h \in \mathcal{H}$. Particularly, for $g = 1_\circ$, we find that $x^h = x$ for $\forall h \in \mathcal{H}$, i.e., $(\mathcal{H}; \mathcal{O}_P) = ((\mathcal{G}_X^P)_x; \mathcal{O}_P)$.

If $R = X \times X$, then $(x, x^f) \in R$ for $\forall f \in \mathcal{G}_X^P$. In this case, there must exist $g \in \mathcal{G}_X^P$ and $h \in \mathcal{H}$ such that $x = x^g, x^f = x^{goh}$. Whence, $g \in ((\mathcal{G}_X^P)_x; \mathcal{O}_P) \prec (\mathcal{H}; \mathcal{O}_P)$ and $g^{-1} \circ h^{-1} \circ f \in ((\mathcal{G}_X^P)_x; \mathcal{O}_P) \prec (\mathcal{H}; \mathcal{O}_P)$. Therefore, $f \in \mathcal{H}$ and $(\mathcal{H}; \mathcal{O}_P) = ((\mathcal{G}_X^P)_x; \mathcal{O}_P)$.

Conversely, assume R to be a \mathcal{G}_X^P -admissible equivalent relation and there is an element $x \in X$ such that $p \in (\mathcal{G}_X^P)_x$ for $\forall p \in P$, $((\mathcal{G}_X^P)_x; \mathcal{O}_P) \prec (\mathcal{H}; \mathcal{O}_P) \prec \mathcal{G}_X^P$ implies that $(\mathcal{H}; \mathcal{O}_P) = ((\mathcal{G}_X^P)_x; \mathcal{O}_P)$ or $((\mathcal{G}_X^P)_x; \mathcal{O}_P)$. Define

$$\mathcal{H} = \{ h \in \mathcal{G}_X^P \mid (x, x^h) \in R \}.$$

Then $(\mathcal{H}; \mathcal{O}_P)$ is multi-subgroup of \mathcal{G}_X^P which contains a multi-subgroup $((\mathcal{G}_X^P)_x; \mathcal{O}_P)$ by definition. Whence, $(\mathcal{H}; \mathcal{O}_P) = ((\mathcal{G}_X^P)_x; \mathcal{O}_P)$ or \mathcal{G}_X^P .

If $(\mathcal{H}; \mathcal{O}_P) = ((\mathcal{G}_X^P)_x; \mathcal{O}_P)$, then x is only equivalent to itself. Since \mathcal{G}_X^P is transitive on X , we know that $R = \{(x, x) \mid x \in X\}$.

If $(\mathcal{H}; \mathcal{O}_P) = \mathcal{G}_X^P$, by the transitiveness of \mathcal{G}_X^P on X again, we find that $R = X \times X$. Combining these discussions, we conclude that \mathcal{G}_X^P is primitive. \square

Choose $p = 1_X$ for each $p \in P$ in Theorem 2.5.10, we get a well-known result in classical permutation groups following.

Corollary 2.5.5 *A transitive group Γ is primitive if and only if there is an element $x \in X$ such that a subgroup H with $\Gamma_x \prec H \prec \Gamma$ hold implies that $H = \Gamma_x$ or Γ .*

Now let Γ be a permutation group action on a set X and $P \subset \Pi(X)$. We have shown in Theorem 2.5.2 that $(\Gamma; \mathcal{O}_P)$ is a multi-group if $P \subset \Gamma$. Then *what can we say if not all $p \in P$ are in Γ ?* For this case, we introduce a new multi-group $(\tilde{\Gamma}; \mathcal{O}_P)$ on X , the *permutation multi-group generated by P in Γ* by

$$\tilde{\Gamma} = \{ g_1 \circ_{p_1} g_2 \circ_{p_2} \cdots \circ_{p_l} g_{l+1} \mid g_i \in \Gamma, p_j \in P, 1 \leq i \leq l+1, 1 \leq j \leq l \},$$

denoted by $\langle \Gamma_X^P \rangle$. This multi-group has good behavior like \mathcal{G}_X^P , also a kind way of extending a group to a multi-group. For convenience, a group generated by a set S with the operation in Γ is denoted by $\langle S \rangle_\Gamma$.

Theorem 2.5.11 *Let Γ be a permutation group action on a set X and $P \subset \Pi(X)$. Then*

- (i) $\langle \Gamma_X^P \rangle = \langle \Gamma \cup P \rangle_\Gamma$, particularly, $\langle \Gamma_X^P \rangle = \mathcal{G}_X^P$ if and only if $P \subset \Gamma$;
- (ii) for any subgroup Λ of Γ , there exists a subset $P \subset \Gamma$ such that

$$\langle \Lambda_X^P; \mathcal{O}_P \rangle = \langle \Gamma_X^P \rangle.$$

Proof By definition, for $\forall a, b \in \Gamma$ and $p \in P$, we know that

$$a \circ_p b = apb.$$

Choosing $a = b = 1_\Gamma$, we find that

$$a \circ_p b = p,$$

i.e., $\Gamma \subset \tilde{\Gamma}$. Whence,

$$\langle \Gamma \cup P \rangle_\Gamma \subset \langle \Gamma_X^P \rangle.$$

Now for $\forall g_i \in \Gamma$ and $p_j \in P$, $1 \leq i \leq l+1$, $1 \leq j \leq l$, we know that

$$g_1 \circ_{p_1} g_2 \circ_{p_2} \cdots \circ_{p_l} g_{l+1} = g_1 p_1 g_2 p_2 \cdots p_l g_{l+1},$$

which means that

$$\langle \Gamma_X^P \rangle \subset \langle \Gamma \cup P \rangle_\Gamma.$$

Therefore,

$$\langle \Gamma_X^P \rangle = \langle \Gamma \cup P \rangle_\Gamma.$$

Now if $\langle \Gamma_X^P \rangle = \mathcal{G}_X^P$, i.e., $\langle \Gamma \cup P \rangle_\Gamma = \Gamma$, there must be $P \subset \Gamma$. According to Theorem 2.5.2, this concludes the assertion (i).

For the assertion (ii), notice that if $P = \Gamma \setminus \Lambda$, we get that

$$\langle \Lambda_X^P \rangle = \langle \Lambda \cup P \rangle_\Gamma = \Gamma$$

by (i). Whence, there always exists a subset $P \subset \Gamma$ such that

$$\langle \Lambda_X^P; \mathcal{O}_P \rangle = \langle \Gamma_X^P \rangle.$$

□

Theorem 2.5.12 *Let Γ be a permutation group action on a set X . For an integer $k \geq 1$, there is a set $P \in \Pi(X)$ with $|P| \leq k$ such that $\langle \Gamma_X^P \rangle$ is k -transitive.*

Proof Notice that the symmetric group $Sym(X)$ is $|X|$ -transitive for any finite

set X . If Γ is k -transitive on X , choose $P = \emptyset$ enabling the conclusion true. Otherwise, assume these orbits of Γ action on X to be O_1, O_2, \dots, O_s , where $s = |\text{Orb}(X)|$. Construct a permutation $p \in \Pi(X)$ by

$$p = (x_1, x_2, \dots, x_s),$$

where $x_i \in O_i$, $1 \leq i \leq s$ and let $P = \{p\} \subset \text{Sym}(X)$. Applying Theorem 2.5.11, we know that $\langle \Gamma_X^P \rangle = \langle \Gamma \cup P \rangle_\Gamma$ is transitive on X with $|P| = 1$.

Now for an integer k , if $\langle \Gamma_X^{P_1} \rangle$ is k -transitive with $|P_1| \leq k$, let O'_1, O'_2, \dots, O'_l be these orbits of the stabilizer $\langle \Gamma_X^{P_1} \rangle_{y_1 y_2 \dots y_k}$ action on $X \setminus \{y_1, y_2, \dots, y_k\}$. Construct a permutation

$$q = (z_1, z_2, \dots, z_l),$$

where $z_i \in O'_i$, $1 \leq i \leq l$ and let $P_2 = P_1 \cup \{q\}$. Applying Theorem 2.5.11 again, we find that $\langle \Gamma_X^{P_2} \rangle_{y_1 y_2 \dots y_k}$ is transitive on $X \setminus \{y_1, y_2, \dots, y_k\}$, where $|P_2| \leq |P_1| + 1$. Therefore, $\langle \Gamma_X^{P_2} \rangle$ is $(k+1)$ -transitive on X with $|P_2| \leq k+1$ by Theorem 2.5.7.

Applying the induction principle, we get the conclusion. \square

Notice that any k -transitive multi-group is primitive if $k \geq 2$ by Theorem 2.5.9. We have a corollary following by Theorem 2.5.12.

Corollary 2.5.6 *Let Γ be a permutation group action on a set X . There is a set $P \in \Pi(X)$ such that $\langle \Gamma_X^P \rangle$ is primitive.*

§2.6 COMBINATORIAL ALGEBRAIC SYSTEMS

2.6.1 Algebraic Multi-System. An algebraic multi-system is a pair $(\widetilde{\mathcal{A}}; \widetilde{\mathcal{O}})$ with

$$\widetilde{\mathcal{A}} = \bigcup_{i=1}^m \mathcal{H}_i \quad \text{and} \quad \widetilde{\mathcal{O}} = \bigcup_{i=1}^m \mathcal{O}_i$$

such that for any integer i , $1 \leq i \leq m$, $(\mathcal{H}_i; \mathcal{O}_i)$ is a multi-operation system. For an algebraic multi-operation system $(\widetilde{\mathcal{A}}; \widetilde{\mathcal{O}})$ and an integer i , $1 \leq i \leq m$, a homomorphism $p_i : (\widetilde{\mathcal{A}}; \widetilde{\mathcal{O}}) \rightarrow (\mathcal{H}_i; \mathcal{O}_i)$ is called a *sectional projection*, which is useful in multi-systems.

Two multi-systems $(\widetilde{\mathcal{A}}_1; \widetilde{\mathcal{O}}_1)$, $(\widetilde{\mathcal{A}}_2; \widetilde{\mathcal{O}}_2)$, where $\widetilde{\mathcal{A}}_1 = \bigcup_{i=1}^m \mathcal{H}_i^k$ and $\widetilde{\mathcal{O}}_1 = \bigcup_{i=1}^m \mathcal{O}_i^k$

for $k = 1, 2$ are *homomorphic* if there is a mapping $o : \widetilde{\mathcal{A}}_1 \rightarrow \widetilde{\mathcal{A}}_2$ such that op_i is a homomorphism for any integer $i, 1 \leq i \leq m$. By this definition, we know the existent conditions for homomorphisms on algebraic multi-systems following.

Theorem 2.6.1 *There exists a homomorphism from an algebraic multi-system $(\widetilde{\mathcal{A}}_1; \widetilde{\mathcal{O}}_1)$ to $(\widetilde{\mathcal{A}}_2; \widetilde{\mathcal{O}}_2)$, where $\widetilde{\mathcal{A}}_k = \bigcup_{i=1}^m \mathcal{H}_i^k$ and $\widetilde{\mathcal{O}}_k = \bigcup_{i=1}^m \mathcal{O}_i^k$ for $k = 1, 2$ if and only if there are homomorphisms $\eta_1, \eta_2, \dots, \eta_m$ on $(\mathcal{H}_1^1; \mathcal{O}_1^1), (\mathcal{H}_2^1; \mathcal{O}_2^1), \dots, (\mathcal{H}_m^1; \mathcal{O}_m^1)$ such that*

$$\eta_i|_{\mathcal{H}_i^1 \cap \mathcal{H}_j^1} = \eta_j|_{\mathcal{H}_i^1 \cap \mathcal{H}_j^1}$$

for any integer $1 \leq i, j \leq m$.

Proof By definition, if there is a homomorphism $o : (\widetilde{\mathcal{A}}_1; \widetilde{\mathcal{O}}_1) \rightarrow (\widetilde{\mathcal{A}}_2; \widetilde{\mathcal{O}}_2)$, then op_i is a homomorphism on $(\mathcal{H}_i^1; \mathcal{O}_i^1)$ for any integer $i, 1 \leq i \leq m$.

On the other hand, if there are homomorphisms $\eta_1, \eta_2, \dots, \eta_m$ on $(\mathcal{H}_1^1; \mathcal{O}_1^1), (\mathcal{H}_2^1; \mathcal{O}_2^1), \dots, (\mathcal{H}_m^1; \mathcal{O}_m^1)$, define a mapping $o : (\widetilde{\mathcal{A}}_1; \widetilde{\mathcal{O}}_1) \rightarrow (\widetilde{\mathcal{A}}_2; \widetilde{\mathcal{O}}_2)$ by $o(a) = \eta_i(a)$ if $a \in \mathcal{H}_i^1$. Then it can be checked immediately that o is a homomorphism. \square

Let $o : (\widetilde{\mathcal{A}}_1; \widetilde{\mathcal{O}}_1) \rightarrow (\widetilde{\mathcal{A}}_2; \widetilde{\mathcal{O}}_2)$ be a homomorphism with a unit 1_o for each operation $\circ \in \widetilde{\mathcal{O}}_2$. Similar to the case of multi-operation systems, we define the *multi-kernel* $\widetilde{\text{Ker}}(o)$ by

$$\widetilde{\text{Ker}}(o) = \{ a \in \widetilde{\mathcal{A}}_1 \mid o(a) = 1_o \text{ for } \forall \circ \in \widetilde{\mathcal{O}}_2 \}.$$

Then we have the homomorphism theorem on algebraic multi-systems following.

Theorem 2.6.2 *Let $(\widetilde{\mathcal{A}}_1; \widetilde{\mathcal{O}}_1), (\widetilde{\mathcal{A}}_2; \widetilde{\mathcal{O}}_2)$ be algebraic multi-systems, where $\widetilde{\mathcal{A}}_k = \bigcup_{i=1}^m \mathcal{H}_i^k$, $\widetilde{\mathcal{O}}_k = \bigcup_{i=1}^m \mathcal{O}_i^k$ for $k = 1, 2$ and $o : (\widetilde{\mathcal{A}}_1; \widetilde{\mathcal{O}}_1) \rightarrow (\widetilde{\mathcal{A}}_2; \widetilde{\mathcal{O}}_2)$ a onto homomorphism with a multi-group $(\mathcal{I}_i^2; \mathcal{O}_i^2)$ for any integer $i, 1 \leq i \leq m$. Then there are representation pairs $(\widetilde{R}_1, \widetilde{P}_1)$ and $(\widetilde{R}_2, \widetilde{P}_2)$ such that*

$$\frac{(\widetilde{\mathcal{A}}_1; \widetilde{\mathcal{O}}_1)}{(\widetilde{\text{Ker}}(o); \mathcal{O}_1)}|_{(\widetilde{R}_1, \widetilde{P}_1)} \cong \frac{(\widetilde{\mathcal{A}}_2; \widetilde{\mathcal{O}}_2)}{(\widetilde{\mathcal{I}}(\mathcal{O}_2); \mathcal{O}_2)}|_{(\widetilde{R}_2, \widetilde{P}_2)}$$

where $(\widetilde{\mathcal{I}}(\mathcal{O}_2); \mathcal{O}_2) = \bigcup_{i=1}^m (\mathcal{I}_i^2; \mathcal{O}_i^2)$.

Proof By definition, we know that $o|_{\mathcal{H}_i^1} : (\mathcal{H}_i^1; \mathcal{O}_i^1) \rightarrow (\mathcal{H}_{o(i)}^2; \mathcal{O}_{o(i)}^2)$ is also an onto homomorphism for any integer $i, 1 \leq i \leq m$. Applying Theorem 2.3.2 and Corollary 2.3.1, we can find representation pairs (R_i^1, \tilde{P}_i^1) and (R_i^2, \tilde{P}_i^2) such that

$$\frac{(\mathcal{H}_i^1; \mathcal{O}_i^1)}{(\text{Ker}(o|_{\mathcal{H}_i^1}); \mathcal{O}_i^1)}_{(R_i^1, \tilde{P}_i^1)} \cong \frac{(\mathcal{H}_{o(i)}^2; \mathcal{O}_{o(i)}^2)}{(\mathcal{I}_{o(i)}^2; \mathcal{O}_{o(i)}^2)}_{(R_{o(i)}^1, \tilde{P}_{o(i)}^1)}.$$

Notice that

$$\tilde{\mathcal{A}}_k = \bigcup_{i=1}^m \mathcal{H}_i^k, \quad \tilde{\mathcal{O}}_k = \bigcup_{i=1}^m \mathcal{O}_i^k$$

for $k = 1, 2$ and

$$\widetilde{\text{Ker}}(o) = \bigcup_{i=1}^m \text{Ker}(o|_{\mathcal{H}_i^1}).$$

We finally get that

$$\frac{(\tilde{\mathcal{A}}_1; \tilde{\mathcal{O}}_1)}{(\widetilde{\text{Ker}}(o); \mathcal{O}_1)}_{(\tilde{R}_1, \tilde{P}_1)} \cong \frac{(\tilde{\mathcal{A}}_2; \tilde{\mathcal{O}}_2)}{(\tilde{\mathcal{I}}(\mathcal{O}_2); \mathcal{O}_2)}_{(\tilde{R}_2, \tilde{P}_2)}$$

with

$$\tilde{R}_k = \bigcup_{i=1}^m R_i^k \quad \text{and} \quad \tilde{P}_k = \bigcup_{i=1}^m \tilde{P}_i^k$$

for $k = 1$ or 2 . □

2.6.2 Diagram of Multi-System. Let $(A; \circ)$ be an algebraic system with operation “ \circ ”. We associate a *labeled graph* $G^L[A]$ with $(A; \circ)$ by

$$V(G^L[A]) = A,$$

$$E(G^L[A]) = \{(a, c) \text{ with label } \circ b \mid a \circ b = c \text{ for } \forall a, b, c \in A\},$$

as shown in Fig.2.6.1.

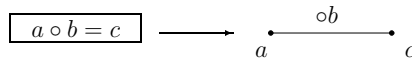

Fig.2.6.1

The advantage of this diagram on systems is that we can find $aob = c$ for any edge in $G^L[A]$, if its vertices are a, c with a label ob and vice versa immediately. For example, the labeled graph $G^L[Z_4]$ of an Abelian group Z_4 is shown in Fig.2.6.2.

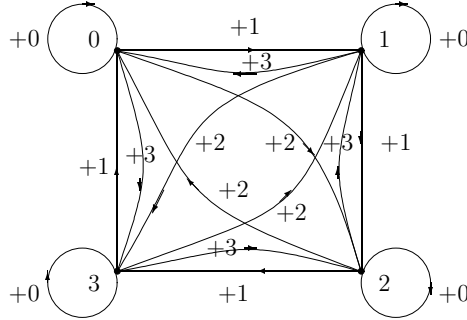

Fig.2.6.2

Some structure properties on these diagrams $G^L[A]$ of systems are shown in the following.

Property 1. *The labeled graph $G^L[A]$ is connected if and only if there are no partition $A = A_1 \cup A_2$ such that for $\forall a_1 \in A_1, \forall a_2 \in A_2$, there are no definition for $a_1 \circ a_2$ in $(A; \circ)$.*

If $G^L[A]$ is disconnected, we choose one component C and let $A_1 = V(C)$. Define $A_2 = V(G^L[A]) \setminus V(C)$. Then we get a partition $A = A_1 \cup A_2$ and for $\forall a_1 \in A_1, \forall a_2 \in A_2$, there are no definition for $a_1 \circ a_2$ in $(A; \circ)$, a contradiction.

Property 2. *If there is a unit 1_A in $(A; \circ)$, then there exists a vertex 1_A in $G^L[A]$ such that the label on the edge $(1_A, x)$ is $\circ x$.*

For a multiple 2-edge (a, b) in a directed graph, if two orientations on edges are both to a or both to b , then we say it a *parallel multiple 2-edge*. If one orientation is to a and another is to b , then we say it an *opposite multiple 2-edge*.

Property 3. *For $\forall a \in A$, if $a \circ^{-1}$ exists, then there is an opposite multiple 2-edge $(1_A, a)$ in $G^L[A]$ with labels $\circ a$ and $\circ a \circ^{-1}$, respectively.*

Property 4. *For $\forall a, b \in A$ if $a \circ b = b \circ a$, then there are edges (a, x) and (b, x) , $x \in A$ in $(A; \circ)$ with labels $w(a, x) = \circ b$ and $w(b, x) = \circ a$ in $G^L[A]$, respectively.*

Property 5. *If the cancelation law holds in $(A; \circ)$, i.e., for $\forall a, b, c \in A$, if $a \circ b = a \circ c$ then $b = c$, then there are no parallel multiple 2-edges in $G^L[A]$.*

These properties 2 – 5 are gotten by definition. Each of these cases is shown in (1), (2), (3) and (4) in Fig.2.6.3.

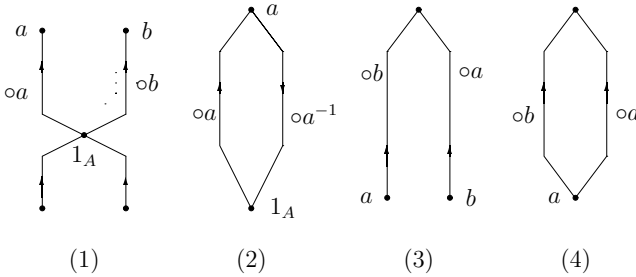

Fig.2.6.3

Now we consider the diagrams of algebraic multi-systems. Let $(\widetilde{\mathcal{A}}; \widetilde{\mathcal{O}})$ be an algebraic multi-system with

$$\widetilde{\mathcal{A}} = \bigcup_{i=1}^m \mathcal{H}_i \quad \text{and} \quad \widetilde{\mathcal{O}} = \bigcup_{i=1}^m \mathcal{O}_i$$

such that $(\mathcal{H}_i; \mathcal{O}_i)$ is a multi-operation system for any integer $i, 1 \leq i \leq m$, where the operation set $\mathcal{O}_i = \{\circ_{ij} | 1 \leq j \leq n_i\}$. Define a labeled graph $G^L[\widetilde{\mathcal{A}}]$ associated with $(\widetilde{\mathcal{A}}; \widetilde{\mathcal{O}})$ by

$$G^L[\widetilde{\mathcal{A}}] = \bigcup_{i=1}^m \bigcup_{j=1}^{n_i} G^L[(\mathcal{H}_i; \circ_{ij})],$$

where $G^L[(\mathcal{H}_i; \circ_{ij})]$ is the associated labeled graph of $(\mathcal{H}_i; \circ_{ij})$ for $1 \leq i \leq m, 1 \leq j \leq n_{ij}$. The importance of $G^L[\widetilde{\mathcal{A}}]$ is displayed in the next result.

Theorem 2.6.3 *Let $(\widetilde{\mathcal{A}}_1; \widetilde{\mathcal{O}}_1), (\widetilde{\mathcal{A}}_2; \widetilde{\mathcal{O}}_2)$ be two algebraic multi-systems. Then*

$$(\widetilde{\mathcal{A}}_1; \widetilde{\mathcal{O}}_1) \cong (\widetilde{\mathcal{A}}_2; \widetilde{\mathcal{O}}_2)$$

if and only if

$$G^L[\widetilde{\mathcal{A}}_1] \cong G^L[\widetilde{\mathcal{A}}_2].$$

Proof If $(\widetilde{\mathcal{A}}_1; \widetilde{\mathcal{O}}_1) \cong (\widetilde{\mathcal{A}}_2; \widetilde{\mathcal{O}}_2)$, by definition, there is a 1 – 1 mapping $\omega : \widetilde{\mathcal{A}}_1 \rightarrow$

$\widetilde{\mathcal{A}}_2$ with $\omega : \widetilde{\mathcal{O}}_1 \rightarrow \widetilde{\mathcal{O}}_2$ such that for $\forall a, b \in \widetilde{\mathcal{A}}_1$ and $\circ_1 \in \widetilde{\mathcal{O}}_1$, there exists an operation $\circ_2 \in \widetilde{\mathcal{O}}_2$ with the equality following hold,

$$\omega(a \circ_1 b) = \omega(a) \circ_2 \omega(b).$$

Not loss of generality, assume $a \circ_1 b = c$ in $(\widetilde{\mathcal{A}}_1; \widetilde{\mathcal{O}}_1)$. Then for an edge (a, c) with a label $\circ_1 b$ in $G^L[\widetilde{\mathcal{A}}_1]$, there is an edge $(\omega(a), \omega(c))$ with a label $\circ_2 \omega(b)$ in $G^L[\widetilde{\mathcal{A}}_2]$, i.e., ω is an equivalence from $G^L[\widetilde{\mathcal{A}}_1]$ to $G^L[\widetilde{\mathcal{A}}_2]$. Therefore, $G^L[\widetilde{\mathcal{A}}_1] \cong G^L[\widetilde{\mathcal{A}}_2]$.

Conversely, if $G^L[\widetilde{\mathcal{A}}_1] \cong G^L[\widetilde{\mathcal{A}}_2]$, let ϖ be a such equivalence from $G^L[\widetilde{\mathcal{A}}_1]$ to $G^L[\widetilde{\mathcal{A}}_2]$, then for an edge (a, c) with a label $\circ_1 b$ in $G^L[\widetilde{\mathcal{A}}_1]$, by definition we know that $(\omega(a), \omega(c))$ with a label $\omega(\circ_1)\omega(b)$ is an edge in $G^L[\widetilde{\mathcal{A}}_2]$. Whence,

$$\omega(a \circ_1 b) = \omega(a)\omega(\circ_1)\omega(b),$$

i.e., $\omega : \widetilde{\mathcal{A}}_1 \rightarrow \widetilde{\mathcal{A}}_2$ is an isomorphism from $(\widetilde{\mathcal{A}}_1; \widetilde{\mathcal{O}}_1)$ to $(\widetilde{\mathcal{A}}_2; \widetilde{\mathcal{O}}_2)$. □

Generally, let $(\widetilde{\mathcal{A}}_1; \widetilde{\mathcal{O}}_1), (\widetilde{\mathcal{A}}_2; \widetilde{\mathcal{O}}_2)$ be two algebraic multi-systems associated with labeled graphs $G^L[\widetilde{\mathcal{A}}_1], G^L[\widetilde{\mathcal{A}}_2]$. A *homomorphism* $\iota : G^L[\widetilde{\mathcal{A}}_1] \rightarrow G^L[\widetilde{\mathcal{A}}_2]$ is a mapping $\iota : V(G^L[\widetilde{\mathcal{A}}_1]) \rightarrow V(G^L[\widetilde{\mathcal{A}}_2])$ and $\iota : \widetilde{\mathcal{O}}_1 \rightarrow \widetilde{\mathcal{O}}_2$ such that $\iota(a, c) = (\iota(a), \iota(c))$ with a label $\iota(\circ)\iota(b)$ for $\forall (a, c) \in E(G^L[\widetilde{\mathcal{A}}_1])$ with a label ob . We get a result on homomorphisms of labeled graphs following.

Theorem 2.6.4 *Let $(\widetilde{\mathcal{A}}_1; \widetilde{\mathcal{O}}_1), (\widetilde{\mathcal{A}}_2; \widetilde{\mathcal{O}}_2)$ be algebraic multi-systems, where $\widetilde{\mathcal{A}}_k = \bigcup_{i=1}^m \mathcal{H}_i^k, \widetilde{\mathcal{O}}_k = \bigcup_{i=1}^m \mathcal{O}_i^k$ for $k = 1, 2$ and $\iota : (\widetilde{\mathcal{A}}_1; \widetilde{\mathcal{O}}_1) \rightarrow (\widetilde{\mathcal{A}}_2; \widetilde{\mathcal{O}}_2)$ a homomorphism. Then there is a homomorphism $\iota : G^L[\mathcal{A}_1] \rightarrow G^L[\mathcal{A}_2]$ from $G^L[\mathcal{A}_1]$ to $G^L[\mathcal{A}_2]$ induced by ι .*

Proof By definition, we know that $o : V(G^L[\mathcal{A}_1]) \rightarrow V(G^L[\mathcal{A}_2])$. Now if $(a, c) \in E(G^L[\mathcal{A}_1])$ with a label ob , then there must be $a \circ b = c$ in $(\widetilde{\mathcal{A}}_1; \widetilde{\mathcal{O}}_1)$. Hence, $\iota(a)\iota(\circ)\iota(b) = \iota(c)$ in $(\widetilde{\mathcal{A}}_2; \widetilde{\mathcal{O}}_2)$, where $\iota(\circ) \in \widetilde{\mathcal{O}}_2$ by definition. Whence, $(\iota(a), \iota(c)) \in E(G^L[\mathcal{A}_1])$ with a label $\iota(\circ)\iota(b)$ in $G^L[\mathcal{A}_2]$, i.e., ι is a homomorphism between $G^L[\mathcal{A}_1]$ and $G^L[\mathcal{A}_2]$. Therefore, ι induced a homomorphism from $G^L[\mathcal{A}_1]$ to $G^L[\mathcal{A}_2]$. □

Notice that an algebraic multi-system $(\widetilde{\mathcal{A}}; \widetilde{\mathcal{O}})$ is a combinatorial system \mathcal{C}_Γ with an underlying graph Γ , called a Γ -*multi-system*, where

$$V(\Gamma) = \{\mathcal{H}_i | 1 \leq i \leq m\},$$

$$E(\Gamma) = \{(\mathcal{H}_i, \mathcal{H}_j) | \exists a \in \mathcal{H}_i, b \in \mathcal{H}_j \text{ with } (a, b) \in E(G^L[\widetilde{\mathcal{A}}]) \text{ for } 1 \leq i, j \leq m\}.$$

We obtain conditions for an algebraic multi-system with a graphical structure in the following.

Theorem 2.6.5 *Let $(\widetilde{\mathcal{A}}; \widetilde{\mathcal{O}})$ be an algebraic multi-system. Then it is*

(i) *a circuit multi-system if and only if there is arrangement $\mathcal{H}_i, 1 \leq i \leq m$ for $\mathcal{H}_1, \mathcal{H}_2, \dots, \mathcal{H}_m$ such that*

$$\mathcal{H}_{i-1} \cap \mathcal{H}_i \neq \emptyset, \mathcal{H}_i \cap \mathcal{H}_{i+1} \neq \emptyset$$

for any integer $i(\text{mod } m), 1 \leq i \leq m$ but

$$\mathcal{H}_i \cap \mathcal{H}_j = \emptyset$$

for integers $j \neq i-1, i, i+1(\text{mod } m)$;

(ii) *a star multi-system if and only if there is arrangement $\mathcal{H}_i, 1 \leq i \leq m$ for $\mathcal{H}_1, \mathcal{H}_2, \dots, \mathcal{H}_m$ such that*

$$\mathcal{H}_{i_1} \cap \mathcal{H}_{i_2} \neq \emptyset \text{ but } \mathcal{H}_{i_1} \cap \mathcal{H}_{i_3} = \emptyset$$

for integers $1 < i, j \leq m, i \neq j$.

(iii) *a tree multi-system if and only if any subset of $\widetilde{\mathcal{A}}$ is not a circuit multi-system under operations in $\widetilde{\mathcal{O}}$.*

Proof By definition, these conditions really ensure a circuit, star, or a tree multi-system, and conversely, a circuit, star, or a tree multi-system constrains these conditions, respectively. \square

Now if an associative system $(\mathcal{A}; \circ)$ has a unit and inverse element a_\circ^{-1} for any element $a \in \mathcal{A}$, i.e., a group, then for any elements $x, y \in \mathcal{A}$, there is an edge $(x, y) \in E(G^L[\mathcal{A}])$. In fact, by definition, there is an element $z \in \mathcal{A}$ such that $x_\circ^{-1} \circ y = z$. Whence, $x \circ z = y$. By definition, there is an edge (x, y) with a label oz in $G^L[\mathcal{A}]$, and an edge (y, x) with label z_\circ^{-1} . Thereafter, the diagram of a group is a complete graph attached with a loop at each vertex, denoted by $K[\mathcal{A}; \circ]$. As a by-product, the diagram $G^L[\widetilde{G}]$ of a m -group \widetilde{G} is a union of m complete graphs with the same vertices, each attached with m loops.

Summarizing previous discussion, we can sketch the diagram of a multi-group as follows.

Theorem 2.6.6 *Let $(\widetilde{\mathcal{A}}; \widetilde{\mathcal{O}})$ be a multi-group with $\widetilde{\mathcal{A}} = \bigcup_{i=1}^m \mathcal{H}_i$, $\widetilde{\mathcal{O}} = \bigcup_{i=1}^m \mathcal{O}_i$, $\mathcal{O}_i = \{\circ_{ij}, 1 \leq j \leq n_i\}$ and $(\mathcal{H}_i; \circ_{ij})$ a group for integers i, j , $1 \leq i \leq m, 1 \leq j \leq n_i$. Then its diagram $G^L[\mathcal{A}]$ is*

$$G^L[\mathcal{A}] = \bigcup_{i=1}^m \bigcup_{j=1}^{n_i} K[\mathcal{H}_i; \circ_{ij}].$$

□

Corollary 2.6.1 *The diagram of a field $(\mathcal{H}; +, \circ)$ is a union of two complete graphs attached with 2 loops at each vertex.*

Corollary 2.6.2 *Let $(\widetilde{\mathcal{A}}; \widetilde{\mathcal{O}})$ be a multi-group. Then $G^L[\mathcal{A}]$ is hamiltonian if and only if \mathcal{G}_Γ is hamiltonian.*

Proof Notice that \mathcal{G}_Γ is an resultant graph in $G^L[\mathcal{A}]$ shrinking each $\bigcup_{j=1}^{n_i} K[\mathcal{H}_i; \circ_{ij}]$ to a vertex \mathcal{H}_i for $1 \leq i \leq m$ by definition. Whence, \mathcal{G}_Γ is hamiltonian if $G^L[\mathcal{A}]$ is hamiltonian.

Conversely, if \mathcal{G}_Γ is hamiltonian, we can easily find a hamiltonian circuit in $G^L[\mathcal{A}]$ by applying Theorem 2.6.6. □

2.6.3 Cayley Diagram. Besides these diagrams of multi-systems described in Theorem 2.4.5, there is another diagram for a multi-system of finitely generated, called *Cayley diagrams of multi-systems* defined in the following.

A multi-system $(\widetilde{\mathcal{A}}; \widetilde{\mathcal{O}})$ is *finitely generated* if there are finite elements a_1, a_2, \dots, a_s in $\widetilde{\mathcal{A}}$ such that for $\forall x \in \widetilde{\mathcal{A}}$,

$$x = a_{x_1} \circ_1 a_{x_2} \circ_2 \cdots \circ_{l_1} a_{x_{l_1}},$$

where $a_{x_i} \in \{a_1, a_2, \dots, a_s\}$ and $\circ_i \in \widetilde{\mathcal{O}}$. Denoted by $\widetilde{\mathcal{A}} = \langle a_1, a_2, \dots, a_s; \widetilde{\mathcal{O}} \rangle$.

Let $(\widetilde{\mathcal{A}}; \widetilde{\mathcal{O}})$ be a finitely generated multi-system with a generating set \widetilde{S} , $\widetilde{\mathcal{O}} = \{\circ_i | 1 \leq i \leq m\}$. A Cayley diagram $Cay(\widetilde{\mathcal{A}} : \widetilde{S})$ of $(\widetilde{\mathcal{A}}; \widetilde{\mathcal{O}})$ is defined by

$$V(Cay(\widetilde{\mathcal{A}} : \widetilde{S})) = \widetilde{\mathcal{A}},$$

$$E(Cay(\widetilde{\mathcal{A}} : \widetilde{S})) = \{(g, h) \text{ with a label } g^{-1} \circ_i h \mid \exists i, g^{-1} \circ_i h \in \widetilde{S}, 1 \leq i \leq m\}.$$

For the case of multi-groups $(\widetilde{\mathcal{A}}; \widetilde{\mathcal{O}})$, some elementary properties are presented in [Mao3], particularly, if $(\widetilde{\mathcal{A}}; \widetilde{\mathcal{O}})$ is a group, these Cayley diagrams are nothing but the Cayley graphs of finite groups introduced in graph theory, which have many good behaviors. For multi-groups, the following structure result is obtained in [Mao3].

Theorem 2.6.7 *Let $\text{Cay}(\widetilde{\Gamma} : \widetilde{S})$ be a Cayley diagram of a multi-group $(\widetilde{\Gamma}; \widetilde{\mathcal{O}})$ with $\widetilde{\Gamma} = \bigcup_{i=1}^m \Gamma_i$, $\widetilde{\mathcal{O}} = \{\circ_i | 1 \leq i \leq m\}$ and $\widetilde{S} = \bigcup_{i=1}^m S_i$, $\Gamma = \langle S_i; \circ_i \rangle$ for $1 \leq i \leq m$. Then*

$$\text{Cay}(\widetilde{\Gamma} : \widetilde{S}) = \bigcup_{i=1}^n \text{Cay}(\Gamma_i : S_i).$$

□

As we known, few results can be found for Cayley diagrams of multi-systems on publications unless [Mao3]. So, to find out such behaviors for multi-systems is a good topic for researchers.

§2.7 REMARKS

2.7.1 The original form of the combinatorial conjecture for mathematics is that *mathematical science can be reconstructed from or made by combinatorialization*, abbreviated to *CCM Conjecture* in [Mao4] and [Mao10]. Its importance is in combinatorial notion for entirely developing mathematical sciences, which produces an enormous creative power for modern mathematics and physics.

2.7.2 The relation of Smarandache's notion with *LAO ZHI's* thought was first pointed out by the author in [Mao19], reported at the *4th International Conference on Number Theory and Smarandache Problems of Northwest of China* in Xianyang, 2008. Here, combinatorial systems is a generalization of Smarandache systems, also an application of *LAO ZHI's* thought to mathematics. Complete words in *TAO TEH KING* written by *LAO ZHI* can be found in [Sim1]. Further analysis on *LAO ZHI's* thought can consults references [Luj1]-[Luj2] and [WaW1], particularly [Luj1].

2.7.3 These conceptions of multi-group, multi-ring, multi-field and multi-vector space are first presented in [Mao5]-[Mao8] by Smarandache multi-spaces. In Section 2.3, we consider their general case, i.e., *multi-operation systems* and extend the homomorphism theorem to this multi-system. Section 2.4 is a generalization of

works in [Mao7] to multi-modules. There are many trends or topics in multi-systems should be researched, such as extending those of results in groups, rings or linear spaces to multi-systems.

2.7.4 Considering the action of multi-systems on multi-sets is an interesting problem, which requires us to generalize permutation groups to permutation multi-groups. This kind of action, i.e., multi-groups on finite multi-sets can be found in [Mao20]. The construction in Theorems 2.5.1 and 2.5.2 can be also applied to abstract multi-groups. But in fact, an action of a multi-group acting on a multi-set dependent on their combinatorial structures. This means general research on the action of multi-groups must consider their underlying labeled graphs, which is a candidate topic for postgraduate students.

2.7.5 The topic discussed in Section 2.6 can be seen as an application of combinatorial notion to classical algebra. In fact, there are many research trends in *combinatorial algebraic systems*, in algebra or combinatorics. For example, *given an underlying combinatorial structure G , what can we say about its algebraic behavior?* Similarly, *what can we know on its graphical structure, such as in what condition it has a hamiltonian circuit, or a 1-factor? When it is regular?,...*, etc.. Similarly, for Cayley diagrams $Cay(\widetilde{\mathcal{A}} : \widetilde{S})$ of multi-systems $(\widetilde{\mathcal{A}}; \widetilde{O})$, particularly, multi-groups, *what can we know on their structure? Determine those properties of Cayley diagrams $Cay(\widetilde{\mathcal{A}} : \widetilde{S})$ which Cayley graphs of finite groups have.*

CHAPTER 3.

Smarandache manifolds

A Smarandache geometry is a geometrical Smarandache system, which means that there is a Smarandachely denied axiom in this geometrical system, i.e., both validated and invalidated, or just invalidated but in multiple distinct ways, which is a generalization of classical geometries. For example, these *Euclid*, *Lobachevshy-Bolyai-Gauss* and *Riemannian geometries* maybe united altogether in a same space by some Smarandache geometries. A Smarandache geometry can be either partially Euclidean and partially non-Euclidean, or non-Euclidean connected with the *relativity theory* because they include Riemannian geometry in a subspace, also with the *parallel universes* in physics because they combine separate spaces into one space too. A Smarandache manifold is a topological or differential manifold which supports a Smarandache geometry. For an introduction on Smarandache manifolds, Sections 3.1 and 3.2 present the fundamental of algebraic topology and differential on Euclidean spaces for the following discussion. In Section 3.3, we define Smarandache geometries, also with some well-known models, such as Iseri's *s*-manifolds on the plane and Mao's map geometries on surfaces. Then a more general way for constructing Smarandache manifolds, i.e., *pseudo-manifolds* is shown in Section.3.4. Finally, we also introduce differential structure on pseudo-manifolds in this chapter.

§3.1 TOPOLOGICAL SPACES

3.1.1 Topological Space. A *topological space* is a set S together with a collection \mathcal{C} of subsets called *open sets* such that

- (T1) $\emptyset \in \mathcal{C}$ and $S \in \mathcal{C}$;
- (T2) if $U_1, U_2 \in \mathcal{C}$, then $U_1 \cap U_2 \in \mathcal{C}$;
- (T3) the union of any collection of open sets is open.

Example 3.1.1 Let R be the set of real numbers. We have knows these open intervals (a, b) for $a \leq b, a, b \in R$ in elementary mathematics. Define open sets in R to be a union of finite open intervals. Then it can be shown conditions T1-T3 are hold. Consequently, R is a topological space.

A set V is *closed* in a topological space S if $S \setminus V$ is opened. If A is a subset of a topological space S , the *relative topological on A in S* is defined by

$$\mathcal{C}_A = \{ U \cap A \mid \forall U \in \mathcal{C} \}.$$

Applied these identities

- (i) $\emptyset \cap A = \emptyset, S \cap A = A$;
- (ii) $(U_1 \cap U_2) \cap A = (U_1 \cap A) \cap (U_2 \cap A)$;
- (iii) $\bigcup_{\alpha} (U_{\alpha} \cap A) = (\bigcup_{\alpha} U_{\alpha}) \cap A$

in Boolean algebra, we know that \mathcal{C}_A is indeed a topology on A , which is called a subspace with topology \mathcal{C}_A of S .

For a point u in a topological space S , its an *open neighborhood* in S is an open set U such that $u \in U$ and a *neighborhood* in S is a set containing some of its open neighborhoods. Similarly, for a subset A of S , a set U is an *open neighborhood* or *neighborhood* of A if U is open itself or a set containing some open neighborhoods of that set in S . A *basis* in S is a collection \mathcal{B} of subsets of S such that $S = \bigcup_{B \in \mathcal{B}} B$ and $B_1, B_2 \in \mathcal{B}, x \in B_1 \cap B_2$ implies that $\exists B_3 \in \mathcal{B}$ with $x \in B_3 \subset B_1 \cap B_2$ hold.

A topological space S is called *Hausdorff* if each two distinct points have disjoint neighborhoods and *first countable* if for each $p \in S$ there is a sequence $\{U_n\}$ of neighborhoods of p such that for any neighborhood U of p , there is an n such that $U_n \subset U$. The topology is called *second countable* if it has a countable basis.

For a point sequence $\{x_n\}$ in a topological space S , if there is a point $x \in S$

such that for every neighborhood U of u , there is an integer N such that $n \geq N$ implies $x_n \in U$, then we say that $\{u_n\}$ converges to u or u is a *limit point* of $\{u_n\}$.

Let S and T be topological spaces with $\varphi : S \rightarrow T$ a mapping. φ is *continuous* at $u \in S$ if for every neighborhood V of $\varphi(u)$, there is a neighborhood U of u such that $\varphi(U) \subset V$. Furthermore, if φ is continuous at any point u in S , φ is called a *continuous mapping*.

Theorem 3.1.1 *Let R, S and T be topological spaces. If $f : R \rightarrow S$ and $g : S \rightarrow T$ are continuous at $x \in R$ and $f(x) \in S$, then the composition mapping $gf : R \rightarrow T$ is also continuous at x .*

Proof Since f and g are respective continuous at $x \in R$ and $f(x) \in S$, for any open neighborhood W of point $g(f(x)) \in T$, $g^{-1}(W)$ is opened neighborhood of $f(x)$ in S . Whence, $f^{-1}(g^{-1}(W))$ is an opened neighborhood of x in R by definition. Therefore, $g(f)$ is continuous at x . \square

The following result, usually called *Gluing Lemma*, is very useful in constructing continuous mappings on a union of spaces.

Theorem 3.1.2 *Assume that a space X is a finite union of closed subsets: $X = \bigcup_{i=1}^n X_i$. If for some space Y , there are continuous maps $f_i : X_i \rightarrow Y$ that agree on overlaps, i.e., $f_i|_{X_i \cap X_j} = f_j|_{X_i \cap X_j}$ for all i, j , then there exists a unique continuous $f : X \rightarrow Y$ with $f|_{X_i} = f_i$ for all i .*

Proof Obviously, the mapping f defined by

$$f(x) = f_i(x), \quad x \in X_i$$

is the unique well defined mapping from X to Y with restrictions $f|_{X_i} = f_i$ hold for all i . So we only need to establish the continuity of f on X . In fact, if U is an open set in Y , then

$$\begin{aligned} f^{-1}(U) &= X \cap f^{-1}(U) = \left(\bigcup_{i=1}^n X_i \right) \cap f^{-1}(U) \\ &= \bigcup_{i=1}^n (X_i \cap f^{-1}(U)) = \bigcup_{i=1}^n (X_i \cap f_i^{-1}(U)) = \bigcup_{i=1}^n f_i^{-1}(U). \end{aligned}$$

By assumption, each f_i is continuous. We know that $f_i^{-1}(U)$ is open in X_i . Whence, $f^{-1}(U)$ is open in X , i.e., f is continuous on X . \square

A collection $\mathcal{C} \subset 2^X$ is called a *cover* of X if

$$\bigcup_{C \in \mathcal{C}} C = X.$$

If each set in \mathcal{C} is open, \mathcal{C} is called an *opened cover* and if $|\mathcal{C}|$ is finite, it is called a *finite cover* of X . A topological space is *compact* if there exists a finite cover in its any opened cover and *locally compact* if it is Hausdorff with a compact neighborhood for its each point. As a consequence of Theorem 3.1.2, we can apply the gluing lemma to ascertain continuous mappings shown in the next.

Corollary 3.1.1 *Let $\{A_1, A_2, \dots, A_n\}$ be a finite opened cover. If a mapping $f : X \rightarrow Y$ is continuous constrained on each A_i , $1 \leq i \leq n$, then f is a continuous mapping.*

Two topological spaces S and T are *homeomorphic* if there is a 1-1 continuous mapping $\varphi : S \rightarrow T$ such that its inverse $\varphi^{-1} : T \rightarrow S$ is also continuous. Such mapping φ is called a *homeomorphic* or *topological mapping*. A invariant of topological spaces is said *topological invariant* if it is not variable under homeomorphic mappings. In topology, a fundamental problem is *to classify topological spaces*, or equivalently, *to determine whether two given spaces are homeomorphic*. Certainly, we have known many homeomorphic spaces, particularly, spaces shown in the following example.

Example 3.1.2 Each of the following topological space pairs are homeomorphic.

(1) a Euclidean space \mathbf{R}^n and an opened unit n -ball $B^n = \{(x_1, x_2, \dots, x_n) | x_1^2 + x_2^2 + \dots + x_n^2 < 1\}$;

(2) a Euclidean plane \mathbf{R}^2 and a unit sphere $S^2 = \{(x, y, z) | x^2 + y^2 + z^2 = 1\}$ with one point (x_0, y_0, z_0) on it removed;

(3) A unit circle with an equilateral triangle.

In fact, for the case (1), a homeomorphic mapping f from B^n to \mathbf{R}^n is defined by

$$f(x_1, x_2, \dots, x_n) = \frac{(x_1, x_2, \dots, x_n)}{1 - \sqrt{x_1^2 + x_2^2 + \dots + x_n^2}}$$

for $\forall(x_1, x_2, \dots, x_n) \in B^n$ with an inverse

$$f^{-1}(x_1, x_2, \dots, x_n) = \frac{(x_1, x_2, \dots, x_n)}{1 + \sqrt{x_1^2 + x_2^2 + \dots + x_n^2}}$$

for $\forall(x_1, x_2, \dots, x_n) \in \mathbf{R}^n$.

For the case (2), let (x_0, y_0, z_0) be the north pole with coordinate $(0, 0, 1)$ and the Euclidean plane \mathbf{R}^2 be a plane containing the circle $\{(x, y) \mid x^2 + y^2 = 1\}$. Then a homeomorphic mapping g from S^2 to \mathbf{R}^2 is defined by

$$g(x, y, z) = \left(\frac{x}{1-z}, \frac{y}{1-z} \right).$$

The readers are required to find a homeomorphic mapping in the case (3).

3.1.2 Metric Space. A *metric space* $(M; \rho)$ is a set M associated with a metric function $\rho : M \times M \rightarrow R^+ = \{x \mid x \in R, x \geq 0\}$ with conditions following for ρ hold for $\forall x, y, z \in M$.

(1)(*definiteness*) $\rho(x, y) = 0$ if and only if $x = y$;

(ii)(*symmetry*) $\rho(x, y) = \rho(y, x)$;

(iii)(*triangle inequality*) $\rho(x, y) + \rho(y, z) \geq \rho(x, z)$.

For example, the standard metric function on a Euclidean space \mathbf{R}^n is defined by

$$\rho(\mathbf{x}, \mathbf{y}) = \sqrt{\sum_{i=1}^n (x_i - y_i)^2}$$

for $\forall \mathbf{x} = (x_1, x_2, \dots, x_n)$ and $\mathbf{y} = (y_1, y_2, \dots, y_n) \in \mathbf{R}^n$.

Let $(M; \rho)$ be a metric space. For a given number $\epsilon > 0$ and $\forall p \in M$, the ϵ -*disk* on p is defined by

$$D_\epsilon(p) = \{ q \in M \mid \rho(q, p) < \epsilon \}.$$

A metric topology on $(M; \rho)$ is a collection of unions of such disks. Indeed, it is really a topology on M with conditions (T1)-(T3) hold.

In fact, the conditions (T1) and (T2) are clearly hold. For the condition (T3), let $x \in D_{\epsilon_1}(x_1) \cap D_{\epsilon_2}(x_2)$ and $0 < \epsilon_x = \min\{\epsilon_1 - \rho(x, x_1), \epsilon_2 - \rho(x, x_2)\}$. Then $D_{\epsilon_x}(x) \subset$

$D_{\epsilon_1}(x_1) \cap D_{\epsilon_2}(x_2)$ since for $\forall y \in D_{\epsilon_x}(x)$,

$$\rho(y, x_1) \leq \rho(y, x) + \rho(x, x_1) < \epsilon_x + \rho(x, x_1) < \epsilon_1.$$

Similarly, we know that $\rho(y, x) < \epsilon_2$. Therefore, $D_{\epsilon_x}(x) \subset D_{\epsilon_1}(x_1) \cap D_{\epsilon_2}(x_2)$, we find that

$$D_{\epsilon_1}(x_1) \cap D_{\epsilon_2}(x_2) = \bigcup_{x \in D_{\epsilon_1}(x_1) \cap D_{\epsilon_2}(x_2)} D_{\epsilon_x}(x),$$

i.e., it enables the condition (T3) hold.

Let $(M; \rho)$ be a metric space. For a point $x \in M$ and $A \subset M$, define $\rho(x, A) = \inf\{d(x, a) | a \in A\}$ if $A \neq \emptyset$, otherwise, $\rho(x, \emptyset) = \infty$. The *diameter of a set* $A \subset M$ is defined by $\text{diam}(A) = \sup\{\rho(x, y) | x, y \in A\}$. Now let $x_1, x_2, \dots, x_n, \dots$ be a point sequence in a metric space $(M; \rho)$. If there is a point $x \in M$ such that for every $\epsilon > 0$ there is an integer N implies that $\rho(x_n, x) < \epsilon$ providing $n \geq N$, then we say the sequence $\{x_n\}$ *converges to* x or x is a *limit point* of $\{x_n\}$, denoted by $\lim_{n \rightarrow \infty} x_n = x$. The following result, called *Lebesgue lemma*, is a useful result in metric spaces.

Theorem 3.1.3(Lebesgue Lemma) *Let $\{V_\alpha | \alpha \in \Pi\}$ be an opened cover of a compact metric space $(M; \rho)$. Then there exists a positive number λ such that each subset A of diameter less than λ is contained in one of member of $\{V_\alpha | \alpha \in \Pi\}$. The number λ is called the Lebesgue number.*

Proof The proof is by contradiction. If there no such Lebesgue number λ , choosing numbers $\epsilon_1, \epsilon_2, \dots$ with $\lim_{n \rightarrow \infty} \epsilon_n = 0$, we can construct a sequence $A_1 \supset A_2 \supset \dots$ with diameter $\text{diam}(A_n) = \epsilon_n$, but each A_n is not a subset of one member in $\{V_\alpha | \alpha \in \Pi\}$ for $n \geq 1$. Whence, $\lim_{n \rightarrow \infty} \text{diam}(A_n) = 0$. Choose a point x_n in each A_n and $x \in \bigcap_{i \geq 1} A_i$. Then $\lim_{n \rightarrow \infty} x_n = x$.

Now let $x \in V_{\alpha_0}$ and $D_\epsilon(x)$ an ϵ -disk of x in V_{α_0} . Since $\lim_{n \rightarrow \infty} \text{diam}(A_n) = 0$, let m be a sufficient large number such that $\text{diam}(A_m) < \epsilon/2$ and $x_m \in D_{\epsilon/2}(x)$. For $\forall y \in A_m$, we find that

$$\begin{aligned} \rho(y, x) &\leq \rho(y, x_m) + \rho(x_m, x) \\ &< \text{diam}(A_m) + \frac{\epsilon}{2} < \epsilon, \end{aligned}$$

which means that $y \in D_\epsilon(x) \subseteq V_{\alpha_0}$, i.e., $A_m \subseteq V_{\alpha_0}$, a contradiction. \square

3.1.3 Fundamental Group. A topological space S is *connected* if there are no open subspaces A and B such that $S = A \cup B$ with $A, B \neq \emptyset$. A useful way for characterizing connectedness is by arcwise connectedness. Certainly, topological spaces are arcwise connected in most cases considered in topology.

Definition 3.1.1 Let S be a topological space and $I = [0, 1] \subset \mathbf{R}$. An arc a in S is a continuous mapping $a : I \rightarrow S$ with initial point $a(0)$ and end point $a(1)$, and S is called *arcwise connected* if every two points in S can be joined by an arc in S . An arc $a : I \rightarrow S$ is a *loop based at p* if $a(0) = a(1) = p \in S$. A *degenerated loop* $e : I \rightarrow x \in S$, i.e., mapping each element in I to a point x , usually called a *point loop*.

For example, let G be a planar 2-connected graph on \mathbf{R}^2 and S is a topological space consisting of points on each $e \in E(G)$. Then S is a arcwise connected space by definition. For a circuit C in G , we choose any point p on C . Then C is a loop e_p in S based at p .

Definition 3.1.2 Let a and b be two arcs in a topological space S with $a(1) = b(0)$. A *product mapping* $a \cdot b$ of a with b is defined by

$$a \cdot b(t) = \begin{cases} a(2t), & \text{if } 0 \leq t \leq \frac{1}{2}, \\ b(2t - 1), & \text{if } \frac{1}{2} \leq t \leq 1 \end{cases}$$

and an *inverse mapping* $\bar{a} = a(1 - t)$ by a .

Notice that $a \cdot b : I \rightarrow S$ and $\bar{a} : I \rightarrow S$ are continuous by Corollary 3.1.1. Whence, they are indeed arcs by definition, called the *product arc* of a with b and the *inverse arc* of a . Sometimes it is needed to distinguish the orientation of an arc. We say the arc a *orientation preserving* and its inverse \bar{a} *orientation reversing*.

Now let a, b be arcs in a topological space S . Properties following are hold by definition.

$$(P1) \quad \overline{\bar{a}} = a;$$

$$(P2) \quad \overline{\bar{b} \cdot \bar{a}} = \overline{a \cdot b} \text{ providing } ab \text{ existing};$$

$$(P3) \quad \bar{e}_x = e_x, \text{ where } x = e(0) = e(1).$$

Definition 3.1.3 Let S be a topological space and $a, b : I \rightarrow S$ two arcs with $a(0) = b(0)$ and $a(1) = b(1)$. If there exists a continuous mapping

$$H : I \times I \rightarrow S$$

such that $H(t, 0) = a(t)$, $H(t, 1) = b(t)$ for $\forall t \in I$, then a and b are said homotopic, denoted by $a \simeq b$ and H a homotopic mapping from a to b .

Theorem 3.1.4 *The homotopic \simeq is an equivalent relation, i.e., all arcs homotopic to an arc a is an equivalent arc class, denoted by $[a]$.*

Proof Let a, b, c be arcs in a topological space S , $a \simeq b$ and $b \simeq c$ with homotopic mappings H_1 and H_2 . Then

(i) $a \simeq a$ if choose $H : I \times I \rightarrow S$ by $H(t, s) = a(t)$ for $\forall s \in I$.

(ii) $b \simeq a$ if choose $H(t, s) = H_1(t, 1 - s)$ for $\forall s, t \in I$ which is obviously continuous;

(iii) $a \simeq c$ if choose $H(t, s) = H_2(H_1(t, s))$ for $\forall s, t \in I$ by applying Theorem 3.1.1 for the continuity of composition mappings. \square

Theorem 3.1.5 *Let a, b, c and d be arcs in a topological space S . Then*

(i) $\bar{a} \simeq \bar{b}$ if $a \simeq b$;

(ii) $a \cdot b \simeq c \cdot d$ if $a \simeq b$, $c \simeq d$ with $a \cdot c$ an arc.

proof Let H_1 be a homotopic mapping from a to b . Define a continuous mapping $H' : I \times I \rightarrow S$ by $H'(t, s) = H_1(1 - t, s)$ for $\forall t, s \in I$. Then we find that $H'(t, 0) = \bar{a}(t)$ and $H'(t, 1) = \bar{b}(t)$. Whence, we get that $\bar{a} \simeq \bar{b}$, i.e., the assertion (i).

For (ii), let H_2 be a homotopic mapping from c to d . Define a mapping $H : I \times I \rightarrow S$ by

$$H(t, s) = \begin{cases} H_1(2t, s), & \text{if } 0 \leq t \leq \frac{1}{2}, \\ H_2(2t - 1, s), & \text{if } \frac{1}{2} \leq t \leq 1. \end{cases}$$

Notice that $a(1) = c(0)$ and $H_1(1, s) = a(1) = c(0) = H_2(0, s)$. Applying Corollary 3.1.1, we know that H is continuous. Therefore, $a \cdot b \simeq c \cdot d$. \square

Definition 3.1.4 *For a topological space S and $x_0 \in S$, let $\pi_1(S, x_0)$ be a set consisting of equivalent classes of loops based at x_0 . Define an operation \circ in \mathcal{A} by*

$$[a] \circ [b] = [a \cdot b] \quad \text{and} \quad [a]^{-1} = [a^{-1}].$$

Then we know that $\pi_1(S, x_0)$ is a group shown in the next.

Theorem 3.1.6 $\pi_1(S, x_0)$ is a group.

Proof We check each condition of a group for $\pi_1(S, x_0)$. First, it is closed under the operation \circ since $[a] \circ [b] = [a \cdot b]$ is an equivalent class of loop $a \cdot b$ based at x_0 for $\forall [a], [b] \in \pi_1(S, x_0)$.

Now let $a, b, c : I \rightarrow S$ be three loops based at x_0 . By Definition 3.1.2, we know that

$$(a \cdot b) \cdot c(t) = \begin{cases} a(4t), & \text{if } 0 \leq t \leq \frac{1}{4}, \\ b(4t - 1), & \text{if } \frac{1}{4} \leq t \leq \frac{1}{2}, \\ c(2t - 1), & \text{if } \frac{1}{2} \leq t \leq 1. \end{cases}$$

and

$$a \cdot (b \cdot c)(t) = \begin{cases} a(2t), & \text{if } 0 \leq t \leq \frac{1}{2}, \\ b(4t - 2), & \text{if } \frac{1}{2} \leq t \leq \frac{3}{4}, \\ c(4t - 3), & \text{if } \frac{3}{4} \leq t \leq 1. \end{cases}$$

Consider a function $H : I \times I \rightarrow S$ defined by

$$H(t, s) = \begin{cases} a\left(\frac{4t}{1+s}\right), & \text{if } 0 \leq t \leq \frac{s+1}{4}, \\ b(4t - 1 - s), & \text{if } \frac{s+1}{4} \leq t \leq \frac{s+2}{4}, \\ c\left(1 - \frac{4(1-t)}{2-s}\right), & \text{if } \frac{s+2}{4} \leq t \leq 1. \end{cases}$$

Then H is continuous by applying Corollary 3.1.1, $H(t, 0) = ((a \cdot b) \cdot c)(t)$ and $H(t, 1) = (a \cdot (b \cdot c))(t)$. Consequently, we know that $([a] \circ [b]) \circ [c] = [a] \circ ([b] \circ [c])$.

Now let $\mathbf{e}_{x_0} : I \rightarrow x_0 \in S$ be the point loop at x_0 . Then it is easily to check that

$$a \cdot \bar{a} \simeq \mathbf{e}_{x_0}, \quad \bar{a} \cdot a \simeq \mathbf{e}_{x_0}$$

and

$$\mathbf{e}_{x_0} \cdot a \simeq a, \quad a \cdot \mathbf{e}_{x_0} \simeq a.$$

We conclude that $\pi_1(S, x_0)$ is a group with a unit $[\mathbf{e}_{x_0}]$ and an inverse element $[a^{-1}]$ for any $[a] \in \pi_1(S, x_0)$ by definition. \square

Let S be a topological space, $x_0, x_1 \in S$ and \mathcal{L} an arc from x_0 to x_1 . For $\forall [a] \in \pi_1(S, x_0)$, we know that $\mathcal{L} \circ [a] \circ \mathcal{L}^{-1} \in \pi_1(S, x_1)$ (see Fig.3.1.1 below). Whence, the mapping $\mathcal{L}_\# = \mathcal{L} \circ [a] \circ \mathcal{L}^{-1} : \pi_1(S, x_0) \rightarrow \pi_1(S, x_1)$.

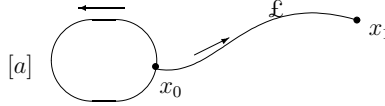

Fig.3.1.1

Theorem 3.1.7 *Let S be a topological space. If $x_0, x_1 \in S$ and \mathcal{L} is an arc from x_0 to x_1 in S , then $\pi_1(S, x_0) \cong \pi_1(S, x_1)$.*

Proof We have known that $\mathcal{L}_\# : \pi_1(S, x_0) \rightarrow \pi_1(S, x_1)$. Now for $[a], [b] \in \pi_1(S, x_0)$, $[a] \neq [b]$, we find that

$$\mathcal{L}_\#([a]) = \mathcal{L} \circ [a] \circ \mathcal{L}^{-1} \neq \mathcal{L} \circ [b] \circ \mathcal{L}^{-1} = \mathcal{L}_\#([b]),$$

i.e., $\mathcal{L}_\#$ is a 1 – 1 mapping. Let $[c] \in \pi_1(S, x_0)$. Then

$$\begin{aligned} \mathcal{L}_\#([a]) \circ \mathcal{L}_\#([c]) &= \mathcal{L} \circ [a] \circ \mathcal{L}^{-1} \circ \mathcal{L} \circ [c] \circ \mathcal{L}^{-1} = \mathcal{L} \circ [a] \circ \mathbf{e}_{x_1} \circ [c] \circ \mathcal{L}^{-1} \\ &= \mathcal{L} \circ [a] \circ [c] \circ \mathcal{L}^{-1} = \mathcal{L}_\#([a] \circ [c]). \end{aligned}$$

Therefore, $\mathcal{L}_\#$ is a homomorphism.

Similarly, $\mathcal{L}_\#^{-1} = \mathcal{L}^{-1} \circ [a] \circ \mathcal{L}$ is also a homomorphism from $\pi_1(S, x_1)$ to $\pi_1(S, x_0)$ and $\mathcal{L}_\#^{-1} \circ \mathcal{L}_\# = [\mathbf{e}_{x_1}]$, $\mathcal{L}_\# \circ \mathcal{L}_\#^{-1} = [\mathbf{e}_{x_0}]$ are the identity mappings between $\pi_1(S, x_0)$ and $\pi_1(S, x_1)$. Whence, $\mathcal{L}_\#$ is an isomorphism. \square

Theorem 3.1.7 says that all fundamental groups in an arcwise connected space S are isomorphic, i.e., independent on the choice of base point x_0 . Whence, we can denote its fundamental group by $\pi_1(S)$. Particularly, if $\pi_1(S) = \{[e_{x_0}]\}$, S is called a *simply connected space*. These Euclidean space \mathbf{R}^n and n -ball are well-known simply connected spaces.

For a non-simply connected space S , to determine its fundamental group is complicated. For example, the fundamental group of n -sphere $S^n = \{ (x_1, x_2, \dots, x_n) \mid x_1^2 + x_2^2 + \dots + x_n^2 = 1 \}$ is

$$\pi_1(S^n) = \begin{cases} \mathbf{e}_{x_0}, & \text{if } n \geq 2, \\ Z, & \text{if } n = 2, \end{cases}$$

seeing [Amr1] or [Mas1] for details.

Theorem 3.1.8 *Let G be an embedded graph on a topological space S and T a spanning tree in G . Then $\pi_1(G) = \langle T + e \mid e \in E(G) \setminus \{e\} \rangle$.*

Proof We prove this assertion by induction on the number of $n = |E(T)|$. If $n = 0$, G is a bouquet, then each edge e is a loop itself. A closed walk on G is a combination of edges e in $E(G)$, i.e., $\pi_1(G) = \langle e \mid e \in E(G) \rangle$ in this case.

Assume the assertion is true for $n = k$, i.e., $\pi_1(G) = \langle T + e \mid e \in E(G) \setminus \{e\} \rangle$. Consider the case of $n = k + 1$. For any edge $\widehat{e} \in E(T)$, we consider the embedded graph G/\widehat{e} , which means continuously to contract \widehat{e} to a point v in S . A closed walk on G passes or not through \widehat{e} in G is homotopic to a walk passes or not through v in G/\widehat{e} for $\kappa(T) = 1$. Therefore, we conclude that $\pi_1(G) = \langle T + e \mid e \in E(G) \setminus \{e\} \rangle$ by the induction assumption. \square

For calculating fundamental groups of topological spaces, the following *Seifert and Van-Kampen theorem* is useful.

Theorem 3.1.9(Seifert and Van-Kampen) *Let S_1, S_2 be two open sets of a topological space S with $S = S_1 \cup S_2$. If there S, S_1, S_2 and $S_1 \cap S_2$ are non-empty arcwise connected, then for $\forall x_0 \in S$,*

$$\pi_1(S, x_0) \cong \frac{\pi_1(S_1, x_0)\pi_1(S_2, x_0)}{\langle (i_1)_\pi([a])(i_2)_\pi[a^{-1}] \mid [a] \in \pi_1(S_0, x_0) \rangle^N},$$

where $i_l : S_0 \hookrightarrow S_l$ is the inclusion mapping and $(i_l)_\pi : \pi_1(S_0, x_0) \rightarrow \pi_1(S_l, x_0)$, an homomorphism induced by i_l for $l = 1, 2$ and $\langle (i_1)_\pi([a])(i_2)_\pi[a^{-1}] \mid [a] \in \pi_1(S_0, x_0) \rangle^N$ the normal closure generated by $(i_1)_\pi([a])(i_2)_\pi[a^{-1}]$, $[a] \in \pi_1(S_0, x_0)$ in $\pi_1(S, x_0)$. \square

Complete proof of the Seifert and Van-Kampen theorem can be found in the reference [Mas1]. Corollaries following is appropriate in practical applications.

Corollary 3.1.2 *Let S_1, S_2 be two open sets of a topological space S with $S = S_1 \cup S_2$, S_2 simply connected and S, S_1 and $S_1 \cap S_2$ non-empty arcwise connected, then for $\forall x_0 \in S$,*

$$\pi_1(S, x_0) \cong \frac{\pi_1(S_1, x_0)}{\langle (i_1)_\pi([a]) \mid [a] \in \pi_1(S_0, x_0) \rangle^N}.$$

Corollary 3.1.3 *Let S_1, S_2 be two open sets of a topological space S with $S = S_1 \cup S_2$. If there S, S_1, S_2 are non-empty arcwise connected and $S_1 \cap S_2$ simply connected, then for $\forall x_0 \in S$,*

$$\pi_1(S, x_0) \cong \pi_1(S_1, x_0)\pi_1(S_2, x_0).$$

Corollary 3.1.3 can be applied to find the fundamental group of an embedded graph, particularly, a bouquet B_n consisting of n loops $L_i, 1 \leq i \leq n$ again following, which is the same as in Theorem 3.1.8.

Let x_0 be the common point in B_n . For $n = 2$, denote the two loop spaces by $B_1^{(1)}$ and $B_1^{(2)}$ respectively. Applying Corollary 3.1.2, we get that

$$\pi_1(B_2, x_0) \cong \pi_1(B_1^{(1)}, x_0)\pi_1(B_1^{(2)}, x_0) = \langle L_1 \rangle \langle L_2 \rangle = \langle L_1, L_2 \rangle.$$

If $n \geq 2$, we can chose $S_1 = B_{n-1}$ and $S_2 = B_n \setminus B_{n-1}$. By applying Corollary 3.1.3, we know that

$$\pi_1(B_n, x_0) \cong \pi_1(B_{n-1}, x_0)\pi_1(B_n \setminus B_{n-1}, x_0) = \pi_1(B_{n-1}, x_0) \langle L_n \rangle.$$

Applying the induction principle, we finally find the fundamental group of B_n

$$\pi_1(B_n, x_0) = \langle L_i, 1 \leq i \leq n \rangle.$$

3.1.4 Covering Space A *covering space* \tilde{S} of S consisting of a space \tilde{S} with a continuous mapping $p : \tilde{S} \rightarrow S$ such that each point $x \in S$ has an arcwise connected neighborhood U_x and each arcwise connected component of $p^{-1}(U_x)$ is mapped topologically onto U_x by p . An opened neighborhoods U_x that satisfies the condition just stated is called an *elementary neighborhood* and p is often called a *projection from \tilde{S} to S* .

For example, let $p : \mathbf{R} \rightarrow S^1$ be defined by

$$p(t) = (\sin(t), \cos(t))$$

for any real number $t \in \mathbf{R}$. Then the pair (\mathbf{R}, p) is a covering space of the unit circle S^1 . In this example, each opened subinterval on S^1 serves as an elementary neighborhood.

Definition 3.1.5 Let S, T be topological spaces, $x_0 \in S, y_0 \in T$ and $f : (T, y_0) \rightarrow (S, x_0)$ a continuous mapping. If (\tilde{S}, p) is a covering space of S , $\tilde{x}_0 \in \tilde{S}$, $x_0 = p(\tilde{x}_0)$ and there exists a mapping $f^l : (T, y_0) \rightarrow (\tilde{S}, \tilde{x}_0)$ such that

$$f = f^l \circ p,$$

then f^l is a lifting of f , particularly, if f is an arc, f^l is called a lifting arc.

Theorem 3.1.10 Let (\tilde{S}, p) be a covering space of S , $\tilde{x}_0 \in \tilde{X}$ and $p(\tilde{x}_0) = x_0$. Then there exists a unique lifting arc $f^l : I \rightarrow \tilde{S}$ with initial point \tilde{x}_0 for each arc $f : I \rightarrow S$ with initial point x_0 .

Proof If the arc f were contained in an arcwise connected neighborhood U , let V be an arcwise connected component of $p^{-1}(U)$ which contains \tilde{x}_0 , then there would exist a unique f^l in V since p topologically maps V onto U by definition.

Now let $\{U_i\}$ be a covering of S by elementary neighborhoods. Then $\{f^{-1}(U_i)\}$ is an opened cover of the unit interval I , a compact metric space. Choose an integer n so large that $1/n$ is less than the Lebesgue number of this cover. We divide the interval I into these closed subintervals $[0, 1/n], [1/n, 2/n], \dots, [(n-1)/n, 1]$.

According to Theorem 3.1.3, f maps each subinterval into an elementary neighborhood in $\{U_i\}$. Define f^l a successive lifting over these subintervals. Its connectedness is confirmed by Corollary 3.1.1.

For the uniqueness, assume f_1^l and f_2^l be two liftings of an arc $f : I \rightarrow S$ with $f_1^l(x_0) = f_2^l(x_0)$ at the initial point x_0 . Denote $A = \{x \in I | f_1^l(x) = f_2^l(x)\}$. We prove that $A = I$. In fact, we only need to prove it is both closed and opened.

If A is closed, let $x_1 \in A$ and $x = pf_1^l(x_1) = pf_2^l(x_1)$. Then $f_1^l(x_1) \neq f_2^l(x_1)$. We show this will lead to a contradiction. For this object, let U be an elementary neighborhood of x and V_1, V_2 the different components of $p^{-1}(U)$ containing $f_1^l(x_1)$ and $f_2^l(x_1)$, respectively, i.e., $V_1 \cap V_2 = \emptyset$. For the connectedness of f_1^l, f_2^l , we can find a neighborhood W of x_1 such that $f_1^l(W) \subset V_1$ and $f_2^l(W) \subset V_2$. Applying the fact that any neighborhood W of x_1 must meet A , i.e., $f(W \cap A) \subset V_0 \cap V_1$, a contradiction. Whence, A is closed.

Similarly, if \bar{A} is closed, a contradiction can be also find. Therefore, A is both closed and opened. Since $A \neq \emptyset$, we find that $A = I$, i.e., $f_1^l = f_2^l$. \square

Theorem 3.1.11 *Let (\tilde{S}, p) be a covering space of S , $\tilde{x}_0 \in \tilde{S}$ and $p(\tilde{x}_0) = x_0$. Then*

- (i) *the induced homomorphism $p_* : \pi(\tilde{S}, \tilde{x}_0) \rightarrow \pi(S, x_0)$ is a monomorphism;*
- (ii) *for $\tilde{x} \in p^{-1}(x_0)$, the subgroups $p_*\pi(\tilde{S}, \tilde{x}_0)$ are exactly a conjugacy class of subgroups of $\pi(S, x_0)$.*

Proof Applying Theorem 3.10, for $\tilde{x}_0 \in \tilde{S}$ and $p(\tilde{x}_0) = x_0$, there is a unique mapping on loops from \tilde{S} with base point \tilde{x}_0 to S with base point x_0 . Now let $L_i : I \rightarrow \tilde{S}$, $i = 1, 2$ be two arcs with the same initial point \tilde{x}_0 in \tilde{S} . We prove that if $pL_1 \simeq pL_2$, then $L_1 \simeq L_2$.

Notice that $pL_1 \simeq pL_2$ implies the existence of a continuous mapping $H : I \times I \rightarrow S$ such that $H(s, 0) = pL_1(s)$ and $H(s, 1) = pL_2(s)$. Similar to the proof of Theorem 3.10, we can find numbers $0 = s_0 < s_1 < \dots < s_m = 1$ and $0 = t_0 < t_1 < \dots < t_n = 1$ such that each rectangle $[s_{i-1}, s_i] \times [t_{j-1}, t_j]$ is mapped into an elementary neighborhood in S by H .

Now we construct a mapping $G : I \times I \rightarrow \tilde{S}$ with $pG = H, G(0, 0) = \tilde{x}_0$ hold by the following procedure.

First, we can choose G to be a lifting of H over $[0, s_1] \times [0, t_1]$ since H maps this rectangle into an elementary neighborhood of $p(\tilde{x}_0)$. Then we extend the definition of G successively over the rectangles $[s_{i-1}, s_i] \times [0, t_1]$ for $i = 2, 3, \dots, m$ by taking care that it is agree on the common edge of two successive rectangles, which enables us to get G over the strip $I \times [0, t_1]$. Similarly, we can extend it over these rectangles $I \times [t_1, t_2], [t_2, t_3], \dots$, etc.. Consequently, we get a lifting H^l of H , i.e., $L_1 \simeq L_2$ by this construction.

Particularly, If L_1 and L_2 were two loops, we get the induced monomorphism homomorphism $p_* : \pi(\tilde{S}, \tilde{x}_0) \rightarrow \pi(S, x_0)$. This is the assertion of (i).

For (ii), suppose \tilde{x}_1 and \tilde{x}_2 are two points of \tilde{S} such that $p(\tilde{x}_1) = p(\tilde{x}_2) = x_0$. Choose a class L of arcs in \tilde{S} from \tilde{x}_1 to \tilde{x}_2 . Similar to the proof of Theorem 3.1.7, we know that $\mathcal{L} = L[a]L^{-1}, [a] \in \pi(\tilde{S}, \tilde{x}_1)$ defines an isomorphism $\mathcal{L} : \pi(\tilde{S}, \tilde{x}_1) \rightarrow \pi(\tilde{S}, \tilde{x}_2)$. Whence, $p_*(\pi(\tilde{S}, \tilde{x}_1)) = p_*(L)\pi(\tilde{S}, \tilde{x}_2)p_*(L^{-1})$. Notice that $p_*(L)$ is a loop with a base point x_0 . We know that $p_*(L) \in \pi(S, x_0)$, i.e., $p_*\pi(\tilde{S}, \tilde{x}_0)$ are exactly a conjugacy class of subgroups of $\pi(S, x_0)$. \square

Theorem 3.1.12 *If (\tilde{S}, p) is a covering space of S , then the sets $p^{-1}(x)$ have the same cardinal number for all $x \in S$.*

Proof For any points x_1 and $x_2 \in S$, choosing an arc f in S with initial point x_1 and terminal point x_2 . Applying f , we can define a mapping $\Psi : p^{-1}(x_1) \rightarrow p^{-1}(x_2)$ by the following procedure.

For $\forall y_1 \in p^{-1}(x_1)$, we lift f to an arc f^l in \tilde{S} with initial point y_1 such that $pf^l = f$. Denoted by y_2 the terminal point of f^l . Define $\Psi(y_1) = y_2$.

By applying the inverse arc f^{-1} , we can define $\Psi^{-1}(y_2) = y_1$ in an analogous way. Therefore, ψ is a 1 – 1 mapping form $p^{-1}(x_1)$ to $p^{-1}(x_2)$. \square

The common cardinal number of the sets $p^{-1}(x)$ for $x \in S$ is called the *number of sheets* of the covering space (\tilde{S}, p) on S . If $|p^{-1}(x)| = n$ for $x \in S$, we also say it is an n -sheeted covering.

We present an example for constructing covering spaces of graphs by voltage assignment.

Example 3.1.3 Let G be a connected graph and $(\Gamma; \circ)$ a group. For each edge $e \in E(G)$, $e = uv$, an *orientation* on e is an orientation on e from u to v , denoted by $e = (u, v)$, called *plus orientation* and its *minus orientation*, from v to u , denoted by $e^{-1} = (v, u)$. For a given graph G with plus and minus orientation on its edges, a *voltage assignment* on G is a mapping α from the plus-edges of G into a group Γ satisfying $\alpha(e^{-1}) = \alpha^{-1}(e)$, $e \in E(G)$. These elements $\alpha(e)$, $e \in E(G)$ are called voltages, and (G, α) a *voltage graph* over the group $(\Gamma; \circ)$.

For a voltage graph (G, α) , its lifting $G^\alpha = (V(G^\alpha), E(G^\alpha); I(G^\alpha))$ is defined by

$$V(G^\alpha) = V(G) \times \Gamma, \quad (u, a) \in V(G) \times \Gamma \text{ abbreviated to } u_a;$$

$$E(G^\alpha) = \{(u_a, v_{aob}) | e^+ = (u, v) \in E(G), \alpha(e^+) = b\}$$

and

$$I(G^\alpha) = \{(u_a, v_{aob}) | I(e) = (u, v) \text{ if } e = (u, v) \in E(G^\alpha)\}.$$

This is a $|\Gamma|$ -sheet covering of the graph G . For example, let $G = K_3$ and $\Gamma = Z_2$. Then the voltage graph (K_3, α) with $\alpha : K_3 \rightarrow Z_2$ and its lifting are shown

in Fig.3.1.2.

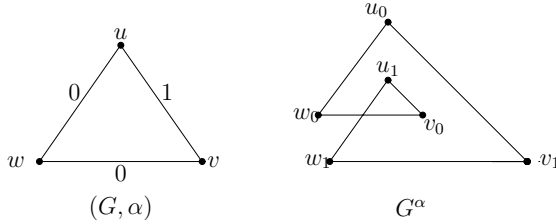

Fig.3.1.2

We can find easily that there is a unique lifting path in Γ^l with an initial point \tilde{x} for each path with an initial point x in Γ , and for $\forall x \in \Gamma$, $|p^{-1}(x)| = 2$.

Let (\tilde{S}_1, p_1) and (\tilde{S}_2, p_2) be two covering spaces of S . We say them *equivalent* if there is a continuous mapping $\varphi : (\tilde{S}_1, p_1) \rightarrow (\tilde{S}_2, p_2)$ such that $p_1 = p_2\varphi$, particularly, if $\varphi : (\tilde{S}, p) \rightarrow (\tilde{S}, p)$, we say φ an automorphism of covering space (\tilde{S}, p) onto itself. If so, according to Theorem 3.1.11, $p_{1*}\pi(\tilde{S}_1, \tilde{x}_1)$ and $p_{2*}\pi(\tilde{S}_1, \tilde{x}_2)$ both are conjugacy classes in $\pi(S, x_0)$. Furthermore, we know the following result.

Theorem 3.1.13 *Two covering spaces (\tilde{S}_1, p_1) and (\tilde{S}_2, p_2) of S are equivalent if and only if for any two points $\tilde{x}_1 \in \tilde{S}_1$, $\tilde{x}_2 \in \tilde{S}_2$ with $p_1(\tilde{x}_1) = p_2(\tilde{x}_2) = x_0$, these subgroups $p_{1*}\pi(\tilde{S}_1, \tilde{x}_1)$ and $p_{2*}\pi(\tilde{S}_1, \tilde{x}_2)$ belong to a same conjugacy class in $\pi(S, x_0)$.*

□

3.1.5 Simplicial Homology Group. A n -simplex $\underline{s} = [a_1, a_2, \dots, a_n]$ in a Euclidean space is a set

$$\underline{s} = \left\{ \sum_{i=1}^{n+1} \lambda_i a_i \mid \lambda_i \geq 0 \text{ and } \sum_{i=1}^{n+1} \lambda_i = 1 \right\},$$

abbreviated to \underline{s} sometimes, where each a_i , $1 \leq i \leq n$ is called a *vertex* of \underline{s} and n the dimensional of \underline{s} . For two simplexes $\underline{s}_1 = [b_1, b_2, \dots, b_m]$ and $\underline{s}_2 = [a_1, a_2, \dots, a_n]$, if $\{b_1, b_2, \dots, b_m\} \subset \{a_1, a_2, \dots, a_n\}$, i.e., each vertex in \underline{s}_1 is a vertex of \underline{s}_2 , then \underline{s}_1 is called a *face* of \underline{s}_2 , denoted by $\underline{s}_1 \prec \underline{s}_2$.

Let K be a collection of simplexes. It is called a *simplicial complex* if

- (i) if $\underline{s}, \underline{t} \in K$, then $\underline{s} \cap \underline{t}$ is either empty or a common face of \underline{s} and of \underline{t} ;
- (ii) if $\underline{t} \prec \underline{s}$ and $\underline{s} \in K$, then $\underline{t} \in K$.

Usually, its *underlying space* is defined by $|K| = \bigcup_{\underline{s} \in K} \underline{s}$, i.e., the union of all the simplexes of K . See Fig.3.1.3 for examples. In other words, an underlying space is a *multi-simplex*. The maximum dimensional number of simplex in K is called the dimensional of K , denoted by $\dim K$.

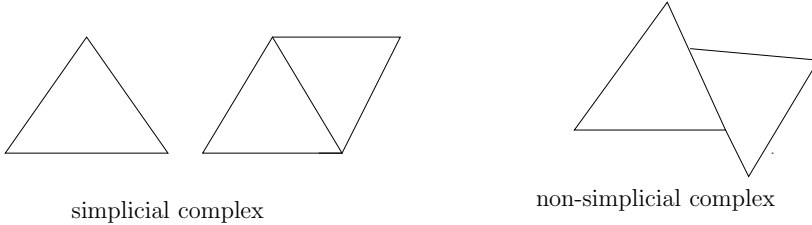

Fig.3.1.3

A topological space \mathbf{P} is a *polyhedron* if there exists a simplicial complex K and a homomorphism $h : |K| \rightarrow \mathbf{P}$. An *orientation* on a simplicial complex K is a partial order on its vertices whose restriction on the vertices of any simplex in K is a linear order. Notice that two orientations on a simplex are the same if their vertex permutations are different on an even permutation. Whence, there are only two orientations on a simplex determined by its all odd or even vertex permutations. Usually, we denote one orientation of \underline{s} by \underline{s} denoted by $\underline{s} = a_0 a_1 \cdots a_n$ if its vertices are a_0, a_1, \dots, a_n formally, and another by $-\underline{s} = -a_0 a_1 \cdots a_n$ in the context.

Definition 3.1.6 Let K be a simplicial complex with an orientation and $T_q(k)$ all q -dimensional simplexes in K , where $q > 0$, an integer. A q -dimensional chain on K is a mapping $c : T_q(K) \rightarrow \mathbf{Z}$ such that $f(-\underline{s}) = -f(\underline{s})$. The commutative group generated by all q -chains of K under the addition operation is called a q -dimensional chain group, denoted by $C_q(K)$.

If there are α_q oriented q -dimensional simplexes $\underline{s}_1, \underline{s}_2, \dots, \underline{s}_{\alpha_q}$ in K , define a standard chain $c_0 : T_q(K) \rightarrow \{1, -1\}$ by $c_0(\underline{s}_i) = 1$ and $c_0(-\underline{s}_i) = -1$ for $1 \leq i \leq \alpha_q$. These standard q -dimensional chains $c_0(\underline{s}_1), c_0(\underline{s}_2), \dots, c_0(\underline{s}_{\alpha_q})$ are also denoted by $\underline{s}_1, \underline{s}_2, \dots, \underline{s}_{\alpha_q}$ if there are no ambiguous in the context. Then a chain $c = \sum_{i=1}^{\alpha_q} c(\underline{s}_i) \underline{s}_i$ for $\forall c \in C_q(K)$ by definition.

Definition 3.1.7 A boundary homomorphism $\partial_q : C_q(K) \rightarrow C_{q-1}(K)$ on a simplex $\underline{s} = a_0 a_1, \dots, a_q$ is defined by

$$\partial_q \underline{s} = \sum_{i=0}^q (-1)^i a_0 a_1 \dots \widehat{a}_i \dots a_q,$$

where \widehat{a}_i means delete the vertex a_i and extending it to $\forall c \in C_q(K)$ by linearity, i.e., for $c = \sum_{i=1}^{\alpha_q} c(\underline{s}_i) \underline{s}_i \in C_q(K)$,

$$\partial_q(c) = \sum_{i=1}^{\alpha_q} c(\underline{s}_i) \partial_q(\underline{s}_i)$$

and $\partial_q(c) = 0$ if $q \leq 0$ or $q > \dim K$.

For example, we know that $\partial_1 a_0 a_1 = a_1 - a_0$ and $\partial_2 a_0 a_1 a_2 = a_1 a_2 - a_0 a_2 + a_0 a_1 = a_0 a_1 + a_1 a_2 + a_2 a_0$ for simplexes in Fig.3.1.4.

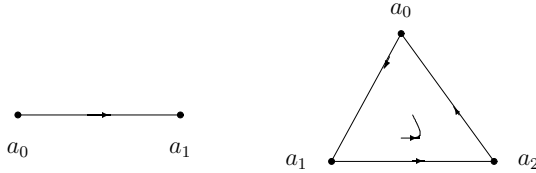

Fig. 3.1.4

These boundary homomorphisms ∂_q have an important property shown in the next result, which brings about the conception of *chain complex*.

Theorem 3.1.14 $\partial_{q-1} \partial_q = 0$ for $\forall q \in Z$.

Proof We only need to prove that $\partial_{q-1} \partial_q = 0$ for $\forall \underline{s} \in T_q(K)$ and $1 \leq q \leq \dim K$. Assume $\underline{s} = a_0 a_1 \dots a_q$. Then by definition, we know that

$$\begin{aligned} \partial_{q-1} \partial_q \underline{s} &= \partial_{q-1} \left(\sum_{i=0}^q (-1)^i a_0 a_1 \dots \widehat{a}_i \dots a_q \right) \\ &= \sum_{i=1}^q (-1)^i \partial_{q-1} (a_0 a_1 \dots \widehat{a}_i \dots a_q) \\ &= \sum_{i=1}^q (-1)^i \left(\sum_{j=1}^{i-1} (-1)^j a_0 a_1 \dots \widehat{a}_j \dots \widehat{a}_i \dots a_q \right) \end{aligned}$$

$$\begin{aligned}
& + \sum_{j=i+1}^q (-1)^{j-1} a_0 a_1 \cdots \widehat{a}_i \cdots \widehat{a}_j \cdots a_q \\
= & \sum_{0 \leq j < i \leq q} (-1)^{i+j} a_0 a_1 \cdots \widehat{a}_j \cdots \widehat{a}_i \cdots a_q \\
& - \sum_{0 \leq i < j \leq q} (-1)^{i+j} a_0 a_1 \cdots \widehat{a}_i \cdots \widehat{a}_j \cdots a_q \\
= & 0.
\end{aligned}$$

This completes the proof. \square

A *chain complex* $(\mathcal{C}; \partial)$ is a sequence of Abelian groups and homomorphisms

$$0 \rightarrow \cdots \rightarrow C_{q+1} \xrightarrow{\partial_{q+1}} C_q \xrightarrow{\partial_q} C_{q-1} \rightarrow \cdots \rightarrow 0$$

such that $\partial_q \partial_{q+1} = 0$ for $\forall q \in \mathbf{Z}$. Whence, $\text{Im} \partial_{q+1} \subset \text{Ker} \partial_q$ in a chain complex $(\mathcal{C}; \partial)$.

By Theorem 3.1.14, we know that chain groups $C_q(K)$ with homomorphisms ∂_q on a simplicial complex K is a chain complex

$$0 \rightarrow \cdots \rightarrow C_{q+1}(K) \xrightarrow{\partial_{q+1}} C_q(K) \xrightarrow{\partial_q} C_{q-1}(K) \rightarrow \cdots \rightarrow 0.$$

The simplicial homology group is defined in the next.

Definition 3.1.8 *Let K be an oriented simplicial complex with a chain complex*

$$0 \rightarrow \cdots \rightarrow C_{q+1}(K) \xrightarrow{\partial_{q+1}} C_q(K) \xrightarrow{\partial_q} C_{q-1}(K) \rightarrow \cdots \rightarrow 0.$$

Then $Z_q(K) = \text{Ker} \partial_q$, $B_q(K) = \text{Im} \partial_{q+1}$ and $H_q = Z_q(K)/B_q(K)$ are called the group of simplicial q -cycles, the group of simplicial q -boundaries and the q^{th} simplicial homology group, respectively. An element in $Z_q(K)$ or $B_q(K)$ is called q -cycles or q -boundary.

Generally, we define the q^{th} homology group $H_q = \text{Ker} \partial_q / \text{Im} \partial_{q+1}$ in a chain complex $(\mathcal{C}; \partial)$.

By definition 3.1.8, two q -dimensional chains c and c' in $C_q(K)$ are called *homologic* if they are in the same coset of $B_q(K)$, i.e., $c - c' \in B_q(K)$. Denoted by $c \sim c'$. Notice that a planar triangulation is a simplicial complex K with $\dim K = 2$. See Fig.3.1.5 for an example.

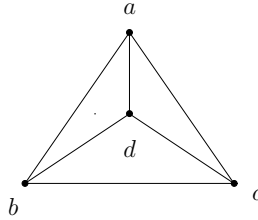

Fig.3.1.5

In this planar graph, abc, abd, acd and bcd are 2-simplexes, called surfaces. Now define their orientations to be $a \rightarrow b \rightarrow c \rightarrow a, a \rightarrow b \rightarrow d \rightarrow a, a \rightarrow c \rightarrow d \rightarrow a$ and $b \rightarrow c \rightarrow d \rightarrow b$. Then $c = abc - abd + acd - bcd$ is a 2-cycle since

$$\begin{aligned} \partial_2 c &= \partial_2(abc) - \partial_2(abd) + \partial_2(acd) - \partial_2(bcd) \\ &= bc - ac + ab - bd + ad - ab + cd - ad + ac - cd + bd - bc \\ &= 0. \end{aligned}$$

Definition 3.1.9 Let K be an oriented simplicial complex with a chain complex with α_q q -dimensional simplexes, where $q = 0, 1, \dots, \dim K$. The Euler-Poincaré characteristic $\chi(K)$ of K is defined by

$$\chi(K) = \sum_{q=0}^{\dim K} (-1)^q \alpha_q.$$

For example, the Euler -Poincaré characteristic of 2-complex in Fig.3.1.5 is

$$\chi(K) = \alpha_2 - \alpha_1 + \alpha_0 = 4 - 6 + 4 = 2.$$

Theorem 3.1.15 Let K be an oriented simplicial complex. Then

$$\chi(K) = \sum_{q=0}^{\dim K} (-1)^q \text{rank} H_q(K),$$

where $\text{rank} G$ denotes the cardinal number of a free Abelian group G .

Proof Consider the chain complex

$$0 \rightarrow \cdots \rightarrow C_{q+1}(K) \xrightarrow{\partial_{q+1}} C_q(K) \xrightarrow{\partial_q} C_{q-1}(K) \rightarrow \cdots \rightarrow 0.$$

Notice that each $C_q(K)$ is a free Abelian group of rank α_q . By definition, $H_q = Z_q(K)/B_q(K) = \text{Ker}\partial_q/\text{Im}\partial_{q+1}$. Then

$$\text{rank}H_q(K) = \text{rank}Z_q(K) - \text{rank}B_q(K).$$

In fact, each basis $\{B_1, B_2, \dots, B_{\text{rank}B_q(K)}\}$ of $B_q(K)$ can be extended to a basis $\{Z_1, Z_2, \dots, Z_{\text{rank}Z_q(K)}\}$ by adding a basis $\{H_1, H_2, \dots, H_{\text{rank}H_q(K)}\}$ of $H_q(K)$.

Applying Corollary 2.2.3, we get that $B_{q-1}(K) \cong C_q(K)/Z_q(K)$. Whence,

$$\text{rank}B_{q-1}(K) = \alpha_q - \text{rank}Z_q(K)$$

Notice that $\text{rank}B_{-1}(K) = \text{rank}B_{\dim K} = 0$ by definition, we find that

$$\begin{aligned} \chi(K) &= \sum_{q=0}^{\dim K} (-1)^q \alpha_q \\ &= \sum_{q=0}^{\dim K} (-1)^q (\text{rank}Z_q(K) + \text{rank}B_{q-1}(K)) \\ &= \sum_{q=0}^{\dim K} (-1)^q (\text{rank}Z_q(K) - \text{rank}B_q(K)) \\ &= \sum_{q=0}^{\dim K} (-1)^q \text{rank}H_q(K). \end{aligned}$$

□

3.1.6 Topological Manifold. Manifolds are generalization of Euclidean spaces. For an integer $n \geq 1$, an n -dimensional manifold is a second countable Hausdorff space such that each point has an open neighborhood homomorphic to a Euclidean space \mathbf{R}^n of dimension n , abbreviated to n -manifold.

For example, a Euclidean space \mathbf{R}^n is itself an n -manifold by definition, and the n -sphere

$$S^n = \{(x_1, x_2, \dots, x_{n+1}) \in \mathbf{R}^{n+1} | x_1^2 + x_2^2 + \cdots + x_{n+1}^2 = 1\}$$

is also an n -manifold.

Classifying n -manifolds for a given integer n is an important but more complex object in topology. However, if $n = 2$, i.e., the classification is complete(see [Mas1] for details), particularly for surfaces, i.e., 2-connected manifolds without boundary.

For classifying surfaces, T.Radó presented a combinatorial approach, he proved that *there exists a triangulation $\{\mathcal{T}_i, i \geq 1\}$ on any surface S* . T.Radó's work enables one to define a surface combinatorially, i.e., a *surface* is topological equivalent to a polygon with even number of edges by identifying each pairs of edges along a given direction on it. If label each pair of edges by a letter $e, e \in \mathcal{E}$, a surface S is also identifying with a cyclic permutation such that each edge $e, e \in \mathcal{E}$ just appears two times in S , one is e and another is e^{-1} . Let a, b, c, \dots denote the letters in \mathcal{E} and A, B, C, \dots the sections of successive letters in a linear order on a surface S (or a string of letters on S). Then, a surface can be represented as follows:

$$S = (\dots, A, a, B, a^{-1}, C, \dots),$$

where, $a \in \mathcal{E}, A, B, C$ denote a string of letters. Define three elementary transformations as follows:

- $(O_1) \quad (A, a, a^{-1}, B) \Leftrightarrow (A, B);$
- $(O_2) \quad (i) \quad (A, a, b, B, b^{-1}, a^{-1}) \Leftrightarrow (A, c, B, c^{-1});$
 $(ii) \quad (A, a, b, B, a, b) \Leftrightarrow (A, c, B, c);$
- $(O_3) \quad (i) \quad (A, a, B, C, a^{-1}, D) \Leftrightarrow (B, a, A, D, a^{-1}, C);$
 $(ii) \quad (A, a, B, C, a, D) \Leftrightarrow (B, a, A, C^{-1}, a, D^{-1}).$

If a surface S can be obtained from S_0 by these elementary transformations O_1 - O_3 , we say that S is elementary equivalent with S_0 , denoted by $S \sim_{El} S_0$. Then we can get the classification theorem surfaces.

Theorem 3.1.15 *A surface is homeomorphic to one of the following standard surfaces:*

- (P_0) the sphere: $aa^{-1};$
- (P_n) the connected sum of $n, n \geq 1$ tori:

$$a_1b_1a_1^{-1}b_1^{-1}a_2b_2a_2^{-1}b_2^{-1} \dots a_nb_na_n^{-1}b_n^{-1};$$

- (Q_n) the connected sum of $n, n \geq 1$ projective planes:

$$a_1 a_1 a_2 a_2 \cdots a_n a_n.$$

Proof By operations $O_1 - O_3$, we can prove that

$$AaBbCa^{-1}Db^{-1}E \sim_{El} ADCBEaba^{-1}b^{-1},$$

$$AcBcC \sim_{El} AB^{-1}cc,$$

$$Accaba^{-1}b^{-1} \sim_{El} Accaabb.$$

Applying the inductive method on the cardinality of \mathcal{E} , we get the conclusion. \square

Now let S be a topological space with a collection \mathcal{C} of open sets and \sim_S is an equivalence on points in S . For convenience, denote $C[u] = \{v \in S | v \sim_S u\}$ and $S / \sim_S = \{C[u] | u \in S\}$. There is a natural mapping p from S to S / \sim_S determined by $p(u) = [u]$, similar to these covering spaces.

We define a set U in S / \sim_S to be open if $p^{-1}(U) \in S$ is opened in S . With these open sets in S / \sim_S , S / \sim_S become a topological space, called the *quotient space* of S under \sim_S .

For example, the combinatorial definition of surface is just an application of the quotient space, i.e., a polygon S with even number of edges under an equivalence \sim_S on pairs of edges along a given direction. Some well-known surfaces, such as the sphere, the torus and Klein Bottle, are shown in Fig.3.1.6.

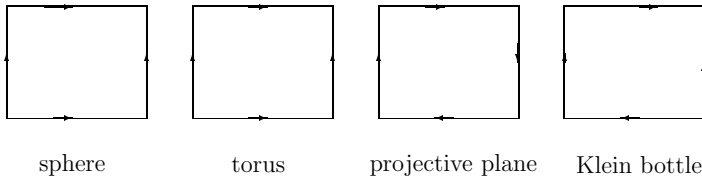

Fig.3.1.6

Theorem 3.1.16([Mas1-2],[You1]) *These fundamental and homology groups of surfaces are respective*

$$\begin{cases} \pi_1(P_0) = \langle 1 \rangle, \text{ the trivial group;} \\ \pi_1(P_n) = \langle a_1, b_1, \dots, a_n, b_n \rangle / \left\langle \prod_{i=1}^n a_i b_i a_i^{-1} b_i^{-1} \right\rangle; \\ \pi_1(Q_n) = \langle c_1, c_2, \dots, c_n \rangle / \left\langle \prod_{i=1}^n c_i c_i \right\rangle \end{cases}$$

and

$$H_q(P_n) = \begin{cases} \mathbf{Z}, & q = 0, 2; \\ \overbrace{\mathbf{Z} \oplus \mathbf{Z} \oplus \cdots \oplus \mathbf{Z}}^{2n}, & q = 1; \\ 0, & q \neq 0, 1, 2, \end{cases}$$

$$H_q(Q_n) = \begin{cases} \mathbf{Z}, & q = 0; \\ \overbrace{\mathbf{Z} \oplus \mathbf{Z} \oplus \cdots \oplus \mathbf{Z}}^{n-1} \oplus \mathbf{Z}_2, & q = 1; \\ 0, & q \neq 0, 1, \end{cases}$$

for any integer $n \geq 0$. □

§3.2 EUCLIDEAN GEOMETRY

3.2.1 Euclidean Space. An *Euclidean space* on a real vector space \mathbf{E} over a field \mathcal{F} is a mapping

$$\langle \cdot, \cdot \rangle : \mathbf{E} \times \mathbf{E} \rightarrow \mathbf{R} \text{ with } (\bar{e}_1, \bar{e}_2) \rightarrow \langle \bar{e}_1, \bar{e}_2 \rangle \text{ for } \forall \bar{e}_1, \bar{e}_2 \in \mathbf{E}$$

such that for $\bar{e}, \bar{e}_1, \bar{e}_2 \in \mathbf{E}, \alpha \in \mathcal{F}$

- (E1) $\langle \bar{e}, \bar{e}_1 + \bar{e}_2 \rangle = \langle \bar{e}, \bar{e}_1 \rangle + \langle \bar{e}, \bar{e}_2 \rangle$;
- (E2) $\langle \bar{e}, \alpha \bar{e}_1 \rangle = \alpha \langle \bar{e}, \bar{e}_1 \rangle$;
- (E3) $\langle \bar{e}_1, \bar{e}_2 \rangle = \langle \bar{e}_2, \bar{e}_1 \rangle$;
- (E4) $\langle \bar{e}, \bar{e} \rangle \geq 0$ and $\langle \bar{e}, \bar{e} \rangle = 0$ if and only if $\bar{e} = \bar{0}$.

In a Euclidean space \mathbf{E} , the number $\sqrt{\langle \bar{e}, \bar{e} \rangle}$ is called its *norm*, denoted by $\|\bar{e}\|$ for abbreviation.

It can be shown that

- (i) $\langle \bar{0}, \bar{e} \rangle = \langle \bar{e}, \bar{0} \rangle = 0$ for $\forall \bar{e} \in \mathbf{E}$;
- (ii) $\left\langle \sum_{i=1}^n x_i \bar{e}_i^1, \sum_{j=1}^m y_j \bar{e}_j^2 \right\rangle = \sum_{i=1}^n \sum_{j=1}^m x_i y_j \langle \bar{e}_i^1, \bar{e}_j^2 \rangle$, for $\bar{e}_i^s \in \mathbf{E}$, where $1 \leq i \leq \max\{m, n\}$ and $s = 1$ or 2 .

In fact, let $\bar{e}_1 = \bar{e}_2 = \bar{0}$ in (E1), we find that $\langle \bar{e}, \bar{0} \rangle = 0$. Then applying (E3), we get that $\langle \bar{0}, \bar{e} \rangle = 0$. This is the formula in (i).

For (ii), applying (E1)-(E2), we know that

$$\begin{aligned}
 \left\langle \sum_{i=1}^n x_i \bar{e}_i^1, \sum_{j=1}^m y_j \bar{e}_j^2 \right\rangle &= \sum_{j=1}^m \left\langle \sum_{i=1}^n x_i \bar{e}_i^1, y_j \bar{e}_j^2 \right\rangle \\
 &= \sum_{j=1}^m y_j \left\langle \sum_{i=1}^n x_i \bar{e}_i^1, \bar{e}_j^2 \right\rangle \\
 &= \sum_{j=1}^m y_j \left\langle \bar{e}_j^2, \sum_{i=1}^n x_i \bar{e}_i^1 \right\rangle \\
 &= \sum_{i=1}^n \sum_{j=1}^m x_i y_j \langle \bar{e}_j^2, \bar{e}_i^1 \rangle \\
 &= \sum_{i=1}^n \sum_{j=1}^m x_i y_j \langle \bar{e}_i^1, \bar{e}_j^2 \rangle.
 \end{aligned}$$

Theorem 3.2.1 Let \mathbf{E} be a Euclidean space. Then for $\forall \bar{e}_1, \bar{e}_2 \in \mathbf{E}$,

$$(i) \quad |\langle \bar{e}_1, \bar{e}_2 \rangle| \leq \|\bar{e}_1\| \|\bar{e}_2\|;$$

$$(ii) \quad \|\bar{e}_1 + \bar{e}_2\| \leq \|\bar{e}_1\| + \|\bar{e}_2\|.$$

Proof Notice that the inequality (i) is hold if \bar{e}_1 or $\bar{e}_2 = \bar{0}$. Assume $\bar{e}_1 \neq \bar{0}$. Let $x = \frac{\langle \bar{e}_1, \bar{e}_2 \rangle}{\langle \bar{e}_1, \bar{e}_1 \rangle}$. Since

$$\langle \bar{e}_2 - x\bar{e}_1, \bar{e}_2 - x\bar{e}_1 \rangle = \langle \bar{e}_2, \bar{e}_2 \rangle - 2\langle \bar{e}_1, \bar{e}_2 \rangle x + \langle \bar{e}_1, \bar{e}_1 \rangle x^2 \geq 0.$$

Replacing x by $\frac{\langle \bar{e}_1, \bar{e}_2 \rangle}{\langle \bar{e}_1, \bar{e}_1 \rangle}$ in it, we find that

$$\langle \bar{e}_1, \bar{e}_1 \rangle \langle \bar{e}_2, \bar{e}_2 \rangle - \langle \bar{e}_1, \bar{e}_2 \rangle^2 \geq 0.$$

Therefore, we get that

$$|\langle \bar{e}_1, \bar{e}_2 \rangle| \leq \|\bar{e}_1\| \|\bar{e}_2\|.$$

For the inequality (ii), applying the inequality (i), we know that

$$\begin{aligned}
 \|\langle \bar{e}_1, \bar{e}_2 \rangle\|^2 &= \langle \bar{e}_1 + \bar{e}_2, \bar{e}_1 + \bar{e}_2 \rangle \\
 &= \langle \bar{e}_1, \bar{e}_1 \rangle + 2\langle \bar{e}_1, \bar{e}_2 \rangle + \langle \bar{e}_2, \bar{e}_2 \rangle \\
 &= \langle \bar{e}_1, \bar{e}_1 \rangle + 2|\langle \bar{e}_1, \bar{e}_2 \rangle| + \langle \bar{e}_2, \bar{e}_2 \rangle
 \end{aligned}$$

$$\begin{aligned} &\leq \langle \bar{e}_1, \bar{e}_1 \rangle + 2\|\langle \bar{e}_1, \bar{e}_1 \rangle\| \|\langle \bar{e}_2, \bar{e}_1 \rangle\| + \langle \bar{e}_2, \bar{e}_2 \rangle \\ &= (\|\bar{e}_1\| + \|\bar{e}_2\|)^2. \end{aligned}$$

Whence,

$$\|\bar{e}_1 + \bar{e}_2\| \leq \|\bar{e}_1\| + \|\bar{e}_2\|.$$

□

Definition 3.2.1 Let \mathbf{E} be a Euclidean space, $\bar{a}, \bar{b} \in \mathbf{E}$, $\bar{a} \neq \bar{0}, \bar{b} \neq \bar{0}$. The angle between \bar{a} and \bar{b} are determined by

$$\cos \theta = \frac{\langle \bar{a}, \bar{b} \rangle}{\|\bar{a}\| \|\bar{b}\|}.$$

Notice that by Theorem 3.2.1(i), we always have that

$$-1 \leq \frac{\langle \bar{a}, \bar{b} \rangle}{\|\bar{a}\| \|\bar{b}\|} \leq 1.$$

Whence, the angle between \bar{a} and \bar{b} is well-defined.

Definition 3.2.2 Let \mathbf{E} be a Euclidean space, $\bar{x}, \bar{y} \in \mathbf{E}$. \bar{x} and \bar{y} are orthogonal if $\langle \bar{x}, \bar{y} \rangle = 0$. If there is a basis $\bar{e}_1, \bar{e}_2, \dots, \bar{e}_m$ of \mathbf{E} such that $\bar{e}_1, \bar{e}_2, \dots, \bar{e}_m$ are orthogonal two by two, then this basis is called an orthogonal basis. Furthermore, if $\|\bar{e}_i\| = 1$ for $1 \leq i \leq m$, an orthogonal basis $\bar{e}_1, \bar{e}_2, \dots, \bar{e}_m$ is called a normal basis.

Theorem 3.2.2 Any n -dimensional Euclidean space \mathbf{E} has an orthogonal basis.

Proof Let $\bar{a}_1, \bar{a}_2, \dots, \bar{a}_n$ be a basis of \mathbf{E} . We construct an orthogonal basis $\bar{b}_1, \bar{b}_2, \dots, \bar{b}_n$ of this space. Notice that $\langle \bar{b}_1, \bar{b}_1 \rangle \neq 0$, choose $\bar{b}_1 = \bar{a}_1$ and let

$$\bar{b}_2 = \bar{a}_2 - \frac{\langle \bar{a}_2, \bar{b}_1 \rangle}{\langle \bar{b}_1, \bar{b}_1 \rangle} \bar{b}_1.$$

Then \bar{b}_2 is a linear combination of \bar{a}_1 and \bar{a}_2 and

$$\langle \bar{b}_2, \bar{b}_1 \rangle = \langle \bar{a}_2, \bar{b}_1 \rangle - \frac{\langle \bar{a}_2, \bar{b}_1 \rangle}{\langle \bar{b}_1, \bar{b}_1 \rangle} \langle \bar{b}_1, \bar{b}_1 \rangle = 0,$$

i.e., \bar{b}_2 is orthogonal with \bar{b}_1 .

Assume we have constructed $\bar{b}_1, \bar{b}_2, \dots, \bar{b}_k$ for an integer $1 \leq k \leq n-1$, and each of which is a linear combination of $\bar{a}_1, \bar{a}_2, \dots, \bar{a}_i$, $1 \leq i \leq k$. Notice that $\langle \bar{b}_1, \bar{b}_1 \rangle, \langle \bar{b}_2, \bar{b}_2 \rangle, \dots, \langle \bar{b}_{k-1}, \bar{b}_{k-1} \rangle \neq 0$. Let

$$\bar{b}_k = \bar{a}_k - \frac{\langle \bar{a}_k, \bar{b}_1 \rangle}{\langle \bar{b}_1, \bar{b}_1 \rangle} \bar{b}_1 - \frac{\langle \bar{a}_k, \bar{b}_2 \rangle}{\langle \bar{b}_2, \bar{b}_2 \rangle} \bar{b}_2 - \dots - \frac{\langle \bar{a}_k, \bar{b}_{k-1} \rangle}{\langle \bar{b}_{k-1}, \bar{b}_{k-1} \rangle} \bar{b}_{k-1}.$$

Then \bar{b}_k is a linear combination of $\bar{a}_1, \bar{a}_2, \dots, \bar{a}_{k-1}$ and

$$\begin{aligned} \langle \bar{b}_k, \bar{b}_i \rangle &= \langle \bar{a}_k, \bar{b}_i \rangle - \frac{\langle \bar{a}_k, \bar{b}_1 \rangle}{\langle \bar{b}_1, \bar{b}_1 \rangle} \langle \bar{b}_1, \bar{b}_i \rangle - \dots - \frac{\langle \bar{a}_k, \bar{b}_{k-1} \rangle}{\langle \bar{b}_{k-1}, \bar{b}_{k-1} \rangle} \langle \bar{b}_{k-1}, \bar{b}_i \rangle \\ &= \langle \bar{a}_k, \bar{b}_i \rangle - \frac{\langle \bar{a}_k, \bar{b}_i \rangle}{\langle \bar{b}_i, \bar{b}_i \rangle} \langle \bar{b}_i, \bar{b}_i \rangle = 0 \end{aligned}$$

for $i = 1, 2, \dots, k-1$. Apply the induction principle, this proof is completes. \square

Corollary 3.2.1 Any n -dimensional Euclidean space \mathbf{E} has a normal basis.

Proof According to Theorem 3.2.2, any n -dimensional Euclidean space \mathbf{E} has an orthogonal basis $\bar{a}_1, \bar{a}_2, \dots, \bar{a}_m$. Now let $\bar{e}_1 = \frac{\bar{a}_1}{\|\bar{a}_1\|}$, $\bar{e}_2 = \frac{\bar{a}_2}{\|\bar{a}_2\|}$, \dots , $\bar{e}_m = \frac{\bar{a}_m}{\|\bar{a}_m\|}$. Then we find that

$$\langle \bar{e}_i, \bar{e}_j \rangle = \frac{\langle \bar{a}_i, \bar{a}_j \rangle}{\|\bar{a}_i\| \|\bar{a}_j\|} = 0$$

and

$$\|\bar{e}_i\| = \left\| \frac{\bar{a}_i}{\|\bar{a}_i\|} \right\| = \frac{\|\bar{a}_i\|}{\|\bar{a}_i\|} = 1$$

for $1 \leq i, j \leq m$ by definition. Whence, $\bar{e}_1, \bar{e}_2, \dots, \bar{e}_m$ is a normal basis. \square

Definition 3.2.3 Two Euclidean spaces \mathbf{E}_1 , \mathbf{E}_2 respectively over fields $\mathcal{F}_1, \mathcal{F}_2$ are isomorphic if there is a 1-1 mapping $h: \mathbf{E}_1 \rightarrow \mathbf{E}_2$ such that for $\forall \bar{e}_1, \bar{e}_2 \in \mathbf{E}_1$ and $\alpha \in \mathcal{F}_1$,

- (i) $h(\bar{e}_1 + \bar{e}_2) = h(\bar{e}_1) + h(\bar{e}_2)$;
- (ii) $h(\alpha \bar{e}) = \alpha h(\bar{e})$;
- (iii) $\langle \bar{e}_1, \bar{e}_2 \rangle = \langle h(\bar{e}_1), h(\bar{e}_2) \rangle$.

Theorem 3.2.3 *Two finite dimensional Euclidean spaces \mathbf{E}_1 , \mathbf{E}_2 are isomorphic if and only if $\dim \mathbf{E}_1 = \dim \mathbf{E}_2$.*

Proof By Definition 3.2.3, we get $\dim \mathbf{E}_1 = \dim \mathbf{E}_2$ if \mathbf{E}_1 , \mathbf{E}_2 are isomorphic.

Now if $\dim \mathbf{E}_1 = \dim \mathbf{E}_2$, we prove that they are isomorphic. Assume $\dim \mathbf{E}_1 = \dim \mathbf{E}_2 = n$. Applying Corollary 3.2.1, choose normal bases $\bar{a}_1, \bar{a}_2, \dots, \bar{a}_n$ of \mathbf{E}_1 and $\bar{b}_1, \bar{b}_2, \dots, \bar{b}_n$ of \mathbf{E}_2 , respectively. Define a 1 – 1 mapping $h : \mathbf{E}_1 \rightarrow \mathbf{E}_2$ by $h(\bar{a}_i) = \bar{b}_i$ for $1 \leq i \leq n$ and extend it linearity on \mathbf{E}_1 , we know that

$$h\left(\sum_{i=1}^n x_i \bar{a}_i\right) = \sum_{i=1}^n x_i h(\bar{a}_i).$$

Let $\sum_{i=1}^n x_i \bar{a}_i$ and $\sum_{i=1}^n y_i \bar{a}_i$ be two elements in \mathbf{E}_1 . Then we find that

$$\left\langle \sum_{i=1}^n x_i \bar{a}_i, \sum_{i=1}^n y_i \bar{a}_i \right\rangle = \sum_{i=1}^n x_i y_i$$

and

$$\left\langle h\left(\sum_{i=1}^n x_i \bar{a}_i\right), h\left(\sum_{i=1}^n y_i \bar{a}_i\right) \right\rangle = \sum_{i=1}^n x_i y_i.$$

Therefore, we get that

$$\left\langle \sum_{i=1}^n x_i \bar{a}_i, \sum_{i=1}^n y_i \bar{a}_i \right\rangle = \left\langle h\left(\sum_{i=1}^n x_i \bar{a}_i\right), h\left(\sum_{i=1}^n y_i \bar{a}_i\right) \right\rangle.$$

□

Notice that \mathbf{R}^n is an n -dimensional space with a normal basis $\bar{\epsilon}_1 = (1, 0, \dots, 0)$, $\bar{\epsilon}_2 = (0, 1, \dots, 0)$, \dots , $\bar{\epsilon}_n = (0, 0, \dots, 1)$ if define

$$\langle (x_1, x_2, \dots, x_n), (y_1, y_2, \dots, y_n) \rangle = \sum_{i=1}^n x_i y_i.$$

for $(x_1, x_2, \dots, x_n), (y_1, y_2, \dots, y_n) \in \mathbf{R}^n$. Consequently, we know the next result.

Corollary 3.2.2 *Any n -dimensional Euclidean space \mathbf{E} is isomorphic to \mathbf{R}^n .*

3.2.2 Linear Mapping. For two vector space $\mathbf{E}_1, \mathbf{E}_2$ over fields $\mathcal{F}_1, \mathcal{F}_2$, respectively, a mapping $T : \mathbf{E}_1 \rightarrow \mathbf{E}_2$ is *linear* if

$$T(\alpha\bar{a} + \bar{b}) = \alpha T(\bar{a}) + T(\bar{b})$$

for $\forall \bar{a}, \bar{b} \in \mathbf{E}_1$ and $\forall \alpha \in \mathcal{F}_1$.

If $\mathcal{F}_1 = \mathcal{F}_2 = \mathbf{R}$, all such linear mappings T from \mathbf{E}_1 to \mathbf{E}_2 forms a linear space over \mathbf{R} , denoted by $L(\mathbf{E}_1, \mathbf{E}_2)$. It is obvious that $L(\mathbf{E}_1, \mathbf{E}_2) \subset \mathbf{E}_2^{\mathbf{E}_1}$.

Theorem 3.2.4 If $\dim \mathbf{E}_1 = n$, $\dim \mathbf{E}_2 = m$, then $\dim L(\mathbf{E}_1, \mathbf{E}_2) = nm$.

Proof Let $\bar{e}_1^1, \bar{e}_2^1, \dots, \bar{e}_n^1$ and $\bar{e}_1^2, \bar{e}_2^2, \dots, \bar{e}_m^2$ be basis of \mathbf{E}_1 and \mathbf{E}_2 , respectively. For each pair (i, j) , $1 \leq i \leq n$, $1 \leq j \leq m$, define an element $\bar{l}_{ij} \in L(\mathbf{E}_1, \mathbf{E}_2)$ with

$$\bar{l}_{ij}(\bar{e}_i^1) = \bar{e}_j^2 \text{ and } \bar{l}_{ij}(\bar{e}_k^1) = \bar{0} \text{ if } k \neq i.$$

Then for $\bar{x} = \sum_{i=1}^n x_i \bar{e}_i^1 \in \mathbf{E}_1$, we have $\bar{l}_{ij}(\bar{x}) = x_i \bar{e}_j^2$. We prove that \bar{l}_{ij} , $1 \leq i \leq n$, $1 \leq j \leq m$ consists of a basis of $L(\mathbf{E}_1, \mathbf{E}_2)$.

In fact, if there are numbers $x_{ij} \in \mathbf{R}$, $1 \leq i \leq n$, $1 \leq j \leq m$ such that

$$\sum_{i=1}^n \sum_{j=1}^m x_{ij} \bar{l}_{ij} = \bar{0},$$

then

$$\sum_{i=1}^n \sum_{j=1}^m x_{ij} \bar{l}_{ij}(\bar{e}_i^1) = \bar{0}(\bar{e}_i^1) = \bar{0}$$

for \bar{e}_i^1 , $1 \leq i \leq n$. Whence, we find that

$$\sum_{j=1}^m x_{ij} \bar{e}_j^2 = \bar{0}.$$

Since $\bar{e}_1^2, \bar{e}_2^2, \dots, \bar{e}_m^2$ are linearly independent, we get $x_{ij} = 0$ for $1 \leq j \leq m$. Therefore, \bar{l}_{ij} , $1 \leq i \leq n$, $1 \leq j \leq m$ are linearly independent.

Now let $f \in L(\mathbf{E}_1, \mathbf{E}_2)$. If

$$f(\bar{e}_i^1) = \sum_{j=1}^m \mu_{ij} \bar{e}_j^2,$$

Then

$$f(\bar{e}_k^1) = \sum_{j=1}^m \mu_{kj} \bar{e}_j^2 = \sum_{i=1}^n \sum_{j=1}^m \mu_{ij} \bar{l}_{ij}(\bar{e}_k^1).$$

By the linearity of f , we get that

$$f = \sum_{j=1}^m \mu_{kj} \bar{e}_j^2 = \sum_{i=1}^n \sum_{j=1}^m \mu_{ij} \bar{l}_{ij},$$

i.e., f is linearly spanned by \bar{l}_{ij} , $1 \leq i \leq n$, $1 \leq j \leq m$.

Consequently, $\dim L(\mathbf{E}_1, \mathbf{E}_2) = nm$. □

In $L(\mathbf{E}, \mathbf{E}_1)$, if $\mathbf{E}_1 = \mathbf{R}$, the linear space $L(\mathbf{E}, \mathbf{R})$ consists of linear functionals $f : \mathbf{E} \rightarrow \mathbf{R}$, is called the *dual space* of \mathbf{E} , denoted by \mathbf{E}^* . According to Theorem 3.2.4, we get the next consequence.

Corollary 3.2.3 $\dim \mathbf{E}^* = \dim \mathbf{E}$.

Now let $\mathbf{E}_1, \mathbf{E}_2, \dots, \mathbf{E}_k$ and \mathbf{F} be linear spaces over fields $\mathcal{F}_1, \mathcal{F}_2, \dots, \mathcal{F}_k$ and \mathcal{F} , respectively, a mapping

$$\tilde{T} : \mathbf{E}_1 \times \mathbf{E}_2 \times \dots \times \mathbf{E}_k \rightarrow \mathbf{F}$$

is called *k-multilinear* if \tilde{T} is linear in each argument separately, i.e.,

$$\tilde{T}(\bar{e}_1, \dots, \alpha \bar{e}_i + \beta \bar{f}_i, \dots, \bar{e}_k) = \alpha \tilde{T}(\bar{e}_1, \dots, \bar{e}_i, \dots, \bar{e}_k) + \beta \tilde{T}(\bar{e}_1, \dots, \bar{f}_i, \dots, \bar{e}_k)$$

for $\alpha, \beta \in \mathcal{F}_i$, $1 \leq i \leq k$. All such multilinear mappings also form a vector space, denoted by $L(\mathbf{E}_1, \mathbf{E}_2, \dots, \mathbf{E}_k; \mathbf{F})$. Particularly, if $\mathbf{E}_i = \mathbf{E}$ for $1 \leq i \leq k$, this space is denoted by $L^k(\mathbf{E}, \mathbf{F})$.

Let \mathbf{E} and \mathbf{F} be vector spaces over \mathbf{R} . For any integers $p, q > 0$, the space of multilinear mappings

$$\tilde{T} : \underbrace{\mathbf{E}^* \times \dots \times \mathbf{E}^*}_p \times \underbrace{\mathbf{E} \times \dots \times \mathbf{E}}_q \rightarrow \mathbf{F}$$

is called a *\mathbf{F} -valued tensor*. All such tensors are denoted by $T^{p,q}(\mathbf{E}, \mathbf{F})$. For the case $\mathbf{F} = \mathbf{R}$, we denote the $T^{p,q}(\mathbf{E}, \mathbf{R})$ by $T^{p,q}(\mathbf{E})$.

If $\bar{u}_1, \bar{u}_2, \dots, \bar{u}_p \in \mathbf{E}$ and $\bar{v}_1^*, \bar{v}_2^*, \dots, \bar{v}_q^* \in \mathbf{E}^*$, then $\bar{u}_1 \otimes \dots \otimes \bar{u}_p \otimes \bar{v}_1^* \otimes \dots \otimes \bar{v}_q^* \in T^{p,q}(\mathbf{E})$ is defined by

$$\bar{u}_1 \otimes \cdots \otimes \bar{u}_p \otimes \bar{v}_1^* \otimes \cdots \otimes \bar{v}_q^*(\bar{x}_1^*, \cdots, \bar{x}_p^*, y_1, \cdots, y_q) = \bar{x}_1^*(\bar{u}_1) \cdots \bar{x}_p^*(\bar{u}_p) \bar{v}_1^*(\bar{y}_1) \cdots \bar{v}_q^*(\bar{y}_q).$$

Let $\bar{e}_1, \cdots, \bar{e}_n$ be a basis of \mathbf{E} and $\bar{e}_1^*, \cdots, \bar{e}_n^*$ of its dual \mathbf{E}^* . Then similar to Theorem 3.2.4, we know that any $\tilde{T} \in T^{p,q}(\mathbf{E})$ can be uniquely written as

$$\tilde{T} = \sum_{i_1, \dots, i_p, j_1, \dots, j_q} T_{j_1, \dots, j_q}^{i_1, \dots, i_p} \bar{e}_{i_1} \otimes \cdots \otimes \bar{e}_{i_p} \otimes \bar{e}_{j_1}^* \otimes \cdots \otimes \bar{e}_{j_q}^*$$

for components $T_{j_1, \dots, j_q}^{i_1, \dots, i_p} \in \mathbf{R}$.

3.2.3 Differential Calculus on \mathbf{R}^n . Let $\mathbf{R}^n, \mathbf{R}^m$ be Euclidean spaces. For an opened set $U \subset \mathbf{R}^n$, let $f : U \rightarrow \mathbf{R}^m$ be a mapping from U into \mathbf{R}^m , i.e.,

$$f(x_1, x_2, \cdots, x_n) = (f^1(x_1, x_2, \cdots, x_n), f^2(x_1, x_2, \cdots, x_n), \cdots, f^m(x_1, x_2, \cdots, x_n)),$$

also written it by $f = (f^1, f^2, \cdots, f^m)$ for abbreviation. Then f is said to be *differentiable* at a point $\bar{x} \in U$ if there exists a linear mapping $A \in L(\mathbf{R}^n, \mathbf{R}^m)$ such that

$$f(\bar{x} + \bar{h}) = f(\bar{x}) + A\bar{h} + r(\bar{h})$$

with $r : U \rightarrow \mathbf{R}^m$,

$$\lim_{\bar{h} \rightarrow \bar{0}} \frac{r(\bar{h})}{\|\bar{h}\|} = 0$$

for all $\bar{h} \in \mathbf{R}^n$ with $\bar{x} + \bar{h} \in U$ hold. This linear mapping A is called the *differential* of f at $\bar{x} \in U$, denoted by

$$A = f'(\bar{x}) = df(\bar{x}).$$

Furthermore, if f is differentiable at each $\bar{x} \in U$, the mapping $df = f' : U \rightarrow L(\mathbf{R}^n, \mathbf{R}^m)$ determined by $\bar{x} \rightarrow df(\bar{x})$ is called the *derivative* of f in U .

For integers $n, m \geq 1$, it is easily to know that a linear mapping $T : \mathbf{R}^n \rightarrow \mathbf{R}^m$ is differentiable at any point $\bar{x} \in \mathbf{R}^n$ and if $f, g : U \rightarrow \mathbf{R}^m$ are differentiable at $\bar{x} \in U \subset \mathbf{R}^n$, then

$$d(f + g)(\bar{x}) = df(\bar{x}) + dg(\bar{x});$$

$$d(fg)(\bar{x}) = f(\bar{x})dg(\bar{x}) + g(\bar{x})df(\bar{x});$$

$$d(\lambda\bar{x}) = \lambda df(\bar{x}),$$

where $\lambda \in \mathbf{R}$.

A map $f : U \subset \mathbf{R}^n \rightarrow \mathbf{R}^m$ is said to have n partial derivatives

$$D_{\bar{\epsilon}_i} f(\bar{x}) = \lim_{t \rightarrow 0} \frac{f(\bar{x} + t\bar{\epsilon}_i) - f(\bar{x})}{t} = \left. \frac{df(\bar{x} + t\bar{\epsilon}_i)}{dt} \right|_{t=0}, \quad 1 \leq i \leq n,$$

at $\bar{x} \in U$, if all these n mappings $g_i(t) = f(\bar{x} + t\bar{\epsilon}_i)$ are differentiable at $t = 0$. We usually denote the $D_{\bar{\epsilon}_i} f(\bar{x})$ by $\frac{\partial f}{\partial x_i}(\bar{x})$.

Theorem 3.2.5 *Let $f : U \subset \mathbf{R}^n \rightarrow \mathbf{R}^m$ be a differentiable mapping. The matrix of the differential $df(\bar{x})$ with respect to the normal bases of \mathbf{R}^n and \mathbf{R}^m is given by*

$$(A_i^j) = \begin{pmatrix} \frac{\partial f^1}{\partial x_1}(\bar{x}) & \cdots & \frac{\partial f^1}{\partial x_n}(\bar{x}) \\ \vdots & & \vdots \\ \frac{\partial f^m}{\partial x_1}(\bar{x}) & \cdots & \frac{\partial f^m}{\partial x_n}(\bar{x}) \end{pmatrix} = \left(\frac{\partial f^j}{\partial x_i}(\bar{x}) \right), \quad 1 \leq i \leq n, \quad 1 \leq j \leq m,$$

which is referred to as the Jacobian matrix and its determinant $\det\left(\frac{\partial f^j}{\partial x_i}(\bar{x})\right)$ the Jacobian of f at the point $\bar{x} \in U$, usually denoted by

$$\frac{\partial(f^1, \dots, f^m)}{\partial(x_1, \dots, x_n)} = \det\left(\frac{\partial f^j}{\partial x_i}(\bar{x})\right).$$

Proof Let $\bar{x} = (x_1, \dots, x_n) \in U \subset \mathbf{R}^n$, $\bar{x} + \bar{h} = (x_1 + h_1, \dots, x_n + h_n) \in U$. Then for such \bar{h} ,

$$f^j(x_1 + h_1, \dots, x_n + h_n) - f^j(x_1, \dots, x_n) = \sum_{i=1}^n A_i^j h_i + r^j(h_1, \dots, h_n).$$

Particularly, the choice $\bar{h} = (0, \dots, 0, h_i, 0, \dots, 0)$ enables us to obtain

$$\frac{f^j(x_1, \dots, x_{i-1}, x_i + h_i, x_{i+1}, \dots, x_n) - f^j(x_1, \dots, x_n)}{h_i}$$

$$= A_i^j + r^j(0, \dots, h_i, \dots, 0),$$

which yields that

$$\frac{\partial f^j}{\partial x_i}(x_1, \dots, x_n) = A_i^j$$

for $h_i \rightarrow 0$. □

Corollary 3.2.4 *Let $f : U \subset \mathbf{R}^n \rightarrow V \subset \mathbf{R}^m$ and $g : V \rightarrow \mathbf{R}^p$ be differentiable mappings. Then the composite mapping $h = g \circ f : U \rightarrow \mathbf{R}^p$ is also differentiable with its differential, the chain rule.*

$$dg(\bar{x}) = dg(f(\bar{x}))df(\bar{x}).$$

Proof Not loss of generality, let $f = (f^1, \dots, f^m)$ and $g = (g^1, \dots, g^p)$ be differentiable at $\bar{x} \in U$, $\bar{y} = f(\bar{x})$ and $h = (h^1, \dots, h^p)$, respectively. Applying the chain rule on $h^k = g^k(f^1, \dots, f^m)$, $1 \leq k \leq p$ in one variable, we find that

$$\frac{\partial h^k}{\partial x_i} = \sum_{j=1}^m \frac{\partial g^k}{\partial y_j} \frac{\partial f^j}{\partial x_i}.$$

Choose the normal bases of \mathbf{R}^n , \mathbf{R}^m and \mathbf{R}^p . Then by Theorem 3.2.5, we know that

$$\begin{aligned} dh(\bar{x}) &= \begin{pmatrix} \frac{\partial h^1}{\partial x_1}(\bar{x}) & \cdots & \frac{\partial h^1}{\partial x_n}(\bar{x}) \\ \vdots & & \vdots \\ \frac{\partial h^p}{\partial x_1}(\bar{x}) & \cdots & \frac{\partial h^p}{\partial x_n}(\bar{x}) \end{pmatrix} \\ &= \begin{pmatrix} \frac{\partial g^1}{\partial y_1}(\bar{y}) & \cdots & \frac{\partial g^1}{\partial y_m}(\bar{y}) \\ \vdots & & \vdots \\ \frac{\partial g^p}{\partial y_1}(\bar{y}) & \cdots & \frac{\partial g^p}{\partial y_m}(\bar{y}) \end{pmatrix} \times \begin{pmatrix} \frac{\partial f^1}{\partial x_1}(\bar{x}) & \cdots & \frac{\partial f^1}{\partial x_n}(\bar{x}) \\ \vdots & & \vdots \\ \frac{\partial f^m}{\partial x_1}(\bar{x}) & \cdots & \frac{\partial f^m}{\partial x_n}(\bar{x}) \end{pmatrix} \\ &= dg(f(\bar{x}))df(\bar{x}) \end{aligned}$$

□

For an integer $k \geq 1$, a mapping $f : U \subset \mathbf{R}^n \rightarrow \mathbf{R}^m$ is said to be *differentiable of order k* if

$$d^k f = d(d^{k-1}f) : U \subset \mathbf{R}^n \rightarrow L_k(\mathbf{R}^n, \mathbf{R}^m) = L(\mathbf{R}^n, L(\mathbf{R}^n, \dots, L(\mathbf{R}^n, \mathbf{R}^m)));$$

$$d^0 f = f$$

exists. If $d^k f$ is continuous, f is said to be of class C^k and class C^∞ if it is of class C^k for any integer k .

A bijective mapping $f : U \rightarrow V$, where $U, V \subset \mathbf{R}^n$, is a C^k -diffeomorphism if $f \in C^k(U, \mathbf{R}^n)$ and $f^{-1} \in C^k(V, \mathbf{R}^n)$. Certainly, a C^k -diffeomorphism mapping is also a homeomorphism.

For determining a C^k -diffeomorphism mapping, the following *implicit function theorem* is usually applicable. Its proof can be found in, for example [AbM1].

Theorem 3.2.6 *Let U be an open subset of $\mathbf{R}^n \times \mathbf{R}^m$ and $f : U \rightarrow \mathbf{R}^m$ a mapping of class $C^k, 1 \leq k \leq \infty$. If $f(\bar{x}_0, \bar{y}_0) = \bar{0}$ at the point $(\bar{x}_0, \bar{y}_0) \in U$ and the $m \times m$ matrix $\partial f^j / \partial y^i(\bar{x}_0, \bar{y}_0)$ is non-singular, i.e.,*

$$\det\left(\frac{\partial f^j}{\partial y^i}(\bar{x}_0, \bar{y}_0)\right) \neq 0, \quad \text{where } 1 \leq i, j \leq m.$$

Then there exist opened neighborhoods V of \bar{x}_0 in \mathbf{R}^n and W of \bar{y}_0 in \mathbf{R}^m and a C^k mapping $g : V \rightarrow W$ such that $V \times W \subset U$ and for each $(\bar{x}, \bar{y}) \in V \times W$,

$$f(\bar{x}, \bar{y}) = \bar{0} \Rightarrow \bar{y} = g(\bar{x}).$$

3.2.4 Differential Form. Let \mathbf{R}^n be an Euclidean space with a normal basis $\bar{e}_1, \bar{e}_2, \dots, \bar{e}_n$. Then $\forall \bar{x} \in \mathbf{R}^n$, there is a unique n -tuple $(x_1, x_2, \dots, x_n), x_i \in \mathbf{R}$, such that

$$\bar{x} = x_1 \bar{e}_1 + x_2 \bar{e}_2 + \dots + x_n \bar{e}_n.$$

For needing in research tangent spaces of differential manifolds in the following chapters, we consider a vector space

$$G(\Lambda) = \Lambda^0 \oplus \Lambda^1 \oplus \Lambda^2 \oplus \dots \oplus \Lambda^n$$

generated by differentials dx_1, dx_2, \dots, dx_n under an operation \wedge . Each element in Λ^0 is a real number, and elements in Λ^1 have a form

$$\sum_{i=1}^n a_i(x_1, x_2, \dots, x_n) dx_i,$$

where $a_i(x_1, x_2, \dots, x_n)$ is a function on \mathbf{R}^n . In the space Λ^2 , elements have a form

$$\sum_{i_1 < i_2} a_{i_1 i_2}(x_1, x_2, \dots, x_n) dx_{i_1} \wedge dx_{i_2}.$$

Notice that $dx_{i_1} \wedge dx_{i_2} = -dx_{i_2} \wedge dx_{i_1}$ by the definition of \wedge . Generally, elements in Λ^k , $1 \leq k \leq n$, have a form

$$\sum_{i_1 < i_2 < \dots < i_k} a_{i_1 i_2 \dots i_k}(x_1, x_2, \dots, x_n) dx_{i_1} \wedge dx_{i_2} \wedge \dots \wedge dx_{i_k}.$$

A *differential k -form* is an element in Λ^k for $1 \leq k \leq n$. It is said in class of C^∞ if each function $a_{i_1 i_2 \dots i_k}(x_1, x_2, \dots, x_n)$ is of class C^∞ . By definition, an element in $G(\Lambda)$ can be represented as

$$\begin{aligned} & a(x_1, x_2, \dots, x_n) + \sum_{i=1}^n a_i(x_1, x_2, \dots, x_n) dx_i \\ & + \sum_{i_1 < i_2}^n a_{i_1 i_2}(x_1, x_2, \dots, x_n) dx_{i_1} \wedge dx_{i_2} + \dots \\ & + \sum_{i_1 < i_2 < \dots < i_k}^n a_{i_1 i_2 \dots i_k}(x_1, x_2, \dots, x_n) dx_{i_1} \wedge dx_{i_2} \wedge \dots \wedge dx_{i_k} + \dots \\ & + a_{1,2,\dots,n}(x_1, x_2, \dots, x_n) dx_1 \wedge dx_2 \wedge \dots \wedge dx_n. \end{aligned}$$

An *exterior differential operator* $d: \Lambda^k \rightarrow \Lambda^{k+1}$ is defined by

$$d\omega = \sum_{i_1 < i_2 < \dots < i_k} \sum_{i=1}^n \left(\frac{\partial a_{i_1 i_2 \dots i_k}}{\partial x_i} dx_i \right) \wedge dx_{i_1} \wedge \dots \wedge dx_{i_k}$$

for a differential k -form

$$\omega = \sum_{i_1 < i_2 < \dots < i_k} a_{i_1 i_2 \dots i_k}(x_1, x_2, \dots, x_n) dx_{i_1} \wedge dx_{i_2} \wedge \dots \wedge dx_{i_k} \in \Lambda^k.$$

A differential form ω is called to be *closed* if $d\omega = 0$ and *exact* if there exists a differential form ϖ such that $d\varpi = \omega$. We know that each exact differential form is closed in the next result.

Theorem 3.2.7 $dd\omega = 0$.

Proof Since d is a linear mapping, we only need to prove this claim on a monomial. Let $\omega = a(x_1, x_2, \dots, x_n) dx_{i_1} \wedge \dots \wedge dx_{i_k}$. Then

$$d\omega = \sum_{i=1}^n \frac{\partial a}{\partial x_i} dx_i \wedge dx_{i_1} \wedge \dots \wedge dx_{i_k}.$$

Therefore, we get that

$$\begin{aligned}
 dd\omega &= \sum_{i=1}^n d\left(\frac{\partial a}{\partial x_i}\right) dx_i \wedge dx_{i_1} \wedge \cdots \wedge dx_{i_k} \\
 &= \sum_{i,j=1}^n \frac{\partial^2 a}{\partial x_i \partial x_j} dx_j \wedge dx_i \wedge dx_{i_1} \wedge \cdots \wedge dx_{i_k} \\
 &= \sum_{i < j}^n \frac{\partial^2 a}{\partial x_i \partial x_j} (dx_i \wedge dx_j + dx_j \wedge dx_i) \wedge dx_{i_1} \wedge \cdots \wedge dx_{i_k} \\
 &= 0
 \end{aligned}$$

□

3.2.5 Stokes' Theorem on Simplicial Complex. A standard p -simplex \underline{s}_p in \mathbf{R}^p is defined by

$$\underline{s}_p = \{(x_1, \dots, x_p) \in \mathbf{R}^p \mid \sum_{i=1}^p x_i \leq 1, 0 \leq x_i \leq 1 \text{ for } 0 \leq i \leq p\}.$$

Now let $\omega \in \Lambda^p$ be a differential p -form with

$$\omega = \sum_{i_1 < i_2 < \cdots < i_p} a_{i_1 i_2 \dots i_p}(x_1, x_2, \dots, x_n) dx_{i_1} \wedge dx_{i_2} \wedge \cdots \wedge dx_{i_p}.$$

Its integral on \underline{s}_p is defined by

$$\int_{\underline{s}_p} \omega = \sum_{i_1 < i_2 < \cdots < i_p} \underbrace{\int \cdots \int}_p a_{i_1 i_2 \dots i_p}(x_1, x_2, \dots, x_n) dx_{i_1} dx_{i_2} \cdots dx_{i_p},$$

where the summands of the right hand expression are ordinary multiple integrals, and for a chain $c_p = \sum_{i \geq 1} \lambda_i \underline{s}_p^i \in C_p(\mathbf{R}^p)$, the integral of ω on c_p is determined by

$$\int_{c_p} \omega = \sum_{i \geq 1} \lambda_i \int_{\underline{s}_p^i} \omega.$$

Theorem 3.2.8 For any p -chain $c_p \in C_p(\mathbf{R}^p)$, $p \geq 1$ and a differentiable $(p-1)$ -form ω ,

$$\int_{\partial c_p} \omega = \int_{c_p} d\omega.$$

Proof By definition, it suffices to check that

$$\int_{\partial \underline{s}_p} \omega = \int_{\underline{s}_p} d\omega$$

in the case of ω being a monomial, i.e.,

$$\omega = a(\bar{x})dx_1 \wedge \cdots \wedge d\hat{x}_j \wedge \cdots \wedge dx_p$$

with a fixed j , $1 \leq j \leq p$ on a p -simplex $\underline{s}_p = a_0 a_1 \cdots a_p$. Then we find that

$$\begin{aligned} \int_{\underline{s}_p} d\omega &= \int_{\underline{s}_p} \left(\sum_{i=1}^p \frac{\partial a}{\partial x_i} dx_i \right) \wedge dx_1 \wedge \cdots \wedge d\hat{x}_j \wedge \cdots \wedge dx_p \\ &= (-1)^{j-1} \int_{\underline{s}_p} \frac{\partial a}{\partial x_i} dx_1 \wedge \cdots \wedge dx_p \\ &= (-1)^{j-1} \int_{\underline{a}_{p-1}^{(j)}} [a(B) - a(A)] dx_1 \cdots d\hat{x}_j \cdots dx_p, \end{aligned}$$

where $\underline{a}_{p-1}^{(j)}$ is a $(p - 1)$ -simplex determined by $\underline{a}_{p-1}^{(j)}(x_1, \dots, \hat{x}_j, \dots, x_p)$, $a(A) = a(x_1, \dots, x_{j-1}, 0, \dots, x_p)$ and $a(B) = a(x_1, \dots, x_{j-1}, 1 - (x_1 + \cdots + \hat{x}_j + \cdots + x_p), \dots, x_p)$, see Fig.3.2.1 for details.

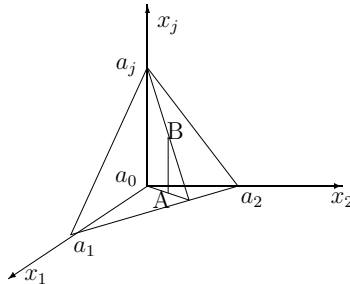

Fig.3.2.1

Thus

$$\begin{aligned} \int_{\underline{\mathbb{R}}^p} d\omega &= (-1)^j \int_{\underline{a}_{p-1}^{(j)}} a(A) dx_1 \cdots d\widehat{x}_j \cdots dx_p + (-1)^{j-1} \int_{\underline{a}_{p-1}^{(j)}} a(B) dx_1 \cdots d\widehat{x}_j \cdots dx_p \\ &= (-1)^j \int_{\underline{a}_{p-1}^{(j)}} \omega + (-1)^{j-1} \int_{\underline{a}_{p-1}^{(j)}} a(B) dx_1 \cdots d\widehat{x}_j \cdots dx_p. \end{aligned}$$

Let τ be a mapping $\tau : a_0 \rightarrow a_j$ and $a_i \rightarrow a_i$ if $i \neq j$, which defines a mapping on coordinates $(x_1, x_2, \dots, x_p) \rightarrow (x_j, x_1, \dots, \widehat{x}_j, \dots, x_p)$. Whence,

$$\begin{aligned} \int_{\underline{a}_{p-1}^{(0)}} \omega &= \int_{\underline{a}_{p-1}^{(j)}} a(B) \frac{\partial(x_1, x_2, \dots, x_p)}{\partial(x_j, x_1, \dots, \widehat{x}_j, \dots, x_p)} dx_1 \cdots d\widehat{x}_j \cdots dx_p \\ &= (-1)^{j-1} \int_{\underline{a}_{p-1}^{(j)}} a(B) dx_1 \cdots d\widehat{x}_j \cdots dx_p. \end{aligned}$$

Notice that if $i \neq 0$ or j , then

$$\int_{\underline{a}_{p-1}^{(i)}} \omega = 0$$

Whence, we find that

$$(-1)^j \int_{\underline{a}_{p-1}^{(j)}} \omega + (-1)^{j-1} (-1)^{j-1} \int_{\underline{a}_{p-1}^{(0)}} \omega = \sum_{i=0}^p (-1)^i \int_{\underline{a}_{p-1}^i} \omega$$

and

$$\int_{\partial \underline{\mathbb{R}}^p} \omega = \int_{\sum_{i=0}^p (-1)^i \underline{a}_{p-1}^i} \omega = \sum_{i=0}^p (-1)^i \int_{\underline{a}_{p-1}^i} \omega,$$

where $\underline{a}_{p-1}^i = a_0 a_1 \cdots \widehat{a}_i \cdots a_p$. Therefore, we get that

$$\begin{aligned} \int_{\underline{\mathbb{R}}^p} d\omega &= (-1)^j \int_{\underline{a}_{p-1}^{(j)}} \omega + (-1)^{j-1} \int_{\underline{a}_{p-1}^{(0)}} a(B) dx_1 \cdots d\widehat{x}_j \cdots dx_p \\ &= (-1)^j \int_{\underline{a}_{p-1}^{(j)}} \omega + (-1)^{j-1} (-1)^{j-1} \int_{\underline{a}_{p-1}^{(0)}} \omega = \int_{\partial \underline{\mathbb{R}}^p} \omega. \end{aligned}$$

This completes the proof. □

§3.3 SMARANDACHE N-MANIFOLDS

3.3.1 Smarandache Geometry. Let $(M; \rho)$ be a metric space, i.e., a geometrical system. An axiom is said to be *Smarandachely denied* in $(M; \rho)$ if this axiom behaves in at least two different ways within M , i.e., validated and invalidated, or only invalidated but in multiple distinct ways. A *Smarandache geometry* is a geometry which has at least one Smarandachely denied axiom, which was first introduced by Smarandache in [Sma2] and then a formal definition in [KuA1].

As we known, an axiom system of an *Euclid geometry* is consisted of five axioms following:

(E1) *there is a straight line between any two points.*

(E2) *a finite straight line can produce a infinite straight line continuously.*

(E3) *any point and a distance can describe a circle.*

(E4) *all right angles are equal to one another.*

(E5) *if a straight line falling on two straight lines make the interior angles on the same side less than two right angles, then the two straight lines, if produced indefinitely, meet on that side on which are the angles less than the two right angles.*

The last axiom (E5) is usually replaced by:

(E5') *given a line and a point exterior this line, there is one line parallel to this line.*

Notice that in a *Lobachevshy-Bolyai-Gauss geometry*, also called the *hyperbolic geometry*, the axiom (E5) is replaced by

(L5) *there are infinitely many lines parallel to a given line passing through an exterior point,*

and in a *Riemannian geometry*, also called the *elliptic geometry*, the axiom (E5) is replaced by (R5):

there is no parallel to a given line passing through an exterior point.

There are many ways for constructing Smarandache geometries, particularly, by

denying some axioms in Euclidean geometry done as in Lobachevshy-Bolyai-Gauss geometry and Riemannian geometry.

For example, let \mathbf{R}^2 be a Euclidean plane, points $A, B \in \mathbf{R}^2$ and l a straight line, where each straight line passes through A will turn 30° degree to the upper and passes through B will turn 30° degree to the down such as those shown in Fig. 3.3.1. Then each line passing through A in F_1 will intersect with l , lines passing through B in F_2 will not intersect with l and there is only one line passing through other points does not intersect with l .

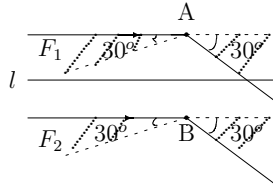

Fig.3.3.1

A nice model on Smarandache geometries, namely s -manifolds on the plane was found by Iseri in [Ise1], which is defined as follows:

An s -manifold is any collection $\mathcal{C}(T, n)$ of these equilateral triangular disks $T_i, 1 \leq i \leq n$ satisfying the following conditions:

- (i) each edge e is the identification of at most two edges e_i, e_j in two distinct triangular disks $T_i, T_j, 1 \leq i, j \leq n$ and $i \neq j$;
- (ii) each vertex v is the identification of one vertex in each of five, six or seven distinct triangular disks.

The vertices are classified by the number of the disks around them. A vertex around five, six or seven triangular disks is called an *elliptic vertex*, an *Euclidean vertex* or a *hyperbolic vertex*, respectively.

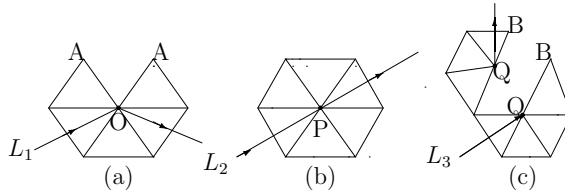

Fig.3.3.2

In a plane, an elliptic vertex O , a Euclidean vertex P and a hyperbolic vertex Q and an s -line L_1, L_2 or L_3 passes through points O, P or Q are shown in Fig.3.3.2(a), (b), (c), respectively.

As shown in [Ise1] and [Mao3], there are many ways for constructing a Smarandache geometry, such as those of denial one or more axioms of a Euclidean geometry by new axiom or its anti-axiom,...., etc.

3.3.2 Map Geometry. A *map geometry* is gotten by endowing an angular function $\mu : V(M) \rightarrow [0, 4\pi)$ on a map M , which was first introduced in [Mao2] as a generalization of Iseri's model on surfaces. In fact, the essence in Iseri's model is not these numbers 5, 6 or 7, but in these angles $300^\circ, 360^\circ$ and 420° on vertices, which determines a vertex is elliptic, Euclidean or hyperbolic on the plane.

Definition 3.3.1 Let M be a combinatorial map on a surface S with each vertex valency ≥ 3 and $\mu : V(M) \rightarrow [0, 4\pi)$, i.e., endow each vertex $u, u \in V(M)$ with a real number $\mu(u), 0 < \mu(u) < \frac{4\pi}{\rho_M(u)}$. The pair (M, μ) is called a map geometry without boundary, $\mu(u)$ an angle factor on u and orientable or non-orientable if M is orientable or not.

Certainly, a vertex $u \in V(M)$ with $\rho_M(u)\mu(u) < 2\pi, = 2\pi$ or $> 2\pi$ can be realized in a Euclidean space \mathbf{R}^3 , such as those shown in Fig.3.3.3.

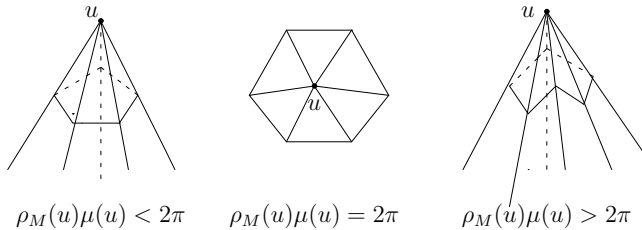

Fig.3.3.3

A point u in a map geometry (M, μ) is said to be *elliptic, Euclidean* or *hyperbolic* if $\rho_M(u)\mu(u) < 2\pi, \rho_M(u)\mu(u) = 2\pi$ or $\rho_M(u)\mu(u) > 2\pi$. If $\mu(u) = 60^\circ$, we find these elliptic, Euclidean or hyperbolic vertices are just the same in Iseri's model, which means that these s -manifolds are a special map geometry. If a line passes through a point u , it must has an angle $\frac{\rho_M(u)\mu(u)}{2}$ with the entering ray and equal

to 180° only when u is Euclidean. For convenience, we always assume that a line passing through an elliptic point turn to the left and a hyperbolic point to the right on the plane.

Theorem 3.3.1 *Let M be a map on a locally orientable surface with $|M| \geq 3$ and $\rho_M(u) \geq 3$ for $\forall u \in V(M)$. Then there exists an angle factor $\mu : V(M) \rightarrow [0, 4\pi)$ such that (M, μ) is a Smarandache geometry by denial the axiom (E5) with axioms (E5), (L5) and (R5).*

Proof By the assumption $\rho_M(u) \geq 3$, we can always choose an angle factor μ such that $\mu(u)\rho_M(u) < 2\pi$, $\mu(v)\rho_M(u) = 2\pi$ or $\mu(w)\rho_M(u) > 2\pi$ for three vertices $u, v, w \in V(M)$, i.e., there elliptic, or Euclidean, or hyperbolic points exist in (M, μ) simultaneously. The proof is divided into three cases.

Case 1. M is a planar map

Choose L being a line under the map M , not intersection with it, $u \in (M, \mu)$. Then if u is Euclidean, there is one and only one line passing through u not intersecting with L , and if u is elliptic, there are infinite many lines passing through u not intersecting with L , but if u is hyperbolic, then each line passing through u will intersect with L . See for example, Fig.3.3.4 in where the planar graph is a complete graph K_4 on a sphere and points 1, 2 are elliptic, 3 is Euclidean but the point 4 is hyperbolic. Then all lines in the field A do not intersect with L , but each line passing through the point 4 will intersect with the line L . Therefore, (M, μ) is a Smarandache geometry by denial the axiom (E5) with these axioms (E5), (L5) and (R5).

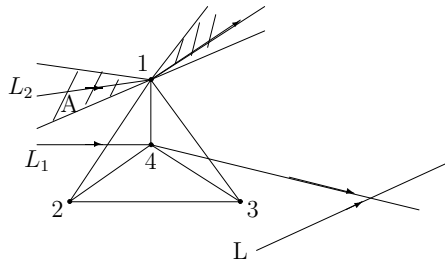

Fig.3.3.4

Case 2. M is an orientable map

According to Theorem 3.1.15 of classifying surfaces, We only need to prove this assertion on a torus. In this case, lines on a torus has the following property (see [NiS1] for details):

if the slope ς of a line L is a rational number, then L is a closed line on the torus. Otherwise, L is infinite, and moreover L passes arbitrarily close to every point on the torus.

Whence, if L_1 is a line on a torus with an irrational slope not passing through an elliptic or a hyperbolic point, then for any point u exterior to L_1 , if u is a Euclidean point, then there is only one line passing through u not intersecting with L_1 , and if u is elliptic or hyperbolic, any m -line passing through u will intersect with L_1 .

Now let L_2 be a line on the torus with a rational slope not passing through an elliptic or a hyperbolic point, such as the the line L_2 shown in Fig.3.3.5, in where v is a Euclidean point. If u is a Euclidean point, then each line L passing through u with rational slope in the area A will not intersect with L_2 , but each line passing through u with irrational slope in the area A will intersect with L_2 .

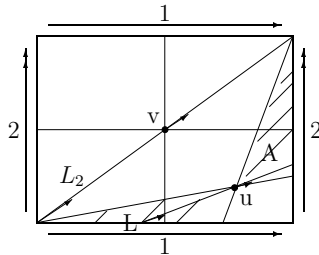

Fig.3.3.5

Therefore, (M, μ) is a Smarandache geometry by denial the axiom (E5) with axioms (E5), (L5) and (R5) in the orientable case.

Case 3. M is a non-orientable map

Similar to the Case 2, we only need to prove this result for the projective plane. A line in a projective plane is shown in Fig.3.3.6(a), (b) or (c), in where case (a) is a line passing through a Euclidean point, (b) passing through an elliptic point and (c) passing through a hyperbolic point.

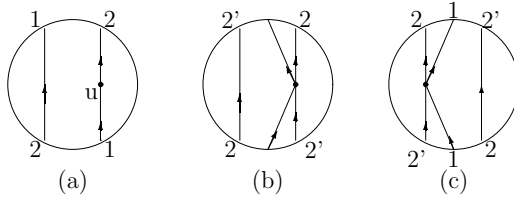

Fig.3.3.6

Let L be a line passing through the center of the circle. Then if u is a Euclidean point, there is only one line passing through u such as the case (a) in Fig.3.3.7. If v is an elliptic point then there is an m -line passing through it and intersecting with L such as the case (b) in Fig.3.3.7. We assume the point 1 is a point such that there exists a line passing through 1 and 0, then any line in the shade of Fig.3.3.7(b) passing through v will intersect with L .

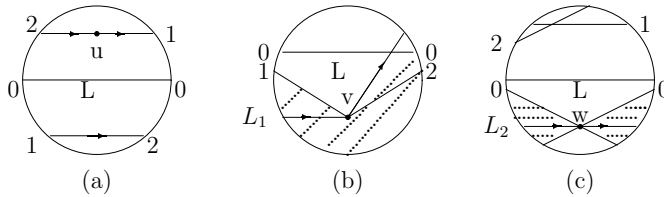

Fig.3.3.7

If w is a Euclidean point and there is a line passing through it not intersecting with L such as the case (c) in Fig.3.3.7, then any line in the shade of Fig.3.3.7(c) passing through w will not intersect with L . Since the position of the vertices of a map M on a projective plane can be choose as our wish, we know (M, μ) is a Smarandache geometry by denial the axiom (E5) with axioms (E5),(L5) and (R5).

Combining discussions of Cases 1, 2 and 3, the proof is complete. □

These map geometries determined in Theorem 3.3.1 are all without boundary, which are a generalization of polyhedral geometry, i.e., Riemannian geometry. Generally, we can also introduce map geometries with deleting some faces, i.e., map geometries with boundary.

Definition 3.3.2 *Let (M, μ) be a map geometry without boundary, faces $f_1, f_2, \dots, f_l \in F(M), 1 \leq l \leq \phi(M) - 1$. If $S(M) \setminus \{f_1, f_2, \dots, f_l\}$ is connected, then $(M, \mu)^{-l} =$*

$(S(M) \setminus \{f_1, f_2, \dots, f_l\}, \mu)$ is called a map geometry with boundary f_1, f_2, \dots, f_l , and orientable or not if (M, μ) is orientable or not, where $S(M)$ denotes the underlying surface of M .

Similarly, map geometries with boundary can also provide Smarandache geometries, which is convinced in the following for $l = 1$.

Theorem 3.3.2 *Let M be a map on a locally orientable surface with order ≥ 3 , vertex valency ≥ 3 and a face $f \in F(M)$. Then there is an angle factor $\mu : V(M) \rightarrow [0, 4\pi)$ such that $(M, \mu)^{-1}$ is a Smarandache geometry by denial the axiom (E5) with these axioms (E5), (L5) and (R5).*

Proof Divide the discussion into planar map, orientable map on a torus and non-orientable map on a projective plane dependent on M , respectively. Similar to the proof of Theorem 3.3.1, We can prove $(M, \mu)^{-1}$ is a Smarandache geometry by denial the axiom (E5) with these axioms (E5), (L5) and (R5) in each case. In fact, the proof applies here, only need to note that a line in a map geometry with boundary is terminated at its boundary. □

A *Poincaré's model* for hyperbolic geometry is an upper half-plane in which lines are upper half-circles with center on the x -axis or upper straight lines perpendicular to the x -axis such as those shown in Fig.3.3.8.

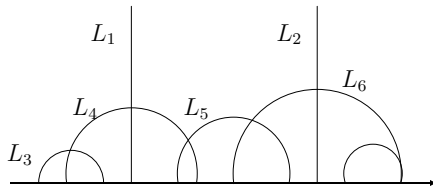

Fig.3.3.8

Now let all infinite points be a same point. Then the Poincaré's model for hyperbolic geometry turns to a *Klein model* for hyperbolic geometry which uses a boundary circle and lines are straight line segment in this circle, such as those shown in Fig.3.3.9.

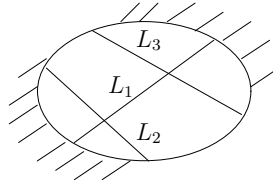

Fig.3.3.9

Whence, a Klein’s model is nothing but a map geometry with boundary of 1 face determined by Theorem 3.3.2. This fact convinces us that map geometries with boundary are a generalization of hyperbolic geometry.

3.3.3 Pseudo-Euclidean Space. Let \mathbf{R}^n be an n -dimensional Euclidean space with a normal basis $\bar{\epsilon}_1 = (1, 0, \dots, 0)$, $\bar{\epsilon}_2 = (0, 1, \dots, 0)$, \dots , $\bar{\epsilon}_n = (0, 0, \dots, 1)$. An orientation \vec{X} is a vector \overrightarrow{OX} with $\|\overrightarrow{OX}\| = 1$ in \mathbf{R}^n , where $O = (0, 0, \dots, 0)$. Usually, an orientation \vec{X} is denoted by its projections of \overrightarrow{OX} on each $\bar{\epsilon}_i$ for $1 \leq i \leq n$, i.e.,

$$\vec{X} = (\cos(\overrightarrow{OX}, \bar{\epsilon}_1), \cos(\overrightarrow{OX}, \bar{\epsilon}_2), \dots, \cos(\overrightarrow{OX}, \bar{\epsilon}_n)),$$

where $(\overrightarrow{OX}, \bar{\epsilon}_i)$ denotes the angle between vectors \overrightarrow{OX} and $\bar{\epsilon}_i$, $1 \leq i \leq n$. All possible orientations \vec{X} in \mathbf{R}^n consist of a set \mathcal{O} .

A *pseudo-Euclidean space* is a pair $(\mathbf{R}^n, \omega|_{\vec{O}})$, where $\omega|_{\vec{O}} : \mathbf{R}^n \rightarrow \mathcal{O}$ is a continuous function, i.e., a straight line with an orientation \vec{O} will have an orientation $\vec{O} + \omega|_{\vec{O}}(\bar{u})$ after it passing through a point $\bar{u} \in \mathbf{E}$. It is obvious that $(\mathbf{E}, \omega|_{\vec{O}}) = \mathbf{E}$, namely the Euclidean space itself if and only if $\omega|_{\vec{O}}(\bar{u}) = \bar{0}$ for $\forall \bar{u} \in \mathbf{E}$.

We have known that a straight line L passing through a point $(x_1^0, x_2^0, \dots, x_n^0)$ with an orientation $\vec{O} = (X_1, X_2, \dots, X_n)$ is defined to be a point set (x_1, x_2, \dots, x_n) determined by an equation system

$$\begin{cases} x_1 = x_1^0 + tX_1 \\ x_2 = x_2^0 + tX_2 \\ \dots\dots\dots \\ x_n = x_n^0 + tX_n \end{cases}$$

for $\forall t \in \mathbf{R}$ in analytic geometry on \mathbf{R}^n , or equivalently, by the equation system

$$\frac{x_1 - x_1^0}{X_1} = \frac{x_2 - x_2^0}{X_2} = \dots = \frac{x_n - x_n^0}{X_n}.$$

Therefore, we can also determine its equation system for a straight line L in a pseudo-Euclidean space (\mathbf{R}^n, ω) . By definition, a straight line L passing through a Euclidean point $\vec{x}^0 = (x_1^0, x_2^0, \dots, x_n^0) \in \mathbf{R}^n$ with an orientation $\vec{O} = (X_1, X_2, \dots, X_n)$ in (\mathbf{R}^n, ω) is a point set (x_1, x_2, \dots, x_n) determined by an equation system

$$\begin{cases} x_1 = x_1^0 + t(X_1 + \omega_1(\vec{x}^0)) \\ x_2 = x_2^0 + t(X_2 + \omega_2(\vec{x}^0)) \\ \dots\dots\dots \\ x_n = x_n^0 + t(X_n + \omega_n(\vec{x}^0)) \end{cases}$$

for $\forall t \in \mathbf{R}$, or equivalently,

$$\frac{x_1 - x_1^0}{X_1 + \omega_1(\vec{x}^0)} = \frac{x_2 - x_2^0}{X_2 + \omega_2(\vec{x}^0)} = \dots = \frac{x_n - x_n^0}{X_n + \omega_n(\vec{x}^0)},$$

where $\omega|_{\vec{O}}(\vec{x}^0) = (\omega_1(\vec{x}^0), \omega_2(\vec{x}^0), \dots, \omega_n(\vec{x}^0))$. Notice that this equation system dependent on $\omega|_{\vec{O}}$, it maybe not a linear equation system.

Similarly, let \vec{O} be an orientation. A point $\vec{u} \in \mathbf{R}^n$ is said to be *Euclidean* on orientation \vec{O} if $\omega|_{\vec{O}}(\vec{u}) = \vec{0}$. Otherwise, let $\omega|_{\vec{O}}(\vec{u}) = (\omega_1(\vec{u}), \omega_2(\vec{u}), \dots, \omega_n(\vec{u}))$. The point \vec{u} is *elliptic* or *hyperbolic* determined by the following inductive programming.

STEP 1. If $\omega_1(\vec{u}) < 0$, then \vec{u} is elliptic; otherwise, hyperbolic if $\omega_1(\vec{u}) > 0$;

STEP 2. If $\omega_1(\vec{u}) = \omega_2(\vec{u}) = \dots = \omega_i(\vec{u}) = 0$, but $\omega_{i+1}(\vec{u}) < 0$ then \vec{u} is elliptic; otherwise, hyperbolic if $\omega_{i+1}(\vec{u}) > 0$ for an integer $i, 0 \leq i \leq n - 1$.

Denote these elliptic, Euclidean and hyperbolic point sets by

$$\begin{aligned} \vec{V}_{eu} &= \{ \vec{u} \in \mathbf{R}^n \mid \vec{u} \text{ an Euclidean point } \}, \\ \vec{V}_{el} &= \{ \vec{v} \in \mathbf{R}^n \mid \vec{v} \text{ an elliptic point } \}. \\ \vec{V}_{hy} &= \{ \vec{v} \in \mathbf{R}^n \mid \vec{v} \text{ a hyperbolic point } \}. \end{aligned}$$

Then we get a partition

$$\mathbf{R}^n = \vec{V}_{eu} \cup \vec{V}_{el} \cup \vec{V}_{hy}$$

on points in \mathbf{R}^n with $\vec{V}_{eu} \cap \vec{V}_{el} = \emptyset$, $\vec{V}_{eu} \cap \vec{V}_{hy} = \emptyset$ and $\vec{V}_{el} \cap \vec{V}_{hy} = \emptyset$. Points in $\vec{V}_{el} \cap \vec{V}_{hy}$ are called *non-Euclidean points*.

Now we introduce a linear order \prec on \mathcal{O} by the dictionary arrangement in the following.

For (x_1, x_2, \dots, x_n) and $(x'_1, x'_2, \dots, x'_n) \in \mathcal{O}$, if $x_1 = x'_1, x_2 = x'_2, \dots, x_l = x'_l$ and $x_{l+1} < x'_{l+1}$ for any integer $l, 0 \leq l \leq n - 1$, then define $(x_1, x_2, \dots, x_n) \prec (x'_1, x'_2, \dots, x'_n)$.

By this definition, we know that

$$\omega|_{\vec{\mathcal{O}}}(\bar{u}) \prec \omega|_{\vec{\mathcal{O}}}(\bar{v}) \prec \omega|_{\vec{\mathcal{O}}}(\bar{w})$$

for $\forall \bar{u} \in \vec{V}_{el}, \bar{v} \in \vec{V}_{eu}, \bar{w} \in \vec{V}_{hy}$ and a given orientation $\vec{\mathcal{O}}$. This fact enables us to find an interesting result following.

Theorem 3.3.3 For any orientation $\vec{\mathcal{O}} \in \mathcal{O}$ in a pseudo-Euclidean space $(\mathbf{R}^n, \omega|_{\vec{\mathcal{O}}})$, if $\vec{V}_{el} \neq \emptyset$ and $\vec{V}_{hy} \neq \emptyset$, then $\vec{V}_{eu} \neq \emptyset$.

Proof By assumption, $\vec{V}_{el} \neq \emptyset$ and $\vec{V}_{hy} \neq \emptyset$, we can choose points $\bar{u} \in \vec{V}_{el}$ and $\bar{w} \in \vec{V}_{hy}$. Notice that $\omega|_{\vec{\mathcal{O}}} : \mathbf{R}^n \rightarrow \mathcal{O}$ is a continuous and (\mathcal{O}, \prec) a linear ordered set. Applying the *generalized intermediate value theorem* on continuous mappings in topology, i.e.,

Let $f : X \rightarrow Y$ be a continuous mapping with X a connected space and Y a linear ordered set in the order topology. If $a, b \in X$ and $y \in Y$ lies between $f(a)$ and $f(b)$, then there exists $x \in X$ such that $f(x) = y$.

we know that there is a point $\bar{v} \in \mathbf{R}^n$ such that

$$\omega|_{\vec{\mathcal{O}}}(\bar{v}) = \bar{0},$$

i.e., \bar{v} is a Euclidean point by definition. □

Corollary 3.3.1 For any orientation $\vec{\mathcal{O}} \in \mathcal{O}$ in a pseudo-Euclidean space $(\mathbf{R}^n, \omega|_{\vec{\mathcal{O}}})$, if $\vec{V}_{eu} = \emptyset$, then either points in $(\mathbf{R}^n, \omega|_{\vec{\mathcal{O}}})$ is elliptic or hyperbolic.

Certainly, a pseudo-Euclidean space $(\mathbf{R}^n, \omega|_{\vec{\mathcal{O}}})$ is a Smarandache geometry sometimes explained in the following.

Theorem 3.3.4 A pseudo-Euclidean space $(\mathbf{R}^n, \omega|_{\vec{\mathcal{O}}})$ is a Smarandache geometry

if $\vec{V}_{eu}, \vec{V}_{el} \neq \emptyset$, or $\vec{V}_{eu}, \vec{V}_{hy} \neq \emptyset$, or $\vec{V}_{el}, \vec{V}_{hy} \neq \emptyset$ for an orientation \vec{O} in $(\mathbf{R}^n, \omega|_{\vec{O}})$.

Proof Notice that $\omega|_{\vec{O}}(\bar{u}) = \bar{0}$ is an axiom in \mathbf{R}^n , but a Smarandache denied axiom if $\vec{V}_{eu}, \vec{V}_{el} \neq \emptyset$, or $\vec{V}_{eu}, \vec{V}_{hy} \neq \emptyset$, or $\vec{V}_{el}, \vec{V}_{hy} \neq \emptyset$ for an orientation \vec{O} in $(\mathbf{R}^n, \omega|_{\vec{O}})$ for $\omega|_{\vec{O}}(\bar{u}) = \bar{0}$ or $\neq \bar{0}$ in the former two cases and $\omega|_{\vec{O}}(\bar{u}) \prec \bar{0}$ or $\succ \bar{0}$ both hold in the last one. Whence, we know that $(\mathbf{R}^n, \omega|_{\vec{O}})$ is a Smarandache geometry by definition. \square

Notice that there infinite points on a segment of a straight line in \mathbf{R}^n . Whence, a necessary for the existence of a straight line is there exist infinite Euclidean points in $(\mathbf{R}^n, \omega|_{\vec{O}})$. We find a necessary and sufficient result for the existence of a curve C in $(\mathbf{R}^n, \omega|_{\vec{O}})$ following.

Theorem 3.3.5 *A curve $C = (f_1(t), f_2(t), \dots, f_n(t))$ exists in a pseudo-Euclidean space $(\mathbf{R}^n, \omega|_{\vec{O}})$ for an orientation \vec{O} if and only if*

$$\frac{df_1(t)}{dt} \Big|_{\bar{u}} = \sqrt{\left(\frac{1}{\omega_1(\bar{u})}\right)^2 - 1},$$

$$\frac{df_2(t)}{dt} \Big|_{\bar{u}} = \sqrt{\left(\frac{1}{\omega_2(\bar{u})}\right)^2 - 1},$$

.....,

$$\frac{df_n(t)}{dt} \Big|_{\bar{u}} = \sqrt{\left(\frac{1}{\omega_n(\bar{u})}\right)^2 - 1}.$$

for $\forall \bar{u} \in C$, where $\omega|_{\vec{O}} = (\omega_1, \omega_2, \dots, \omega_n)$.

Proof Let the angle between $\omega|_{\vec{O}}$ and $\bar{\epsilon}_i$ be θ_i , $1 \leq \theta_i \leq n$.

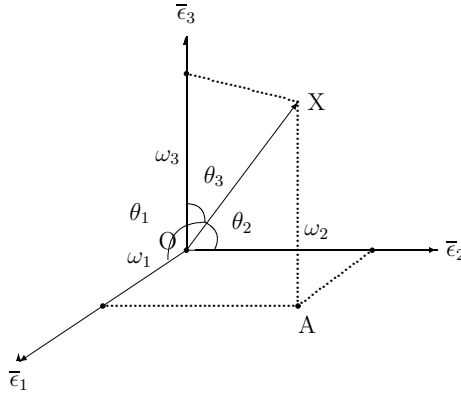

Fig.3.3.10

Then we know that

$$\cos \theta_i = \omega_i, \quad 1 \leq i \leq n.$$

According to the geometrical implication of differential at a point $\bar{u} \in \mathbf{R}^n$, seeing also Fig.3.3.10, we know that

$$\frac{df_i(t)}{dt} \Big|_{\bar{u}} = tg\theta_i = \sqrt{\left(\frac{1}{\omega_i(\bar{u})}\right)^2 - 1}$$

for $1 \leq i \leq n$. Therefore, if a curve $C = (f_1(t), f_2(t), \dots, f_n(t))$ exists in a pseudo-Euclidean space $(\mathbf{R}^n, \omega |_{\vec{O}})$ for an orientation \vec{O} , then

$$\frac{df_i(t)}{dt} \Big|_{\bar{u}} = \sqrt{\left(\frac{1}{\omega_2(\bar{u})}\right)^2 - 1}, \quad 1 \leq i \leq n$$

for $\forall \bar{u} \in C$. On the other hand, if

$$\frac{df_i(t)}{dt} \Big|_{\bar{v}} = \sqrt{\left(\frac{1}{\omega_2(\bar{v})}\right)^2 - 1}, \quad 1 \leq i \leq n$$

hold for points \bar{v} for $\forall t \in \mathbf{R}$, then all points \bar{v} , $t \in \mathbf{R}$ consist of a curve $C = (f_1(t), f_2(t), \dots, f_n(t))$ in $(\mathbf{R}^n, \omega |_{\vec{O}})$ for the orientation \vec{O} . □

Corollary 3.3.2 *A straight line L exists in $(\mathbf{R}^n, \omega |_{\vec{O}})$ if and only if $\omega |_{\vec{O}}(\bar{u}) = \bar{0}$ for $\forall \bar{u} \in L$ and $\forall \vec{O} \in \mathcal{O}$.*

3.3.4 Smarandache manifold. For an integer $n, n \geq 2$, a *Smarandache manifold* is a n -manifold that supports a Smarandache geometry. Certainly, there are many ways for construction of Smarandache manifolds. For example, these pseudo-Euclidean spaces $(\mathbf{R}^n, \omega|_{\vec{O}})$ for different homomorphisms $\omega|_{\vec{O}}$ and orientations \vec{O} . We consider a general family of Smarandache manifolds, i.e., pseudo-manifolds $(M^n, \mathcal{A}^\omega)$ in this section, which is a generalization of n -manifolds.

An n -dimensional pseudo-manifold $(M^n, \mathcal{A}^\omega)$ is a Hausdorff space such that each points p has an open neighborhood U_p homomorphic to a pseudo-Euclidean space $(\mathbf{R}^n, \omega|_{\vec{O}})$, where $\mathcal{A} = \{(U_p, \varphi_p^\omega) | p \in M^n\}$ is its atlas with a homomorphism $\varphi_p^\omega : U_p \rightarrow (\mathbf{R}^n, \omega|_{\vec{O}})$ and a chart (U_p, φ_p^ω) .

Theorem 3.3.6 For a point $p \in (M^n, \mathcal{A}^\omega)$ with a local chart (U_p, φ_p^ω) , $\varphi_p^\omega = \varphi_p$ if and only if $\omega|_{\vec{O}}(p) = \vec{0}$.

Proof For $\forall p \in (M^n, \mathcal{A}^\omega)$, if $\varphi_p^\omega(p) = \varphi_p(p)$, then $\omega(\varphi_p(p)) = \varphi_p(p)$. By the definition of pseudo-Euclidean space $(\mathbf{R}^n, \omega|_{\vec{O}})$, this can only happens while $\omega(p) = \vec{0}$. \square

A point $p \in (M^n, \mathcal{A}^\omega)$ is *elliptic, Euclidean* or *hyperbolic* if $\omega(\varphi_p(p)) \in (\mathbf{R}^n, \omega|_{\vec{O}})$ is *elliptic, Euclidean* or *hyperbolic*, respectively. These elliptic and hyperbolic points also called *non-Euclidean points*. We get a consequence by Theorem 3.3.6.

Corollary 3.3.3 Let $(M^n, \mathcal{A}^\omega)$ be a pseudo-manifold. Then $\varphi_p^\omega = \varphi_p$ if and only if every point in M^n is Euclidean.

Theorem 3.3.7 Let $(M^n, \mathcal{A}^\omega)$ be an n -dimensional pseudo-manifold, $p \in M^n$. If there are Euclidean and non-Euclidean points simultaneously or two elliptic or hyperbolic points on an orientation \vec{O} in (U_p, φ_p) , then $(M^n, \mathcal{A}^\omega)$ is a Smarandache n -manifold.

Proof Notice that two lines L_1, L_2 are said *locally parallel* in a neighborhood (U_p, φ_p^ω) of a point $p \in (M^n, \mathcal{A}^\omega)$ if $\varphi_p^\omega(L_1)$ and $\varphi_p^\omega(L_2)$ are parallel in $(\mathbf{R}^n, \omega|_{\vec{O}})$. If these conditions hold for $(M^n, \mathcal{A}^\omega)$, the axiom that *there is exactly one line passing through a point locally parallel a given line* is Smarandachely denied since it behaves in at least two different ways, i.e., *one parallel, none parallel*, or *one parallel, infinite parallels*, or *none parallel, infinite parallels*, which are verified in the following.

If there are Euclidean and non-Euclidean points in (U_p, φ_p^ω) simultaneously, not

loss of generality, we assume that u is Euclidean but v non-Euclidean, $\varphi_p^\omega(v) = (\omega_1, \omega_2, \dots, \omega_n)$ with $\omega_1 < 0$.

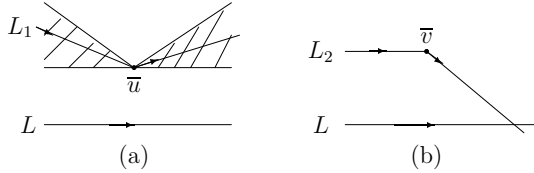

Fig.3.3.11

Let L be a line parallel the axis $\vec{\tau}_1$ in $(\mathbf{R}^n, \omega|\vec{\mathcal{O}})$. There is only one line L_u locally parallel to $(\varphi_p^\omega)^{-1}(L)$ passing through the point u since there is only one line $\varphi_p^\omega(L_u)$ parallel to L in $(\mathbf{R}^n, \omega|\vec{\mathcal{O}})$. However, if $\omega_1 > 0$, then there are infinite many lines passing through u locally parallel to $\varphi_p^{-1}(L)$ in (U_p, φ_p) since there are infinite many lines parallel L in $(\mathbf{R}^n, \omega|\vec{\mathcal{O}})$, such as those shown in Fig.3.3.11(a) in where each line passing through the point $\bar{u} = \varphi_p^\omega(u)$ from the shade field is parallel to L . But if $\omega_1 > 0$, then there are no lines locally parallel to $(\varphi_p^\omega)^{-1}(L)$ in (U_p, φ_p^ω) since there are no lines passing through the point $\bar{v} = \varphi_p^\omega(v)$ parallel to L in $(\mathbf{R}^n, \omega|\vec{\mathcal{O}})$, such as those shown in Fig.3.3.11(b).

If there are two elliptic points u, v along a direction $\vec{\mathcal{O}}$, consider the plane \mathcal{P} determined by $\varphi_p^\omega(u), \varphi_p^\omega(v)$ with $\vec{\mathcal{O}}$ in $(\mathbf{R}^n, \omega|\vec{\mathcal{O}})$. Let L be a line intersecting with the line $\varphi_p^\omega(u)\varphi_p^\omega(v)$ in \mathcal{P} . Then there are infinite lines passing through u locally parallel to $(\varphi_p^\omega)^{-1}(L)$ but none line passing through v locally parallel to $\varphi_p^{-1}(L)$ in (U_p, φ_p) since there are infinite many lines or none lines passing through $\bar{u} = \varphi_p^\omega(u)$ or $\bar{v} = \varphi_p^\omega(v)$ parallel to L in $(\mathbf{R}^n, \omega|\vec{\mathcal{O}})$, such as those shown in Fig.3.3.12.

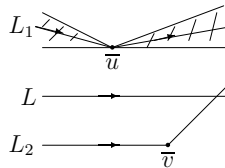

Fig.3.3.12

Similarly, we can also get the conclusion on the case of hyperbolic points. Since there exists a Smarandachely denied axiom in $(M^n, \mathcal{A}^\omega)$ under these assumptions, it is indeed a Smarandache manifold. \square

Particularly, we have consequences following by Theorem 3.3.7 for pseudo-Euclidean spaces $(\mathbf{R}^n, \omega|_{\vec{O}})$.

Corollary 3.3.4 *For any integer $n \geq 2$, if there are Euclidean and non-Euclidean points simultaneously or two elliptic or hyperbolic points in an orientation \vec{O} in $(\mathbf{R}^n, \omega|_{\vec{O}})$, then $(\mathbf{R}^n, \omega|_{\vec{O}})$ is an n -dimensional Smarandache geometry.*

Corollary 3.3.4 partially answers an open problem in [Mao3] for establishing Smarandache geometries in \mathbf{R}^3 .

Corollary 3.3.5 *If there are points $\bar{p}, \bar{q} \in (\mathbf{R}^3, \omega|_{\vec{O}})$ such that $\omega|_{\vec{O}}(\bar{p}) \neq (0, 0, 0)$ but $\omega|_{\vec{O}}(\bar{q}) = (0, 0, 0)$ or \bar{p}, \bar{q} are simultaneously elliptic or hyperbolic in an orientation \vec{O} in $(\mathbf{R}^3, \omega|_{\vec{O}})$, then $(\mathbf{R}^3, \omega|_{\vec{O}})$ is a Smarandache geometry.*

Notice that if there only finite non-Euclidean points in $(M^n, \mathcal{A}^\omega)$, a loop L_p based at a point $p \in M^n$ is still a loop of $(M^n, \mathcal{A}^\omega)$ based at a point $p \in (M^n, \mathcal{A}^\omega)$ and vice versa. Whence, we get the fundamental groups of pseudo-manifolds with finite non-Euclidean points.

Theorem 3.3.8 *Let $(M^n, \mathcal{A}^\omega)$ be a pseudo-manifold with finite non-Euclidean points. Then*

$$\pi_1(M^n, p) = \pi_1((M^n, \mathcal{A}^\omega), p)$$

for $\forall p \in (M^n, \mathcal{A}^\omega)$. □

§3.4 DIFFERENTIAL SMARANDACHE MANIFOLDS

3.4.1 Differential Manifold. A differential n -manifold (M^n, \mathcal{A}) is an n -manifold M^n , where $M^n = \bigcup_{i \in I} U_i$ endowed with a C^r differential structure $\mathcal{A} = \{(U_\alpha, \varphi_\alpha) | \alpha \in I\}$ on M^n for an integer r with following conditions hold.

- (1) $\{U_\alpha; \alpha \in I\}$ is an open covering of M^n ;
- (2) For $\forall \alpha, \beta \in I$, atlases $(U_\alpha, \varphi_\alpha)$ and (U_β, φ_β) are equivalent, i.e., $U_\alpha \cap U_\beta = \emptyset$ or $U_\alpha \cap U_\beta \neq \emptyset$ but the overlap maps

$$\varphi_\alpha \varphi_\beta^{-1} : \varphi_\beta(U_\alpha \cap U_\beta) \rightarrow \varphi_\alpha(U_\alpha) \quad \text{and} \quad \varphi_\beta \varphi_\alpha^{-1} : \varphi_\alpha(U_\alpha \cap U_\beta) \rightarrow \varphi_\beta(U_\beta)$$

are C^r ;

(3) \mathcal{A} is maximal, i.e., if (U, φ) is an atlas of M^n equivalent with one atlas in \mathcal{A} , then $(U, \varphi) \in \mathcal{A}$.

An n -manifold is *smooth* if it is endowed with a C^∞ differential structure. It has been known that the base of a tangent space $T_p M^n$ of differential n -manifold (M^n, \mathcal{A}) consisting of $\frac{\partial}{\partial x^i}, 1 \leq i \leq n$ for $\forall p \in (M^n, \mathcal{A})$. More results on differential manifolds can be found in [ABM1], [MAR1], [Pet1], [Wes1] or [ChL1] for details.

3.4.2 Differential Smarandache manifold. For an integer $r \geq 1$, a C^r differential Smarandache manifold $(M^n, \mathcal{A}^\omega)$ is a Smarandache manifold $(M^n, \mathcal{A}^\omega)$ endowed with a C^r differentiable structure \mathcal{A} and $\omega|_{\vec{\mathcal{O}}}$ for an orientation $\vec{\mathcal{O}}$. A C^∞ Smarandache n -manifold $(M^n, \mathcal{A}^\omega)$ is also said to be a *smooth Smarandache manifold*. For pseudo-manifolds, we know their differentiable conditions following.

Theorem 3.4.1 *A pseudo-Manifold $(M^n, \mathcal{A}^\omega)$ is a C^r differential Smarandache manifold with an orientation $\vec{\mathcal{O}}$ for an integer $r \geq 1$ if conditions following hold.*

- (1) *There is a C^r differential structure $\mathcal{A} = \{(U_\alpha, \varphi_\alpha) | \alpha \in I\}$ on M^n ;*
- (2) *$\omega|_{\vec{\mathcal{O}}}$ is C^r ;*
- (3) *There are Euclidean and non-Euclidean points simultaneously or two elliptic or hyperbolic points on the orientation $\vec{\mathcal{O}}$ in (U_p, φ_p) for a point $p \in M^n$.*

Proof The condition (1) implies that (M^n, \mathcal{A}) is a C^r differential n -manifold and conditions (2), (3) ensure $(M^n, \mathcal{A}^\omega)$ is a differential Smarandache manifold by definitions and Theorem 3.3.7. □

3.4.3 Tangent Space on Smarandache manifold. For a smooth differential Smarandache manifold $(M^n, \mathcal{A}^\omega)$, a function $f : M^n \rightarrow \mathbf{R}$ is said smooth if for $\forall p \in M^n$ with a chart (U_p, φ_p) ,

$$f \circ (\varphi_p^\omega)^{-1} : \varphi_p^\omega(U_p) \rightarrow \mathbf{R}^n$$

is smooth. Denote all such C^∞ functions at a point $p \in M^n$ by \mathfrak{S}_p . A tangent vector \vec{v} at p is a mapping $\vec{v} : \mathfrak{S}_p \rightarrow \mathbf{R}$ with conditions following hold.

- (1) $\forall g, h \in \mathfrak{S}_p, \forall \lambda \in \mathbf{R}, \vec{v}(h + \lambda h) = \vec{v}(g) + \lambda \vec{v}(h)$;
- (2) $\forall g, h \in \mathfrak{S}_p, \vec{v}(gh) = \vec{v}(g)h(p) + g(p)\vec{v}(h)$.

Denote all tangent vectors at a point $p \in (M^n, \mathcal{A}^\omega)$ still by T_pM^n without ambiguous and define addition “+” and scalar multiplication “ \cdot ” for $\forall u, v \in T_pM^n, \lambda \in \mathbf{R}$ and $f \in \mathfrak{S}_p$ by

$$(u + v)(f) = u(f) + v(f), \quad (\lambda u)(f) = \lambda \cdot u(f).$$

Then it can be shown immediately that T_pM^n is a vector space under these two operations “+” and “ \cdot ”.

Let $p \in (M^n, \mathcal{A}^\omega)$ and $\gamma : (-\varepsilon, \varepsilon) \rightarrow \mathbf{R}^n$ be a smooth curve in \mathbf{R}^n with $\gamma(0) = p$. In $(M^n, \mathcal{A}^\omega)$, there are four possible cases for tangent vectors on γ at the point p , such as those shown in Fig.3.4.1, in where these L-L represent tangent lines.

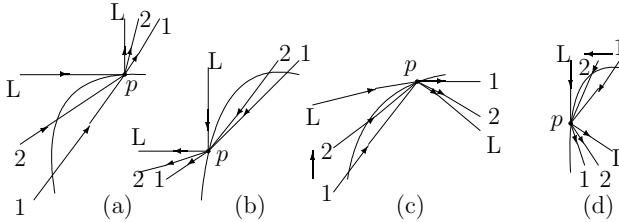

Fig.3.4.1

By these positions of tangent lines at a point p on γ , we conclude that there is one tangent line at a point p on a smooth curve if and only if p is Euclidean in $(M^n, \mathcal{A}^\omega)$. This result enables us to get the dimensional number of a tangent vector space T_pM^n at a point $p \in (M^n, \mathcal{A}^\omega)$.

Theorem 3.4.2 For a point $p \in (M^n, \mathcal{A}^\omega)$ with a local chart (U_p, φ_p) , if there are exactly s Euclidean directions along $\bar{\epsilon}_{i_1}, \bar{\epsilon}_{i_2}, \dots, \bar{\epsilon}_{i_s}$ for p , then the dimension of T_pM^n is

$$\dim T_pM^n = 2n - s$$

with a basis

$$\left\{ \frac{\partial}{\partial x^{i_j}} \Big|_p \mid 1 \leq j \leq s \right\} \cup \left\{ \frac{\partial^-}{\partial x^l} \Big|_p, \frac{\partial^+}{\partial x^l} \Big|_p \mid 1 \leq l \leq n \text{ and } l \neq i_j, 1 \leq j \leq s \right\}.$$

Proof We only need to prove that

$$\left\{ \frac{\partial}{\partial x^{ij}} \Big|_p \mid 1 \leq j \leq s \right\} \cup \left\{ \frac{\partial^-}{\partial x^l}, \frac{\partial^+}{\partial x^l} \Big|_p \mid 1 \leq l \leq n \text{ and } l \neq i_j, 1 \leq j \leq s \right\} \quad (3.4.1)$$

is a basis of $T_p M^n$. For $\forall f \in \mathfrak{F}_p$, since f is smooth, we know that

$$\begin{aligned} f(x) &= f(p) + \sum_{i=1}^n (x_i - x_i^0) \frac{\partial^{\epsilon_i} f}{\partial x_i}(p) \\ &+ \sum_{i,j=1}^n (x_i - x_i^0)(x_j - x_j^0) \frac{\partial^{\epsilon_i} f}{\partial x_i} \frac{\partial^{\epsilon_j} f}{\partial x_j} + R_{i,j,\dots,k} \end{aligned}$$

for $\forall x = (x_1, x_2, \dots, x_n) \in \varphi_p(U_p)$ by the Taylor formula in \mathbf{R}^n , where each term in $R_{i,j,\dots,k}$ contains $(x_i - x_i^0)(x_j - x_j^0) \cdots (x_k - x_k^0)$, $\epsilon_l \in \{+, -\}$ for $1 \leq l \leq n$ but $l \neq i_j$ for $1 \leq j \leq s$ and ϵ_l should be deleted for $l = i_j, 1 \leq j \leq s$.

Now let $v \in T_p M^n$. By the condition (1) of definition of tangent vector at a point $p \in (M^n, \mathcal{A}^w)$, we get that

$$\begin{aligned} v(f(x)) &= v(f(p)) + v\left(\sum_{i=1}^n (x_i - x_i^0) \frac{\partial^{\epsilon_i} f}{\partial x_i}(p)\right) \\ &+ v\left(\sum_{i,j=1}^n (x_i - x_i^0)(x_j - x_j^0) \frac{\partial^{\epsilon_i} f}{\partial x_i} \frac{\partial^{\epsilon_j} f}{\partial x_j}\right) + v(R_{i,j,\dots,k}). \end{aligned}$$

Similarly, application of the condition (2) in definition of tangent vector at a point $p \in (M^n, \mathcal{A}^w)$ shows that

$$\begin{aligned} v(f(p)) &= 0, \quad \sum_{i=1}^n v(x_i^0) \frac{\partial^{\epsilon_i} f}{\partial x_i}(p) = 0, \\ v\left(\sum_{i,j=1}^n (x_i - x_i^0)(x_j - x_j^0) \frac{\partial^{\epsilon_i} f}{\partial x_i} \frac{\partial^{\epsilon_j} f}{\partial x_j}\right) &= 0 \end{aligned}$$

and

$$v(R_{i,j,\dots,k}) = 0.$$

Whence, we get that

$$v(f(x)) = \sum_{i=1}^n v(x_i) \frac{\partial^{\epsilon_i} f}{\partial x_i}(p) = \sum_{i=1}^n v(x_i) \frac{\partial^{\epsilon_i}}{\partial x_i} \Big|_p (f). \quad (3.4.2)$$

The formula (3.4.2) shows that any tangent vector v in $T_p M^n$ can be spanned by elements in the set (3.4.1).

All elements in the set (3.4.1) are linearly independent. Otherwise, if there are numbers $a^1, a^2, \dots, a^s, a_1^+, a_1^-, a_2^+, a_2^-, \dots, a_{n-s}^+, a_{n-s}^-$ such that

$$\sum_{j=1}^s a_{i_j} \frac{\partial}{\partial x_{i_j}} + \sum_{i \neq i_1, i_2, \dots, i_s, 1 \leq i \leq n} a_i^{\epsilon_i} \frac{\partial^{\epsilon_i}}{\partial x_i} \Big|_p = 0,$$

where $\epsilon_i \in \{+, -\}$, then we get that

$$a_{i_j} = \left(\sum_{j=1}^s a_{i_j} \frac{\partial}{\partial x_{i_j}} + \sum_{i \neq i_1, i_2, \dots, i_s, 1 \leq i \leq n} a_i^{\epsilon_i} \frac{\partial^{\epsilon_i}}{\partial x_i} \right) (x_{i_j}) = 0$$

for $1 \leq j \leq s$ and

$$a_i^{\epsilon_i} = \left(\sum_{j=1}^s a_{i_j} \frac{\partial}{\partial x_{i_j}} + \sum_{i \neq i_1, i_2, \dots, i_s, 1 \leq i \leq n} a_i^{\epsilon_i} \frac{\partial^{\epsilon_i}}{\partial x_i} \right) (x_i) = 0$$

for $i \neq i_1, i_2, \dots, i_s, 1 \leq i \leq n$. Therefore, vectors in the set (3.4.1) is a basis of the tangent vector space $T_p M^n$ at the point $p \in (M^n, \mathcal{A}^\omega)$. \square

Notice that $\dim T_p M^n = n$ in Theorem 3.4.2 if and only if all these directions are Euclidean along $\bar{\epsilon}_1, \bar{\epsilon}_2, \dots, \bar{\epsilon}_n$. We get a consequence by Theorem 3.4.2.

Corollary 3.4.1 *Let (M^n, \mathcal{A}) be a smooth manifold and $p \in M^n$. Then*

$$\dim T_p M^n = n$$

with a basis

$$\left\{ \frac{\partial}{\partial x^i} \Big|_p \mid 1 \leq i \leq n \right\}.$$

For $\forall p \in (M^n, \mathcal{A}^\omega)$, the dual space $T_p^* M^n$ is called a *co-tangent vector space* at p . Now let $f \in \mathfrak{S}_p, d \in T_p^* M^n$ and $v \in T_p M^n$. The action of d on f , called a differential operator $d : \mathfrak{S}_p \rightarrow \mathbf{R}$, is defined by

$$df = v(f).$$

Then, we can immediately get the result on its basis of co-tangent vector space at a point $p \in (M^n, \mathcal{A}^\omega)$ similar to Theorem 3.4.2.

Theorem 3.4.3 *For any point $p \in (M^n, \mathcal{A}^\omega)$ with a local chart (U_p, φ_p) , if there are exactly s Euclidean directions along $\bar{\epsilon}_{i_1}, \bar{\epsilon}_{i_2}, \dots, \bar{\epsilon}_{i_s}$ for p , then the dimension of $T_p^*M^n$ is*

$$\dim T_p^*M^n = 2n - s$$

with a basis

$$\{dx_{i_j}|_p \mid 1 \leq j \leq s\} \cup \{d^-x_l|_p, d^+x_l|_p \mid 1 \leq l \leq n \text{ and } l \neq i_j, 1 \leq j \leq s\},$$

where

$$dx_i|_p \left(\frac{\partial}{\partial x_j} \Big|_p \right) = \delta_j^i \quad \text{and} \quad d^{\epsilon_i}x_i|_p \left(\frac{\partial^{\epsilon_i}}{\partial x_j} \Big|_p \right) = \delta_j^i$$

for $\epsilon_i \in \{+, -\}, 1 \leq i \leq n$.

§3.5 PSEUDO-MANIFOLD GEOMETRY

Similar to the approach in Finsler geometry, we introduce *Minkowskian norms* on these pseudo-manifolds $(M^n, \mathcal{A}^\omega)$ following.

Definition 3.5.1 *A Minkowskian norm on a vector space V is a function $F : V \rightarrow \mathbf{R}$ such that*

- (1) F is smooth on $V \setminus \{0\}$ and $F(v) \geq 0$ for $\forall v \in V$;
- (2) F is 1-homogenous, i.e., $F(\lambda v) = \lambda F(v)$ for $\forall \lambda > 0$;
- (3) for all $y \in V \setminus \{0\}$, the symmetric bilinear form $g_y : V \times V \rightarrow \mathbf{R}$ with

$$g_y(u, v) = \sum_{i,j} \frac{\partial^2 F(y)}{\partial y^i \partial y^j}$$

is positive definite for $u, v \in V$.

Denote by $TM^n = \bigcup_{p \in (M^n, \mathcal{A}^\omega)} T_pM^n$.

Definition 3.5.2 *A pseudo-manifold geometry is a pseudo-manifold $(M^n, \mathcal{A}^\omega)$ endowed with a Minkowskian norm F on TM^n .*

Then we get the following result.

Theorem 3.5.1 *There are pseudo-manifold geometries.*

Proof Consider a Euclidean $2n$ -dimensional space \mathbf{R}^{2n} . Then there exists a Minkowskian norm $F(\bar{x}) = |\bar{x}|$ at least. According to Theorem 3.4.2, the dimension of $T_p M^n$ is $\mathbf{R}^{s+2(n-s)}$ if $\omega|_{\mathcal{O}(p)}$ exactly has s Euclidean directions along $\bar{\epsilon}_1, \bar{\epsilon}_2, \dots, \bar{\epsilon}_n$. Whence there are Minkowskian norms on each chart of points in $(M^n, \mathcal{A}^\omega)$.

Since (M^n, \mathcal{A}) has a finite cover $\{(U_\alpha, \varphi_\alpha) | \alpha \in I\}$, where I is a finite index set, by the decomposition theorem for unit, we know that there are smooth functions $h_\alpha, \alpha \in I$ such that

$$\sum_{\alpha \in I} h_\alpha = 1 \text{ with } 0 \leq h_\alpha \leq 1.$$

Choose a Minkowskian norm F^α on each chart $(U_\alpha, \varphi_\alpha)$. Define

$$F_\alpha = \begin{cases} h_\alpha F^\alpha, & \text{if } p \in U_\alpha, \\ 0, & \text{if } p \notin U_\alpha \end{cases}$$

for $\forall p \in (M^n, \varphi^\omega)$. Now let

$$F = \sum_{\alpha \in I} F_\alpha.$$

Then F is a Minkowskian norm on TM^n since it satisfies all of these conditions (1) – (3) in Definition 3.5.1. \square

Although the dimension of each tangent vector space maybe different, we can also introduce *principal fiber bundles* and *connections* on pseudo-manifolds.

Definition 3.5.3 *A principal fiber bundle (PFB) consists of a pseudo-manifold $(P, \mathcal{A}_1^\omega)$, a projection $\pi : (P, \mathcal{A}_1^\omega) \rightarrow (M, \mathcal{A}_0^{\pi(\omega)})$, a base pseudo-manifold $(M, \mathcal{A}_0^{\pi(\omega)})$ and a Lie group G , which is a manifold with group operation $G \times G \rightarrow G$ given by $(g, h) \rightarrow g \circ h$ being C^∞ mapping, denoted by (P, M, ω^π, G) such that (1), (2) and (3) following hold.*

(1) *There is a right freely action of G on $(P, \mathcal{A}_1^\omega)$, i.e., for $\forall g \in G$, there is a diffeomorphism $R_g : (P, \mathcal{A}_1^\omega) \rightarrow (P, \mathcal{A}_1^\omega)$ with $R_g(p^\omega) = p^\omega g$ for $\forall p \in (P, \mathcal{A}_1^\omega)$ such that $p^\omega(g_1 g_2) = (p^\omega g_1) g_2$ for $\forall p \in (P, \mathcal{A}_1^\omega)$, $\forall g_1, g_2 \in G$ and $p^\omega e = p^\omega$ for some $p \in (P^n, \mathcal{A}_1^\omega)$, $e \in G$ if and only if e is the identity element of G .*

(2) The map $\pi : (P, \mathcal{A}_1^\omega) \rightarrow (M, \mathcal{A}_0^{\pi(\omega)})$ is onto with $\pi^{-1}(\pi(p)) = \{pg|g \in G\}$, $\pi\omega_1 = \omega_0\pi$, and regular on spatial directions of p , i.e., if the spatial directions of p are $(\omega_1, \omega_2, \dots, \omega_n)$, then ω_i and $\pi(\omega_i)$ are both elliptic, or Euclidean, or hyperbolic and $|\pi^{-1}(\pi(\omega_i))|$ is a constant number independent of p for any integer $i, 1 \leq i \leq n$.

(3) For $\forall x \in (M, \mathcal{A}_0^{\pi(\omega)})$ there is an open set U with $x \in U$ and a diffeomorphism $T_u^{\pi(\omega)} : (\pi)^{-1}(U^{\pi(\omega)}) \rightarrow U^{\pi(\omega)} \times G$ of the form $T_u(p) = (\pi(p^\omega), s_u(p^\omega))$, where $s_u : \pi^{-1}(U^{\pi(\omega)}) \rightarrow G$ has the property $s_u(p^\omega g) = s_u(p^\omega)g$ for $\forall g \in G, p \in \pi^{-1}(U)$.

We know the following result for principal fiber bundles of pseudo-manifolds.

Theorem 3.5.2 *Let (P, M, ω^π, G) be a PFB. Then*

$$(P, M, \omega^\pi, G) = (P, M, \pi, G)$$

if and only if all points in pseudo-manifolds $(P, \mathcal{A}_1^\omega)$ are Euclidean.

Proof For $\forall p \in (P, \mathcal{A}_1^\omega)$, let (U_p, φ_p) be a chart at p . Notice that $\omega^\pi = \pi$ if and only if $\varphi_p^\omega = \varphi_p$ for $\forall p \in (P, \mathcal{A}_1^\omega)$. According to Theorem 3.3.6, this is equivalent to that all points in $(P, \mathcal{A}_1^\omega)$ are Euclidean. □

Definition 3.5.4 *Let (P, M, ω^π, G) be a PFB with $\dim G = r$. A subspace family $H = \{H_p|p \in (P, \mathcal{A}_1^\omega), \dim H_p = \dim T_{\pi(p)}M\}$ of TP is called a connection if conditions (1) and (2) following hold.*

(1) For $\forall p \in (P, \mathcal{A}_1^\omega)$, there is a decomposition

$$T_pP = H_p \oplus V_p$$

and the restriction $\pi_|_{H_p} : H_p \rightarrow T_{\pi(p)}M$ is a linear isomorphism.*

(2) H is invariant under the right action of G , i.e., for $p \in (P, \mathcal{A}_1^\omega), \forall g \in G$,

$$(R_g)_*p(H_p) = H_{pg}.$$

Similar to Theorem 3.5.2, the conception of connection introduced in Definition 3.5.4 is more general than the popular connection on principal fiber bundles.

Theorem 3.5.3 *Let (P, M, ω^π, G) be a PFB with a connection H . For $\forall p \in (P, \mathcal{A}_1^\omega)$, if the number of Euclidean directions of p is $\lambda_P(p)$, then*

$$\dim V_p = \frac{(\dim P - \dim M)(2\dim P - \lambda_P(p))}{\dim P}.$$

Proof Assume these Euclidean directions of the point p being $\bar{\epsilon}_1, \bar{\epsilon}_2, \dots, \bar{\epsilon}_{\lambda_P(p)}$. By definition π is regular, we know that $\pi(\bar{\epsilon}_1), \pi(\bar{\epsilon}_2), \dots, \pi(\bar{\epsilon}_{\lambda_P(p)})$ are also Euclidean in $(M, \mathcal{A}_1^{\pi(\omega)})$. Now since

$$\pi^{-1}(\pi(\bar{\epsilon}_1)) = \pi^{-1}(\pi(\bar{\epsilon}_2)) = \dots = \pi^{-1}(\pi(\bar{\epsilon}_{\lambda_P(p)})) = \mu = \text{constant},$$

we get that $\lambda_P(p) = \mu \lambda_M$, where λ_M denotes the correspondent Euclidean directions in $(M, \mathcal{A}_1^{\pi(\omega)})$. Similarly, consider all directions of the point p , we also get that $\dim P = \mu \dim M$. Thereafter

$$\lambda_M = \frac{\dim M}{\dim P} \lambda_P(p). \quad (3.5.1)$$

Now by Definition 3.5.4, $T_p P = H_p \oplus V_p$, i.e.,

$$\dim T_p P = \dim H_p + \dim V_p. \quad (3.5.2)$$

Since $\pi_*|_{H_p} : H_p \rightarrow T_{\pi(p)} M$ is a linear isomorphism, we know that $\dim H_p = \dim T_{\pi(p)} M$. According to Theorem 3.4.2, we get formulae

$$\dim T_p P = 2\dim P - \lambda_P(p)$$

and

$$\dim T_{\pi(p)} M = 2\dim M - \lambda_M = 2\dim M - \frac{\dim M}{\dim P} \lambda_P(p).$$

Now replacing these two formulae into (3.5.2), we get that

$$2\dim P - \lambda_P(p) = 2\dim M - \frac{\dim M}{\dim P} \lambda_P(p) + \dim V_p.$$

That is,

$$\dim V_p = \frac{(\dim P - \dim M)(2\dim P - \lambda_P(p))}{\dim P}.$$

□

We immediately get the following consequence by Theorem 3.5.3.

Corollary 3.5.1 *Let (P, M, ω^π, G) be a PFB with a connection H . Then for $\forall p \in (P, \mathcal{A}_1^\omega)$,*

$$\dim V_p = \dim P - \dim M$$

if and only if the point p is Euclidean.

Now we consider conclusions included in Smarandache geometries, particularly in pseudo-manifold geometries.

Theorem 3.5.4 *A pseudo-manifold geometry (M^n, φ^ω) with a Minkowskian norm on TM^n is a Finsler geometry if and only if all points of (M^n, φ^ω) are Euclidean.*

Proof According to Theorem 3.3.6, $\varphi_p^\omega = \varphi_p$ for $\forall p \in (M^n, \varphi^\omega)$ if and only if p is Euclidean. Whence, by definition (M^n, φ^ω) is a Finsler geometry if and only if all points of (M^n, φ^ω) are Euclidean. \square

Corollary 3.5.2 *There are inclusions among Smarandache geometries, Finsler geometry, Riemann geometry and Weyl geometry:*

$$\begin{aligned} \{Smarandache\ geometries\} &\supset \{pseudo\text{-manifold}\ geometries\} \\ &\supset \{Finsler\ geometry\} \supset \{Riemann\ geometry\} \supset \{Weyl\ geometry\}. \end{aligned}$$

Proof The first and second inclusions are implied in Theorems 3.3.6 and 3.5.3. Other inclusions are known in a textbook, such as [ChC1] and [ChL1]. \square

Now let us to consider complex manifolds. Let $z^i = x^i + \sqrt{-1}y^i$. In fact, any complex manifold M_c^n is equal to a smooth real manifold M^{2n} with a natural base $\{\frac{\partial}{\partial x^i}, \frac{\partial}{\partial y^i}\}$ for $T_p M_c^n$ at each point $p \in M_c^n$. Define a *Hermite* manifold M_c^n to be a manifold M_c^n endowed with a Hermite inner product $h(p)$ on the tangent space $(T_p M_c^n, J)$ for $\forall p \in M_c^n$, where J is a mapping defined by

$$J\left(\frac{\partial}{\partial x^i}\Big|_p\right) = \frac{\partial}{\partial y^i}\Big|_p, \quad J\left(\frac{\partial}{\partial y^i}\Big|_p\right) = -\frac{\partial}{\partial x^i}\Big|_p$$

at each point $p \in M_c^n$ for any integer $i, 1 \leq i \leq n$. Now let

$$h(p) = g(p) + \sqrt{-1}\kappa(p), \quad p \in M_c^m.$$

Then a *Kähler manifold* is defined to be a Hermite manifold (M_c^n, h) with a closed κ satisfying

$$\kappa(X, Y) = g(X, JY), \quad \forall X, Y \in T_p M_c^n, \forall p \in M_c^n.$$

Similar to Theorem 3.5.3 for real manifolds, we know the next result.

Theorem 3.5.5 *A pseudo-manifold geometry (M_c^n, φ^ω) with a Minkowskian norm on TM^n is a Kähler geometry if and only if F is a Hermite inner product on M_c^n with all points of (M^n, φ^ω) being Euclidean.*

Proof Notice that a complex manifold M_c^n is equal to a real manifold M^{2n} . Similar to the proof of Theorem 3.5.3, we get the claim. \square

As a immediately consequence, we get the following inclusions in Smarandache geometries.

Corollary 3.5.3 *There are inclusions among Smarandache geometries, pseudo-manifold geometry and Kähler geometry:*

$$\begin{aligned} \{ \text{Smarandache geometries} \} &\supset \{ \text{pseudo-manifold geometries} \} \\ &\supset \{ \text{Kähler geometry} \}. \end{aligned}$$

§3.6 REMARKS

3.6.1 These Smarandache geometries were proposed by Smarandache in 1969 by contradicts axioms (E1) – (E5) in a Euclid geometry, such as those of *paradoxist geometry, non-geometry, counter-projective geometry* and *anti-geometry*, see his paper [Sma2] for details. For example, he asked whether there exists a geometry with axioms (E1) – (E4) and one of the axioms following:

(i) there are at least a straight line and a point exterior to it in this space for which any line that passes through the point intersect the initial line.

(ii) there are at least a straight line and a point exterior to it in this space for which only one line passes through the point and does not intersect the initial line.

(iii) there are at least a straight line and a point exterior to it in this space for which only a finite number of lines $l_1, l_2, \dots, l_k, k \geq 2$ pass through the point and do not intersect the initial line.

(iv) there are at least a straight line and a point exterior to it in this space for which an infinite number of lines pass through the point (but not all of them) and

do not intersect the initial line.

(v) there are at least a straight line and a point exterior to it in this space for which any line that passes through the point and does not intersect the initial line.

A modern definition on Smarandache geometry is formed by Kuciuk and Antholy in [KuA1]. Iseri proved s -manifolds constructed by equilateral triangular disks $T_i, 1 \leq i \leq n$ on the plane can indeed produce the paradoxist geometry, non-geometry, counter-projective geometry and anti-geometry in [Ise1]. For generalizing his idea to surfaces, Mao introduced *map geometry* on combinatorial maps in his postdoctoral report [Mao2], shown that these map geometries also produce these paradoxist geometry, non-geometry, counter-projective geometry and anti-geometry, and then introduced the conception of *pseudo-plane* for general construction of Smarandache geometries on a Euclidean plane in [Mao3].

3.6.2 There are many good monographs and textbooks on topology and differential geometry, such as those of [AbM1], [AMR1], [Arm1], [ChL1], [Mas1], [Mas2], [Pet1], [Rot1], [Sti1], [Wes1] [ChC1] and [ChL1], ..., etc. These materials presented in Sections 1 and 2 are self-contained for this book. Many conceptions in here will be used or generalized to combinatorial manifolds in following chapters.

3.6.3 For constructing Smarandache manifolds of dimensional $n \geq 2$, Mao first constructs Smarandache 2-manifolds by applying combinatorial maps on surfaces, i.e., map geometries in his post-doctoral research in [Mao1-2] and a paper in [Mao4]. Then, he presented a general way for constructing Smarandache manifolds by applying topological or differential n -manifolds in [Mao11-12]. The material in Sections 3.3 – 3.5 is mainly extracted from his paper [Mao12], but with a different handling way. Certainly, there are many open problems in Smarandache geometries arising from an analogizing results in Sections 1 and 2. For example, Theorem 3.3.8 is a such result. The readers are encouraged to find more such results and construct new Smarandache manifolds different from pseudo-manifolds.

Problem 3.6.1 *Define more Smarandache manifolds other than pseudo-manifolds and find their topological and differential behaviors.*

Problem 3.6.2 *Define integrations and then generalize Stokes, Gauss,... theorems on pseudo-manifolds.*

Corollaries 3.5.2 and 3.5.3 are interesting results established in [Mao12], which convince us that Smarandache geometries are indeed a generalization of geometries already existence. [SCF1] and other papers also mentioned these two results for reviewing Mao's work.

Now we consider some well-known results in Riemannian geometry. Let S be an orientable compact surface. Then

$$\int \int_S K d\sigma = 2\pi\chi(S),$$

where K and $\chi(S)$ are the Gauss curvature and Euler characteristic of S . This formula is the well-known Gauss-Bonnet formula in differential geometry on surfaces. Then *what is its counterpart in pseudo-manifold geometries?* This need us to solve problems following.

(1) *Find a suitable definition for curvatures in pseudo-manifold geometries.*

(2) *Find generalizations of the Gauss-Bonnet formula for pseudo-manifold geometries, particularly, for pseudo-surfaces.*

For an oriently compact Riemannian manifold (M^{2p}, g) , let

$$\Omega = \frac{(-1)^p}{2^{2p}\pi^p p!} \sum_{i_1, i_2, \dots, i_{2p}} \delta_{1, \dots, 2p}^{i_1, \dots, i_{2p}} \Omega_{i_1 i_2} \wedge \dots \wedge \Omega_{i_{2p-1} i_{2p}},$$

where Ω_{ij} is the curvature form under the natural chart $\{e_i\}$ of M^{2p} and

$$\delta_{1, \dots, 2p}^{i_1, \dots, i_{2p}} = \begin{cases} 1, & \text{if permutation } i_1 \dots i_{2p} \text{ is even,} \\ -1, & \text{if permutation } i_1 \dots i_{2p} \text{ is odd,} \\ 0, & \text{otherwise.} \end{cases}$$

Chern proved that (see [ChC1] for details)

$$\int_{M^{2p}} \Omega = \chi(M^{2p}).$$

Certainly, these new kind of global formulae for pseudo-manifold geometries are valuable to find.

3.6.4 These principal fiber bundles and connections considered in Section 3.5 are very important in theoretical physics. Physicists have established a gauge theory on principal fiber bundles of Riemannian manifolds, which can be used to unite

gauge fields with gravitation. In section 3.5, we have introduced those on pseudo-manifolds. For applying pseudo-manifolds to physics, similar consideration should induce a new gauge theory, which needs us to solving problems following:

to establish a gauge theory on those of pseudo-manifold geometries with some additional conditions.

In fact, this object requires us to solve problems following:

- (1) find these conditions such that we can establish a gauge theory on pseudo-manifolds;
- (2) find the Yang-Mills equation in a gauge theory on pseudo-manifold;
- (3) unify these gauge fields and gravitation.

CHAPTER 4.

Combinatorial Manifolds

A combinatorial manifold is a topological space consisting of manifolds underlying a combinatorial structure, i.e., a combinatorial system of manifolds. Certainly, it is a Smarandache system and a geometrical multi-space model of our WORLD. For introducing this kind of geometrical spaces, we discuss its topological behavior in this chapter, and then its differential behavior in the following chapters. As a concrete introduction, Section 4.1 presents a calculation on the dimension of combinatorial Euclidean spaces and the decomposition of a Euclidean space with dimension ≥ 4 to combinatorial Euclidean space with lower dimensions. This model can be also used to describe spacetime of dimension ≥ 4 in physics. The combinatorial manifold is introduced in Section 4.2. In this section, these topological properties of combinatorial manifold, such as those of combinatorial submanifold, vertex-edge labeled graphs, combinatorial equivalence, homotopy class and Euler-Poincaré characteristic, \dots , etc. are discussed. Fundamental groups and singular homology groups of combinatorial manifolds are discussed in Sections 4.3 and 4.4, in where these groups are obtained for a few cases by applying some well-known theorems in classical topology. In Section 4.5, the ordinary voltage graph is generalized to voltage labeled graph. Applying voltage labeled graph with its lifting, this section presents a combinatorial construction for regular covering of finitely combinatorial manifolds, which essentially provides for the *principal fibre bundles* in combinatorial differential geometry in chapters following.

§4.1 COMBINATORIAL SPACES

A *combinatorial space* \mathcal{S}_G is a combinatorial system \mathcal{C}_G of geometrical spaces $(\Sigma_1; \mathcal{R}_1), (\Sigma_2; \mathcal{R}_2), \dots, (\Sigma_m; \mathcal{R}_m)$ for an integer m with an underlying graph G in Definition 2.1.3. We concentrated our attention on each $(\Sigma_i; \mathcal{R}_i)$ being a Euclidean space for integers $i, 1 \leq i \leq m$ in this section.

4.1.1 Combinatorial Euclidean Space. A *combinatorial Euclidean space* is a combinatorial system \mathcal{C}_G of Euclidean spaces $\mathbf{R}^{n_1}, \mathbf{R}^{n_2}, \dots, \mathbf{R}^{n_m}$ with an underlying structure G , denoted by $\mathcal{E}_G(n_1, \dots, n_m)$ and abbreviated to $\mathcal{E}_G(r)$ if $n_1 = \dots = n_m = r$. It is itself a Euclidean space \mathbf{R}^{n_c} . Whence, it is natural to give rise to a packing problem on Euclidean spaces following.

Parking Problem *Let $\mathbf{R}^{n_1}, \mathbf{R}^{n_2}, \dots, \mathbf{R}^{n_m}$ be Euclidean spaces. In what conditions do they consist of a combinatorial Euclidean space $\mathcal{E}_G(n_1, \dots, n_m)$?*

By our intuition, this parking problem is related with the dimensions of $\mathbf{R}^{n_1}, \mathbf{R}^{n_2}, \dots, \mathbf{R}^{n_m}$, also with their combinatorial structure G . Notice that a Euclidean space \mathbf{R}^n is an n -dimensional vector space with a normal basis $\bar{\epsilon}_1 = (1, 0, \dots, 0), \bar{\epsilon}_2 = (0, 1, 0, \dots, 0), \dots, \bar{\epsilon}_n = (0, \dots, 0, 1)$, namely, it has n orthogonal orientations. So if we think any Euclidean space \mathbf{R}^n is a subspace of a Euclidean space \mathbf{R}^{n_∞} with a finite but sufficiently large dimension n_∞ , then two Euclidean spaces \mathbf{R}^{n_u} and \mathbf{R}^{n_v} have a non-empty intersection if and only if they have common orientations. Whence, we only need to determine the number of different orthogonal orientations in $\mathcal{E}_G(n_1, \dots, n_m)$.

Denoted by $X_{v_1}, X_{v_2}, \dots, X_{v_m}$ consist of these orthogonal orientations in $\mathbf{R}^{n_{v_1}}, \mathbf{R}^{n_{v_2}}, \dots, \mathbf{R}^{n_{v_m}}$, respectively. An intersection graph $G[X_{v_1}, X_{v_2}, \dots, X_{v_m}]$ of $X_{v_1}, X_{v_2}, \dots, X_{v_m}$ is defined by

$$V(G[X_{v_1}, X_{v_2}, \dots, X_{v_m}]) = \{v_1, v_2, \dots, v_m\},$$

$$E[X_{v_1}, X_{v_2}, \dots, X_{v_m}] = \{(v_i, v_j) | X_{v_i} \cap X_{v_j} \neq \emptyset, 1 \leq i \neq j \leq m\}.$$

By definition, we can easily find that

$$G \cong G[X_{v_1}, X_{v_2}, \dots, X_{v_m}].$$

So we can apply properties of the intersection graph G to the parking problem

$\mathcal{E}_G(n_1, \dots, n_m)$ of $\mathbf{R}^{n_1}, \mathbf{R}^{n_2}, \dots, \mathbf{R}^{n_m}$, which transfers the parking problem of Euclidean spaces to a combinatorial problem following.

Intersection Problem For given integers $\kappa, m \geq 2$ and n_1, n_2, \dots, n_m , find finite sets Y_1, Y_2, \dots, Y_m with their intersection graph being G such that $|Y_i| = n_i, 1 \leq i \leq m$, and $|Y_1 \cup Y_2 \cup \dots \cup Y_m| = \kappa$.

This enables us to find solutions of the parking problem sometimes.

Theorem 4.1.1 Let $\mathcal{E}_G(n_1, \dots, n_m)$ be a combinatorial Euclidean space of $\mathbf{R}^{n_1}, \mathbf{R}^{n_2}, \dots, \mathbf{R}^{n_m}$ with an underlying structure G . Then

$$\dim \mathcal{E}_G(n_1, \dots, n_m) = \sum_{\langle v_i \in V(G) | 1 \leq i \leq s \rangle \in CL_s(G)} (-1)^{s+1} \dim(\mathbf{R}^{n_{v_1}} \cap \mathbf{R}^{n_{v_2}} \cap \dots \cap \mathbf{R}^{n_{v_s}}),$$

where n_{v_i} denotes the dimensional number of the Euclidean space in $v_i \in V(G)$ and $CL_s(G)$ consists of all complete graphs of order s in G .

Proof By definition, $\mathbf{R}^{n_u} \cap \mathbf{R}^{n_v} \neq \emptyset$ only if there is an edge $(\mathbf{R}^{n_u}, \mathbf{R}^{n_v})$ in G . This condition can be generalized to a more general situation, i.e., $\mathbf{R}^{n_{v_1}} \cap \mathbf{R}^{n_{v_2}} \cap \dots \cap \mathbf{R}^{n_{v_l}} \neq \emptyset$ only if $\langle v_1, v_2, \dots, v_l \rangle_G \cong K_l$.

In fact, if $\mathbf{R}^{n_{v_1}} \cap \mathbf{R}^{n_{v_2}} \cap \dots \cap \mathbf{R}^{n_{v_l}} \neq \emptyset$, then $\mathbf{R}^{n_{v_i}} \cap \mathbf{R}^{n_{v_j}} \neq \emptyset$, which implies that $(\mathbf{R}^{n_{v_i}}, \mathbf{R}^{n_{v_j}}) \in E(G)$ for any integers $i, j, 1 \leq i, j \leq l$. Therefore, $\langle v_1, v_2, \dots, v_l \rangle_G$ is a complete graph of order l in the intersection graph G .

Now we are needed to count these orthogonal orientations in $\mathcal{E}_G(n_1, \dots, n_m)$. In fact, the number of different orthogonal orientations is

$$\dim \mathcal{E}_G(n_1, \dots, n_m) = \dim\left(\bigcup_{v \in V(G)} \mathbf{R}^{n_v}\right)$$

by previous discussion. Applying Theorem 1.5.1 the inclusion-exclusion principle, we find that

$$\begin{aligned} \dim \mathcal{E}_G(n_1, \dots, n_m) &= \dim\left(\bigcup_{v \in V(G)} \mathbf{R}^{n_v}\right) \\ &= \sum_{\{v_1, \dots, v_s\} \subset V(G)} (-1)^{s+1} \dim(\mathbf{R}^{n_{v_1}} \cap \mathbf{R}^{n_{v_2}} \cap \dots \cap \mathbf{R}^{n_{v_s}}) \\ &= \sum_{\langle v_i \in V(G) | 1 \leq i \leq s \rangle \in CL_s(G)} (-1)^{s+1} \dim(\mathbf{R}^{n_{v_1}} \cap \mathbf{R}^{n_{v_2}} \cap \dots \cap \mathbf{R}^{n_{v_s}}). \end{aligned}$$

□

Notice that $\dim(\mathbf{R}^{n_{v_1}} \cap \mathbf{R}^{n_{v_2}} \cap \cdots \cap \mathbf{R}^{n_{v_s}}) = n_{v_1}$ if $s = 1$ and $\dim(\mathbf{R}^{n_{v_1}} \cap \mathbf{R}^{n_{v_2}}) \neq 0$ only if $(\mathbf{R}^{n_{v_1}}, \mathbf{R}^{n_{v_2}}) \in E(G)$. We get a more applicable formula for calculating $\dim \mathcal{E}_G(n_1, \dots, n_m)$ on K_3 -free graphs G by Theorem 4.1.1.

Corollary 4.1.1 *If G is K_3 -free, then*

$$\dim \mathcal{E}_G(n_1, \dots, n_m) = \sum_{v \in V(G)} n_v - \sum_{(u,v) \in E(G)} \dim(\mathbf{R}^{n_u} \cap \mathbf{R}^{n_v}).$$

Particularly, if $G = v_1 v_2 \cdots v_m$ a circuit for an integer $m \geq 4$, then

$$\dim \mathcal{E}_G(n_1, \dots, n_m) = \sum_{i=1}^m n_{v_i} - \sum_{i=1}^m \dim(\mathbf{R}^{n_{v_i}} \cap \mathbf{R}^{n_{v_{i+1}}}),$$

where each index is modulo m .

Now we determine the maximum and minimum dimension of combinatorial Euclidean spaces of $\mathbf{R}^{n_1}, \mathbf{R}^{n_2}, \dots, \mathbf{R}^{n_m}$ with an underlying structure G .

Theorem 4.1.2 *Let $\mathcal{E}_G(n_{v_1}, \dots, n_{v_m})$ be a combinatorial Euclidean space of $\mathbf{R}^{n_{v_1}}, \mathbf{R}^{n_{v_2}}, \dots, \mathbf{R}^{n_{v_m}}$ with an underlying graph $G, V(G) = \{v_1, v_2, \dots, v_m\}$. Then the maximum dimension $\dim_{\max} \mathcal{E}_G(n_{v_1}, \dots, n_{v_m})$ of $\mathcal{E}_G(n_{v_1}, \dots, n_{v_m})$ is*

$$\dim_{\max} \mathcal{E}_G(n_{v_1}, \dots, n_{v_m}) = 1 - m + \sum_{v \in V(G)} n_v$$

with conditions $\dim(\mathbf{R}^{n_u} \cap \mathbf{R}^{n_v}) = 1$ for $\forall (u, v) \in E(G)$.

Proof Let $X_{v_1}, X_{v_2}, \dots, X_{v_m}$ consist of these orthogonal orientations in $\mathbf{R}^{n_{v_1}}, \mathbf{R}^{n_{v_2}}, \dots, \mathbf{R}^{n_{v_m}}$, respectively. Notice that

$$|X_{v_i} \cup X_{v_j}| = |X_{v_i}| + |X_{v_j}| - |X_{v_i} \cap X_{v_j}|$$

for $1 \leq i \neq j \leq m$ by Theorem 1.5.1 in the case of $n = 2$. We immediately know that $|X_{v_i} \cup X_{v_j}|$ attains its maximum value only if $|X_{v_i} \cap X_{v_j}|$ is minimum. Since X_{v_i} and X_{v_j} are nonempty sets, we find that the minimum value of $|X_{v_i} \cap X_{v_j}| = 1$ if $(v_i, v_j) \in E(G)$.

We finish our proof by the inductive principle. Not loss of generality, assume $(v_1, v_2) \in E(G)$. Then we have known that $|X_{v_1} \cup X_{v_2}|$ attains its maximum

$$|X_{v_1}| + |X_{v_2}| - 1$$

only if $|X_{v_1} \cap X_{v_2}| = 1$. Since G is connected, not loss of generality, let v_3 be adjacent

with $\{v_1, v_2\}$ in G . Then by

$$|X_{v_1} \cup X_{v_2} \cup X_{v_3}| = |X_{v_1} \cup X_{v_2}| + |X_{v_3}| - |(X_{v_1} \cup X_{v_2}) \cap X_{v_3}|,$$

we know that $|X_{v_1} \cup X_{v_2} \cup X_{v_3}|$ attains its maximum value only if $|X_{v_1} \cup X_{v_2}|$ attains its maximum and $|(X_{v_1} \cup X_{v_2}) \cap X_{v_3}| = 1$ for $(X_{v_1} \cup X_{v_2}) \cap X_{v_3} \neq \emptyset$. Whence, $|X_{v_1} \cap X_{v_3}| = 1$ or $|X_{v_2} \cap X_{v_3}| = 1$, or both. In the later case, there must be $|X_{v_1} \cap X_{v_2} \cap X_{v_3}| = 1$. Therefore, the maximum value of $|X_{v_1} \cup X_{v_2} \cup X_{v_3}|$ is

$$|X_{v_1}| + |X_{v_2}| + |X_{v_3}| - 2.$$

Generally, we assume the maximum value of $|X_{v_1} \cup X_{v_2} \cup \dots \cup X_{v_k}|$ to be

$$|X_{v_1}| + |X_{v_2}| + \dots + |X_{v_k}| - k + 1$$

for an integer $k \leq m$ with conditions $|X_{v_i} \cap X_{v_j}| = 1$ hold if $(v_i, v_j) \in E(G)$ for $1 \leq i \neq j \leq k$. By the connectedness of G , without loss of generality, we choose a vertex v_{k+1} adjacent with $\{v_1, v_2, \dots, v_k\}$ in G and find out the maximum value of $|X_{v_1} \cup X_{v_2} \cup \dots \cup X_{v_k} \cup X_{v_{k+1}}|$. In fact, since

$$\begin{aligned} |X_{v_1} \cup X_{v_2} \cup \dots \cup X_{v_k} \cup X_{v_{k+1}}| &= |X_{v_1} \cup X_{v_2} \cup \dots \cup X_{v_k}| + |X_{v_{k+1}}| \\ &\quad - |(X_{v_1} \cup X_{v_2} \cup \dots \cup X_{v_k}) \cap X_{v_{k+1}}|, \end{aligned}$$

we know that $|X_{v_1} \cup X_{v_2} \cup \dots \cup X_{v_k} \cup X_{v_{k+1}}|$ attains its maximum value only if $|X_{v_1} \cup X_{v_2} \cup \dots \cup X_{v_k}|$ attains its maximum and $|(X_{v_1} \cup X_{v_2} \cup \dots \cup X_{v_k}) \cap X_{v_{k+1}}| = 1$ for $(X_{v_1} \cup X_{v_2} \cup \dots \cup X_{v_k}) \cap X_{v_{k+1}} \neq \emptyset$. Whence, $|X_{v_i} \cap X_{v_{k+1}}| = 1$ if $(v_i, v_{k+1}) \in E(G)$. Consequently, we find that the maximum value of $|X_{v_1} \cup X_{v_2} \cup \dots \cup X_{v_k} \cup X_{v_{k+1}}|$ is

$$|X_{v_1}| + |X_{v_2}| + \dots + |X_{v_k}| + |X_{v_{k+1}}| - k.$$

Notice that our process searching for the maximum value of $|X_{v_1} \cup X_{v_2} \cup \dots \cup X_{v_k}|$ does not alter the intersection graph G of $X_{v_1}, X_{v_2}, \dots, X_{v_m}$. Whence, by the inductive principle we finally get the maximum dimension $\dim_{max} \mathcal{E}_G$ of \mathcal{E}_G , that is,

$$\dim_{max} \mathcal{E}_G(n_{v_1}, \dots, n_{v_m}) = 1 - m + n_1 + n_2 + \dots + n_m$$

with conditions $\dim(\mathbf{R}^{n_u} \cap \mathbf{R}^{n_v}) = 1$ for $\forall(u, v) \in E(G)$. \square

Determining the minimum value $\dim_{\min} \mathcal{E}_G(n_1, \dots, n_m)$ of $\mathcal{E}_G(n_1, \dots, n_m)$ is a difficult problem in general case. But we can still get it for some graph families.

Theorem 4.1.3 *Let $\mathcal{E}_G(n_{v_1}, n_{v_2}, \dots, n_{v_m})$ be a combinatorial Euclidean space of $\mathbf{R}^{n_{v_1}}, \mathbf{R}^{n_{v_2}}, \dots, \mathbf{R}^{n_{v_m}}$ with an underlying graph G , $V(G) = \{v_1, v_2, \dots, v_m\}$ and $\{v_1, v_2, \dots, v_l\}$ an independent vertex set in G . Then*

$$\dim_{\min} \mathcal{E}_G(n_{v_1}, \dots, n_{v_m}) \geq \sum_{i=1}^l n_{v_i}$$

and with the equality hold if G is a complete bipartite graph $K(V_1, V_2)$ with partite sets $V_1 = \{v_1, v_2, \dots, v_l\}$, $V_2 = \{v_{l+1}, v_{l+2}, \dots, v_m\}$ and

$$\sum_{i=1}^l n_{v_i} \geq \sum_{i=l+1}^m n_{v_i}.$$

Proof Similarly, we use $X_{v_1}, X_{v_2}, \dots, X_{v_m}$ to denote these orthogonal orientations in $\mathbf{R}^{n_{v_1}}, \mathbf{R}^{n_{v_2}}, \dots, \mathbf{R}^{n_{v_m}}$, respectively. By definition, we know that

$$X_{v_i} \cap X_{v_j} = \emptyset, \quad 1 \leq i \neq j \leq l$$

for $(v_i, v_j) \notin E(G)$. Whence, we get that

$$|\bigcup_{i=1}^m X_{v_i}| \geq |\bigcup_{i=1}^l X_{v_i}| = \sum_{i=1}^l n_{v_i}.$$

By the assumption,

$$\sum_{i=1}^l n_{v_i} \geq \sum_{i=l+1}^m n_{v_i},$$

we can partition $X_{v_1}, X_{v_2}, \dots, X_{v_m}$ to

$$\begin{aligned} X_{v_1} &= \left(\bigcup_{i=l+1}^m Y_i(v_1) \right) \cup Z(v_1), \\ X_{v_2} &= \left(\bigcup_{i=l+1}^m Y_i(v_2) \right) \cup Z(v_2), \\ &\dots\dots\dots, \\ X_{v_l} &= \left(\bigcup_{i=l+1}^m Y_i(v_l) \right) \cup Z(v_l) \end{aligned}$$

such that $\sum_{k=1}^l |Y_i(v_k)| = |X_{v_i}|$ for any integer i , $l+1 \leq i \leq m$, where $Z(v_i)$ maybe an empty set for integers i , $1 \leq i \leq l$. Whence, we can choose

$$X'_{v_i} = \bigcup_{k=1}^l Y_i(v_k)$$

to replace each X_{v_i} for any integer i , $1 \leq i \leq m$. Notice that the intersection graph of $X_{v_1}, X_{v_2}, \dots, X_{v_l}, X'_{v_{l+1}}, \dots, X'_{v_m}$ is still the complete bipartite graph $K(V_1, V_2)$, but

$$\left| \bigcup_{i=1}^m X_{v_i} \right| = \left| \bigcup_{i=1}^l X_{v_i} \right| = \sum_{i=1}^l n_i.$$

Therefore, we get that

$$\dim_{\min} \mathcal{E}_G(n_{v_1}, \dots, n_{v_m}) = \sum_{i=1}^l n_{v_i}$$

in the case of complete bipartite graph $K(V_1, V_2)$ with partite sets $V_1 = \{v_1, v_2, \dots, v_l\}$, $V_2 = \{v_{l+1}, v_{l+2}, \dots, v_m\}$ and

$$\sum_{i=1}^l n_{v_i} \geq \sum_{i=l+1}^m n_{v_i}.$$

□

Although the lower bound of $\dim \mathcal{E}_G(n_{v_1}, \dots, n_{v_m})$ in Theorem 4.1.3 is sharp, but sometimes this bound is not better if G is given, for example, the complete graph K_m shown in the next results. Consider a complete system of r -subsets of a set with less than $2r$ elements. We know the next conclusion.

Theorem 4.1.4 For any integer $r \geq 2$, let $\mathcal{E}_{K_m}(r)$ be a combinatorial Euclidean space of $\underbrace{\mathbf{R}^r, \dots, \mathbf{R}^r}_m$, and there exists an integer s , $0 \leq s \leq r-1$ such that

$$\binom{r+s-1}{r} < m \leq \binom{r+s}{r}.$$

Then

$$\dim_{\min} \mathcal{E}_{K_m}(r) = r + s.$$

Proof We denote by X_1, X_2, \dots, X_m these sets consist of orthogonal orientations in m Euclidean spaces \mathbf{R}^r . Then each X_i , $1 \leq i \leq m$, is an r -set. By assumption,

$$\binom{r+s-1}{r} < m \leq \binom{r+s}{r}$$

and $0 \leq s \leq r-1$, we know that two r -subsets of an $(r+s)$ -set must have a nonempty intersection. So we can determine these m r -subsets X_1, X_2, \dots, X_m by using the complete system of r -subsets in an $(r+s)$ -set, and these m r -subsets X_1, X_2, \dots, X_m can not be chosen in an $(r+s-1)$ -set. Therefore, we find that

$$|\bigcup_{i=1}^m X_i| = r+s,$$

i.e., if $0 \leq s \leq r-1$, then

$$\dim_{\min} \mathcal{E}_{K_m}(r) = r+s$$

□

Because of our living world is the space \mathbf{R}^3 , so the combinatorial space of \mathbf{R}^3 is particularly interesting in physics. We completely determine its minimum dimension in the case of K_m following.

Theorem 4.1.5 *Let $\mathcal{E}_{K_m}(3)$ be a combinatorial Euclidean space of $\underbrace{\mathbf{R}^3, \dots, \mathbf{R}^3}_m$. Then*

$$\dim_{\min} \mathcal{E}_{K_m}(3) = \begin{cases} 3, & \text{if } m = 1, \\ 4, & \text{if } 2 \leq m \leq 4, \\ 5, & \text{if } 5 \leq m \leq 10, \\ 2 + \lceil \sqrt{m} \rceil, & \text{if } m \geq 11. \end{cases}$$

Proof Let X_1, X_2, \dots, X_m be these sets consist of orthogonal orientations in m Euclidean spaces \mathbf{R}^3 , respectively and $|X_1 \cup X_2 \cup \dots \cup X_m| = l$. Then each $X_i, 1 \leq i \leq m$, is a 3-set.

In the case of $m \leq 10 = \binom{5}{2}$, any s -sets have a nonempty intersection. So it is easily to check that

$$\dim_{\min} \mathcal{E}_{K_m}(3) = \begin{cases} 3, & \text{if } m = 1, \\ 4, & \text{if } 2 \leq m \leq 4, \\ 5, & \text{if } 5 \leq m \leq 10. \end{cases}$$

We only consider the case of $m \geq 11$. Let $X = \{u, v, w\}$ be a chosen 3-set. Notice that any 3-set will intersect X with 1 or 2 elements. Our discussion is divided into three cases.

Case 1 *There exist 3-sets X'_1, X'_2, X'_3 such that $X'_1 \cap X = \{u, v\}$, $X'_2 \cap X = \{u, w\}$ and $X'_3 \cap X = \{v, w\}$ such as those shown in Fig.4.1.1, where each triangle denotes a 3-set.*

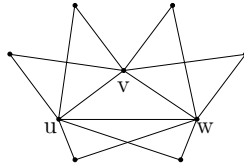

Fig.4.1.1

Notice that there are no 3-sets X' such that $|X' \cap X| = 1$ in this case. Otherwise, we can easily find two 3-sets with an empty intersection, a contradiction. Counting such 3-sets, we know that there are at most $3(v-3)+1$ 3-sets with their intersection graph being K_m . Thereafter, we know that

$$m \leq 3(l-3) + 1, \quad \text{i.e.,} \quad l \geq \lceil \frac{m-1}{3} \rceil + 3.$$

Case 2 *There are 3-sets X'_1, X'_2 but no 3-set X'_3 such that $X'_1 \cap X = \{u, v\}$, $X'_2 \cap X = \{u, w\}$ and $X'_3 \cap X = \{v, w\}$ such as those shown in Fig.4.1.2, where each triangle denotes a 3-set.*

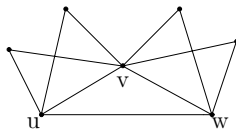

Fig.4.1.2

In this case, there are no 3-sets X' such that $X' \cap X = \{u\}$ or $\{w\}$. Otherwise, we can easily find two 3-sets with an empty intersection, a contradiction. Enumerating such 3-sets, we know that there are at most

$$2(l-1) + \binom{l-3}{2} + 1$$

3-sets with their intersection graph still being K_m . Whence, we get that

$$m \leq 2(l-1) + \binom{l-3}{2} + 1, \quad \text{i.e.,} \quad l \geq \lceil \frac{3 + \sqrt{8m + 17}}{2} \rceil.$$

Case 3 There are a 3-set X'_1 but no 3-sets X'_2, X'_3 such that $X'_1 \cap X = \{u, v\}$, $X'_2 \cap X = \{u, w\}$ and $X'_3 \cap X = \{v, w\}$ such as those shown in Fig.4.1.3, where each triangle denotes a 3-set.

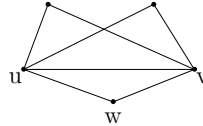

Fig.4.1.3

Enumerating 3-sets in this case, we know that there are at most

$$l-2 + 2 \binom{l-2}{2}$$

such 3-sets with their intersection graph still being K_m . Therefore, we find that

$$m \leq l-2 + 2 \binom{l-2}{2}, \quad \text{i.e.,} \quad l \geq 2 + \lceil \sqrt{m} \rceil.$$

Combining these Cases 1 – 3, we know that

$$l \geq \min \left\{ \lceil \frac{m-1}{3} \rceil + 3, \lceil \frac{3 + \sqrt{8m + 17}}{2} \rceil, 2 + \lceil \sqrt{m} \rceil \right\} = 2 + \lceil \sqrt{m} \rceil.$$

Conversely, there 3-sets constructed in Case 3 show that there indeed exist 3-sets X_1, X_2, \dots, X_m whose intersection graph is K_m , where

$$m = l-2 + 2 \binom{l-2}{2}.$$

Therefore, we get that

$$\dim_{\min} \mathcal{E}_{K_m}(3) = 2 + \lceil \sqrt{m} \rceil$$

if $m \geq 11$. This completes the proof. □

For general combinatorial spaces $\mathcal{E}_{K_m}(n_{v_1}, \dots, n_{v_m})$ of $\mathbf{R}^{n_{v_1}}, \mathbf{R}^{n_{v_2}}, \dots, \mathbf{R}^{n_{v_m}}$, we get their minimum dimension if n_{v_m} is large enough.

Theorem 4.1.6 *Let \mathcal{E}_{K_m} be a combinatorial Euclidean space of $\mathbf{R}^{n_{v_1}}, \mathbf{R}^{n_{v_2}}, \dots, \mathbf{R}^{n_{v_m}}$, $n_{v_1} \geq n_{v_2} \geq \dots \geq n_{v_m} \geq \lceil \log_2(\frac{m+1}{2^{n_{v_1}-n_{v_2}-1}}) \rceil + 1$ and $V(K_m) = \{v_1, v_2, \dots, v_m\}$. Then*

$$\dim_{\min} \mathcal{E}_{K_m}(n_{v_1}, \dots, n_{v_m}) = n_{v_1} + \lceil \log_2(\frac{m+1}{2^{n_{v_1}-n_{v_2}-1}}) \rceil.$$

Proof Let $X_{v_1}, X_{v_2}, \dots, X_{v_m}$ be sets consist of these orthogonal orientations in $\mathbf{R}^{n_{v_1}}, \mathbf{R}^{n_{v_2}}, \dots, \mathbf{R}^{n_{v_m}}$, respectively and

$$2^{s-1} < \frac{m}{2^{k+1}-1} + 1 \leq 2^s$$

for an integer s , where $k = n_{v_1} - n_{v_2}$. Then we find that

$$\lceil \log_2(\frac{m+1}{2^{n_{v_1}-n_{v_2}-1}}) \rceil = s.$$

We construct a family $\{Y_{v_1}, Y_{v_2}, \dots, Y_{v_m}\}$ with none being a subset of another, $|Y_{v_i}| = |X_{v_i}|$ for $1 \leq i \leq m$ and its intersection graph is still K_m , but with

$$|Y_{v_1} \cup Y_{v_2} \cup \dots \cup Y_{v_m}| = n_{v_1} + s.$$

In fact, let $X_{v_1} = \{x_1, x_2, \dots, x_{n_{v_2}}, x_{n_{v_2}+1}, \dots, x_{n_{v_1}}\}$ and $U = \{u_1, u_2, \dots, u_s\}$, such as those shown in Fig.4.1.4 for $s = 1$ and $n_{v_1} = 9$.

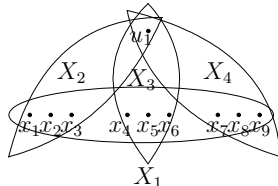

Fig.4.1.4

Choose g elements $x_{i_1}, x_{i_2}, \dots, x_{i_g} \in X_{v_1}$ and $h \geq 1$ elements $u_{j_1}, u_{j_2}, \dots, u_{j_h} \in U$. We construct a finite set

$$X_{g,h} = \{x_{i_1}, x_{i_2}, \dots, x_{i_g}, u_{j_1}, u_{j_2}, \dots, u_{j_h}\}$$

with a cardinal $g + h$. Let $g + h = |X_{v_1}|, |X_{v_2}|, \dots, |X_{v_m}|$, respectively. We consequently find such sets $Y_{v_1}, Y_{v_2}, \dots, Y_{v_m}$. Notice that there are no one set being a subset of another in the family $\{Y_{v_1}, Y_{v_2}, \dots, Y_{v_m}\}$. So there must have two elements in each Y_{v_i} , $1 \leq i \leq m$ at least such that one is in U and another in $\{x_{n_{v_2}}, x_{n_{v_2}+1}, \dots, x_{n_{v_1}}\}$. Now since $n_{v_m} \geq \lceil \log_2(\frac{m+1}{2^{n_{v_1}-n_{v_2}-1}}) \rceil + 1$, there are

$$\sum_{i=1}^{k+1} \sum_{j=1}^s \binom{k+1}{i} \binom{s}{j} = (2^{k+1} - 1)(2^s - 1) \geq m$$

different sets $Y_{v_1}, Y_{v_2}, \dots, Y_{v_m}$ altogether with $|X_{v_1}| = |Y_{v_1}|, \dots, |X_{v_m}| = |Y_{v_m}|$. None of them is a subset of another and their intersection graph is still K_m . For example,

$$\begin{aligned} & X_{v_1}, \quad \{u_1, x_1, \dots, x_{n_{v_2}-1}\}, \\ & \{u_1, x_{n_{v_2}-n_{v_3}+2}, \dots, x_{n_{v_2}}\}, \\ & \dots\dots\dots, \\ & \{u_1, x_{n_{v_{k-1}}-n_{v_k}+2}, \dots, x_{n_{v_k}}\} \end{aligned}$$

are such sets with only one element u_1 in U . See also in Fig.4.1.1 for details. It is easily to know that

$$|Y_{v_1} \cup Y_{v_2} \cup \dots \cup Y_{v_m}| = n_{v_1} + s = n_{v_1} + \lceil \log_2(\frac{m+1}{2^{n_{v_1}-n_{v_2}-1}}) \rceil$$

in our construction.

Conversely, if there exists a family $\{Y_{v_1}, Y_{v_2}, \dots, Y_{v_m}\}$ such that $|X_{v_1}| = |Y_{v_1}|, \dots, |X_{v_m}| = |Y_{v_m}|$ and

$$|Y_{v_1} \cup Y_{v_2} \cup \dots \cup Y_{v_m}| < n_{v_1} + s,$$

then there at most

$$\sum_{i=1}^{k+1} \sum_{j=1}^s \binom{k+1}{i} \binom{s-1}{j} = (2^{k+1} - 1)(2^{s-1} - 1) < m$$

different sets in $\{Y_{v_1}, Y_{v_2}, \dots, Y_{v_m}\}$ with none being a subset of another. This implies that there must exist integers $i, j, 1 \leq i \neq j \leq m$ with $Y_{v_i} \subset Y_{v_j}$, a contradiction. Therefore, we get the minimum dimension $\dim_{\min} \mathcal{E}_{K_m}$ of \mathcal{E}_{K_m} to be

$$\dim_{\min} \mathcal{E}_{K_m}(n_{v_1}, \dots, n_{v_m}) = n_{v_1} + \lceil \log_2 \left(\frac{m+1}{2^{n_{v_1} - n_{v_2}} - 1} \right) \rceil.$$

□

4.1.2 Combinatorial Fan-Space. A *combinatorial fan-space* $\tilde{\mathbf{R}}(n_1, \dots, n_m)$ is the combinatorial Euclidean space $\mathcal{E}_{K_m}(n_1, \dots, n_m)$ of $\mathbf{R}^{n_1}, \mathbf{R}^{n_2}, \dots, \mathbf{R}^{n_m}$ such that for any integers $i, j, 1 \leq i \neq j \leq m$,

$$\mathbf{R}^{n_i} \cap \mathbf{R}^{n_j} = \bigcap_{k=1}^m \mathbf{R}^{n_k},$$

which is applied for generalizing n -manifolds to combinatorial manifolds in next section. The dimensional number of $\tilde{\mathbf{R}}(n_1, \dots, n_m)$ is determined immediately by definition following.

Theorem 4.1.7 *Let $\tilde{\mathbf{R}}(n_1, \dots, n_m)$ be a fan-space. Then*

$$\dim \tilde{\mathbf{R}}(n_1, \dots, n_m) = \hat{m} + \sum_{i=1}^m (n_i - \hat{m}),$$

where

$$\hat{m} = \dim \left(\bigcap_{k=1}^m \mathbf{R}^{n_k} \right).$$

□

For $\forall p \in \tilde{\mathbf{R}}(n_1, \dots, n_m)$ we can present it by an $m \times n_m$ coordinate matrix $[\tilde{x}]$ following with $x_{il} = \frac{x_i}{m}$ for $1 \leq i \leq m, 1 \leq l \leq \hat{m}$.

$$[\tilde{x}] = \begin{bmatrix} x_{11} & \cdots & x_{1\hat{m}} & x_{1(\hat{m}+1)} & \cdots & x_{1n_1} & \cdots & 0 \\ x_{21} & \cdots & x_{2\hat{m}} & x_{2(\hat{m}+1)} & \cdots & x_{2n_2} & \cdots & 0 \\ \cdots & \cdots & \cdots & \cdots & \cdots & \cdots & \cdots & \cdots \\ x_{m1} & \cdots & x_{m\hat{m}} & x_{m(\hat{m}+1)} & \cdots & \cdots & x_{mn_{m-1}} & x_{mn_m} \end{bmatrix}$$

Now let $(A) = (a_{ij})_{m \times n}$ and $(B) = (b_{ij})_{m \times n}$ be two matrixes. Similar to Euclidean space, we introduce the *inner product* $\langle (A), (B) \rangle$ of (A) and (B) by

$$\langle(A), (B)\rangle = \sum_{i,j} a_{ij}b_{ij}.$$

Then we know

Theorem 4.1.8 *Let $(A), (B), (C)$ be $m \times n$ matrixes and α a constant. Then*

- (1) $\langle A, B \rangle = \langle B, A \rangle$;
- (2) $\langle A + B, C \rangle = \langle A, C \rangle + \langle B, C \rangle$;
- (3) $\langle \alpha A, B \rangle = \alpha \langle A, B \rangle$;
- (4) $\langle A, A \rangle \geq 0$ with equality hold if and only if $(A) = O_{m \times n}$.

Proof (1)-(3) can be gotten immediately by definition. Now calculation shows that

$$\langle A, A \rangle = \sum_{i,j} a_{ij}^2 \geq 0$$

and with equality hold if and only if $a_{ij} = 0$ for any integers $i, j, 1 \leq i \leq m, 1 \leq j \leq n$, namely, $(A) = O_{m \times n}$. □

By Theorem 4.1.8, all matrixes of real entries under the inner product form a Euclidean space. We also generalize some well-known results in Section 3.2 to this space. The first, Theorem 3.2.1(i) is generalized to the next result.

Theorem 4.1.9 *Let $(A), (B)$ be $m \times n$ matrixes. Then*

$$\langle(A), (B)\rangle^2 \leq \langle(A), (A)\rangle \langle(B), (B)\rangle$$

and with equality hold only if $(A) = \lambda(B)$, where λ is a real constant.

Proof If $(A) = \lambda(B)$, then $\langle A, B \rangle^2 = \lambda^2 \langle B, B \rangle^2 = \langle A, A \rangle \langle B, B \rangle$. Now if there are no constant λ enabling $(A) = \lambda(B)$, then $(A) - \lambda(B) \neq O_{m \times n}$ for any real number λ . According to Theorem 2.1, we know that

$$\langle(A) - \lambda(B), (A) - \lambda(B)\rangle > 0,$$

i.e.,

$$\langle(A), (A)\rangle - 2\lambda \langle(A), (B)\rangle + \lambda^2 \langle(B), (B)\rangle > 0.$$

Therefore, we find that

$$\Delta = (-2 \langle (A), (B) \rangle)^2 - 4 \langle (A), (A) \rangle \langle (B), (B) \rangle < 0,$$

namely,

$$\langle (A), (B) \rangle^2 < \langle (A), (A) \rangle \langle (B), (B) \rangle.$$

□

Corollary 4.1.2 For given real numbers a_{ij}, b_{ij} , $1 \leq i \leq m, 1 \leq j \leq n$,

$$\left(\sum_{i,j} a_{ij} b_{ij} \right)^2 \leq \left(\sum_{i,j} a_{ij}^2 \right) \left(\sum_{i,j} b_{ij}^2 \right).$$

Now let O be the original point of $\tilde{\mathbf{R}}(n_1, \dots, n_m)$. Then $[O] = O_{m \times n_m}$. For $\forall p, q \in \tilde{\mathbf{R}}(n_1, \dots, n_m)$, we also call $\vec{O}p$ the vector correspondent to the point p similar to that of Euclidean spaces, Then $\vec{p}q = \vec{O}q - \vec{O}p$. Theorem 4.1.9 enables us to introduce an angle between two vectors $\vec{p}q$ and $\vec{u}v$ for points $p, q, u, v \in \tilde{\mathbf{R}}(n_1, \dots, n_m)$.

Let $p, q, u, v \in \tilde{\mathbf{R}}(n_1, \dots, n_m)$. Then the angle θ between vectors $\vec{p}q$ and $\vec{u}v$ is determined by

$$\cos \theta = \frac{\langle [p] - [q], [u] - [v] \rangle}{\sqrt{\langle [p] - [q], [p] - [q] \rangle \langle [u] - [v], [u] - [v] \rangle}}$$

under the condition that $0 \leq \theta \leq \pi$.

Corollary 4.1.3 The conception of angle between two vectors is well defined.

Proof Notice that

$$\langle [p] - [q], [u] - [v] \rangle^2 \leq \langle [p] - [q], [p] - [q] \rangle \langle [u] - [v], [u] - [v] \rangle$$

by Theorem 4.1.9. Thereby, we know that

$$-1 \leq \frac{\langle [p] - [q], [u] - [v] \rangle}{\sqrt{\langle [p] - [q], [p] - [q] \rangle \langle [u] - [v], [u] - [v] \rangle}} \leq 1.$$

Therefore there is a unique angle θ with $0 \leq \theta \leq \pi$ enabling Definition 2.3 hold. □

For two points p, q in $\tilde{\mathbf{R}}(n_1, \dots, n_m)$, the distance $d(p, q)$ between points p and q is defined to be $\sqrt{\langle [p] - [q], [p] - [q] \rangle}$. We get the following result.

Theorem 4.1.10 For a given integer sequence $n_1, n_2, \dots, n_m, m \geq 1$ with $0 < n_1 < n_2 < \dots < n_m$, $(\tilde{\mathbf{R}}(n_1, \dots, n_m); d)$ is a metric space.

Proof We only need to verify that each condition for a metric space is hold in $(\tilde{\mathbf{R}}(n_1, \dots, n_m); d)$. For two point $p, q \in \tilde{\mathbf{R}}(n_1, \dots, n_m)$, by definition we know that

$$d(p, q) = \sqrt{\langle [p] - [q], [p] - [q] \rangle} \geq 0$$

with equality hold if and only if $[p] = [q]$, namely, $p = q$ and

$$d(p, q) = \sqrt{\langle [p] - [q], [p] - [q] \rangle} = \sqrt{\langle [q] - [p], [q] - [p] \rangle} = d(q, p).$$

Now let $u \in \tilde{\mathbf{R}}(n_1, \dots, n_m)$. By Theorem 4.1.9, we then find that

$$\begin{aligned} & (d(p, u) + d(u, p))^2 \\ &= \langle [p] - [u], [p] - [u] \rangle + 2\sqrt{\langle [p] - [u], [p] - [u] \rangle \langle [u] - [q], [u] - [q] \rangle} \\ &+ \langle [u] - [q], [u] - [q] \rangle \\ &\geq \langle [p] - [u], [p] - [u] \rangle + 2\langle [p] - [u], [u] - [q] \rangle + \langle [u] - [q], [u] - [q] \rangle \\ &= \langle [p] - [q], [p] - [q] \rangle = d^2(p, q). \end{aligned}$$

Whence, $d(p, u) + d(u, p) \geq d(p, q)$ and $(\tilde{\mathbf{R}}(n_1, \dots, n_m); d)$ is a metric space. \square

4.1.3 Decomposition Space into Combinatorial One. As we have shown in Subsection 4.1.2, a combinatorial fan-space $\tilde{R}(n_1, n_2, \dots, n_m)$ can be turned into a Euclidean space \mathbf{R}^n with $n = \hat{m} + \sum_{i=1}^m (n_i - \hat{m})$. Now the inverse question is that for a Euclidean space \mathbf{R}^n , weather there is a combinatorial Euclidean space $\mathcal{E}_G(n_1, \dots, n_m)$ of Euclidean spaces $\mathbf{R}^{n_1}, \mathbf{R}^{n_2}, \dots, \mathbf{R}^{n_m}$ such that $\dim \mathbf{R}^{n_1} \cup \mathbf{R}^{n_2} \cup \dots \cup \mathbf{R}^{n_m} = n$? For combinatorial fan-spaces, we immediately get the following decomposition result of Euclidean spaces.

Theorem 4.1.11 Let \mathbf{R}^n be a Euclidean space, n_1, n_2, \dots, n_m integers with $\hat{m} < n_i < n$ for $1 \leq i \leq m$ and the equation

$$\hat{m} + \sum_{i=1}^m (n_i - \hat{m}) = n$$

hold for an integer $\widehat{m}, 1 \leq \widehat{m} \leq n$. Then there is a combinatorial fan-space $\widetilde{\mathbf{R}}(n_1, n_2, \dots, n_m)$ such that

$$\mathbf{R}^n \cong \widetilde{\mathbf{R}}(n_1, n_2, \dots, n_m).$$

Proof Not loss of generality, assume the normal basis of \mathbf{R}^n is $\bar{e}_1 = (1, 0, \dots, 0)$, $\bar{e}_2 = (0, 1, 0 \dots, 0)$, \dots , $\bar{e}_n = (0, \dots, 0, 1)$. Then its coordinate system of \mathbf{R}^n is (x_1, x_2, \dots, x_n) . Since

$$n - \widehat{m} = \sum_{i=1}^m (n_i - \widehat{m}),$$

choose

$$\mathbf{R}_1 = \langle \bar{e}_1, \bar{e}_2, \dots, \bar{e}_{\widehat{m}}, \bar{e}_{\widehat{m}+1}, \dots, \bar{e}_{n_1} \rangle;$$

$$\mathbf{R}_2 = \langle \bar{e}_1, \bar{e}_2, \dots, \bar{e}_{\widehat{m}}, \bar{e}_{n_1+1}, \bar{e}_{n_1+2}, \dots, \bar{e}_{n_2} \rangle;$$

$$\mathbf{R}_3 = \langle \bar{e}_1, \bar{e}_2, \dots, \bar{e}_{\widehat{m}}, \bar{e}_{n_2+1}, \bar{e}_{n_2+2}, \dots, \bar{e}_{n_3} \rangle;$$

.....;

$$\mathbf{R}_m = \langle \bar{e}_1, \bar{e}_2, \dots, \bar{e}_{\widehat{m}}, \bar{e}_{n_{m-1}+1}, \bar{e}_{n_{m-1}+2}, \dots, \bar{e}_{n_m} \rangle.$$

Calculation shows that $\dim \mathbf{R}_i = n_i$ and $\dim(\bigcap_{i=1}^m \mathbf{R}_i) = \widehat{m}$. Whence $\widetilde{\mathbf{R}}(n_1, n_2, \dots, n_m)$ is a combinatorial fan-space. By Definition 2.1.3 and Theorems 2.1.1, 4.1.8 – 4.1.9, we then get that

$$\mathbf{R}^n \cong \widetilde{\mathbf{R}}(n_1, n_2, \dots, n_m).$$

□

For an intersection graph G of sets $X_v, v \in V(G)$, there is a natural labeling θ_E with $\theta_E(u, v) = |X_u \cap X_v|$ for $\forall (u, v) \in E(G)$. This fact enables us to find an intersecting result following, which generalizes a result of Erdős et al. in [EGP1].

Theorem 4.1.12 *Let G^E be an edge labeled graph on a connected graph G with labeling $\theta_E : E(G) \rightarrow [1, l]$. If $n_v, v \in V(G)$ are given integers with $n_v \geq \sum_{u \in N_G(v)} \theta_E(v, u)$, then there are sets $X_v, v \in V(G)$ such that $|X_v| = n_v$ and $|X_v \cap X_u| = \theta_E(v, u)$ for $v \in V(G), u \in N_G(v)$.*

Proof For $(v, u) \in E(G)$, construct a finite set

$$\widehat{(v, u)} = \{(v, u)_1, (v, u)_2, \dots, (v, u)_{\theta_E(v, u)}\}.$$

Now we define

$$X_v = \left(\bigcup_{u \in N_G(v)} \widehat{(v, u)} \right) \cup \{x_1, x_2, \dots, x_\varsigma\},$$

for $\forall v \in V(G)$, where $\varsigma = n_v - \sum_{u \in N_G(v)} \theta_E(v, u)$. Then we find that these sets $X_v, v \in V(G)$ satisfy $|X_v| = n_v, |X_v \cap X_u| = \theta_E(v, u)$ for $\forall v \in V(G)$ and $\forall u \in N_G(v)$. This completes the proof. \square

As a special case, choosing the labeling 1 on each edge of G in Theorem 4.1.12, we get the result of Erdős et al. again.

Corollary 4.1.4 *For any graph G , there exist sets $X_v, v \in V(G)$ with the intersection graph G , i.e., the minimum number of elements in $X_v, v \in V(G)$ is less than or equal to $\varepsilon(G)$.*

Calculation shows that

$$\left| \bigcup_{v \in V(G)} X_v \right| = \sum_{v \in V(G)} n_v - \frac{1}{2} \sum_{(v, u) \in E(G)} \theta_E(v, u)$$

in the construction of Theorem 4.1.12, we get a decomposition result for a Euclidean space \mathbf{R}^n following.

Theorem 4.1.13 *Let G be a connected graph and*

$$n = \sum_{v \in V(G)} n_v - \frac{1}{2} \sum_{(v, u) \in E(G)} n_{(v, u)}$$

for integers $n_v, n_v \geq \sum_{u \in N_G(v)} \theta_E(v, u), v \in V(G)$ and $n_{(v, u)} \geq 1, (v, u) \in E(G)$. Then there is a combinatorial Euclidean space $\mathcal{E}_G(n_v, v \in V(G))$ of $\mathbf{R}^{n_v}, v \in V(G)$ such that $\mathbf{R}^n \cong \mathcal{E}_G(n_v, v \in V(G))$. \square

§4.2 COMBINATORIAL MANIFOLDS

4.2.1 Combinatorial Manifold. For a given integer sequence $n_1, n_2, \dots, n_m, m \geq 1$ with $0 < n_1 < n_2 < \dots < n_m$, a *combinatorial manifold* \widetilde{M} is a Hausdorff space such that for any point $p \in \widetilde{M}$, there is a local chart (U_p, φ_p) of p , i.e., an open neighborhood U_p of p in \widetilde{M} and a homeomorphism $\varphi_p : U_p \rightarrow \widetilde{\mathbf{R}}(n_1(p), n_2(p), \dots, n_{s(p)}(p))$, a combinatorial fan-space with

$$\{n_1(p), n_2(p), \dots, n_{s(p)}(p)\} \subseteq \{n_1, n_2, \dots, n_m\},$$

and

$$\bigcup_{p \in \widetilde{M}} \{n_1(p), n_2(p), \dots, n_{s(p)}(p)\} = \{n_1, n_2, \dots, n_m\},$$

denoted by $\widetilde{M}(n_1, n_2, \dots, n_m)$ or \widetilde{M} on the context, and

$$\widetilde{\mathcal{A}} = \{(U_p, \varphi_p) | p \in \widetilde{M}(n_1, n_2, \dots, n_m)\}$$

an atlas on $\widetilde{M}(n_1, n_2, \dots, n_m)$. The maximum value of $s(p)$ and the dimension $\widehat{s}(p) = \dim(\bigcap_{i=1}^{s(p)} \mathbf{R}^{n_i(p)})$ are called the dimension and the intersectional dimension of $\widetilde{M}(n_1, n_2, \dots, n_m)$ at the point p , respectively.

A combinatorial manifold \widetilde{M} is *finite* if it is just combined by finite manifolds with an underlying combinatorial structure G without one manifold contained in the union of others. Certainly, a finitely combinatorial manifold is indeed a combinatorial manifold.

Two examples of such combinatorial manifolds with different dimensions in \mathbf{R}^3 are shown in Fig.4.2.1, in where, (a) represents a combination of a 3-manifold, a torus and 1-manifold, and (b) a torus with 4 bouquets of 1-manifolds.

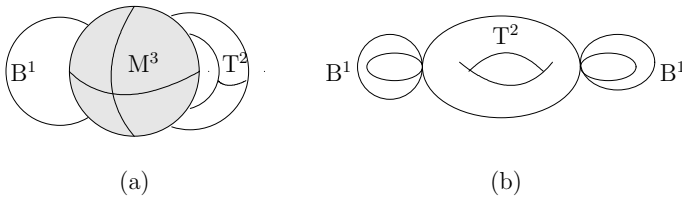

Fig.4.2.1

By definition, combinatorial manifolds are a generalization of manifolds by a combinatorial speculation. However, a compact n -manifold M^n without boundary is itself a combinatorial Euclidean space $\mathcal{E}_G(\underbrace{n, \dots, n}_m)$ of Euclidean spaces \mathbf{R}^n with an underlying structure G shown in the next result.

Theorem 4.2.1 *A compact n -manifold M^n without boundary is homeomorphic to a combinatorial Euclidean space $\mathcal{E}_G(\underbrace{n, \dots, n}_m)$ of spaces \mathbf{R}^n , where G is dependent on M^n .*

Proof Let

$$\mathcal{A} = \{(U_p, \varphi_p) \mid \varphi_p : U_p \rightarrow \mathbf{R}^n, \forall p \in M^n\}$$

be an atlas of M^n . By definition, M^n is compact. Whence, there is an atlas of M^n with only finite charts, i.e., there is an integer $1 \leq m \leq +\infty$ such that

$$\mathcal{A}_{[m]} = \{(U_i, \varphi_i) \mid 1 \leq i \leq m\}$$

is a finite atlas on M^n . Therefore, we can define an underlying combinatorial structure G by

$$\begin{aligned} V(G) &= \{U_i, 1 \leq i \leq m\}, \\ E(G) &= \{(U_i, U_j) \mid U_i \cap U_j \neq \emptyset, 1 \leq i \neq j \leq m\}. \end{aligned}$$

Then we get a combinatorial manifold $\widetilde{M}(n)$ underlying the graph G .

Now we can also define a combinatorial Euclidean space $\mathcal{E}_G(\underbrace{n, \dots, n}_m)$ of spaces \mathbf{R}^n by

$$\begin{aligned} V(G) &= \{\varphi_i(U_i), 1 \leq i \leq m\}, \\ E(G) &= \{(\varphi_i(U_i), \varphi_j(U_j)) \mid \text{if } \varphi_i(U_i) \cap \varphi_j(U_j) \neq \emptyset, 1 \leq i \neq j \leq m\}. \end{aligned}$$

Notice that $\varphi_i(U_i) \cap \varphi_j(U_j) \neq \emptyset$ if and only if $U_i \cap U_j \neq \emptyset$. We know that

$$\widetilde{M}(n) \cong \mathcal{E}_G(\underbrace{n, \dots, n}_m).$$

This completes the proof. □

By definition, a finitely combinatorial manifold $\widetilde{M}(n_1, n_2, \dots, n_m)$ is provided

with a combinatorial structure G . We characterize its structure by applying vertex-edge labeled graphs on the conception of d -connectedness introduced for integers $d \geq 1$ following.

Definition 4.2.1 For two points p, q in a finitely combinatorial manifold $\widetilde{M}(n_1, n_2, \dots, n_m)$, if there is a sequence B_1, B_2, \dots, B_s of d -dimensional open balls with two conditions following hold.

- (1) $B_i \subset \widetilde{M}(n_1, n_2, \dots, n_m)$ for any integer $i, 1 \leq i \leq s$ and $p \in B_1, q \in B_s$;
- (2) The dimensional number $\dim(B_i \cap B_{i+1}) \geq d$ for $\forall i, 1 \leq i \leq s - 1$.

Then points p, q are called d -dimensional connected in $\widetilde{M}(n_1, n_2, \dots, n_m)$ and the sequence B_1, B_2, \dots, B_s a d -dimensional path connecting p and q , denoted by $P^d(p, q)$.

If each pair p, q of points in the finitely combinatorial manifold $\widetilde{M}(n_1, n_2, \dots, n_m)$ is d -dimensional connected, then $\widetilde{M}(n_1, n_2, \dots, n_m)$ is called d -pathwise connected and say its connectivity $\geq d$.

Not loss of generality, we consider only finitely combinatorial manifolds with a connectivity ≥ 1 in this book. Let $\widetilde{M}(n_1, n_2, \dots, n_m)$ be a finitely combinatorial manifold and $d, d \geq 1$ an integer. We construct a vertex-edge labeled graph $G^d[\widetilde{M}(n_1, n_2, \dots, n_m)]$ by

$$V(G^d[\widetilde{M}(n_1, n_2, \dots, n_m)]) = V_1 \cup V_2,$$

where $V_1 = \{n_i - \text{manifolds } M^{n_i} \text{ in } \widetilde{M}(n_1, n_2, \dots, n_m) | 1 \leq i \leq m\}$ and $V_2 = \{\text{isolated intersection points } O_{M^{n_i}, M^{n_j}} \text{ of } M^{n_i}, M^{n_j} \text{ in } \widetilde{M}(n_1, n_2, \dots, n_m) \text{ for } 1 \leq i, j \leq m\}$. Label n_i for each n_i -manifold in V_1 and 0 for each vertex in V_2 and

$$E(G^d[\widetilde{M}(n_1, n_2, \dots, n_m)]) = E_1 \cup E_2,$$

where $E_1 = \{(M^{n_i}, M^{n_j}) \text{ labeled with } \dim(M^{n_i} \cap M^{n_j}) | \dim(M^{n_i} \cap M^{n_j}) \geq d, 1 \leq i, j \leq m\}$ and $E_2 = \{(O_{M^{n_i}, M^{n_j}}, M^{n_i}), (O_{M^{n_i}, M^{n_j}}, M^{n_j}) \text{ labeled with } 0 | M^{n_i} \text{ tangent } M^{n_j} \text{ at the point } O_{M^{n_i}, M^{n_j}} \text{ for } 1 \leq i, j \leq m\}$.

For example, these correspondent labeled graphs gotten from finitely combinatorial manifolds in Fig.4.2.1 are shown in Fig.4.2.2, in where $d = 1$ for (a) and (b), $d = 2$ for (c) and (d). Notice if $\dim(M^{n_i} \cap M^{n_j}) \leq d - 1$, then there are no such edges (M^{n_i}, M^{n_j}) in $G^d[\widetilde{M}(n_1, n_2, \dots, n_m)]$.

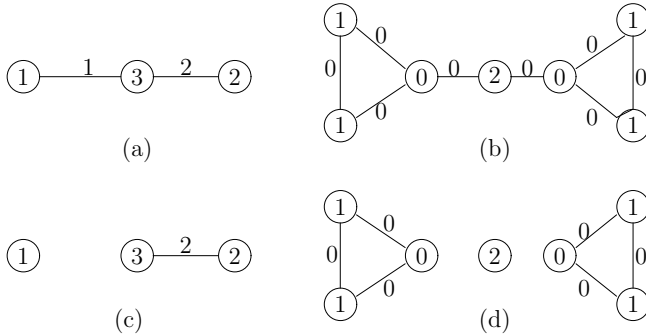

Fig.4.2.2

Theorem 4.2.2 Let $G^d[\widetilde{M}(n_1, n_2, \dots, n_m)]$ be a labelled graph of a finitely combinatorial manifold $\widetilde{M}(n_1, n_2, \dots, n_m)$. Then

- (1) $G^d[\widetilde{M}(n_1, n_2, \dots, n_m)]$ is connected only if $d \leq n_1$.
- (2) there exists an integer $d, d \leq n_1$ such that $G^d[\widetilde{M}(n_1, n_2, \dots, n_m)]$ is connected.

Proof By definition, there is an edge (M^{n_i}, M^{n_j}) in $G^d[\widetilde{M}(n_1, n_2, \dots, n_m)]$ for $1 \leq i, j \leq m$ if and only if there is a d -dimensional path $P^d(p, q)$ connecting two points $p \in M^{n_i}$ and $q \in M^{n_j}$. Notice that

$$(P^d(p, q) \setminus M^{n_i}) \subseteq M^{n_j} \text{ and } (P^d(p, q) \setminus M^{n_j}) \subseteq M^{n_i}.$$

Whence,

$$d \leq \min\{n_i, n_j\}. \tag{4.2.1}$$

Now if $G^d[\widetilde{M}(n_1, n_2, \dots, n_m)]$ is connected, then there is a d -path $P(M^{n_i}, M^{n_j})$ connecting vertices M^{n_i} and M^{n_j} for $\forall M^{n_i}, M^{n_j} \in V(G^d[\widetilde{M}(n_1, n_2, \dots, n_m)])$. Not loss of generality, assume

$$P(M^{n_i}, M^{n_j}) = M^{n_i} M^{s_1} M^{s_2} \dots M^{s_{t-1}} M^{n_j}.$$

Then we get that

$$d \leq \min\{n_i, s_1, s_2, \dots, s_{t-1}, n_j\} \tag{4.2.2}$$

by (4.2.1). However, by definition we know that

$$\bigcup_{p \in \widetilde{M}} \{n_1(p), n_2(p), \dots, n_{s(p)}(p)\} = \{n_1, n_2, \dots, n_m\}. \quad (4.2.3)$$

Therefore, we get that

$$d \leq \min\left(\bigcup_{p \in \widetilde{M}} \{n_1(p), n_2(p), \dots, n_{s(p)}(p)\}\right) = \min\{n_1, n_2, \dots, n_m\} = n_1$$

by combining (4.2.2) with (4.2.3). Notice that points labeled with 0 and 1 are always connected by a path. We get the conclusion (1).

For the conclusion (2), notice that any finitely combinatorial manifold is always pathwise 1-connected by definition. Accordingly, $G^1[\widetilde{M}(n_1, n_2, \dots, n_m)]$ is connected. Thereby, there at least one integer, for instance $d = 1$ enabling $G^d[\widetilde{M}(n_1, n_2, \dots, n_m)]$ to be connected. This completes the proof. \square

According to Theorem 4.2.2, we get immediately two corollaries following.

Corollary 4.2.1 *For a given finitely combinatorial manifold \widetilde{M} , all connected graphs $G^d[\widetilde{M}]$ are isomorphic if $d \leq n_1$, denoted by $G^L[\widetilde{M}]$.*

Corollary 4.2.2 *If there are k 1-manifolds intersect at one point p in a finitely combinatorial manifold \widetilde{M} , then there is an induced subgraph K^{k+1} in $G^L[\widetilde{M}]$.*

Now we define an edge set $E^d(\widetilde{M})$ in $G^L[\widetilde{M}]$ by

$$E^d(\widetilde{M}) = E(G^d[\widetilde{M}]) \setminus E(G^{d+1}[\widetilde{M}]).$$

Then we get a graphical recursion equation for graphs of a finitely combinatorial manifold \widetilde{M} as a by-product.

Theorem 4.2.3 *Let \widetilde{M} be a finitely combinatorial manifold. Then for any integer $d, d \geq 1$, there is a recursion equation*

$$G^{d+1}[\widetilde{M}] = G^d[\widetilde{M}] - E^d(\widetilde{M})$$

for labeled graphs of \widetilde{M} .

Proof It can be obtained immediately by definition. \square

Now let $\mathcal{H}(n_1, n_2, \dots, n_m)$ denote all finitely combinatorial manifolds $\widetilde{M}(n_1, n_2, \dots, n_m)$ and $\mathcal{G}[0, n_m]$ all vertex-edge labeled graphs G^L with $\theta_L : V(G^L) \cup E(G^L) \rightarrow \{0, 1, \dots, n_m\}$ with conditions following hold.

(1)Each induced subgraph by vertices labeled with 1 in G is a union of complete graphs and vertices labeled with 0 can only be adjacent to vertices labeled with 1.

(2)For each edge $e = (u, v) \in E(G)$, $\tau_2(e) \leq \min\{\tau_1(u), \tau_1(v)\}$.

Then we know a relation between sets $\mathcal{H}(n_1, n_2, \dots, n_m)$ and $\mathcal{G}([0, n_m], [0, n_m])$ following.

Theorem 4.2.4 *Let $1 \leq n_1 < n_2 < \dots < n_m, m \geq 1$ be a given integer sequence. Then every finitely combinatorial manifold $\widetilde{M} \in \mathcal{H}(n_1, n_2, \dots, n_m)$ defines a vertex-edge labeled graph $G([0, n_m]) \in \mathcal{G}[0, n_m]$. Conversely, every vertex-edge labeled graph $G([0, n_m]) \in \mathcal{G}[0, n_m]$ defines a finitely combinatorial manifold $\widetilde{M} \in \mathcal{H}(n_1, n_2, \dots, n_m)$ with a 1 – 1 mapping $\theta : G([0, n_m]) \rightarrow \widetilde{M}$ such that $\theta(u)$ is a $\theta(u)$ -manifold in \widetilde{M} , $\tau_1(u) = \dim\theta(u)$ and $\tau_2(v, w) = \dim(\theta(v) \cap \theta(w))$ for $\forall u \in V(G([0, n_m]))$ and $\forall (v, w) \in E(G([0, n_m]))$.*

Proof By definition, for $\forall \widetilde{M} \in \mathcal{H}(n_1, n_2, \dots, n_m)$ there is a vertex-edge labeled graph $G([0, n_m]) \in \mathcal{G}([0, n_m])$ and a 1 – 1 mapping $\theta : \widetilde{M} \rightarrow G([0, n_m])$ such that $\theta(u)$ is a $\theta(u)$ -manifold in \widetilde{M} . For completing the proof, we need to construct a finitely combinatorial manifold $\widetilde{M} \in \mathcal{H}(n_1, n_2, \dots, n_m)$ for $\forall G([0, n_m]) \in \mathcal{G}[0, n_m]$ with $\tau_1(u) = \dim\theta(u)$ and $\tau_2(v, w) = \dim(\theta(v) \cap \theta(w))$ for $\forall u \in V(G([0, n_m]))$ and $\forall (v, w) \in E(G([0, n_m]))$. The construction is carried out by programming following.

STEP 1. Choose $|G([0, n_m])| - |V_0|$ manifolds correspondent to each vertex u with a dimensional n_i if $\tau_1(u) = n_i$, where $V_0 = \{u | u \in V(G([0, n_m])) \text{ and } \tau_1(u) = 0\}$. Denoted by $V_{\geq 1}$ all these vertices in $G([0, n_m])$ with label ≥ 1 .

STEP 2. For $\forall u_1 \in V_{\geq 1}$ with $\tau_1(u_1) = n_{i_1}$, if its neighborhood set $N_{G([0, n_m])}(u_1) \cap V_{\geq 1} = \{v_1^1, v_1^2, \dots, v_1^{s(u_1)}\}$ with $\tau_1(v_1^1) = n_{11}, \tau_1(v_1^2) = n_{12}, \dots, \tau_1(v_1^{s(u_1)}) = n_{1s(u_1)}$, then let the manifold correspondent to the vertex u_1 with an intersection dimension $\tau_2(u_1 v_1^i)$ with manifold correspondent to the vertex v_1^i for $1 \leq i \leq s(u_1)$ and define a vertex set $\Delta_1 = \{u_1\}$.

STEP 3. If the vertex set $\Delta_l = \{u_1, u_2, \dots, u_l\} \subseteq V_{\geq 1}$ has been defined and $V_{\geq 1} \setminus \Delta_l \neq \emptyset$, let $u_{l+1} \in V_{\geq 1} \setminus \Delta_l$ with a label $n_{i_{l+1}}$. Assume

$$(N_{G([0, n_m])}(u_{l+1}) \cap V_{\geq 1}) \setminus \Delta_l = \{v_{l+1}^1, v_{l+1}^2, \dots, v_{l+1}^{s(u_{l+1})}\}$$

with $\tau_1(v_{l+1}^1) = n_{l+1,1}$, $\tau_1(v_{l+1}^2) = n_{l+1,2}$, $\dots, \tau_1(v_{l+1}^{s(u_{l+1})}) = n_{l+1,s(u_{l+1})}$. Then let the manifold correspondent to the vertex u_{l+1} with an intersection dimension $\tau_2(u_{l+1}v_{l+1}^i)$ with the manifold correspondent to the vertex $v_{l+1}^i, 1 \leq i \leq s(u_{l+1})$ and define a vertex set $\Delta_{l+1} = \Delta_l \cup \{u_{l+1}\}$.

STEP 4. Repeat steps 2 and 3 until a vertex set $\Delta_t = V_{\geq 1}$ has been constructed. This construction is ended if there are no vertices $w \in V(G)$ with $\tau_1(w) = 0$, i.e., $V_{\geq 1} = V(G)$. Otherwise, go to the next step.

STEP 5. For $\forall w \in V(G([0, n_m])) \setminus V_{\geq 1}$, assume $N_{G([0, n_m])}(w) = \{w_1, w_2, \dots, w_e\}$. Let all these manifolds correspondent to vertices w_1, w_2, \dots, w_e intersects at one point simultaneously and define a vertex set $\Delta_{t+1}^* = \Delta_t \cup \{w\}$.

STEP 6. Repeat STEP 5 for vertices in $V(G([0, n_m])) \setminus V_{\geq 1}$. This construction is finally ended until a vertex set $\Delta_{t+h}^* = V(G[n_1, n_2, \dots, n_m])$ has been constructed.

A finitely combinatorial manifold \widetilde{M} correspondent to $G([0, n_m])$ is gotten when Δ_{t+h}^* has been constructed. By this construction, it is easily verified that $\widetilde{M} \in \mathcal{H}(n_1, n_2, \dots, n_m)$ with $\tau_1(u) = \dim\theta(u)$ and $\tau_2(v, w) = \dim(\theta(v) \cap \theta(w))$ for $\forall u \in V(G([0, n_m]))$ and $\forall (v, w) \in E(G([0, n_m]))$. This completes the proof. \square

4.2.2 Combinatorial Submanifold. A subset \widetilde{S} of a combinatorial manifold \widetilde{M} is called a *combinatorial submanifold* if it is itself a combinatorial manifold with $G^L[\widetilde{S}] \prec G^L[\widetilde{M}]$. For finding some simple criterions of combinatorial submanifolds, we only consider the case of $F : \widetilde{M} \rightarrow \widetilde{N}$ mapping each manifold of \widetilde{M} to a manifold of \widetilde{N} , denoted by $F : \widetilde{M}_1 \rightarrow_1 \widetilde{N}$, which can be characterized by a purely combinatorial manner. In this case, \widetilde{M} is called a *combinatorial in-submanifold* of \widetilde{N} .

For a given vertex-edge labeled graph $G^L = (V^L, E^L)$ on a graph $G = (V, E)$, its a subgraph is defined to be a connected subgraph $\Gamma \prec G$ with labels $\tau_1|_{\Gamma}(u) \leq \tau_1|_G(u)$ for $\forall u \in V(\Gamma)$ and $\tau_2|_{\Gamma}(u, v) \leq \tau_2|_G(u, v)$ for $\forall (u, v) \in E(\Gamma)$, denoted by $\Gamma^L \prec G^L$. For example, two vertex-edge labeled graphs with an underlying graph K_4 are shown in Fig.4.2.3, in which the vertex-edge labeled graphs (b) and (c) are subgraphs of that (a).

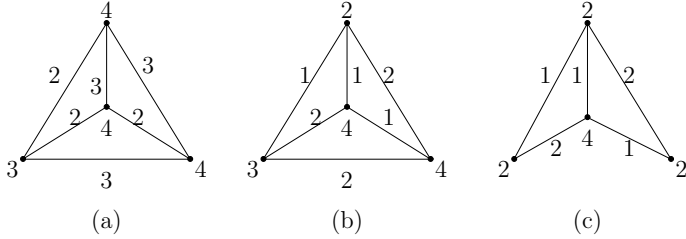

Fig.4.2.3

For characterizing combinatorial in-submanifolds of a combinatorial manifold \widetilde{M} , we introduce the conceptions of *feasible vertex-edge labeled subgraph* and *labeled quotient graph* in the following.

Definition 4.2.2 Let \widetilde{M} be a finitely combinatorial manifold with an underlying graph $G^L[\widetilde{M}]$. For $\forall M \in V(G^L[\widetilde{M}])$ and $U^L \subset N_{G^L[\widetilde{M}]}(M)$ with new labels $\tau_2(M, M_i) \leq \tau_2|_{G^L[\widetilde{M}]}(M, M_i)$ for $\forall M_i \in U^L$, let $J(M_i) = \{M'_i | \dim(M \cap M'_i) = \tau_2(M, M_i), M'_i \subset M_i\}$ and denotes all these distinct representatives of $J(M_i), M_i \in U^L$ by \mathcal{F} . Define the index $o_{\widetilde{M}}(M : U^L)$ of M relative to U^L by

$$o_{\widetilde{M}}(M : U^L) = \min_{J \in \mathcal{F}} \{ \dim(\bigcup_{M' \in J} (M \cap M')) \}.$$

A vertex-edge labeled subgraph Γ^L of $G^L[\widetilde{M}]$ is feasible if for $\forall u \in V(\Gamma^L)$,

$$\tau_1|_{\Gamma}(u) \geq o_{\widetilde{M}}(u : N_{\Gamma^L}(u)).$$

Denoted by $\Gamma^L \prec_o G^L[\widetilde{M}]$ a feasibly vertex-edge labeled subgraph Γ^L of $G^L[\widetilde{M}]$.

Definition 4.2.3 Let \widetilde{M} be a finitely combinatorial manifold, \mathcal{L} a finite set of manifolds and $F_1^1 : \widetilde{M} \rightarrow \mathcal{L}$ an injection such that for $\forall M \in V(G^L[\widetilde{M}])$, there are no two different $N_1, N_2 \in \mathcal{L}$ with $F_1^1(M) \cap N_1 \neq \emptyset, F_1^1(M) \cap N_2 \neq \emptyset$ and for different $M_1, M_2 \in V(G^L[\widetilde{M}])$ with $F_1^1(M_1) \subset N_1, F_1^1(M_2) \subset N_2$, there exist $N'_1, N'_2 \in \mathcal{L}$ enabling that $N_1 \cap N'_1 \neq \emptyset$ and $N_2 \cap N'_2 \neq \emptyset$. A vertex-edge labeled quotient graph $G^L[\widetilde{M}]/F_1^1$ is defined by

$$V(G^L[\widetilde{M}]/F_1^1) = \{N \in \mathcal{L} | \exists M \in V(G^L[\widetilde{M}]) \text{ such that } F_1^1(M) \subset N\},$$

$$E(G^L[\widetilde{M}]/F_1^1) = \{(N_1, N_2) | \exists (M_1, M_2) \in E(G^L[\widetilde{M}]), N_1, N_2 \in \mathcal{L} \text{ such that}$$

$$F_1^1(M_1) \subset N_1, F_1^1(M_2) \subset N_2 \text{ and } F_1^1(M_1) \cap F_1^1(M_2) \neq \emptyset\}$$

and labeling each vertex N with $\dim M$ if $F_1^1(M) \subset N$ and each edge (N_1, N_2) with $\dim(M_1 \cap M_2)$ if $F_1^1(M_1) \subset N_1, F_1^1(M_2) \subset N_2$ and $F_1^1(M_1) \cap F_1^1(M_2) \neq \emptyset$.

Then, we know the following criterion on combinatorial submanifolds.

Theorem 4.2.5 *Let \widetilde{M} and \widetilde{N} be finitely combinatorial manifolds. Then \widetilde{M} is a combinatorial in-submanifold of \widetilde{N} if and only if there exists an injection F_1^1 on \widetilde{M} such that*

$$G^L[\widetilde{M}]/F_1^1 \prec_o \widetilde{N}.$$

Proof If \widetilde{M} is a combinatorial in-submanifold of \widetilde{N} , by definition, we know that there is an injection $F : \widetilde{M} \rightarrow \widetilde{N}$ such that $F(\widetilde{M}) \in V(G[\widetilde{N}])$ for $\forall M \in V(G^L[\widetilde{M}])$ and there are no two different $N_1, N_2 \in \mathcal{L}$ with $F_1^1(M) \cap N_1 \neq \emptyset, F_1^1(M) \cap N_2 \neq \emptyset$. Choose $F_1^1 = F$. Since F is locally 1-1 we get that $F(M_1 \cap M_2) = F(M_1) \cap F(M_2)$, i.e., $F(M_1, M_2) \in E(G[\widetilde{N}])$ or $V(G[\widetilde{N}])$ for $\forall (M_1, M_2) \in E(G^L[\widetilde{M}])$. Whence, $G^L[\widetilde{M}]/F_1^1 \prec G^L[\widetilde{N}]$. Notice that $G^L[\widetilde{M}]$ is correspondent with \widetilde{M} . Whence, it is a feasible vertex-edge labeled subgraph of $G^L[\widetilde{N}]$ by definition. Therefore, $G^L[\widetilde{M}]/F_1^1 \prec_o G^L[\widetilde{N}]$.

Now if there exists an injection F_1^1 on \widetilde{M} , let $\Gamma^L \prec_o G^L[\widetilde{N}]$. Denote by $\overline{\Gamma}$ the graph $G^L[\widetilde{N}] \setminus \Gamma^L$, where $G^L[\widetilde{N}] \setminus \Gamma^L$ denotes the vertex-edge labeled subgraph induced by edges in $G^L[\widetilde{N}] \setminus \Gamma^L$ with non-zero labels in $G[\widetilde{N}]$. We construct a subset \widetilde{M}^* of \widetilde{N} by

$$\widetilde{M}^* = \widetilde{N} \setminus \left(\left(\bigcup_{M' \in V(\overline{\Gamma})} M' \right) \bigcup \left(\bigcup_{(M', M'') \in E(\overline{\Gamma})} (M' \cap M'') \right) \right)$$

and define $\widetilde{M} = F_1^{1-1}(\widetilde{M}^*)$. Notice that any open subset of an n -manifold is also a manifold and $F_1^{1-1}(\Gamma^L)$ is connected by definition. It can be shown that \widetilde{M} is a finitely combinatorial submanifold of \widetilde{N} with $G^L[\widetilde{M}]/F_1^1 \cong \Gamma^L$. \square

An injection $F_1^1 : \widetilde{M} \rightarrow \mathcal{L}$ is *monotonic* if $N_1 \neq N_2$ if $F_1^1(M_1) \subset N_1$ and $F_1^1(M_2) \subset N_2$ for $\forall M_1, M_2 \in V(G^L[\widetilde{M}]), M_1 \neq M_2$. In this case, we get a criterion for combinatorial submanifolds of a finite combinatorial manifold.

Corollary 4.2.3 For two finitely combinatorial manifolds $\widetilde{M}, \widetilde{N}$, \widetilde{M} is a combinatorial monotonic submanifold of \widetilde{N} if and only if $G^L[\widetilde{M}] \prec_o G^L[\widetilde{N}]$.

Proof Notice that $F_1^1 \equiv \mathbf{1}_1^1$ in the monotonic case. Whence, $G^L[\widetilde{M}]/F_1^1 = G^L[\widetilde{M}]/\mathbf{1}_1^1 = G^L[\widetilde{M}]$. Thereafter, by Theorem 4.2.9, we know that \widetilde{M} is a combinatorial monotonic submanifold of \widetilde{N} if and only if $G^L[\widetilde{M}] \prec_o G^L[\widetilde{N}]$. \square

4.2.3 Combinatorial Equivalence. Two finitely combinatorial manifolds $\widetilde{M}_1(n_1, n_2, \dots, n_m), \widetilde{M}_2(k_1, k_2, \dots, k_l)$ are called *equivalent* if these correspondent labeled graphs

$$G^L[\widetilde{M}_1(n_1, n_2, \dots, n_m)] \cong G^L[\widetilde{M}_2(k_1, k_2, \dots, k_l)].$$

Notice that if $\widetilde{M}_1(n_1, n_2, \dots, n_m), \widetilde{M}_2(k_1, k_2, \dots, k_l)$ are equivalent, then we can get that $\{n_1, n_2, \dots, n_m\} = \{k_1, k_2, \dots, k_l\}$ and $G^L[\widetilde{M}_1] \cong G^L[\widetilde{M}_2]$. Reversing this idea enables us classifying finitely combinatorial manifolds in $\mathcal{H}^d(n_1, n_2, \dots, n_m)$ by the action of automorphism groups of these correspondent graphs without labels.

Definition 4.2.4 A labeled connected graph $G^L[\widetilde{M}(n_1, n_2, \dots, n_m)]$ is *combinatorially unique* if all of its correspondent finitely combinatorial manifolds $\widetilde{M}(n_1, n_2, \dots, n_m)$ are equivalent.

Definition 4.2.5 A labeled graph $G[n_1, n_2, \dots, n_m]$ is called *class-transitive* if the automorphism group $\text{Aut}G$ is transitive on $\{C(n_i), 1 \leq i \leq m\}$, where $C(n_i)$ denotes all these vertices with label n_i .

We find a characteristic for combinatorially unique graphs following.

Theorem 4.2.6 A labeled connected graph $G[n_1, n_2, \dots, n_m]$ is *combinatorially unique* if and only if it is class-transitive.

Proof For two integers $i, j, 1 \leq i, j \leq m$, relabel vertices in $C(n_i)$ by n_j and vertices in $C(n_j)$ by n_i in $G[n_1, n_2, \dots, n_m]$. Then we get a new labeled graph $G'[n_1, n_2, \dots, n_m]$ in $\mathcal{G}[n_1, n_2, \dots, n_m]$. According to Theorem 4.2.4, we can get two finitely combinatorial manifolds $\widetilde{M}_1(n_1, n_2, \dots, n_m)$ and $\widetilde{M}_2(k_1, k_2, \dots, k_l)$ correspondent to $G[n_1, n_2, \dots, n_m]$ and $G'[n_1, n_2, \dots, n_m]$.

Now if $G[n_1, n_2, \dots, n_m]$ is combinatorially unique, we know $\widetilde{M}_1(n_1, n_2, \dots, n_m)$ is equivalent to $\widetilde{M}_2(k_1, k_2, \dots, k_l)$, i.e., there is an automorphism $\theta \in \text{Aut}G$ such that

$C^\theta(n_i) = C(n_j)$ for $\forall i, j, 1 \leq i, j \leq m$.

On the other hand, if $G[n_1, n_2, \dots, n_m]$ is class-transitive, then for integers $i, j, 1 \leq i, j \leq m$, there is an automorphism $\tau \in \text{Aut}G$ such that $C^{\tau(n_i)} = C(n_j)$. Whence, for any re-labeled graph $G'[n_1, n_2, \dots, n_m]$, we find that

$$G[n_1, n_2, \dots, n_m] \cong G'[n_1, n_2, \dots, n_m],$$

which implies that these finitely combinatorial manifolds correspondent to $G[n_1, n_2, \dots, n_m]$ and $G'[n_1, n_2, \dots, n_m]$ are combinatorially equivalent, i.e., $G[n_1, n_2, \dots, n_m]$ is combinatorially unique. \square

Now assume that for parameters $t_{i1}, t_{i2}, \dots, t_{is_i}$, we have known an enufunctor

$$C_{M^{n_i}}[x_{i1}, x_{i2}, \dots] = \sum_{t_{i1}, t_{i2}, \dots, t_{is_i}} n_i(t_{i1}, t_{i2}, \dots, t_{is_i}) x_{i1}^{t_{i1}} x_{i2}^{t_{i2}} \dots x_{is_i}^{t_{is_i}}$$

for n_i -manifolds, where $n_i(t_{i1}, t_{i2}, \dots, t_{is_i})$ denotes the number of non-homeomorphic n_i -manifolds with parameters $t_{i1}, t_{i2}, \dots, t_{is_i}$. For instance the enufunctor for compact 2-manifolds with parameter genera is

$$C_{\widetilde{M}}[x](2) = 1 + \sum_{p \geq 1} 2x^p.$$

Consider the action of $\text{Aut}G[n_1, n_2, \dots, n_m]$ on $G[n_1, n_2, \dots, n_m]$. If the number of orbits of the automorphism group $\text{Aut}G[n_1, n_2, \dots, n_m]$ action on $\{C(n_i), 1 \leq i \leq m\}$ is π_0 , then we can only get $\pi_0!$ non-equivalent combinatorial manifolds correspondent to the labeled graph $G[n_1, n_2, \dots, n_m]$ similar to Theorem 2.4. Calculation shows that there are $l!$ orbits action by its automorphism group for a complete $(s_1 + s_2 + \dots + s_l)$ -partite graph $K(k_1^{s_1}, k_2^{s_2}, \dots, k_l^{s_l})$, where $k_i^{s_i}$ denotes that there are s_i partite sets of order k_i in this graph for any integer $i, 1 \leq i \leq l$, particularly, for $K(n_1, n_2, \dots, n_m)$ with $n_i \neq n_j$ for $i, j, 1 \leq i, j \leq m$, the number of orbits action by its automorphism group is $m!$. Summarizing all these discussions, we get an enufunctor for these finitely combinatorial manifolds $\widetilde{M}(n_1, n_2, \dots, n_m)$ correspondent to a labeled graph $G[n_1, n_2, \dots, n_m]$ in $\mathcal{G}(n_1, n_2, \dots, n_m)$ with each label ≥ 1 .

Theorem 4.2.7 *Let $G[n_1, n_2, \dots, n_m]$ be a labelled graph in $\mathcal{G}(n_1, n_2, \dots, n_m)$ with each label ≥ 1 . For an integer $i, 1 \leq i \leq m$, let the enufunctor of non-homeomorphic n_i -manifolds with given parameters t_1, t_2, \dots , be $C_{M^{n_i}}[x_{i1}, x_{i2}, \dots]$ and π_0 the number of orbits of the automorphism group $\text{Aut}G[n_1, n_2, \dots, n_m]$ action on $\{C(n_i), 1 \leq$*

$i \leq m\}$, then the enufnction of combinatorial manifolds $\widetilde{M}(n_1, n_2, \dots, n_m)$ correspondent to a labeled graph $G[n_1, n_2, \dots, n_m]$ is

$$C_{\widetilde{M}}(\vec{x}) = \pi_0! \prod_{i=1}^m C_{M^{n_i}}[x_{i1}, x_{i2}, \dots],$$

particularly, if $G[n_1, n_2, \dots, n_m] = K(k_1^{s_1}, k_2^{s_2}, \dots, k_m^{s_m})$ such that the number of partite sets labeled with n_i is s_i for any integer $i, 1 \leq i \leq m$, then the enufnction correspondent to $K(k_1^{s_1}, k_2^{s_2}, \dots, k_m^{s_m})$ is

$$C_{\widetilde{M}}(\vec{x}) = m! \prod_{i=1}^m C_{M^{n_i}}[x_{i1}, x_{i2}, \dots]$$

and the enufnction correspondent to a complete graph K_m is

$$C_{\widetilde{M}}(\vec{x}) = \prod_{i=1}^m C_{M^{n_i}}[x_{i1}, x_{i2}, \dots].$$

Proof Notice that the number of non-equivalent finitely combinatorial manifolds correspondent to $G[n_1, n_2, \dots, n_m]$ is

$$\pi_0 \prod_{i=1}^m n_i(t_{i1}, t_{i2}, \dots, t_{is})$$

for parameters $t_{i1}, t_{i2}, \dots, t_{is}, 1 \leq i \leq m$ by the product principle of enumeration. Whence, the enufnction of combinatorial manifolds $\widetilde{M}(n_1, n_2, \dots, n_m)$ correspondent to a labeled graph $G[n_1, n_2, \dots, n_m]$ is

$$\begin{aligned} C_{\widetilde{M}}(\vec{x}) &= \sum_{t_{i1}, t_{i2}, \dots, t_{is}} (\pi_0 \prod_{i=1}^m n_i(t_{i1}, t_{i2}, \dots, t_{is})) \prod_{i=1}^m x_{i1}^{t_{i1}} x_{i2}^{t_{i2}} \dots x_{is}^{t_{is}} \\ &= \pi_0! \prod_{i=1}^m C_{M^{n_i}}[x_{i1}, x_{i2}, \dots]. \quad \spadesuit \end{aligned}$$

4.2.4 Homotopy Class. Denote by $f \simeq g$ two homotopic mappings f and g . Two finitely combinatorial manifolds $\widetilde{M}(k_1, k_2, \dots, k_l), \widetilde{M}(n_1, n_2, \dots, n_m)$ are said to be *homotopically equivalent* if there exist continuous mappings

$$f : \widetilde{M}(k_1, k_2, \dots, k_l) \rightarrow \widetilde{M}(n_1, n_2, \dots, n_m),$$

$$g : \widetilde{M}(n_1, n_2, \dots, n_m) \rightarrow \widetilde{M}(k_1, k_2, \dots, k_l)$$

such that $gf \simeq \text{identity} : \widetilde{M}(k_1, k_2, \dots, k_l) \rightarrow \widetilde{M}(k_1, k_2, \dots, k_l)$ and $fg \simeq \text{identity} : \widetilde{M}(n_1, n_2, \dots, n_m) \rightarrow \widetilde{M}(n_1, n_2, \dots, n_m)$.

For equivalent homotopically combinatorial manifolds, we know the following result.

Theorem 4.2.8 *Let $\widetilde{M}(n_1, n_2, \dots, n_m)$ and $\widetilde{M}(k_1, k_2, \dots, k_l)$ be finitely combinatorial manifolds with an equivalence $\varpi : G^L[\widetilde{M}(n_1, n_2, \dots, n_m)] \rightarrow G^L[\widetilde{M}(k_1, k_2, \dots, k_l)]$. If for $\forall M_1, M_2 \in V(G^L[\widetilde{M}(n_1, n_2, \dots, n_m)])$, M_i is homotopic to $\varpi(M_i)$ with homotopic mappings $f_{M_i} : M_i \rightarrow \varpi(M_i)$, $g_{M_i} : \varpi(M_i) \rightarrow M_i$ such that $f_{M_i}|_{M_i \cap M_j} = f_{M_j}|_{M_i \cap M_j}$, $g_{M_i}|_{M_i \cap M_j} = g_{M_j}|_{M_i \cap M_j}$ providing $(M_i, M_j) \in E(G^L[\widetilde{M}(n_1, n_2, \dots, n_m)])$ for $1 \leq i, j \leq m$, then $\widetilde{M}(n_1, n_2, \dots, n_m)$ is homotopic to $\widetilde{M}(k_1, k_2, \dots, k_l)$.*

Proof By the Gluing Lemma, there are continuous mappings

$$f : \widetilde{M}(n_1, n_2, \dots, n_m) \rightarrow \widetilde{M}(k_1, k_2, \dots, k_l)$$

and

$$g : \widetilde{M}(k_1, k_2, \dots, k_l) \rightarrow \widetilde{M}(n_1, n_2, \dots, n_m)$$

such that

$$f|_M = f_M \text{ and } g|_{\varpi(M)} = g_{\varpi(M)}$$

for $\forall M \in V(G^L[\widetilde{M}(n_1, n_2, \dots, n_m)])$. Thereby, we also get that

$$gf \simeq \text{identity} : \widetilde{M}(k_1, k_2, \dots, k_l) \rightarrow \widetilde{M}(k_1, k_2, \dots, k_l)$$

and

$$fg \simeq \text{identity} : \widetilde{M}(n_1, n_2, \dots, n_m) \rightarrow \widetilde{M}(n_1, n_2, \dots, n_m)$$

as a result of

$$g_M f_M \simeq \text{identity} : M \rightarrow M,$$

and

$$f_M g_M \simeq \text{identity} : \varpi(M) \rightarrow \varpi(M)$$

for $\forall M \in V(G^L[\widetilde{M}(n_1, n_2, \dots, n_m)])$. □

4.2.5 Euler-Poincaré Characteristic. It is well-known that the integer

$$\chi(\mathfrak{M}) = \sum_{i=0}^{\infty} (-1)^i \alpha_i$$

with α_i the number of i -dimensional cells in a CW -complex \mathfrak{M} is defined to be the Euler-Poincaré characteristic of this complex. In this subsection, we get the Euler-Poincaré characteristic for finitely combinatorial manifolds. For this objective, define a clique sequence $\{Cl(i)\}_{i \geq 1}$ in the graph $G^L[\widetilde{M}]$ by the following programming.

STEP 1. Let $Cl(G^L[\widetilde{M}]) = l_0$. Construct

$$Cl(l_0) = \{K_1^{l_0}, K_2^{l_0}, \dots, K_p^{i_0} | K_i^{l_0} \succ G^L[\widetilde{M}] \text{ and } K_i^{l_0} \cap K_j^{l_0} = \emptyset, \\ \text{or a vertex } \in V(G^L[\widetilde{M}]) \text{ for } i \neq j, 1 \leq i, j \leq p\}.$$

STEP 2. Let $G_1 = \bigcup_{K^l \in Cl(l)} K^l$ and $Cl(G^L[\widetilde{M}] \setminus G_1) = l_1$. Construct

$$Cl(l_1) = \{K_1^{l_1}, K_2^{l_1}, \dots, K_q^{i_1} | K_i^{l_1} \succ G^L[\widetilde{M}] \text{ and } K_i^{l_1} \cap K_j^{l_1} = \emptyset \\ \text{or a vertex } \in V(G^L[\widetilde{M}]) \text{ for } i \neq j, 1 \leq i, j \leq q\}.$$

STEP 3. Assume we have constructed $Cl(l_{k-1})$ for an integer $k \geq 1$. Let $G_k = \bigcup_{K^{l_{k-1}} \in Cl(l)} K^{l_{k-1}}$ and $Cl(G^L[\widetilde{M}] \setminus (G_1 \cup \dots \cup G_k)) = l_k$. We construct

$$Cl(l_k) = \{K_1^{l_k}, K_2^{l_k}, \dots, K_r^{i_k} | K_i^{l_k} \succ G^L[\widetilde{M}] \text{ and } K_i^{l_k} \cap K_j^{l_k} = \emptyset, \\ \text{or a vertex } \in V(G^L[\widetilde{M}]) \text{ for } i \neq j, 1 \leq i, j \leq r\}.$$

STEP 4. Continue STEP 3 until we find an integer t such that there are no edges in $G^L[\widetilde{M}] \setminus \bigcup_{i=1}^t G_i$.

By this clique sequence $\{Cl(i)\}_{i \geq 1}$, we can calculate the Euler-Poincaré characteristic of finitely combinatorial manifolds.

Theorem 4.2.9 *Let \widetilde{M} be a finitely combinatorial manifold. Then*

$$\chi(\widetilde{M}) = \sum_{K^k \in Cl(k), k \geq 2} \sum_{M_{i_j} \in V(K^k), 1 \leq j \leq s \leq k} (-1)^{s+1} \chi(M_{i_1} \cap \dots \cap M_{i_s})$$

Proof Denoted the numbers of all these i -dimensional cells in a combinatorial manifold \widetilde{M} or in a manifold M by $\widetilde{\alpha}_i$ and $\alpha_i(M)$. If $G^L[\widetilde{M}]$ is nothing but a complete graph K^k with $V(G^L[\widetilde{M}]) = \{M_1, M_2, \dots, M_k\}$, $k \geq 2$, by applying the inclusion-exclusion principle and the definition of Euler-Poincaré characteristic we get that

$$\begin{aligned} \chi(\widetilde{M}) &= \sum_{i=0}^{\infty} (-1)^i \widetilde{\alpha}_i \\ &= \sum_{i=0}^{\infty} (-1)^i \sum_{M_{i_j} \in V(K^k), 1 \leq j \leq s \leq k} (-1)^{s+1} \alpha_i(M_{i_1} \cap \dots \cap M_{i_s}) \\ &= \sum_{M_{i_j} \in V(K^k), 1 \leq j \leq s \leq k} (-1)^{s+1} \sum_{i=0}^{\infty} (-1)^i \alpha_i(M_{i_1} \cap \dots \cap M_{i_s}) \\ &= \sum_{M_{i_j} \in V(K^k), 1 \leq j \leq s \leq k} (-1)^{s+1} \chi(M_{i_1} \cap \dots \cap M_{i_s}) \end{aligned}$$

for instance, $\chi(\widetilde{M}) = \chi(M_1) + \chi(M_2) - \chi(M_1 \cap M_2)$ if $G^L[\widetilde{M}] = K^2$ and $V(G^L[\widetilde{M}]) = \{M_1, M_2\}$. By the definition of clique sequence of $G^L[\widetilde{M}]$, we finally obtain that

$$\chi(\widetilde{M}) = \sum_{K^k \in Cl(k), k \geq 2} \sum_{M_{i_j} \in V(K^k), 1 \leq j \leq s \leq k} (-1)^{i+1} \chi(M_{i_1} \cap \dots \cap M_{i_s}).$$

□

If $G^L[\widetilde{M}]$ is just one of some special graphs, we can get interesting consequences by Theorem 4.2.14.

Corollary 4.2.4 *Let \widetilde{M} be a finitely combinatorial manifold. If $G^L[\widetilde{M}]$ is K^3 -free, then*

$$\chi(\widetilde{M}) = \sum_{M \in V(G^L[\widetilde{M}])} \chi^2(M) - \sum_{(M_1, M_2) \in E(G^L[\widetilde{M}])} \chi(M_1 \cap M_2).$$

Particularly, if $\dim(M_1 \cap M_2)$ is a constant for any $(M_1, M_2) \in E(G^L[\widetilde{M}])$, then

$$\chi(\widetilde{M}) = \sum_{M \in V(G^L[\widetilde{M}])} \chi^2(M) - \chi(M_1 \cap M_2) |E(G^L[\widetilde{M}])|.$$

Proof Notice that $G^L[\widetilde{M}]$ is K^3 -free, we get that

$$\begin{aligned} \chi(\widetilde{M}) &= \sum_{(M_1, M_2) \in E(G^L[\widetilde{M}])} (\chi(M_1) + \chi(M_2) - \chi(M_1 \cap M_2)) \\ &= \sum_{(M_1, M_2) \in E(G^L[\widetilde{M}])} (\chi(M_1) + \chi(M_2)) - \sum_{(M_1, M_2) \in E(G^L[\widetilde{M}])} \chi(M_1 \cap M_2) \\ &= \sum_{M \in V(G^L[\widetilde{M}])} \chi^2(M) - \sum_{(M_1, M_2) \in E(G^L[\widetilde{M}])} \chi(M_1 \cap M_2). \end{aligned}$$

□

Since the Euler-Poincaré characteristic of a manifold M is 0 if $\dim M \equiv 1 \pmod{2}$, we get the following consequence.

Corollary 4.2.5 *Let \widetilde{M} be a finitely combinatorial manifold with odd dimension number for any intersection of k manifolds with $k \geq 2$. Then*

$$\chi(\widetilde{M}) = \sum_{M \in V(G^L[\widetilde{M}])} \chi(M).$$

§4.3 FUNDAMENTAL GROUPS OF

COMBINATORIAL MANIFOLDS

4.3.1 Retraction. Let $\varphi : X \rightarrow Y$ be a continuous mapping from topological spaces X to Y and $a, b : I \rightarrow X$ be paths in X . It is readily that if $a \simeq b$ in X , then $\varphi([a]) \simeq \varphi([b])$ in Y , thus φ induce a mapping φ_* from $\pi(X, x_0)$ to $\pi(Y, \varphi(x_0))$ with properties following hold.

(i) If $[a]$ and $[b]$ are path classes in X such that $[a] \cdot [b]$ is defined, then $\varphi_*([a] \cdot [b]) = \varphi_*([a]) \cdot \varphi_*([b])$;

(ii) $\varphi_*(\epsilon_x) = \epsilon_{\varphi_*(x)}$ for $\forall x \in X$;

(iii) $\varphi_*([a]^{-1}) = (\varphi_*([a]))^{-1}$;

(iv) If $\psi : Y \rightarrow Z$ is also a continuous mapping, then $(\psi\varphi)_* = \psi_*\varphi_*$;

(v) If $\varphi : X \rightarrow X$ is the identity mapping, then $\varphi_*([a]) = [a]$ for $\forall [a] \in \pi(X, x_0)$.

Such a φ_* is called a *homomorphism induced by φ* , particularly, a *isomorphism induced by φ* if φ is an isomorphism.

Definition 4.3.1 *A subset R of a topological space S is called a retract of S if there exists a continuous mapping $o : S \rightarrow R$, called a retraction such that $o(a) = a$ for $\forall a \in R$.*

Now let $o : S \rightarrow R$ be a retraction and $i : R \hookrightarrow S$ a inclusion mapping. For any point $x \in R$, we consider the induced homomorphism

$$o_* : \pi(S, x) \rightarrow \pi(R, x), \quad i_* : \pi(R, x) \rightarrow \pi(S, x).$$

Notice that $oi = \text{identity mapping}$ by definition, which implies that o_*i_* is an identity mapping of the group $\pi(R, x_0)$ by properties (iv) and (v) previously.

Definition 4.3.2 *A subset R of a topological space S is called a deformation retract of S if there exists a retraction $o : S \rightarrow R$ and a homotopy $f : S \times I \rightarrow S$ such that*

$$f(x, 0) = x, \quad f(x, 1) = o(x) \quad \text{for } \forall x \in S,$$

$$f(a, t) = a \quad \text{for } \forall a \in R, \quad t \in I.$$

Theorem 4.3.1 *If R is a deformation retract of a topological space S , then the inclusion mapping $i : R \rightarrow S$ induces an isomorphism of $\pi(R, x_0)$ onto $\pi(S, x_0)$ for $\forall x_0 \in R$, i.e., $\pi(R, x_0) \cong \pi(S, x_0)$*

Proof As we have just mentioned, o_*i_* is the identity mapping. By definition, $io : X \rightarrow X$ is an identity mapping with $io(x_0) = x_0$. Whence, $(io)_* = i_*o_*$ is the identity mapping of $\pi(S, x_0)$, which implies that i_* is an isomorphism from $\pi(R, x_0)$ to $\pi(S, x_0)$. \square

Definition 4.3.3 *A topological space S is contractible to a point if there exists a point $x_0 \in S$ such that $\{x_0\}$ is a deformation retract of S .*

Corollary 4.3.1 *A topological space S is simply connected if it is contractible.*

Combining this conclusion with the *Seifert and Van-Kampen theorem*, we determine the fundamental groups of combinatorial manifolds \widetilde{M} in some cases related with its combinatorial structure $G^L[\widetilde{M}]$ in the following subsections.

4.3.2 Fundamental d-Group. Let a finitely combinatorial manifold $\widetilde{M}(n_1, n_2, \dots, n_m)$ be d -arcwise connected for some integers $1 \leq d \leq n_1$. Similar to fundamental group, we consider fundamental d -groups of finitely combinatorial manifolds in this subsection.

Definition 4.3.4 Let $\widetilde{M}(n_1, n_2, \dots, n_m)$ be a finitely combinatorial manifold of d -arcwise connectedness for an integer $d, 1 \leq d \leq n_1$ and $\forall x_0 \in \widetilde{M}(n_1, n_2, \dots, n_m)$, a fundamental d -group at the point x_0 , denoted by $\pi^d(\widetilde{M}(n_1, n_2, \dots, n_m), x_0)$ is defined to be a group generated by all homotopic classes of closed d -pathes based at x_0 .

If $d = 1$ and $\widetilde{M}(n_1, n_2, \dots, n_m)$ is just a manifold M , we get that

$$\pi^d(\widetilde{M}(n_1, n_2, \dots, n_m), x) = \pi_1(M, x).$$

Whence, fundamental d -groups are a generalization of fundamental groups in classical topology.

A combinatorial Euclidean space $\mathcal{E}_G(\overbrace{d, d, \dots, d}^m)$ of \mathbf{R}^d underlying a combinatorial structure $G, |G| = m$ is called a d -dimensional graph, denoted by $\widetilde{M}^d[G]$ if

- (1) $\widetilde{M}^d[G] \setminus V(\widetilde{M}^d[G])$ is a disjoint union of a finite number of open subsets e_1, e_2, \dots, e_m , each of which is homeomorphic to an open ball B^d ;
- (2) the boundary $\bar{e}_i - e_i$ of e_i consists of one or two vertices B^d , and each pair (\bar{e}_i, e_i) is homeomorphic to the pair (\bar{B}^d, S^{d-1}) ,

The next result is gotten by definition.

Theorem 4.3.2 $\pi^d(\widetilde{M}^d[G], x_0) \cong \pi_1(G, x_0), x_0 \in G.$ □

For determining the d -fundamental group of combinatorial manifolds, an easily case is the adjunctions of s -balls to a connected d -dimensional graph, i.e., there exists an arcwise connected combinatorial submanifold $\widetilde{M}^d[G] \prec \widetilde{M}(n_1, n_2, \dots, n_m)$ such that

$$\widetilde{M}(n_1, n_2, \dots, n_m) \setminus \widetilde{M}^d[G] = \bigcup_{i=2}^k \bigcup_{j=1}^{l_i} B_{i_j},$$

where B_{i_j} is the i -ball B^i for integers $1 \leq i \leq k, 1 \leq j \leq l_i$. We know the following result.

Theorem 4.3.3 Let $\widetilde{M}(n_1, n_2, \dots, n_m)$ be a finitely combinatorial manifold underlying a combinatorial structure G , $\widetilde{M}^d[G] \prec \widetilde{M}(n_1, n_2, \dots, n_m)$ such that

$$\widetilde{M}(n_1, n_2, \dots, n_m) \setminus \widetilde{M}^d[G] = \bigcup_{i=2}^k \bigcup_{j=1}^{l_i} B_{i_j},$$

$x_0 \in \widetilde{M}^d[G]$. Then

$$\pi^d(\widetilde{M}(n_1, n_2, \dots, n_m), x_0) \cong \frac{\pi_1(G, x_0)}{\langle \beta_{2_j} \alpha_{2_j} \beta_{2_j}^{-1} \mid 1 \leq j \leq l_2 \rangle^N},$$

where α_{2_j} is the closed path of B_{2_j} and β_{2_j} a path in X with an initial point x_0 and terminal point on α_{2_j} .

Proof For any s -ball B_{s_j} , $1 \leq j \leq l_s$, choose one point $u_{s0_j} \in B_{s_j}$. Define $U = \widetilde{M}(n_1, n_2, \dots, n_m) \setminus \{u_{s0_j}\}$ and $V = B_{s_j}$. Then U, V are open sets and $\widetilde{M}(n_1, n_2, \dots, n_m) = U \cup V$. Notice that $U, V, V \cap U = B_{s_j} \setminus \{u_{s0_j}\}$ are arcwise connected and V simply connected. Applying Corollary 3.1.2 and Theorem 4.3.2, we get that

$$\pi^d(\widetilde{M}(n_1, n_2, \dots, n_m), x_0) \cong \frac{\pi(G, x_0)}{\langle \pi_1(U \cap V) \rangle^N} = \frac{\pi(G, x_0)}{\langle i_{1*}(\pi_1(B_{s_j} \setminus \{u_{s0_j}\})) \rangle^N}.$$

Since

$$\pi_1(B_{s_j} \setminus \{u_{s0_j}\}) = \begin{cases} \mathbf{Z}, & \text{if } s = 2, \\ \{1\}, & \text{if } s \geq 3, \end{cases}$$

we find that

$$\pi^d(\widetilde{M}(n_1, n_2, \dots, n_m), x_0) \cong \begin{cases} \frac{\pi_1(G, x_0)}{i_{1*}(\pi_1(B_{2_j} \setminus \{u_{20_j}\}))}, & \text{if } s = 2, \\ \pi_1(G, x_0), & \text{if } s \geq 3. \end{cases}$$

Notice that $\langle i_{1*}(\pi_1(B_{2_j} \setminus \{u_{20_j}\})) \rangle^N = \langle \beta_{2_j} \alpha_{2_j} \beta_{2_j}^{-1} \rangle^N$. Applying the induction principle on integers i, j , $2 \leq i \leq k$, $1 \leq j \leq l_i$, we finally get the fundamental d -group of $\widetilde{M}(n_1, n_2, \dots, n_m)$ with a base point x_0 following, i.e.,

$$\pi^d(\widetilde{M}(n_1, n_2, \dots, n_m), x_0) \cong \frac{\pi_1(G, x_0)}{\langle \beta_{2_j} \alpha_{2_j} \beta_{2_j}^{-1} \mid 1 \leq j \leq l_2 \rangle^N}.$$

This completes the proof. \square

Corollary 4.3.2 *Let $\widetilde{M}(n_1, n_2, \dots, n_m)$ be a finitely combinatorial manifold underlying a combinatorial structure G , $\widetilde{M}^d[G] \prec \widetilde{M}(n_1, n_2, \dots, n_m)$ such that*

$$\widetilde{M}(n_1, n_2, \dots, n_m) \setminus \widetilde{M}^d[G] = \bigcup_{i \geq 3}^{l_i} B_{i_j},$$

$x_0 \in \widetilde{M}^d[G]$. Then

$$\pi^d(\widetilde{M}(n_1, n_2, \dots, n_m), x_0) \cong \pi_1(G, x_0).$$

Corollary 4.3.3 *Let $\widetilde{M}(n_1, n_2, \dots, n_m)$ be a finitely combinatorial manifold underlying a combinatorial structure G , $\widetilde{M}^d[G] \prec \widetilde{M}(n_1, n_2, \dots, n_m)$ such that*

$$\widetilde{M}(n_1, n_2, \dots, n_m) \setminus \widetilde{M}^d[G] = \bigcup_{i=1}^k B_{2_i},$$

$x_0 \in \widetilde{M}^d[G]$. Then

$$\pi^d(\widetilde{M}(n_1, n_2, \dots, n_m), x_0) \cong \frac{\pi_1(G, x_0)}{\langle \beta_{2_i} \alpha_{2_i} \beta_{2_i}^{-1} \mid 1 \leq i \leq k \rangle^N},$$

where α_{2_i} is the closed path of B_{2_i} and β_{2_i} a path in X with an initial point x_0 and terminal point on α_{2_i} .

A *combinatorial map* is a connected graph G cellularly embedded in a surface S ([Liu2] and [Mao1]). For these fundamental groups of surfaces, we can also represent them by graphs applying Corollary 4.3.3.

Corollary 4.3.4 *Let M be a combinatorial map underlying a connected graph G on a locally orientable surface S . Then for a point $x_0 \in G$,*

$$\pi_1(S, x_0) \cong \frac{\pi_1(G, x_0)}{\langle \partial f \mid f \in F(M) \rangle^N},$$

where $F(M)$ denotes the face set of M and ∂f the boundary of a face $f \in F(M)$.

We obtain the following characteristics for fundamental d -groups of finitely combinatorial manifolds if their intersection of two by two is either empty or simply connected.

Theorem 4.3.4 Let $\widetilde{M}(n_1, n_2, \dots, n_m)$ be a d -connected finitely combinatorial manifold for an integer d , $1 \leq d \leq n_1$. If $\forall (M_1, M_2) \in E(G^L[\widetilde{M}(n_1, n_2, \dots, n_m)])$, $M_1 \cap M_2$ is simply connected, then

- (1) for $\forall x_0 \in G^d$, $M \in V(G^L[\widetilde{M}(n_1, n_2, \dots, n_m)])$ and $x_{0M} \in M$,

$$\pi^d(\widetilde{M}(n_1, n_2, \dots, n_m), x_0) \cong \left(\bigoplus_{M \in V(G^d)} \pi^d(M, x_{M0}) \right) \bigoplus \pi(G^d, x_0),$$

where $G^d = G^d[\widetilde{M}(n_1, n_2, \dots, n_m)]$ in which each edge (M_1, M_2) passing through a given point $x_{M_1 M_2} \in M_1 \cap M_2$, $\pi^d(M, x_{M0}), \pi(G^d, x_0)$ denote the fundamental d -groups of a manifold M and the graph G^d , respectively and

- (2) for $\forall x, y \in \widetilde{M}(n_1, n_2, \dots, n_m)$,

$$\pi^d(\widetilde{M}(n_1, n_2, \dots, n_m), x) \cong \pi^d(\widetilde{M}(n_1, n_2, \dots, n_m), y).$$

Proof Applying Corollary 3.1.3, we firstly prove that the fundamental d -groups of two arcwise connected spaces S_1 and S_2 are equal if there exist arcwise connected subspaces $U, V \subset S_1$, $U, V \subset S_2$ such that $U \cap V$ is simply connected in S_1 and $U \cap V = \{z_0\}$ in S_2 , such as those shown in Fig.4.3.1.

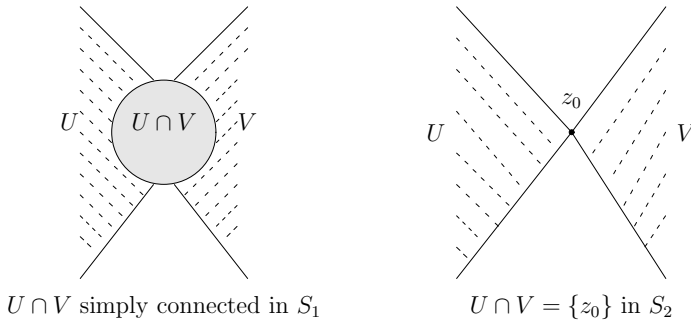

Fig.4.3.1

In fact, we know that

$$\pi_1(S_1, x_0) = \pi_1(U, x_0)\pi_1(V, x_0)$$

for $x_0 \in U \cap V$ and

$$\pi_1(S_2, z_0) = \pi_1(U, z_0)\pi_1(V, z_0)$$

by Corollary 3.1.3. Whence, $\pi_1(S_1, x_0) = \pi_1(S_2, z_0)$. Therefore, we only need to determine equivalently the fundamental d-group of a new combinatorial manifold $\widetilde{M}^*(n_1, n_2, \dots, n_m)$, which is obtained by replacing each pairs $M_1 \cap M_2 \neq \emptyset$ in $\widetilde{M}(n_1, n_2, \dots, n_m)$ by $M_1 \cap M_2 = \{x_{M_1 M_2}\}$, such as those shown in Fig.4.3.2.

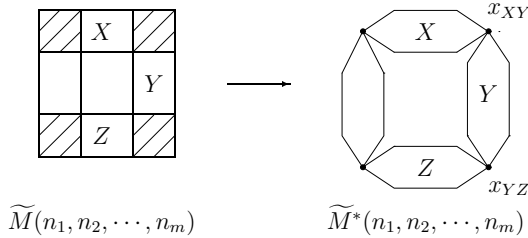

Fig.4.3.2

For proving the conclusion (1), we only need to prove that for any cycle \widetilde{C} in $\widetilde{M}(n_1, n_2, \dots, n_m)$, there are elements $C_1^M, C_2^M, \dots, C_{l(M)}^M \in \pi^d(M)$, $\alpha_1, \alpha_2, \dots, \alpha_{\beta(G^d)} \in \pi(G^d)$ and integers a_i^M, b_j for $\forall M \in V(G^d)$ and $1 \leq i \leq l(M)$, $1 \leq j \leq c(G^d) \leq \beta(G^d)$ such that

$$\widetilde{C} \equiv \sum_{M \in V(G^d)} \sum_{i=1}^{l(M)} a_i^M C_i^M + \sum_{j=1}^{c(G^d)} b_j \alpha_j \pmod{2}$$

and it is unique. Let $C_1^M, C_2^M, \dots, C_{b(M)}^M$ be a base of $\pi^d(M)$ for $\forall M \in V(G^d)$. Since \widetilde{C} is a closed trail, \widetilde{C} passes through a point $x_{M_1 M_2}$ even times or it pass through cycles in G^d . Whence there exist integers $k_i^M, l_j, 1 \leq i \leq b(M), 1 \leq j \leq \beta(G^d)$ and h_P for an open d -path on \widetilde{C} such that

$$\widetilde{C} = \sum_{M \in V(G^d)} \sum_{i=1}^{b(M)} k_i^M C_i^M + \sum_{j=1}^{\beta(G^d)} l_j \alpha_j + \sum_{P \in \Delta} h_P P,$$

where $h_P \equiv 0 \pmod{2}$ and Δ denotes all of these open d -paths on \widetilde{C} . Now let

$$\{a_i^M | 1 \leq i \leq l(M)\} = \{k_i^M | k_i^M \neq 0 \text{ and } 1 \leq i \leq b(M)\},$$

$$\{b_j | 1 \leq j \leq c(G^d)\} = \{l_j | l_j \neq 0, 1 \leq j \leq \beta(G^d)\}.$$

Then we get that

$$\tilde{C} \equiv \sum_{M \in V(G^d)} \sum_{i=1}^{l(M)} a_i^M C_i^M + \sum_{j=1}^{c(G^d)} b_j \alpha_j \pmod{2}. \quad (3.4.1)$$

The formula (3.4.1) provides with us

$$[C] \in \left(\bigoplus_{M \in V(G^d)} \pi^d(M, x_{M0}) \right) \bigoplus \pi(G^d, x_0).$$

If there is another decomposition

$$\tilde{C} \equiv \sum_{M \in V(G^d)} \sum_{i=1}^{l'(M)} a'_i C_i^M + \sum_{j=1}^{c'(G^d)} b'_j \alpha_j \pmod{2},$$

not loss of generality, assume $l'(M) \leq l(M)$ and $c'(M) \leq c(M)$, then we know that

$$\sum_{M \in V(G^d)} \sum_{i=1}^{l(M)} (a_i^M - a'_i) C_i^M + \sum_{j=1}^{c(G^d)} (b_j - b'_j) \alpha_j = 0,$$

where $a_i^M = 0$ if $i > l(M)$, $b'_j = 0$ if $j' > c'(M)$. Since $C_i^M, 1 \leq i \leq b(M)$ and $\alpha_j, 1 \leq j \leq \beta(G^d)$ are bases of the fundamental group $\pi(M)$ and $\pi(G^d)$ respectively, we must have

$$a_i^M = a'_i, 1 \leq i \leq l(M) \text{ and } b_j = b'_j, 1 \leq j \leq c(G^d).$$

Whence, \tilde{C} can be decomposed uniquely into (3.4.1). Thereafter, we finally get that

$$\pi^d(\tilde{M}(n_1, n_2, \dots, n_m), x_0) \supseteq \left(\bigoplus_{M \in V(G^d)} \pi^d(M, x_{M0}) \right) \bigoplus \pi(G^d, x_0).$$

For proving the conclusion (2), notice that $\tilde{M}(n_1, n_2, \dots, n_m)$ is arcwise d -connected. Let $P^d(x, y)$ be a d -path connecting points x and y in $\tilde{M}(n_1, n_2, \dots, n_m)$. Define

$$\omega_*(C) = P^d(x, y)C(P^d)^{-1}(x, y)$$

for $\forall C \in \widetilde{M}(n_1, n_2, \dots, n_m)$. Then it can be checked immediately that

$$\omega_* : \pi^d(\widetilde{M}(n_1, n_2, \dots, n_m), x) \rightarrow \pi^d(\widetilde{M}(n_1, n_2, \dots, n_m), y)$$

is an isomorphism. □

A d -connected finitely combinatorial manifold $\widetilde{M}(n_1, n_2, \dots, n_m)$ is said to be *simply d -connected* if $\pi^d(\widetilde{M}(n_1, n_2, \dots, n_m), x)$ is trivial. As a consequence, we get the following result by Theorem 4.3.4.

Corollary 4.3.5 *A d -connected finitely combinatorial manifold $\widetilde{M}(n_1, n_2, \dots, n_m)$ is simply d -connected if and only if*

- (1) *for $\forall M \in V(G^d[\widetilde{M}(n_1, n_2, \dots, n_m)])$, M is simply d -connected and*
- (2) *$G^d[\widetilde{M}(n_1, n_2, \dots, n_m)]$ is a tree.*

Proof According to the decomposition for $\pi^d(\widetilde{M}(n_1, n_2, \dots, n_m), x)$ in Theorem 4.3.4, it is trivial if and only if $\pi(M)$ and $\pi(G^d)$ both are trivial for $\forall M \in V(G^d[\widetilde{M}(n_1, n_2, \dots, n_m)])$, i.e M is simply d -connected and G^d is a tree. □

Corollary 4.3.6 *Let $\widetilde{M}(n_1, n_2, \dots, n_m)$ be a d -connected finitely combinatorial manifold for an integer $d, 1 \leq d \leq n_1$. For $\forall M \in V(G^L[\widetilde{M}(n_1, n_2, \dots, n_m)])$, $(M_1, M_2) \in E(G^L[\widetilde{M}(n_1, n_2, \dots, n_m)])$, if M and $M_1 \cap M_2$ are simply connected, then for $x_0 \in G^d$,*

$$\pi^d(\widetilde{M}(n_1, n_2, \dots, n_m), x_0) \cong \pi(G^d, x_0).$$

4.3.3 Homotopy Equivalence. For equivalent homotopically combinatorial manifolds, we can also find criterions following.

Theorem 4.3.5 *If $f : \widetilde{M}(n_1, n_2, \dots, n_m) \rightarrow \widetilde{M}(k_1, k_2, \dots, k_l)$ is a homotopic equivalence, then for any integer $d, 1 \leq d \leq n_1$ and $x \in \widetilde{M}(n_1, n_2, \dots, n_m)$,*

$$\pi^d(\widetilde{M}(n_1, n_2, \dots, n_m), x) \cong \pi^d(\widetilde{M}(k_1, k_2, \dots, k_l), f(x)).$$

Proof Notice that f can natural induce a homomorphism

$$f_\pi : \pi^d(\widetilde{M}(n_1, n_2, \dots, n_m), x) \rightarrow \pi^d(\widetilde{M}(k_1, k_2, \dots, k_l), f(x))$$

defined by $f_\pi \langle g \rangle = \langle f(g) \rangle$ for $\forall g \in \pi^d(\widetilde{M}(n_1, n_2, \dots, n_m), x)$ since it can be easily checked that $f_\pi(gh) = f_\pi(g)f_\pi(h)$ for $\forall g, h \in \pi^d(\widetilde{M}(n_1, n_2, \dots, n_m), x)$. We only

need to prove that f_π is an isomorphism.

By definition, there is also a homotopic equivalence $g : \widetilde{M}(k_1, k_2, \dots, k_l) \rightarrow \widetilde{M}(n_1, n_2, \dots, n_m)$ such that $gf \simeq \text{identity} : \widetilde{M}(n_1, n_2, \dots, n_m) \rightarrow \widetilde{M}(n_1, n_2, \dots, n_m)$. Thereby, $g_\pi f_\pi = (gf)_\pi = \mu(\text{identity})_\pi :$

$$\pi^d(\widetilde{M}(n_1, n_2, \dots, n_m), x) \rightarrow \pi^s(\widetilde{M}(n_1, n_2, \dots, n_m), x),$$

where μ is an isomorphism induced by a certain d -path from x to $gf(x)$ in $\widetilde{M}(n_1, n_2, \dots, n_m)$. Therefore, $g_\pi f_\pi$ is an isomorphism. Whence, f_π is a monomorphism and g_π is an epimorphism.

Similarly, apply the same argument to the homotopy

$$fg \simeq \text{identity} : \widetilde{M}(k_1, k_2, \dots, k_l) \rightarrow \widetilde{M}(k_1, k_2, \dots, k_l),$$

we get that $f_\pi g_\pi = (fg)_\pi = \nu(\text{identity})_{pi} :$

$$\pi^d(\widetilde{M}(k_1, k_2, \dots, k_l), x) \rightarrow \pi^s(\widetilde{M}(k_1, k_2, \dots, k_l), x),$$

where ν is an isomorphism induced by a d -path from $fg(x)$ to x in $\widetilde{M}(k_1, k_2, \dots, k_l)$. So g_π is a monomorphism and f_π is an epimorphism. Combining these facts enables us to conclude that $f_\pi : \pi^d(\widetilde{M}(n_1, n_2, \dots, n_m), x) \rightarrow \pi^d(\widetilde{M}(k_1, k_2, \dots, k_l), f(x))$ is an isomorphism. \square

Corollary 4.3.7 If $f : \widetilde{M}(n_1, n_2, \dots, n_m) \rightarrow \widetilde{M}(k_1, k_2, \dots, k_l)$ is a homeomorphism, then for any integer $d, 1 \leq d \leq n_1$ and $x \in \widetilde{M}(n_1, n_2, \dots, n_m)$,

$$\pi^d(\widetilde{M}(n_1, n_2, \dots, n_m), x) \cong \pi^d(\widetilde{M}(k_1, k_2, \dots, k_l), f(x)).$$

§4.4 HOMOLOGY GROUPS OF

COMBINATORIAL MANIFOLDS

4.4.1 Singular Homology Group. Let Δ_p be a standard p -simplex $[\mathbf{e}_0, \mathbf{e}_1, \dots, \mathbf{e}_p]$, where $\mathbf{e}_0 = \bar{0}$, \mathbf{e}_i is the vector with a 1 in the i th place and 0 elsewhere, and S a topological space. A *singular p -simplex* in S is a continuous mapping $\sigma : \Delta_p \rightarrow S$. For example, a singular 0-simplex is just a mapping from the one-point space Δ_0 into S and a singular 1-simplex is a mapping from $\Delta_1 = [0, 1]$ into S , i.e., an arc in

S .

Similar to the case of simplicial complexes, we consider Abelian groups generated by these singular simplices. Denote by $C_p(S)$ the free Abelian group generated by the set of all singular p -simplices in S , in which each element can be written as a formal of linear combination of singular simplices with integer coefficients, called a *singular p -chain* in S .

For a p -simplex $\underline{s} = [a_0, a_1, \dots, a_p]$ in \mathbf{R}^n , let $\alpha(a_0, a_1, \dots, a_p) : \Delta_p \rightarrow \underline{s}$ be a continuous mapping defined by $\alpha(a_0, a_1, \dots, a_p)(\mathbf{e}_i) = a_i$ for $i = 0, 1, \dots, p$, called an *affine singular simplex*. For $i = 0, 1, \dots, p$, define the *i th face mapping* $F_{i,p} : \Delta_{p-1} \rightarrow \Delta_p$ to be an affine singular simplex by

$$F_{i,p} = \alpha(\mathbf{e}_0, \dots, \widehat{\mathbf{e}}_i, \dots, \mathbf{e}_p),$$

where $\widehat{\mathbf{e}}_i$ means that \mathbf{e}_i is to be omitted. The *boundary* $\partial\sigma$ of a singular simplex $\sigma : \Delta_p \rightarrow S$ is a $(p - 1)$ -chain determined by

$$\partial\sigma = \sum_{i=0}^p (-1)^i \sigma \circ F_{i,p}$$

and extended linearly to a *boundary operator* $\partial_P : C_p(S) \rightarrow C_{p-1}(S)$.

A singular p -chain c is called a *cycle* if $\partial c = 0$ and is called a *boundary* if there exists a $(p + 1)$ -chain b such that $c = \partial b$. Similar to Theorem 3.1.14, we also know the following result for the boundary operator on singular chains.

Theorem 4.4.1 *Let c be a singular chain. Then $\partial(\partial c) = 0$.*

Proof By definition, calculation shows that

$$F_{i,p} \circ F_{j,p-1} = F_{j,p} \circ F_{i-1,p-1}$$

if $i > j$. In fact, both sides are equal to the affine simplex $\alpha(\mathbf{e}_0, \dots, \widehat{\mathbf{e}}_j, \dots, \widehat{\mathbf{e}}_i, \dots, \mathbf{e}_p)$. Whence, we know that

$$\begin{aligned} \partial(\partial c) &= \sum_{j=0}^{p-1} \sum_{i=0}^p (-1)^{i+j} \sigma \circ F_{i,p} \circ F_{j,p-1} \\ &= \sum_{0 \leq j < i \leq p} (-1)^{i+j} \sigma \circ F_{i,p} \circ F_{j,p-1} + \sum_{0 \leq i \leq j \leq p-1} (-1)^{i+j} \sigma \circ F_{i,p} \circ F_{j,p-1} \end{aligned}$$

$$\begin{aligned}
&= \sum_{0 \leq j < i \leq p} (-1)^{i+j} \sigma \circ F_{i,p} \circ F_{j,p-1} + \sum_{0 \leq j < i \leq p} (-1)^{i+j-1} \sigma \circ F_{j,p} \circ F_{i-1,p-1} \\
&= 0.
\end{aligned}$$

□

Denote by $Z_p(S)$ all p -cycles and $B_p(S)$ all boundaries in $C_p(S)$. Each of them is a subgroup of $C_p(S)$ by definition. According to Theorem 4.4.1, we find that $\text{Im} \partial_{p+1} \leq \text{Ker} \partial_p$. This enables us to get a chain complex $(\mathcal{C}; \partial)$

$$0 \rightarrow \cdots \rightarrow C_{p+1}(S) \xrightarrow{\partial_{p+1}} C_p(S) \xrightarrow{\partial_p} C_{p-1}(S) \rightarrow \cdots \rightarrow 0.$$

Similarly, the p th singular homology group of S is defined to be a quotient group

$$H_p(S) = Z_p(S) / B_p(S) = \text{Ker} \partial_p / \text{Im} \partial_{p+1}.$$

These singular homology groups of S are topological invariants shown in the next.

Theorem 4.4.2 *If S is homomorphic to T , then $H_p(S)$ is isomorphic to $H_p(T)$ for any integer $p \geq 0$.*

Proof Let $f : S \rightarrow T$ be a continuous mapping. It induces a homomorphism $f_{\#} : C_p(S) \rightarrow C_p(T)$ by setting $f_{\#} \sigma = f \circ \sigma$ for each singular p -simplex and then extend it linearly on $C_p(S)$.

Notice that

$$f_{\#}(\partial \sigma) = \sum_{i=0}^p (-1)^i f \circ \sigma \circ F_{i,p}.$$

We know that $f_{\#} : Z_p(S) \rightarrow Z_p(T)$ and $f_{\#} : B_p(S) \rightarrow B_p(T)$. Thereafter, f also induces a homomorphism $f_* : H_p(S) \rightarrow H_p(T)$ with properties following, each of them can be checked easily even for $f_{\#}$.

(i) The identity homomorphism $\text{identity}_S : S \rightarrow S$ induces the identity of $H_p(S)$;

(ii) If $f : S \rightarrow T$ and $g : T \rightarrow U$ are continuous mapping, then $(g \circ f)_* = g_* \circ f_* : H_p(S) \rightarrow H_p(U)$.

Applying these properties, we get the conclusion. □

Furthermore, singular homology groups are homotopy invariance shown in the following result. For its proof, the reader is referred to [Mas2].

Theorem 4.4.3 *If $f : S \rightarrow T$ is a homotopy equivalence, then $f_* : H_p(S) \rightarrow H_p(T)$ is an isomorphism for each integer $p \geq 0$. \square*

Now we calculate homology groups for some simple spaces.

Theorem 4.4.4 *Let S be a disjoint union of arcwise connected spaces S_λ , $\lambda \in \Lambda$ and $\iota_p : S_\lambda \hookrightarrow S$ an inclusion. Then for each $p \geq 0$, the induced mappings $(\iota_\lambda)_* : H_p(S_\lambda) \rightarrow H_p(S)$ induce an isomorphism*

$$\bigoplus_{\lambda \in \Lambda} H_p(S_\lambda) \stackrel{(\iota_\lambda)_*}{\cong} H_p(S).$$

Proof Notice that the image of a singular simplex must entirely lie in an arcwise connected component of S . It is easily known that each $(\iota_\lambda)_\# : C_p(S_\lambda) \rightarrow C_p(S)$ introduced in the proof of Theorem 4.4.2 induces isomorphisms

$$\bigoplus_{\lambda \in \Lambda} C_p(S_\lambda) \stackrel{(\iota_\lambda)_\#}{\cong} C_p(S),$$

$$\bigoplus_{\lambda \in \Lambda} Z_p(S_\lambda) \stackrel{(\iota_\lambda)_\#}{\cong} Z_p(S),$$

$$\bigoplus_{\lambda \in \Lambda} B_p(S_\lambda) \stackrel{(\iota_\lambda)_\#}{\cong} B_p(S).$$

Therefore, we know that

$$\bigoplus_{\lambda \in \Lambda} H_p(S_\lambda) \stackrel{(\iota_\lambda)_*}{\cong} H_p(S).$$

\square

For $p = 0$ or 1 , we have known the singular homology groups $H_p(S)$ in the following.

Theorem 4.4.5 *Let S be a topological space. Then*

(i) $H_0(S)$ is free Abelian group with basis consisting of an arbitrary point in each arcwise component.

(ii) $H_1(S) \cong \pi_1(S, x_0) / [\pi_1(S, x_0), \pi_1(S, x_0)]$, where $[\pi_1(S, x_0), \pi_1(S, x_0)]$ denotes the commutator subgroup of $\pi_1(S, x_0)$, i.e.,

$$[\pi_1(S, x_0), \pi_1(S, x_0)] = \langle a^{-1}b^{-1}ab \mid a, b \in \pi_1(S, x_0) \rangle.$$

Proof The (i) is an immediately consequence of Theorem 4.4.4. For (ii), its proof can be found in references, for examples, [Mas2], [You1], etc.. \square

Theorem 4.4.6 *Let O be a one point space. Then singular homology groups of O are*

$$H_p(O) = \begin{cases} \mathbf{Z}, & \text{if } p = 0, \\ 0, & \text{if } p > 0. \end{cases}$$

Proof The case of $p = 0$ is a consequence of Theorem 4.4.4. For each $p > 0$, there is exactly one singular simplex $\sigma_p : \Delta_p \rightarrow O$. Whence, each chain group $C_p(O)$ is an infinite cyclic group generated by σ_p . By definition,

$$\partial\sigma_p = \sum_{i=0}^p (-1)^i \sigma_p \circ F_{i,p} = \sum_{i=0}^p (-1)^i \sigma_{p-1} = \begin{cases} 0, & \text{if } p \text{ is odd,} \\ \sigma_{p-1}, & \text{if } p \text{ is even.} \end{cases}$$

Therefore, $\partial : C_p(O) \rightarrow C_{p-1}(O)$ is an isomorphism if p is even and zero mapping if p is odd. We get that

$$\dots \xrightarrow{\cong} C_3(O) \xrightarrow{0} C_2(O) \xrightarrow{\cong} C_1(O) \xrightarrow{0} C_0(O) \rightarrow 0.$$

By this chain complex, it follows that for each $p > 0$,

$$Z_p(O) = \begin{cases} C_p(O), & \text{if } p \text{ is odd,} \\ 0, & \text{if } p \text{ is even;} \end{cases}$$

$$B_p(O) = \begin{cases} C_p(O), & \text{if } p \text{ is odd,} \\ 0, & \text{if } p \text{ is even.} \end{cases}$$

Whence, we find that $H_p(O) = Z_p(O)/B_p(O) = 0$. \square

4.4.2 Relative Homology Group. For a subspace A of a topological space S and an inclusion mapping $i : A \hookrightarrow S$, it is readily verified that the induced homomorphism $i_{\#} : C_p(A) \rightarrow C_p(S)$ is a monomorphism. Whence, we can consider that $C_p(A)$ is a subgroup of $C_p(S)$. Let $C_p(S, A)$ denote the quotient group $C_p(S)/C_p(A)$, called the p -chain group of the pair (S, A) .

It is easily to know also that the boundary operator $\partial : C_p(S) \rightarrow C_{p-1}(S)$ posses the property that $\partial_p(C_p(A)) \subset C_p(A)$. Whence, it induces a homomorphism ∂_p on quotient groups

$$\partial_p : C_p(S, A) \rightarrow C_{p-1}(X, A).$$

Similarly, we define the p -cycle group and p -boundary group of (S, A) by

$$Z_p(S, A) = \text{Ker}\partial_p = \{ u \in C_p(S, A) \mid \partial_p(u) = 0 \},$$

$$B_p(S, A) = \text{Im}\partial_{p+1} = \partial_{p+1}(C_{p+1}(S, A)),$$

for any integer $p \geq 0$. Notice that $\partial_p\partial_{p+1} = 0$. It follows that $B_p(S, A) \subset Z_p(S, A)$ and the p th relative homology group $H_p(S, A)$ is defined to be

$$H_p(S, A) = Z_p(S, A)/B_p(S, A).$$

Let (S, A) and (T, B) be pairs consisting of a topological space with a subspace. A continuous mapping $f : S \rightarrow T$ is called a *mapping (S, A) into (T, B)* if $f(A) \subset B$, denoted by $f : (S, A) \rightarrow (T, B)$ such a mapping.

The main property of relative homology groups is the *excision property* shown in the following result. Its proof is refereed to the reference [Mas2].

Theorem 4.4.7 *Let (S, A) be a pair and B a subset of A such that B is contained in the interior of A . Then the inclusion mapping $i : (S - B, A - B) \hookrightarrow (S, A)$ induces an isomorphism of relative homology groups*

$$H_p(S - B, A - B) \xrightarrow{i_*} H_p(S, A)$$

for any integer $p \geq 0$. □

4.4.3 Exact Chain. A chain complex

$$0 \rightarrow \dots \rightarrow C_{p+1} \xrightarrow{\partial_{p+1}} C_p \xrightarrow{\partial_p} C_{p-1} \rightarrow \dots \rightarrow 0$$

is said to be *exact* if $\text{Im}\partial_{p+1} = \text{Ker}\partial_p$ for all $p \geq 0$, particularly, a 5-term exact chain

$$0 \rightarrow C_4 \xrightarrow{\partial_4} C_3 \xrightarrow{\partial_3} C_2 \rightarrow 0$$

is called a *short exact chain*. Notice that the exactness of a short exact chain means that ∂_3 is surjective, $\text{Ker}\partial_3 = \text{Im}\partial_4$ and

$$C_2 \cong C_3/\text{Ker}\partial_3 = C_3/\text{Im}\partial_4$$

by Theorem 2.2.5.

Now let $i : A \hookrightarrow S$ be an inclusion mapping for a pair (S, A) and $j_{\sharp} : C_p(S) \rightarrow C_p(S, A)$ the natural epimorphism of $C_p(S)$ onto its quotient group $C_p(S, A)$ for an integer $p \geq 0$. Then as shown in the proof of Theorem 4.4.2, i and j_{\sharp} induce homomorphisms $i_* : H_p(A) \rightarrow H_p(S)$, $j_* : H_p(S) \rightarrow H_p(S, A)$ for $p \geq 0$.

We define a boundary operator $\partial_* : H_p(S, A) \rightarrow H_{p-1}(A)$ as follows. For $\forall u \in H_p(S, A)$, choose a representative p -cycle $u' \in C_p(S, A)$ for u . Notice that j_{\sharp} is an epimorphism, there is a chain $u'' \in C_p(S)$ such that $j_{\sharp}(u'') = u'$. Consider the chain $\partial(u'')$. We find that $j_{\sharp}\partial(u'') = \partial j_{\sharp}(u'') = \partial u' = 0$. Whence, $\partial(u'')$ belong to the subgroup $C_{p-1}(A)$ of $C_{p-1}(S)$. It is a cycle of $C_p(S, A)$. We define ∂_* to be the homology class of the cycle $\partial(u'')$. It can be easily verified that ∂_* does not depend on the choice of u' , u'' and it is a homomorphism, i.e., $\partial_*(u + v) = \partial_*(u) + \partial_*(v)$ for $\forall u, v \in H_p(S, A)$.

Therefore, we get a chain complex, called the *homology sequence of (S, A)* following.

$$\dots \xrightarrow{j_*} H_{p+1}(S, A) \xrightarrow{\partial_*} H_p(A) \xrightarrow{i_*} H_p(S) \xrightarrow{j_*} H_p(S, A) \xrightarrow{\partial_*} \dots$$

Theorem 4.4.8 *The homology sequence of any pair (S, A) is exact.*

Proof It is easily to verify the following six inclusions:

$$\text{Im}i_* \subseteq \text{Ker}j_*, \quad \text{Ker}j_* \subseteq \text{Im}i_*,$$

$$\text{Im}j_* \subseteq \text{Ker}\partial_*, \quad \text{Ker}\partial_* \subseteq \text{Im}i_*,$$

$$\text{Im}\partial_* \subseteq \text{Ker}i_*, \quad \text{Ker}i_* \subseteq \text{Im}\partial_*.$$

Whence, the homology sequence of (S, A) is exact by definition. \square

Similar to the consideration in Seifer-Van Kampen theorem on fundamental groups, let $S_1, S_2 \subset S$ with $S = S_1 \cup S_2$ and four inclusion mappings $i : S_1 \cap S_2 \hookrightarrow S_1$, $j : S_1 \cap S_2 \hookrightarrow S_2$, $k : S_1 \hookrightarrow S$ and $l : S_2 \hookrightarrow S$, which induce four homology homomorphisms. Then we know the next result.

Theorem 4.4.9(Mayer-Vietoris) *Let S be a topological space, $S_1, S_2 \subset S$ with $S_1 \cup S_2 = S$. Then for each integer $p \geq 0$, there is a homomorphism $\partial_* : H_p(S) \rightarrow H_{p-1}(S_1 \cap S_2)$ such that the following chain*

$$\cdots \xrightarrow{\partial_*} H_p(S_1 \cap S_2) \xrightarrow{i_* \oplus j_*} H_p(S_1) \oplus H_p(S_2) \xrightarrow{k_* - l_*} H_p(S) \xrightarrow{\partial_*} H_{p-1}(S_1 \cap S_2) \xrightarrow{i_* \oplus j_*} \cdots,$$

is exact, where $i_* \oplus j_*(u) = (i_*(u), j_*(u)), \forall u \in H_p(S_1 \cap S_2)$ and $(k_* - l_*)(u, v) = k_*(u) - l_*(v)$ for $\forall u \in H_p(S_1), v \in H_p(S_2)$. □

This theorem and the exact chain in it are usually called the *Mayer-Vietoris theorem* and *Mayer-Vietoris chain*, respectively. For its proof, the reader is referred to [Mas2] or [Lee1].

4.4.4 Homology Group of d-Dimensional Graph. We have determined the fundamental group of d -dimensional graphs in Section 4.3. The application of results in previous subsections also enables us to find its singular homology groups.

Theorem 4.4.10 *For an integer $n \geq 1$, the singular homology groups $H_p(S^n)$ of S^n are*

$$H_p(S^n) \cong \begin{cases} \mathbf{Z}, & \text{if } p = 0 \text{ or } n, \\ 0, & \text{otherwise.} \end{cases}$$

Proof Let N and S denote the north and south poles of S^n and $U = S^n \setminus \{N\}, V = S^n \setminus \{S\}$. By the Mayer-Vietoris theorem, we know the following portion of the Mayer-Vietoris chain

$$\cdots H_p(U) \oplus H_p(V) \rightarrow H_p(S^n) \xrightarrow{\partial_*} H_{p-1}(U \cap V) \rightarrow H_{p-1}(U) \oplus H_{p-1}(V) \cdots$$

Notice that U and V are contractible. If $p > 1$, this chain reduces to

$$0 \rightarrow H_p(S^n) \xrightarrow{\partial_*} H_{p-1}(U \cap V) \rightarrow 0,$$

which means that ∂_* is an isomorphism. Now since $U \cap V$ is homotopy equivalent to S^{n-1} , we get the following recurrence relation on $H_p(S^n)$ with $H_{p-1}(S^{n-1})$,

$$H_p(S^n) \cong H_{p-1}(U \cap V) \cong H_{p-1}(S^{n-1})$$

for $p > 1$ and $n \geq 1$.

Now if $n = 1$, $H_0(S^1) \cong H_1(S^1) \cong \mathbf{Z}$ by Theorem 4.4.5. For $p > 1$, the previous relation shows that $H_p(S^1) \cong H_{p-1}(S^0)$. Notice that S^0 is consisted of 2 isolated points. Applying Theorems 4.4.5 and 4.4.6, we know that $H_{p-1}(S^0)$, and consequently, $H_p(S^1)$ is a trivial group.

Suppose the result is true for S^{n-1} for $n > 1$. The cases of $p = 0$ or 1 are obtained by Theorem 4.4.5. For cases of $p > 1$, applying the recurrence relation again, we find that

$$H_p(S^n) \cong H_{p-1}(S^{n-1}) \cong \begin{cases} 0, & \text{if } p < n, \\ \mathbf{Z}, & \text{if } p = n, \\ 0, & \text{if } p > n. \end{cases}$$

This completes the proof. \square

Corollary 4.4.1 *A sphere S^n is not contractible to a point.*

Corollary 4.4.2 *The relative homology groups of the pair $(\overline{B}^n, S^{n-1})$ are as follows*

$$H_p(\overline{B}^n, S^{n-1}) \cong \begin{cases} 0, & p \neq n, \\ \mathbf{Z}, & p = n \end{cases}$$

for $p, n \geq 1$.

Proof Applying Theorem 4.4.8, we know an exact chain following

$$\cdots \rightarrow H_p(\overline{B}^n) \xrightarrow{j_*} H_p(\overline{B}^n, S^{n-1}) \xrightarrow{\partial_*} H_{p-1}(S^{n-1}) \xrightarrow{i_*} H_{p-1}(\overline{B}^n) \rightarrow \cdots$$

Notice that $H_p(\overline{B}^n) = 0$ for any integer $p \geq 1$. We get that

$$H_p(\overline{B}^n, S^{n-1}) \cong H_{p-1}(S^{n-1}) \cong \begin{cases} 0, & p \neq n, \\ \mathbf{Z}, & p = n. \end{cases}$$

\square

The case discussed in Theorem 4.4.10 is correspondent to a n -dimensional graph of order 1. Generally, we know the following result for relative homology groups of d -dimensional graphs. Combining Corollary 4.4.2 with the definition of d -dimensional graphs, we know that

$$H_p(\bar{e}_i, \dot{e}_i) \cong \begin{cases} 0, & p \neq n, \\ \mathbf{Z}, & p = n, \end{cases}$$

where $e_i \cong B^n$ and $\dot{e}_i = \bar{e}_i - e_i \cong S^{n-1}$ for integers $1 \leq i \leq m$.

Theorem 4.4.11 *Let $\widetilde{M}^d(G)$ be a d -dimensional graph with $E(\widetilde{M}^d(G)) = \{e_1, e_2, \dots, e_m\}$. Then the inclusion $(e_l, \dot{e}_l) \hookrightarrow (\widetilde{M}^d(G), V(\widetilde{M}^d(G)))$ induces a monomorphism $H_p(e_l, \dot{e}_l) \rightarrow H_p(\widetilde{M}^d(G), V(\widetilde{M}^d(G)))$ for $l = 1, 2, \dots, m$ and $H_p(\widetilde{M}^d(G), V(\widetilde{M}^d(G)))$ is a direct sum of the image subgroups, which follows that*

$$H_p(\widetilde{M}^d(G), V(\widetilde{M}^d(G))) \cong \begin{cases} \underbrace{\mathbf{Z} \oplus \dots \oplus \mathbf{Z}}_m, & \text{if } p = d, \\ 0, & \text{if } p \neq d. \end{cases}$$

Proof For a ball B^d and the sphere S^{d-1} with center at the origin O , define $D_{\frac{1}{2}}^d = \{\bar{x} \in \mathbf{R}^d \mid \|\bar{x}\| \leq \frac{1}{2}\}$. Let $f_l : B^d \rightarrow \bar{e}_l$ be a continuous mapping for integers $1 \leq l \leq m$ in the space of $\widetilde{M}^d(G)$ and

$$D_l = f_l(D_{\frac{1}{2}}^d), \quad a_l = f_l(\bar{0}), \quad A = \{a_l \mid 1 \leq l \leq m\},$$

$$X' = \widetilde{M}^d(G) \setminus A, \quad \mathcal{D} = \bigcup_{l=1}^m D_l.$$

Notice that f_l maps a pair $(D^d, D^d - \{\bar{0}\})$ homeomorphically onto $(D_l, D_l - \{a_l\})$ and those subsets $D_l, 1 \leq l \leq m$ are pairwise disjoint. We consider the following diagram

$$H_p(\mathcal{D}, \mathcal{D} - A) \xrightarrow{1} H_p(\widetilde{M}^d(G), X') \xleftarrow{2} H_p(\widetilde{M}^d(G), \widetilde{M}^d(G) - V(\widetilde{M}^d(G))),$$

where each arrow denotes a homomorphism induced by the inclusion mapping. In fact, these homomorphisms represented by arrows 1 and 2 are isomorphisms for integers $p \geq 1$. This follows from the fact that $\widetilde{M}^d(G) - V(\widetilde{M}^d(G))$ is a deformation retract of X' and the excision property.

Notice that the arcwise connected components in \mathcal{D} are just these sets $D_l, 1 \leq l \leq m$. Whence, $H_p(\mathcal{D}, \mathcal{D} - A)$ is the direct sum of the groups $H_p(D_l, D_l - \{a_l\})$ by Theorem 4.4.4. Applying Corollary 4.4.2, we know that

$$H_p(D_l, D_l - \{a_l\}) \cong \begin{cases} 0, & p \neq d, \\ \mathbf{Z}, & p = d. \end{cases}$$

Consequently, $H_p(\widetilde{M}^d(G), V(\widetilde{M}^d(G))) = 0$ if $p \neq d$ and $H_d(\widetilde{M}^d(G), V(\widetilde{M}^d(G)))$ is a free Abelian group with basis in 1-1 correspondent with the set $\widetilde{M}^d(G) - V(\widetilde{M}^d(G))$. Consider the following diagram:

$$\begin{array}{ccccc}
 H_p(\mathcal{D}, \mathcal{D} - A) & \xrightarrow{1} & H_p(\widetilde{M}^d(G), X') & \xleftarrow{2} & H_p(\widetilde{M}^d(G), V(\widetilde{M}^d(G))) \\
 \uparrow f'_{l*} & & \uparrow f''_{l*} & & \uparrow f_{l*} \\
 H_p(D^d, D^d - \{\bar{0}\}) & \xrightarrow{3} & H_p(\overline{B}^d, \overline{B}^d - \{\bar{0}\}) & \xleftarrow{4} & H_p(\overline{B}^d, S^{d-1})
 \end{array}$$

The vertical arrows denote homomorphisms induced by f_l . By definition, f_l maps $(D^d, D^d - \{\bar{0}\})$ homeomorphically onto $(D_l, D_l - \{a_l\})$. It follows that f'_{l*} maps $H_p(D^d, D^d - \{\bar{0}\})$ isomorphically onto the direct summand $H_p(D_l, D_l - \{a_l\})$ of $H_p(\mathcal{D}, \mathcal{D} - A)$. We have proved that arrows 1 and 2 are isomorphisms. Similarly, by the same method we can also know that arrows 3 and 4 are isomorphisms. Combining all these facts suffices to know that $f_{l*} : H_p(\overline{B}^d, S^{d-1}) \rightarrow H_p(\widetilde{M}^d(G), V(\widetilde{M}^d(G)))$ is a monomorphism. This completes the proof. \square

Particularly, if $d = 1$, i.e., $\widetilde{M}^d(G)$ is a graph G embedded in a topological space, we know its homology groups in the following.

Corollary 4.4.3 *Let G be a graph embedded in a topological space S . Then*

$$H_p(G, V(G)) \cong \begin{cases} \underbrace{\mathbf{Z} \oplus \cdots \oplus \mathbf{Z}}_{\varepsilon(G)}, & \text{if } p = 1, \\ 0, & \text{if } p \neq 1. \end{cases}$$

Corollary 4.4.4 *Let $X = \widetilde{M}^d(G), X_v = V(\widetilde{M}^d(G))$. Then the homomorphism $i_* : H_p(X_v) \rightarrow H_p(X)$ is an isomorphism except possibly for $p = d$ and $p = d - 1$, and the only non-trivial part of homology sequence of the pair (X, X_v) is*

$$0 \rightarrow H_p(X_v) \xrightarrow{i_*} H_p(X) \rightarrow H_p(X, X_v) \rightarrow H_{p-1}(X_v) \xrightarrow{i_*} H_{p-1}(X) \rightarrow 0,$$

particularly, if $d = 1$, i.e., $\widetilde{M}^d(G)$ is just a graph embedded in a space, then

$$0 \rightarrow H_1(G) \xrightarrow{i_*} H_1(G, V(G)) \xrightarrow{\partial_*} H_0(V(G)) \xrightarrow{i_*} H_0(G) \rightarrow 0.$$

4.4.5 Homology Group of Combinatorial Manifold. A easily case for determining homology groups of combinatorial manifolds is the adjunctions of s -balls to a d -dimensional graph, i.e., there exists a d -dimensional graph $\widetilde{M}^d[G] \prec \widetilde{M}(n_1, n_2, \dots, n_m)$ such that

$$\widetilde{M}(n_1, n_2, \dots, n_m) \setminus \widetilde{M}^d[G] = \bigcup_{i=2}^k \bigcup_{j=1}^{l_i} B_{i_j},$$

where B_{i_j} is the i -ball B^i for integers $1 \leq i \leq k, 1 \leq j \leq l_i$. We know the following result for homology groups of combinatorial manifolds.

Theorem 4.4.12 *Let \widetilde{M} be a combinatorial manifold, $\widetilde{M}^d(G) \prec \widetilde{M}$ a d -dimensional graph with $E(\widetilde{M}^d(G)) = \{e_1, e_2, \dots, e_m\}$ such that*

$$\widetilde{M} \setminus \widetilde{M}^d[G] = \bigcup_{i=2}^k \bigcup_{j=1}^{l_i} B_{i_j}.$$

Then the inclusion $(e_l, \dot{e}_l) \hookrightarrow (\widetilde{M}, \widetilde{M}^d(G))$ induces a monomorphism $H_p(e_l, \dot{e}_l) \rightarrow H_p(\widetilde{M}, \widetilde{M}^d(G))$ for $l = 1, 2, \dots, m$ and

$$H_p(\widetilde{M}, \widetilde{M}^d(G)) \cong \begin{cases} \underbrace{\mathbf{Z} \oplus \dots \oplus \mathbf{Z}}_m, & \text{if } p = d, \\ 0, & \text{if } p \neq d. \end{cases}$$

Proof Similar to the proof of Theorem 4.4.11, we can get this conclusion. \square

Corollary 4.4.5 *Let \widetilde{M} be a combinatorial manifold, $\widetilde{M}^d(G) \prec \widetilde{M}$ a d -dimensional graph with $E(\widetilde{M}^d(G)) = \{e_1, e_2, \dots, e_m\}$ such that*

$$\widetilde{M} \setminus \widetilde{M}^d[G] = \bigcup_{i=2}^k \bigcup_{j=1}^{l_i} B_{i_j}.$$

Then the homomorphism $i_ : H_p(\widetilde{M}^d(G)) \rightarrow H_p(\widetilde{M})$ is an isomorphism except possibly for $p = d$ and $p = d - 1$, and the only non-trivial part of homology sequence of the pair $(\widetilde{M}, \widetilde{M}^d(G))$ is*

$$0 \rightarrow H_p(\widetilde{M}^d(G)) \xrightarrow{i_*} H_p(\widetilde{M}) \rightarrow H_p(\widetilde{M}, \widetilde{M}^d(G)) \rightarrow H_{p-1}(\widetilde{M}^d(G)) \xrightarrow{i_*} H_{p-1}(\widetilde{M}) \rightarrow 0.$$

Notice that any manifold M in a combinatorial manifold \widetilde{M} , it consists of a pair (\widetilde{M}, M) . We know the following result.

Theorem 4.4.13 For any manifold in a combinatorial manifold \widetilde{M} , the following chain

$$\dots \xrightarrow{j_*} H_{p+1}(\widetilde{M}, M) \xrightarrow{\partial_*} H_p(M) \xrightarrow{i_*} H_p(\widetilde{M}) \xrightarrow{j_*} H_p(\widetilde{M}, M) \xrightarrow{\partial_*} \dots$$

is exact.

Proof It is an immediately conclusion of Theorem 4.4.8. □

For a finitely combinatorial manifold, if each manifold in this combinatorial manifold is compact, we call it a *compactly combinatorial manifold*. We also know homology groups of compactly combinatorial manifolds following.

Theorem 4.4.14 A compact combinatorial manifold \widetilde{M} is finitely generated.

Proof It is easily to know that the homology groups $H_p(\widetilde{M})$ of a finitely combinatorial manifold \widetilde{M} can be generated by $\langle [u] \in H_p(M) \mid M \in V(G^L[\widetilde{M}]) \rangle$. Applying a famous result, i.e., *any compact manifold is finitely generated* (see [Mas2] for details), we know that \widetilde{M} is also finitely generated. □

§4.5 REGULAR COVERING OF

COMBINATORIAL MANIFOLDS BY VOLTAGE ASSIGNMENT

4.5.1 Action of Fundamental Group on Covering Space. Let $p: \widetilde{S} \rightarrow S$ be a covering mapping of topological spaces. For $\forall x_0 \in S$, the set $p^{-1}(x_0)$ is called the *fibre* over the vertex x_0 , denoted by fib_{x_0} . Notice that we have introduced a 1 – 1 mapping $\Phi: p^{-1}(x_1) \rightarrow p^{-1}(x_2)$ in the proof of Theorem 3.1.12, which is defined by $\Phi(y_1) = y_2$ for $y_1 \in p^{-1}(x_1)$ with y_2 the terminal point of a lifting arc f^l of an arc f from x_1 to x_2 in S . This enables us to introduce the action of fundamental group on fibres fib_{x_0} for $x_0 \in S$ following.

Definition 4.5.1 Let $p: \widetilde{S} \rightarrow S$ be a covering projection of S . Define the left action of $\pi_1(S)$ on fibres $p^{-1}(x)$ by

$$L(\tilde{x}) = \tilde{x} \cdot L = \tilde{y},$$

for $\tilde{x} \in p^{-1}(x)$, where $L: p(\tilde{x}) \rightarrow p(\tilde{y})$ and \tilde{y} is the terminal point of the unique

lifted arc L^l over L starting at x .

Notice that $L : \text{fib}_x \rightarrow \text{fib}_y$ is a bijection by the proof of Theorem 3.1.12. For $\forall C \in \pi_1(\widetilde{M})$, let $L_* = L^{-1}CL$. Then

$$(L, L_*) : (\text{fib}_x, \pi_1(\widetilde{S}, p(x))) \rightarrow (\text{fib}_x, \pi_1(\widetilde{S}, p(y)))$$

is an isomorphism of actions.

4.5.2 Regular Covering of Labeled Graph. Generalizing voltage assignments on graphs in topological graph theory ([GrT1]) to vertex-edge labeled graphs enables us to find a combinatorial technique for getting regular covers of a combinatorial manifold \widetilde{M} , which is the essence in the construction of principal fiber bundles of combinatorial manifolds in follow-up chapters.

Let G^L be a connected vertex-edge labeled graph with $\theta_L : V(G) \cup E(G) \rightarrow L$ of a label set and Γ a finite group. A *voltage labeled graph* on a vertex-edge labeled graph G^L is a 2-tuple $(G^L; \alpha)$ with a voltage assignments $\alpha : E(G^L) \rightarrow \Gamma$ such that

$$\alpha(u, v) = \alpha^{-1}(v, u), \quad \forall (u, v) \in E(G^L).$$

Similar to voltage graphs such as those shown in Example 3.1.3, the importance of voltage labeled graphs lies in their *labeled lifting* $G^{L\alpha}$ defined by

$$V(G^{L\alpha}) = V(G^L) \times \Gamma, \quad (u, g) \in V(G^L) \times \Gamma \text{ abbreviated to } u_g;$$

$$E(G^{L\alpha}) = \{ (u_g, v_{goh}) \mid \text{for } \forall (u, v) \in E(G^L) \text{ with } \alpha(u, v) = h \}$$

with labels $\Theta_L : G^{L\alpha} \rightarrow L$ following:

$$\Theta_L(u_g) = \theta_L(u), \quad \text{and} \quad \Theta_L(u_g, v_{goh}) = \theta_L(u, v)$$

for $u, v \in V(G^L)$, $(u, v) \in E(G^L)$ with $\alpha(u, v) = h$ and $g, h \in \Gamma$.

For a voltage labeled graph (G^L, α) with its lifting $G^{L\alpha}$, a *natural projection* $p : G^{L\alpha} \rightarrow G^L$ is defined by $p(u_g) = u$ and $p(u_g, v_{goh}) = (u, v)$ for $\forall u, v \in V(G^L)$ and $(u, v) \in E(G^L)$ with $\alpha(u, v) = h$. Whence, $(G^{L\alpha}, p)$ is a covering space of the labeled graph G^L . In this covering, we can find

$$p^{-1}(u) = \{ u_g \mid \forall g \in \Gamma \}$$

for a vertex $u \in V(G^L)$ and

$$p^{-1}(u, v) = \{ (u_g, v_{goh}) \mid \forall g \in \Gamma \}$$

for an edge $(u, v) \in E(G^L)$ with $\alpha(u, v) = h$. Such sets $p^{-1}(u)$, $p^{-1}(u, v)$ are called *fibres* over the vertex $u \in V(G^L)$ or edge $(u, v) \in E(G^L)$, denoted by fib_u or $\text{fib}_{(u,v)}$, respectively.

A voltage labeled graph with its labeled lifting are shown in Fig.4.5.1, in where, $G^L = C_3^L$ and $\Gamma = Z_2$.

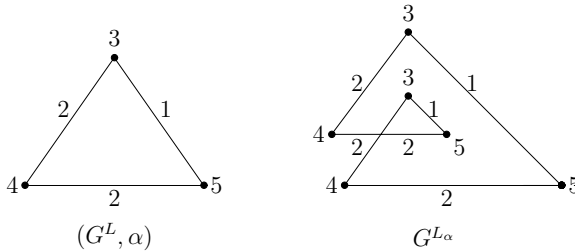

Fig.4.5.1

A mapping $g : G^L \rightarrow G^L$ is *acting on a labeled graph* G^L with a labeling $\theta_L : G^L \rightarrow L$ if $g\theta_L(x) = \theta_Lg(x)$ for $\forall x \in V(G^L) \cup E(G^L)$, and a group Γ is acting on a labeled graph G^L if each $g \in \Gamma$ is acting on G^L . Clearly, if Γ is acting on a labeled graph G^L , then $\Gamma \leq \text{Aut}G$. In this case, we can define a quotient labeled graph G^L/Γ by

$$V(G^L/\Gamma) = \{ u^\Gamma \mid \forall u \in V(G^L) \},$$

$$E(G^L/\Gamma) = \{ (u, v)^\Gamma \mid \forall (u, v) \in E(G^L) \}$$

and a labeling $\theta_L^\Gamma : G^L/\Gamma \rightarrow L$ with

$$\theta_L^\Gamma(u^\Gamma) = \theta_L(u), \quad \theta_L^\Gamma((u, v)^\Gamma) = \theta_L(u, v)$$

for $\forall u \in V(G^L)$, $(u, v) \in E(G^L)$. It can be easily shown that this definition is well defined. According to Theorems 3.1.10 – 3.1.12, we get a conclusion on a voltage labeled graph (G^L, α) with its lifting $G^{L\alpha}$ following.

Theorem 4.5.1 *Let $p : G^{L\alpha} \rightarrow G^L$ be a covering projection of G^L and $f : I \rightarrow \widetilde{M}$ an arc correspondent to a walk in G^L . Then for $u \in V(G^L)$ there is a unique arc f^l which projects to f with the initial point u and homotopic arcs lift to homotopic arcs.* □

A group Γ is *freely* acting on a labeled graph G^L if for $\forall g \in \Gamma$, $g(x) = x$ for any element in $V(G^L) \cup E(G^L)$ implies that g is the unit element of action, i.e., fixing every element in G^L .

For voltage labeled graphs, a natural question is *which labeled graph \tilde{G}^L is a lifting of a voltage labeled graph (G^L, α) with $\alpha : E(G^L) \rightarrow \Gamma$?* For answer this question, we introduce an action Φ_g of Γ on $G^{L\alpha}$ for $\forall g \in \Gamma$ as follows.

For $\forall g \in \Gamma$, the action Φ_g of g on $G^{L\alpha}$ is defined by $\Phi_g(u_h) = u_{gh}$ and $\Phi_g \Theta_L = \Theta_L \Phi_g$, where $\Theta_L : G^{L\alpha} \rightarrow L$ is the labeling on $G^{L\alpha}$ induced by $\theta_L : G^L \rightarrow L$.

Then we know the following criterion.

Theorem 4.5.2 *Let Γ be a group acting freely on a labeled graph \tilde{G}^L and G^L the quotient graph \tilde{G}^L/Γ . Then there is an assignment $\alpha : E(G^L) \rightarrow \Gamma$ and a labeling of vertices in G^L by elements of $V(G^L) \times \Gamma$ such that $\tilde{G}^L = G^{L\alpha}$, and furthermore, the given action of Γ on \tilde{G}^L is the natural left action of Γ on $G^{L\alpha}$.*

Proof By definition, we only need to assign voltages on edges in G^L and prove the existence of a assignment such that $\tilde{G}^L = G^{L\alpha}$, without noting on what labels on these element in \tilde{G}^L and G^L already existence.

For this object, we choose positive directions on edges of G^L and \tilde{G}^L so that the quotient mapping $q_\Gamma : \tilde{G}^L \rightarrow G^L$ is direction-preserving and that the action of Γ on \tilde{G}^L preserves directions first. Then, for for each vertex v in G^L , relabel one vertex of the orbit $q_\Gamma^{-1}(v)$ in \tilde{G}^L by v_{1_Γ} , and for every group element $g \in \Gamma, g \neq 1_\Gamma$, relabel the vertex $\phi_g(v_{1_\Gamma})$ as v_g . Now if the edge e of G^L runs from u to w , we assigns the label e_g to the edge of orbit $q_\Gamma^{-1}(e)$ that originates at the vertex u_g . Since Γ acts freely on \tilde{G}^L , there are just $|\Gamma|$ edges in the orbit $q_\Gamma^{-1}(e)$, one originating at each of the vertices in the vertex orbit $q_\Gamma^{-1}(v)$. Thus the choice of an edge to be labeled e_g is unique. Finally, if the terminal vertex of the edge e_{1_Γ} is w_h , one assigns a voltage h to the edge e in G^L . To show that this relabeling of edges in $q_\Gamma^{-1}(e)$ and the choice of voltages h for the edge e really yields an isomorphism $\vartheta : \tilde{G}^L \rightarrow G^{L\alpha}$, one needs to show that for $\forall g \in \Gamma$ that the edge e_g terminates at the vertex w_{goh} . However, since $e_g = \phi_g(e_{1_\Gamma})$, the terminal vertex of the edge e_g must be the terminal vertex of the edge $\phi_g(e_{1_\Gamma})$, which is

$$\phi_g(w_h) = \phi_g \phi_h(w_{1_\Gamma}) = \phi_{goh}(w_{1_\Gamma}) = w_{goh}.$$

Under this relabeling process, the isomorphism $\vartheta : \tilde{G}^L \rightarrow G^{L\alpha}$ identifies orbits in \tilde{G}^L with fibers of $G^{L\alpha}$. Moreover, it is defined precisely so that the action of Γ on \tilde{G}^L is consistent with the natural left action of Γ on the lifting graph $G^{L\alpha}$. \square

The construction of lifting from a voltage labeled graph implies the following result, which means that $G^{L\alpha}$ is a $|\Gamma|$ -fold covering over (G^L, α) with $\alpha : E(G^L) \rightarrow \Gamma$.

Theorem 4.5.3 *Let $G^{L\alpha}$ be the lifting of the voltage labeled graph (G^L, α) with $\alpha : E(G^L) \rightarrow \Gamma$. Then*

$$|\text{fib}_u| = |\text{fib}_{(u,v)}| = |\Gamma| \text{ for } \forall u \in V(G^L) \text{ and } (u, v) \in E(G^L),$$

and furthermore, denote by $C_{G^L}^v(l)$ and $C_{G^L}^e(l)$ the sets of vertices or edges for a label $l \in L$ in a labeled graph G^L . Then

$$|C_{G^{L\alpha}}^v(l)| = |\Gamma| |C_{G^L}^v(l)| \text{ and } |C_{G^{L\alpha}}^e(l)| = |\Gamma| |C_{G^L}^e(l)|.$$

Proof By definition, Γ is freely acting on $G^{L\alpha}$. Whence, we find that $|\text{fib}_u| = |\text{fib}_{(u,v)}| = |\Gamma|$ for $\forall u \in V(G^L)$ and $(u, v) \in E(G^L)$. Then it follows that $|C_{G^{L\alpha}}^v(l)| = |\Gamma| |C_{G^L}^v(l)|$ and $|C_{G^{L\alpha}}^e(l)| = |\Gamma| |C_{G^L}^e(l)|$. \square

4.5.3 Lifting Automorphism of Voltage Labeled Graph. Applying the action of the fundamental group of G^L , we can find criterions for the lifting set $\text{Lft}(f)$ of an automorphism $f \in \text{Aut}G^L$. First, we have two general results following on the lifting automorphism of a labeled graph.

Theorem 4.5.4 *Let $p : \tilde{G}^L \rightarrow G^L$ be a covering projection and f an automorphism of G^L . Then f lifts to a $f^l \in \text{Aut}\tilde{G}^L$ if and only if, for an arbitrarily chosen base vertex $u \in V(G^L)$, there exists an isomorphism of actions*

$$(\varphi, f) : (\text{fib}_u, \pi(G^L, u)) \rightarrow (\text{fib}_{f(u)}, \pi(G^L, f(u)))$$

of the fundamental groups such that $f^l|_{\text{fib}_u} = \varphi$, and moreover, there is a bijection correspondence between $\text{Lft}(f)$ and functions φ for which (φ, f) is such an automorphism with

$$f^l(\tilde{u}) = \varphi(\tilde{u} \cdot L) \cdot f(L^{-1}),$$

where $L : p(\tilde{u}) \rightarrow u$ is an arc.

Proof First, let f^l be a lifting of f and $L : p(\tilde{u}) \rightarrow u$ an arc. Then $f^l(L^l) : f^l(\tilde{u}) \rightarrow f^l(\tilde{u} \cdot L)$ projects to $f(L)$, which implies that $f^l(\tilde{u} \cdot L) = f^l(\tilde{u}) \cdot f(L)$. Particularly, this equality holds for $\forall \tilde{u} \in \text{fib}_u$ and $L \in \pi_1(G^L, u)$. Since $\varphi = f^l|_{\text{fib}_u}$, the required isomorphism of action is obtained.

Conversely, let (φ, f) be such an isomorphism. We define f^l as follows. Choose an arbitrary vertex \tilde{v} in \tilde{G}^L and $v = p(\tilde{v})$. Let $L : v \rightarrow u$ be an arbitrary arc and set

$$f^l(\tilde{v}) = \varphi(\tilde{v} \cdot f(L^{-1})).$$

Then this mapping is well defined, i.e., it does not depend on the choice of L . In fact, let $L_1, L_2 : v \rightarrow u$. Then $\tilde{v} \cdot L_1 = (\tilde{v} \cdot L_2) \cdot L_2^{-1}L_1$. Whence, $\varphi(\tilde{v} \cdot L_1) = \varphi((\tilde{v} \cdot L_2)) \cdot f(L_2^{-1}L_1) = \varphi((\tilde{v} \cdot L_2)) \cdot f(L_2^{-1}) \cdot f(L_1)$. Thereafter, we get that $\varphi(\tilde{v} \cdot L_1) \cdot f(L_1^{-1}) = \varphi(\tilde{v} \cdot L_2) \cdot f(L_2^{-1})$.

From the definition of f^l it is easily seen that $pf^l(\tilde{v}) = fp(\tilde{v})$. We verify it is a bijection. First, we show it is onto. Now let \tilde{w} be an arbitrary vertex of $G^{L\alpha}$ and choose $L : p(\tilde{w}) \rightarrow f(u)$ arbitrarily. Then it is easily to check that the vertex $\varphi^{-1}(\tilde{w} \cdot L) \cdot f^{-1}(L^{-1})$ mapped to \tilde{w} . For its one-to-one, let $\varphi(\tilde{v}_1 \cdot L_1) \cdot f(L_1^{-1}) = f^l(\tilde{v}_1) = f^l(\tilde{v}_2) = \varphi(\tilde{v}_2 \cdot L_2) \cdot f(L_2^{-1})$. Whence, $f(L_1)$ and $f(L_2)$ have the same initial vertex. Consequently, so do L_1 and L_2 . Therefore, \tilde{v}_1 and \tilde{v}_2 is in the same fibre. Furthermore, we know that $\varphi(\tilde{v}_1 \cdot L_1) \cdot f(L_1^{-1}L_2) = \varphi(\tilde{v}_2 \cdot L_2)$, which implies that $\varphi(\tilde{v}_1 \cdot L_1 \cdot L_1^{-1}L_2) = \varphi(\tilde{v}_2 \cdot L_2)$. That is, $\varphi(\tilde{v}_1 \cdot L_2) = \varphi(\tilde{v}_2 \cdot L_2)$. Thus $\tilde{v}_1 \cdot L_2 = \tilde{v}_2 \cdot L_2$ and so $\tilde{v}_1 = \tilde{v}_2$.

Now we conclude that f^l is really a lifting of f . This shows that $\text{Lft}(f) \rightarrow \text{Lft}(f)|_{\text{fib}_u}$ defines a function onto the set of all such φ for which (φ, f) is an isomorphism of fundamental groups, and it is one-to-one. \square

The next result presents how an arbitrary lifted automorphism acts on fibres with stabilizer under the action of the fundamental group.

Theorem 4.5.5 *Let $p : \tilde{G}^L \rightarrow G^L$ be a covering projection and f an automorphism of G^L . Then,*

(i) *there exists an isomorphism of actions*

$$(\varphi, f) : (\text{fib}_u, \pi(G^L, u)) \rightarrow (\text{fib}_{f(u)}, \pi(G^L, f(u)))$$

if and only if f maps the stabilizer $(\pi_1(\tilde{G}^L))_{\tilde{u}}$ of an arbitrarily chosen base point $\tilde{u} \in \text{fib}_u$ isomorphically onto some stabilizer $(\pi_1(\tilde{G}^L))_{\tilde{v}} \leq \pi_1(G^L, f(u))$. In this case, $\tilde{v} = \varphi(\tilde{u})$ and there is a bijective correspondence between all choice of such a vertex \tilde{v} and all such isomorphisms.

(ii) Choose a base point $\tilde{w} \in \text{fib}_{f(u)}$ and $Q \in \pi_1(G^L, f(u))$ such that

$$Q^{-1}\pi_1(\tilde{G}^L, \tilde{d})Q = f\pi_1(\tilde{G}^L, \tilde{u}),$$

all such bijections $\varphi = \varphi_P$ are given by

$$\varphi_P(\tilde{u} \cdot S) = \tilde{w} \cdot Pf(S), \quad \text{for } S \in \pi_1(G^L, u),$$

where P belong to the coset $N(\pi_1(\tilde{G}^L, \tilde{w}))Q$ of the normalizer of $\pi_1(\tilde{G}^L)_{\tilde{w}}$ within $\pi_1(G^L, f(u))$. Moreover, $\varphi_{P'} = \varphi_P$ if and only if $P' \in \pi_1(\tilde{G}^L, \tilde{w})P$.

Proof It is clear that (φ, f) is an isomorphism of actions, then these conditions holds. Conversely, let $f\pi_1(G^L, u)_{\tilde{u}} = \pi_1(G^L, f(b))_{\tilde{v}}$. Each $\tilde{x} \in \text{fib}_u$ can be written as $\tilde{x} = \tilde{u} \cdot S$ for some $S \in \pi_1(G^L, u)$ because G^L is connected. Define φ by setting $\varphi(\tilde{x}) = \tilde{v} \cdot f(S)$. we can easily check that (φ, f) is the required isomorphism of actions. The assertion bijective correspondence should also be clear since φ is completely determined by the image of one point. This concludes (i).

For (ii), let $\tilde{v} = \tilde{w} \cdot P$ be any point satisfying the condition of (i). Then we know that $P^{-1}\pi_1(\tilde{G}^L, \tilde{w})P = \pi_1(G^{L\alpha}, \tilde{w} \cdot P) = Q^{-1}\pi_1(\tilde{G}^L, \tilde{w})Q$, that is $PQ^{-1} \in N(\pi_1(\tilde{G}^L, \tilde{w}))$. The last statement is obvious. \square

Now we turn our attention to lifting automorphisms of voltage labeled graphs by Applying Theorems 4.5.4 and 4.5.5. For this objective, We introduce some useful conceptions following.

Let (G^L, α) be a voltage labeled graph with $\alpha : E(G^L) \rightarrow \Gamma$. For $u \in V(G^L)$, the local voltage group Γ^u at u is defined by

$$\Gamma^u = \langle \alpha(L) \mid \text{for } \forall L \in \pi_1(G^L, u) \rangle.$$

Moreover, for $v \in V(G^L)$, by the connectedness of G^L , let $W : u \rightarrow v$ be an arc connecting u with v in G^L . Then the inner automorphism $W^\#(g) = \alpha^{-1}(W)g\alpha(W)$ of Γ for $g \in \Gamma^u$, takes Γ^u to Γ^v .

Let A be a group of automorphisms of G^L . A voltage labeled graph (G^L, α) is called *locally A-invariant* at a vertex $u \in V(G^L)$ if for $\forall f \in A$ and $W \in \pi_1(G^L, u)$, we have

$$\alpha(W) = \text{identity} \Rightarrow \alpha(f(W)) = \text{identity}$$

and *locally f-invariant* for an automorphism $f \in \text{Aut}G^L$ if it is locally invariant with respect to the group $\langle f \rangle$ in $\text{Aut}G^L$. Notice that for each $f \in A$, $f^{-1} \in A$ also satisfying the required inference. Whence, the local A -invariance is equivalent to the requirement that for $\forall f \in A$, there exists an induced isomorphism $f^{\#u} : \Gamma^u \rightarrow \Gamma^{f(u)}$ of local voltage groups such that the following diagram

$$\begin{array}{ccc} \pi_1(G^L, u) & \xrightarrow{f} & \pi_1(G^L, f(u)) \\ \alpha \downarrow & & \downarrow \alpha \\ \pi_1(G^L, u) & \xrightarrow{f^{\#u}} & \pi_1(G^L, f(u)) \end{array}$$

Fig.4.5.2

is commutative, i.e., $f^{\#u}(\alpha(W)) = \alpha(f(W))$ for $\forall W \in \pi_1(G^L, u)$. Then we know a criterion for lifting automorphisms of voltage labeled graphs.

Theorem 4.5.6 *Let (G^L, α) be a voltage labeled graph with $\alpha : E(G^L) \rightarrow \Gamma$ and $f \in \text{Aut}G^L$. Then f lifts to an automorphism of $G^{L\alpha}$ if and only if (G^L, α) is locally f -invariant.*

Proof By definition, the mapping $(l_u, \alpha) : (\text{fib}_u, \pi_1(G^L, u)) \rightarrow (\Gamma, \Gamma^u)$ with $l_u : \text{fib}_u \rightarrow \Gamma$ is a bijection. Whence, if $W \in \pi_1(G^L, u)$ and $l_u(\tilde{u}) = g$, then $W \in (\pi_1(G^L, u))_{\tilde{u}}$ if and only if $\alpha(W) \in \Gamma_g^u$, i.e., $g\alpha(W) = g$, which implies that $\alpha(W) = \text{identity}$.

According to Theorem 4.5.2, the action of Γ on vertices of $G^{L\alpha}$ is free. Whence, applying Theorems 4.5.4 and 4.5.4, we know that f lifts to an automorphism of $G^{L\alpha}$ if and only if (G^L, α) is locally f -invariant. □

4.5.4 Regular Covering of Combinatorial manifold. Let \widetilde{M} be a finitely combinatorial manifold underlying a connected graph G . Applying Theorem 4.2.4, we know that \widetilde{M} determines a vertex-edge labeled graph $G^L[\widetilde{M}]$ by labeling its vertices and edges with dimensions of correspondent manifolds, and vice versa. Such correspondence is combinatorially unique.

The voltage assignment technique on the labeled graph $G^L[\widetilde{M}]$ naturally induces a combinatorial manifold \widetilde{M}^* by Theorem 4.2.4. Assume $(G^{L\alpha}[\widetilde{M}], p)$ is a covering of $G^L[\widetilde{M}]$ with $\alpha : E(G^L[\widetilde{M}]) \rightarrow \Gamma$. For $\forall M \in V(G^L[\widetilde{M}])$, let $h_s : M \rightarrow M$ be a self-homeomorphism of \widetilde{M} , $\varsigma_M : x \rightarrow M$ for $\forall x \in M$, and define $p^* = h_s \circ \varsigma_M^{-1} p \varsigma_M$. Then we know that $p^* : \widetilde{M}^* \rightarrow \widetilde{M}$ is a covering projection.

Theorem 4.5.7 (\widetilde{M}^*, p^*) is a $|\Gamma|$ -sheeted covering, called natural covering of \widetilde{M} .

Proof For $M \in V(G^L[\widetilde{M}])$, let $x \in M$. By definition, for $\forall M_g \in V(G^{L\alpha}[\widetilde{M}])$ and $\forall h_s^{-1}(x)^* \in M_g$, we know that

$$p^*((h_s^{-1}(x))^*) = h_s \circ \varsigma_{M_g}^{-1} p \varsigma_{M_g}((h_s^{-1}(x))^*) = h_s(h_s^{-1}(x)) = x \in M.$$

By definitions of the voltage labeled graph and the mapping p^* , we find easily that each arcwise component of $(p^*)^{-1}(U_x)$ is mapped topologically onto the neighborhood U_x for $\forall x \in \widetilde{M}$. Whence, $p^* : \widetilde{M}^* \rightarrow \widetilde{M}$ is a covering mapping.

Notice that there are $|\Gamma|$ copies $M_g, g \in \Gamma$ for $\forall M \in V(G^L(\widetilde{M}))$. Whence, (\widetilde{M}^*, p^*) is a $|\Gamma|$ -sheeted covering of \widetilde{M} . □

Let $p_1 : \widetilde{S}_1 \rightarrow S$ and $p_2 : \widetilde{S}_2 \rightarrow S$ be two covering projections of topological spaces. They are said to be *equivalent* if there exists a one-to-one mapping $\tau : \widetilde{S}_1 \rightarrow \widetilde{S}_2$ such that the following

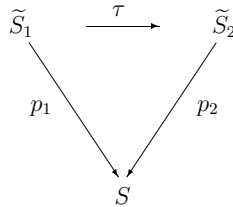

Fig.4.5.3

is commutative. Then, how many non-equivalent natural coverings \widetilde{M}^* are over \widetilde{M} under the covering projection $p^* : \widetilde{M}^* \rightarrow \widetilde{M}$? By definition, this question is equivalent to a combinatorial problem: to enumerate non-equivalent voltage labeled graphs $(G^L[\widetilde{M}], \alpha)$ with $\alpha : E(G^L[\widetilde{M}]) \rightarrow \Gamma$ under the action of $\text{Aut}G^L[\widetilde{M}]$. Finding such exact numbers is difficult in general. Applying Burnside Lemma, i.e., Corollary 2.5.4 for counting orbits, we can know the following result.

Theorem 4.5.8 *The number $n^c(\widetilde{M})$ of non-equivalent natural coverings of a finitely combinatorial manifold \widetilde{M} is*

$$n^c(\widetilde{M}) = \frac{1}{|\text{Aut}|G^L[\widetilde{M}]} \sum_{g \in \text{Aut}G^L[\widetilde{M}]} |\Phi(g)|,$$

where $\Phi(g) = \{\alpha : E(G^L) \rightarrow \Gamma \mid \alpha g = g\alpha\}$.

Proof B definition, two voltage labeled graphs $(G^L[\widetilde{M}], \alpha_1)$, $(G^L[\widetilde{M}], \alpha_2)$ are equivalent if there is an one-to-one mapping $f : V(G^L[\widetilde{M}]) \rightarrow V(G^L[\widetilde{M}])$ such that $f\alpha = \alpha f$ and $f\theta_L = \theta_L f$. Whence, there must be that $f \in \text{Aut}G^L[\widetilde{M}]$. Then follows Corollary 2.5.4, we get the conclusion. \square

Particularly, if $\text{Aut}G^L[\widetilde{M}]$ is trivial or transitive, we get the following results for the non-equivalent natural covering of a finite combinatorial manifold.

Corollary 4.5.1 *Let \widetilde{M} be a finitely combinatorial manifold. Then,*

(i) if $\text{Aut}G^L[\widetilde{M}]$ is trivial, then

$$n^c(\widetilde{M}) = \varepsilon^{|\Gamma|}(G^L[\widetilde{M}]).$$

(ii) if $\text{Aut}G^L[\widetilde{M}]$ is transitive, then

$$n^c(\widetilde{M}) = \binom{|\Gamma| + \varepsilon(G^L[\widetilde{M}]) - 1}{\varepsilon(G^L[\widetilde{M}])}.$$

Proof If $\text{Aut}G^L[\widetilde{M}]$ is trivial, then $\alpha : E(G^L[\widetilde{M}]) \rightarrow \Gamma$ depends on edges in $G^L[\widetilde{M}]$ and such mappings induce non-equivalent natural coverings over \widetilde{M} . A simple counting shows that there are $\varepsilon^{|\Gamma|}(G^L[\widetilde{M}])$ such voltage labeled graphs. This is the conclusion (i).

Now for (ii), if $\text{Aut}G^L[\widetilde{M}]$ is transitive, then $\alpha : E(G^L[\widetilde{M}]) \rightarrow \Gamma$ does not depend on edges in $G^L[\widetilde{M}]$. Whence, it is equal to the number of choosing $\varepsilon(G^L[\widetilde{M}])$ elements repeatedly from a $|\Gamma|$ -set, which in turn is

$$n^c(\widetilde{M}) = \binom{|\Gamma| + \varepsilon(G^L[\widetilde{M}]) - 1}{\varepsilon(G^L[\widetilde{M}])}.$$

\square

As a part of enumerating non-equivalent natural coverings, many mathematicians turn their attentions to non-equivalent surface coverings of a connected graph with a trivial voltage group Γ . Such as those of results in [Mao1], [MLT1], [MLW1], [Mul1] and [MRW1]. For example, if $G^L[\widetilde{M}]$ is the labeled complete graph K_n^L , we have the following result in [Mao1] for surface coverings.

Theorem 4.5.9 *The number $n^c(\widetilde{M})$ with $G^L[\widetilde{M}] \cong K_n^L$, $n \geq 5$ on surfaces is*

$$n^c(\widetilde{M}) = \frac{1}{2} \left(\sum_{k|n} + \sum_{k|n, k \equiv 0 \pmod{2}} \right) \frac{2^{\alpha(n,k)} (n-2)! \binom{n}{k}}{k^{\frac{n}{k}} \left(\frac{n}{k}\right)!} + \sum_{k|(n-1), k \neq 1} \frac{\phi(k) 2^{\beta(n,k)} (n-2)! \binom{n-1}{k}}{n-1},$$

where,

$$\alpha(n, k) = \begin{cases} \frac{n(n-3)}{2k}, & \text{if } k \equiv 1 \pmod{2}; \\ \frac{n(n-2)}{2k}, & \text{if } k \equiv 0 \pmod{2}, \end{cases}$$

and

$$\beta(n, k) = \begin{cases} \frac{(n-1)(n-2)}{2k}, & \text{if } k \equiv 1 \pmod{2}; \\ \frac{(n-1)(n-3)}{2k}, & \text{if } k \equiv 0 \pmod{2}. \end{cases}$$

and $n^c(\widetilde{M}) = 11$ if $G^L[\widetilde{M}] \cong K_4^L$. □

For meeting the needs of combinatorial differential geometry in following chapters, we introduce the conception of *combinatorial fiber bundles* following.

Definition 4.5.2 *A combinatorial fiber bundle is a 4-tuple $(\widetilde{M}^*, \widetilde{M}, p, G)$ consisting of a covering combinatorial manifold \widetilde{M}^* , a group G , a combinatorial manifold \widetilde{M} and a projection mapping $p : \widetilde{M}^* \rightarrow \widetilde{M}$ with properties following:*

- (i) G acts freely on \widetilde{M}^* to the right.
- (ii) the mapping $p : \widetilde{M}^* \rightarrow \widetilde{M}$ is onto, and for $\forall x \in \widetilde{M}$, $p^{-1}(p(x)) = \text{fib}_x = \{x_g | \forall g \in \Gamma\}$ and $l_x : \text{fib}_x \rightarrow \Gamma$ is a bijection.
- (iii) for $\forall x \in \widetilde{M}$ with its a open neighborhood U_x , there is an open set \widetilde{U} and a mapping $T_x : p^{-1}(U_x) \rightarrow U_x \times \Gamma$ of the form $T_x(y) = (p(y), s_x(y))$, where $s_x : p^{-1}(U_x) \rightarrow \Gamma$ has the property that $s_x(yg) = s_x(y)g$ for $\forall g \in G$ and $y \in p^{-1}(U_x)$.

Summarizing the discussion in this section, we get the main result following of this section.

Theorem 4.5.10 *Let \widetilde{M} be a finite combinatorial manifold and $(G^L([\widetilde{M}]), \alpha)$ a voltage labeled graph with $\alpha : E(G^L([\widetilde{M}])) \rightarrow \Gamma$. Then $(\widetilde{M}^*, \widetilde{M}, p^*, \Gamma)$ is a combinatorial fiber bundle, where \widetilde{M}^* is the combinatorial manifold correspondent to the lifting $G^{L\alpha}([\widetilde{M}])$, $p^* : \widetilde{M}^* \rightarrow \widetilde{M}$ a natural projection determined by $p^* = h_s \circ \varsigma_M^{-1} p_{\varsigma_M}$ with $h_s : M \rightarrow M$ a self-homeomorphism of \widetilde{M} and $\varsigma_M : x \rightarrow M$ a mapping defined by $\varsigma_M(x) = M$ for $\forall x \in M$. □*

§4.6 REMARKS

4.6.1 How to visualize a Euclidean space of dimension ≥ 4 is constantly making one hard to understand. Certainly, we can describe a point of an n -dimensional Euclidean space \mathbf{R}^n by an n -tuple (x_1, x_2, \dots, x_n) . But how to visualize it is still hard since one can just see objects in \mathbf{R}^3 . The combinatorial Euclidean space presents an approach decomposing a higher dimensional space to a lower dimensional one with a combinatorial structure. The discussion in Section 4.1 mainly on the following packing problem, i.e., *in what conditions do $\mathbf{R}^{n_1}, \mathbf{R}^{n_2}, \dots, \mathbf{R}^{n_m}$ consist of a combinatorial Euclidean space $\mathcal{E}_G(n_1, n_2, \dots, n_m)$?* Particularly, the following dimensional problem.

Problem 4.6.1 *Let $\mathbf{R}^{n_1}, \mathbf{R}^{n_2}, \dots, \mathbf{R}^{n_m}$ be Euclidean spaces. Determine the dimensional number $\dim \mathcal{E}_G(n_1, n_2, \dots, n_m)$, particularly, the dimensional number $\dim \mathcal{E}_G(r)$, $r \geq 2$ for a given graph G .*

Theorems 4.1.1–4.1.3 partially solved this problem, and Theorems 4.1.4–4.1.5 got the number $\dim \mathcal{E}_{K_n}(r)$. But for any connected graph G , this problem is still open.

Notice that the combinatorial fan-space is indeed a Euclidean space, which consists of the local topological or differential structure of a combinatorial manifold.

4.6.2 The material in Sections 4.2 and 4.3 is extracted from [Mao14] and [Mao16]. In fact, the intersection of two manifolds maybe very complex. That is why we can only get the fundamental groups or singular homology groups of combinatorial manifolds in some special cases. Although so, the reader is encouraged to find more such fundamental groups or singular homology groups constraint on conditions. A more

heartening thing in Section 4.2 is the correspondence of a combinatorial manifold with a vertex-edge labeled graph, which enables one to get its regular covering in Section 4.5 and combinatorial fields in Chapter 8.

4.6.3 The well-known Seifer and Von Kampen theorem on fundamental groups is very useful in calculation of fundamental groups of topological spaces. Extending its application to a wide range, the following problem is interesting.

Problem 4.6.2 *Generalize the Seifer and Von-Kampen theorem to the case of that $U \cap V$ maybe not arcwise connected.*

Corollary 4.3.4 is an interesting result in combinatorics, which shows that the fundamental group of a surface can be completely determined by a graph embedded on this surface. Applying this result to enumerate rooted or unrooted combinatorial maps on surfaces (see [Mao1], [Liu2] and [Liu3] for details) is worth to make a through inquiry.

4.6.4 Each singular homology group is an Abelian group by definition. That is why we always find singular groups of a space with the form of $\mathbf{Z} \times \cdots \times \mathbf{Z}$. Theorems 4.4.11 – 4.4.12 determined the singular homology groups of combinatorial manifolds constraint on conditions. The reader is encourage to solve the general problem on singular homology groups of combinatorial manifolds following.

Problem 4.6.3 *Determine the singular homology groups of combinatorial manifolds.*

Furthermore, the inverse problem following.

Problem 4.6.4 *For an integer $n \geq 1$, determine what kind of topological spaces S with singular homology groups $H_q(S) \cong \underbrace{\mathbf{Z} \times \cdots \times \mathbf{Z}}_n$ for some special integers q , particularly, these combinatorial manifolds.*

4.6.5 The definition of various voltage graphs can be found in [GrT1]. Recently, many mathematicians are interested to determine the lifting of an automorphism of a graph or a combinatorial map on a surface. Results in references [MNS1] and [NeS1] are such kind. It is essentially the application of Theorems 3.1.11 – 3.1.13. The main material on the lifting of automorphisms in Section 4.5 is extracted from [MNS1]. But in here, we apply it to the case of labeled graph.

Many mathematicians also would like to classify covering of a graph G or a combinatorial map under the action of $\text{Aut}G$ in recent years. Theorem 4.5.9 is such a result for complete graphs. More results can be found in references, such as those of [KwL1], [Lis1]-[Lis2], [LiW1], [Mao1], [MLT1], [MLW1], [Mul1] and [MRW1], etc..

4.6.6 As we have seen in last chapter, the fiber bundle is indeed the application of covering spaces with a space. Applying the relation of a combinatorial manifold with the vertex-edge labeled graph, Section 4.5 presents a construction approach for covering of finitely combinatorial manifold by the voltage labeled graph with its lifting. In fact, this kind of construction enables one to get regular covering of finitely combinatorial manifold, also the combinatorial fiber bundle by a combinatorial technique. We will apply it in the Chapter 6 for finding differential behavior of combinatorial manifolds with covering, i.e., the principal fiber bundle of finitely combinatorial manifolds.

CHAPTER 5.

Combinatorial Differential Geometry

The combinatorial differential geometry is a geometry on the locally or globally differential behavior of combinatorial manifolds. By introducing differentiable combinatorial manifolds, we determine the basis of tangent or cotangent vector space at a point on a combinatorial manifold in Section 5.1. As in the case of differentiable manifolds, in Section 5.2 we define tensor, tensor field, k -forms at a point on a combinatorial manifold and determine their basis. The existence of exterior differentiation on k -forms is also discussed in this section. Section 5.3 introduces the conception of connection on tensors and presents its local form on a combinatorial manifold. Particular results are also gotten for these torsion-free tensors and combinatorial Riemannian manifolds. The curvature tensors on combinatorial manifolds are discussed in Sections 5.4 and 5.5, where we obtain the first and second Bianchi equalities, structural equations and local form of curvature tensor for both combinatorial manifolds and combinatorial Riemannian manifolds, which is the fundamental of applications of combinatorial manifold to theoretical physics. Sections 5.6 and 5.7 concentrate on the integration theory on combinatorial manifolds. It is different from the case of differentiable manifolds. Here, we need to determine what dimensional numbers k ensure the existence of integration on k -forms of a combinatorial manifold. Then we generalize the classical Stokes' and Gauss' theorems to combinatorial manifolds. The material in Section 5.8 is interesting, which shows that nearly all existent differential geometries are special cases of Smarandache geometries. Certainly, there are many open problems in this area, even if we consider the counterpart in manifolds for differentiable combinatorial manifold.

§5.1 DIFFERENTIABLE COMBINATORIAL MANIFOLDS

5.1.1 Smoothly Combinatorial Manifold. We introduce differential structures on finitely combinatorial manifolds and characterize them in this section.

Definition 5.1.1 For a given integer sequence $1 \leq n_1 < n_2 < \dots < n_m$, a combinatorial C^h -differential manifold $(\widetilde{M}(n_1, n_2, \dots, n_m); \widetilde{\mathcal{A}})$ is a finitely combinatorial manifold $\widetilde{M}(n_1, n_2, \dots, n_m)$, $\widetilde{M}(n_1, n_2, \dots, n_m) = \bigcup_{i \in I} U_i$, endowed with an atlas $\widetilde{\mathcal{A}} = \{(U_\alpha; \varphi_\alpha) | \alpha \in I\}$ on $\widetilde{M}(n_1, n_2, \dots, n_m)$ for an integer $h, h \geq 1$ with conditions following hold.

(1) $\{U_\alpha; \alpha \in I\}$ is an open covering of $\widetilde{M}(n_1, n_2, \dots, n_m)$.

(2) For $\forall \alpha, \beta \in I$, local charts $(U_\alpha; \varphi_\alpha)$ and $(U_\beta; \varphi_\beta)$ are equivalent, i.e., $U_\alpha \cap U_\beta = \emptyset$ or $U_\alpha \cap U_\beta \neq \emptyset$ but the overlap maps

$$\varphi_\alpha \varphi_\beta^{-1} : \varphi_\beta(U_\alpha \cap U_\beta) \rightarrow \varphi_\alpha(U_\alpha \cap U_\beta) \quad \text{and} \quad \varphi_\beta \varphi_\alpha^{-1} : \varphi_\alpha(U_\alpha \cap U_\beta) \rightarrow \varphi_\beta(U_\beta)$$

are C^h -mappings, such as those shown in Fig.5.1.1 following.

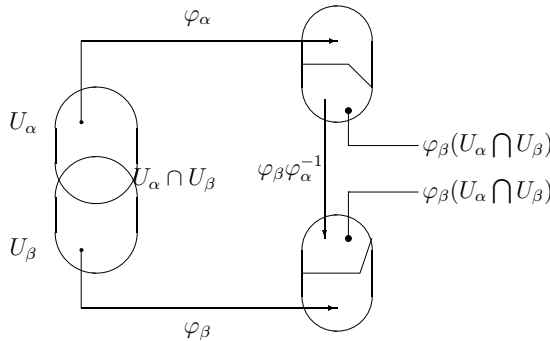

Fig.5.1.1

(3) $\widetilde{\mathcal{A}}$ is maximal, i.e., if $(U; \varphi)$ is a local chart of $\widetilde{M}(n_1, n_2, \dots, n_m)$ equivalent with one of local charts in $\widetilde{\mathcal{A}}$, then $(U; \varphi) \in \widetilde{\mathcal{A}}$.

Denote by $(\widetilde{M}(n_1, n_2, \dots, n_m); \widetilde{\mathcal{A}})$ a combinatorial differential manifold. A finitely combinatorial manifold $\widetilde{M}(n_1, n_2, \dots, n_m)$ is said to be smooth if it is endowed with a C^∞ -differential structure.

Let $\tilde{\mathcal{A}}$ be an atlas on $\tilde{M}(n_1, n_2, \dots, n_m)$. Choose a local chart $(U; \varpi)$ in $\tilde{\mathcal{A}}$. For $\forall p \in (U; \varphi)$, if $\varpi_p : U_p \rightarrow \bigcup_{i=1}^{s(p)} B^{n_i(p)}$ and $\hat{s}(p) = \dim(\bigcap_{i=1}^{s(p)} B^{n_i(p)})$, the following $s(p) \times n_{s(p)}$ matrix $[\varpi(p)]$

$$[\varpi(p)] = \begin{bmatrix} \frac{x^{11}}{s(p)} & \dots & \frac{x^{1\hat{s}(p)}}{s(p)} & x^{1(\hat{s}(p)+1)} & \dots & x^{1n_1} & \dots & 0 \\ \frac{x^{21}}{s(p)} & \dots & \frac{x^{2\hat{s}(p)}}{s(p)} & x^{2(\hat{s}(p)+1)} & \dots & x^{2n_2} & \dots & 0 \\ \dots & \dots & \dots & \dots & \dots & \dots & \dots & \dots \\ \frac{x^{s(p)1}}{s(p)} & \dots & \frac{x^{s(p)\hat{s}(p)}}{s(p)} & x^{s(p)(\hat{s}(p)+1)} & \dots & \dots & x^{s(p)n_{s(p)}-1} & x^{s(p)n_{s(p)}} \end{bmatrix}$$

with $x^{is} = x^{js}$ for $1 \leq i, j \leq s(p), 1 \leq s \leq \hat{s}(p)$ is called the *coordinate matrix* of p . For emphasize ϖ is a matrix, we often denote local charts in a combinatorial differential manifold by $(U; [\varpi])$. Using the coordinate matrix system of a combinatorial differential manifold $(\tilde{M}(n_1, n_2, \dots, n_m); \tilde{\mathcal{A}})$, we introduce the conception of C^h mappings and functions in the next.

Definition 5.1.2 Let $\tilde{M}_1(n_1, n_2, \dots, n_m), \tilde{M}_2(k_1, k_2, \dots, k_l)$ be smoothly combinatorial manifolds and

$$f : \tilde{M}_1(n_1, n_2, \dots, n_m) \rightarrow \tilde{M}_2(k_1, k_2, \dots, k_l)$$

be a mapping, $p \in \tilde{M}_1(n_1, n_2, \dots, n_m)$. If there are local charts $(U_p; [\varpi_p])$ of p on $\tilde{M}_1(n_1, n_2, \dots, n_m)$ and $(V_{f(p)}; [\omega_{f(p)}])$ of $f(p)$ with $f(U_p) \subset V_{f(p)}$ such that the composition mapping

$$\tilde{f} = [\omega_{f(p)}] \circ f \circ [\varpi_p]^{-1} : [\varpi_p](U_p) \rightarrow [\omega_{f(p)}](V_{f(p)})$$

is a C^h -mapping, then f is called a C^h -mapping at the point p . If f is C^h at any point p of $\tilde{M}_1(n_1, n_2, \dots, n_m)$, then f is called a C^h -mapping. Particularly, if $\tilde{M}_2(k_1, k_2, \dots, k_l) = \mathbf{R}$, f is called a C^h -function on $\tilde{M}_1(n_1, n_2, \dots, n_m)$. In the extreme $h = \infty$, these terminologies are called smooth mappings and functions, respectively. Denote by \mathcal{X}_p^h all these C^∞ -functions at a point $p \in \tilde{M}(n_1, n_2, \dots, n_m)$.

For the existence of combinatorial differential manifolds, we know the following result.

Theorem 5.1.1 Let $\tilde{M}(n_1, n_2, \dots, n_m)$ be a finitely combinatorial manifold and $d, 1 \leq d \leq n_1$ an integer. If $\forall M \in V(G^d[\tilde{M}(n_1, n_2, \dots, n_m)])$ is C^h -differential and $\forall (M_1, M_2) \in E(G^d[\tilde{M}(n_1, n_2, \dots, n_m)])$ there exist atlas

$$\mathcal{A}_1 = \{(V_x; \varphi_x) | \forall x \in M_1\} \quad \mathcal{A}_2 = \{(W_y; \psi_y) | \forall y \in M_2\}$$

such that $\varphi_x|_{V_x \cap W_y} = \psi_y|_{V_x \cap W_y}$ for $\forall x \in M_1, y \in M_2$, then there is a differential structures

$$\tilde{\mathcal{A}} = \{(U_p; [\varpi_p]) | \forall p \in \tilde{M}(n_1, n_2, \dots, n_m)\}$$

such that $(\tilde{M}(n_1, n_2, \dots, n_m); \tilde{\mathcal{A}})$ is a combinatorial C^h -differential manifold.

Proof By definition, We only need to show that we can always choose a neighborhood U_p and a homoeomorphism $[\varpi_p]$ for each $p \in \tilde{M}(n_1, n_2, \dots, n_m)$ satisfying these conditions (1) – (3) in definition 3.1.

By assumption, each manifold $\forall M \in V(G^d[\tilde{M}(n_1, n_2, \dots, n_m)])$ is C^h -differential, accordingly there is an index set I_M such that $\{U_\alpha; \alpha \in I_M\}$ is an open covering of M , local charts $(U_\alpha; \varphi_\alpha)$ and $(U_\beta; \varphi_\beta)$ of M are equivalent and $\mathcal{A} = \{(U; \varphi)\}$ is maximal. Since for $\forall p \in \tilde{M}(n_1, n_2, \dots, n_m)$, there is a local chart $(U_p; [\varpi_p])$ of p such that $[\varpi_p] : U_p \rightarrow \bigcup_{i=1}^{s(p)} B^{n_i(p)}$, i.e., p is an intersection point of manifolds $M^{n_i(p)}, 1 \leq i \leq s(p)$. By assumption each manifold $M^{n_i(p)}$ is C^h -differential, there exists a local chart $(V_p^i; \varphi_p^i)$ while the point $p \in M^{n_i(p)}$ such that $\varphi_p^i \rightarrow B^{n_i(p)}$. Now we define

$$U_p = \bigcup_{i=1}^{s(p)} V_p^i.$$

Then applying the Gluing Lemma again, we know that there is a homoeomorphism $[\varpi_p]$ on U_p such that

$$[\varpi_p]|_{M^{n_i(p)}} = \varphi_p^i$$

for any integer $i, 1 \leq i \leq s(p)$. Thereafter,

$$\tilde{\mathcal{A}} = \{(U_p; [\varpi_p]) | \forall p \in \tilde{M}(n_1, n_2, \dots, n_m)\}$$

is a C^h -differential structure on $\tilde{M}(n_1, n_2, \dots, n_m)$ satisfying conditions (1) – (3). Thereby $(\tilde{M}(n_1, n_2, \dots, n_m); \tilde{\mathcal{A}})$ is a combinatorial C^h -differential manifold. \square

5.1.2 Tangent Vector Space. For a point in a smoothly combinatorial manifold, we introduce the tangent vector at this point following.

Definition 5.1.3 Let $(\widetilde{M}(n_1, n_2, \dots, n_m), \widetilde{\mathcal{A}})$ be a smoothly combinatorial manifold and $p \in \widetilde{M}(n_1, n_2, \dots, n_m)$. A tangent vector \bar{v} at p is a mapping $\bar{v} : \mathcal{X}_p \rightarrow \mathbf{R}$ with conditions following hold.

- (1) $\forall g, h \in \mathcal{X}_p, \forall \lambda \in \mathbf{R}, \bar{v}(h + \lambda h) = \bar{v}(g) + \lambda \bar{v}(h);$
- (2) $\forall g, h \in \mathcal{X}_p, \bar{v}(gh) = \bar{v}(g)h(p) + g(p)\bar{v}(h).$

Let $\gamma : (-\epsilon, \epsilon) \rightarrow \widetilde{M}$ be a smooth curve on \widetilde{M} and $p = \gamma(0)$. Then for $\forall f \in \mathcal{X}_p$, we usually define a mapping $\bar{v} : \mathcal{X}_p \rightarrow \mathbf{R}$ by

$$\bar{v}(f) = \left. \frac{df(\gamma(t))}{dt} \right|_{t=0}.$$

We can easily verify such mappings \bar{v} are tangent vectors at p .

Denoted all tangent vectors at $p \in \widetilde{M}(n_1, n_2, \dots, n_m)$ by $T_p \widetilde{M}(n_1, n_2, \dots, n_m)$ and define addition “+” and scalar multiplication “ \cdot ” for $\forall \bar{u}, \bar{v} \in T_p \widetilde{M}(n_1, n_2, \dots, n_m)$, $\lambda \in \mathbf{R}$ and $f \in \mathcal{X}_p$ by

$$(\bar{u} + \bar{v})(f) = \bar{u}(f) + \bar{v}(f), \quad (\lambda \bar{u})(f) = \lambda \cdot \bar{u}(f).$$

Then it can be shown immediately that $T_p \widetilde{M}(n_1, n_2, \dots, n_m)$ is a vector space under these two operations “+” and “ \cdot ”. Let

$$\mathcal{X}(\widetilde{M}(n_1, n_2, \dots, n_m)) = \bigcup_{p \in \widetilde{M}} T_p \widetilde{M}(n_1, n_2, \dots, n_m).$$

A vector field on $\widetilde{M}(n_1, n_2, \dots, n_m)$ is a mapping $X : \widetilde{M} \rightarrow \mathcal{X}(\widetilde{M}(n_1, n_2, \dots, n_m))$, i.e., chosen a vector at each point $p \in \widetilde{M}(n_1, n_2, \dots, n_m)$.

Definition 5.1.4 For $X, Y \in \mathcal{X}(\widetilde{M}(n_1, n_2, \dots, n_m))$, the bracket operation $[X, Y] : \mathcal{X}(\widetilde{M}(n_1, n_2, \dots, n_m)) \rightarrow \mathcal{X}(\widetilde{M}(n_1, n_2, \dots, n_m))$ is defined by

$$[X, Y](f) = X(Y(f)) - Y(X(f)) \text{ for } \forall f \in \mathcal{X}_p \text{ and } p \in \widetilde{M}.$$

The existence and uniqueness of the bracket operation on $\mathcal{X}(\widetilde{M}(n_1, n_2, \dots, n_m))$ can be found similar to the case of manifolds, for examples [AbM1] and [Wes1]. The next result is immediately established by definition.

Theorem 5.1.2 Let $\widetilde{M}(n_1, n_2, \dots, n_m)$ be a smoothly combinatorial manifold. Then,

for $X, Y, Z \in \mathcal{X}(\widetilde{M}(n_1, n_2, \dots, n_m))$,

- (i) $[X, Y] = -[Y, X]$;
- (ii) the Jacobi identity

$$[X, [Y, Z]] + [Y, [Z, X]] + [Z, [X, Y]] = 0$$

holds. Such systems are called Lie algebras.

For $\forall p \in \widetilde{M}(n_1, n_2, \dots, n_m)$, We determine the dimension and basis of the tangent space $T_p\widetilde{M}(n_1, n_2, \dots, n_m)$ in the next result.

Theorem 5.1.3 For any point $p \in \widetilde{M}(n_1, n_2, \dots, n_m)$ with a local chart $(U_p; [\varphi_p])$, the dimension of $T_p\widetilde{M}(n_1, n_2, \dots, n_m)$ is

$$\dim T_p\widetilde{M}(n_1, n_2, \dots, n_m) = \widehat{s}(p) + \sum_{i=1}^{s(p)} (n_i - \widehat{s}(p))$$

with a basis matrix

$$\left[\frac{\partial}{\partial x} \right]_{s(p) \times n_{s(p)}} = \begin{bmatrix} \frac{1}{s(p)} \frac{\partial}{\partial x^{11}} & \dots & \frac{1}{s(p)} \frac{\partial}{\partial x^{1s(p)}} & \frac{\partial}{\partial x^{1(\widehat{s}(p)+1)}} & \dots & \frac{\partial}{\partial x^{1n_1}} & \dots & 0 \\ \frac{1}{s(p)} \frac{\partial}{\partial x^{21}} & \dots & \frac{1}{s(p)} \frac{\partial}{\partial x^{2s(p)}} & \frac{\partial}{\partial x^{2(\widehat{s}(p)+1)}} & \dots & \frac{\partial}{\partial x^{2n_2}} & \dots & 0 \\ \dots & \dots & \dots & \dots & \dots & \dots & \dots & \dots \\ \frac{1}{s(p)} \frac{\partial}{\partial x^{s(p)1}} & \dots & \frac{1}{s(p)} \frac{\partial}{\partial x^{s(p)s(p)}} & \frac{\partial}{\partial x^{s(p)(\widehat{s}(p)+1)}} & \dots & \dots & \frac{\partial}{\partial x^{s(p)(n_{s(p)}-1)}} & \frac{\partial}{\partial x^{s(p)n_{s(p)}}} \end{bmatrix}$$

where $x^{il} = x^{jl}$ for $1 \leq i, j \leq s(p), 1 \leq l \leq \widehat{s}(p)$, namely there is a smoothly functional matrix $[v_{ij}]_{s(p) \times n_{s(p)}}$ such that for any tangent vector \bar{v} at a point p of $\widetilde{M}(n_1, n_2, \dots, n_m)$,

$$\bar{v} = \left\langle [v_{ij}]_{s(p) \times n_{s(p)}}, \left[\frac{\partial}{\partial x} \right]_{s(p) \times n_{s(p)}} \right\rangle,$$

where $\langle [a_{ij}]_{k \times l}, [b_{ts}]_{k \times l} \rangle = \sum_{i=1}^k \sum_{j=1}^l a_{ij} b_{ij}$, the inner product on matrixes.

Proof For $\forall f \in \mathcal{X}_p$, let $\tilde{f} = f \cdot [\varphi_p]^{-1} \in \mathcal{X}_{[\varphi_p](p)}$. We only need to prove that f can be spanned by elements in

$$\left\{ \frac{\partial}{\partial x^{hj}} \Big|_p \mid 1 \leq j \leq \widehat{s}(p) \right\} \cup \left(\bigcup_{i=1}^{s(p)} \bigcup_{j=\widehat{s}(p)+1}^{n_i} \left\{ \frac{\partial}{\partial x^{ij}} \Big|_p \mid 1 \leq j \leq s \right\} \right), \quad (5-1)$$

for a given integer $h, 1 \leq h \leq s(p)$, namely (5-1) is a basis of $T_p \widetilde{M}(n_1, n_2, \dots, n_m)$. In fact, for $\forall \bar{x} \in [\varphi_p](U_p)$, since \tilde{f} is smooth, we know that

$$\begin{aligned} \tilde{f}(\bar{x}) - \tilde{f}(\bar{x}_0) &= \int_0^1 \frac{d}{dt} \tilde{f}(\bar{x}_0 + t(\bar{x} - \bar{x}_0)) dt \\ &= \sum_{i=1}^{s(p)} \sum_{j=1}^{n_i} \eta_{\widehat{s}(p)}^j(x^{ij} - x_0^{ij}) \int_0^1 \frac{\partial \tilde{f}}{\partial x^{ij}}(\bar{x}_0 + t(\bar{x} - \bar{x}_0)) dt \end{aligned}$$

in a spherical neighborhood of the point p in $[\varphi_p](U_p) \subset \mathbf{R}^{\widehat{s}(p)-s(p)\widehat{s}(p)+n_1+n_2+\dots+n_{s(p)}}$ with $[\varphi_p](p) = \bar{x}_0$, where

$$\eta_{\widehat{s}(p)}^j = \begin{cases} \frac{1}{\widehat{s}(p)}, & \text{if } 1 \leq j \leq \widehat{s}(p), \\ 1, & \text{otherwise.} \end{cases}$$

Define

$$\tilde{g}_{ij}(\bar{x}) = \int_0^1 \frac{\partial \tilde{f}}{\partial x^{ij}}(\bar{x}_0 + t(\bar{x} - \bar{x}_0)) dt$$

and $g_{ij} = \tilde{g}_{ij} \cdot [\varphi_p]$. Then we find that

$$\begin{aligned} g_{ij}(p) = \tilde{g}_{ij}(\bar{x}_0) &= \frac{\partial \tilde{f}}{\partial x^{ij}}(\bar{x}_0) \\ &= \frac{\partial (f \cdot [\varphi_p]^{-1})}{\partial x^{ij}}([\varphi_p](p)) = \frac{\partial f}{\partial x^{ij}}(p). \end{aligned}$$

Therefore, for $\forall q \in U_p$, there are $g_{ij}, 1 \leq i \leq s(p), 1 \leq j \leq n_i$ such that

$$f(q) = f(p) + \sum_{i=1}^{s(p)} \sum_{j=1}^{n_i} \eta_{\widehat{s}(p)}^j(x^{ij} - x_0^{ij}) g_{ij}(p).$$

Now let $\bar{v} \in T_p \widetilde{M}(n_1, n_2, \dots, n_m)$. Application of the condition (2) in Definition 5.1.1 shows that

$$v(f(p)) = 0, \quad \text{and} \quad v(\eta_{\widehat{s}(p)}^j x_0^{ij}) = 0.$$

Accordingly, we obtain that

$$\begin{aligned} \bar{v}(f) &= \bar{v}(f(p)) + \sum_{i=1}^{s(p)} \sum_{j=1}^{n_i} \eta_{\widehat{s}(p)}^j (x^{ij} - x_0^{ij}) g_{ij}(p) \\ &= \bar{v}(f(p)) + \sum_{i=1}^{s(p)} \sum_{j=1}^{n_i} \bar{v}(\eta_{\widehat{s}(p)}^j (x^{ij} - x_0^{ij}) g_{ij}(p)) \\ &= \sum_{i=1}^{s(p)} \sum_{j=1}^{n_i} (\eta_{\widehat{s}(p)}^j g_{ij}(p) \bar{v}(x^{ij} - x_0^{ij}) + (x^{ij}(p) - x_0^{ij}) \bar{v}(\eta_{\widehat{s}(p)}^j g_{ij}(p))) \\ &= \sum_{i=1}^{s(p)} \sum_{j=1}^{n_i} \eta_{\widehat{s}(p)}^j \frac{\partial f}{\partial x^{ij}}(p) \bar{v}(x^{ij}) \\ &= \sum_{i=1}^{s(p)} \sum_{j=1}^{n_i} \bar{v}(x^{ij}) \eta_{\widehat{s}(p)}^j \frac{\partial}{\partial x^{ij}}|_p(f) = \left\langle [v_{ij}]_{s(p) \times n_{s(p)}}, \left[\frac{\partial}{\partial \bar{x}} \right]_{s(p) \times n_{s(p)}} \right\rangle|_p(f). \end{aligned}$$

Therefore, we get that

$$\bar{v} = \left\langle [v_{ij}]_{s(p) \times n_{s(p)}}, \left[\frac{\partial}{\partial \bar{x}} \right]_{s(p) \times n_{s(p)}} \right\rangle. \quad (5-2)$$

The formula (5-2) shows that any tangent vector \bar{v} in $T_p \widetilde{M}(n_1, n_2, \dots, n_m)$ can be spanned by elements in (5.1).

Notice that all elements in (5-1) are also linearly independent. Otherwise, if there are numbers $a^{ij}, 1 \leq i \leq s(p), 1 \leq j \leq n_i$ such that

$$\left(\sum_{j=1}^{\widehat{s}(p)} a^{hj} \frac{\partial}{\partial x^{hj}} + \sum_{i=1}^{s(p)} \sum_{j=\widehat{s}(p)+1}^{n_i} a^{ij} \frac{\partial}{\partial x^{ij}} \right)|_p = 0,$$

then we get that

$$a^{ij} = \left(\sum_{j=1}^{\widehat{s}(p)} a^{hj} \frac{\partial}{\partial x^{hj}} + \sum_{i=1}^{s(p)} \sum_{j=\widehat{s}(p)+1}^{n_i} a^{ij} \frac{\partial}{\partial x^{ij}} \right)(x^{ij}) = 0$$

for $1 \leq i \leq s(p), 1 \leq j \leq n_i$. Therefore, (5-1) is a basis of the tangent vector space $T_p \widetilde{M}(n_1, n_2, \dots, n_m)$ at the point $p \in (\widetilde{M}(n_1, n_2, \dots, n_m); \widetilde{\mathcal{A}})$. \square

By Theorem 5.1.3, if $s(p) = 1$ for any point $p \in (\widetilde{M}(n_1, n_2, \dots, n_m); \widetilde{\mathcal{A}})$, then $\dim T_p \widetilde{M}(n_1, n_2, \dots, n_m) = n_1$. This can only happens while $\widetilde{M}(n_1, n_2, \dots, n_m)$ is combined by one manifold. As a consequence, we get a well-known result in classical differential geometry again.

Corollary 5.1.1 *Let $(M^n; \mathcal{A})$ be a smooth manifold and $p \in M^n$. Then*

$$\dim T_p M^n = n$$

with a basis

$$\left\{ \frac{\partial}{\partial x^i} \Big|_p \mid 1 \leq i \leq n \right\}.$$

5.1.3 Cotangent Vector Space. For a point on a smoothly combinatorial manifold, the cotangent vector space is defined in the next definition.

Definition 5.1.5 *For $\forall p \in (\widetilde{M}(n_1, n_2, \dots, n_m); \widetilde{\mathcal{A}})$, the dual space $T_p^* \widetilde{M}(n_1, n_2, \dots, n_m)$ is called a co-tangent vector space at p .*

Definition 5.1.6 *For $f \in \mathcal{X}_p, d \in T_p^* \widetilde{M}(n_1, n_2, \dots, n_m)$ and $\bar{v} \in T_p \widetilde{M}(n_1, n_2, \dots, n_m)$, the action of d on f , called a differential operator $d : \mathcal{X}_p \rightarrow \mathbf{R}$, is defined by*

$$df = \bar{v}(f).$$

Then we immediately obtain the result following.

Theorem 5.1.4 *For $\forall p \in (\widetilde{M}(n_1, n_2, \dots, n_m); \widetilde{\mathcal{A}})$ with a local chart $(U_p; [\varphi_p])$, the dimension of $T_p^* \widetilde{M}(n_1, n_2, \dots, n_m)$ is*

$$\dim T_p^* \widetilde{M}(n_1, n_2, \dots, n_m) = \widehat{s}(p) + \sum_{i=1}^{s(p)} (n_i - \widehat{s}(p))$$

with a basis matrix

$$[d\bar{x}]_{s(p) \times n_{s(p)}} = \begin{bmatrix} \frac{dx^{11}}{s(p)} & \dots & \frac{dx^{1\widehat{s}(p)}}{s(p)} & dx^{1(\widehat{s}(p)+1)} & \dots & dx^{1n_1} & \dots & 0 \\ \frac{dx^{21}}{s(p)} & \dots & \frac{dx^{2\widehat{s}(p)}}{s(p)} & dx^{2(\widehat{s}(p)+1)} & \dots & dx^{2n_2} & \dots & 0 \\ \dots & \dots & \dots & \dots & \dots & \dots & \dots & \dots \\ \frac{dx^{s(p)1}}{s(p)} & \dots & \frac{dx^{s(p)\widehat{s}(p)}}{s(p)} & dx^{s(p)(\widehat{s}(p)+1)} & \dots & \dots & dx^{s(p)n_{s(p)}-1} & dx^{s(p)n_{s(p)}} \end{bmatrix}$$

where $x^{il} = x^{jl}$ for $1 \leq i, j \leq s(p), 1 \leq l \leq \widehat{s}(p)$, namely for any co-tangent vector d at a point p of $\widetilde{M}(n_1, n_2, \dots, n_m)$, there is a smoothly functional matrix $[u_{ij}]_{s(p) \times s(p)}$ such that,

$$d = \left\langle [u_{ij}]_{s(p) \times s(p)}, [d\overline{x}]_{s(p) \times n_{s(p)}} \right\rangle. \quad \square$$

§5.2 TENSOR FIELDS ON COMBINATORIAL MANIFOLDS

5.2.1 Tensor on Combinatorial Manifold. For any integers $r, s \geq 1$, a tensor of type (r, s) at a point in a smoothly combinatorial manifold $\widetilde{M}(n_1, n_2, \dots, n_m)$ is defined following.

Definition 5.2.1 Let $\widetilde{M}(n_1, n_2, \dots, n_m)$ be a smoothly combinatorial manifold and $p \in \widetilde{M}(n_1, n_2, \dots, n_m)$. A tensor of type (r, s) at the point p on $\widetilde{M}(n_1, n_2, \dots, n_m)$ is an $(r + s)$ -multilinear function τ ,

$$\tau : \underbrace{T_p^* \widetilde{M} \times \dots \times T_p^* \widetilde{M}}_r \times \underbrace{T_p \widetilde{M} \times \dots \times T_p \widetilde{M}}_s \rightarrow \mathbf{R},$$

where $T_p \widetilde{M} = T_p \widetilde{M}(n_1, n_2, \dots, n_m)$ and $T_p^* \widetilde{M} = T_p^* \widetilde{M}(n_1, n_2, \dots, n_m)$.

Denoted by $T_s^r(p, \widetilde{M})$ all tensors of type (r, s) at a point p of $\widetilde{M}(n_1, n_2, \dots, n_m)$. Then we know its structure by Theorems 5.1.3 and 5.1.4.

Theorem 5.2.1 Let $\widetilde{M}(n_1, n_2, \dots, n_m)$ be a smoothly combinatorial manifold and $p \in \widetilde{M}(n_1, n_2, \dots, n_m)$. Then

$$T_s^r(p, \widetilde{M}) = \underbrace{T_p \widetilde{M} \otimes \dots \otimes T_p \widetilde{M}}_r \otimes \underbrace{T_p^* \widetilde{M} \otimes \dots \otimes T_p^* \widetilde{M}}_s,$$

where $T_p \widetilde{M} = T_p \widetilde{M}(n_1, n_2, \dots, n_m)$ and $T_p^* \widetilde{M} = T_p^* \widetilde{M}(n_1, n_2, \dots, n_m)$, particularly,

$$\dim T_s^r(p, \widetilde{M}) = (\widehat{s}(p) + \sum_{i=1}^{s(p)} (n_i - \widehat{s}(p)))^{r+s}.$$

Proof By definition and multilinear algebra, any tensor t of type (r, s) at the point p can be uniquely written as

$$t = \sum t_{j_1 \dots j_s}^{i_1 \dots i_r} \frac{\partial}{\partial x^{i_1 j_1}}|_p \otimes \dots \otimes \frac{\partial}{\partial x^{i_r j_r}}|_p \otimes dx^{k_1 l_1} \otimes \dots \otimes dx^{k_s l_s}$$

for components $t_{j_1 \dots j_s}^{i_1 \dots i_r} \in \mathbf{R}$ by Theorems 5.1.3 and 5.1.4, where $1 \leq i_h, k_h \leq s(p)$ and $1 \leq j_h \leq i_h, 1 \leq l_h \leq k_h$ for $1 \leq h \leq r$. As a consequence, we obtain that

$$T_s^r(p, \widetilde{M}) = \underbrace{T_p \widetilde{M} \otimes \dots \otimes T_p \widetilde{M}}_r \otimes \underbrace{T_p^* \widetilde{M} \otimes \dots \otimes T_p^* \widetilde{M}}_s.$$

Since $\dim T_p \widetilde{M} = \dim T_p^* \widetilde{M} = \widehat{s}(p) + \sum_{i=1}^{s(p)} (n_i - \widehat{s}(p))$ by Theorems 5.1.3 and 5.1.4, we also know that

$$\dim T_s^r(p, \widetilde{M}) = (\widehat{s}(p) + \sum_{i=1}^{s(p)} (n_i - \widehat{s}(p)))^{r+s}.$$

□

5.2.2 Tensor Field on Combinatorial Manifold. Similar to manifolds, we can also introduce tensor field and k -forms at a point in a combinatorial manifold following.

Definition 5.2.2 Let $T_s^r(\widetilde{M}) = \bigcup_{p \in \widetilde{M}} T_s^r(p, \widetilde{M})$ for a smoothly combinatorial manifold $\widetilde{M} = \widetilde{M}(n_1, n_2, \dots, n_m)$. A tensor field of type (r, s) on $\widetilde{M}(n_1, n_2, \dots, n_m)$ is a mapping $\tau : \widetilde{M}(n_1, n_2, \dots, n_m) \rightarrow T_s^r(\widetilde{M})$ such that $\tau(p) \in T_s^r(p, \widetilde{M})$ for $\forall p \in \widetilde{M}(n_1, n_2, \dots, n_m)$.

A k -form on $\widetilde{M}(n_1, n_2, \dots, n_m)$ is a tensor field $\omega \in T_k^0(\widetilde{M})$. Denoted all k -form of $\widetilde{M}(n_1, n_2, \dots, n_m)$ by $\Lambda^k(\widetilde{M})$ and

$$\Lambda(\widetilde{M}) = \bigoplus_{k=0}^{\widehat{s}(p) - s(p)\widehat{s}(p) + \sum_{i=1}^{s(p)} n_i} \Lambda^k(\widetilde{M}).$$

We have introduced the wedge \wedge on differential forms in \mathbf{R}^n in Section 3.2.4. Certainly, for $\omega \in \Lambda^k(\widetilde{M}), \varpi \in \Lambda^l(\widetilde{M})$ and integers $k, l \geq 0$, we can also define the wedge operation $\omega \wedge \varpi$ in $\Lambda(\widetilde{M})$ following.

Definition 5.2.2 For any integer $k \geq 0$ and $\omega \in \Lambda^k(\widetilde{M})$, an alternation mapping $\mathbf{A} : \Lambda^k(\widetilde{M}) \rightarrow \Lambda^k(\widetilde{M})$ is defined by

$$\mathbf{A}\omega(\bar{u}_1, \dots, \bar{u}_k) = \frac{1}{k!} \sum_{\sigma \in S_k} \text{sign}\sigma \omega(\bar{u}_{\sigma(1)}, \dots, \bar{u}_{\sigma(k)})$$

for $\forall \bar{u}_1 \in \widetilde{M}$, and for integers $k, l \geq 0$ and $\omega \in \Lambda^k(\widetilde{M})$, $\varpi \in \Lambda^l(\widetilde{M})$, their wedge $\omega \wedge \varpi \in \Lambda^{k+l}(\widetilde{M})$ is defined by

$$\omega \wedge \varpi = \frac{(k+l)!}{k!l!} \mathbf{A}(\omega \otimes \varpi).$$

For example, if $\widetilde{M} = \mathbf{R}^3$, \mathbf{a} is a 1-form and \mathbf{b} a 1-form, then

$$\mathbf{a} \wedge \mathbf{b}(\bar{\mathbf{e}}_1, \bar{\mathbf{e}}_2) = \mathbf{a}(\bar{\mathbf{e}}_1)\mathbf{b}(\bar{\mathbf{e}}_2) - \mathbf{a}(\bar{\mathbf{e}}_2)\mathbf{b}(\bar{\mathbf{e}}_1)$$

and if \mathbf{a} is a 2-form and \mathbf{b} a 1-form, then

$$\mathbf{a} \wedge \mathbf{b}(\bar{\mathbf{e}}_1, \bar{\mathbf{e}}_2, \bar{\mathbf{e}}_3) = \mathbf{a}(\bar{\mathbf{e}}_1, \bar{\mathbf{e}}_2)\mathbf{b}(\bar{\mathbf{e}}_3) - \mathbf{a}(\bar{\mathbf{e}}_1, \bar{\mathbf{e}}_3)\mathbf{b}(\bar{\mathbf{e}}_2) + \mathbf{a}(\bar{\mathbf{e}}_2, \bar{\mathbf{e}}_3)\mathbf{b}(\bar{\mathbf{e}}_1).$$

Example 5.2.1 The wedge product is operated in $\Lambda(\widetilde{M})$ in the same way as in the algebraic case. For example, let $\mathbf{a} = dx_1 - x_1dx_2 \in \Lambda^1(\widetilde{M})$ and $\mathbf{b} = x_2dx_1 \wedge dx_3 - dx_2 \wedge dx_1 \in \Lambda^2(\widetilde{M})$, then

$$\begin{aligned} \mathbf{a} \wedge \mathbf{b} &= (dx_1 - x_1dx_2) \wedge (x_2dx_1 \wedge dx_3 - dx_2 \wedge dx_1) \\ &= 0 - x_1x_2dx_2 \wedge dx_1 \wedge dx_3 - dx_1 \wedge dx_2 \wedge dx_3 + 0 \\ &= (x_1x_2 - 1) \wedge dx_3 - dx_1 \wedge dx_2 \wedge dx_3. \end{aligned}$$

Theorem 5.2.2 Let $\bar{v}_1, \bar{v}_2, \dots, \bar{v}_n$ be vectors in a vector space \mathcal{V} . Then they are linear dependent if and only if

$$\bar{v}_1 \wedge \bar{v}_2 \wedge \dots \wedge \bar{v}_n = 0.$$

Proof If $\bar{v}_1, \bar{v}_2, \dots, \bar{v}_n$ are linear dependent, without loss of generality, let

$$\bar{v}_n = a_1\bar{v}_1 + a_2\bar{v}_2 \dots + a_{n-1}\bar{v}_{n-1}.$$

Then

$$\begin{aligned}
& \bar{v}_1 \wedge \bar{v}_2 \wedge \cdots \wedge \bar{v}_n \\
& \bar{v}_1 \wedge \cdots \wedge \bar{v}_{n-1} \wedge (a_1 \bar{v}_1 + a_2 \bar{v}_2 \cdots + a_{n-1} \bar{v}_{n-1}) \\
& = 0.
\end{aligned}$$

Now if $\bar{v}_1, \bar{v}_2, \dots, \bar{v}_n$ are linear independent, we can extend them to a basis $\{\bar{v}_1, \bar{v}_2, \dots, \bar{v}_n, \dots, \bar{v}_{\dim \mathcal{V}}\}$ of \mathcal{V} . Because of

$$\bar{v}_1 \wedge \bar{v}_2 \wedge \cdots \wedge \bar{v}_{\dim \mathcal{V}} \neq 0,$$

we finally get that

$$\bar{v}_1 \wedge \bar{v}_2 \wedge \cdots \wedge \bar{v}_n \neq 0.$$

□

Theorem 5.2.3 *Let $\bar{v}_1, \bar{v}_2, \dots, \bar{v}_n$ and $\bar{w}_1, \bar{w}_2, \dots, \bar{w}_n$ be two vector families in a vector space \mathcal{V} such that*

$$\sum_{k=1}^n \bar{v}_k \wedge \bar{w}_k = 0.$$

If $\bar{v}_1, \bar{v}_2, \dots, \bar{v}_n$ are linear independent, then for any integer $k, 1 \leq k \leq n$,

$$\bar{w}_k = \sum_{l=1}^n a_{kl} \bar{v}_l$$

with $a_{kl} = a_{lk}$.

Proof Because $\bar{v}_1, \bar{v}_2, \dots, \bar{v}_n$ are linear independent, we can extend them to a basis $\{\bar{v}_1, \bar{v}_2, \dots, \bar{v}_n, \dots, \bar{v}_{\dim \mathcal{V}}\}$ of \mathcal{V} . Therefore, there are scalars $a_{kl}, 1 \leq k, l \leq \dim \mathcal{V}$ such that

$$\bar{w}_k = \sum_{l=1}^n a_{kl} \bar{v}_l + \sum_{l=k+1}^{\dim \mathcal{V}} a_{kl} \bar{v}_l.$$

Whence, we find that

$$\sum_{k=1}^n \bar{v}_k \wedge \bar{w}_k = \sum_{k,l=1}^n a_{kl} \bar{v}_k \wedge \bar{v}_l + \sum_{k=1}^n \sum_{l=k+1}^{\dim \mathcal{V}} a_{kl} \bar{v}_k \wedge \bar{v}_l$$

$$= \sum_{1 \leq k < l \leq n} (a_{kl} - a_{lk}) \bar{v}_k \wedge \bar{v}_l + \sum_{k=1}^n \sum_{t=k+1}^{\dim \mathcal{V}} a_{kt} \bar{v}_k \wedge \bar{v}_t = 0$$

by assumption. Since $\{\bar{v}_k \wedge \bar{v}_l, 1 \leq k < l \leq \dim \mathcal{V}\}$ is a basis $\Lambda^2(\mathcal{V})$, we know that $a_{kl} - a_{lk} = 0$ and $a_{kt} = 0$. Thereafter, we get that

$$\bar{w}_k = \sum_{l=1}^n a_{kl} \bar{v}_l$$

with $a_{kl} = a_{lk}$. □

5.2.3 Exterior Differentiation. It is the same as in the classical differential geometry, the next result determines a unique exterior differentiation $\tilde{d} : \Lambda(\tilde{M}) \rightarrow \Lambda(\tilde{M})$ for smoothly combinatorial manifolds.

Theorem 5.2.4 *Let \tilde{M} be a smoothly combinatorial manifold. Then there is a unique exterior differentiation $\tilde{d} : \Lambda(\tilde{M}) \rightarrow \Lambda(\tilde{M})$ such that for any integer $k \geq 1$, $\tilde{d}(\Lambda^k) \subset \Lambda^{k+1}(\tilde{M})$ with conditions following hold.*

(1) \tilde{d} is linear, i.e., for $\forall \varphi, \psi \in \Lambda(\tilde{M}), \lambda \in \mathbf{R}$,

$$\tilde{d}(\varphi + \lambda\psi) = \tilde{d}\varphi \wedge \psi + \lambda\tilde{d}\psi$$

and for $\varphi \in \Lambda^k(\tilde{M}), \psi \in \Lambda(\tilde{M})$,

$$\tilde{d}(\varphi \wedge \psi) = \tilde{d}\varphi \wedge \psi + (-1)^k \varphi \wedge \tilde{d}\psi.$$

(2) For $f \in \Lambda^0(\tilde{M})$, $\tilde{d}f$ is the differentiation of f .

(3) $\tilde{d}^2 = \tilde{d} \cdot \tilde{d} = 0$.

(4) \tilde{d} is a local operator, i.e., if $U \subset V \subset \tilde{M}$ are open sets and $\alpha \in \Lambda^k(V)$, then $\tilde{d}(\alpha|_U) = (\tilde{d}\alpha)|_U$.

Proof Let $(U; [\varphi])$, where $[\varphi] : p \rightarrow \bigcup_{i=1}^{s(p)} [\varphi](p) = [\varphi(p)]$ be a local chart for a point $p \in \tilde{M}$ and $\alpha = \alpha_{(\mu_1 \nu_1) \dots (\mu_k \nu_k)} dx^{\mu_1 \nu_1} \wedge \dots \wedge dx^{\mu_k \nu_k}$ with $1 \leq \nu_j \leq n_{\mu_i}$ for $1 \leq \mu_i \leq s(p), 1 \leq i \leq k$. We first establish the uniqueness. If $k = 0$, the local formula $\tilde{d}\alpha = \frac{\partial \alpha}{\partial x^{\mu\nu}} dx^{\mu\nu}$ applied to the coordinates $x^{\mu\nu}$ with $1 \leq \nu_j \leq n_{\mu_i}$ for $1 \leq \mu_i \leq s(p), 1 \leq i \leq k$ shows that the differential of $x^{\mu\nu}$ is 1-form $dx^{\mu\nu}$. From (3), $\tilde{d}(x^{\mu\nu}) = 0$, which combining with (1) shows that $\tilde{d}(dx^{\mu_1 \nu_1} \wedge \dots \wedge dx^{\mu_k \nu_k}) = 0$. This, again by (1),

$$\tilde{d}\alpha = \frac{\partial\alpha_{(\mu_1\nu_1)\dots(\mu_k\psi_k)}}{\partial x^{\mu\nu}} dx^{\mu\nu} \wedge dx^{\mu_1\nu_1} \wedge \dots \wedge dx^{\mu_k\nu_k}. \quad (5-3)$$

and \tilde{d} is uniquely determined on U by properties (1) – (3) and by (4) on any open subset of \tilde{M} .

For existence, define on every local chart $(U; [\varphi])$ the operator \tilde{d} by (5-3). Then (2) is trivially verified as is \mathbf{R} -linearity. If $\beta = \beta_{(\sigma_1\varsigma_1)\dots(\sigma_l\varsigma_l)} dx^{\sigma_1\varsigma_1} \wedge \dots \wedge dx^{\sigma_l\varsigma_l} \in \Lambda^l(U)$, then

$$\begin{aligned} \tilde{d}(\alpha \wedge \beta) &= \tilde{d}(\alpha_{(\mu_1\nu_1)\dots(\mu_k\psi_k)}\beta_{(\sigma_1\varsigma_1)\dots(\sigma_l\varsigma_l)} dx^{\mu_1\nu_1} \wedge \dots \wedge dx^{\mu_k\nu_k} \wedge dx^{\sigma_1\varsigma_1} \wedge \dots \wedge dx^{\sigma_l\varsigma_l}) \\ &= \left(\frac{\partial\alpha_{(\mu_1\nu_1)\dots(\mu_k\psi_k)}}{\partial x^{\mu\nu}} \beta_{(\sigma_1\varsigma_1)\dots(\sigma_l\varsigma_l)} + \alpha_{(\mu_1\nu_1)\dots(\mu_k\psi_k)} \right) \\ &\quad \times \frac{\partial\beta_{(\sigma_1\varsigma_1)\dots(\sigma_l\varsigma_l)}}{\partial x^{\mu\nu}} dx^{\mu_1\nu_1} \wedge \dots \wedge dx^{\mu_k\nu_k} \wedge dx^{\sigma_1\varsigma_1} \wedge \dots \wedge dx^{\sigma_l\varsigma_l} \\ &= \frac{\partial\alpha_{(\mu_1\nu_1)\dots(\mu_k\psi_k)}}{\partial x^{\mu\nu}} dx^{\mu_1\nu_1} \wedge \dots \wedge dx^{\mu_k\nu_k} \wedge \beta_{(\sigma_1\varsigma_1)\dots(\sigma_l\varsigma_l)} dx^{\sigma_1\varsigma_1} \wedge \dots \wedge dx^{\sigma_l\varsigma_l} \\ &\quad + (-1)^k \alpha_{(\mu_1\nu_1)\dots(\mu_k\psi_k)} dx^{\mu_1\nu_1} \wedge \dots \wedge dx^{\mu_k\nu_k} \wedge \frac{\partial\beta_{(\sigma_1\varsigma_1)\dots(\sigma_l\varsigma_l)}}{\partial x^{\mu\nu}} dx^{\sigma_1\varsigma_1} \wedge \dots \wedge dx^{\sigma_l\varsigma_l} \\ &= \tilde{d}\alpha \wedge \beta + (-1)^k \alpha \wedge \tilde{d}\beta \end{aligned}$$

and (1) is verified. For (3), symmetry of the second partial derivatives shows that

$$\tilde{d}(\tilde{d}\alpha) = \frac{\partial^2\alpha_{(\mu_1\nu_1)\dots(\mu_k\psi_k)}}{\partial x^{\mu\nu}\partial x^{\sigma\varsigma}} dx^{\mu_1\nu_1} \wedge \dots \wedge dx^{\mu_k\nu_k} \wedge dx^{\sigma_1\varsigma_1} \wedge \dots \wedge dx^{\sigma_l\varsigma_l} = 0.$$

Thus, in every local chart $(U; [\varphi])$, (5-3) defines an operator \tilde{d} satisfying (1)-(3). It remains to be shown that \tilde{d} really defines an operator \tilde{d} on any open set and (4) holds. To do so, it suffices to show that this definition is chart independent. Let \tilde{d}' be the operator given by (5-3) on a local chart $(U'; [\varphi'])$, where $U \cap U' \neq \emptyset$. Since \tilde{d}' also satisfies (1) – (3) and the local uniqueness has already been proved, $\tilde{d}'\alpha = \tilde{d}\alpha$ on $U \cap U'$. Whence, (4) thus follows. \square

Corollary 5.2.1 *Let $\tilde{M} = \tilde{M}(n_1, n_2, \dots, n_m)$ be a smoothly combinatorial manifold and $d_M : \Lambda^k(M) \rightarrow \Lambda^{k+1}(M)$ the unique exterior differentiation on M with conditions following hold for $M \in V(G^l[\tilde{M}(n_1, n_2, \dots, n_m)])$ where, $1 \leq l \leq \min\{n_1, n_2, \dots, n_m\}$.*

(1) d_M is linear, i.e., for $\forall\varphi, \psi \in \Lambda(M)$, $\lambda \in \mathbf{R}$,

$$d_M(\varphi + \lambda\psi) = d_M\varphi + \lambda d_M\psi.$$

(2) For $\varphi \in \Lambda^r(M), \psi \in \Lambda(M)$,

$$d_M(\varphi \wedge \psi) = d_M\varphi + (-1)^r\varphi \wedge d_M\psi.$$

(3) For $f \in \Lambda^0(M)$, $d_M f$ is the differentiation of f .

(4) $d_M^2 = d_M \cdot d_M = 0$.

Then

$$\tilde{d}|_M = d_M.$$

Proof By Theorem 2.4.5 in [AbM1], d_M exists uniquely for any smoothly manifold M . Now since \tilde{d} is a local operator on \tilde{M} , i.e., for any open subset $U_\mu \subset \tilde{M}$, $\tilde{d}(\alpha|_{U_\mu}) = (\tilde{d}\alpha)|_{U_\mu}$ and there is an index set J such that $M = \bigcup_{\mu \in J} U_\mu$, we finally get that

$$\tilde{d}|_M = d_M$$

by the uniqueness of \tilde{d} and d_M . □

Theorem 5.2.5 Let $\omega \in \Lambda^1(\tilde{M})$. Then for $\forall X, Y \in \mathcal{X}(\tilde{M})$,

$$\tilde{d}\omega(X, Y) = X(\omega(Y)) - Y(\omega(X)) - \omega([X, Y]).$$

Proof Denote by $\alpha(X, Y)$ the right hand side of the formula. We know that $\alpha : \tilde{M} \times \tilde{M} \rightarrow C^\infty(\tilde{M})$. It can be checked immediately that α is bilinear and for $\forall X, Y \in \mathcal{X}(\tilde{M}), f \in C^\infty(\tilde{M})$,

$$\begin{aligned} \alpha(fX, Y) &= fX(\omega(Y)) - Y(\omega(fX)) - \omega([fX, Y]) \\ &= fX(\omega(Y)) - Y(f\omega(X)) - \omega(f[X, Y] - Y(f)X) \\ &= f\alpha(X, Y) \end{aligned}$$

and

$$\alpha(X, fY) = -\alpha(fY, X) = -f\alpha(Y, X) = f\alpha(X, Y)$$

by definition. Accordingly, α is a differential 2-form. We only need to prove that for a local chart $(U, [\varphi])$,

$$\alpha|_U = \tilde{d}\omega|_U.$$

In fact, assume $\omega|_U = \omega_{\mu\nu}dx^{\mu\nu}$. Then

$$\begin{aligned} (\tilde{d}\omega)|_U = \tilde{d}(\omega|_U) &= \frac{\partial\omega_{\mu\nu}}{\partial x^{\sigma\varsigma}}dx^{\sigma\varsigma} \wedge dx^{\mu\nu} \\ &= \frac{1}{2}\left(\frac{\partial\omega_{\mu\nu}}{\partial x^{\sigma\varsigma}} - \frac{\partial\omega_{\varsigma\tau}}{\partial x^{\mu\nu}}\right)dx^{\sigma\varsigma} \wedge dx^{\mu\nu}. \end{aligned}$$

On the other hand, $\alpha|_U = \frac{1}{2}\alpha\left(\frac{\partial}{\partial x^{\mu\nu}}, \frac{\partial}{\partial x^{\sigma\varsigma}}\right)dx^{\sigma\varsigma} \wedge dx^{\mu\nu}$, where

$$\begin{aligned} \alpha\left(\frac{\partial}{\partial x^{\mu\nu}}, \frac{\partial}{\partial x^{\sigma\varsigma}}\right) &= \frac{\partial}{\partial x^{\sigma\varsigma}}\left(\omega\left(\frac{\partial}{\partial x^{\mu\nu}}\right)\right) - \frac{\partial}{\partial x^{\mu\nu}}\left(\omega\left(\frac{\partial}{\partial x^{\sigma\varsigma}}\right)\right) \\ &\quad - \omega\left[\left(\frac{\partial}{\partial x^{\mu\nu}} - \frac{\partial}{\partial x^{\sigma\varsigma}}\right)\right] \\ &= \frac{\partial\omega_{\mu\nu}}{\partial x^{\sigma\varsigma}} - \frac{\partial\omega_{\sigma\varsigma}}{\partial x^{\mu\nu}}. \end{aligned}$$

Therefore, $\tilde{d}\omega|_U = \alpha|_U$. □

§5.3 CONNECTIONS ON TENSORS

5.3.1 Connection on Tensor. We introduce connections on tensors of smoothly combinatorial manifolds by the next definition.

Definition 5.3.1 *Let \tilde{M} be a smoothly combinatorial manifold. A connection on tensors of \tilde{M} is a mapping $\tilde{D} : \mathcal{X}(\tilde{M}) \times T_s^r\tilde{M} \rightarrow T_s^r\tilde{M}$ with $\tilde{D}_X\tau = \tilde{D}(X, \tau)$ such that for $\forall X, Y \in \mathcal{X}\tilde{M}$, $\tau, \pi \in T_s^r(\tilde{M})$, $\lambda \in \mathbf{R}$ and $f \in C^\infty(\tilde{M})$,*

- (1) $\tilde{D}_{X+fY}\tau = \tilde{D}_X\tau + f\tilde{D}_Y\tau$; and $\tilde{D}_X(\tau + \lambda\pi) = \tilde{D}_X\tau + \lambda\tilde{D}_X\pi$;
- (2) $\tilde{D}_X(\tau \otimes \pi) = \tilde{D}_X\tau \otimes \pi + \tau \otimes \tilde{D}_X\pi$;
- (3) for any contraction C on $T_s^r(\tilde{M})$,

$$\tilde{D}_X(C(\tau)) = C(\tilde{D}_X\tau).$$

We get results following for these connections on tensors of smoothly combinatorial manifolds.

Theorem 5.3.1 *Let \widetilde{M} be a smoothly combinatorial manifold. Then there exists a connection \widetilde{D} locally on \widetilde{M} with a form*

$$(\widetilde{D}_X\tau)|_U = X^{\sigma\varsigma} \tau_{(\kappa_1\lambda_1)(\kappa_2\lambda_2)\dots(\kappa_s\lambda_s),(\mu\nu)}^{(\mu_1\nu_1)(\mu_2\nu_2)\dots(\mu_r\nu_r)} \frac{\partial}{\partial x^{\mu_1\nu_1}} \otimes \dots \otimes \frac{\partial}{\partial x^{\mu_r\nu_r}} \otimes dx^{\kappa_1\lambda_1} \otimes \dots \otimes dx^{\kappa_s\lambda_s}$$

for $\forall Y \in \mathcal{X}(\widetilde{M})$ and $\tau \in T_s^r(\widetilde{M})$, where

$$\begin{aligned} \tau_{(\kappa_1\lambda_1)(\kappa_2\lambda_2)\dots(\kappa_s\lambda_s),(\mu\nu)}^{(\mu_1\nu_1)(\mu_2\nu_2)\dots(\mu_r\nu_r)} &= \frac{\partial \tau_{(\kappa_1\lambda_1)(\kappa_2\lambda_2)\dots(\kappa_s\lambda_s)}^{(\mu_1\nu_1)(\mu_2\nu_2)\dots(\mu_r\nu_r)}}{\partial x^{\mu\nu}} \\ &+ \sum_{a=1}^r \tau_{(\kappa_1\lambda_1)(\kappa_2\lambda_2)\dots(\kappa_s\lambda_s)}^{(\mu_1\nu_1)\dots(\mu_{a-1}\nu_{a-1})(\sigma\varsigma)(\mu_{a+1}\nu_{a+1})\dots(\mu_r\nu_r)} \Gamma_{(\sigma\varsigma)}^{\mu_a\nu_a}(\mu\nu) \\ &- \sum_{b=1}^s \tau_{(\kappa_1\lambda_1)\dots(\kappa_{b-1}\lambda_{b-1})(\mu\nu)(\sigma_b\nu_b)\dots(\kappa_s\lambda_s)}^{(\mu_1\nu_1)(\mu_2\nu_2)\dots(\mu_r\nu_r)} \Gamma_{(\sigma_b\nu_b)}^{\sigma\varsigma}(\mu\nu) \end{aligned}$$

and $\Gamma_{(\sigma\varsigma)}^{\kappa\lambda}(\mu\nu)$ is a function determined by

$$\widetilde{D} \frac{\partial}{\partial x^{\mu\nu}} \frac{\partial}{\partial x^{\sigma\varsigma}} = \Gamma_{(\sigma\varsigma)}^{\kappa\lambda}(\mu\nu) \frac{\partial}{\partial x^{\sigma\varsigma}}$$

on $(U_p; [\varphi_p]) = (U_p; x^{\mu\nu})$ of a point $p \in \widetilde{M}$, also called the coefficient on a connection.

Proof We first prove that any connection \widetilde{D} on smoothly combinatorial manifolds \widetilde{M} is local by definition, namely for $X_1, X_2 \in \mathcal{X}(\widetilde{M})$ and $\tau_1, \tau_2 \in T_s^r(\widetilde{M})$, if $X_1|_U = X_2|_U$ and $\tau_1|_U = \tau_2|_U$, then $(\widetilde{D}_{X_1}\tau_1)|_U = (\widetilde{D}_{X_2}\tau_2)|_U$. For this objective, we need to prove that $(\widetilde{D}_{X_1}\tau_1)|_U = (\widetilde{D}_{X_1}\tau_2)|_U$ and $(\widetilde{D}_{X_1}\tau_1)|_U = (\widetilde{D}_{X_2}\tau_1)|_U$. Since their proofs are similar, we check the first only.

In fact, if $\tau = 0$, then $\tau = \tau - \tau$. By the definition of connection,

$$\widetilde{D}_X\tau = \widetilde{D}_X(\tau - \tau) = \widetilde{D}_X\tau - \widetilde{D}_X\tau = 0.$$

Now let $p \in U$. Then there is a neighborhood V_p of p such that \overline{V} is compact and $\overline{V} \subset U$. By a result in topology, i.e., for two open sets V_p, U of $\mathbf{R}^{\widehat{s}(p)-s(p)\widehat{s}(p)+n_1+\dots+n_{s(p)}}$ with compact $\overline{V_p}$ and $\overline{V_p} \subset U$, there exists a function $f \in C^\infty(\mathbf{R}^{\widehat{s}(p)-s(p)\widehat{s}(p)+n_1+\dots+n_{s(p)}})$ such that $0 \leq f \leq 1$ and $f|_{V_p} \equiv 1, f|_{\mathbf{R}^{\widehat{s}(p)-s(p)\widehat{s}(p)+n_1+\dots+n_{s(p)}} \setminus U} \equiv 0$, we find that $f \cdot (\tau_2 - \tau_1) = 0$. Whence, we know that

$$0 = \widetilde{D}_{X_1}((f \cdot (\tau_2 - \tau_1))) = X_1(f)(\tau_2 - \tau_1) + f(\widetilde{D}_{X_1}\tau_2 - \widetilde{D}_{X_1}\tau_1).$$

As a consequence, we get that $(\tilde{D}_{X_1}\tau_1)_V = (\tilde{D}_{X_1}\tau_2)_V$, particularly, $(\tilde{D}_{X_1}\tau_1)_p = (\tilde{D}_{X_1}\tau_2)_p$. For the arbitrary choice of p , we get that $(\tilde{D}_{X_1}\tau_1)_U = (\tilde{D}_{X_1}\tau_2)_U$ finally.

The local property of \tilde{D} enables us to find an induced connection $\tilde{D}^U : \mathcal{X}(U) \times T_s^r(U) \rightarrow T_s^r(U)$ such that $\tilde{D}_{X|U}^U(\tau|_U) = (\tilde{D}_X\tau)|_U$ for $\forall X \in \mathcal{X}(\tilde{M})$ and $\tau \in T_s^r\tilde{M}$. Now for $\forall X_1, X_2 \in \mathcal{X}(\tilde{M})$, $\forall \tau_1, \tau_2 \in T_s^r(\tilde{M})$ with $X_1|_{V_p} = X_2|_{V_p}$ and $\tau_1|_{V_p} = \tau_2|_{V_p}$, define a mapping $\tilde{D}^U : \mathcal{X}(U) \times T_s^r(U) \rightarrow T_s^r(U)$ by

$$(\tilde{D}_{X_1}\tau_1)|_{V_p} = (\tilde{D}_{X_2}\tau_2)|_{V_p}$$

for any point $p \in U$. Then since \tilde{D} is a connection on \tilde{M} , it can be checked easily that \tilde{D}^U satisfies all conditions in Definition 5.3.1. Whence, \tilde{D}^U is indeed a connection on U .

Now we calculate the local form on a chart $(U_p, [\varphi_p])$ of p . Since

$$\tilde{D}_{\frac{\partial}{\partial x^{\mu\nu}}} = \Gamma_{(\sigma\varsigma)(\mu\nu)}^{\kappa\lambda} \frac{\partial}{\partial x^{\sigma\varsigma}},$$

it can find immediately that

$$\tilde{D}_{\frac{\partial}{\partial x^{\mu\nu}}} dx^{\kappa\lambda} = -\Gamma_{(\sigma\varsigma)(\mu\nu)}^{\kappa\lambda} dx^{\sigma\varsigma}$$

by Definition 5.3.1. Therefore, we finally find that

$$(\tilde{D}_X\tau)|_U = X^{\sigma\varsigma} \tau_{(\kappa_1\lambda_1)(\kappa_2\lambda_2)\cdots(\kappa_s\lambda_s),(\mu\nu)}^{(\mu_1\nu_1)(\mu_2\nu_2)\cdots(\mu_r\nu_r)} \frac{\partial}{\partial x^{\mu_1\nu_1}} \otimes \cdots \otimes \frac{\partial}{\partial x^{\mu_r\nu_r}} \otimes dx^{\kappa_1\lambda_1} \otimes \cdots \otimes dx^{\kappa_s\lambda_s}$$

with

$$\begin{aligned} \tau_{(\kappa_1\lambda_1)(\kappa_2\lambda_2)\cdots(\kappa_s\lambda_s),(\mu\nu)}^{(\mu_1\nu_1)(\mu_2\nu_2)\cdots(\mu_r\nu_r)} &= \frac{\partial \tau_{(\kappa_1\lambda_1)(\kappa_2\lambda_2)\cdots(\kappa_s\lambda_s)}^{(\mu_1\nu_1)(\mu_2\nu_2)\cdots(\mu_r\nu_r)}}{\partial x^{\mu\nu}} \\ &+ \sum_{a=1}^r \tau_{(\kappa_1\lambda_1)(\kappa_2\lambda_2)\cdots(\kappa_s\lambda_s)}^{(\mu_1\nu_1)\cdots(\mu_{a-1}\nu_{a-1})(\sigma\varsigma)(\mu_{a+1}\nu_{a+1})\cdots(\mu_r\nu_r)} \Gamma_{(\sigma\varsigma)(\mu\nu)}^{\mu_a\nu_a} \\ &- \sum_{b=1}^s \tau_{(\kappa_1\lambda_1)\cdots(\kappa_{b-1}\lambda_{b-1})(\mu\nu)(\sigma_{b+1}\varsigma_{b+1})\cdots(\kappa_s\lambda_s)}^{(\mu_1\nu_1)(\mu_2\nu_2)\cdots(\mu_r\nu_r)} \Gamma_{(\sigma_b\varsigma_b)(\mu\nu)}^{\sigma\varsigma}. \end{aligned}$$

This completes the proof. \square

Theorem 5.3.2 *Let \tilde{M} be a smoothly combinatorial manifold with a connection \tilde{D} . Then for $\forall X, Y \in \mathcal{X}(\tilde{M})$,*

$$\tilde{T}(X, Y) = \tilde{D}_X Y - \tilde{D}_Y X - [X, Y]$$

is a tensor of type (1, 2) on \tilde{M} .

Proof By definition, it is clear that $\tilde{T} : \mathcal{X}(\tilde{M}) \times \mathcal{X}(\tilde{M}) \rightarrow \mathcal{X}(\tilde{M})$ is anti-symmetrical and bilinear. We only need to check it is also linear on each element in $C^\infty(\tilde{M})$ for variables X or Y . In fact, for $\forall f \in C^\infty(\tilde{M})$,

$$\begin{aligned} \tilde{T}(fX, Y) &= \tilde{D}_{fX} Y - \tilde{D}_Y (fX) - [fX, Y] \\ &= f\tilde{D}_X Y - (Y(f)X + f\tilde{D}_Y X) \\ &\quad - (f[X, Y] - Y(f)X) = f\tilde{T}(X, Y). \end{aligned}$$

and

$$\tilde{T}(X, fY) = -\tilde{T}(fY, X) = -f\tilde{T}(Y, X) = f\tilde{T}(X, Y).$$

□

5.3.2 Torsion-free Tensor. Notice that

$$\begin{aligned} T\left(\frac{\partial}{\partial x^{\mu\nu}}, \frac{\partial}{\partial x^{\sigma\varsigma}}\right) &= \tilde{D}_{\frac{\partial}{\partial x^{\mu\nu}}} \frac{\partial}{\partial x^{\sigma\varsigma}} - \tilde{D}_{\frac{\partial}{\partial x^{\sigma\varsigma}}} \frac{\partial}{\partial x^{\mu\nu}} \\ &= (\Gamma_{(\mu\nu)(\sigma\varsigma)}^{\kappa\lambda} - \Gamma_{(\sigma\varsigma)(\mu\nu)}^{\kappa\lambda}) \frac{\partial}{\partial x^{\kappa\lambda}} \end{aligned}$$

under a local chart $(U_p; [\varphi_p])$ of a point $p \in \tilde{M}$. If $T(\frac{\partial}{\partial x^{\mu\nu}}, \frac{\partial}{\partial x^{\sigma\varsigma}}) \equiv 0$, we call T *torsion-free*. This enables us getting the next useful result by definition.

Theorem 5.3.3 *A connection \tilde{D} on tensors of a smoothly combinatorial manifold \tilde{M} is torsion-free if and only if $\Gamma_{(\mu\nu)(\sigma\varsigma)}^{\kappa\lambda} = \Gamma_{(\sigma\varsigma)(\mu\nu)}^{\kappa\lambda}$.* □

5.3.3 Combinatorial Riemannian Manifold. A *combinatorial Riemannian geometry* is defined in the next on the case of $s = r = 1$.

Definition 5.3.2 *Let \tilde{M} be a smoothly combinatorial manifold and $g \in A^2(\tilde{M}) = \bigcup_{p \in \tilde{M}} T_2^0(p, \tilde{M})$. If g is symmetrical and positive, then \tilde{M} is called a combinatorial Riemannian manifold, denoted by (\tilde{M}, g) . In this case, if there is a connection \tilde{D} on (\tilde{M}, g) with equality following hold*

$$Z(g(X, Y)) = g(\tilde{D}_Z, Y) + g(X, \tilde{D}_Z Y) \quad (5-4)$$

then \tilde{M} is called a combinatorial Riemannian geometry, denoted by $(\tilde{M}, g, \tilde{D})$.

We get a result for connections on smoothly combinatorial manifolds similar to that of the Riemannian geometry.

Theorem 5.3.4 *Let (\tilde{M}, g) be a combinatorial Riemannian manifold. Then there exists a unique connection \tilde{D} on (\tilde{M}, g) such that $(\tilde{M}, g, \tilde{D})$ is a combinatorial Riemannian geometry.*

Proof By definition, we know that

$$\tilde{D}_Z g(X, Y) = Z(g(X, Y)) - g(\tilde{D}_Z X, Y) - g(X, \tilde{D}_Z Y)$$

for a connection \tilde{D} on tensors of \tilde{M} and $\forall Z \in \mathcal{X}(\tilde{M})$. Thereby, the equality (5-4) is equivalent to that of $\tilde{D}_Z g = 0$ for $\forall Z \in \mathcal{X}(\tilde{M})$, namely \tilde{D} is torsion-free.

Not loss of generality, assume $g = g_{(\mu\nu)(\sigma\varsigma)} dx^{\mu\nu} dx^{\sigma\varsigma}$ in a local chart $(U_p; [\varphi_p])$ of a point p , where $g_{(\mu\nu)(\sigma\varsigma)} = g(\frac{\partial}{\partial x^{\mu\nu}}, \frac{\partial}{\partial x^{\sigma\varsigma}})$. Then we find that

$$\tilde{D}g = (\frac{\partial g_{(\mu\nu)(\sigma\varsigma)}}{\partial x^{\kappa\lambda}} - g_{(\zeta\eta)(\sigma\varsigma)} \Gamma_{(\mu\nu)(\sigma\varsigma)}^{\zeta\eta} - g_{(\mu\nu)(\zeta\eta)} \Gamma_{(\sigma\varsigma)(\kappa\lambda)}^{\zeta\eta}) dx^{\mu\nu} \otimes dx^{\sigma\varsigma} \otimes dx^{\kappa\lambda}.$$

Therefore, we get that

$$\frac{\partial g_{(\mu\nu)(\sigma\varsigma)}}{\partial x^{\kappa\lambda}} = g_{(\zeta\eta)(\sigma\varsigma)} \Gamma_{(\mu\nu)(\sigma\varsigma)}^{\zeta\eta} + g_{(\mu\nu)(\zeta\eta)} \Gamma_{(\sigma\varsigma)(\kappa\lambda)}^{\zeta\eta} \quad (5-5)$$

if $\tilde{D}_Z g = 0$ for $\forall Z \in \mathcal{X}(\tilde{M})$. The formula (5-5) enables us to get that

$$\Gamma_{(\mu\nu)(\sigma\varsigma)}^{\kappa\lambda} = \frac{1}{2} g^{(\kappa\lambda)(\zeta\eta)} (\frac{\partial g_{(\mu\nu)(\zeta\eta)}}{\partial x^{\sigma\varsigma}} + \frac{\partial g_{(\zeta\eta)(\sigma\varsigma)}}{\partial x^{\mu\nu}} - \frac{\partial g_{(\mu\nu)(\sigma\varsigma)}}{\partial x^{\zeta\eta}}),$$

where $g^{(\kappa\lambda)(\zeta\eta)}$ is an element in the matrix inverse of $[g_{(\mu\nu)(\sigma\varsigma)}]$.

Now if there exists another torsion-free connection \tilde{D}^* on (\tilde{M}, g) with

$$\tilde{D}^*_{\frac{\partial}{\partial x^{\mu\nu}}} = \Gamma_{(\sigma\varsigma)(\mu\nu)}^{*\kappa\lambda} \frac{\partial}{\partial x^{\kappa\lambda}},$$

then we must get that

$$\Gamma_{(\mu\nu)(\sigma\varsigma)}^{*\kappa\lambda} = \frac{1}{2} g^{(\kappa\lambda)(\zeta\eta)} (\frac{\partial g_{(\mu\nu)(\zeta\eta)}}{\partial x^{\sigma\varsigma}} + \frac{\partial g_{(\zeta\eta)(\sigma\varsigma)}}{\partial x^{\mu\nu}} - \frac{\partial g_{(\mu\nu)(\sigma\varsigma)}}{\partial x^{\zeta\eta}}).$$

Accordingly, $\tilde{D} = \tilde{D}^*$. Whence, there are at most one torsion-free connection \tilde{D} on a combinatorial Riemannian manifold (\tilde{M}, g) .

For the existence of torsion-free connection \tilde{D} on (\tilde{M}, g) , let $\Gamma_{(\mu\nu)(\sigma\varsigma)}^{\kappa\lambda} = \Gamma_{(\sigma\varsigma)(\mu\nu)}^{\kappa\lambda}$ and define a connection \tilde{D} on (\tilde{M}, g) such that

$$\tilde{D}_{\frac{\partial}{\partial x^{\mu\nu}}} = \Gamma_{(\sigma\varsigma)(\mu\nu)}^{\kappa\lambda} \frac{\partial}{\partial x^{\kappa\lambda}},$$

then \tilde{D} is torsion-free by Theorem 5.3.3. This completes the proof. □

Corollary 5.3.1 *For a Riemannian manifold (M, g) , there exists only one torsion-free connection D , i.e.,*

$$D_Z g(X, Y) = Z(g(X, Y)) - g(D_Z X, Y) - g(X, D_Z Y) \equiv 0$$

for $\forall X, Y, Z \in \mathcal{X}(M)$.

§5.4 CURVATURES ON CONNECTION SPACES

5.4.1 Combinatorial Curvature Operator. A combinatorial connection space is a 2-tuple (\tilde{M}, \tilde{D}) consisting of a smoothly combinatorial manifold \tilde{M} with a connection \tilde{D} on its tensors. We define combinatorial curvature operators on smoothly combinatorial manifolds in the next.

Definition 5.4.1 *Let (\tilde{M}, \tilde{D}) be a combinatorial connection space. For $\forall X, Y \in \mathcal{X}(\tilde{M})$, a combinatorial curvature operator $\tilde{\mathcal{R}}(X, Y) : \mathcal{X}(\tilde{M}) \rightarrow \mathcal{X}(\tilde{M})$ is defined by*

$$\tilde{\mathcal{R}}(X, Y)Z = \tilde{D}_X \tilde{D}_Y Z - \tilde{D}_Y \tilde{D}_X Z - \tilde{D}_{[X, Y]} Z$$

for $\forall Z \in \mathcal{X}(\tilde{M})$.

For a given combinatorial connection space (\tilde{M}, \tilde{D}) , we know properties following on combinatorial curvature operators, which is similar to those of the Riemannian geometry.

Theorem 5.4.1 *Let (\tilde{M}, \tilde{D}) be a combinatorial connection space. Then for $\forall X, Y, Z \in \mathcal{X}(\tilde{M})$, $\forall f \in C^\infty(\tilde{M})$,*

- (1) $\tilde{\mathcal{R}}(X, Y) = -\tilde{\mathcal{R}}(Y, X)$;
- (2) $\tilde{\mathcal{R}}(fX, Y) = \tilde{\mathcal{R}}(X, fY) = f\tilde{\mathcal{R}}(X, Y)$;
- (3) $\tilde{\mathcal{R}}(X, Y)(fZ) = f\tilde{\mathcal{R}}(X, Y)Z$.

Proof For $\forall X, Y, Z \in \mathcal{X}(\tilde{M})$, we know that $\tilde{\mathcal{R}}(X, Y)Z = -\tilde{\mathcal{R}}(Y, X)Z$ by definition. Whence, $\tilde{\mathcal{R}}(X, Y) = -\tilde{\mathcal{R}}(Y, X)$.

Now since

$$\begin{aligned}
 \tilde{\mathcal{R}}(fX, Y)Z &= \tilde{D}_{fX}\tilde{D}_YZ - \tilde{D}_Y\tilde{D}_{fX}Z - \tilde{D}_{[fX, Y]}Z \\
 &= f\tilde{D}_X\tilde{D}_YZ - \tilde{D}_Y(f\tilde{D}_XZ) - \tilde{D}_{f[X, Y]-Y(f)X}Z \\
 &= f\tilde{D}_X\tilde{D}_YZ - Y(f)\tilde{D}_XZ - f\tilde{D}_Y\tilde{D}_XZ \\
 &\quad - f\tilde{D}_{[X, Y]}Z + Y(f)\tilde{D}_XZ \\
 &= f\tilde{\mathcal{R}}(X, Y)Z,
 \end{aligned}$$

we get that $\tilde{\mathcal{R}}(fX, Y) = f\tilde{\mathcal{R}}(X, Y)$. Applying the quality (1), we find that

$$\tilde{\mathcal{R}}(X, fY) = -\tilde{\mathcal{R}}(fY, X) = -f\tilde{\mathcal{R}}(Y, X) = f\tilde{\mathcal{R}}(X, Y).$$

This establishes (2). Now calculation shows that

$$\begin{aligned}
 \tilde{\mathcal{R}}(X, Y)(fZ) &= \tilde{D}_X\tilde{D}_Y(fZ) - \tilde{D}_Y\tilde{D}_X(fZ) - \tilde{D}_{[X, Y]}(fZ) \\
 &= \tilde{D}_X(Y(f)Z + f\tilde{D}_YZ) - \tilde{D}_Y(X(f)Z + f\tilde{D}_XZ) \\
 &\quad - ([X, Y](f))Z - f\tilde{D}_{[X, Y]}Z \\
 &= X(Y(f))Z + Y(f)\tilde{D}_XZ + X(f)\tilde{D}_YZ \\
 &\quad + f\tilde{D}_X\tilde{D}_YZ - Y(X(f))Z - X(f)\tilde{D}_YZ - Y(f)\tilde{D}_XZ \\
 &\quad - f\tilde{D}_Y\tilde{D}_XZ - ([X, Y](f))Z - f\tilde{D}_{[X, Y]}Z \\
 &= f\tilde{\mathcal{R}}(X, Y)Z.
 \end{aligned}$$

Whence, we know that

$$\tilde{\mathcal{R}}(X, Y)(fZ) = f\tilde{\mathcal{R}}(X, Y)Z.$$

□

As the cases in the Riemannian geometry, these curvature tensors on smoothly combinatorial manifolds also satisfy the Bianchi equalities.

Theorem 5.4.2 *Let (\tilde{M}, \tilde{D}) be a combinatorial connection space. If the torsion tensor $\tilde{T} \equiv 0$ on \tilde{D} , then the first and second Bianchi equalities following hold.*

$$\tilde{\mathcal{R}}(X, Y)Z + \tilde{\mathcal{R}}(Y, Z)X + \tilde{\mathcal{R}}(Z, X)Y = 0$$

and

$$(\tilde{D}_X \tilde{R})(Y, Z)W + (\tilde{D}_Y \tilde{R})(Z, X)W + (\tilde{D}_Z \tilde{R})(X, Y)W = 0.$$

Proof Notice that $\tilde{T} \equiv 0$ is equal to $\tilde{D}_X Y - \tilde{D}_Y X = [X, Y]$ for $\forall X, Y \in \mathcal{X}(\tilde{M})$. Thereafter, we know that

$$\begin{aligned} & \tilde{\mathcal{R}}(X, Y)Z + \tilde{\mathcal{R}}(Y, Z)X + \tilde{\mathcal{R}}(Z, X)Y \\ &= \tilde{D}_X \tilde{D}_Y Z - \tilde{D}_Y \tilde{D}_X Z - \tilde{D}_{[X, Y]}Z + \tilde{D}_Y \tilde{D}_Z X - \tilde{D}_Z \tilde{D}_Y X \\ & \quad - \tilde{D}_{[Y, Z]}X + \tilde{D}_Z \tilde{D}_X Y - \tilde{D}_X \tilde{D}_Z Y - \tilde{D}_{[Z, X]}Y \\ &= \tilde{D}_X(\tilde{D}_Y Z - \tilde{D}_Z Y) - \tilde{D}_{[Y, Z]}X + \tilde{D}_Y(\tilde{D}_Z X - \tilde{D}_X Z) \\ & \quad - \tilde{D}_{[Z, X]}Y + \tilde{D}_Z(\tilde{D}_X Y - \tilde{D}_Y X) - \tilde{D}_{[X, Y]}Z \\ &= \tilde{D}_X[Y, Z] - \tilde{D}_{[Y, Z]}X + \tilde{D}_Y[Z, X] - \tilde{D}_{[Z, X]}Y \\ & \quad + \tilde{D}_Z[X, Y] - \tilde{D}_{[X, Y]}Z \\ &= [X, [Y, Z]] + [Y, [Z, X]] + [Z, [X, Y]]. \end{aligned}$$

By the Jacobi equality $[X, [Y, Z]] + [Y, [Z, X]] + [Z, [X, Y]] = 0$, we get that

$$\tilde{\mathcal{R}}(X, Y)Z + \tilde{\mathcal{R}}(Y, Z)X + \tilde{\mathcal{R}}(Z, X)Y = 0.$$

By definition, we know that

$$\begin{aligned} & (\tilde{D}_X \tilde{R})(Y, Z)W \\ &= \tilde{D}_X \tilde{R}(Y, Z)W - \tilde{R}(\tilde{D}_X Y, Z)W - \tilde{R}(Y, \tilde{D}_X Z)W - \tilde{R}(Y, Z)\tilde{D}_X W \\ &= \tilde{D}_X \tilde{D}_Y \tilde{D}_Z W - \tilde{D}_X \tilde{D}_Z \tilde{D}_Y W - \tilde{D}_X \tilde{D}_{[Y, Z]}W - \tilde{D}_{\tilde{D}_X Y} \tilde{D}_Z W \\ & \quad + \tilde{D}_Z \tilde{D}_{\tilde{D}_X Y} W + \tilde{D}_{[\tilde{D}_X Y, Z]}W - \tilde{D}_Y \tilde{D}_{\tilde{D}_X Z} W + \tilde{D}_{\tilde{D}_X Z} \tilde{D}_Y W \\ & \quad + \tilde{D}_{[Y, \tilde{D}_X Z]}W - \tilde{D}_Y \tilde{D}_Z \tilde{D}_X W + \tilde{D}_Z \tilde{D}_Y \tilde{D}_X W + \tilde{D}_{[Y, Z]} \tilde{D}_X W. \end{aligned}$$

Now let

$$\begin{aligned} A^W(X, Y, Z) &= \tilde{D}_X \tilde{D}_Y \tilde{D}_Z W - \tilde{D}_X \tilde{D}_Z \tilde{D}_Y W - \tilde{D}_Y \tilde{D}_Z \tilde{D}_X W + \tilde{D}_Z \tilde{D}_Y \tilde{D}_X W, \\ B^W(X, Y, Z) &= -\tilde{D}_X \tilde{D}_{\tilde{D}_Y Z} W + \tilde{D}_X \tilde{D}_{\tilde{D}_Z Y} W + \tilde{D}_Z \tilde{D}_{\tilde{D}_X Y} W - \tilde{D}_Y \tilde{D}_{\tilde{D}_X Z} W, \\ C^W(X, Y, Z) &= -\tilde{D}_{\tilde{D}_X Y} \tilde{D}_Z W + \tilde{D}_{\tilde{D}_X Z} \tilde{D}_Y W + \tilde{D}_{\tilde{D}_Y Z} \tilde{D}_X W - \tilde{D}_{\tilde{D}_Z Y} \tilde{D}_X W \end{aligned}$$

and

$$D^W(X, Y, Z) = \tilde{D}_{[\tilde{D}_X Y, Z]} W - \tilde{D}_{[\tilde{D}_X Z, Y]} W.$$

Applying the equality $\tilde{D}_X Y - \tilde{D}_Y X = [X, Y]$, we find that

$$(\tilde{D}_X \tilde{R})(Y, Z)W = A^W(X, Y, Z) + B^W(X, Y, Z) + C^W(X, Y, Z) + D^W(X, Y, Z).$$

We can check immediately that

$$\begin{aligned} A^W(X, Y, Z) + A^W(Y, Z, X) + A^W(Z, X, Y) &= 0, \\ B^W(X, Y, Z) + B^W(Y, Z, X) + B^W(Z, X, Y) &= 0, \\ C^W(X, Y, Z) + C^W(Y, Z, X) + C^W(Z, X, Y) &= 0 \end{aligned}$$

and

$$\begin{aligned} D^W(X, Y, Z) + D^W(Y, Z, X) + D^W(Z, X, Y) \\ = \tilde{D}_{[X, [Y, Z]] + [Y, [Z, X]] + [Z, [X, Y]]} W = \tilde{D}_0 W = 0 \end{aligned}$$

by the Jacobi equality $[X, [Y, Z]] + [Y, [Z, X]] + [Z, [X, Y]] = 0$. Therefore, we finally get that

$$\begin{aligned} &(\tilde{D}_X \tilde{R})(Y, Z)W + (\tilde{D}_Y \tilde{R})(Z, X)W + (\tilde{D}_Z \tilde{R})(X, Y)W \\ &= A^W(X, Y, Z) + B^W(X, Y, Z) + C^W(X, Y, Z) + D^W(X, Y, Z) \\ &+ A^W(Y, Z, X) + B^W(Y, Z, X) + C^W(Y, Z, X) + D^W(Y, Z, X) \\ &+ A^W(Z, X, Y) + B^W(Z, X, Y) + C^W(Z, X, Y) + D^W(Z, X, Y) = 0. \end{aligned}$$

This completes the proof. \square

5.4.2 Curvature Tensor on Combinatorial Manifold. According to Theorem 5.4.1, the curvature operator $\tilde{\mathcal{R}}(X, Y) : \mathcal{X}(\tilde{M}) \rightarrow \mathcal{X}(\tilde{M})$ is a tensor of type (1, 1). By applying this operator, we can define a curvature tensor in the next definition.

Definition 5.4.2 Let (\tilde{M}, \tilde{D}) be a combinatorial connection space. For $\forall X, Y, Z \in \mathcal{X}(\tilde{M})$, a linear multi-mapping $\tilde{\mathcal{R}} : \mathcal{X}(\tilde{M}) \times \mathcal{X}(\tilde{M}) \times \mathcal{X}(\tilde{M}) \rightarrow \mathcal{X}(\tilde{M})$ determined by

$$\tilde{\mathcal{R}}(Z, X, Y) = \tilde{\mathcal{R}}(X, Y)Z$$

is said a curvature tensor of type (1, 3) on (\tilde{M}, \tilde{D}) .

Let (\tilde{M}, \tilde{D}) be a combinatorial connection space and

$$\{\bar{e}_{ij} | 1 \leq i \leq s(p), 1 \leq j \leq n_i \text{ and } \bar{e}_{i_1 j} = \bar{e}_{i_2 j} \text{ for } 1 \leq i_1, i_2 \leq s(p) \text{ if } 1 \leq j \leq \hat{s}(p)\}$$

a local frame with a dual

$$\{\omega^{ij} | 1 \leq i \leq s(p), 1 \leq j \leq n_i \text{ and } \omega_{i_1 j} = \omega_{i_2 j} \text{ for } 1 \leq i_1, i_2 \leq s(p) \text{ if } 1 \leq j \leq \hat{s}(p)\},$$

abbreviated to $\{\bar{e}_{ij}\}$ and $\{\omega^{ij}\}$ at a point $p \in \tilde{M}$, where $\tilde{M} = \tilde{M}(n_1, n_2, \dots, n_m)$. Then there exist smooth functions $\Gamma_{(\mu\nu)(\kappa\lambda)}^{\sigma\varsigma} \in C^\infty(\tilde{M})$ such that

$$\tilde{D}_{\bar{e}_{\kappa\lambda}} \bar{e}_{\mu\nu} = \Gamma_{(\mu\nu)(\kappa\lambda)}^{\sigma\varsigma} \bar{e}_{\sigma\varsigma}$$

called connection coefficients in the local frame $\{\bar{e}_{ij}\}$.

Theorem 5.4.3 Let (\tilde{M}, \tilde{D}) be a combinatorial connection space and $\{\bar{e}_{ij}\}$ a local frame with a dual $\{\omega^{ij}\}$ at a point $p \in \tilde{M}$. Then

$$\tilde{d}\omega^{\mu\nu} - \omega^{\kappa\lambda} \wedge \omega_{\kappa\lambda}^{\mu\nu} = \frac{1}{2} \tilde{T}_{(\kappa\lambda)(\sigma\varsigma)}^{\mu\nu} \omega^{\kappa\lambda} \wedge \omega^{\sigma\varsigma},$$

where $\tilde{T}_{(\kappa\lambda)(\sigma\varsigma)}^{\mu\nu}$ is a component of the torsion tensor \tilde{T} in the frame $\{\bar{e}_{ij}\}$, i.e., $\tilde{T}_{(\kappa\lambda)(\sigma\varsigma)}^{\mu\nu} = \omega^{\mu\nu}(\tilde{T}(\bar{e}_{\kappa\lambda}, e_{\sigma\varsigma}))$ and

$$\tilde{d}\omega_{\mu\nu}^{\kappa\lambda} - \omega_{\mu\nu}^{\sigma\varsigma} \wedge \omega_{\sigma\varsigma}^{\kappa\lambda} = \frac{1}{2} \tilde{R}_{(\mu\nu)(\sigma\varsigma)(\eta\theta)}^{\kappa\lambda} \omega^{\sigma\varsigma} \wedge \omega^{\eta\theta}$$

with $\tilde{R}_{(\mu\nu)(\sigma\zeta)(\sigma\zeta)}^{\kappa\lambda} e_{\kappa\lambda} = \tilde{R}(\bar{e}_{\sigma\zeta}, \bar{e}_{\eta\theta}) \bar{e}_{\mu\nu}$.

Proof By definition, for any given $\bar{e}_{\sigma\zeta}, \bar{e}_{\eta\theta}$ we know that

$$\begin{aligned}
 (\tilde{d}\omega^{\mu\nu} - \omega^{\kappa\lambda} \wedge \omega_{\kappa\lambda}^{\mu\nu})(\bar{e}_{\sigma\zeta}, \bar{e}_{\eta\theta}) &= \bar{e}_{\sigma\zeta}(\omega^{\mu\nu}(\bar{e}_{\eta\theta})) - \bar{e}_{\eta\theta}(\omega^{\mu\nu}(\bar{e}_{\sigma\zeta})) - \omega^{\mu\nu}([\bar{e}_{\sigma\zeta}, \bar{e}_{\eta\theta}]) \\
 &\quad - \omega^{\kappa\lambda}(\bar{e}_{\sigma\zeta})\omega_{\kappa\lambda}^{\mu\nu}(\bar{e}_{\eta\theta}) + \omega^{\kappa\lambda}(\bar{e}_{\eta\theta})\omega_{\kappa\lambda}^{\mu\nu}(\bar{e}_{\sigma\zeta}) \\
 &= -\omega_{\sigma\zeta}^{\mu\nu}(\bar{e}_{\eta\theta}) + \omega_{\eta\theta}^{\mu\nu}(\bar{e}_{\sigma\zeta}) - \omega^{\mu\nu}([\bar{e}_{\sigma\zeta}, \bar{e}_{\eta\theta}]) \\
 &= -\Gamma_{(\sigma\zeta)(\eta\theta)}^{\mu\nu} + \Gamma_{(\eta\theta)(\sigma\zeta)}^{\mu\nu} - \omega^{\mu\nu}([\bar{e}_{\sigma\zeta}, \bar{e}_{\eta\theta}]) \\
 &= \omega^{\mu\nu}(\tilde{D}_{\bar{e}_{\sigma\zeta}}\bar{e}_{\eta\theta} - \tilde{D}_{\bar{e}_{\eta\theta}}\bar{e}_{\sigma\zeta} - [\bar{e}_{\sigma\zeta}, \bar{e}_{\eta\theta}]) \\
 &= \omega^{\mu\nu}(\tilde{T}(\bar{e}_{\sigma\zeta}, \bar{e}_{\eta\theta})) = \tilde{T}_{(\sigma\zeta)(\eta\theta)}^{\mu\nu}.
 \end{aligned}$$

by Theorem 5.2.3. Whence,

$$\tilde{d}\omega^{\mu\nu} - \omega^{\kappa\lambda} \wedge \omega_{\kappa\lambda}^{\mu\nu} = \frac{1}{2}\tilde{T}_{(\kappa\lambda)(\sigma\zeta)}^{\mu\nu}\omega^{\kappa\lambda} \wedge \omega^{\sigma\zeta}.$$

Now since

$$\begin{aligned}
 &(\tilde{d}\omega_{\mu\nu}^{\kappa\lambda} - \omega_{\mu\nu}^{\vartheta\iota} \wedge \omega_{\vartheta\iota}^{\kappa\lambda})(\bar{e}_{\sigma\zeta}, \bar{e}_{\eta\theta}) \\
 &= \bar{e}_{\sigma\zeta}(\omega_{\mu\nu}^{\kappa\lambda}(\bar{e}_{\eta\theta})) - \bar{e}_{\eta\theta}(\omega_{\mu\nu}^{\kappa\lambda}(\bar{e}_{\sigma\zeta})) - \omega_{\mu\nu}^{\kappa\lambda}([\bar{e}_{\sigma\zeta}, \bar{e}_{\eta\theta}]) \\
 &\quad - \omega_{\mu\nu}^{\vartheta\iota}(\bar{e}_{\sigma\zeta})\omega_{\vartheta\iota}^{\kappa\lambda}(\bar{e}_{\eta\theta}) + \omega_{\mu\nu}^{\vartheta\iota}(\bar{e}_{\eta\theta})\omega_{\vartheta\iota}^{\kappa\lambda}(\bar{e}_{\sigma\zeta}) \\
 &= \bar{e}_{\sigma\zeta}(\Gamma_{(\mu\nu)(\eta\theta)}^{\kappa\lambda}) - \bar{e}_{\eta\theta}(\Gamma_{(\mu\nu)(\sigma\zeta)}^{\kappa\lambda}) - \omega^{\vartheta\iota}([\bar{e}_{\sigma\zeta}, \bar{e}_{\eta\theta}])\Gamma_{(\mu\nu)(\vartheta\iota)}^{\kappa\lambda} \\
 &\quad - \Gamma_{(\mu\nu)(\sigma\zeta)}^{\vartheta\iota}\Gamma_{(\vartheta\iota)(\eta\theta)}^{\kappa\lambda} + \Gamma_{(\mu\nu)(\eta\theta)}^{\vartheta\iota}\Gamma_{(\vartheta\iota)(\sigma\zeta)}^{\kappa\lambda}
 \end{aligned}$$

and

$$\begin{aligned}
 \tilde{R}(\bar{e}_{\sigma\zeta}, \bar{e}_{\eta\theta})\bar{e}_{\mu\nu} &= \tilde{D}_{\bar{e}_{\sigma\zeta}}\tilde{D}_{\bar{e}_{\eta\theta}}\bar{e}_{\mu\nu} - \tilde{D}_{\bar{e}_{\eta\theta}}\tilde{D}_{\bar{e}_{\sigma\zeta}}\bar{e}_{\mu\nu} - \tilde{D}_{[\bar{e}_{\sigma\zeta}, \bar{e}_{\eta\theta}]} \bar{e}_{\mu\nu} \\
 &= \tilde{D}_{\bar{e}_{\sigma\zeta}}(\Gamma_{(\mu\nu)(\eta\theta)}^{\kappa\lambda}\bar{e}_{\kappa\lambda}) - \tilde{D}_{\bar{e}_{\eta\theta}}(\Gamma_{(\mu\nu)(\sigma\zeta)}^{\kappa\lambda}\bar{e}_{\kappa\lambda}) - \omega^{\vartheta\iota}([\bar{e}_{\sigma\zeta}, \bar{e}_{\eta\theta}])\Gamma_{(\mu\nu)(\vartheta\iota)}^{\kappa\lambda}\bar{e}_{\kappa\lambda} \\
 &= (\bar{e}_{\sigma\zeta}(\Gamma_{(\mu\nu)(\eta\theta)}^{\kappa\lambda}) - \bar{e}_{\eta\theta}(\Gamma_{(\mu\nu)(\sigma\zeta)}^{\kappa\lambda}) + \Gamma_{(\mu\nu)(\eta\theta)}^{\vartheta\iota}\Gamma_{(\vartheta\iota)(\sigma\zeta)}^{\kappa\lambda}) \\
 &\quad - \Gamma_{(\mu\nu)(\sigma\zeta)}^{\vartheta\iota}\Gamma_{(\vartheta\iota)(\eta\theta)}^{\kappa\lambda} - \omega^{\vartheta\iota}([\bar{e}_{\sigma\zeta}, \bar{e}_{\eta\theta}])\Gamma_{(\mu\nu)(\vartheta\iota)}^{\kappa\lambda}\bar{e}_{\kappa\lambda} \\
 &= (\tilde{d}\omega_{\mu\nu}^{\kappa\lambda} - \omega_{\mu\nu}^{\vartheta\iota} \wedge \omega_{\vartheta\iota}^{\kappa\lambda})(\bar{e}_{\sigma\zeta}, \bar{e}_{\eta\theta})\bar{e}_{\kappa\lambda}.
 \end{aligned}$$

Therefore, we get that

$$(\tilde{d}\omega_{\mu\nu}^{\kappa\lambda} - \omega_{\mu\nu}^{\theta\iota} \wedge \omega_{\theta\iota}^{\kappa\lambda})(\bar{e}_{\sigma\varsigma}, \bar{e}_{\eta\theta}) = \tilde{R}_{(\mu\nu)(\sigma\varsigma)(\eta\theta)}^{\kappa\lambda},$$

that is,

$$\tilde{d}\omega_{\mu\nu}^{\kappa\lambda} - \omega_{\mu\nu}^{\sigma\varsigma} \wedge \omega_{\sigma\varsigma}^{\kappa\lambda} = \frac{1}{2} \tilde{R}_{(\mu\nu)(\sigma\varsigma)(\eta\theta)}^{\kappa\lambda} \omega^{\sigma\varsigma} \wedge \omega^{\eta\theta}.$$

□

5.4.3 Structural Equation. First, we introduce torsion forms, curvature forms and structural equations in a local frame $\{e_{ij}\}$ of $(\widetilde{M}, \widetilde{D})$ in the next.

Definition 5.4.3 Let $(\widetilde{M}, \widetilde{D})$ be a combinatorial connection space. Differential 2-forms $\Omega^{\mu\nu} = \tilde{d}\omega^{\mu\nu} - \omega^{\mu\nu} \wedge \omega_{\kappa\lambda}^{\mu\nu}$, $\Omega_{\mu\nu}^{\kappa\lambda} = \tilde{d}\omega_{\mu\nu}^{\kappa\lambda} - \omega_{\mu\nu}^{\sigma\varsigma} \wedge \omega_{\sigma\varsigma}^{\kappa\lambda}$ and equations

$$\tilde{d}\omega^{\mu\nu} = \omega^{\kappa\lambda} \wedge \omega_{\kappa\lambda}^{\mu\nu} + \Omega^{\mu\nu}, \quad \tilde{d}\omega_{\mu\nu}^{\kappa\lambda} = \omega_{\mu\nu}^{\sigma\varsigma} \wedge \omega_{\sigma\varsigma}^{\kappa\lambda} + \Omega_{\mu\nu}^{\kappa\lambda}$$

are called torsion forms, curvature forms and structural equations in a local frame $\{e_{ij}\}$ of $(\widetilde{M}, \widetilde{D})$, respectively.

By Theorem 5.4.3 and Definition 5.4.3, we get local forms for torsion tensor and curvature tensor in a local frame following.

Corollary 5.4.1 Let $(\widetilde{M}, \widetilde{D})$ be a combinatorial connection space and $\{e_{ij}\}$ a local frame with a dual $\{\omega^{ij}\}$ at a point $p \in \widetilde{M}$. Then

$$\tilde{T} = \Omega^{\mu\nu} \otimes e_{\mu\nu} \quad \text{and} \quad \tilde{R} = \omega^{\mu\nu} \otimes e_{\kappa\lambda} \otimes \Omega_{\mu\nu}^{\kappa\lambda},$$

i.e., for $\forall X, Y \in \mathcal{X}(\widetilde{M})$,

$$\tilde{T}(X, Y) = \Omega^{\mu\nu}(X, Y)e_{\mu\nu} \quad \text{and} \quad \tilde{R}(X, Y) = \Omega_{\mu\nu}^{\kappa\lambda}(X, Y)\omega^{\mu\nu} \otimes e_{\mu\nu}.$$

Theorem 5.4.4 Let $(\widetilde{M}, \widetilde{D})$ be a combinatorial connection space and $\{e_{ij}\}$ a local frame with a dual $\{\omega^{ij}\}$ at a point $p \in \widetilde{M}$. Then

$$\tilde{d}\Omega^{\mu\nu} = \omega^{\kappa\lambda} \wedge \Omega_{\kappa\lambda}^{\mu\nu} - \Omega^{\kappa\lambda} \wedge \omega_{\kappa\lambda}^{\mu\nu} \quad \text{and} \quad \tilde{d}\Omega_{\mu\nu}^{\kappa\lambda} = \omega_{\mu\nu}^{\sigma\varsigma} \wedge \Omega_{\sigma\varsigma}^{\kappa\lambda} - \Omega_{\mu\nu}^{\sigma\varsigma} \wedge \omega_{\sigma\varsigma}^{\kappa\lambda}.$$

Proof Notice that $\tilde{d}^2 = 0$. Differentiating the equality $\Omega^{\mu\nu} = \tilde{d}\omega^{\mu\nu} - \omega^{\mu\nu} \wedge \omega_{\kappa\lambda}^{\mu\nu}$ on both sides, we get that

$$\begin{aligned}
\tilde{d}\Omega^{\mu\nu} &= -\tilde{d}\omega^{\mu\nu} \wedge \omega_{\kappa\lambda}^{\mu\nu} + \omega^{\mu\nu} \wedge \tilde{d}\omega_{\kappa\lambda}^{\mu\nu} \\
&= -(\Omega^{\kappa\lambda} + \omega^{\sigma\varsigma} \wedge \omega_{\sigma\varsigma}^{\kappa\lambda}) \wedge \omega_{\kappa\lambda}^{\mu\nu} + \omega^{\kappa\lambda} \wedge (\Omega_{\kappa\lambda}^{\mu\nu} + \omega_{\kappa\lambda}^{\sigma\varsigma} \wedge \omega_{\sigma\varsigma}^{\mu\nu}) \\
&= \omega^{\kappa\lambda} \wedge \Omega_{\kappa\lambda}^{\mu\nu} - \Omega^{\kappa\lambda} \wedge \omega_{\kappa\lambda}^{\mu\nu}.
\end{aligned}$$

Similarly, differentiating the equality $\Omega_{\mu\nu}^{\kappa\lambda} = \tilde{d}\omega_{\mu\nu}^{\kappa\lambda} - \omega_{\mu\nu}^{\sigma\varsigma} \wedge \omega_{\sigma\varsigma}^{\kappa\lambda}$ on both sides, we can also find that

$$\tilde{d}\Omega_{\mu\nu}^{\kappa\lambda} = \omega_{\mu\nu}^{\sigma\varsigma} \wedge \Omega_{\sigma\varsigma}^{\kappa\lambda} - \Omega_{\mu\nu}^{\sigma\varsigma} \wedge \omega_{\sigma\varsigma}^{\kappa\lambda}.$$

□

Corollary 5.4.2 *Let (M, D) be an affine connection space and $\{e_i\}$ a local frame with a dual $\{\omega^i\}$ at a point $p \in M$. Then*

$$d\Omega^i = \omega^j \wedge \Omega_j^i - \Omega^j \wedge \omega_j^i \quad \text{and} \quad d\Omega_i^j = \omega_i^k \wedge \Omega_k^j - \Omega_i^k \wedge \omega_k^j.$$

5.4.4 Local Form of Curvature Tensor. According to Theorems 5.4.1 – 5.4.4 there is a type $(1, 3)$ tensor $\tilde{\mathcal{R}}_p : T_p\tilde{M} \times T_p\tilde{M} \times T_p\tilde{M} \rightarrow T_p\tilde{M}$ determined by $\tilde{\mathcal{R}}(w, u, v) = \tilde{\mathcal{R}}(u, v)w$ for $\forall u, v, w \in T_p\tilde{M}$ at each point $p \in \tilde{M}$. Particularly, we get its a concrete local form in the standard basis $\{\frac{\partial}{\partial x^{\mu\nu}}\}$.

Theorem 5.4.5 *Let (\tilde{M}, \tilde{D}) be a combinatorial connection space. Then for $\forall p \in \tilde{M}$ with a local chart $(U_p; [\varphi_p])$,*

$$\tilde{\mathcal{R}} = \tilde{\mathcal{R}}_{(\sigma\varsigma)(\mu\nu)(\kappa\lambda)}^{\eta\theta} dx^{\sigma\varsigma} \otimes \frac{\partial}{\partial x^{\eta\theta}} \otimes dx^{\mu\nu} \otimes dx^{\kappa\lambda}$$

with

$$\tilde{\mathcal{R}}_{(\sigma\varsigma)(\mu\nu)(\kappa\lambda)}^{\eta\theta} = \frac{\partial \Gamma_{(\sigma\varsigma)(\kappa\lambda)}^{\eta\theta}}{\partial x^{\mu\nu}} - \frac{\partial \Gamma_{(\sigma\varsigma)(\mu\nu)}^{\eta\theta}}{\partial x^{\kappa\lambda}} + \Gamma_{(\sigma\varsigma)(\kappa\lambda)}^{\vartheta\iota} \Gamma_{(\vartheta\iota)(\mu\nu)}^{\eta\theta} - \Gamma_{(\sigma\varsigma)(\mu\nu)}^{\vartheta\iota} \Gamma_{(\vartheta\iota)(\kappa\lambda)}^{\eta\theta} \frac{\partial}{\partial x^{\vartheta\iota}},$$

where $\Gamma_{(\mu\nu)(\kappa\lambda)}^{\sigma\varsigma} \in C^\infty(U_p)$ is determined by

$$\tilde{D}_{\frac{\partial}{\partial x^{\mu\nu}}} \frac{\partial}{\partial x^{\kappa\lambda}} = \Gamma_{(\kappa\lambda)(\mu\nu)}^{\sigma\varsigma} \frac{\partial}{\partial x^{\sigma\varsigma}}.$$

Proof We only need to prove that for integers $\mu, \nu, \kappa, \lambda, \sigma, \varsigma, \iota$ and θ ,

$$\tilde{\mathcal{R}}\left(\frac{\partial}{\partial x^{\mu\nu}}, \frac{\partial}{\partial x^{\kappa\lambda}}\right)\frac{\partial}{\partial x^{\sigma\varsigma}} = \tilde{\mathcal{R}}_{(\sigma\varsigma)(\mu\nu)(\kappa\lambda)}^{\eta\theta}\frac{\partial}{\partial x^{\eta\theta}}$$

at the local chart $(U_p; [\varphi_p])$. In fact, by definition we get that

$$\begin{aligned} & \tilde{\mathcal{R}}\left(\frac{\partial}{\partial x^{\mu\nu}}, \frac{\partial}{\partial x^{\kappa\lambda}}\right)\frac{\partial}{\partial x^{\sigma\varsigma}} \\ &= \tilde{D}_{\frac{\partial}{\partial x^{\mu\nu}}}\tilde{D}_{\frac{\partial}{\partial x^{\kappa\lambda}}}\frac{\partial}{\partial x^{\sigma\varsigma}} - \tilde{D}_{\frac{\partial}{\partial x^{\kappa\lambda}}}\tilde{D}_{\frac{\partial}{\partial x^{\mu\nu}}}\frac{\partial}{\partial x^{\sigma\varsigma}} - \tilde{D}_{[\frac{\partial}{\partial x^{\mu\nu}}, \frac{\partial}{\partial x^{\kappa\lambda}}]}\frac{\partial}{\partial x^{\sigma\varsigma}} \\ &= \tilde{D}_{\frac{\partial}{\partial x^{\mu\nu}}}(\Gamma_{(\sigma\varsigma)(\kappa\lambda)}^{\eta\theta})\frac{\partial}{\partial x^{\eta\theta}} - \tilde{D}_{\frac{\partial}{\partial x^{\kappa\lambda}}}(\Gamma_{(\sigma\varsigma)(\mu\nu)}^{\eta\theta})\frac{\partial}{\partial x^{\eta\theta}} \\ &= \frac{\partial\Gamma_{(\sigma\varsigma)(\kappa\lambda)}^{\eta\theta}}{\partial x^{\mu\nu}}\frac{\partial}{\partial x^{\eta\theta}} + \Gamma_{(\sigma\varsigma)(\kappa\lambda)}^{\eta\theta}\tilde{D}_{\frac{\partial}{\partial x^{\mu\nu}}}\frac{\partial}{\partial x^{\eta\theta}} - \frac{\partial\Gamma_{(\sigma\varsigma)(\mu\nu)}^{\eta\theta}}{\partial x^{\kappa\lambda}}\frac{\partial}{\partial x^{\eta\theta}} - \Gamma_{(\sigma\varsigma)(\mu\nu)}^{\eta\theta}\tilde{D}_{\frac{\partial}{\partial x^{\kappa\lambda}}}\frac{\partial}{\partial x^{\eta\theta}} \\ &= \left(\frac{\partial\Gamma_{(\sigma\varsigma)(\kappa\lambda)}^{\eta\theta}}{\partial x^{\mu\nu}} - \frac{\partial\Gamma_{(\sigma\varsigma)(\mu\nu)}^{\eta\theta}}{\partial x^{\kappa\lambda}}\right)\frac{\partial}{\partial x^{\eta\theta}} + \Gamma_{(\sigma\varsigma)(\kappa\lambda)}^{\eta\theta}\Gamma_{(\eta\theta)(\mu\nu)}^{\vartheta\iota}\frac{\partial}{\partial x^{\vartheta\iota}} - \Gamma_{(\sigma\varsigma)(\mu\nu)}^{\eta\theta}\Gamma_{(\eta\theta)(\kappa\lambda)}^{\vartheta\iota}\frac{\partial}{\partial x^{\vartheta\iota}} \\ &= \left(\frac{\partial\Gamma_{(\sigma\varsigma)(\kappa\lambda)}^{\eta\theta}}{\partial x^{\mu\nu}} - \frac{\partial\Gamma_{(\sigma\varsigma)(\mu\nu)}^{\eta\theta}}{\partial x^{\kappa\lambda}} + \Gamma_{(\sigma\varsigma)(\kappa\lambda)}^{\vartheta\iota}\Gamma_{(\vartheta\iota)(\mu\nu)}^{\eta\theta} - \Gamma_{(\sigma\varsigma)(\mu\nu)}^{\vartheta\iota}\Gamma_{(\vartheta\iota)(\kappa\lambda)}^{\eta\theta}\right)\frac{\partial}{\partial x^{\eta\theta}} \\ &= \tilde{\mathcal{R}}_{(\sigma\varsigma)(\mu\nu)(\kappa\lambda)}^{\eta\theta}\frac{\partial}{\partial x^{\eta\theta}}. \end{aligned}$$

This completes the proof. \square

For the curvature tensor $\tilde{\mathcal{R}}_{(\sigma\varsigma)(\mu\nu)(\kappa\lambda)}^{\eta\theta}$, we can also get these *Bianchi identities* in the next result.

Theorem 5.4.6 *Let (\tilde{M}, \tilde{D}) be a combinatorial connection space. Then for $\forall p \in \tilde{M}$ with a local chart $(U_p, [\varphi_p])$, if $\tilde{T} \equiv 0$, then*

$$\tilde{R}_{(\kappa\lambda)(\sigma\varsigma)(\eta\theta)}^{\mu\nu} + \tilde{R}_{(\sigma\varsigma)(\eta\theta)(\kappa\lambda)}^{\mu\nu} + \tilde{R}_{(\eta\theta)(\kappa\lambda)(\sigma\varsigma)}^{\mu\nu} = 0$$

and

$$\tilde{D}_{\vartheta\iota}\tilde{R}_{(\mu\nu)(\sigma\varsigma)(\eta\theta)}^{\kappa\lambda} + \tilde{D}_{\sigma\varsigma}\tilde{R}_{(\mu\nu)(\eta\theta)(\vartheta\iota)}^{\kappa\lambda} + \tilde{D}_{\eta\theta}\tilde{R}_{(\mu\nu)(\vartheta\iota)(\sigma\varsigma)}^{\kappa\lambda} = 0,$$

where,

$$\tilde{D}_{\vartheta\iota}\tilde{R}_{(\mu\nu)(\sigma\varsigma)(\eta\theta)}^{\kappa\lambda} = \tilde{D}_{\frac{\partial}{\partial x^{\vartheta\iota}}}\tilde{R}_{(\mu\nu)(\sigma\varsigma)(\eta\theta)}^{\kappa\lambda}.$$

Proof By definition of the curvature tensor $\tilde{\mathcal{R}}_{(\sigma\varsigma)(\mu\nu)(\kappa\lambda)}^{\eta\theta}$, we know that

$$\begin{aligned} & \tilde{R}_{(\kappa\lambda)(\sigma\varsigma)(\eta\theta)}^{\mu\nu} + \tilde{R}_{(\sigma\varsigma)(\eta\theta)(\kappa\lambda)}^{\mu\nu} + \tilde{R}_{(\eta\theta)(\kappa\lambda)(\sigma\varsigma)}^{\mu\nu} \\ &= \tilde{R}\left(\frac{\partial}{\partial x^{\sigma\varsigma}}, \frac{\partial}{\partial x^{\eta\theta}}\right)\frac{\partial}{\partial x^{\kappa\lambda}} + \tilde{R}\left(\frac{\partial}{\partial x^{\eta\theta}}, \frac{\partial}{\partial x^{\kappa\lambda}}\right)\frac{\partial}{\partial x^{\sigma\varsigma}} + \tilde{R}\left(\frac{\partial}{\partial x^{\kappa\lambda}}, \frac{\partial}{\partial x^{\sigma\varsigma}}\right)\frac{\partial}{\partial x^{\eta\theta}} = 0 \end{aligned}$$

with

$$X = \frac{\partial}{\partial x^{\sigma\varsigma}}, \quad Y = \frac{\partial}{\partial x^{\eta\theta}} \quad \text{and} \quad Z = \frac{\partial}{\partial x^{\kappa\lambda}}$$

in the first Bianchi equality and

$$\begin{aligned} & \tilde{D}_{\vartheta\iota}\tilde{R}_{(\mu\nu)(\sigma\varsigma)(\eta\theta)}^{\kappa\lambda} + \tilde{D}_{\sigma\varsigma}\tilde{R}_{(\mu\nu)(\eta\theta)(\vartheta\iota)}^{\kappa\lambda} + \tilde{D}_{\eta\theta}\tilde{R}_{(\mu\nu)(\vartheta\iota)(\sigma\varsigma)}^{\kappa\lambda} \\ &= \tilde{D}_{\vartheta\iota}\tilde{R}\left(\frac{\partial}{\partial x^{\sigma\varsigma}}, \frac{\partial}{\partial x^{\eta\theta}}\right)\frac{\partial}{\partial x^{\kappa\lambda}} + \tilde{D}_{\sigma\varsigma}\tilde{R}\left(\frac{\partial}{\partial x^{\eta\theta}}, \frac{\partial}{\partial x^{\vartheta\iota}}\right)\frac{\partial}{\partial x^{\kappa\lambda}} + \tilde{D}_{\eta\theta}\tilde{R}\left(\frac{\partial}{\partial x^{\vartheta\iota}}, \frac{\partial}{\partial x^{\sigma\varsigma}}\right)\frac{\partial}{\partial x^{\kappa\lambda}} \\ &= 0. \end{aligned}$$

with

$$X = \frac{\partial}{\partial x^{\vartheta\iota}}, \quad Y = \frac{\partial}{\partial x^{\sigma\varsigma}}, \quad Z = \frac{\partial}{\partial x^{\eta\theta}}, \quad W = \frac{\partial}{\partial x^{\kappa\lambda}}$$

in the second Bianchi equality of Theorem 5.4.2. □

§5.5 CURVATURES ON RIEMANNIAN MANIFOLDS

5.5.1 Combinatorial Riemannian Curvature Tensor. In this section, we turn our attention to combinatorial Riemannian manifolds and characterize curvature tensors on combinatorial manifolds further.

Definition 5.5.1 *Let $(\tilde{M}, g, \tilde{D})$ be a combinatorial Riemannian manifold. A combinatorial Riemannian curvature tensor*

$$\tilde{R} : \mathcal{X}(\tilde{M}) \times \mathcal{X}(\tilde{M}) \times \mathcal{X}(\tilde{M}) \times \mathcal{X}(\tilde{M}) \rightarrow C^\infty(\tilde{M})$$

of type $(0, 4)$ is defined by

$$\tilde{R}(X, Y, Z, W) = g(\tilde{R}(Z, W)X, Y)$$

for $\forall X, Y, Z, W \in \mathcal{X}(\widetilde{M})$.

Then we find symmetrical relations of $\widetilde{R}(X, Y, Z, W)$ following.

Theorem 5.5.1 *Let $\widetilde{R} : \mathcal{X}(\widetilde{M}) \times \mathcal{X}(\widetilde{M}) \times \mathcal{X}(\widetilde{M}) \times \mathcal{X}(\widetilde{M}) \rightarrow C^\infty(\widetilde{M})$ be a combinatorial Riemannian curvature tensor. Then for $\forall X, Y, Z, W \in \mathcal{X}(\widetilde{M})$,*

- (1) $\widetilde{R}(X, Y, Z, W) + \widetilde{R}(Z, Y, W, X) + \widetilde{R}(W, Y, X, Z) = 0$.
- (2) $\widetilde{R}(X, Y, Z, W) = -\widetilde{R}(Y, X, Z, W)$ and $\widetilde{R}(X, Y, Z, W) = -\widetilde{R}(X, Y, W, Z)$.
- (3) $\widetilde{R}(X, Y, Z, W) = \widetilde{R}(Z, W, X, Y)$.

Proof For the equality (1), calculation shows that

$$\begin{aligned} & \widetilde{R}(X, Y, Z, W) + \widetilde{R}(Z, Y, W, X) + \widetilde{R}(W, Y, X, Z) \\ &= g(\widetilde{R}(Z, W)X, Y) + g(\widetilde{R}(W, X)Z, Y) + g(\widetilde{R}(X, Z)W, Y) \\ &= g(\widetilde{R}(Z, W)X + \widetilde{R}(W, X)Z + \widetilde{R}(X, Z)W, Y) = 0 \end{aligned}$$

by definition and Theorem 5.4.1(4).

For (2), by definition and Theorem 5.4.1(1), we know that

$$\begin{aligned} \widetilde{R}(X, Y, Z, W) &= g(\widetilde{R}(Z, W)X, Y) = g(-\widetilde{R}(W, Z)X, Y) \\ &= -g(\widetilde{R}(W, Z)X, Y) = -\widetilde{R}(X, Y, W, Z). \end{aligned}$$

Now since \widetilde{D} is a combinatorial Riemannian connection, we know that

$$Z(g(X, Y)) = g(\widetilde{D}_Z X, Y) + g(X, \widetilde{D}_Z Y).$$

by Theorem 5.3.4. Therefore, we find that

$$\begin{aligned} g(\widetilde{D}_Z \widetilde{D}_W X, Y) &= Z(g(\widetilde{D}_W X, Y)) - g(\widetilde{D}_W X, \widetilde{D}_Z Y) \\ &= Z(W(g(X, Y))) - Z(g(X, \widetilde{D}_W Y)) \\ &\quad - W(g(X, \widetilde{D}_Z Y)) + g(X, \widetilde{D}_W \widetilde{D}_Z Y). \end{aligned}$$

Similarly, we have that

$$\begin{aligned} g(\tilde{D}_W \tilde{D}_Z X, Y) &= W(Z(g(X, Y))) - W(g(X, \tilde{D}_Z Y)) \\ &\quad - Z(g(X, \tilde{D}_W Y)) + g(X, \tilde{D}_Z \tilde{D}_W Y). \end{aligned}$$

Notice that

$$g(\tilde{D}_{[Z, W]}, Y) = [Z, W]g(X, Y) - g(X, \tilde{D}_{[Z, W]}Y).$$

By definition, we get that

$$\begin{aligned} \tilde{R}(X, Y, Z, W) &= g(\tilde{D}_Z \tilde{D}_W X - \tilde{D}_W \tilde{D}_Z X - \tilde{D}_{[Z, W]}X, Y) \\ &= g(\tilde{D}_Z \tilde{D}_W X, Y) - g(\tilde{D}_W \tilde{D}_Z X, Y) - g(\tilde{D}_{[Z, W]}X, Y) \\ &= Z(W(g(X, Y))) - Z(g(X, \tilde{D}_W Y)) - W(g(X, \tilde{D}_Z Y)) \\ &\quad + g(X, \tilde{D}_W \tilde{D}_Z Y) - W(Z(g(X, Y))) + W(g(X, \tilde{D}_Z Y)) \\ &\quad + Z(g(X, \tilde{D}_W Y)) - g(X, \tilde{D}_Z \tilde{D}_W Y) - [Z, W]g(X, Y) \\ &\quad - g(X, \tilde{D}_{[Z, W]}Y) \\ &= Z(W(g(X, Y))) - W(Z(g(X, Y))) + g(X, \tilde{D}_W \tilde{D}_Z Y) \\ &\quad - g(X, \tilde{D}_Z \tilde{D}_W Y) - [Z, W]g(X, Y) - g(X, \tilde{D}_{[Z, W]}Y) \\ &= g(X, \tilde{D}_W \tilde{D}_Z Y - \tilde{D}_Z \tilde{D}_W Y + \tilde{D}_{[Z, W]}Y) \\ &= -g(X, \tilde{R}(Z, W)Y) = -\tilde{R}(Y, X, Z, W). \end{aligned}$$

Applying the equality (1), we know that

$$\tilde{R}(X, Y, Z, W) + \tilde{R}(Z, Y, W, X) + \tilde{R}(W, Y, X, Z) = 0, \quad (5-6)$$

$$\tilde{R}(Y, Z, W, X) + \tilde{R}(W, Z, X, Y) + \tilde{R}(X, Z, Y, W) = 0. \quad (5-7)$$

Then (5-6) + (5-7) shows that

$$\begin{aligned} \tilde{R}(X, Y, Z, W) + \tilde{R}(W, Y, X, Z) \\ + \tilde{R}(W, Z, X, Y) + \tilde{R}(X, Z, Y, W) = 0 \end{aligned}$$

by applying (2). We also know that

$$\begin{aligned} \tilde{R}(W, Y, X, Z) - \tilde{R}(X, Z, Y, W) &= -(\tilde{R}(Z, Y, W, X) - \tilde{R}(W, X, Z, Y)) \\ &= \tilde{R}(X, Y, Z, W) - \tilde{R}(Z, W, X, Y). \end{aligned}$$

This enables us getting the equality (3)

$$\tilde{R}(X, Y, Z, W) = \tilde{R}(Z, W, X, Y).$$

□

5.5.2 Structural Equation in Riemannian Manifold. Applying Theorems 5.4.2 – 5.4.3 and 5.5.1, we also get the next result.

Theorem 5.5.2 *Let $(\tilde{M}, g, \tilde{D})$ be a combinatorial Riemannian manifold and $\Omega_{(\mu\nu)(\kappa\lambda)} = \Omega_{\mu\nu}^{\sigma\varsigma} g_{(\sigma\varsigma)(\kappa\lambda)}$. Then*

- (1) $\Omega_{(\mu\nu)(\kappa\lambda)} = \frac{1}{2} \tilde{R}_{(\mu\nu)(\kappa\lambda)(\sigma\varsigma)(\eta\theta)} \omega^{\sigma\varsigma} \wedge \omega^{\eta\theta}$;
- (2) $\Omega_{(\mu\nu)(\kappa\lambda)} + \Omega_{(\kappa\lambda)(\mu\nu)} = 0$;
- (3) $\omega^{\mu\nu} \wedge \Omega_{(\mu\nu)(\kappa\lambda)} = 0$;
- (4) $\tilde{d}\Omega_{(\mu\nu)(\kappa\lambda)} = \omega_{\mu\nu}^{\sigma\varsigma} \wedge \Omega_{(\sigma\varsigma)(\kappa\lambda)} - \omega_{\kappa\lambda}^{\sigma\varsigma} \wedge \Omega_{(\sigma\varsigma)(\mu\nu)}$.

Proof Notice that $\tilde{T} \equiv 0$ in a combinatorial Riemannian manifold $(\tilde{M}, g, \tilde{D})$. We find that

$$\Omega_{\mu\nu}^{\kappa\lambda} = \frac{1}{2} \tilde{R}_{(\mu\nu)(\sigma\varsigma)(\eta\theta)}^{\kappa\lambda} \omega^{\sigma\varsigma} \wedge \omega^{\eta\theta}$$

by Theorem 5.4.2. By definition, we know that

$$\begin{aligned} \Omega_{(\mu\nu)(\kappa\lambda)} &= \Omega_{\mu\nu}^{\sigma\varsigma} g_{(\sigma\varsigma)(\kappa\lambda)} \\ &= \frac{1}{2} \tilde{R}_{(\mu\nu)(\eta\theta)(\vartheta\iota)}^{\sigma\varsigma} g_{(\sigma\varsigma)(\kappa\lambda)} \omega^{\eta\theta} \wedge \omega^{\vartheta\iota} = \frac{1}{2} \tilde{R}_{(\mu\nu)(\kappa\lambda)(\sigma\varsigma)(\eta\theta)} \omega^{\sigma\varsigma} \wedge \omega^{\eta\theta}. \end{aligned}$$

Whence, we get the equality (1). For (2), applying Theorem 5.5.1(2), we find that

$$\Omega_{(\mu\nu)(\kappa\lambda)} + \Omega_{(\kappa\lambda)(\mu\nu)} = \frac{1}{2} (\tilde{R}_{(\mu\nu)(\kappa\lambda)(\sigma\varsigma)(\eta\theta)} + \tilde{R}_{(\kappa\lambda)(\mu\nu)(\sigma\varsigma)(\eta\theta)}) \omega^{\sigma\varsigma} \wedge \omega^{\eta\theta} = 0.$$

By Corollary 5.4.1, a connection \tilde{D} is torsion-free only if $\Omega^{\mu\nu} \equiv 0$. This fact enables us to get these equalities (3) and (4) by Theorem 5.4.3. □

5.5.3 Local form of Riemannian Curvature Tensor. For any point $p \in \widetilde{M}$ with a local chart $(U_p, [\varphi_p])$, we can also find a local form of \widetilde{R} in the next result.

Theorem 5.5.3 *Let $\widetilde{R} : \mathcal{X}(\widetilde{M}) \times \mathcal{X}(\widetilde{M}) \times \mathcal{X}(\widetilde{M}) \times \mathcal{X}(\widetilde{M}) \rightarrow C^\infty(\widetilde{M})$ be a combinatorial Riemannian curvature tensor. Then for $\forall p \in \widetilde{M}$ with a local chart $(U_p, [\varphi_p])$,*

$$\widetilde{R} = \widetilde{R}_{(\sigma\varsigma)(\eta\theta)(\mu\nu)(\kappa\lambda)} dx^{\sigma\varsigma} \otimes dx^{\eta\theta} \otimes dx^{\mu\nu} \otimes dx^{\kappa\lambda}$$

with

$$\begin{aligned} \widetilde{R}_{(\sigma\varsigma)(\eta\theta)(\mu\nu)(\kappa\lambda)} &= \frac{1}{2} \left(\frac{\partial^2 g_{(\mu\nu)(\sigma\varsigma)}}{\partial x^{\kappa\lambda} \partial x^{\eta\theta}} + \frac{\partial^2 g_{(\kappa\lambda)(\eta\theta)}}{\partial x^{\mu\nu} \partial x^{\sigma\varsigma}} - \frac{\partial^2 g_{(\mu\nu)(\eta\theta)}}{\partial x^{\kappa\lambda} \partial x^{\sigma\varsigma}} - \frac{\partial^2 g_{(\kappa\lambda)(\sigma\varsigma)}}{\partial x^{\mu\nu} \partial x^{\eta\theta}} \right) \\ &+ \Gamma_{(\mu\nu)(\sigma\varsigma)}^{\vartheta\iota} \Gamma_{(\kappa\lambda)(\eta\theta)}^{\xi\omicron} g_{(\xi\omicron)(\vartheta\iota)} - \Gamma_{(\mu\nu)(\eta\theta)}^{\xi\omicron} \Gamma_{(\kappa\lambda)(\sigma\varsigma)}^{\vartheta\iota} g_{(\xi\omicron)(\vartheta\iota)}, \end{aligned}$$

where $g_{(\mu\nu)(\kappa\lambda)} = g\left(\frac{\partial}{\partial x^{\mu\nu}}, \frac{\partial}{\partial x^{\kappa\lambda}}\right)$.

Proof Notice that

$$\begin{aligned} \widetilde{R}_{(\sigma\varsigma)(\eta\theta)(\mu\nu)(\kappa\lambda)} &= \widetilde{R}\left(\frac{\partial}{\partial x^{\sigma\varsigma}}, \frac{\partial}{\partial x^{\eta\theta}}, \frac{\partial}{\partial x^{\mu\nu}}, \frac{\partial}{\partial x^{\kappa\lambda}}\right) = \widetilde{R}\left(\frac{\partial}{\partial x^{\mu\nu}}, \frac{\partial}{\partial x^{\kappa\lambda}}, \frac{\partial}{\partial x^{\sigma\varsigma}}, \frac{\partial}{\partial x^{\eta\theta}}\right) \\ &= g\left(\widetilde{R}\left(\frac{\partial}{\partial x^{\sigma\varsigma}}, \frac{\partial}{\partial x^{\eta\theta}}\right) \frac{\partial}{\partial x^{\mu\nu}}, \frac{\partial}{\partial x^{\kappa\lambda}}\right) = \widetilde{R}_{(\mu\nu)(\sigma\varsigma)(\eta\theta)}^{\vartheta\iota} g_{(\vartheta\iota)(\kappa\lambda)} \end{aligned}$$

By definition and Theorem 5.5.1(3). Now we have know that (eqn.(5 – 5))

$$\frac{\partial g_{(\mu\nu)(\kappa\lambda)}}{\partial x^{\sigma\varsigma}} = \Gamma_{(\mu\nu)(\sigma\varsigma)}^{\eta\theta} g_{(\eta\theta)(\kappa\lambda)} + \Gamma_{(\kappa\lambda)(\sigma\varsigma)}^{\eta\theta} g_{(\mu\nu)(\eta\theta)}.$$

Applying Theorem 5.4.4, we get that

$$\begin{aligned} &\widetilde{R}_{(\sigma\varsigma)(\eta\theta)(\mu\nu)(\kappa\lambda)} \\ &= \left(\frac{\partial \Gamma_{(\sigma\varsigma)(\kappa\lambda)}^{\vartheta\iota}}{\partial x^{\mu\nu}} - \frac{\partial \Gamma_{(\sigma\varsigma)(\mu\nu)}^{\vartheta\iota}}{\partial x^{\kappa\lambda}} + \Gamma_{(\sigma\varsigma)(\kappa\lambda)}^{\xi\omicron} \Gamma_{(\xi\omicron)(\mu\nu)}^{\vartheta\iota} - \Gamma_{(\sigma\varsigma)(\mu\nu)}^{\xi\omicron} \Gamma_{(\xi\omicron)(\kappa\lambda)}^{\vartheta\iota} \right) g_{(\vartheta\iota)(\eta\theta)} \\ &= \frac{\partial}{\partial x^{\mu\nu}} (\Gamma_{(\sigma\varsigma)(\kappa\lambda)}^{\vartheta\iota} g_{(\vartheta\iota)(\eta\theta)}) - \Gamma_{(\sigma\varsigma)(\kappa\lambda)}^{\vartheta\iota} \frac{\partial g_{(\vartheta\iota)(\eta\theta)}}{\partial x^{\mu\nu}} - \frac{\partial}{\partial x^{\kappa\lambda}} (\Gamma_{(\sigma\varsigma)(\mu\nu)}^{\vartheta\iota} g_{(\vartheta\iota)(\eta\theta)}) \\ &+ \Gamma_{(\sigma\varsigma)(\mu\nu)}^{\vartheta\iota} \frac{\partial g_{(\vartheta\iota)(\eta\theta)}}{\partial x^{\kappa\lambda}} + \Gamma_{(\sigma\varsigma)(\kappa\lambda)}^{\xi\omicron} \Gamma_{(\xi\omicron)(\mu\nu)}^{\vartheta\iota} g_{(\vartheta\iota)(\kappa\lambda)} - \Gamma_{(\sigma\varsigma)(\mu\nu)}^{\xi\omicron} \Gamma_{(\xi\omicron)(\kappa\lambda)}^{\vartheta\iota} g_{(\vartheta\iota)(\eta\theta)} \\ &= \frac{\partial}{\partial x^{\mu\nu}} (\Gamma_{(\sigma\varsigma)(\kappa\lambda)}^{\vartheta\iota} g_{(\vartheta\iota)(\eta\theta)}) - \frac{\partial}{\partial x^{\kappa\lambda}} (\Gamma_{(\sigma\varsigma)(\mu\nu)}^{\vartheta\iota} g_{(\vartheta\iota)(\eta\theta)}) \end{aligned}$$

$$\begin{aligned}
 & + \Gamma_{(\sigma\varsigma)(\mu\nu)}^{\vartheta\iota} (\Gamma_{(\vartheta\iota)(\kappa\lambda)}^{\xi\omicron} g(\xi\omicron)(\eta\theta) + \Gamma_{(\eta\theta)(\kappa\lambda)}^{\xi\omicron} g(\vartheta\iota)(\xi\omicron)) + \Gamma_{(\sigma\varsigma)(\kappa\lambda)}^{\xi\omicron} \Gamma_{(\xi\omicron)(\mu\nu)}^{\vartheta\iota} g(\vartheta\iota)(\kappa\lambda) \\
 & - \Gamma_{(\sigma\varsigma)(\kappa\lambda)}^{\vartheta\iota} (\Gamma_{(\vartheta\iota)(\mu\nu)}^{\xi\omicron} g(\xi\omicron)(\eta\theta) + \Gamma_{(\eta\theta)(\mu\nu)}^{\xi\omicron} g(\vartheta\iota)(\xi\omicron)) - \Gamma_{(\sigma\varsigma)(\mu\nu)}^{\xi\omicron} \Gamma_{(\xi\omicron)(\kappa\lambda)}^{\vartheta\iota} g(\vartheta\iota)(\eta\theta) \\
 & = \frac{1}{2} \frac{\partial}{\partial x^{\mu\nu}} \left(\frac{\partial g(\sigma\varsigma)(\eta\theta)}{\partial x^{\kappa\lambda}} + \frac{\partial g(\kappa\lambda)(\eta\theta)}{\partial x^{\sigma\varsigma}} - \frac{\partial g(\sigma\varsigma)(\kappa\lambda)}{\partial x^{\eta\theta}} \right) + \Gamma_{(\sigma\varsigma)(\kappa\lambda)}^{\xi\omicron} \Gamma_{(\xi\omicron)(\mu\nu)}^{\vartheta\iota} g(\vartheta\iota)(\kappa\lambda) \\
 & - \frac{1}{2} \frac{\partial}{\partial x^{\kappa\lambda}} \left(\frac{\partial g(\sigma\varsigma)(\eta\theta)}{\partial x^{\mu\nu}} + \frac{\partial g(\mu\nu)(\eta\theta)}{\partial x^{\sigma\varsigma}} - \frac{\partial g(\sigma\varsigma)(\mu\nu)}{\partial x^{\eta\theta}} \right) - \Gamma_{(\sigma\varsigma)(\mu\nu)}^{\xi\omicron} \Gamma_{(\xi\omicron)(\kappa\lambda)}^{\vartheta\iota} g(\vartheta\iota)(\eta\theta) \\
 & = \frac{1}{2} \left(\frac{\partial^2 g(\mu\nu)(\sigma\varsigma)}{\partial x^{\kappa\lambda} \partial x^{\eta\theta}} + \frac{\partial^2 g(\kappa\lambda)(\eta\theta)}{\partial x^{\mu\nu} \partial x^{\sigma\varsigma}} - \frac{\partial^2 g(\mu\nu)(\eta\theta)}{\partial x^{\kappa\lambda} \partial x^{\sigma\varsigma}} - \frac{\partial^2 g(\kappa\lambda)(\sigma\varsigma)}{\partial x^{\mu\nu} \partial x^{\eta\theta}} \right) \\
 & + \Gamma_{(\sigma\varsigma)(\kappa\lambda)}^{\xi\omicron} \Gamma_{(\xi\omicron)(\mu\nu)}^{\vartheta\iota} g(\vartheta\iota)(\kappa\lambda) - \Gamma_{(\sigma\varsigma)(\mu\nu)}^{\xi\omicron} \Gamma_{(\xi\omicron)(\kappa\lambda)}^{\vartheta\iota} g(\vartheta\iota)(\eta\theta).
 \end{aligned}$$

This completes the proof. □

Combining Theorems 5.4.6, 5.5.1 and 5.5.3, we have the following consequence.

Corollary 5.5.1 *Let $\tilde{R}_{(\mu\nu)(\kappa\lambda)(\sigma\varsigma)(\eta\theta)}$ be a component of a combinatorial Riemannian curvature tensor \tilde{R} in a local chart $(U, [\varphi])$ of a combinatorial Riemannian manifold*

- (1) $\tilde{R}_{(\mu\nu)(\kappa\lambda)(\sigma\varsigma)(\eta\theta)} = -\tilde{R}_{(\kappa\lambda)(\mu\nu)(\sigma\varsigma)(\eta\theta)} = -\tilde{R}_{(\mu\nu)(\kappa\lambda)(\eta\theta)(\sigma\varsigma)}$;
- (2) $\tilde{R}_{(\mu\nu)(\kappa\lambda)(\sigma\varsigma)(\eta\theta)} = \tilde{R}_{(\sigma\varsigma)(\eta\theta)(\mu\nu)(\kappa\lambda)}$;
- (3) $\tilde{R}_{(\mu\nu)(\kappa\lambda)(\sigma\varsigma)(\eta\theta)} + \tilde{R}_{(\eta\theta)(\kappa\lambda)(\mu\nu)(\sigma\varsigma)} + \tilde{R}_{(\sigma\varsigma)(\kappa\lambda)(\eta\theta)(\mu\nu)} = 0$;
- (4) $\tilde{D}_{\vartheta\iota} \tilde{R}_{(\mu\nu)(\kappa\lambda)(\sigma\varsigma)(\eta\theta)} + \tilde{D}_{\sigma\varsigma} \tilde{R}_{(\mu\nu)(\kappa\lambda)(\eta\theta)(\vartheta\iota)} + \tilde{D}_{\eta\theta} \tilde{R}_{(\mu\nu)(\kappa\lambda)(\vartheta\iota)(\sigma\varsigma)} = 0$. □

§5.6 INTEGRATION ON COMBINATORIAL MANIFOLDS

5.6.1 Determining $\mathcal{H}_{\tilde{M}}(\mathbf{n}, \mathbf{m})$. Let $\tilde{M}(n_1, \dots, n_m)$ be a smoothly combinatorial manifold. Then there exists an atlas $\mathcal{C} = \{(\tilde{U}_\alpha, [\varphi_\alpha]) | \alpha \in \tilde{I}\}$ on $\tilde{M}(n_1, \dots, n_m)$ consisting of positively oriented charts such that for $\forall \alpha \in \tilde{I}$, $\tilde{s}(p) + \sum_{i=1}^{s(p)} (n_i - \tilde{s}(p))$ is an constant $n_{\tilde{U}_\alpha}$ for $\forall p \in \tilde{U}_\alpha$ ([Mao14]). The integer set $\mathcal{H}_{\tilde{M}}(n, m)$ is then defined by

$$\mathcal{H}_{\tilde{M}}(n, m) = \{n_{\tilde{U}_\alpha} | \alpha \in \tilde{I}\}.$$

Notice that $\tilde{M}(n_1, \dots, n_m)$ is smoothly. We know that $\mathcal{H}_{\tilde{M}}(n, m)$ is finite. This set is important to the definition of integral and the establishing of Stokes' or Gauss' theorems on smoothly combinatorial manifolds.

Applying the relation between the sets $\mathcal{H}(n_1, n_2, \dots, n_m)$ and $\mathcal{G}([0, n_m], [0, n_m])$ established in Theorem 4.2.4. We determine it under its vertex-edge labeled graph $G([0, n_m], [0, n_m])$.

Theorem 5.6.1 *Let \widetilde{M} be a smoothly combinatorial manifold with a correspondent vertex-edge labeled graph $G([0, n_m], [0, n_m])$. Then*

$$\begin{aligned} \mathcal{H}_{\widetilde{M}}(n, m) \subseteq & \{n_1, n_2, \dots, n_m\} \bigcup_{\widehat{d}(p) \geq 3, p \in \widetilde{M}} \{\widehat{d}(p) + \sum_{i=1}^{d(p)} (n_i - \widehat{d}(p))\} \\ & \bigcup \{\tau_1(u) + \tau_1(v) - \tau_2(u, v) | \forall (u, v) \in E(G([0, n_m], [0, n_m]))\}. \end{aligned}$$

Particularly, if $G([0, n_m], [0, n_m])$ is K_3 -free, then

$$\begin{aligned} \mathcal{H}_{\widetilde{M}}(n, m) = & \{\tau_1(u) | u \in V(G([0, n_m], [0, n_m]))\} \\ & \bigcup \{\tau_1(u) + \tau_1(v) - \tau_2(u, v) | \forall (u, v) \in E(G([0, n_m], [0, n_m]))\}. \end{aligned}$$

Proof Notice that the dimension of a point $p \in \widetilde{M}$ is

$$n_p = \widehat{d}(p) + \sum_{i=1}^{d(p)} (n_i - \widehat{d}(p))$$

by definition. If $d(p) = 1$, then $n_p = n_j, 1 \leq j \leq m$. If $d(p) = 2$, namely, $p \in M^{n_i} \cap M^{n_j}$ for $1 \leq i, j \leq m$, we know that its dimension is

$$n_i + n_j - \widehat{d}(p) = \tau_1(M^{n_i}) + \tau_1(M^{n_j}) - \widehat{d}(p).$$

Whence, we get that

$$\begin{aligned} \mathcal{H}_{\widetilde{M}}(n, m) \subseteq & \{n_1, n_2, \dots, n_m\} \bigcup_{\widehat{d}(p) \geq 3, p \in \widetilde{M}} \{\widehat{d}(p) + \sum_{i=1}^{d(p)} (n_i - \widehat{d}(p))\} \\ & \bigcup \{\tau_1(u) + \tau_1(v) - \tau_2(u, v) | \forall (u, v) \in E(G([0, n_m], [0, n_m]))\}. \end{aligned}$$

Now if $G([0, n_m], [0, n_m])$ is K_3 -free, then there are no points with intersectional dimension ≥ 3 . In this case, there are really existing points $p \in M^{n_i}$ for any integer $i, 1 \leq i \leq m$ and $q \in M^{n_i} \cap M^{n_j}$ for $1 \leq i, j \leq m$ by definition. Therefore, we get that

$$\begin{aligned} \mathcal{H}_{\widetilde{M}}(n, m) = & \{\tau_1(u) | u \in V(G([0, n_m], [0, n_m]))\} \\ & \bigcup \{\tau_1(u) + \tau_1(v) - \tau_2(u, v) | \forall (u, v) \in E(G([0, n_m], [0, n_m]))\}. \quad \square \end{aligned}$$

For some special graphs, we get the following interesting results for the integer set $\mathcal{H}_{\widetilde{M}}(n, m)$.

Corollary 5.6.1 *Let \widetilde{M} be a smoothly combinatorial manifold with a correspondent vertex-edge labeled graph $G([0, n_m], [0, n_m])$. If $G([0, n_m], [0, n_m]) \cong P^s$, then*

$$\mathcal{H}_{\widetilde{M}}(n, m) = \{\tau_1(u_i), 1 \leq i \leq p\} \cup \{\tau_1(u_i) + \tau_1(u_{i+1}) - \tau_2(u_i, u_{i+1}) | 1 \leq i \leq p - 1\}$$

and if $G([0, n_m], [0, n_m]) \cong C^p$ with $p \geq 4$, then

$$\mathcal{H}_{\widetilde{M}}(n, m) = \{\tau_1(u_i), 1 \leq i \leq p\} \cup \{\tau_1(u_i) + \tau_1(u_{i+1}) - \tau_2(u_i, u_{i+1}) | 1 \leq i \leq p, i \equiv (\text{mod } p)\}.$$

5.6.2 Partition of Unity. A *partition of unity* on a combinatorial manifold \widetilde{M} is defined following.

Definition 5.6.1 *Let \widetilde{M} be a smoothly combinatorial manifold and $\omega \in \Lambda(\widetilde{M})$. A support set $\text{Supp}\omega$ of ω is defined by*

$$\text{Supp}\omega = \overline{\{p \in \widetilde{M}; \omega(p) \neq 0\}}$$

and say ω has compact support if $\text{Supp}\omega$ is compact in \widetilde{M} . A collection of subsets $\{C_i | i \in \widetilde{I}\}$ of \widetilde{M} is called *locally finite* if for each $p \in \widetilde{M}$, there is a neighborhood U_p of p such that $U_p \cap C_i = \emptyset$ except for finitely many indices i .

Definition 5.6.2 *A partition of unity on a combinatorial manifold \widetilde{M} is a collection $\{(U_i, g_i) | i \in \widetilde{I}\}$, where*

- (1) $\{U_i | i \in \widetilde{I}\}$ is a locally finite open covering of \widetilde{M} ;
- (2) $g_i \in \mathcal{X}(\widetilde{M})$, $g_i(p) \geq 0$ for $\forall p \in \widetilde{M}$ and $\text{supp}g_i \in U_i$ for $i \in \widetilde{I}$;
- (3) for $p \in \widetilde{M}$, $\sum_i g_i(p) = 1$.

For a smoothly combinatorial manifold \widetilde{M} , denoted by $G^L[\widetilde{M}]$ the underlying graph of its correspondent vertex-edge labeled graph. We get the next result for a partition of unity on smoothly combinatorial manifolds.

Theorem 5.6.2 *Let \widetilde{M} be a smoothly combinatorial manifold. Then \widetilde{M} admits partitions of unity.*

Proof For $\forall M \in V(G^L[\widetilde{M}])$, since \widetilde{M} is smooth we know that M is a smoothly submanifold of \widetilde{M} . As a byproduct, there is a partition of unity $\{(U_M^\alpha, g_M^\alpha) | \alpha \in I_M\}$

on M with conditions following hold.

- (1) $\{U_M^\alpha | \alpha \in I_M\}$ is a locally finite open covering of M ;
- (2) $g_M^\alpha(p) \geq 0$ for $\forall p \in M$ and $\text{supp} g_M^\alpha \in U_M^\alpha$ for $\alpha \in I_M$;
- (3) For $p \in M$, $\sum_i g_M^i(p) = 1$.

By definition, for $\forall p \in \widetilde{M}$, there is a local chart $(U_p, [\varphi_p])$ enable $\varphi_p : U_p \rightarrow B^{n_{i_1}} \cup B^{n_{i_2}} \cup \dots \cup B^{n_{i_s(p)}}$ with $B^{n_{i_1}} \cap B^{n_{i_2}} \cap \dots \cap B^{n_{i_s(p)}} \neq \emptyset$. Now let $U_{M_{i_1}}^\alpha, U_{M_{i_2}}^\alpha, \dots, U_{M_{i_s(p)}}^\alpha$ be $s(p)$ open sets on manifolds $M, M \in V(G^L[\widetilde{M}])$ such that

$$p \in U_p^\alpha = \bigcup_{h=1}^{s(p)} U_{M_{i_h}}^\alpha. \quad (5-8)$$

We define

$$\widetilde{S}(p) = \{U_p^\alpha | \text{all integers } \alpha \text{ enabling (5-8) hold}\}.$$

Then

$$\widetilde{\mathcal{A}} = \bigcup_{p \in \widetilde{M}} \widetilde{S}(p) = \{U_p^\alpha | \alpha \in \widetilde{I}(p)\}$$

is locally finite covering of the combinatorial manifold \widetilde{M} by properties (1) – (3). For $\forall U_p^\alpha \in \widetilde{S}(p)$, define

$$\sigma_{U_p^\alpha} = \sum_{s \geq 1} \sum_{\{i_1, i_2, \dots, i_s\} \subset \{1, 2, \dots, s(p)\}} \left(\prod_{h=1}^s g_{M_{i_h}}^\alpha \right)$$

and

$$g_{U_p^\alpha} = \frac{\sigma_{U_p^\alpha}}{\sum_{\widetilde{V} \in \widetilde{S}(p)} \sigma_{\widetilde{V}}}.$$

Then it can be checked immediately that $\{(U_p^\alpha, g_{U_p^\alpha}) | p \in \widetilde{M}, \alpha \in \widetilde{I}(p)\}$ is a partition of unity on \widetilde{M} by properties (1)-(3) on g_M^α and the definition of $g_{U_p^\alpha}$. □

Corollary 5.6.2 *Let \widetilde{M} be a smoothly combinatorial manifold with an atlas $\widetilde{\mathcal{A}} = \{(V_\alpha, [\varphi_\alpha]) | \alpha \in \widetilde{I}\}$ and t_α be a C^k tensor field, $k \geq 1$, of field type (r, s) defined on V_α for each α , and assume that there exists a partition of unity $\{(U_i, g_i) | i \in J\}$*

subordinate to $\tilde{\mathcal{A}}$, i.e., for $\forall i \in J$, there exists $\alpha(i)$ such that $U_i \subset V_{\alpha(i)}$. Then for $\forall p \in \tilde{M}$,

$$t(p) = \sum_i g_i t_{\alpha(i)}$$

is a C^k tensor field of type (r, s) on \tilde{M}

Proof Since $\{U_i | i \in J\}$ is locally finite, the sum at each point p is a finite sum and $t(p)$ is a type (r, s) for every $p \in \tilde{M}$. Notice that t is C^k since the local form of t in a local chart $(V_{\alpha(i)}, [\varphi_{\alpha(i)}])$ is

$$\sum_j g_i t_{\alpha(j)},$$

where the summation taken over all indices j such that $V_{\alpha(i)} \cap V_{\alpha(j)} \neq \emptyset$. Those number j is finite by the local finiteness. \square

5.6.3 Integration on Combinatorial Manifold. First, we introduce integration on combinatorial Euclidean spaces. Let $\tilde{\mathbf{R}}(n_1, \dots, n_m)$ be a combinatorial Euclidean space and

$$\tau : \tilde{\mathbf{R}}(n_1, \dots, n_m) \rightarrow \tilde{\mathbf{R}}(n_1, \dots, n_m)$$

a C^1 differential mapping with

$$[\bar{y}] = [y^{\kappa\lambda}]_{m \times n_m} = [\tau^{\kappa\lambda}([x^{\mu\nu}))]_{m \times n_m}.$$

The *Jacobi matrix* of f is defined by

$$\frac{\partial[\bar{y}]}{\partial[\bar{x}]} = [A_{(\kappa\lambda)(\mu\nu)}],$$

where $A_{(\kappa\lambda)(\mu\nu)} = \frac{\partial \tau^{\kappa\lambda}}{\partial x^{\mu\nu}}$.

Now let $\omega \in T_k^0(\tilde{\mathbf{R}}(n_1, \dots, n_m))$, a pull-back $\tau^* \omega \in T_k^0(\tilde{\mathbf{R}}(n_1, \dots, n_m))$ is defined by

$$\tau^* \omega(a_1, a_2, \dots, a_k) = \omega(f(a_1), f(a_2), \dots, f(a_k))$$

for $\forall a_1, a_2, \dots, a_k \in \tilde{\mathbf{R}}$.

Denoted by $n = \widehat{m} + \sum_{i=1}^m (n_i - \widehat{m})$. If $0 \leq l \leq n$, recall([4]) that the basis of $\Lambda^l(\widetilde{\mathbf{R}}(n_1, \dots, n_m))$ is

$$\{\mathbf{e}^{i_1} \wedge \mathbf{e}^{i_2} \wedge \dots \wedge \mathbf{e}^{i_l} | 1 \leq i_1 < i_2 < \dots < i_l \leq n\}$$

for a basis $\mathbf{e}_1, \mathbf{e}_2, \dots, \mathbf{e}_n$ of $\widetilde{\mathbf{R}}(n_1, \dots, n_m)$ and its dual basis $\mathbf{e}^1, \mathbf{e}^2, \dots, \mathbf{e}^n$. Thereby the dimension of $\Lambda^l(\widetilde{\mathbf{R}}(n_1, \dots, n_m))$ is

$$\binom{n}{l} = \frac{(\widehat{m} + \sum_{i=1}^m (n_i - \widehat{m}))!}{l!(\widehat{m} + \sum_{i=1}^m (n_i - \widehat{m}) - l)!}$$

Whence $\Lambda^n(\widetilde{\mathbf{R}}(n_1, \dots, n_m))$ is one-dimensional. Now if ω_0 is a basis of $\Lambda^n(\widetilde{R})$, we then know that its each element ω can be represented by $\omega = c\omega_0$ for a number $c \in \mathbf{R}$. Let $\tau : \widetilde{\mathbf{R}}(n_1, \dots, n_m) \rightarrow \widetilde{\mathbf{R}}(n_1, \dots, n_m)$ be a linear mapping. Then

$$\tau^* : \Lambda^n(\widetilde{\mathbf{R}}(n_1, \dots, n_m)) \rightarrow \Lambda^n(\widetilde{\mathbf{R}}(n_1, \dots, n_m))$$

is also a linear mapping with $\tau^*\omega = c\tau^*\omega_0 = b\omega$ for a unique constant $b = \det\tau$, called the determinant of τ . It has been known that ([AbM1])

$$\det\tau = \det\left(\frac{\partial[\overline{y}]}{\partial[\overline{x}]}\right)$$

for a given basis $\mathbf{e}_1, \mathbf{e}_2, \dots, \mathbf{e}_n$ of $\widetilde{\mathbf{R}}(n_1, \dots, n_m)$ and its dual basis $\mathbf{e}^1, \mathbf{e}^2, \dots, \mathbf{e}^n$.

Definition 5.6.3 Let $\widetilde{\mathbf{R}}(n_1, n_2, \dots, n_m)$ be a combinatorial Euclidean space, $n = \widehat{m} + \sum_{i=1}^m (n_i - \widehat{m})$, $\widetilde{U} \subset \widetilde{\mathbf{R}}(n_1, n_2, \dots, n_m)$ and $\omega \in \Lambda^n(U)$ have compact support with

$$\omega(x) = \omega_{(\mu_{i_1} \nu_{i_1}) \dots (\mu_{i_n} \nu_{i_n})} dx^{\mu_{i_1} \nu_{i_1}} \wedge \dots \wedge dx^{\mu_{i_n} \nu_{i_n}}$$

relative to the standard basis $\mathbf{e}^{\mu\nu}$, $1 \leq \mu \leq m, 1 \leq \nu \leq n_m$ of $\widetilde{\mathbf{R}}(n_1, n_2, \dots, n_m)$ with $\mathbf{e}^{\mu\nu} = \mathbf{e}^\nu$ for $1 \leq \mu \leq \widehat{m}$. An integral of ω on \widetilde{U} is defined to be a mapping $\int_{\widetilde{U}} : f \rightarrow \int_{\widetilde{U}} f \in \mathbf{R}$ with

$$\int_{\widetilde{U}} \omega = \int \omega(x) \prod_{\nu=1}^{\widehat{m}} dx^\nu \prod_{\mu \geq \widehat{m}+1, 1 \leq \nu \leq n_i} dx^{\mu\nu}, \quad (5-9)$$

where the right hand side of (5-9) is the Riemannian integral of ω on \widetilde{U} .

For example, consider the combinatorial Euclidean space $\widetilde{\mathbf{R}}(3, 5)$ with $\mathbf{R}^3 \cap \mathbf{R}^5 = \mathbf{R}$. Then the integration of an $\omega \in \Lambda^7(\widetilde{U})$ for an open subset $\widetilde{U} \in \widetilde{\mathbf{R}}(3, 5)$ is

$$\int_{\widetilde{U}} \omega = \int_{\widetilde{U} \cap (\mathbf{R}^3 \cup \mathbf{R}^5)} \omega(x) dx^1 dx^{12} dx^{13} dx^{22} dx^{23} dx^{24} dx^{25}.$$

Theorem 5.6.3 *Let U and V be open subsets of $\widetilde{\mathbf{R}}(n_1, \dots, n_m)$ and $\tau : U \rightarrow V$ is an orientation-preserving diffeomorphism. If $\omega \in \Lambda^n(V)$ has a compact support for $n = \widehat{m} + \sum_{i=1}^m (n_i - \widehat{m})$, then $\tau^* \omega \in \Lambda^n(U)$ has compact support and*

$$\int \tau^* \omega = \int \omega.$$

Proof Let $\omega(x) = \omega_{(\mu_{i_1} \nu_{i_1}) \dots (\mu_{i_n} \nu_{i_n})} dx^{\mu_{i_1} \nu_{i_1}} \wedge \dots \wedge dx^{\mu_{i_n} \nu_{i_n}} \in \Lambda^n(V)$. Since τ is a diffeomorphism, the support of $\tau^* \omega$ is $\tau^{-1}(\text{supp } \omega)$, which is compact by that of $\text{supp } \omega$ compact.

By the usual change of variables formula, since $\tau^* \omega = (\omega \circ \tau)(\det \tau) \omega_0$ by definition, where $\omega_0 = dx^1 \wedge \dots \wedge dx^{\widehat{m}} \wedge dx^{1(\widehat{m}+1)} \wedge dx^{1(\widehat{m}+2)} \wedge \dots \wedge dx^{1n_1} \wedge \dots \wedge dx^{mn_m}$, we then get that

$$\begin{aligned} \int \tau^* \omega &= \int (\omega \circ \tau)(\det \tau) \prod_{\nu=1}^{\widehat{m}} dx^\nu \prod_{\mu \geq \widehat{m}+1, 1 \leq \nu \leq n_\mu} dx^{\mu\nu} \\ &= \int \omega. \end{aligned}$$

□

Definition 5.6.4 *Let \widetilde{M} be a smoothly combinatorial manifold. If there exists a family $\{(U_\alpha, [\varphi_\alpha] | \alpha \in \widetilde{I})\}$ of local charts such that*

- (1) $\bigcup_{\alpha \in \widetilde{I}} U_\alpha = \widetilde{M}$;
- (2) for $\forall \alpha, \beta \in \widetilde{I}$, either $U_\alpha \cap U_\beta = \emptyset$ or $U_\alpha \cap U_\beta \neq \emptyset$ but for $\forall p \in U_\alpha \cap U_\beta$, the Jacobi matrix

$$\det \left(\frac{\partial[\varphi_\beta]}{\partial[\varphi_\alpha]} \right) > 0,$$

then \widetilde{M} is called an oriently combinatorial manifold and $(U_\alpha, [\varphi_\alpha])$ an oriented chart for $\forall \alpha \in \widetilde{I}$.

Now for any integer $\tilde{n} \in \mathcal{H}_{\tilde{M}}(n, m)$, we can define an integral of \tilde{n} -forms on a smoothly combinatorial manifold $\tilde{M}(n_1, \dots, n_m)$.

Definition 5.6.5 Let \tilde{M} be a smoothly combinatorial manifold with orientation \mathcal{O} and $(\tilde{U}; [\varphi])$ a positively oriented chart with a constant $n_{\tilde{U}} \in \mathcal{H}_{\tilde{M}}(n, m)$. Suppose $\omega \in \Lambda^{\tilde{n}}(\tilde{M}), \tilde{U} \subset \tilde{M}$ has compact support $\tilde{C} \subset \tilde{U}$. Then define

$$\int_{\tilde{C}} \omega = \int \varphi_*(\omega|_{\tilde{U}}). \quad (5 - 10)$$

Now if $\mathcal{C}_{\tilde{M}}$ is an atlas of positively oriented charts with an integer set $\mathcal{H}_{\tilde{M}}(n, m)$, let $\tilde{P} = \{(\tilde{U}_\alpha, \varphi_\alpha, g_\alpha) | \alpha \in \tilde{I}\}$ be a partition of unity subordinate to $\mathcal{C}_{\tilde{M}}$. For $\forall \omega \in \Lambda^{\tilde{n}}(\tilde{M}), \tilde{n} \in \mathcal{H}_{\tilde{M}}(n, m)$, an integral of ω on \tilde{P} is defined by

$$\int_{\tilde{P}} \omega = \sum_{\alpha \in \tilde{I}} \int g_\alpha \omega. \quad (5 - 11)$$

The following result shows that the integral of \tilde{n} -forms for $\forall \tilde{n} \in \mathcal{H}_{\tilde{M}}(n, m)$ is well-defined.

Theorem 5.6.4 Let $\tilde{M}(n_1, \dots, n_m)$ be a smoothly combinatorial manifold. For $\tilde{n} \in \mathcal{H}_{\tilde{M}}(n, m)$, the integral of \tilde{n} -forms on $\tilde{M}(n_1, \dots, n_m)$ is well-defined, namely, the sum on the right hand side of (4.4) contains only a finite number of nonzero terms, not dependent on the choice of $\mathcal{C}_{\tilde{M}}$ and if P and Q are two partitions of unity subordinate to $\mathcal{C}_{\tilde{M}}$, then

$$\int_{\tilde{P}} \omega = \int_{\tilde{Q}} \omega.$$

Proof By definition for any point $p \in \tilde{M}(n_1, \dots, n_m)$, there is a neighborhood \tilde{U}_p such that only a finite number of g_α are nonzero on \tilde{U}_p . Now by the compactness of $\text{supp} \omega$, only a finite number of such neighborhood cover $\text{supp} \omega$. Therefore, only a finite number of g_α are nonzero on the union of these \tilde{U}_p , namely, the sum on the right hand side of (5 - 11) contains only a finite number of nonzero terms.

Notice that the integral of \tilde{n} -forms on a smoothly combinatorial manifold $\tilde{M}(n_1, \dots, n_m)$ is well-defined for a local chart \tilde{U} with a constant $n_{\tilde{U}} = \hat{s}(p) + \sum_{i=1}^{s(p)} (n_i - \hat{s}(p))$ for $\forall p \in \tilde{U} \subset \tilde{M}(n_1, \dots, n_m)$ by (5 - 10) and Definition 5.6.3. Whence each term on the right hand side of (5 - 11) is well-defined. Thereby $\int_{\tilde{P}} \omega$ is well-defined.

Now let $\tilde{P} = \{(\tilde{U}_\alpha, \varphi_\alpha, g_\alpha) | \alpha \in \tilde{I}\}$ and $\tilde{Q} = \{(\tilde{V}_\beta, \varphi_\beta, h_\beta) | \beta \in \tilde{J}\}$ be partitions of unity subordinate to atlas $\tilde{\mathcal{C}}_{\tilde{M}}$ and $\tilde{\mathcal{C}}_{\tilde{M}}^*$ with respective integer sets $\tilde{\mathcal{H}}_{\tilde{M}}(n, m)$ and $\tilde{\mathcal{H}}_{\tilde{M}}^*(n, m)$. Then these functions $\{g_\alpha h_\beta\}$ satisfy $g_\alpha h_\beta(p) = 0$ except only for a finite number of index pairs (α, β) and

$$\sum_\alpha \sum_\beta g_\alpha h_\beta(p) = 1, \quad \text{for } \forall p \in \tilde{M}(n_1, \dots, n_m).$$

Since $\sum_\beta = 1$, we then get that

$$\int_{\tilde{P}} = \sum_\alpha \int g_\alpha \omega = \sum_\beta \sum_\alpha \int h_\beta g_\alpha \omega = \sum_\alpha \sum_\beta \int g_\alpha h_\beta \omega = \int_{\tilde{Q}} \omega.$$

□

By the relation of smoothly combinatorial manifolds with these vertex-edge labeled graphs established in Theorem 4.2.4, we can also get the integration on a vertex-edge labeled graph $G([0, n_m], [0, n_m])$ by viewing it that of the correspondent smoothly combinatorial manifold \tilde{M} with $\Lambda^l(G) = \Lambda^l(\tilde{M})$, $\mathcal{H}_G(n, m) = \mathcal{H}_{\tilde{M}}(n, m)$, namely define the *integral of an \tilde{n} -form ω on $G([0, n_m], [0, n_m])$ for $\tilde{n} \in \mathcal{H}_G(n, m)$* by

$$\int_{G([0, n_m], [0, n_m])} \omega = \int_{\tilde{M}} \omega.$$

Then each integration result on a combinatorial manifold can be restated by combinatorial words, such as Theorem 5.7.1 and its corollaries in the next section.

Now let n_1, n_2, \dots, n_m be a positive integer sequence. For any point $p \in \tilde{M}$, if there is a local chart $(\tilde{U}_p, [\varphi_p])$ such that $[\varphi_p] : U_p \rightarrow B^{n_1} \cup B^{n_2} \cup \dots \cup B^{n_m}$ with $\dim(B^{n_1} \cap B^{n_2} \cap \dots \cap B^{n_m}) = \hat{m}$, then \tilde{M} is called a *homogenously combinatorial manifold* with $n(\tilde{M}) = \hat{m} + \sum_{i=1}^m (n_i - \hat{m})$. Particularly, if $m = 1$, a homogenously combinatorial manifold is nothing but a manifold. We then get consequences for the integral of $n(\tilde{M})$ -forms on homogenously combinatorial manifolds.

Corollary 5.6.3 *The integral of $(\hat{m} + \sum_{i=1}^m (n_i - \hat{m}))$ -forms on a homogenously combinatorial manifold $\tilde{M}(n_1, n_2, \dots, n_m)$ is well-defined, particularly, the integral of n -forms on an n -manifold is well-defined.*

Similar to Theorem 5.6.3 for the *change of variables formula of integral* in a combinatorial Euclidean space, we get that of formula in smoothly combinatorial manifolds.

Theorem 5.6.5 *Let $\widetilde{M}(n_1, n_2, \dots, n_m)$ and $\widetilde{N}(k_1, k_2, \dots, k_l)$ be oriently combinatorial manifolds and $\tau : \widetilde{M} \rightarrow \widetilde{N}$ an orientation-preserving diffeomorphism. If $\omega \in \Lambda^{\widetilde{k}}(\widetilde{N})$, $\widetilde{k} \in \mathcal{H}_{\widetilde{N}}(k, l)$ has compact support, then $\tau^*\omega$ has compact support and*

$$\int \omega = \int \tau^*\omega.$$

Proof Notice that $\text{supp}\tau^*\omega = \tau^{-1}(\text{supp}\omega)$. Thereby $\tau^*\omega$ has compact support since ω has so. Now let $\{(U_i, \varphi_i) | i \in \widetilde{I}\}$ be an atlas of positively oriented charts of \widetilde{M} and $\widetilde{P} = \{g_i | i \in \widetilde{I}\}$ a subordinate partition of unity with an integer set $\mathcal{H}_{\widetilde{M}}(n, m)$. Then $\{(\tau(U_i), \varphi_i \circ \tau^{-1}) | i \in \widetilde{I}\}$ is an atlas of positively oriented charts of \widetilde{N} and $\widetilde{Q} = \{g_i \circ \tau^{-1}\}$ is a partition of unity subordinate to the covering $\{\tau(U_i) | i \in \widetilde{I}\}$ with an integer set $\mathcal{H}_{\tau(\widetilde{M})}(k, l)$. Whence, we get that

$$\begin{aligned} \int \tau^*\omega &= \sum_i \int g_i \tau^*\omega = \sum_i \int \varphi_{i*}(g_i \tau^*\omega) \\ &= \sum_i \int \varphi_{i*}(\tau^{-1})_*(g_i \circ \tau^{-1})\omega \\ &= \sum_i \int (\varphi_i \circ \tau^{-1})_*(g_i \circ \tau^{-1})\omega \\ &= \int \omega. \end{aligned}$$

□

§5.7 COMBINATORIAL STOKES' AND GAUSS' THEOREMS

5.7.1 Combinatorial Stokes' Theorem. We establish the revised Stokes' theorem for combinatorial manifolds, namely, the Stokes' is still valid for \widetilde{n} -forms on smoothly combinatorial manifolds \widetilde{M} if $\widetilde{n} \in \mathcal{H}_{\widetilde{M}}(n, m)$, where $\mathcal{H}_{\widetilde{M}}(n, m)$.

Definition 5.7.1 *Let \widetilde{M} be a smoothly combinatorial manifold. A subset \widetilde{D} of \widetilde{M} is with boundary if its points can be classified into two classes following.*

Class 1 (interior point $\text{Int}\tilde{D}$) For $\forall p \in \text{Int}\tilde{D}$, there is a neighborhood \tilde{V}_p of p enable $\tilde{V}_p \subset \tilde{D}$.

Case 2 (boundary $\partial\tilde{D}$) For $\forall p \in \partial\tilde{D}$, there is integers μ, ν for a local chart $(U_p; [\varphi_p])$ of p such that $x^{\mu\nu}(p) = 0$ but

$$\tilde{U}_p \cap \tilde{D} = \{q \mid q \in U_p, x^{\kappa\lambda} \geq 0 \text{ for } \forall \{\kappa, \lambda\} \neq \{\mu, \nu\}\}.$$

Then we generalize the famous Stokes' theorem on manifolds to smoothly combinatorial manifolds in the next.

Theorem 5.7.1 Let \tilde{M} be a smoothly combinatorial manifold with an integer set $\mathcal{H}_{\tilde{M}}(n, m)$ and \tilde{D} a boundary subset of \tilde{M} . For $\forall \tilde{n} \in \mathcal{H}_{\tilde{M}}(n, m)$ if $\omega \in \Lambda^{\tilde{n}}(\tilde{M})$ has a compact support, then

$$\int_{\tilde{D}} \tilde{d}\omega = \int_{\partial\tilde{D}} \omega$$

with the convention $\int_{\partial\tilde{D}} \omega = 0$, while $\partial\tilde{D} = \emptyset$.

Proof By Definition 5.6.5, the integration on a smoothly combinatorial manifold was constructed with partitions of unity subordinate to an atlas. Let $\mathcal{C}_{\tilde{M}}$ be an atlas of positively oriented charts with an integer set $\mathcal{H}_{\tilde{M}}(n, m)$ and $\tilde{P} = \{(\tilde{U}_\alpha, \varphi_\alpha, g_\alpha) \mid \alpha \in \tilde{I}\}$ a partition of unity subordinate to $\mathcal{C}_{\tilde{M}}$. Since $\text{supp}\omega$ is compact, we know that

$$\begin{aligned} \int_{\tilde{D}} \tilde{d}\omega &= \sum_{\alpha \in \tilde{I}} \int_{\tilde{D}} \tilde{d}(g_\alpha \omega), \\ \int_{\partial\tilde{D}} \omega &= \sum_{\alpha \in \tilde{I}} \int_{\partial\tilde{D}} g_\alpha \omega. \end{aligned}$$

and there are only finite nonzero terms on the right hand side of the above two formulae. Thereby, we only need to prove

$$\int_{\tilde{D}} \tilde{d}(g_\alpha \omega) = \int_{\partial\tilde{D}} g_\alpha \omega$$

for $\forall \alpha \in \tilde{I}$.

Not loss of generality we can assume that ω is an \tilde{n} -forms on a local chart $(\tilde{U}, [\varphi])$ with a compact support for $\tilde{n} \in \mathcal{H}_{\tilde{M}}(n, m)$. Now write

$$\omega = \sum_{h=1}^{\tilde{n}} (-1)^{h-1} \omega_{\mu_{i_h} \nu_{i_h}} dx^{\mu_{i_1} \nu_{i_1}} \wedge \cdots \wedge \widehat{dx^{\mu_{i_h} \nu_{i_h}}} \wedge \cdots \wedge dx^{\mu_{i_{\tilde{n}}} \nu_{i_{\tilde{n}}}},$$

where $\widehat{dx^{\mu_{i_h} \nu_{i_h}}}$ means that $dx^{\mu_{i_h} \nu_{i_h}}$ is deleted, where

$$i_h \in \{1, \dots, \widehat{n}_U, (1(\widehat{n}_U + 1)), \dots, (1n_1), (2(\widehat{n}_U + 1)), \dots, (2n_2), \dots, (mn_m)\}.$$

Then

$$\tilde{d}\omega = \sum_{h=1}^{\tilde{n}} \frac{\partial \omega_{\mu_{i_h} \nu_{i_h}}}{\partial x^{\mu_{i_h} \nu_{i_h}}} dx^{\mu_{i_1} \nu_{i_1}} \wedge \cdots \wedge dx^{\mu_{i_{\tilde{n}}} \nu_{i_{\tilde{n}}}}. \quad (5-12)$$

Consider the appearance of neighborhood \tilde{U} . There are two cases must be considered.

Case 1 $\tilde{U} \cap \partial \tilde{D} = \emptyset$

In this case, $\int_{\partial \tilde{D}} \omega = 0$ and \tilde{U} is in $\tilde{M} \setminus \tilde{D}$ or in $\mathbf{Int} \tilde{D}$. The former is naturally implies that $\int_{\tilde{D}} \tilde{d}(g_\alpha \omega) = 0$. For the later, we find that

$$\int_{\tilde{D}} \tilde{d}\omega = \sum_{h=1}^{\tilde{n}} \int_{\tilde{U}} \frac{\partial \omega_{\mu_{i_h} \nu_{i_h}}}{\partial x^{\mu_{i_h} \nu_{i_h}}} dx^{\mu_{i_1} \nu_{i_1}} \cdots dx^{\mu_{i_{\tilde{n}}} \nu_{i_{\tilde{n}}}}. \quad (5-13)$$

Notice that $\int_{-\infty}^{+\infty} \frac{\partial \omega_{\mu_{i_h} \nu_{i_h}}}{\partial x^{\mu_{i_h} \nu_{i_h}}} dx^{\mu_{i_h} \nu_{i_h}} = 0$ since $\omega_{\mu_{i_h} \nu_{i_h}}$ has compact support. Thus $\int_{\tilde{D}} \tilde{d}\omega = 0$ as desired.

Case 2 $\tilde{U} \cap \partial \tilde{D} \neq \emptyset$

In this case we can do the same trick for each term except the last. Without loss of generality, assume that

$$\tilde{U} \cap \tilde{D} = \{q | q \in U, x^{\mu_{i_{\tilde{n}}} \nu_{i_{\tilde{n}}}}(q) \geq 0\}$$

and

$$\tilde{U} \cap \partial \tilde{D} = \{q | q \in U, x^{\mu_{i_{\tilde{n}}} \nu_{i_{\tilde{n}}}}(q) = 0\}.$$

Then we get that

$$\begin{aligned} \int_{\partial \tilde{D}} \omega &= \int_{U \cap \partial \tilde{D}} \omega \\ &= \sum_{h=1}^{\tilde{n}} (-1)^{h-1} \int_{U \cap \partial \tilde{D}} \omega_{\mu_{i_h} \nu_{i_h}} dx^{\mu_{i_1} \nu_{i_1}} \wedge \cdots \wedge \widehat{dx^{\mu_{i_h} \nu_{i_h}}} \wedge \cdots \wedge dx^{\mu_{i_{\tilde{n}}} \nu_{i_{\tilde{n}}}} \\ &= (-1)^{\tilde{n}-1} \int_{U \cap \partial \tilde{D}} \omega_{\mu_{i_{\tilde{n}}} \nu_{i_{\tilde{n}}}} dx^{\mu_{i_1} \nu_{i_1}} \wedge \cdots \wedge dx^{\mu_{i_{\tilde{n}-1}} \nu_{i_{\tilde{n}-1}}} \end{aligned}$$

since $dx^{\mu_{i_{\tilde{n}}} \nu_{i_{\tilde{n}}}}(q) = 0$ for $q \in \tilde{U} \cap \partial \tilde{D}$. Notice that $\mathbf{R}^{\tilde{n}-1} = \partial \mathbf{R}_+^{\tilde{n}}$ but the usual orientation on $\mathbf{R}^{\tilde{n}-1}$ is not the boundary orientation, whose outward unit normal is $-\mathbf{e}_{\tilde{n}} = (0, \dots, 0, -1)$. Hence

$$\int_{\partial \tilde{D}} \omega = - \int_{\partial \mathbf{R}_+^{\tilde{n}}} \omega_{\mu_{i_{\tilde{n}}} \nu_{i_{\tilde{n}}}}(x^{\mu_{i_1} \nu_{i_1}}, \dots, x^{\mu_{i_{\tilde{n}-1}} \nu_{i_{\tilde{n}-1}}}, 0) dx^{\mu_{i_1} \nu_{i_1}} \cdots dx^{\mu_{i_{\tilde{n}-1}} \nu_{i_{\tilde{n}-1}}}.$$

On the other hand, by the fundamental theorem of calculus,

$$\begin{aligned} \int_{\mathbf{R}^{\tilde{n}-1}} \left(\int_0^\infty \frac{\partial \omega_{\mu_{i_{\tilde{n}}} \nu_{i_{\tilde{n}}}}}{\partial x^{\mu_{i_{\tilde{n}}} \nu_{i_{\tilde{n}}}}} dx^{\mu_{i_{\tilde{n}}} \nu_{i_{\tilde{n}}}} \right) dx^{\mu_{i_1} \nu_{i_1}} \cdots dx^{\mu_{i_{\tilde{n}-1}} \nu_{i_{\tilde{n}-1}}} \\ = - \int_{\mathbf{R}^{\tilde{n}-1}} \omega_{\mu_{i_{\tilde{n}}} \nu_{i_{\tilde{n}}}}(x^{\mu_{i_1} \nu_{i_1}}, \dots, x^{\mu_{i_{\tilde{n}-1}} \nu_{i_{\tilde{n}-1}}}, 0) dx^{\mu_{i_1} \nu_{i_1}} \cdots dx^{\mu_{i_{\tilde{n}-1}} \nu_{i_{\tilde{n}-1}}}. \end{aligned}$$

Since $\omega_{\mu_{i_{\tilde{n}}} \nu_{i_{\tilde{n}}}}$ has a compact support, thus

$$\int_U \omega = - \int_{\mathbf{R}^{\tilde{n}-1}} \omega_{\mu_{i_{\tilde{n}}} \nu_{i_{\tilde{n}}}}(x^{\mu_{i_1} \nu_{i_1}}, \dots, x^{\mu_{i_{\tilde{n}-1}} \nu_{i_{\tilde{n}-1}}}, 0) dx^{\mu_{i_1} \nu_{i_1}} \cdots dx^{\mu_{i_{\tilde{n}-1}} \nu_{i_{\tilde{n}-1}}}.$$

Therefore, we get that

$$\int_{\tilde{D}} \tilde{d}\omega = \int_{\partial \tilde{D}} \omega$$

This completes the proof. □

Corollaries following are immediately obtained by Theorem 5.7.1.

Corollary 5.7.1 *Let \tilde{M} be a homogeneously combinatorial manifold with an integer set $\mathcal{H}_{\tilde{M}}(n, m)$ and \tilde{D} a boundary subset of \tilde{M} . For $\tilde{n} \in \mathcal{H}_{\tilde{M}}(n, m)$ if $\omega \in \Lambda^{\tilde{n}}(\tilde{M})$ has a compact support, then*

$$\int_{\tilde{D}} \tilde{d}\omega = \int_{\partial\tilde{D}} \omega,$$

particularly, if \tilde{M} is nothing but a manifold, the Stokes' theorem holds.

Corollary 5.7.2 *Let \tilde{M} be a smoothly combinatorial manifold with an integer set $\mathcal{H}_{\tilde{M}}(n, m)$. For $\tilde{n} \in \mathcal{H}_{\tilde{M}}(n, m)$, if $\omega \in \Lambda^{\tilde{n}}(\tilde{M})$ has a compact support, then*

$$\int_{\tilde{M}} \omega = 0.$$

By the definition of integration on vertex-edge labeled graphs $G([0, n_m], [0, n_m])$, let a boundary subset of $G([0, n_m], [0, n_m])$ mean that of its correspondent combinatorial manifold \tilde{M} . Theorem 5.7.1 and Corollary 5.7.2 then can be restated by a combinatorial manner as follows.

Theorem 5.7.2 *Let $G([0, n_m], [0, n_m])$ be a vertex-edge labeled graph with an integer set $\mathcal{H}_G(n, m)$ and \tilde{D} a boundary subset of $G([0, n_m], [0, n_m])$. For $\forall \tilde{n} \in \mathcal{H}_G(n, m)$ if $\omega \in \Lambda^{\tilde{n}}(G([0, n_m], [0, n_m]))$ has a compact support, then*

$$\int_{\tilde{D}} \tilde{d}\omega = \int_{\partial\tilde{D}} \omega$$

with the convention $\int_{\partial\tilde{D}} \omega = 0$, while $\partial\tilde{D} = \emptyset$.

Corollary 5.7.3 *Let $G([0, n_m], [0, n_m])$ be a vertex-edge labeled graph with an integer set $\mathcal{H}_G(n, m)$. For $\forall \tilde{n} \in \mathcal{H}_G(n, m)$ if $\omega \in \Lambda^{\tilde{n}}(G([0, n_m], [0, n_m]))$ has a compact support, then*

$$\int_{G([0, n_m], [0, n_m])} \omega = 0.$$

Choose $\tilde{M} = \mathbf{R}^n$ in Theorem 5.7.1 or Corollary 5.7.1. Then we get these well known results in classical calculus shown in the following examples.

Example 5.7.1 Let D be a domain in \mathbf{R}^2 with boundary. We have know the *Green's formula*

$$\int_D \left(\frac{\partial A}{\partial x_1} - \frac{\partial B}{\partial x_2} \right) dx_1 dx_2 = \int_{\partial D} A dx_1 + B dx_2$$

in calculus. Let $\omega = A dx_1 + B dx_2 \in \Lambda_0^1(\mathbf{R}^2)$. Then we know that

$$\tilde{d}\omega = \left(\frac{\partial A}{\partial x_1} - \frac{\partial B}{\partial x_2}\right)dx_1 \wedge dx_2.$$

Whence, the *Green's formula* is nothing but a special case of the Stokes' formula

$$\int_{\tilde{D}} \tilde{d}\omega = \int_{\partial\tilde{D}} \omega$$

with $\tilde{D} = D$.

Example 5.7.2 Let S be a surface in \mathbf{R}^3 with boundary such that ∂S a smoothly simple curve with a direction. We have know the *classical Stokes's formula*

$$\begin{aligned} & \int_{\partial S} Adx_1 + Bdx_2 + Cdx_3 \\ &= \int_S \left(\frac{\partial C}{\partial x_2} - \frac{\partial B}{\partial x_3}\right)dx_2dx_3 + \left(\frac{\partial A}{\partial x_3} - \frac{\partial C}{\partial x_1}\right)dx_3dx_1 + \left(\frac{\partial C}{\partial x_1} - \frac{\partial A}{\partial x_2}\right)dx_1dx_2. \end{aligned}$$

Now let $\omega = Adx_1 + Bdx_2 + Cdx_3 \in \Lambda_0^1(\mathbf{R}^3)$. Then we know that

$$d\omega = \left(\frac{\partial C}{\partial x_2} - \frac{\partial B}{\partial x_3}\right)dx_2 \wedge dx_3 + \left(\frac{\partial A}{\partial x_3} - \frac{\partial C}{\partial x_1}\right)dx_3 \wedge dx_1 + \left(\frac{\partial C}{\partial x_1} - \frac{\partial A}{\partial x_2}\right)dx_1 \wedge dx_2.$$

Whence, the *classical Stokes' formula* is a special case of the formula

$$\int_{\tilde{D}} \tilde{d}\omega = \int_{\partial\tilde{D}} \omega$$

in Theorem 5.7.1 with $\tilde{D} = S$.

5.7.2 Combinatorial Gauss' Theorem. Let D be a domain in \mathbf{R}^3 with boundary and a positive direction determined by its normal vector \mathbf{n} . The *Gauss' formula* claims that in calculus

$$\int_{\partial D} Adx_2dx_3 + Bdx_3dx_1 + Cdx_1dx_2 = \int_D \left(\frac{\partial A}{\partial x_1} + \frac{\partial B}{\partial x_2} + \frac{\partial C}{\partial x_3}\right)dx_1dx_2dx_3.$$

Wether can we generalize it to smoothly combinatorial manifolds? The answer is YES. First, we need the following conceptions.

Definition 5.7.2 If $X, Y \in \mathcal{X}^k(\tilde{M})$, $k \geq 1$, define the Lie derivative $L_X Y$ of Y with respect X by $L_X Y = [X, Y]$.

By definition, we know that the Lie derivative forms a *Lie algebra* following.

Theorem 5.7.3 *The Lie derivative $L_X Y = [X, Y]$ on $\mathcal{X}(\widetilde{M})$ forms a Lie algebra, i.e.,*

- (i) $[\cdot, \cdot]$ is **R**-bilinear;
- (ii) $[X, X] = 0$ for all $X \in \mathcal{X}(\widetilde{M})$;
- (iii) $[X, [Y, Z]] + [Y, [Z, X]] + [Z, [X, Y]] = 0$ for all $X, Y, Z \in \mathcal{X}(\widetilde{M})$.

Proof These brackets $[X, Y]$ forms a Lie algebra can be immediately gotten by Theorem 5.1.2 and its definition. \square

Now we find the local expression for $[X, Y]$. For $p \in \widetilde{M}$, let $(U_p, [\varphi]_p)$ with $[\varphi]_p : U_p \rightarrow \widetilde{\mathbf{R}}(n_1(p), \dots, n_{s(p)}(p))$ be a local chart of p and $\widetilde{X}, \widetilde{Y}$ the local representatives of X, Y . According to Theorem 5.7.3, the local representative of $[X, Y]$ is $[\widetilde{X}, \widetilde{Y}]$. Whence,

$$\begin{aligned} [\widetilde{X}, \widetilde{Y}][\widehat{f}](\overline{x}) &= \widetilde{X}[\widetilde{Y}[\widehat{f}]](\overline{x}) - \widetilde{Y}[\widetilde{X}[\widehat{f}]](\overline{x}) \\ &= D(\widetilde{Y}[\widehat{f}])(\overline{x}) \cdot \widetilde{X}(\overline{x}) - D(\widetilde{X}[\widehat{f}])(\overline{x}) \cdot \widetilde{Y}(\overline{x}) \end{aligned}$$

for $\widehat{f} \in \mathcal{X}_p(\widetilde{M})$. Now $\widetilde{Y}[\widehat{f}](\overline{x}) = D\widehat{f}(\overline{x}) \cdot \widetilde{Y}(\overline{x})$ and maybe calculated by the chain ruler. Notice that the terms involving the second derivative of \widehat{f} cancel by the symmetry of $D^2\widehat{f}(\overline{x})$. We are left with

$$D\widehat{f}(\overline{x}) \cdot (D\widetilde{Y}(\overline{x}) \cdot \widetilde{X}(\overline{x}) - D\widetilde{X}(\overline{x}) \cdot \widetilde{Y}(\overline{x})),$$

which implies that the local representative of $[X, Y]$ is $D\widetilde{Y} \cdot \widetilde{X} - D\widetilde{X} \cdot \widetilde{Y}$. Applying Theorem 5.1.3, if $[\varphi]_p$ gives local coordinates $[x_{ij}]_{s(p) \times n_{s(p)}}$, then

$$[X, Y]_{ij} = X_{\mu\nu} \frac{\partial Y_{ij}}{\partial x_{\mu\nu}} - Y_{\mu\nu} \frac{\partial X_{ij}}{\partial x_{\mu\nu}}.$$

Particularly, if \widetilde{M} is a differentiable n -manifold, i.e., $m = 1$ in $\widetilde{M}(n_1, \dots, n_m)$, then these can be simplified to

$$[X, Y]_i = X_\mu \frac{\partial Y_i}{\partial x_\mu} - Y_\mu \frac{\partial X_i}{\partial x_\mu}$$

just with one variable index and if $Y = f \in \Lambda^0(\widetilde{M})$, then $L_X f = [X, f] = \widetilde{d}f$.

Definition 5.7.3 For $X_1, \dots, X_k \in \mathcal{X}(\widetilde{M})$, $\omega \in \Lambda^{k+1}(\widetilde{M})$, define $i_X \omega \in \Lambda^k(\widetilde{M})$ by

$$i_X \omega(X_1, \dots, X_k) = \omega(X, X_1, \dots, X_k).$$

Then we have the following result.

Theorem 5.7.4 For integers $k, l \geq 0$, if $\omega \in \Lambda^k(\widetilde{M})$, $\varpi \in \Lambda^l(\widetilde{M})$, then

(i) $i_X(\omega \wedge \varpi) = (i_X \omega) \wedge \varpi + (-1)^k \omega \wedge i_X \varpi;$

(ii) $L_X \omega = i_X d\omega + di_X \omega.$

Proof By definition, we know that $i_X \omega \in \Lambda^{k-1}(\widetilde{M})$. For $\bar{u} = \bar{u}_1, \bar{u}_2, \dots, \bar{u}_{k+l}$,

$$i_X(\omega \wedge \varpi)(\bar{u}_2, \dots, \bar{u}_{k+l}) = \omega \wedge \varpi(\bar{u}_1, \bar{u}_2, \dots, \bar{u}_{k+l})$$

and

$$\begin{aligned} (i_X \omega) \wedge \varpi + (-1)^k \omega \wedge i_X \varpi &= \frac{(k+l-1)!}{(k-1)!l!} \mathbf{A}(i_X \omega \otimes \varpi) \\ &\quad + (-1)^k \frac{k+l-1}{k!(l-1)!} \mathbf{A}(\omega \otimes i_X \varpi) \end{aligned}$$

by Definition 5.2.2. Let

$$\sigma_0 = \begin{pmatrix} 2 & 3 & \dots & k+1 & 1 & k+2 & \dots & k+l \\ 1 & 2 & \dots & k & k+1 & k+2 & \dots & k+l \end{pmatrix}.$$

Then we know that each permutation in the summation of $\mathbf{A}(\omega \otimes i_X \varpi)$ can be written as $\sigma \sigma_0$ with $\text{sign} \sigma_0 = (-1)^k$. Whence,

$$(-1)^k \frac{(k+l-1)!}{k!(l-1)!} \mathbf{A}(\omega \otimes i_X \varpi) = \frac{(k+l-1)!}{k!(l-1)!} \mathbf{A}(i_X \omega \otimes \varpi).$$

We finally get that

$$\begin{aligned} (i_X \omega) \wedge \varpi + (-1)^k \omega \wedge i_X \varpi &= \left(\frac{(k+l-1)!}{(k-1)!l!} + \frac{k+l-1}{k!(l-1)!} \right) \mathbf{A}(i_X \omega \otimes \varpi) \\ &= \frac{(k+l)!}{k!l!} \mathbf{A}(i_X \omega \otimes \varpi) = i_X(\omega \wedge \varpi). \end{aligned}$$

This is the assertion (i). The proof for (ii) is proceed by induction on k . If $k = 0$, let $f \in \Lambda^0(\widetilde{M})$. By definition, we know that

$$L_X f = \tilde{d}f = i_X \tilde{d}f.$$

Now assume it holds for an integer l . Then a $(l+1)$ -form may be written as $\tilde{d}f \wedge \omega$. Notice that $L_X(\tilde{d}f \wedge \omega) = L_X \tilde{d}f \wedge \omega + \tilde{d}f \wedge L_X \omega$ since we can check L_X is a tensor derivation by definition. Applying (i), we know that

$$\begin{aligned} i_X \tilde{d}(\tilde{d}f \wedge \omega) + \tilde{d}i_X(\tilde{d}f \wedge \omega) &= -i_X(\tilde{d}f \wedge \tilde{d}\omega) + \tilde{d}(i_X \tilde{d}f \wedge \omega - \tilde{d}f \wedge i_X \omega) \\ &= -i_X \tilde{d}f \wedge \tilde{d}\omega + \tilde{d}f \wedge i_X \tilde{d}\omega \\ &\quad + \tilde{d}i_X \tilde{d}f \wedge \omega + i_X \tilde{d}f \wedge \omega + \tilde{d}f \wedge \tilde{d}i_X \omega \\ &= \tilde{d}f \wedge L_X \omega + \tilde{d}L_X f \wedge \omega \end{aligned}$$

by the induction assumption. Notice that $\tilde{d}L_X f = L_X \tilde{d}f$, we get the result. \square

Definition 5.7.4 A volume form on a smoothly combinatorial manifold is an \tilde{n} -form ω in $\Lambda^{\tilde{n}}$ for some integers $\tilde{n} \in \mathcal{H}_{\tilde{M}}(n, m)$ such that $\omega(p) \neq \bar{0}$ for all $p \in \tilde{M}$. If X is a vector field on \tilde{M} , the unique function $\operatorname{div}_\omega X$ determined by $L_X \omega = (\operatorname{div} X)_\omega$ is called the divergence of X and incompressible if $\operatorname{div}_\omega X = \bar{0}$.

Then we know the generalized Gauss' theorem on smoothly combinatorial manifolds following.

Theorem 5.7.5 Let \tilde{M} be a smoothly combinatorial manifold with an integer set $\mathcal{H}_{\tilde{M}}(n, m)$, \tilde{D} a boundary subset of \tilde{M} and X a vector field on \tilde{M} with a compact support. Then

$$\int_{\tilde{D}} (\operatorname{div} X) \mathbf{v} = \int_{\partial \tilde{D}} \mathbf{i}_X \mathbf{v},$$

where \mathbf{v} is a volume form on \tilde{M} , i.e., nonzero elements in $\Lambda^{\tilde{n}}(\tilde{M})$ for $\tilde{n} \in \mathcal{H}_{\tilde{M}}(n, m)$.

Proof This result is also a consequence of Theorem 5.7.1. Notice that by Theorem 5.7.4, we know that

$$(\operatorname{div} X) \mathbf{v} = \tilde{d} \mathbf{i}_X \mathbf{v} + \mathbf{i}_X \tilde{d} \mathbf{v} = \tilde{d} \mathbf{i}_X \mathbf{v}.$$

Whence, we get that

$$\int_{\tilde{D}} (\operatorname{div} X) \mathbf{v} = \int_{\partial \tilde{D}} \mathbf{i}_X \mathbf{v}.$$

by Theorem 5.7.1. □

Then the Gauss' theorem in \mathbf{R}^3 is generalized on smoothly combinatorial manifolds in the following.

Theorem 5.7.6 *Let (\tilde{M}, g) be a homogeneously combinatorial Riemannian manifold carrying a outward-pointing unit normal $\mathbf{n}_{\partial \tilde{M}}$ along $\partial \tilde{M}$ and X a vector field on (\tilde{M}, g) with a compact support. Then*

$$\int_{\tilde{M}} (\operatorname{div} X) \tilde{d}\mathbf{v}_{\tilde{M}} = \int_{\partial \tilde{M}} \langle X, \mathbf{n}_{\partial \tilde{M}} \rangle \tilde{d}\mathbf{v}_{\partial \tilde{M}},$$

where \mathbf{v} and $\mathbf{v}_{\partial \tilde{M}}$ are volume form on \tilde{M} , i.e., nonzero elements in $\Lambda^{n(\tilde{M})}(\tilde{M})$, and $\langle X, \mathbf{n}_{\partial \tilde{M}} \rangle$ the inner product of matrixes X and $\mathbf{n}_{\partial \tilde{M}}$.

Proof Let $\mathbf{v}_{\partial \tilde{M}}$ be the volume element on $\partial \tilde{M}$ induced by the Riemannian volume element $\mathbf{v}_{\tilde{M}} \in \Lambda^{n(\tilde{M})}(\tilde{M})$, i.e., for any positively oriented basis $\bar{v}_1, \dots, \bar{v}_{n(\tilde{M})-1} \in T_p(\partial \tilde{M})$, we have that

$$\mathbf{v}_{\partial \tilde{M}}(x)(\bar{v}_1, \dots, \bar{v}_{n(\tilde{M})-1}) = \mathbf{v}_{\tilde{M}}\left(-\frac{\partial}{\partial x_{n(\tilde{M})}}, \bar{v}_1, \dots, \bar{v}_{n(\tilde{M})-1}\right).$$

Now since

$$\begin{aligned} (i_X \mathbf{v}_{\tilde{M}})(x)(\bar{v}_1, \dots, \bar{v}_{n(\tilde{M})-1}) &= \mathbf{v}_{\tilde{M}(x)}(X_i(x) \mathbf{v}_i - X_{n(\tilde{M})}(x) \frac{\partial}{\partial x_{n(\tilde{M})}}, \bar{v}_1, \dots, \bar{v}_{n(\tilde{M})-1}) \\ &= X_{n(\tilde{M})}(x) \mathbf{v}_{\partial \tilde{M}}(x)(\bar{v}_1, \dots, \bar{v}_{n(\tilde{M})-1}) \end{aligned}$$

and $X_{n(\tilde{M})} = \langle X, \mathbf{n}_{\partial \tilde{M}} \rangle$, we get this result by Theorem 5.7.5. □

Particularly, if $m = 1$ in $\tilde{M}(n_1, \dots, n_m)$, i.e., a manifold, we know the following.

Corollary 5.7.4 *Let (M, g) be a Riemannian n -manifold with a outward-pointing unit normal $\mathbf{n}_{\partial M}$ along ∂M and X a vector field on it with a compact support. Then*

$$\int_M (\operatorname{div} X) d\mathbf{v}_M = \int_{\partial M} \langle X, \mathbf{n}_{\partial M} \rangle d\mathbf{v}_{\partial M},$$

where \mathbf{v} and $\mathbf{v}_{\partial M}$ are volume form on M .

§5.8 COMBINATORIAL FINSLER GEOMETRY

5.8.1 Combinatorial Minkowskian Norm. A *Minkowskian norm* on a vector space V is defined in the following definition, which can be also generalized to smoothly combinatorial manifolds.

Definition 5.8.1 A *Minkowskian norm* on a vector space V is a function $F : V \rightarrow \mathbf{R}$ such that

- (1) F is smooth on $V \setminus \{0\}$ and $F(v) \geq 0$ for $\forall v \in V$;
- (2) F is 1-homogenous, i.e., $F(\lambda v) = \lambda F(v)$ for $\forall \lambda > 0$;
- (3) for all $y \in V \setminus \{0\}$, the symmetric bilinear form $g_y : V \times V \rightarrow \mathbf{R}$ with

$$g_y(u, v) = \sum_{i,j} \frac{\partial^2 F(y)}{\partial y^i \partial y^j}$$

is positive definite for $u, v \in V$.

Denoted by $T\widetilde{M} = \bigcup_{p \in \widetilde{M}} T_p\widetilde{M}$.

5.8.2 Combinatorial Finsler Geometry. A combinatorial Finsler geometries on a Minkowskian norm is defined on $T\widetilde{M}$ following.

Definition 5.8.2 A *combinatorial Finsler geometry* is a smoothly combinatorial manifold \widetilde{M} endowed with a Minkowskian norm \widetilde{F} on $T\widetilde{M}$, denoted by $(\widetilde{M}; \widetilde{F})$.

Then we get the following result.

Theorem 5.8.1 *There are combinatorial Finsler geometries.*

Proof Let $\widetilde{M}(n_1, n_2, \dots, n_m)$ be a smoothly combinatorial manifold. We construct Minkowskian norms on $T\widetilde{M}(n_1, n_2, \dots, n_m)$. Let $\mathbf{R}^{n_1+n_2+\dots+n_m}$ be a Euclidean space. Then there exists a Minkowskian norm $F(\overline{x}) = |\overline{x}|$ in $\mathbf{R}^{n_1+n_2+\dots+n_m}$ at least, in here $|\overline{x}|$ denotes the Euclidean norm on $\mathbf{R}^{n_1+n_2+\dots+n_m}$. According to Theorem 5.1.3, $T_p\widetilde{M}(n_1, n_2, \dots, n_m)$ is homeomorphic to $\mathbf{R}^{\widehat{s}(p)-s(p)\widehat{s}(p)+n_{i_1}+\dots+n_{i_{s(p)}}$. Whence there are Minkowskian norms on $T_p\widetilde{M}(n_1, n_2, \dots, n_m)$ for $p \in U_p$, where $(U_p; [\varphi_p])$ is a local chart.

Notice that the number of manifolds are finite in a smoothly combinatorial manifold $\widetilde{M}(n_1, n_2, \dots, n_m)$ and each manifold has a finite cover $\{(U_\alpha; \varphi_\alpha) | \alpha \in I\}$, where I is a finite index set. We know that there is a finite cover

$$\bigcup_{M \in V(G^L[\widetilde{M}(n_1, n_2, \dots, n_m)])} \{(U_{M\alpha}; \varphi_{M\alpha}) | \alpha \in I_M\}.$$

By the decomposition theorem for unit, we know that there are smooth functions $h_{M\alpha}, \alpha \in I_M$ such that

$$\sum_{M \in V(G^L[\widetilde{M}(n_1, n_2, \dots, n_m)])} \sum_{\alpha \in I_M} h_{M\alpha} = 1 \quad \text{with } 0 \leq h_{M\alpha} \leq 1.$$

Now we choose a Minkowskian norm $\widetilde{F}^{M\alpha}$ on $T_p M_\alpha$ for $\forall p \in U_{M\alpha}$. Define

$$\widetilde{F}_{M\alpha} = \begin{cases} h^{M\alpha} \widetilde{F}^{M\alpha}, & \text{if } p \in U_{M\alpha}, \\ 0, & \text{if } p \notin U_{M\alpha} \end{cases}$$

for $\forall p \in \widetilde{M}$. Now let

$$\widetilde{F} = \sum_{M \in V(G^L[\widetilde{M}(n_1, n_2, \dots, n_m)])} \sum_{\alpha \in I} \widetilde{F}_{M\alpha}.$$

Then \widetilde{F} is a Minkowskian norm on $T\widetilde{M}(n_1, n_2, \dots, n_m)$ since it can be checked immediately that all conditions (1) – (3) in Definition 5.8.1 hold. □

5.8.3 Geometrical Inclusion. For the relation of combinatorial Finsler geometries with these Smarandache multi-spaces, we obtain the next consequence.

Theorem 5.8.2 *A combinatorial Finsler geometry $(\widetilde{M}(n_1, n_2, \dots, n_m); \widetilde{F})$ is a Smarandache geometry if $m \geq 2$.*

Proof Notice that if $m \geq 2$, then $\widetilde{M}(n_1, n_2, \dots, n_m)$ is combined by at least two manifolds M^{n_1} and M^{n_2} with $n_1 \neq n_2$. By definition, we know that

$$M^{n_1} \setminus M^{n_2} \neq \emptyset \text{ and } M^{n_2} \setminus M^{n_1} \neq \emptyset.$$

Now the axiom *there is an integer n such that there exists a neighborhood homeomorphic to a open ball B^n for any point in this space* is Smarandachely denied, since for points in $M^{n_1} \setminus M^{n_2}$, each has a neighborhood homeomorphic to B^{n_1} , but each point in $M^{n_2} \setminus M^{n_1}$ has a neighborhood homeomorphic to B^{n_2} . □

Theorems 5.8.1 and 5.8.2 imply inclusions in Smarandache multi-spaces for classical geometries in the following.

Corollary 5.8.1 *There are inclusions among Smarandache multi-spaces, Finsler geometry, Riemannian geometry and Weyl geometry:*

$$\begin{aligned} \{\text{Smarandache geometries}\} &\supset \{\text{combinatorial Finsler geometries}\} \\ &\supset \{\text{Finsler geometry}\} \text{ and } \{\text{combinatorial Riemannian geometries}\} \\ &\supset \{\text{Riemannian geometry}\} \supset \{\text{Weyl geometry}\}. \end{aligned}$$

Proof Let $m = 1$. Then a combinatorial Finsler geometry $(\widetilde{M}(n_1, n_2, \dots, n_m); \widetilde{F})$ is nothing but just a Finsler geometry. Applying Theorems 5.8.1 and 5.8.2 to this special case, we get these inclusions as expected. \square

Corollary 5.8.2 *There are inclusions among Smarandache geometries, combinatorial Riemannian geometries and Kähler geometry.*

$$\begin{aligned} \{\text{Smarandache geometries}\} &\supset \{\text{combinatorial Riemannian geometries}\} \\ &\supset \{\text{Riemannian geometry}\} \\ &\supset \{\text{Kähler geometry}\}. \end{aligned}$$

Proof Let $m = 1$ in a combinatorial manifold $\widetilde{M}(n_1, n_2, \dots, n_m)$ and applies Theorems 5.3.4 and 5.8.2, we get inclusions

$$\begin{aligned} \{\text{Smarandache geometries}\} &\supset \{\text{combinatorial Riemannian geometries}\} \\ &\supset \{\text{Riemannian geometry}\}. \end{aligned}$$

For the Kähler geometry, notice that any complex manifold M_c^n is equal to a smoothly real manifold M^{2n} with a natural base $\{\frac{\partial}{\partial x^i}, \frac{\partial}{\partial y^i}\}$ for $T_p M_c^n$ at each point $p \in M_c^n$. Whence, we get

$$\{\text{Riemannian geometry}\} \supset \{\text{Kähler geometry}\}.$$

\square

§5.9 REMARKS

5.9.1 Combinatorial Speculation. This chapter is essentially an application of the combinatorial notion in Section 2.1 of Chapter 2 to differential geometry.

Materials in this chapter are mainly extract from references [Mao11]-[Mao15] and [Mao18], also combined with fundamental results in classical differential geometry, particularly, the Riemannian geometry.

5.9.2 D-dimensional holes For these closed 2-manifolds S , it is well-known that

$$\chi(S) = \begin{cases} 2 - 2p(S), & \text{if } S \text{ is orientable,} \\ 2 - q(S). & \text{if } S \text{ is non-orientable.} \end{cases}$$

with $p(S)$ or $q(S)$ the orientable genus or non-orientable genus of S , namely 2-dimensional holes adjacent to S . For general case of n -manifolds M , we know that

$$\chi(M) = \sum_{k=0}^{\infty} (-1)^k \dim H_k(M),$$

where $\dim H_k(M)$ is the rank of these k -dimensional homology groups $H_k(M)$ in M , namely the number of k -dimensional holes adjacent to the manifold M . By the definition of combinatorial manifolds, some k -dimensional holes adjacent to a combinatorial manifold are increased. Then *what is the relation between the Euler-Poincaré characteristic of a combinatorial manifold \widetilde{M} and the i -dimensional holes adjacent to \widetilde{M} ? Wether can we find a formula likewise the Euler-Poincaré formula?* Calculation shows that even for the case of $n = 2$, the situation is complex. For example, choose n different orientable 2-manifolds S_1, S_2, \dots, S_n and let them intersects one after another at n different points in \mathbf{R}^3 . We get a combinatorial manifold \widetilde{M} . Calculation shows that

$$\chi(\widetilde{M}) = (\chi(S_1) + \chi(S_2) + \dots + \chi(S_n)) - n$$

by Theorem 4.2.9. But it only increases one 2-holes. *What is the relation of 2-dimensional holes adjacent to \widetilde{M} ?*

5.9.3 Local properties Although a finitely combinatorial manifold \widetilde{M} is not homogenous in general, namely the dimension of local charts of two points in \widetilde{M} maybe different, we have still constructed global operators such as those of exterior differentiation \widetilde{d} and connection \widetilde{D} on $T_s^* \widetilde{M}$. A operator $\widetilde{\mathfrak{D}}$ is said to be *local* on a subset $W \subset T_s^* \widetilde{M}$ if for any local chart $(U_p, [\varphi_p])$ of a point $p \in W$,

$$\widetilde{\mathfrak{D}}|_{U_p}(W) = \widetilde{\mathfrak{D}}(W)_{U_p}.$$

Of course, nearly all existent operators with local properties on $T_s^r \widetilde{M}$ in Finsler or Riemannian geometries can be reconstructed in these combinatorial Finsler or Riemannian geometries and find the local forms similar to those in Finsler or Riemannian geometries.

5.9.4 Global properties To find global properties on manifolds is a central task in classical differential geometry. The same is true for combinatorial manifolds. In classical geometry on manifolds, some global results, such as those of *de Rham* theorem and *Atiyah-Singer* index theorem, ..., etc. are well-known. Remember that the p^{th} de Rham cohomology group on a manifold M and the *index* $\text{Ind}\mathcal{D}$ of a *Fredholm* operator $\mathcal{D} : H^k(M, E) \rightarrow L^2(M, F)$ are defined to be a quotient space

$$H^p(M) = \frac{\text{Ker}(d : \Lambda^p(M) \rightarrow \Lambda^{p+1}(M))}{\text{Im}(d : \Lambda^{p-1}(M) \rightarrow \Lambda^p(M))}$$

and an integer

$$\text{Ind}\mathcal{D} = \dim \text{Ker}(\mathcal{D}) - \dim \left(\frac{L^2(M, F)}{\text{Im}\mathcal{D}} \right)$$

respectively. The de Rham theorem and the Atiyah-Singer index theorem respectively conclude that

for any manifold M , a mapping $\varphi : \Lambda^p(M) \rightarrow \text{Hom}(\Pi_p(M), \mathbf{R})$ induces a natural isomorphism $\varphi^* : H^p(M) \rightarrow H^n(M; \mathbf{R})$ of cohomology groups, where $\Pi_p(M)$ is the free Abelian group generated by the set of all p -simplexes in M

and

$$\text{Ind}\mathcal{D} = \text{Ind}_T(\sigma(\mathcal{D})),$$

where $\sigma(\mathcal{D}) : T^*M \rightarrow \text{Hom}(E, F)$ and $\text{Ind}_T(\sigma(\mathcal{D}))$ is the topological index of $\sigma(\mathcal{D})$. Now the questions for these finitely combinatorial manifolds are given in the following.

(1) Is the de Rham theorem and Atiyah-Singer index theorem still true for finitely combinatorial manifolds? If not, what is its modified forms?

(2) Check other global results for manifolds whether true or get their new modified forms for finitely combinatorial manifolds.

5.9.5 Combinatorial Gauss-Bonnet Theorem. We have know the Gauss-Bonnet formula in the final section of Chapter 3. Then *what is its counterpart in combinatorial differential geometry? Particularly, wether can we generalize the Gauss-Binnet-Chern result*

$$\int_{M^{2p}} \Omega = \chi(M^{2p})$$

for an oriently compact Riemannian manifold (M^{2p}, g) , where

$$\Omega = \frac{(-1)^p}{2^{2p}\pi^p p!} \sum_{i_1, i_2, \dots, i_{2p}} \delta_{1, \dots, 2p}^{i_1, \dots, i_{2p}} \Omega_{i_1 i_2} \wedge \dots \wedge \Omega_{i_{2p-1} i_{2p}},$$

and Ω_{i_j} is the curvature form under the natural chart $\{e_i\}$ of M^{2p} and

$$\delta_{1, \dots, 2p}^{i_1, \dots, i_{2p}} = \begin{cases} 1, & \text{if permutation } i_1 \dots i_{2p} \text{ is even,} \\ -1, & \text{if permutation } i_1 \dots i_{2p} \text{ is odd,} \\ 0, & \text{otherwise.} \end{cases}$$

to combinatorial Riemannian manifolds $(\tilde{M}, g, \tilde{D})$ such that

$$\int_{M^{2\tilde{n}}} \tilde{\Omega} = \chi(M^{2\tilde{n}})$$

with

$$\tilde{\Omega} = \frac{(-1)^{\tilde{n}}}{2^{2\tilde{n}}\pi^{\tilde{n}}\tilde{n}!} \sum_{i_1, i_2, \dots, i_{2\tilde{n}}} \delta_{1, \dots, 2\tilde{n}}^{i_1, \dots, i_{2\tilde{n}}} \Omega_{(i_1 j_1)(\mu_2 \nu_2)} \wedge \dots \wedge \Omega_{(i_{2\tilde{n}-1} j_{2\tilde{n}-1})(\mu_{2\tilde{n}} \nu_{2\tilde{n}})},$$

$$\delta_{1, \dots, 2p}^{i_1, \dots, i_{2p}} = \begin{cases} 1, & \text{if permutation } (i_1 j_1) \dots (i_{2\tilde{n}} j_{2\tilde{n}}) \text{ is even,} \\ -1, & \text{if permutation } (i_1 j_1) \dots (i_{2\tilde{n}} j_{2\tilde{n}}) \text{ is odd,} \\ 0, & \text{otherwise.} \end{cases}$$

for some integers $\tilde{n} \in \mathcal{H}_{\tilde{M}}(n, m)$?

CHAPTER 6.

Combinatorial Riemannian Submanifolds with Principal Fibre Bundles

For the limitation of human beings, one can only observe parts of the WORLD. Even so, the Whitney's result asserted that one can recognize the whole WORLD in a Euclidean space. The same thing also happens to combinatorial manifolds, i.e., *how do we realize multi-spaces or combinatorial manifolds? how do we apply them to physics?* This chapter presents elementary answers for the two questions in mathematics. Analogous to the classical geometry, these *Gauss's*, *Codazzi's* and *Ricci's* formulae or fundamental equations are established for combinatorial Riemannian submanifolds Sections 6.1 – 6.2. Section 6.3 considers the embedded problem of combinatorial manifolds and shows that any combinatorial Riemannian manifold can be isometrically embedded into combinatorial Euclidean spaces. Section 6.4 generalizes classical topological or Lie groups to topological or Lie multi-groups, which settles the applications of combinatorial manifolds. This section also considers Lie algebras of Lie multi-groups. Different from the classical case, we establish more than 1 Lie algebra in the multiple case. Section 6.5 concentrates on generalizing classical principal fiber bundles to a multiple one. By applying the voltage assignment technique in topological graph theory, this section presents a combinatorial construction for principal fiber bundles on combinatorial manifolds. It is worth to note that on this kind of principal fiber bundles, local or global connection, local or global curvature form can be introduced, and these structural equations or *Bianchi* identity can be also established on combinatorial manifolds. This enables us to apply the combinatorial differential theory to multi-spaces, particularly to theoretical physics.

§6.1 COMBINATORIAL RIEMANNIAN SUBMANIFOLDS

6.1.1 Fundamental Formulae of Submanifold. We have introduced topologically combinatorial submanifolds in Section 4.2, i.e., a *combinatorial submanifold* or *combinatorial Riemannian submanifold* \widetilde{S} is a subset combinatorial manifold or a combinatorial Riemannian manifold \widetilde{M} such that it is itself a combinatorial manifold or a combinatorial Riemannian manifold. In this and the following section, we generalize conditions on differentiable submanifolds, such as those of the *Gauss's*, the *Codazzi's* and the *Ricci's* formulae or fundamental equations for handling the behavior of submanifolds of a Riemannian manifold to combinatorial Riemannian manifolds.

Let $(\widetilde{i}, \widetilde{M})$ be a smoothly combinatorial submanifold of a Riemannian manifold $(\widetilde{N}, g_{\widetilde{N}}, \widetilde{D})$. For $\forall p \in \widetilde{M}$, we can directly decompose the tangent vector space $T_p \widetilde{N}$ into

$$T_p \widetilde{N} = T_p \widetilde{M} \oplus T_p^\perp \widetilde{M}$$

on the Riemannian metric $g_{\widetilde{N}}$ at the point p , i.e., choice the metric of $T_p \widetilde{M}$ and $T_p^\perp \widetilde{M}$ to be $g_{\widetilde{N}}|_{T_p \widetilde{M}}$ or $g_{\widetilde{N}}|_{T_p^\perp \widetilde{M}}$, respectively. Then we get a tangent vector space $T_p \widetilde{M}$ and a orthogonal complement $T_p^\perp \widetilde{M}$ of $T_p \widetilde{M}$ in $T_p \widetilde{N}$, i.e.,

$$T_p^\perp \widetilde{M} = \{v \in T_p \widetilde{N} \mid \langle v, u \rangle = 0 \text{ for } \forall u \in T_p \widetilde{M}\}.$$

We call $T_p \widetilde{M}$, $T_p^\perp \widetilde{M}$ the *tangent space* and *normal space* of $(\widetilde{i}, \widetilde{M})$ at the point p in $(\widetilde{N}, g_{\widetilde{N}}, \widetilde{D})$, respectively. They both have the Riemannian structure, particularly, \widetilde{M} is a combinatorial Riemannian manifold under the induced metric $g = \widetilde{i}^* g_{\widetilde{N}}$.

Therefore, a vector $v \in T_p \widetilde{N}$ can be directly decomposed into

$$v = v^\top + v^\perp,$$

where $v^\top \in T_p \widetilde{M}$, $v^\perp \in T_p^\perp \widetilde{M}$ are the tangent component and the normal component of v at the point p in $(\widetilde{N}, g_{\widetilde{N}}, \widetilde{D})$. All such vectors v^\perp in $T \widetilde{N}$ are denoted by $T^\perp \widetilde{M}$, i.e.,

$$T^\perp \widetilde{M} = \bigcup_{p \in \widetilde{M}} T_p^\perp \widetilde{M}.$$

Whence, for $\forall X, Y \in \mathcal{X}(\widetilde{M})$, we know that

$$\widetilde{D}_X Y = \widetilde{D}_X^\top Y + \widetilde{D}_X^\perp Y,$$

called the *Gauss formula* on the combinatorial Riemannian submanifold (\widetilde{M}, g) , where $\widetilde{D}_X^\top Y = (\widetilde{D}_X Y)^\top$ and $\widetilde{D}_X^\perp Y = (\widetilde{D}_X Y)^\perp$.

Theorem 6.1.1 *Let $(\widetilde{i}, \widetilde{M})$ be a combinatorial Riemannian submanifold of $(\widetilde{N}, g_{\widetilde{N}}, \widetilde{D})$ with an induced metric $g = \widetilde{i}^* g_{\widetilde{N}}$. Then for $\forall X, Y, Z, \widetilde{D}^\top : \mathcal{X}(\widetilde{M}) \times \mathcal{X}(\widetilde{M}) \rightarrow \mathcal{X}(\widetilde{M})$ determined by $\widetilde{D}^\top(Y, X) = \widetilde{D}_X^\top Y$ is a combinatorial Riemannian connection on (\widetilde{M}, g) and $\widetilde{D}^\perp : \mathcal{X}(\widetilde{M}) \times \mathcal{X}(\widetilde{M}) \rightarrow T^\perp(\widetilde{M})$ is a symmetrically coinvariant tensor field of order 2, i.e.,*

- (1) $\widetilde{D}_{X+Y}^\perp Z = \widetilde{D}_X^\perp Z + \widetilde{D}_Y^\perp Z$;
- (2) $\widetilde{D}_{\lambda X}^\perp Y = \lambda \widetilde{D}_X^\perp Y$ for $\forall \lambda \in C^\infty(\widetilde{M})$;
- (3) $\widetilde{D}_X^\perp Y = \widetilde{D}_Y^\perp X$.

Proof By definition, there exists an inclusion mapping $\widetilde{i} : \widetilde{M} \rightarrow \widetilde{N}$ such that $(\widetilde{i}, \widetilde{M})$ is a combinatorial Riemannian submanifold of $(\widetilde{N}, g_{\widetilde{N}}, \widetilde{D})$ with a metric $g = \widetilde{i}^* g_{\widetilde{N}}$.

For $\forall X, Y, Z \in \mathcal{X}(\widetilde{M})$, we know that

$$\begin{aligned} \widetilde{D}_{X+Y} Z &= \widetilde{D}_X Z + \widetilde{D}_Y Z \\ &= (\widetilde{D}_X^\top Z + \widetilde{D}_X^\perp Z) + (\widetilde{D}_Y^\top Z + \widetilde{D}_Y^\perp Z) \end{aligned}$$

by properties of the combinatorial Riemannian connection \widetilde{D} . Thereby, we find that

$$\widetilde{D}_{X+Y}^\top Z = \widetilde{D}_X^\top Z + \widetilde{D}_Y^\top Z, \quad \widetilde{D}_{X+Y}^\perp Z = \widetilde{D}_X^\perp Z + \widetilde{D}_Y^\perp Z.$$

Similarly, we also find that

$$\widetilde{D}_X^\top(Y + Z) = \widetilde{D}_X^\top Y + \widetilde{D}_X^\top Z, \quad \widetilde{D}_X^\perp(Y + Z) = \widetilde{D}_X^\perp Y + \widetilde{D}_X^\perp Z.$$

Now for $\forall \lambda \in C^\infty(\widetilde{M})$, since

$$\widetilde{D}_{\lambda X} Y = \lambda \widetilde{D}_X Y, \quad \widetilde{D}_X(\lambda Y) = X(\lambda) + \lambda \widetilde{D}_X Y,$$

we find that

$$\widetilde{D}_{\lambda X}^\top Y = \lambda \widetilde{D}_X^\top Y, \quad \widetilde{D}_X^\top(\lambda Y) = X(\lambda) + \lambda \widetilde{D}_X^\top Y$$

and

$$\tilde{D}_X^\perp(\lambda Y) = \lambda \tilde{D}_X^\perp Y.$$

Thereafter, the mapping $\tilde{D}^\top : \mathcal{X}(\tilde{M}) \times \mathcal{X}(\tilde{M}) \rightarrow \mathcal{X}(\tilde{M})$ is a combinatorial connection on (\tilde{M}, g) and $\tilde{D}^\perp : \mathcal{X}(\tilde{M}) \times \mathcal{X}(\tilde{M}) \rightarrow T^\perp(\tilde{M})$ have properties (1) and (2).

By the torsion-free of the Riemannian connection \tilde{D} , i.e.,

$$\tilde{D}_X Y - \tilde{D}_Y X = [X, Y] \in \mathcal{X}(\tilde{M})$$

for $\forall X, Y \in \mathcal{X}(\tilde{M})$, we get that

$$\tilde{D}_X^\top Y - \tilde{D}_Y^\top X = (\tilde{D}_X Y - \tilde{D}_Y X)^\top = [X, Y]$$

and

$$\tilde{D}_X^\perp Y - \tilde{D}_Y^\perp X = (\tilde{D}_X Y - \tilde{D}_Y X)^\perp = 0,$$

i.e., $\tilde{D}_X^\perp Y = \tilde{D}_Y^\perp X$. Whence, \tilde{D}^\top is also torsion-free on (\tilde{M}, g) and the property (3) on \tilde{D}^\perp holds. Applying the compatibility of \tilde{D} with $g_{\tilde{N}}$ in $(\tilde{N}, g_{\tilde{N}}, \tilde{D})$, we finally get that

$$\begin{aligned} Z \langle X, Y \rangle &= \langle \tilde{D}_Z X, Y \rangle + \langle X, \tilde{D}_Z Y \rangle \\ &= \langle \tilde{D}_Z^\top X, Y \rangle + \langle X, \tilde{D}_Z^\top Y \rangle, \end{aligned}$$

which implies that \tilde{D}^\top is also compatible with (\tilde{M}, g) , namely $\tilde{D}^\top : \mathcal{X}(\tilde{M}) \times \mathcal{X}(\tilde{M}) \rightarrow \mathcal{X}(\tilde{M})$ is a combinatorial Riemannian connection on (\tilde{M}, g) . \square

Now for $\forall X \in \mathcal{X}(\tilde{M})$ and $Y^\perp \in T^\perp \tilde{M}$, we know that $\tilde{D}_X Y^\perp \in T\tilde{N}$. Whence, we can directly decompose it into

$$\tilde{D}_X Y^\perp = \tilde{D}_X^\top Y^\perp + \tilde{D}_X^\perp Y^\perp,$$

called the *Weingarten formula on the combinatorial Riemannian submanifold* (\tilde{M}, g) , where $\tilde{D}_X^\top Y^\perp = (\tilde{D}_X Y^\perp)^\top$ and $\tilde{D}_X^\perp Y^\perp = (\tilde{D}_X Y^\perp)^\perp$.

Theorem 6.1.2 *Let (\tilde{i}, \tilde{M}) be a combinatorial Riemannian submanifold of $(\tilde{N}, g_{\tilde{N}}, \tilde{D})$ with an induced metric $g = \tilde{i}^*g_{\tilde{N}}$. Then the mapping $\tilde{D}^\perp : T^\perp\tilde{M} \times \mathcal{X}(\tilde{M}) \rightarrow T^\perp\tilde{M}$ determined by $\tilde{D}(Y^\perp, X) = \tilde{D}_X^\perp Y^\perp$ is a combinatorial Riemannian connection on $T^\perp\tilde{M}$.*

Proof By definition, we have known that there is an inclusion mapping $\tilde{i} : \tilde{M} \rightarrow \tilde{N}$ such that (\tilde{i}, \tilde{M}) is a combinatorial Riemannian submanifold of $(\tilde{N}, g_{\tilde{N}}, \tilde{D})$ with a metric $g = \tilde{i}^*g_{\tilde{N}}$. For $\forall X, Y \in \mathcal{X}(\tilde{M})$ and $\forall Z^\perp, Z_1^\perp, Z_2^\perp \in T^\perp\tilde{M}$, we know that

$$\tilde{D}_{X+Y}^\perp Z^\perp = \tilde{D}_X^\perp Z^\perp + \tilde{D}_Y^\perp Z^\perp, \quad \tilde{D}_X^\perp (Z_1^\perp + Z_2^\perp) = \tilde{D}_X^\perp Z_1^\perp + \tilde{D}_X^\perp Z_2^\perp$$

similar to the proof of Theorem 6.1.4. For $\forall \lambda \in C^\infty(\tilde{M})$, we know that

$$\tilde{D}_{\lambda X} Z^\perp = \lambda \tilde{D}_X Z^\perp, \quad \tilde{D}_X(\lambda Z^\perp) = X(\lambda)Z^\perp + \lambda \tilde{D}_X Z^\perp.$$

Whence, we find that

$$\tilde{D}_{\lambda X}^\perp Z^\perp = (\lambda \tilde{D}_X Z^\perp)^\perp = \lambda (\tilde{D}_X Z^\perp)^\perp = \lambda \tilde{D}_X^\perp Z^\perp,$$

$$\tilde{D}_X^\perp(\lambda Z^\perp) = X(\lambda)Z^\perp + \lambda(\tilde{D}_X Z^\perp)^\perp = X(\lambda)Z^\perp + \lambda \tilde{D}_X^\perp Z^\perp.$$

Therefore, the mapping $\tilde{D}^\perp : T^\perp\tilde{M} \times \mathcal{X}(\tilde{M}) \rightarrow T^\perp\tilde{M}$ is a combinatorial connection on $T^\perp\tilde{M}$. Applying the compatibility of \tilde{D} with $g_{\tilde{N}}$ in $(\tilde{N}, g_{\tilde{N}}, \tilde{D})$, we finally get that

$$X \langle Z_1^\perp, Z_2^\perp \rangle = \langle \tilde{D}_X Z_1^\perp, Z_2^\perp \rangle + \langle Z_1^\perp, \tilde{D}_X Z_2^\perp \rangle = \langle \tilde{D}_X^\perp Z_1^\perp, Z_2^\perp \rangle + \langle Z_1^\perp, \tilde{D}_X^\perp Z_2^\perp \rangle,$$

which implies that $\tilde{D}^\perp : \mathcal{X}(\tilde{M}) \times \mathcal{X}(\tilde{M}) \rightarrow \mathcal{X}(\tilde{M})$ is a combinatorial Riemannian connection on $T^\perp\tilde{M}$. □

Definition 6.1.1 *Let (\tilde{i}, \tilde{M}) be a smoothly combinatorial submanifold of a Riemannian manifold $(\tilde{N}, g_{\tilde{N}}, \tilde{D})$. The two mappings $\tilde{D}^\top, \tilde{D}^\perp$ are called the induced Riemannian connection on \tilde{M} and the normal Riemannian connection on $T^\perp\tilde{M}$, respectively.*

Theorem 6.1.3 *Let the (\tilde{i}, \tilde{M}) be a combinatorial Riemannian submanifold of $(\tilde{N}, g_{\tilde{N}}, \tilde{D})$ with an induced metric $g = \tilde{i}^*g_{\tilde{N}}$. Then for any chosen $Z^\perp \in T^\perp\tilde{M}$, the mapping $D_{Z^\perp}^\top : \mathcal{X}(\tilde{M}) \rightarrow \mathcal{X}(\tilde{M})$ determined by $\tilde{D}_{Z^\perp}^\top(X) = \tilde{D}_X^\top Z^\perp$ for $\forall X \in$*

$\mathcal{X}(\widetilde{M})$ is a tensor field of type $(1,1)$. Besides, if $\widetilde{D}_{Z^\perp}^\top$ is treated as a smoothly linear transformation on \widetilde{M} , then $\widetilde{D}_{Z^\perp}^\top : T_p\widetilde{M} \rightarrow T_p\widetilde{M}$ at any point $p \in \widetilde{M}$ is a self-conjugate transformation on g , i.e., the equality following hold

$$\left\langle \widetilde{D}_{Z^\perp}^\top(X), Y \right\rangle = \left\langle \widetilde{D}_X^\perp(Y), Z^\perp \right\rangle, \quad \forall X, Y \in T_p\widetilde{M}. \quad (6-1)$$

Proof First, we establish the equality (6-1). By applying equalities $X \langle Z^\perp, Y \rangle = \langle \widetilde{D}_X Z^\perp, Y \rangle + \langle Z^\perp, \widetilde{D}_X Y \rangle$ and $\langle Z^\perp, Y \rangle = 0$ for $\forall X, Y \in \mathcal{X}(\widetilde{M})$ and $\forall Z^\perp \in T^\perp\widetilde{M}$, we find that

$$\begin{aligned} \left\langle \widetilde{D}_{Z^\perp}^\top(X), Y \right\rangle &= \left\langle \widetilde{D}_X Z^\perp, Y \right\rangle \\ &= X \langle Z^\perp, Y \rangle - \langle Z^\perp, \widetilde{D}_X Y \rangle = \left\langle \widetilde{D}_X^\perp Y, Z^\perp \right\rangle. \end{aligned}$$

Thereafter, the equality (6-1) holds.

Now according to Theorem 6.1.1, $\widetilde{D}_X^\perp Y$ posses tensor properties for $X, Y \in T_p\widetilde{M}$. Combining this fact with the equality (6-1), $\widetilde{D}_{Z^\perp}^\top(X)$ is a tensor field of type $(1,1)$. Whence, $\widetilde{D}_{Z^\perp}^\top$ determines a linear transformation $\widetilde{D}_{Z^\perp}^\top : T_p\widetilde{M} \rightarrow T_p\widetilde{M}$ at any point $p \in \widetilde{M}$. Besides, we can also show that $\widetilde{D}_{Z^\perp}^\top(X)$ posses the tensor properties for $\forall Z^\perp \in T^\perp\widetilde{M}$. For example, for any $\lambda \in C^\infty(\widetilde{M})$ we know that

$$\begin{aligned} \left\langle \widetilde{D}_{\lambda Z^\perp}^\top(X), Y \right\rangle &= \left\langle \widetilde{D}_X^\perp Y, \lambda Z^\perp \right\rangle = \lambda \left\langle \widetilde{D}_X^\perp Y, Z^\perp \right\rangle \\ &= \left\langle \lambda \widetilde{D}_{Z^\perp}^\top(X), Y \right\rangle, \quad \forall X, Y \in \mathcal{X}(\widetilde{M}) \end{aligned}$$

by applying the equality (6-1) again. Therefore, we finally get that $\widetilde{D}_{\lambda Z^\perp}^\top(X) = \lambda \widetilde{D}_{Z^\perp}^\top(X)$.

Combining the symmetry of $\widetilde{D}_X^\perp Y$ with the equality (6-1) enables us to know that the linear transformation $\widetilde{D}_{Z^\perp}^\top : T_p\widetilde{M} \rightarrow T_p\widetilde{M}$ at a point $p \in \widetilde{M}$ is self-conjugate. In fact, for $\forall X, Y \in T_p\widetilde{M}$, we get that

$$\begin{aligned} \left\langle \widetilde{D}_{Z^\perp}^\top(X), Y \right\rangle &= \left\langle \widetilde{D}_X^\perp Y, Z^\perp \right\rangle = \left\langle \widetilde{D}_Y^\perp X, Z^\perp \right\rangle \\ &= \left\langle \widetilde{D}_{Z^\perp}^\top(Y), X \right\rangle = \left\langle X, \widetilde{D}_{Z^\perp}^\top(Y) \right\rangle. \end{aligned}$$

Whence, $\widetilde{D}_{Z^\perp}^\top$ is self-conjugate. This completes the proof. \square

6.1.2 Local Form of Fundamental Formula. Now we look for local forms for \tilde{D}^\top and \tilde{D}^\perp . Let $(\tilde{M}, g, \tilde{D}^\top)$ be a combinatorial Riemannian submanifold of $(\tilde{N}, g_{\tilde{N}}, \tilde{D})$. For $\forall p \in \tilde{M}$, let

$$\{\bar{e}_{AB} | 1 \leq A \leq d_{\tilde{N}}(p), 1 \leq B \leq n_A \quad \text{and} \quad \bar{e}_{A_1 B} = \bar{e}_{A_2 B},$$

$$\text{for } 1 \leq A_1, A_2 \leq d_{\tilde{N}}(p) \text{ if } 1 \leq B \leq \hat{d}_{\tilde{N}}(p)\}$$

be an orthogonal frame with a dual

$$\{\omega^{AB} | 1 \leq A \leq d_{\tilde{N}}(p), 1 \leq B \leq n_A \quad \text{and} \quad \omega^{A_1 B} = \omega^{A_2 B},$$

$$\text{for } 1 \leq A_1, A_2 \leq d_{\tilde{N}}(p) \text{ if } 1 \leq B \leq \hat{d}_{\tilde{N}}(p)\}$$

at the point p in $T\tilde{N}$ abbreviated to $\{\bar{e}_{AB}\}$ and ω^{AB} . Choose indexes $(AB), (CD), \dots, (ab), (cd), \dots$ and $(\alpha\beta), (\gamma\delta), \dots$ satisfying $1 \leq A, C \leq d_{\tilde{N}}(p), 1 \leq B \leq n_A, 1 \leq D \leq n_C, \dots, 1 \leq a, c \leq d_{\tilde{M}}(p), 1 \leq b \leq n_a, 1 \leq d \leq n_c, \dots$ and $\alpha, \gamma \geq d_{\tilde{M}}(p) + 1$ or $\beta, \delta \geq n_i + 1$ for $1 \leq i \leq d_{\tilde{M}}(p)$. For getting local forms of \tilde{D}^\top and \tilde{D}^\perp , we can even assume that $\{\bar{e}_{AB}\}, \{\bar{e}_{ab}\}$ and $\{\bar{e}_{\alpha\beta}\}$ are the orthogonal frame of the point in the tangent vector space $T\tilde{N}, T\tilde{M}$ and the normal vector space $T^\perp\tilde{M}$ by Theorems 3.1 – 3.3. Then the Gauss's and Weingarten's formula can be expressed by

$$\tilde{D}_{\bar{e}_{ab}} \bar{e}_{cd} = \tilde{D}_{\bar{e}_{ab}}^\top \bar{e}_{cd} + \tilde{D}_{\bar{e}_{ab}}^\perp \bar{e}_{cd},$$

$$\tilde{D}_{\bar{e}_{ab}} \bar{e}_{\alpha\beta} = \tilde{D}_{\bar{e}_{ab}}^\top \bar{e}_{\alpha\beta} + \tilde{D}_{\bar{e}_{ab}}^\perp \bar{e}_{\alpha\beta}.$$

When p is varied in \tilde{M} , we know that $\omega^{ab} = \tilde{i}^*(\omega^{ab})$ and $\omega^{ab} = 0, \omega^{\alpha\beta} = 0$. Whence, $\{\omega^{ab}\}$ is the dual of $\{\bar{e}_{ab}\}$ at the point $p \in T\tilde{M}$. Notice that

$$\tilde{d}\omega^{ab} = \omega^{cd} \wedge \omega_{cd}^{ab}, \quad \omega_{cd}^{ab} + \omega_{ab}^{cd} = 0$$

in $(\tilde{M}, g, \tilde{D}^\top)$ and

$$\tilde{d}\omega^{AB} = \omega^{CD} \wedge \omega_{CD}^{AB}, \quad \omega_{AB}^{CD} + \omega_{CD}^{AB} = 0, \quad \omega_{ab}^{\alpha\beta} + \omega_{\alpha\beta}^{ab} = 0, \quad \omega_{\alpha\beta}^{\gamma\delta} + \omega_{\gamma\delta}^{\alpha\beta} = 0$$

in $(\tilde{N}, g_{\tilde{N}}, \tilde{D})$ by the structural equations and

$$\tilde{D}\bar{e}_{AB} = \omega_{AB}^{CD}\bar{e}_{CD}$$

by definition. We finally get that

$$\tilde{D}\bar{e}_{ab} = \omega_{ab}^{cd}\bar{e}_{cd} + \omega_{ab}^{\alpha\beta}\bar{e}_{\alpha\beta}, \quad \tilde{D}\bar{e}_{\alpha\beta} = \omega_{\alpha\beta}^{cd}\bar{e}_{cd} + \omega_{\alpha\beta}^{\gamma\delta}\bar{e}_{\gamma\delta}.$$

Since $\tilde{d}\omega^{\alpha i} = \omega^{ab} \wedge \omega_{ab}^{\alpha i} = 0$, $\tilde{d}\omega^{i\beta} = \omega^{ab} \wedge \omega_{ab}^{i\beta} = 0$, by the *Cartan's Lemma*, i.e., Theorem 5.2.3, we know that

$$\omega_{ab}^{\alpha i} = h_{(ab)(cd)}^{\alpha i}\omega^{cd}, \quad \omega_{ab}^{i\beta} = h_{(ab)(cd)}^{i\beta}\omega^{cd}$$

with $h_{(ab)(cd)}^{\alpha i} = h_{(cd)(ab)}^{\alpha i}$ and $h_{(ab)(cd)}^{i\beta} = h_{(cd)(ab)}^{i\beta}$. Thereafter, we get that

$$\tilde{D}_{\bar{e}_{ab}}^{\perp}\bar{e}_{cd} = \omega_{cd}^{\alpha\beta}(\bar{e}_{ab})\bar{e}_{\alpha\beta} = h_{(ab)(cd)}^{\alpha\beta}\bar{e}_{\alpha\beta},$$

$$\tilde{D}_{\bar{e}_{ab}}^{\top}\bar{e}_{\alpha\beta} = \omega_{\alpha\beta}^{cd}(\bar{e}_{ab})\bar{e}_{cd} = h_{(ab)(cd)}^{\alpha\beta}\bar{e}_{\alpha\beta}.$$

Whence, we get local forms of \tilde{D}^{\top} and \tilde{D}^{\perp} in the following.

Theorem 6.1.4 *Let $(\tilde{M}, g, \tilde{D}^{\top})$ be a combinatorial Riemannian submanifold of $(\tilde{N}, g_{\tilde{N}}, \tilde{D})$. Then for $\forall p \in \tilde{M}$ with locally orthogonal frames $\{\bar{e}_{AB}\}$, $\{\bar{e}_{ab}\}$ and their dual $\{\omega^{AB}\}$, $\{\omega^{ab}\}$ in $T\tilde{N}$, $T\tilde{M}$,*

$$\tilde{D}_{\bar{e}_{ab}}^{\top}\bar{e}_{cd} = \omega_{\alpha\beta}^{cd}(\bar{e}_{ab})\bar{e}_{cd}, \quad \tilde{D}_{\bar{e}_{ab}}^{\perp}\bar{e}_{cd} = h_{(ab)(cd)}^{\alpha\beta}\bar{e}_{\alpha\beta}$$

$$\tilde{D}_{\bar{e}_{ab}}^{\top}\bar{e}_{\alpha\beta} = h_{(ab)(cd)}^{\alpha\beta}\bar{e}_{\alpha\beta}, \quad \tilde{D}_{\bar{e}_{ab}}^{\perp}\bar{e}_{\alpha\beta} = \omega_{\alpha\beta}^{\gamma\delta}(\bar{e}_{ab})\bar{e}_{\gamma\delta}.$$

□

Corollary 6.1.1 *Let (M, g, D^{\top}) be a Riemannian submanifold of (N, g_N, D) . Then for $\forall p \in M$ with locally orthogonal frames $\{\bar{e}_A\}$, $\{\bar{e}_a\}$ and their dual $\{\omega^A\}$, $\{\omega^a\}$ in TN , TM ,*

$$D_{\bar{e}_a}^{\top}\bar{e}_b = \omega_a^b(\bar{e}_a)\bar{e}_b, \quad D_{\bar{e}_a}^{\perp}\bar{e}_b = h_{ab}^{\alpha}\bar{e}_{\alpha}$$

$$D_{\bar{e}_a}^{\top}\bar{e}_{\alpha} = h_{ab}^{\alpha}\bar{e}_{\alpha}, \quad D_{\bar{e}_a}^{\perp}\bar{e}_{\alpha} = \omega_{\alpha}^{\beta}(\bar{e}_a)\bar{e}_{\beta}.$$

§6.2 FUNDAMENTAL EQUATIONS ON

COMBINATORIAL SUBMANIFOLDS

6.2.1 Gauss Equation. Applications of these *Gauss's* and *Weingarten's* formulae enable one to get fundamental equations such as the *Gauss's*, *Codazzi's* and *Ricci's* equations on curvature tensors for characterizing combinatorial Riemannian submanifolds.

Theorem 6.2.1(Gauss equation) *Let $(\widetilde{M}, g, \widetilde{D}^\top)$ be a combinatorial Riemannian submanifold of $(\widetilde{N}, g_{\widetilde{N}}, \widetilde{D})$ with the induced metric $g = \widetilde{i}^*g_{\widetilde{N}}$ and $\widetilde{R}, \widetilde{R}_{\widetilde{N}}$ curvature tensors on \widetilde{M} and \widetilde{N} , respectively. Then for $\forall X, Y, Z, W \in \mathcal{X}(\widetilde{M})$,*

$$\widetilde{R}(X, Y, Z, W) = \widetilde{R}_{\widetilde{N}}(X, Y, Z, W) + \left\langle \widetilde{D}_X^\perp Z, \widetilde{D}_Y^\perp W \right\rangle - \left\langle \widetilde{D}_Y^\perp Z, \widetilde{D}_X^\perp W \right\rangle.$$

Proof By definition, we know that

$$\widetilde{\mathcal{R}}_{\widetilde{N}}(X, Y)Z = \widetilde{D}_X \widetilde{D}_Y Z - \widetilde{D}_Y \widetilde{D}_X Z - \widetilde{D}_{[X, Y]}Z.$$

Applying the *Gauss* formula, we find that

$$\begin{aligned} \widetilde{\mathcal{R}}_{\widetilde{N}}(X, Y)Z &= \widetilde{D}_X(\widetilde{D}_Y^\top Z + \widetilde{D}_Y^\perp Z) - \widetilde{D}_Y(\widetilde{D}_X^\top Z + \widetilde{D}_X^\perp Z) \\ &\quad - (\widetilde{D}_{[X, Y]}^\top Z + \widetilde{D}_{[X, Y]}^\perp Z) \\ &= \widetilde{D}_X^\top \widetilde{D}_Y^\top Z + \widetilde{D}_X^\perp \widetilde{D}_Y^\top Z + \widetilde{D}_X \widetilde{D}_Y^\perp Z - \widetilde{D}_Y^\top \widetilde{D}_X^\top Z \\ &\quad - \widetilde{D}_Y^\perp \widetilde{D}_X^\top Z - \widetilde{D}_Y \widetilde{D}_X^\perp Z - \widetilde{D}_{[X, Y]}^\top Z - \widetilde{D}_{[X, Y]}^\perp Z \\ &= \widetilde{R}(X, Y)Z + (\widetilde{D}_X^\perp \widetilde{D}_Y^\top Z - \widetilde{D}_Y^\perp \widetilde{D}_X^\top Z) \\ &\quad - (\widetilde{D}_{[X, Y]}^\perp Z - \widetilde{D}_X \widetilde{D}_Y^\perp Z + \widetilde{D}_Y \widetilde{D}_X^\perp Z). \quad (6-2) \end{aligned}$$

By the *Weingarten* formula,

$$\widetilde{D}_X \widetilde{D}_Y^\perp Z = \widetilde{D}_X^\top \widetilde{D}_Y^\perp Z + \widetilde{D}_X^\perp \widetilde{D}_Y^\perp Z, \quad \widetilde{D}_Y \widetilde{D}_X^\perp Z = \widetilde{D}_Y^\top \widetilde{D}_X^\perp Z + \widetilde{D}_Y^\perp \widetilde{D}_X^\perp Z.$$

Therefore, we get that

$$\langle \tilde{R}(X, Y)Z, W \rangle = \langle \tilde{R}_{\tilde{N}}(X, Y)Z, W \rangle + \langle \tilde{D}_X^\perp Z, \tilde{D}_Y^\perp W \rangle - \langle \tilde{D}_Y^\perp Z, \tilde{D}_X^\perp W \rangle$$

by applying the equality (6 – 1) in Theorem 6.1.3, i.e.,

$$\tilde{R}(X, Y, Z, W) = \tilde{R}_{\tilde{N}}(X, Y, Z, W) + \langle \tilde{D}_X^\perp Z, \tilde{D}_Y^\perp W \rangle - \langle \tilde{D}_Y^\perp Z, \tilde{D}_X^\perp W \rangle.$$

□

6.2.2 Codazzi Equation. For $\forall X, Y, Z \in \mathcal{X}(\tilde{M})$, define the covariant differential \tilde{D}_X on $\tilde{D}_Y^\perp Z$ by

$$(\tilde{D}_X \tilde{D}^\perp)_Y Z = \tilde{D}_X^\perp(\tilde{D}_Y^\perp Z) - \tilde{D}_{\tilde{D}_X^\perp Y}^\perp Z - \tilde{D}_Y^\perp(\tilde{D}_X^\perp Z).$$

Then we get the *Codazzi equation* in the following.

Theorem 6.2.2 (Codazzi equation) *Let $(\tilde{M}, g, \tilde{D}^\perp)$ be a combinatorial Riemannian submanifold of $(\tilde{N}, g_{\tilde{N}}, \tilde{D})$ with the induced metric $g = \tilde{i}^* g_{\tilde{N}}$ and $\tilde{R}, \tilde{R}_{\tilde{N}}$ curvature tensors on \tilde{M} and \tilde{N} , respectively. Then for $\forall X, Y, Z \in \mathcal{X}(\tilde{M})$,*

$$(\tilde{D}_X \tilde{D}^\perp)_Y Z - (\tilde{D}_Y \tilde{D}^\perp)_X Z = \tilde{R}^\perp(X, Y)Z$$

Proof Decompose the curvature tensor $\tilde{R}_{\tilde{N}}(X, Y)Z$ into

$$\tilde{R}_{\tilde{N}}(X, Y)Z = \tilde{R}_{\tilde{N}}^\perp(X, Y)Z + \tilde{R}_{\tilde{N}}^\perp(X, Y)Z.$$

Notice that

$$\tilde{D}_X^\perp Y - \tilde{D}_Y^\perp X = [X, Y].$$

By the formula (6 – 2), we know that

$$\begin{aligned} \tilde{R}_{\tilde{N}}^\perp(X, Y)Z &= \tilde{D}_X^\perp \tilde{D}_Y^\perp Z - \tilde{D}_Y^\perp \tilde{D}_X^\perp Z - \tilde{D}_{[X, Y]}^\perp Z + \tilde{D}_X^\perp \tilde{D}_Y^\perp Z - \tilde{D}_Y^\perp \tilde{D}_X^\perp Z \\ &= \tilde{D}_X^\perp \tilde{D}_Y^\perp Z - \tilde{D}_Y^\perp \tilde{D}_X^\perp Z - \tilde{D}_{\tilde{D}_X^\perp Y}^\perp Z + \tilde{D}_Y^\perp \tilde{D}_X^\perp Z - \tilde{D}_X^\perp \tilde{D}_Y^\perp Z - \tilde{D}_{\tilde{D}_Y^\perp X}^\perp Z \\ &= (\tilde{D}_X \tilde{D}^\perp)_Y Z - (\tilde{D}_Y \tilde{D}^\perp)_X Z. \end{aligned}$$

□

6.2.3 Ricci Equation. For $\forall X, Y \in \mathcal{X}(\widetilde{M})$, $Z^\perp \in T^\perp(\widetilde{M})$, the curvature tensor \widetilde{R}^\perp determined by \widetilde{D}^\perp in $T^\perp\widetilde{M}$ is defined by

$$\widetilde{R}^\perp(X, Y)Z^\perp = \widetilde{D}_X^\perp \widetilde{D}_Y^\perp Z^\perp - \widetilde{D}_Y^\perp \widetilde{D}_X^\perp Z^\perp - \widetilde{D}_{[X, Y]}^\perp Z^\perp.$$

Similarly, we get the next result.

Theorem 6.2.3(Ricci equation) *Let $(\widetilde{M}, g, \widetilde{D}^\top)$ be a combinatorial Riemannian submanifold of $(\widetilde{N}, g_{\widetilde{N}}, \widetilde{D})$ with the induced metric $g = \widetilde{i}^*g_{\widetilde{N}}$ and $\widetilde{R}, \widetilde{R}_{\widetilde{N}}$ curvature tensors on \widetilde{M} and \widetilde{N} , respectively. Then for $\forall X, Y \in \mathcal{X}(\widetilde{M})$, $Z^\perp \in T\widetilde{M}$,*

$$\widetilde{R}^\perp(X, Y)Z^\perp = \widetilde{R}_{\widetilde{N}}^\perp(X, Y)Z^\perp + (\widetilde{D}_X \widetilde{D}^\perp)_Y Z^\perp - (\widetilde{D}_Y \widetilde{D}^\perp)_X Z^\perp.$$

Proof Similar to the proof of Theorem 6.2.1, we know that

$$\begin{aligned} \widetilde{R}_{\widetilde{N}}^\perp(X, Y)Z^\perp &= \widetilde{D}_X \widetilde{D}_Y Z^\perp - \widetilde{D}_Y \widetilde{D}_X Z^\perp - \widetilde{D}_{[X, Y]} Z^\perp \\ &= \widetilde{R}^\perp(X, Y)Z^\perp + \widetilde{D}_X^\perp \widetilde{D}_Y^\top Z^\perp - \widetilde{D}_Y^\perp \widetilde{D}_X^\top Z^\perp \\ &\quad + \widetilde{D}_X \widetilde{D}_Y^\perp Z^\perp - \widetilde{D}_Y \widetilde{D}_X^\perp Z^\perp \\ &= (\widetilde{R}^\perp(X, Y)Z^\perp + (\widetilde{D}_X \widetilde{D}^\perp)_Y Z^\perp - (\widetilde{D}_Y \widetilde{D}^\perp)_X Z^\perp) \\ &\quad + \widetilde{D}_X^\top \widetilde{D}_Y^\perp Z^\perp - \widetilde{D}_Y^\top \widetilde{D}_X^\perp Z^\perp. \end{aligned}$$

Whence, we get that

$$\widetilde{R}^\perp(X, Y)Z^\perp = \widetilde{R}_{\widetilde{N}}^\perp(X, Y)Z^\perp + (\widetilde{D}_X \widetilde{D}^\perp)_Y Z^\perp - (\widetilde{D}_Y \widetilde{D}^\perp)_X Z^\perp.$$

□

6.2.4 Local Form of Fundamental Equation. We can also find local forms for these Gauss's, Codazzi's and Ricci's equations in a locally orthogonal frames $\{\bar{e}_{AB}\}$, $\{\bar{e}_{ab}\}$ of $T\widetilde{N}$ and $T\widetilde{M}$ at a point $p \in \widetilde{M}$.

Theorem 6.2.4 *Let $(\widetilde{M}, g, \widetilde{D}_{\widetilde{M}})$ be a combinatorial Riemannian submanifold of $(\widetilde{N}, g_{\widetilde{N}}, \widetilde{D})$ with $g = \widetilde{i}^*g_{\widetilde{N}}$ and for $p \in \widetilde{M}$, let $\{\bar{e}_{AB}\}$, $\{\bar{e}_{ab}\}$ be locally orthogonal frames of $T\widetilde{N}$ and $T\widetilde{M}$ at p with dual $\{\omega^{AB}\}$, $\{\omega^{ab}\}$. Then*

$$\widetilde{R}_{(ab)(cd)(ef)(gh)} = (\widetilde{R}_{\widetilde{N}})_{(ab)(cd)(ef)(gh)} - \sum_{\alpha, \beta} (h_{(ab)(ef)}^{\alpha\beta} h_{(cd)(gh)}^{\alpha\beta} - h_{(ab)(gh)}^{\alpha\beta} h_{(cd)(ef)}^{\alpha\beta}) \quad (Gauss),$$

$$h_{(ab)(cd)(ef)}^{\alpha\beta} - h_{(ab)(ef)(cd)}^{\alpha\beta} = (\tilde{R}_{\tilde{N}})_{(\alpha\beta)(ab)(cd)(ef)} \quad (\text{Codazzi})$$

and

$$\tilde{R}_{(\alpha\beta)(\gamma\delta)(ab)(cd)}^\perp = (\tilde{R}_{\tilde{N}})_{(\alpha\beta)(\gamma\delta)(ab)(cd)} - \sum_{e,f} (h_{(ab)(ef)}^{\alpha\beta} h_{(cd)(gh)}^{\gamma\delta} - h_{(cd)(ef)}^{\alpha\beta\beta} h_{(ab)(gh)}^{\gamma\delta}) \quad (\text{Ricci})$$

with $\tilde{R}_{(\alpha\beta)(\gamma\delta)(ab)(cd)}^\perp = \langle \tilde{R}(\bar{e}_{ab}, \bar{e}_{cd})\bar{e}_{\alpha\beta}, \bar{e}_{\gamma\delta} \rangle$ and

$$h_{(ab)(cd)(ef)}^{\alpha\beta} \omega^{ef} = \tilde{d}h_{(ab)(cd)}^{\alpha\beta} - \omega_{ab}^{ef} h_{(ef)(cd)}^{\alpha\beta} - \omega_{cd}^{ef} h_{(ab)(ef)}^{\alpha\beta} + \omega_{\gamma\delta}^{\alpha\beta} h_{(ab)(cd)}^{\gamma\delta}.$$

Proof Let $\tilde{\Omega}$ and $\tilde{\Omega}_{\tilde{N}}$ be curvature forms in \tilde{M} and \tilde{N} . Then by the structural equations in $(\tilde{N}, g_{\tilde{N}}, \tilde{D})$, we know that

$$(\tilde{\Omega}_{\tilde{N}})_{AB}^{CD} = \tilde{d}\omega_{AB}^{CD} - \omega_{AB}^{EF} \wedge \omega_{EF}^{CD} = \frac{1}{2}(\tilde{R}\tilde{N})_{(AB)(CD)(EF)(GH)} \omega^{EF} \wedge \omega^{GH}$$

and $\tilde{R}(\bar{e}_{AB}, \bar{e}_{CD})\bar{e}_{EF} = \tilde{\Omega}_{EF}^{GH}(\bar{e}_{AB}, \bar{e}_{CD})\bar{e}_{GH}$. Let $\tilde{i} : \tilde{M} \rightarrow \tilde{N}$ be an embedding mapping. Applying \tilde{i}^* action on the above equations, we find that

$$\begin{aligned} (\tilde{\Omega}_{\tilde{N}})_{ab}^{cd} &= \tilde{d}\omega_{ab}^{cd} - \omega_{ab}^{ef} \wedge \omega_{ef}^{cd} - \omega_{ab}^{\alpha\beta} \wedge \omega_{\alpha\beta}^{cd} \\ &= \tilde{\Omega}_{ab}^{cd} + \sum_{\alpha,\beta} h_{(ab)(ef)}^{\alpha\beta} h_{(cd)(gh)}^{\alpha\beta} \omega^{ef} \wedge \omega^{gh}. \end{aligned}$$

Whence, we get that

$$\tilde{\Omega}_{ab}^{cd} = (\tilde{\Omega}_{\tilde{N}})_{ab}^{cd} - \frac{1}{2} \sum_{\alpha,\beta} (h_{(ab)(ef)}^{\alpha\beta} h_{(cd)(gh)}^{\alpha\beta} - h_{(ab)(gh)}^{\alpha\beta} h_{(cd)(ef)}^{\alpha\beta}) \omega^{ef} \wedge \omega^{gh}.$$

This is the *Gauss's* equation

$$\tilde{R}_{(ab)(cd)(ef)(gh)} = (\tilde{R}_{\tilde{N}})_{(ab)(cd)(ef)(gh)} - \sum_{\alpha,\beta} (h_{(ab)(ef)}^{\alpha\beta} h_{(cd)(gh)}^{\alpha\beta} - h_{(ab)(gh)}^{\alpha\beta} h_{(cd)(ef)}^{\alpha\beta}).$$

Similarly, we also know that

$$\begin{aligned}
(\tilde{\Omega}_{\tilde{N}})^{\alpha\beta} &= \tilde{d}\omega_{ab}^{\alpha\beta} - \omega_{ab}^{cd} \wedge \omega_{cd}^{\alpha\beta} - \omega_{ab}^{\gamma\delta} \wedge \omega_{\gamma\delta}^{\alpha\beta} \\
&= \tilde{d}(h_{(ab)(cd)}^{\alpha\beta} \omega^{cd}) - h_{(cd)(ef)}^{\alpha\beta} \omega_{ab}^{cd} \wedge \omega^{ef} - h_{(ab)(ef)}^{\gamma\delta} \omega^{ef} \wedge \omega_{\gamma\delta}^{\alpha\beta} \\
&= (\tilde{d}h_{(ab)(cd)}^{\alpha\beta} - h_{(ab)(ef)}^{\alpha\beta} \omega_{cd}^{ef}) - h_{(ef)(cd)}^{\alpha\beta} \omega_{ab}^{ef} + h_{(ab)(cd)}^{\gamma\delta} \omega_{\alpha\beta}^{\gamma\delta} \wedge \omega^{cd} \\
&= h_{(ab)(cd)(ef)}^{\alpha\beta} \omega^{ef} \wedge \omega^{cd} \\
&= \frac{1}{2} (h_{(ab)(cd)(ef)}^{\alpha\beta} - h_{(ab)(ef)(cd)}^{\alpha\beta}) \omega^{ef} \wedge \omega^{cd}
\end{aligned}$$

and

$$\begin{aligned}
(\tilde{\Omega}_{\tilde{N}})_{\alpha\beta}^{\gamma\delta} &= \tilde{d}\omega_{\alpha\beta}^{\gamma\delta} - \omega_{\alpha\beta}^{ef} \wedge \omega_{ef}^{\gamma\delta} - \omega_{\alpha\beta}^{\zeta\eta} \wedge \omega_{\zeta\eta}^{\gamma\delta} \\
&= \tilde{\Omega}_{\alpha\beta}^{\gamma\delta} + \frac{1}{2} \sum_{e,f} (h_{(ef)(ab)}^{\alpha\beta} h_{(ef)(cd)}^{\gamma\delta} - h_{(ef)(cd)}^{\alpha\beta} h_{(ef)(ab)}^{\gamma\delta}) \omega^{ab} \wedge \omega^{cd}.
\end{aligned}$$

These equalities enables us to get

$$h_{(ab)(cd)(ef)}^{\alpha\beta} - h_{(ab)(ef)(cd)}^{\alpha\beta} = (\tilde{R}_{\tilde{N}})_{(\alpha\beta)(ab)(cd)(ef)},$$

and

$$\tilde{R}_{(\alpha\beta)(\gamma\delta)(ab)(cd)}^{\perp} = (\tilde{R}_{\tilde{N}})_{(\alpha\beta)(\gamma\delta)(ab)(cd)} - \sum_{e,f} (h_{(ab)(ef)}^{\alpha\beta} h_{(cd)(gh)}^{\gamma\delta} - h_{(cd)(ef)}^{\alpha\beta\beta} h_{(ab)(gh)}^{\gamma\delta}).$$

These are just the *Codazzi's* or *Ricci's* equations. \square

§6.3 EMBEDDED COMBINATORIAL SUBMANIFOLDS

6.3.1 Embedded Combinatorial Submanifold. Let \tilde{M}, \tilde{N} be two combinatorial manifolds, $F : \tilde{M} \rightarrow \tilde{N}$ a smooth mapping and $p \in \tilde{M}$. For $\forall v \in T_p \tilde{M}$, define a tangent vector $F_*(v) \in T_{F(p)} \tilde{N}$ by

$$F_*(v) = v(f \circ F), \quad \forall f \in C_{F(p)}^\infty,$$

called the differentiation of F at the point p . Its dual $F^* : T_{F(p)}^* \tilde{N} \rightarrow T_p^* \tilde{M}$ determined by

$$(F^*\omega)(v) = \omega(F_*(v)) \text{ for } \forall \omega \in T_{F(p)}^*\tilde{N} \text{ and } \forall v \in T_p\tilde{M}$$

is called a *pull-back* mapping. We know that mappings F_* and F^* are linear.

For a smooth mapping $F : \tilde{M} \rightarrow \tilde{N}$ and $p \in \tilde{M}$, if $F_{*p} : T_p\tilde{M} \rightarrow T_{F(p)}\tilde{N}$ is one-to-one, we call it an *immersion mapping*. Besides, if F_{*p} is onto and $F : \tilde{M} \rightarrow F(\tilde{M})$ is a homeomorphism with the relative topology of \tilde{N} , then we call it an *embedding mapping* and (F, \tilde{M}) a *combinatorial embedded submanifold*. Usually, we replace the inclusion mapping $\tilde{i} : \tilde{M} \rightarrow \tilde{N}$ and denoted by (\tilde{i}, \tilde{M}) a combinatorial submanifold of \tilde{N} .

Now let $\tilde{M} = \tilde{M}(n_1, n_2, \dots, n_m)$, $\tilde{N} = \tilde{N}(k_1, k_2, \dots, k_l)$ be two finitely combinatorial manifolds and $F : \tilde{M} \rightarrow \tilde{N}$ a smooth mapping. For $\forall p \in \tilde{M}$, let (U_p, φ_p) and $(V_{F(p)}, \psi_{F(p)})$ be local charts of p in \tilde{M} and $F(p)$ in \tilde{N} , respectively. Denoted by

$$J_{X;Y}(F)(p) = \left[\frac{\partial F^{\kappa\lambda}}{\partial x^{\mu\nu}} \right]$$

the *Jacobi matrix* of F at p . Then we find that

Theorem 6.3.1 *Let $F : \tilde{M} \rightarrow \tilde{N}$ be a smooth mapping from \tilde{M} to \tilde{N} . Then F is an immersion mapping if and only if*

$$\text{rank}(J_{X;Y}(F)(p)) = d_{\tilde{M}}(p)$$

for $\forall p \in \tilde{M}$.

Proof Assume the coordinate matrixes of points $p \in \tilde{M}$ and $F(p) \in \tilde{N}$ are $[x^{ij}]_{s(p) \times n_s(p)}$ and $[y^{ij}]_{s(F(p)) \times n_s(F(p))}$, respectively. Notice that

$$T_p\tilde{M} = \left\langle \frac{\partial}{\partial x^{i_0 j_1}} \Big|_p, \frac{\partial}{\partial x^{i_0 j_2}} \Big|_p \mid 1 \leq i \leq s(p), 1 \leq j_1 \leq \hat{s}(p), \hat{s}(p) + 1 \leq j_2 \leq n_i \right\rangle$$

and

$$T_{F(p)}\tilde{N} = \left\langle \left\{ \frac{\partial}{\partial y^{i_0 j_1}} \Big|_{F(p)}, 1 \leq j_1 \leq \hat{s}(F(p)) \right\} \bigcup_{i=1}^{s(F(p))} \left\{ \frac{\partial}{\partial y^{i_0 j_2}} \Big|_{F(p)}, \hat{s}(F(p)) + 1 \leq j_2 \leq k_i \right\} \right\rangle$$

for any integer $i_0, 1 \leq i_0 \leq \min\{s(p), s(F(p))\}$. By definition, F_{*p} is a linear mapping. We only need to prove that $F_{*p} : T_p\tilde{M} \rightarrow T_p\tilde{N}$ is an injection for $\forall p \in \tilde{M}$. For $\forall f \in \mathcal{X}_p$, calculation shows that

$$\begin{aligned}
 F_{*p}\left(\frac{\partial}{\partial x^{ij}}\right)(f) &= \frac{\partial(f \circ F)}{\partial x^{ij}} \\
 &= \sum_{\mu,\nu} \frac{\partial F^{\mu\nu}}{\partial x^{ij}} \frac{\partial f}{\partial y^{\mu\nu}}.
 \end{aligned}$$

Whence, we find that

$$F_{*p}\left(\frac{\partial}{\partial x^{ij}}\right) = \sum_{\mu,\nu} \frac{\partial F^{\mu\nu}}{\partial x^{ij}} \frac{\partial}{\partial y^{\mu\nu}}. \tag{6-3}$$

According to a fundamental result on linear equation systems, these exist solutions in the equation system (6-3) if and only if

$$\text{rank}(J_{X;Y}(F)(p)) = \text{rank}(J_{X;Y}^*(F)(p)),$$

where

$$J_{X;Y}^*(F)(p) = \begin{bmatrix} \dots & F_{*p}\left(\frac{\partial}{\partial x^{i_1}}\right) \\ \dots & \dots \\ \dots & F_{*p}\left(\frac{\partial}{\partial x^{i_{n_1}}}\right) \\ J_{X;Y}(F)(p) & \dots \\ \dots & F_{*p}\left(\frac{\partial}{\partial x^{s(p)\Gamma}}\right) \\ \dots & \dots \\ \dots & F_{*p}\left(\frac{\partial}{\partial x^{s(p)n_s(p)}}\right) \end{bmatrix}.$$

We have known that

$$\text{rank}(J_{X;Y}^*(F)(p)) = d_{\widetilde{M}}(p).$$

Therefore, F is an immersion mapping if and only if

$$\text{rank}(J_{X;Y}(F)(p)) = d_{\widetilde{M}}(p)$$

for $\forall p \in \widetilde{M}$. □

Applying Theorem 5.6.2, namely the partition of unity for smoothly combinatorial manifold, we get criterions for embedded combinatorial submanifolds following.

Theorem 6.3.2 *Let \widetilde{M} be a smoothly combinatorial manifold and N a manifold. If for $\forall M \in V(G^L[\widetilde{M}])$, there exists an embedding $F_M : M \rightarrow N$, then \widetilde{M} can be embedded into N .*

Proof By assumption, there exists an embedding $F_M : M \rightarrow N$ for $\forall M \in V(G^L[\widetilde{M}])$. For $p \in \widetilde{M}$, let V_p be the intersection of $\widehat{s}(p)$ manifolds $M_1, M_2, \dots, M_{\widehat{s}(p)}$ with functions $f_{M_i}, 1 \leq i \leq \widehat{s}(p)$ in Lemma 2.1 existed. Define a mapping $\widetilde{F} : \widetilde{M} \rightarrow N$ at p by

$$\widetilde{F}(p) = \sum_{i=1}^{\widehat{s}(p)} f_{M_i} F_{M_i}.$$

Then \widetilde{F} is smooth at each point in \widetilde{M} for the smooth of each F_{M_i} and $\widetilde{F}_{*p} : T_p \widetilde{M} \rightarrow T_p N$ is one-to-one since each $(F_{M_i})_{*p}$ is one-to-one at the point p . Whence, \widetilde{M} can be embedded into the manifold N . □

Theorem 6.3.3 *Let \widetilde{M} and \widetilde{N} be smoothly combinatorial manifolds. If for $\forall M \in V(G^L[\widetilde{M}])$, there exists an embedding $F_M : M \rightarrow \widetilde{N}$, then \widetilde{M} can be embedded into \widetilde{N} .*

Proof Applying Theorem 5.6.2, we can get a mapping $\widetilde{F} : \widetilde{M} \rightarrow \widetilde{N}$ defined by

$$\widetilde{F}(p) = \sum_{i=1}^{\widehat{s}(p)} f_{M_i} F_{M_i}$$

at $\forall p \in \widetilde{M}$. Similar to the proof of Theorem 2.2, we know that \widetilde{F} is smooth and $\widetilde{F}_{*p} : T_p \widetilde{M} \rightarrow T_p \widetilde{N}$ is one-to-one. Whence, \widetilde{M} can be embedded into \widetilde{N} . □

6.3.2 Embedded in Combinatorial Euclidean Space. For a given integer sequence $k_1, n_2, \dots, k_l, l \geq 1$ with $0 < k_1 < k_2 < \dots < k_l$, a *combinatorial Euclidean space* $\widetilde{\mathbf{R}}(k_1, \dots, k_l)$ is a union of finitely Euclidean spaces $\bigcup_{i=1}^l \mathbf{R}^{k_i}$ such that for $\forall p \in \widetilde{\mathbf{R}}(k_1, \dots, k_l), p \in \bigcap_{i=1}^l \mathbf{R}^{k_i}$ with $\widehat{l} = \dim(\bigcap_{i=1}^l \mathbf{R}^{k_i})$ a constant. For a given combinatorial manifold $\widetilde{M}(n_1, n_2, \dots, n_m)$, *wether it can be realized in a combinatorial Euclidean space $\widetilde{\mathbf{R}}(k_1, \dots, k_l)$?* We consider this problem with twofold in this section, i.e., topological or isometry embedding of a combinatorial manifold in combinatorial Euclidean spaces.

Given two topological spaces \mathcal{C}_1 and \mathcal{C}_2 , a *topological embedding* of \mathcal{C}_1 in \mathcal{C}_2 is a one-to-one continuous map

$$f : \mathcal{C}_1 \rightarrow \mathcal{C}_2.$$

When $f : \widetilde{M}(n_1, n_2, \dots, n_m) \rightarrow \widetilde{\mathbf{R}}(k_1, \dots, k_l)$ maps each manifold of \widetilde{M} to an Euclidean space of $\widetilde{\mathbf{R}}(k_1, \dots, k_l)$, we say that \widetilde{M} is in-embedded into $\widetilde{\mathbf{R}}(k_1, \dots, k_l)$.

Whitney had proved once that *any n -manifold can be topological embedded as a closed submanifold of \mathbf{R}^{2n+1} with a sharply minimum dimension $2n + 1$* in 1936 ([AbM1]). Applying Whitney’s result enables us to find conditions of a finitely combinatorial manifold embedded into a combinatorial Euclidean space $\widetilde{\mathbf{R}}(k_1, \dots, k_l)$.

Theorem 6.3.4 *Any finitely combinatorial manifold $\widetilde{M}(n_1, n_2, \dots, n_m)$ can be embedded into \mathbf{R}^{2n_m+1} .*

Proof According to Whitney’s result, each manifold $M^{n_i}, 1 \leq i \leq m$, in $\widetilde{M}(n_1, n_2, \dots, n_m)$ can be topological embedded into a Euclidean space \mathbf{R}^η for any $\eta \geq 2n_i + 1$. By assumption, $n_1 < n_2 < \dots < n_m$. Whence, any manifold in $\widetilde{M}(n_1, n_2, \dots, n_m)$ can be embedded into \mathbf{R}^{2n_m+1} . Applying Theorem 6.3.2, we know that $\widetilde{M}(n_1, n_2, \dots, n_m)$ can be embedded into \mathbf{R}^{2n_m+1} . \square

For in-embedding a finitely combinatorial manifold $\widetilde{M}(n_1, n_2, \dots, n_m)$ into combinatorial Euclidean spaces $\widetilde{\mathbf{R}}(k_1, \dots, k_l)$, we get the next result.

Theorem 6.3.5 *Any finitely combinatorial manifold $\widetilde{M}(n_1, n_2, \dots, n_m)$ can be in-embedded into a combinatorial Euclidean space $\widetilde{\mathbf{R}}(k_1, \dots, k_l)$ if there is an injection*

$$\varpi : \{n_1, n_2, \dots, n_m\} \rightarrow \{k_1, k_2, \dots, k_l\}$$

such that

$$\varpi(n_i) \geq \max\{2\epsilon + 1 \mid \forall \epsilon \in \varpi^{-1}(\varpi(n_i))\}$$

and

$$\dim(\mathbf{R}^{\varpi(n_i)} \cap \mathbf{R}^{\varpi(n_j)}) \geq 2\dim(M^{n_i} \cap M^{n_j}) + 1$$

for any integer $i, j, 1 \leq i, j \leq m$ with $M^{n_i} \cap M^{n_j} \neq \emptyset$.

Proof Notice that if

$$\varpi(n_i) \geq \max\{2\epsilon + 1 \mid \forall \epsilon \in \varpi^{-1}(\varpi(n_i))\}$$

for any integer $i, 1 \leq i \leq m$, then each manifold $M^\epsilon, \forall \epsilon \in \varpi^{-1}(\varpi(n_i))$ can be embedded into $\mathbf{R}^{\varpi(n_i)}$ and for $\forall \epsilon_1 \in \varpi^{-1}(n_i), \forall \epsilon_2 \in \varpi^{-1}(n_j), M^{\epsilon_1} \cap M^{\epsilon_2}$ can be in-embedded into $\mathbf{R}^{\varpi(n_i)} \cap \mathbf{R}^{\varpi(n_j)}$ if $M^{\epsilon_1} \cap M^{\epsilon_2} \neq \emptyset$ by Whitney's result. In this case, a few manifolds in $\widetilde{M}(n_1, n_2, \dots, n_m)$ may be in-embedded into one Euclidean space $\mathbf{R}^{\varpi(n_i)}$ for any integer $i, 1 \leq i \leq m$. Therefore, by applying Theorem 2.3 we know that $\widetilde{M}(n_1, n_2, \dots, n_m)$ can be in-embedded into a combinatorial Euclidean space $\widetilde{\mathbf{R}}(k_1, \dots, k_l)$. \square

If $l = 1$ in Theorem 6.3.5, then we obtain Theorem 6.3.4 once more since $\varpi(n_i)$ is a constant in this case. But on a classical viewpoint, Theorem 6.3.4 is more accepted for it presents the appearances of a combinatorial manifold in a classical space. Certainly, we can also get concrete conclusions for practical usefulness by Theorem 6.3.5, such as the next result.

Corollary 6.3.1 *Any finitely combinatorial manifold $\widetilde{M}(n_1, n_2, \dots, n_m)$ can be in-embedded into a combinatorial Euclidean space $\widetilde{\mathbf{R}}(k_1, \dots, k_l)$ if*

- (i) $l \geq m$;
- (ii) *there exists m different integers $k_{i_1}, k_{i_2}, \dots, k_{i_m} \in \{k_1, k_2, \dots, k_l\}$ such that*

$$k_{i_j} \geq 2n_j + 1$$

and

$$\dim(\mathbf{R}^{k_{i_j}} \cap \mathbf{R}^{k_{i_r}}) \geq 2\dim(M^{n_j} \cap M^{n_r}) + 1$$

for any integer $i, j, 1 \leq i, j \leq m$ with $M^{n_j} \cap M^{n_r} \neq \emptyset$.

Proof Choose an injection

$$\pi : \{n_1, n_2, \dots, n_m\} \rightarrow \{k_1, k_2, \dots, k_l\}$$

by $\pi(n_j) = k_{i_j}$ for $1 \leq j \leq m$. Then conditions (i) and (ii) implies that π is an injection satisfying conditions in Theorem 5.2. Whence, $\widetilde{M}(n_1, n_2, \dots, n_m)$ can be in-embedded into $\widetilde{\mathbf{R}}(k_1, \dots, k_l)$. \square

For two given combinatorial Riemannian C^r -manifolds $(\widetilde{M}, g, \widetilde{D}_{\widetilde{M}})$ and $(\widetilde{N}, g_{\widetilde{N}}, \widetilde{D})$, an *isometry embedding*

$$\tilde{i} : \widetilde{M} \rightarrow \widetilde{N}$$

is an embedding with $g = \tilde{i}^* g_{\widetilde{N}}$. By those discussions in Sections 6.1 and 6.2, let the local charts of \widetilde{M} , \widetilde{N} be $(U, [x])$, $(V, [y])$ and the metrics in \widetilde{M} , \widetilde{N} to be respective

$$g_{\widetilde{N}} = \sum_{(\varsigma\tau), (\vartheta\iota)} g_{\widetilde{N}(\varsigma\tau)(\vartheta\iota)} dy^{\varsigma\tau} \otimes dy^{\vartheta\iota}, \quad g = \sum_{(\mu\nu), (\kappa\lambda)} g_{(\mu\nu)(\kappa\lambda)} dx^{\mu\nu} \otimes dx^{\kappa\lambda},$$

then an isometry embedding \tilde{i} from \widetilde{M} to \widetilde{N} need us to determine whether there are functions

$$y^{\kappa\lambda} = i^{\kappa\lambda}[x^{\mu\nu}], \quad 1 \leq \mu \leq s(p), \quad 1 \leq \nu \leq n_{s(p)}$$

for $\forall p \in \widetilde{M}$ such that

$$\widetilde{R}_{(ab)(cd)(ef)(gh)} = (\widetilde{R}_{\widetilde{N}})_{(ab)(cd)(ef)(gh)} - \sum_{\alpha, \beta} (h_{(ab)(ef)}^{\alpha\beta} h_{(cd)(gh)}^{\alpha\beta} - h_{(ab)(gh)}^{\alpha\beta} h_{(cd)(ef)}^{\alpha\beta}),$$

$$h_{(ab)(cd)(ef)}^{\alpha\beta} - h_{(ab)(ef)(cd)}^{\alpha\beta} = (\widetilde{R}_{\widetilde{N}})_{(\alpha\beta)(ab)(cd)(ef)},$$

$$\widetilde{R}_{(\alpha\beta)(\gamma\delta)(ab)(cd)}^{\perp} = (\widetilde{R}_{\widetilde{N}})_{(\alpha\beta)(\gamma\delta)(ab)(cd)} - \sum_{e, f} (h_{(ab)(ef)}^{\alpha\beta} h_{(cd)(gh)}^{\gamma\delta} - h_{(cd)(ef)}^{\alpha\beta\gamma\delta} h_{(ab)(gh)}^{\gamma\delta})$$

with $\widetilde{R}_{(\alpha\beta)(\gamma\delta)(ab)(cd)}^{\perp} = \langle \widetilde{R}(e_{ab}, e_{cd}) e_{\alpha\beta}, e_{\gamma\delta} \rangle$,

$$h_{(ab)(cd)(ef)}^{\alpha\beta} \omega^{ef} = \widetilde{d} h_{(ab)(cd)}^{\alpha\beta} - \omega_{ab}^{ef} h_{(ef)(cd)}^{\alpha\beta} - \omega_{cd}^{ef} h_{(ab)(ef)}^{\alpha\beta} + \omega_{\gamma\delta}^{\alpha\beta} h_{(ab)(cd)}^{\gamma\delta}$$

and

$$\sum_{(\varsigma\tau), (\vartheta\iota)} g_{\widetilde{N}(\varsigma\tau)(\vartheta\iota)} (\tilde{i}[x]) \frac{\partial i^{\varsigma\tau}}{\partial x^{\mu\nu}} \frac{\partial i^{\vartheta\iota}}{\partial x^{\kappa\lambda}} = g_{(\mu\nu)(\kappa\lambda)}[x].$$

For embedding a combinatorial manifold into a combinatorial Euclidean space $\widetilde{\mathbf{R}}(k_1, \dots, k_l)$, the last equation can be replaced by

$$\sum_{(\varsigma\tau)} \frac{\partial i^{\varsigma\tau}}{\partial y^{\mu\nu}} \frac{\partial i^{\kappa\lambda}}{\partial y^{\kappa\lambda}} = g_{(\mu\nu)(\kappa\lambda)}[y]$$

since a combinatorial Euclidean space $\widetilde{\mathbf{R}}(k_1, \dots, k_l)$ is equivalent to a Euclidean space $\mathbf{R}^{\widetilde{k}}$ with a constant $\widetilde{k} = \widehat{l}(p) + \sum_{i=1}^{l(p)} (k_i - \widehat{l}(p))$ for $\forall p \in \mathbf{R}^{\widetilde{k}}$ but not dependent on p (see [9] for details) and the metric of a Euclidean space $\mathbf{R}^{\widetilde{k}}$ to be

$$g_{\widetilde{\mathbf{R}}} = \sum_{\mu,\nu} dy^{\mu\nu} \otimes dy^{\mu\nu}.$$

These combined with additional conditions enable us to find necessary and sufficient conditions for existing particular combinatorial Riemannian submanifolds.

Similar to Theorems 6.3.4 and 6.3.5, we can also get sufficient conditions on isometry embedding by applying Theorem 5.6.2, i.e., the partition of unity. Firstly, we need two important lemmas following.

Lemma 6.3.1([ChL1]) *For any integer $n \geq 1$, a Riemannian C^r -manifold of dimensional n with $2 < r \leq \infty$ can be isometrically embedded into the Euclidean space $\mathbf{R}^{n^2+10n+3}$.*

Lemma 6.3.2 *Let $(\widetilde{M}, g, \widetilde{D}_{\widetilde{M}})$ and $(\widetilde{N}, g_{\widetilde{N}}, \widetilde{D})$ be combinatorial Riemannian manifolds. If for $\forall M \in V(G^L[\widetilde{M}])$, there exists an isometry embedding $F_M : M \rightarrow \widetilde{N}$, then \widetilde{M} can be isometrically embedded into \widetilde{N} .*

Proof Similar to the proof of Theorems 6.3.2 and 6.3.3, we only need to prove that the mapping $\widetilde{F} : \widetilde{M} \rightarrow \widetilde{N}$ defined by

$$\widetilde{F}(p) = \sum_{i=1}^{\widehat{s}(p)} f_{M_i} F_{M_i}$$

is an isometry embedding. In fact, for $p \in \widetilde{M}$ we have already known that

$$g_{\widetilde{N}}((F_{M_i})_*(v), (F_{M_i})_*(w)) = g(v, w)$$

for $\forall v, w \in T_p \widetilde{M}$ and $i, 1 \leq i \leq \widehat{s}(p)$. By definition we know that

$$g_{\widetilde{N}}(\widetilde{F}_*(v), \widetilde{F}_*(w)) = g_{\widetilde{N}}\left(\sum_{i=1}^{\widehat{s}(p)} f_{M_i} (F_{M_i})_*(v), \sum_{j=1}^{\widehat{s}(p)} f_{M_j} (F_{M_j})_*(w)\right)$$

$$\begin{aligned}
&= \sum_{i=1}^{\widehat{s}(p)} \sum_{j=1}^{\widehat{s}(p)} g_{\widetilde{N}}(f_{M_i}(F_{M_i})(v), f_{M_j}(F_{M_j})(w)) \\
&= \sum_{i=1}^{\widehat{s}(p)} \sum_{j=1}^{\widehat{s}(p)} g(f_{M_i}(F_{M_i})(v), f_{M_j}(F_{M_j})(w)) \\
&= g\left(\sum_{i=1}^{\widehat{s}(p)} f_{M_i}v, \sum_{j=1}^{\widehat{s}(p)} f_{M_j}w\right) \\
&= g(v, w).
\end{aligned}$$

Therefore, \widetilde{F} is an isometry embedding. \square

Applying Lemmas 6.3.1 and 6.3.2, we get results on isometry embedding of a combinatorial manifolds into combinatorial Euclidean spaces following.

Theorem 6.3.6 *Any combinatorial Riemannian manifold $\widetilde{M}(n_1, n_2, \dots, n_m)$ can be isometrically embedded into $\mathbf{R}^{n_m^2+10n_m+3}$.*

Proof According to Lemma 6.3.1, each manifold M^{n_i} , $1 \leq i \leq m$, in $\widetilde{M}(n_1, n_2, \dots, n_m)$ can be isometrically embedded into a Euclidean space \mathbf{R}^η for any $\eta \geq n_i^2 + 10n_i + 3$. By assumption, $n_1 < n_2 < \dots < n_m$. Thereafter, each manifold in $\widetilde{M}(n_1, n_2, \dots, n_m)$ can be embedded into $\mathbf{R}^{n_m^2+10n_m+3}$. Applying Lemma 6.3.2, we know that $\widetilde{M}(n_1, n_2, \dots, n_m)$ can be isometrically embedded into $\mathbf{R}^{n_m^2+10n_m+3}$. \square

Theorem 6.3.7 *A combinatorial Riemannian manifold $\widetilde{M}(n_1, n_2, \dots, n_m)$ can be isometrically embedded into a combinatorial Euclidean space $\widehat{\mathbf{R}}(k_1, \dots, k_l)$ if there is an injection*

$$\varpi : \{n_1, n_2, \dots, n_m\} \rightarrow \{k_1, k_2, \dots, k_l\}$$

such that

$$\varpi(n_i) \geq \max\{\epsilon^2 + 10\epsilon + 3 \mid \forall \epsilon \in \varpi^{-1}(\varpi(n_i))\}$$

and

$$\dim(\mathbf{R}^{\varpi(n_i)} \cap \mathbf{R}^{\varpi(n_j)}) \geq \dim^2(M^{n_i} \cap M^{n_j}) + 10\dim(M^{n_i} \cap M^{n_j}) + 3$$

for any integer $i, j, 1 \leq i, j \leq m$ with $M^{n_i} \cap M^{n_j} \neq \emptyset$.

Proof If

$$\varpi(n_i) \geq \max\{\epsilon^2 + 10\epsilon + 3 \mid \forall \epsilon \in \varpi^{-1}(\varpi(n_i))\}$$

for any integer $i, 1 \leq i \leq m$, then each manifold $M^\epsilon, \forall \epsilon \in \varpi^{-1}(\varpi(n_i))$ can be isometrically embedded into $\mathbf{R}^{\varpi(n_i)}$ and for $\forall \epsilon_1 \in \varpi^{-1}(n_i), \forall \epsilon_2 \in \varpi^{-1}(n_j), M^{\epsilon_1} \cap M^{\epsilon_2}$ can be isometrically embedded into $\mathbf{R}^{\varpi(n_i)} \cap \mathbf{R}^{\varpi(n_j)}$ if $M^{\epsilon_1} \cap M^{\epsilon_2} \neq \emptyset$ by Lemma 6.3.1. Notice that in this case, several manifolds in $\widetilde{M}(n_1, n_2, \dots, n_m)$ may be isometrically embedded into one Euclidean space $\mathbf{R}^{\varpi(n_i)}$ for any integer $i, 1 \leq i \leq m$. Now applying Lemma 5.2 we know that $\widetilde{M}(n_1, n_2, \dots, n_m)$ can be isometrically embedded into a combinatorial Euclidean space $\widetilde{\mathbf{R}}(k_1, \dots, k_l)$. \square

Similar to the proof of Corollary 6.3.1, we can get a more clearly condition for isometry embedding of combinatorial Riemannian manifolds into combinatorial Euclidean spaces.

Corollary 6.3.2 *A combinatorial Riemannian manifold $\widetilde{M}(n_1, n_2, \dots, n_m)$ can be isometry embedded into a combinatorial Euclidean space $\widetilde{\mathbf{R}}(k_1, \dots, k_l)$ if*

(i) $l \geq m$;

(ii) *there exists m different integers $k_{i_1}, k_{i_2}, \dots, k_{i_m} \in \{k_1, k_2, \dots, k_l\}$ such that*

$$k_{i_j} \geq n_j^2 + 10n_j + 3$$

and

$$\dim(\mathbf{R}^{k_{i_j}} \cap \mathbf{R}^{k_{i_r}}) \geq \dim^2(\widetilde{M}^{n_j} \cap \widetilde{M}^{n_r}) + 10\dim(\widetilde{M}^{n_j} \cap \widetilde{M}^{n_r}) + 3$$

for any integer $i, j, 1 \leq i, j \leq m$ with $M^{n_j} \cap M^{n_r} \neq \emptyset$.

§6.4 TOPOLOGICAL MULTI-GROUPS

6.4.1 Topological Multi-Group. An algebraic multi-system $(\widetilde{\mathcal{A}}; \mathcal{O})$ with $\widetilde{\mathcal{A}} = \bigcup_{i=1}^m \mathcal{H}_i$ and $\mathcal{O} = \bigcup_{i=1}^m \{\circ_i\}$ is called a *topological multi-group* if

(i) $(\mathcal{H}_i; \circ_i)$ is a group for each integer $i, 1 \leq i \leq m$, namely, $(\mathcal{H}, \mathcal{O})$ is a multi-group;

(ii) $\widetilde{\mathcal{A}}$ is a combinatorial topological space \mathcal{S}_G ;

(iii) the mapping $(a, b) \rightarrow a \circ b^{-1}$ is continuous for $\forall a, b \in \mathcal{H}_i, \forall \circ \in \mathcal{O}_i, 1 \leq i \leq m$.

Denoted by $(\mathcal{S}_G; \mathcal{O})$ a topological multi-group. Particularly, if $m = 1$ in $(\widetilde{\mathcal{A}}; \mathcal{O})$, i.e., $\widetilde{\mathcal{A}} = \mathcal{H}, \mathcal{O} = \{\circ\}$ with conditions following hold,

(i') $(\mathcal{H}; \circ)$ is a group;

(ii') \mathcal{H} is a topological space;

(iii') the mapping $(a, b) \rightarrow a \circ b^{-1}$ is continuous for $\forall a, b \in \mathcal{H}$,

then \mathcal{H} is nothing but a *topological group* in classical mathematics. The existence of topological multi-groups is shown in the following examples.

Example 6.4.1 Let $\mathbf{R}^{n_i}, 1 \leq i \leq m$ be Euclidean spaces with an additive operation $+_i$ and scalar multiplication \cdot determined by

$$\begin{aligned} & (\lambda_1 \cdot x_1, \lambda_2 \cdot x_2, \dots, \lambda_{n_i} \cdot x_{n_i}) +_i (\zeta_1 \cdot y_1, \zeta_2 \cdot y_2, \dots, \zeta_{n_i} \cdot y_{n_i}) \\ &= (\lambda_1 \cdot x_1 + \zeta_1 \cdot y_1, \lambda_2 \cdot x_2 + \zeta_2 \cdot y_2, \dots, \lambda_{n_i} \cdot x_{n_i} + \zeta_{n_i} \cdot y_{n_i}) \end{aligned}$$

for $\forall \lambda_t, \zeta_t \in \mathbf{R}$, where $1 \leq \lambda_t, \zeta_t \leq n_i$. Then each \mathbf{R}^{n_i} is a continuous group under $+_i$. Whence, the algebraic multi-system $(\mathcal{E}_G(n_1, \dots, n_m); \mathcal{O})$ is a topological multi-group with a underlying structure G by definition, where $\mathcal{E}_G(n_1, \dots, n_m)$ is a combinatorial Euclidean space defined in Section 4.1, and $\mathcal{O} = \bigcup_{i=1}^m \{+_i\}$. Particularly, if $m = 1$, i.e., an n -dimensional Euclidean space \mathbf{R}^n with the vector additive $+$ and multiplication \cdot is a topological group.

Example 6.4.2 Notice that there is function $\kappa : M_{n \times n} \rightarrow \mathbf{R}^{n^2}$ from real $n \times n$ -matrices $M_{n \times n}$ to \mathbf{R} determined by

$$\kappa : \begin{pmatrix} a_{11} & \cdots & a_{1n} \\ a_{21} & \cdots & a_{2n} \\ \dots & \dots & \dots \\ a_{n1} & \cdots & a_{n \times n} \end{pmatrix} \rightarrow (a_{11} \quad \cdots \quad a_{1n}, \dots, a_{n1} \quad \cdots \quad a_{n \times n})$$

Denoted all $n \times n$ -matrices by $\mathbf{M}(n, \mathbf{R})$. Then the general linear group of degree n is defined by

$$GL(n, \mathbf{R}) = \{ M \in \mathbf{M}(n, \mathbf{R}) \mid \det M \neq 0 \},$$

where $\det M$ is the determinant of M . It can be shown that $GL(n, \mathbf{R})$ is a topological group. In fact, since the function $\det : M_{n \times n} \rightarrow \mathbf{R}$ is continuous, $\det^{-1}\mathbf{R} \setminus \{0\}$ is open in \mathbf{R}^{n^2} , and hence an open subset of \mathbf{R}^{n^2} .

We show the mappings $\phi : GL(n, \mathbf{R} \times GL(n, \mathbf{R})) \rightarrow GL(n, \mathbf{R})$ and $\psi : GL(n, \mathbf{R}) \rightarrow GL(n, \mathbf{R})$ determined by $\phi(a, b) = ab$ and $\psi(a) = a^{-1}$ are both continuous for $a, b \in GL(n, \mathbf{R})$. Let $a = (a_{ij})_{n \times n}$ and $b = (b_{ij})_{n \times n} \in M(n, \mathbf{R})$. By definition, we know that

$$ab = ((ab)_{ij}) = \left(\sum_{k=1}^n a_{ik}b_{kj} \right).$$

Whence, $\phi(a, b) = ab$ is continuous. Similarly, let $\psi(a) = (\psi_{ij})_{n \times n}$. Then we know that

$$\psi_{ij} = \frac{a_{ij}^*}{\det a}$$

is continuous, where a_{ij}^* is the cofactor of a_{ij} in the determinant $\det a$. Therefore, $GL(n, \mathbf{R})$ is a topological group.

Now for integers $n_1, n_2, \dots, n_m \geq 1$, let $\mathcal{E}_G(GL_{n_1}, \dots, GL_{n_m})$ be a multi-group consisting of $GL(n_1, \mathbf{R}), GL(n_2, \mathbf{R}), \dots, GL(n_m, \mathbf{R})$ underlying a combinatorial structure G . Then it is itself a combinatorial space. Whence, $\mathcal{E}_G(GL_{n_1}, \dots, GL_{n_m})$ is a topological multi-group.

A topological space S is *homogenous* if for $\forall a, b \in S$, there exists a continuous mapping $f : S \rightarrow S$ such that $f(b) = a$. We have the next result.

Theorem 6.4.1 *If a topological multi-group $(\mathcal{S}_G; \mathcal{O})$ is arcwise connected and associative, then it is homogenous.*

Proof Notice that \mathcal{S}_G is arcwise connected if and only if its underlying graph G is connected. For $\forall a, b \in \mathcal{S}_G$, without loss of generality, assume $a \in \mathcal{H}_0$ and $b \in \mathcal{H}_s$ and

$$P(a, b) = \mathcal{H}_0 \mathcal{H}_1 \cdots \mathcal{H}_s, \quad s \geq 0,$$

a path from \mathcal{H}_0 to \mathcal{H}_s in the graph G . Choose $c_1 \in \mathcal{H}_0 \cap \mathcal{H}_1, c_2 \in \mathcal{H}_1 \cap \mathcal{H}_2, \dots, c_s \in \mathcal{H}_{s-1} \cap \mathcal{H}_s$. Then

$$a \circ_0 c_1 \circ_1 c_1^{-1} \circ_2 c_2 \circ_3 c_3 \circ_4 \cdots \circ_{s-1} c_s^{-1} \circ_s b^{-1}$$

is well-defined and

$$a \circ_0 c_1 \circ_1 c_1^{-1} \circ_2 c_2 \circ_3 c_3 \circ_4 \cdots \circ_{s-1} c_s^{-1} \circ_s b^{-1} \circ_s b = a.$$

Let $L = a \circ_0 c_1 \circ_1 c_1^{-1} \circ_2 c_2 \circ_3 c_3 \circ_4 \cdots \circ_{s-1} c_s^{-1} \circ_s b^{-1} \circ_s$. Then L is continuous by the definition of topological multi-group. We finally get a continuous mapping $L : \mathcal{S}_G \rightarrow \mathcal{S}_G$ such that $L(b) = Lb = a$. Whence, $(\mathcal{S}_G; \mathcal{O})$ is homogenous. \square

Corollary 6.4.1 *A topological group is homogenous if it is arcwise connected.*

A multi-subsystem $(\mathcal{L}_H; \mathcal{O})$ of $(\mathcal{S}_G; \mathcal{O})$ is called a *topological multi-subgroup* if it itself is a topological multi-group. Denoted by $\mathcal{L}_H \leq \mathcal{S}_G$. A criterion on topological multi-subgroups is shown in the following.

Theorem 6.4.2 *A multi-subsystem $(\mathcal{L}_H; \mathcal{O}_1)$ is a topological multi-subgroup of $(\mathcal{S}_G; \mathcal{O})$, where $\mathcal{O}_1 \subset \mathcal{O}$ if and only if it is a multi-subgroup of $(\mathcal{S}_G; \mathcal{O})$ in algebra.*

Proof The necessity is obvious. For the sufficiency, we only need to prove that for any operation $\circ \in \mathcal{O}_1$, $a \circ b^{-1}$ is continuous in \mathcal{L}_H . Notice that the condition (iii) in the definition of topological multi-group can be replaced by:

for any neighborhood $N_{\mathcal{S}_G}(a \circ b^{-1})$ of $a \circ b^{-1}$ in \mathcal{S}_G , there always exist neighborhoods $N_{\mathcal{S}_G}(a)$ and $N_{\mathcal{S}_G}(b^{-1})$ of a and b^{-1} such that $N_{\mathcal{S}_G}(a) \circ N_{\mathcal{S}_G}(b^{-1}) \subset N_{\mathcal{S}_G}(a \circ b^{-1})$, where $N_{\mathcal{S}_G}(a) \circ N_{\mathcal{S}_G}(b^{-1}) = \{x \circ y | \forall x \in N_{\mathcal{S}_G}(a), y \in N_{\mathcal{S}_G}(b^{-1})\}$

by the definition of mapping continuity. Whence, we only need to show that for any neighborhood $N_{\mathcal{L}_H}(x \circ y^{-1})$ in \mathcal{L}_H , where $x, y \in \mathcal{L}_H$ and $\circ \in \mathcal{O}_1$, there exist neighborhoods $N_{\mathcal{L}_H}(x)$ and $N_{\mathcal{L}_H}(y^{-1})$ such that $N_{\mathcal{L}_H}(x) \circ N_{\mathcal{L}_H}(y^{-1}) \subset N_{\mathcal{L}_H}(x \circ y^{-1})$ in \mathcal{L}_H . In fact, each neighborhood $N_{\mathcal{L}_H}(x \circ y^{-1})$ of $x \circ y^{-1}$ can be represented by a form $N_{\mathcal{S}_G}(x \circ y^{-1}) \cap \mathcal{L}_H$. By assumption, $(\mathcal{S}_G; \mathcal{O})$ is a topological multi-group, we know that there are neighborhoods $N_{\mathcal{S}_G}(x)$, $N_{\mathcal{S}_G}(y^{-1})$ of x and y^{-1} in \mathcal{S}_G such that $N_{\mathcal{S}_G}(x) \circ N_{\mathcal{S}_G}(y^{-1}) \subset N_{\mathcal{S}_G}(x \circ y^{-1})$. Notice that $N_{\mathcal{S}_G}(x) \cap \mathcal{L}_H$, $N_{\mathcal{S}_G}(y^{-1}) \cap \mathcal{L}_H$ are neighborhoods of x and y^{-1} in \mathcal{L}_H . Now let $N_{\mathcal{L}_H}(x) = N_{\mathcal{S}_G}(x) \cap \mathcal{L}_H$ and $N_{\mathcal{L}_H}(y^{-1}) = N_{\mathcal{S}_G}(y^{-1}) \cap \mathcal{L}_H$. Then we get that $N_{\mathcal{L}_H}(x) \circ N_{\mathcal{L}_H}(y^{-1}) \subset N_{\mathcal{L}_H}(x \circ y^{-1})$ in \mathcal{L}_H , i.e., the mapping $(x, y) \rightarrow x \circ y^{-1}$ is continuous. Whence, $(\mathcal{L}_H; \mathcal{O}_1)$ is a topological multi-subgroup. \square

Particularly, for the topological groups, we know the following consequence.

Corollary 6.4.2 *A subset of a topological group $(\Gamma; \circ)$ is a topological subgroup if and only if it is a subgroup of $(\Gamma; \circ)$ in algebra.*

For two topological multi-groups $(\mathcal{S}_{G_1}; \mathcal{O}_1)$ and $(\mathcal{S}_{G_2}; \mathcal{O}_2)$, a mapping $\omega : (\mathcal{S}_{G_1}; \mathcal{O}_1) \rightarrow (\mathcal{S}_{G_2}; \mathcal{O}_2)$ is a *homomorphism* if it satisfies the following conditions:

(1) ω is a homomorphism from multi-groups $(\mathcal{S}_{G_1}; \mathcal{O}_1)$ to $(\mathcal{S}_{G_2}; \mathcal{O}_2)$, namely, for $\forall a, b \in \mathcal{S}_{G_1}$ and $\circ \in \mathcal{O}_1$, $\omega(a \circ b) = \omega(a)\omega(\circ)\omega(b)$;

(2) ω is a continuous mapping from topological spaces \mathcal{S}_{G_1} to \mathcal{S}_{G_2} , i.e., for $\forall x \in \mathcal{S}_{G_1}$ and a neighborhood U of $\omega(x)$, $\omega^{-1}(U)$ is a neighborhood of x .

Furthermore, if $\omega : (\mathcal{S}_{G_1}; \mathcal{O}_1) \rightarrow (\mathcal{S}_{G_2}; \mathcal{O}_2)$ is an isomorphism in algebra and a homeomorphism in topology, then it is called an *isomorphism*, particularly, an *automorphism* if $(\mathcal{S}_{G_1}; \mathcal{O}_1) = (\mathcal{S}_{G_2}; \mathcal{O}_2)$ between topological multi-groups $(\mathcal{S}_{G_1}; \mathcal{O}_1)$ and $(\mathcal{S}_{G_2}; \mathcal{O}_2)$.

Let $(\mathcal{S}_G; \mathcal{O})$ be an associatively topological multi-subgroup and $(\mathcal{L}_H; \mathcal{O})$ one of its topological multi-subgroups with $\mathcal{S}_G = \bigcup_{i=1}^m \mathcal{H}_i$, $\mathcal{L}_H = \bigcup_{i=1}^m \mathcal{G}_i$ and $\mathcal{O} = \bigcup_{i=1}^m \{\circ_i\}$. According to Theorem 2.3.1 in Chapter 2, for any integer i , $1 \leq i \leq m$, we get a quotient group $\mathcal{H}_i/\mathcal{G}_i$, i.e., a multi-subgroup $(\mathcal{S}_G/\mathcal{L}_H; \mathcal{O}) = \bigcup_{i=1}^m (\mathcal{H}_i/\mathcal{G}_i; \circ_i)$ on algebraic multi-groups.

Notice that for a topological space S with an equivalent relation \sim and a projection $\pi : S \rightarrow S/\sim = \{[x]|\forall y \in [x], y \sim x\}$, we can introduce a topology on S/\sim by defining its opened sets to be subsets V in S/\sim such that $\pi^{-1}(V)$ is opened in S . Such topological space S/\sim is called a *quotient space*. Now define a relation in $(\mathcal{S}_G; \mathcal{O})$ by $a \sim b$ for $a, b \in \mathcal{S}_G$ providing $b = h \circ a$ for an element $h \in \mathcal{L}_H$ and an operation $\circ \in \mathcal{O}$. It is easily to know that such relation is an equivalence. Whence, we also get an induced quotient space $\mathcal{S}_G/\mathcal{L}_H$.

Theorem 6.4.3 *Let $\omega : (\mathcal{S}_{G_1}; \mathcal{O}_1) \rightarrow (\mathcal{S}_{G_2}; \mathcal{O}_2)$ be an opened onto homomorphism from associatively topological multi-groups $(\mathcal{S}_{G_1}; \mathcal{O}_1)$ to $(\mathcal{S}_{G_2}; \mathcal{O}_2)$, i.e., it maps an opened set to an opened set. Then there are representation pairs (R_1, \mathcal{P}_1) and (R_2, \mathcal{P}_2) such that*

$$\frac{(\mathcal{S}_{G_1}; \mathcal{O}_1)}{(\text{Ker}\omega; \mathcal{O}_1)} \Big|_{(R_1, \tilde{\mathcal{P}}_1)} \cong \frac{(\mathcal{S}_{G_2}; \mathcal{O}_2)}{(\mathcal{I}(\tilde{\mathcal{O}}_2); \tilde{\mathcal{O}}_2)} \Big|_{(R_2, \tilde{\mathcal{P}}_2)},$$

where $\mathcal{P}_1 \subset \mathcal{O}_1, \mathcal{P}_2 \subset \mathcal{O}_2, \mathcal{I}(\mathcal{O}_2) = \{1_\circ, \circ \in \mathcal{O}_2\}$ and

$$\widetilde{\text{Ker}\omega} = \{ a \in \mathcal{S}_{G_1} \mid \omega(a) = 1_o \in \mathcal{I}(\mathcal{O}_2) \}.$$

Proof According to Theorem 2.3.2 or Corollary 2.3.1, we know that there are representation pairs (R_1, \mathcal{P}_1) and (R_2, \mathcal{P}_2) such that

$$\frac{(\mathcal{S}_{G_1}; \mathcal{O}_1)}{(\widetilde{\text{Ker}\omega}; \mathcal{O}_1)} \Big|_{(R_1, \tilde{P}_1)} \cong \frac{(\mathcal{S}_{G_2}; \mathcal{O}_2)}{(\mathcal{I}(\tilde{\mathcal{O}}_2); \tilde{\mathcal{O}}_2)} \Big|_{(R_2, \tilde{P}_2)}$$

in algebra, where $\sigma(a \circ \text{Ker}\omega) = \sigma(a) \circ^{-1} \mathcal{I}(\mathcal{O}_2)$ in the proof of Theorem 2.3.2. We only need to prove that σ and σ^{-1} are continuous.

On the First, for $x = \sigma(a) \circ^{-1} \mathcal{I}(\mathcal{O}_2) \in \frac{(\mathcal{S}_{G_2}; \mathcal{O}_2)}{(\mathcal{I}(\mathcal{O}_2); \mathcal{O}_2)} \Big|_{(R_2, \tilde{P}_2)}$ let \hat{U} be a neighborhood of $\sigma^{-1}(x)$ in the space $\frac{(\mathcal{S}_{G_1}; \mathcal{O}_1)}{(\text{Ker}\omega; \mathcal{O}_1)} \Big|_{(R_1, \tilde{P}_1)}$, where \hat{U} is a union of $a \circ \text{Ker}\omega$ for a in an opened set U and $o \in \tilde{P}_1$. Since ω is opened, there is a neighborhood \hat{V} of x such that $\omega(U) \supset \hat{V}$, which enables us to find that $\sigma^{-1}(\hat{V}) \subset \hat{U}$. In fact, let $\hat{y} \in \hat{V}$. Then there exists $y \in U$ such that $\omega(y) = \hat{y}$. Whence, $\sigma^{-1}(\hat{y}) = y \circ \text{Ker}\omega \in \hat{U}$. Therefore, σ^{-1} is continuous.

On the other hand, let \hat{V} be a neighborhood of $\sigma(x) \circ^{-1} \mathcal{I}(\mathcal{O}_2)$ in the space $\frac{(\mathcal{S}_{G_2}; \mathcal{O}_2)}{(\mathcal{I}(\mathcal{O}_2); \mathcal{O}_2)} \Big|_{(R_2, \tilde{P}_2)}$ for $x \circ \text{Ker}\omega$. By the continuity of ω , we know that there is a neighborhood U of x such that $\omega(U) \subset \hat{V}$. Denoted by \hat{U} the union of all sets $z \circ \text{Ker}\omega$ for $z \in U$. Then $\sigma(\hat{U}) \subset \hat{V}$ because of $\omega(U) \subset \hat{V}$. Whence, σ is also continuous. Combining the continuity of σ and its inverse σ^{-1} , we know that σ is also a homeomorphism from topological spaces $\frac{(\mathcal{S}_{G_1}; \mathcal{O}_1)}{(\text{Ker}\omega; \mathcal{O}_1)} \Big|_{(R_1, \tilde{P}_1)}$ to $\frac{(\mathcal{S}_{G_2}; \mathcal{O}_2)}{(\mathcal{I}(\mathcal{O}_2); \mathcal{O}_2)} \Big|_{(R_2, \tilde{P}_2)}$. \square

Corollary 6.4.3 *Let $\omega : (\mathcal{S}_G; \mathcal{O}) \rightarrow (\mathcal{A}; \circ)$ be a onto homomorphism from a topological multi-group $(\mathcal{S}_G; \mathcal{O})$ to a topological group $(\mathcal{A}; \circ)$. Then there are representation pairs (R, \tilde{P}) , $\tilde{P} \subset \mathcal{O}$ such that*

$$\frac{(\mathcal{S}_G; \mathcal{O})}{(\text{Ker}\omega; \mathcal{O})} \Big|_{(R, \tilde{P})} \cong (\mathcal{A}; \circ).$$

Particularly, if $\mathcal{O} = \{\bullet\}$, i.e., $(\mathcal{S}_G; \bullet)$ is a topological group, then

$$\mathcal{S}_G / \text{Ker}\omega \cong (\mathcal{A}; \circ).$$

A distributive multi-system $(\tilde{\mathcal{A}}; \mathcal{O}_1 \hookrightarrow \mathcal{O}_2)$ with $\tilde{\mathcal{A}} = \bigcup_{i=1}^m \mathcal{H}_i$, $\mathcal{O}_1 = \bigcup_{i=1}^m \{+_i\}$ and $\mathcal{O}_2 = \bigcup_{i=1}^m \{+_i\}$ is called a *topological multi-ring* if

(i) $(\mathcal{H}_i; +_i, \cdot_i)$ is a ring for each integer i , $1 \leq i \leq m$, i.e., $(\mathcal{H}, \mathcal{O}_1 \hookrightarrow \mathcal{O}_2)$ is a multi-ring;

(ii) $\widetilde{\mathcal{A}}$ is a combinatorial topological space \mathcal{S}_G ;

(iii) the mappings $(a, b) \rightarrow a \cdot_i b^{-1}$, $(a, b) \rightarrow a +_i (-_i b)$ are continuous for $\forall a, b \in \mathcal{H}_i$, $1 \leq i \leq m$.

Denoted by $(\mathcal{S}_G; \mathcal{O}_1 \hookrightarrow \mathcal{O}_2)$ a topological multi-ring. A topological multi-ring $(\mathcal{S}_G; \mathcal{O}_1 \hookrightarrow \mathcal{O}_2)$ is called a *topological divisible multi-ring* or *multi-field* if the previous condition (i) is replaced by $(\mathcal{H}_i; +_i, \cdot_i)$ is a *divisible ring or field* for each integer $1 \leq i \leq m$. Particularly, if $m = 1$, then a topological multi-ring, divisible multi-ring or multi-field is nothing but a topological ring, divisible ring or field. Some examples of topological fields are presented in the following.

Example 6.4.3 A 1-dimensional Euclidean space \mathbf{R} is a topological field since \mathbf{R} is itself a field under operations additive $+$ and multiplication \times .

Example 6.4.4 A 2-dimensional Euclidean space \mathbf{R}^2 is isomorphic to a topological field since for $\forall(x, y) \in \mathbf{R}^2$, it can be endowed with a unique complex number $x + iy$, where $i^2 = -1$. It is well-known that all complex numbers form a field.

Example 6.4.5 A 4-dimensional Euclidean space \mathbf{R}^4 is isomorphic to a topological field since for each point $(x, y, z, w) \in \mathbf{R}^4$, it can be endowed with a unique quaternion number $x + iy + jz + kw$, where

$$ij = -ji = k, \quad jk = -kj = i, \quad ki = -ik = j,$$

and

$$i^2 = j^2 = k^2 = -1.$$

We know all such quaternion numbers form a field.

For topological fields, we have known a classification theorem following.

Theorem 6.4.4 *A locally compacted topological field is isomorphic to one of the following:*

- (i) *Euclidean real line \mathbf{R} , the real number field;*
- (ii) *Euclidean plane \mathbf{R}^2 , the complex number field;*
- (iii) *Euclidean space \mathbf{R}^4 , the quaternion number field.*

Proof The proof on this classification theorem is needed a careful analysis for the topological structure and finished by *Pontrjagin* in 1934. A complete proof on this theorem can be found in references [Pon1] or [Pon2]. □

Applying Theorem 6.4.4 enables one to determine these topological multi-fields.

Theorem 6.4.5 *For any connected graph G , a locally compacted topological multi-field $(\mathcal{S}_G; \mathcal{O}_1 \hookrightarrow \mathcal{O}_2)$ is isomorphic to one of the following:*

- (i) *Euclidean space \mathbf{R} , \mathbf{R}^2 or \mathbf{R}^4 endowed respectively with the real, complex or quaternion number for each point if $|G| = 1$;*
- (ii) *combinatorial Euclidean space $\mathcal{E}_G(2, \dots, 2, 4, \dots, 4)$ with coupling number, i.e., the dimensional number $l_{ij} = 1, 2$ or 3 of an edge $(\mathbf{R}^i, \mathbf{R}^j) \in E(G)$ only if $i = j = 4$, otherwise $l_{ij} = 1$ if $|G| \geq 2$.*

Proof By the definition of topological multi-field $(\mathcal{S}_G; \mathcal{O}_1 \hookrightarrow \mathcal{O}_2)$, for an integer i , $1 \leq i \leq m$, $(\mathcal{H}_i; +_i, \cdot_i)$ is itself a locally compacted topological field. Whence, $(\mathcal{S}_G; \mathcal{O}_1 \hookrightarrow \mathcal{O}_2)$ is a topologically combinatorial multi-field consisting of locally compacted topological fields. According to Theorem 6.4.4, we know there must be

$$(\mathcal{H}_i; +_i, \cdot_i) \cong \mathbf{R}, \mathbf{R}^2, \text{ or } \mathbf{R}^4$$

for each integer i , $1 \leq i \leq m$. Let the coordinate system of $\mathbf{R}, \mathbf{R}^2, \mathbf{R}^4$ be $x, (y_1, y_2)$ and (z_1, z_2, z_3, z_4) . If $|G| = 1$, then it is just the classifying in Theorem 6.4.4. Now let $|G| \geq 2$. For $\forall (\mathbf{R}^i, \mathbf{R}^j) \in E(G)$, we know that $\mathbf{R}^i \setminus \mathbf{R}^j \neq \emptyset$ and $\mathbf{R}^j \setminus \mathbf{R}^i \neq \emptyset$ by the definition of combinatorial space. Whence, $i, j = 2$ or 4. If $i = 2$ or $j = 2$, then $l_{ij} = 1$ because of $1 \leq l_{ij} < 2$, which means $l_{ij} \geq 2$ only if $i = j = 4$. This completes the proof. □

6.4.2 Lie Multi-Group. A *Lie multi-group* \mathcal{L}_G is a smoothly combinatorial manifold \widetilde{M} endowed with a multi-group $(\widetilde{\mathcal{A}}(\mathcal{L}_G); \mathcal{O}(\mathcal{L}_G))$, where $\widetilde{\mathcal{A}}(\mathcal{L}_G) = \bigcup_{i=1}^m \mathcal{H}_i$

and $\mathcal{O}(\mathcal{L}_G) = \bigcup_{i=1}^m \{\circ_i\}$ such that

- (i) $(\mathcal{H}_i; \circ_i)$ is a group for each integer i , $1 \leq i \leq m$;
- (ii) $G^L[\widetilde{M}] = G$;
- (iii) the mapping $(a, b) \rightarrow a \circ_i b^{-1}$ is C^∞ -differentiable for any integer i , $1 \leq i \leq m$ and $\forall a, b \in \mathcal{H}_i$.

Notice that if $m = 1$, then a Lie multi-group \mathcal{L}_G is nothing but just the Lie group in classical differential geometry. For example, the topological multi-groups shown in Examples 6.4.1 and 6.4.2 are Lie multi-groups since it is easily to know the mapping $(a, b) \rightarrow a \circ b^{-1}$ is C^∞ -differentiable for $a, b \in \widetilde{\mathcal{A}}$ providing the existence of $a \circ b^{-1}$. Furthermore, we give an important example following.

Example 6.4.6 An n -dimensional *special linear group*

$$SL(n, \mathbf{R}) = \{M \in GL(n, \mathbf{R}) \mid \det M = 1\}$$

is a Lie group. In fact, let $\det M : \mathbf{R}^{n^2} \rightarrow \mathbf{R}$ be the determinant function. We need to show that for $M \in \det^{-1}(1)$, $d(\det M) \neq 0$. If so, then applying the implicit function theorem, i.e., Theorem 3.2.6, $SL(n, \mathbf{R})$ is a smoothly manifold.

Let $M = (a_{ij})_{n \times n}$. Then

$$\det M = \sum_{\pi \in S_n} \text{sign} \pi \, a_{1\pi(1)} \cdots a_{n\pi(n)}.$$

whence, we get that

$$d(\det M) = \sum_{j=1}^n \sum_{\pi \in S_n} \text{sign} \pi \, a_{1\pi(1)} \cdots a_{j-1\pi(j-1)} a_{j+1\pi(j+1)} \cdots a_{n\pi(n)} da_{j\pi(j)}.$$

Notice that the coefficient in da_{ij} of the (i, j) entry in this sum is the determinant of the cofactor of a_{ij} in M . Therefore, they can not vanish all at any point of $\det^{-1}(1)$. Now since $\{da_{ij}\}$ is linearly independent, there must be $d(\det M) \neq 0$. So applying the implicit function theorem, we know that $SL(n, \mathbf{R})$ is a smoothly submanifold of $GL(n, \mathbf{R})$. Now let \widetilde{M}_G be a combinatorial manifold consisting of $GL(n_1, \mathbf{R}), GL(n_2, \mathbf{R}), \dots, GL(n_m, \mathbf{R})$ underlying a structure G . Then it is a Lie multi-group.

Definition 6.4.1 Let \mathcal{L}_G be a Lie multi-group with $\widetilde{\mathcal{A}}(\mathcal{L}_G) = \bigcup_{\circ \in \mathcal{O}} \mathcal{H}_\circ$ and $\mathcal{O}(\mathcal{L}_G) = \bigcup_{i=1}^m \{\circ_i\}$. For $g \in \widetilde{\mathcal{A}}(\mathcal{L}_G)$ and $\circ \in \mathcal{O}(\mathcal{L}_G)$, a left or right translation \widetilde{L}_g or \widetilde{R}_g of \mathcal{L}_G is a mapping $\widetilde{L}_g, \widetilde{R}_g : \mathcal{O}(\mathcal{L}_G) \times \widetilde{\mathcal{A}}(\mathcal{L}_G) \rightarrow \widetilde{\mathcal{A}}(\mathcal{L}_G)$ determined by

$$\widetilde{L}_g(\circ, h) = g \circ h, \text{ or } \widetilde{R}_g(h, \circ) = h \circ g$$

for $\forall h \in \widetilde{\mathcal{A}}(\mathcal{L}_G)$ and $a \circ \in \mathcal{O}(\mathcal{L}_G)$ provided $g \circ h$ exists.

Definition 6.4.2 A vector field X on a Lie multi-group \mathcal{L}_G is called locally left-invariant for $\circ \in \mathcal{O}(\mathcal{L}_G)$ if

$$d\tilde{L}_g X(\circ, x) = X(\tilde{L}_g(\circ, x))$$

holds for $\forall g, x \in \mathcal{H}_\circ$ and globally left-invariant if it is locally left-invariant for $\forall \circ \in \mathcal{O}(\mathcal{L}_G)$ and $\forall g \in \tilde{\mathcal{A}}(\mathcal{L}_G)$.

Theorem 6.4.6 A vector field X on a Lie multi-group \mathcal{L}_G is locally left-invariant for $\circ \in \mathcal{O}(\mathcal{L}_G)$ (or globally left-invariant) if and only if

$$d\tilde{L}_g X(\circ, \mathbf{1}_\circ) = X(g)$$

holds for $\forall g \in \mathcal{H}_\circ$ (or hold for $\forall g \in \tilde{\mathcal{A}}(\mathcal{L}_G)$ and $\forall \circ \in \mathcal{O}(\mathcal{L}_G)$).

Proof In fact, let $\circ \in \mathcal{O}(\mathcal{L}_G)$ and $g \in \mathcal{H}_\circ$ (or $g \in \tilde{\mathcal{A}}(\mathcal{L}_G)$). If X is locally left-invariant for $\circ \in \mathcal{O}(\mathcal{L}_G)$, then we know that

$$d\tilde{L}_g X(\circ, \mathbf{1}_\circ) = X(\tilde{L}_g(\circ, \mathbf{1}_\circ)) = X(g \circ \mathbf{1}_\circ) = X(g)$$

by definition. Conversely, if

$$d\tilde{L}_g X(\circ, \mathbf{1}_\circ) = X(g)$$

holds for $\forall g \in \mathcal{H}_\circ$ and $\circ \in \mathcal{O}(\mathcal{L}_G)$, let $x \in \mathcal{H}_\circ$. We get hat

$$\begin{aligned} X(\tilde{L}_g(\circ, x)) &= X(g \circ x) = d\tilde{L}_{g \circ x} X(\circ, \mathbf{1}_\circ) \\ &= d\tilde{L}_g \circ \tilde{L}_x(X(\circ, \mathbf{1}_\circ)) = d\tilde{L}_g(d\tilde{L}_x(X(\circ, \mathbf{1}_\circ))) \\ &= d\tilde{L}_g X(\circ, x). \end{aligned}$$

Whence, X is locally left-invariant for $\circ \in \mathcal{O}(\mathcal{L}_G)$.

Similarly, we know the conditions for \mathcal{L}_G being globally left-invariant. \square

Corollary 6.4.4 A vector field X on a Lie group \mathcal{G} is left-invariant if and only if

$$dL_g X(1_{\mathcal{G}}) = X(g)$$

for $\forall g \in \mathcal{G}$.

Recall that a *Lie algebra over a real field \mathbf{R}* is a pair $(\mathcal{F}, [\ , \])$, where \mathcal{F} is a vector space and $[\ , \] : \mathcal{F} \times \mathcal{F} \rightarrow \mathcal{F}$ with $(X, Y) \rightarrow [X, Y]$ a bilinear mapping such that

$$[a_1X_1 + a_2Y_2, Y] = a_1[X_1, Y] + a_2[X_2, Y],$$

$$[X, a_1Y_1 + a_2Y_2] = a_1[X, Y_1] + a_2[X, Y_2]$$

for $\forall a_1, a_2 \in \mathbf{R}$ and $X, Y, X_1, X_2, Y_1, Y_2 \in \mathcal{F}$. By Theorem 5.1.2, we know that

$$[X, Y] = 0,$$

$$[[X, Y], Z] + [[Y, Z], X] + [[Z, X], Y] = 0$$

for $X, Y, Z \in \mathcal{X}(\mathcal{L}_G)$. Notice that all vector fields in $\mathcal{X}(\mathcal{L}_G)$ forms a Lie algebra over \mathbf{R} , where, for $X, Y \in \mathcal{X}(\mathcal{L}_G)$, $p \in \mathcal{L}_G$, $f \in \mathcal{X}_p$ and $\lambda, \mu \in \mathbf{R}$, these $X + Y$, λX and $[X, Y] \in \mathcal{X}(\mathcal{L}_G)$ are defined by $(X + Y)f = Xf + Yf$, $(\lambda X)f = \lambda(Xf)$ and $[X, Y]v = X(Yf) - Y(Xf)$.

Now for a $\circ \in \mathcal{O}(\mathcal{L}_G)$, define

$$\mathfrak{Y}(\circ, \mathcal{L}_G) = \{ X \in \mathcal{X}(\mathcal{L}_G) \mid d\tilde{L}_g\bar{u}(\circ, x) = X(\tilde{L}_g(\circ, x)), \forall x \in \mathcal{H}_\circ \}$$

and

$$\tilde{\mathfrak{Y}}(\mathcal{L}_G) = \{ X \in \mathcal{X}(\mathcal{L}_G) \mid d\tilde{L}_gX(\circ, x) = X(\tilde{L}_g(\circ, x)), \forall \circ \in \mathcal{O}(\mathcal{L}_G) \text{ and } \forall x \in \mathcal{H}_\circ \},$$

i.e., the sets of all locally left-invariant vector fields for an operation \circ on \mathcal{L}_G and of all globally left-invariant fields. We can easily check that $\mathfrak{Y}(\circ, \mathcal{L}_G)$ is a Lie algebra.

In fact,

$$d\tilde{L}_g(\lambda X + \mu Y) = \lambda d\tilde{L}_gX + \mu d\tilde{L}_gY = \lambda X + \mu Y,$$

and

$$\begin{aligned} d\tilde{L}_g[X, Y](\circ, x) &= dX(Y(g \circ x)) - dY(X(g \circ x)) \\ &= dX(dY(g \circ x)) - dY(dX(g \circ x)) \\ &= dX \circ dY(g \circ x) - dY \circ dX(g \circ x) \\ &= [d\tilde{L}_gX(\circ, x), d\tilde{L}_gY(\circ, x)] = [d\tilde{L}_gX, d\tilde{L}_gY](\circ, x). \end{aligned}$$

Therefore, $\mathfrak{Y}(\circ, \mathcal{L}_G)$ is a Lie algebra. By definition, we know that

$$\tilde{\mathfrak{Y}}(\mathcal{L}_G) = \bigcap_{\circ \in \mathcal{O}} \mathfrak{Y}(\circ, \mathcal{L}_G).$$

Whence, $\tilde{\mathfrak{Y}}(\mathcal{L}_G)$ is also a Lie algebra by definition.

Theorem 6.4.7 *Let \mathcal{L}_G be a Lie multi-group. Then the mapping*

$$\Phi : \bigoplus_{\circ \in \mathcal{O}} \mathfrak{Y}(\circ, \mathcal{L}_G) \rightarrow \bigoplus_{\circ \in \mathcal{O}} T_{1_\circ}(\mathcal{L}_G)$$

determined by $\Phi(X) = X(\mathbf{1}_\circ)$ if $d\tilde{L}_g X(\circ, x) = X(\tilde{L}_g(\circ, x))$ for $\forall x \in \mathcal{H}_\circ$ is an isomorphism of $\bigoplus_{\circ \in \mathcal{O}} \mathfrak{Y}(\circ, \mathcal{L}_G)$ with direct sum of $T_{1_\circ}(\mathcal{L}_G)$ to \mathcal{L}_G at identities $\mathbf{1}_\circ$ for $\circ \in \mathcal{O}(\mathcal{L}_G)$.

Proof For an operation $\circ \in \mathcal{O}(\mathcal{L}_G)$, we show that $\Phi|_{\mathcal{H}_\circ} : \mathfrak{Y}(\circ, \mathcal{L}_G) \rightarrow T_{1_\circ}(\mathcal{L}_G)$ is an isomorphism. In fact, $\Phi|_{\mathcal{H}_\circ}$ is linear by definition. If $\Phi|_{\mathcal{H}_\circ}(X) = \Phi|_{\mathcal{H}_\circ}(Y)$, then for $\forall g \in \mathcal{H}_\circ$, we get that $X(g) = d\tilde{L}_g(X(\circ, \mathbf{1}_\circ)) = d\tilde{L}_g(Y(\circ, \mathbf{1}_\circ)) = Y(g)$. Hence, $X = Y$. We know $\Phi|_{\mathcal{H}_\circ}$ is injective.

Let $W \in T_{1_\circ}(\mathcal{H}_\circ)$. We can define a vector field X on \mathcal{L}_G by $X : g \rightarrow \tilde{L}_g(\circ, W) = X(g)$ for every $g \in \mathcal{H}_\circ$. Thus, $X(\mathbf{1}_\circ) = \tilde{L}_{1_\circ}W = W$. Such vector field is left invariant. In fact, for $g_1, g_2 \in \mathcal{H}_\circ$, we have

$$X(\tilde{L}_{g_1}(g_2)) = X(g_1 g_2) = d\tilde{L}_{g_1 g_2}(W) = d\tilde{L}_{g_1} \circ d\tilde{L}_{g_2}(W) = d\tilde{L}_{g_1} X(g_2).$$

Therefore, for $W \in T_{1_\circ}(\mathcal{H}_\circ)$, there exists a vector field $X \in \mathfrak{Y}(\circ, \mathcal{L}_G)$ such that $\Phi|_{\mathcal{H}_\circ}(X) = W$, i.e., $\Phi|_{\mathcal{H}_\circ}$ is surjective. Whence, $\Phi|_{\mathcal{H}_\circ} : \mathfrak{Y}(\circ, \mathcal{L}_G) \rightarrow T_{1_\circ}(\mathcal{L}_G)$ is an isomorphism.

Now extend $\Phi|_{\mathcal{H}_\circ}$ linearly to $\bigoplus_{\circ \in \mathcal{O}} \mathfrak{Y}(\circ, \mathcal{L}_G)$. We know that

$$\Phi : \bigoplus_{\circ \in \mathcal{O}} \mathfrak{Y}(\circ, \mathcal{L}_G) \rightarrow \bigoplus_{\circ \in \mathcal{O}} T_{1_\circ}(\mathcal{L}_G)$$

is an isomorphism. □

Corollary 6.4.5 *Let \mathcal{G} be a Lie group with an operation \circ . Then the mapping*

$$\Phi : \mathfrak{Y}(\circ, \mathcal{G}) \rightarrow T_{1_\mathcal{G}}(\mathcal{G})$$

determined by $\Phi(X) = X(\mathbf{1}_{\mathcal{G}})$ if $d\tilde{L}_g X(\circ, x) = X(\tilde{L}_g(\circ, x))$ for $\forall x \in \mathcal{G}$ is an isomorphism of $\mathfrak{V}(\circ, \mathcal{G})$ with $T_{\mathbf{1}_{\mathcal{G}}}(\mathcal{G})$ to \mathcal{G} at identity $\mathbf{1}_{\mathcal{G}}$.

For finding local form of a vector field $X \in \mathcal{X}(\mathcal{L}_G)$ of a Lie multi-group \mathcal{L}_G at a point $p \in \mathcal{L}_G$, we have known that

$$X = \left\langle [a_{ij}(p)]_{s(p) \times n_{s(p)}}, \left[\frac{\partial}{\partial x^l} \right]_{s(p) \times n_{s(p)}} \right\rangle = \sum_{i=1}^{s(p)} \sum_{j=1}^{n_{s(p)}} a_{ij} \frac{\partial}{\partial x^{ij}},$$

by Theorem 5.1.3, where $x^{il} = x^{jl}$ for $1 \leq i, j \leq s(p), 1 \leq l \leq \widehat{s}(p)$. Generally, we have the following result.

Theorem 6.4.8 *Let \mathcal{L}_G be a Lie multi-group. If a vector field $X \in \mathcal{X}(\mathcal{L}_G)$ is locally left-invariant for an operation $\circ \in \mathcal{O}(\mathcal{L}_G)$, then,*

$$X_p = \sum_{i=1}^{s(p)} \sum_{j=1}^{n_{s(p)}} a_{ij}(p) \frac{\partial}{\partial x^{ij}}$$

with

$$a_{ij}(\tilde{L}_g(\circ, p)) = \sum_j a_{ij}(p) \frac{\partial \tilde{L}_g(\circ, y)^{ij}}{\partial y^{ij}} \Big|_{y=p}$$

for $g, p \in \mathcal{L}_G$. Furthermore, X is globally left-invariant only if it is locally left-invariant for $\forall \circ \in \mathcal{O}(\mathcal{L}_G)$.

Proof According to Theorem 5.1.3, we know that

$$X(g \circ p)f(y) = \sum_j a_{ij}(g \circ p) \frac{\partial f(y)}{\partial y^{ij}} \Big|_{y=g \circ p}$$

and

$$\begin{aligned} (d\tilde{L}_g X)_p(\circ, f(y)) &= X_p(f\tilde{L}_g)(\circ, y) \\ &= \sum_j a_{ij} \frac{\partial (f\tilde{L}_g)(\circ, y)}{\partial y^{ij}} \Big|_{y=p} \\ &= \sum_j a_{ij} \frac{\partial (f(\tilde{L}_g)(\circ, y))}{\partial y^{ij}} \Big|_{y=p} \end{aligned}$$

by definition. Notice that

$$\begin{aligned} \frac{\partial(f(\tilde{L}_g)(\circ, y))}{\partial y^{ij}} \Big|_{y=p} &= \sum_s \frac{\partial f(g \circ y)}{\partial (g \circ y)^{is}} \frac{\partial (g \circ y)^{is}}{\partial y^{ij}} \Big|_{y=p} \\ &= \sum_s \frac{\partial f(y)}{\partial y^{is}} \Big|_{y=g \circ p} \frac{\partial (g \circ y)^{is}}{\partial y^{ij}} \Big|_{y=p}. \end{aligned}$$

By assumption, X is locally left-invariant for \circ . We know that $X(g \circ p)f(y) = (d\tilde{L}_g X)_p(\circ, f(y))$, namely,

$$\sum_j a_{ij}(g \circ p) \frac{\partial f(y)}{\partial y^{ij}} \Big|_{y=g \circ p} = \sum_i \left(\sum_s a_{is}(p) \frac{\partial (g \circ y)^{is}}{\partial y^{is}} \Big|_{y=p} \right) \frac{\partial f(y)}{\partial y^{is}} \Big|_{y=g \circ p}.$$

Whence, we finally get that

$$a_{ij}(\tilde{L}_g(\circ, p)) = \sum_j a_{ij}(p) \frac{\partial \tilde{L}_g(\circ, y)^{ij}}{\partial y^{ij}} \Big|_{y=p}$$

□

Example 6.4.7 Let $\tilde{R}(n_1, \dots, n_m)$ be a combinatorial Euclidean space consisting of $\mathbf{R}^{n_1}, \dots, \mathbf{R}^{n_m}$. It is a Lie multi-group by verifying each operation $+_i, 1 \leq i \leq m$ in Example 6.4.1 is C^∞ -differentiable. For this combinatorial space, its locally left-invariant \tilde{L}_g for $+_i$ is

$$\tilde{L}_g(+_i, p) = g +_i p.$$

Whence, a locally left-invariant vector field X must has a form

$$X = \sum_{i=1}^m \sum_{j=1}^{n_i} c_{ij}(p) \frac{\partial}{\partial x^{ij}}$$

In fact, by applying Theorem 6.4.8, we know that

$$c_{ij}(g +_i p) = \sum_s c_{is}(p) \frac{\partial (g +_i p)}{\partial x^{ij}} = \sum_s c_{is}(p)$$

for $\forall g, p \in \tilde{R}(n_1, \dots, n_m)$. Then, each $c_{ij}(p)$ is a constant. Otherwise, by Theorem 3.2.6, the implicit theorem we know that there must be a C^∞ -mapping h such that $g = h(p)$, a contradiction.

6.4.3 Homomorphism on Lie Multi-Group. Let \mathcal{L}_{G_1} and \mathcal{L}_{G_2} be Lie multi-groups. A topological homomorphism $\omega : \mathcal{L}_{G_1} \rightarrow \mathcal{L}_{G_2}$ is called a *homomorphism on Lie multi-group* if ω is C^∞ differentiable. Particularly, if $\mathcal{L}_{G_2} = \mathcal{E}(GL(n_1, \mathbf{R}), GL(n_2, \mathbf{R}), \dots, GL(n_m, \mathbf{R}))$, then a homomorphism $\omega : \mathcal{L}_{G_1} \rightarrow \mathcal{L}_{G_2}$ is called a *multi-representation of \mathcal{L}_{G_1}* .

Now let \mathfrak{Y}_i be one Lie algebra of \mathcal{L}_{G_i} for $i=1$ or 2 . A mapping $\varpi : \mathfrak{Y}_1 \rightarrow \mathfrak{Y}_2$ is a *Lie algebra homomorphism* if it is linear with

$$\varpi[X, Y] = [\varpi(X), \varpi(Y)] \quad \text{for } \forall X, Y \in \tilde{\mathcal{G}}_1.$$

Particularly, if $\mathfrak{Y}_2 = \mathfrak{Y}(GL(n, \mathbf{R}))$ in case, then a Lie algebra homomorphism ϖ is called a *representation of the Lie algebra \mathfrak{Y}_1* . Furthermore, if $\varpi : \mathfrak{Y}_1 \rightarrow \mathfrak{Y}_2$ is an isomorphism, then it is said that \mathfrak{Y}_1 and \mathfrak{Y}_2 are isomorphic, denoted by $\mathfrak{Y}_1 \stackrel{\varpi}{\cong} \mathfrak{Y}_2$.

Notice that if $\omega : \mathcal{L}_{G_1} \rightarrow \mathcal{L}_{G_2}$ is a homomorphism on Lie multi-group, then since ω maps an identity 1_o of \mathcal{L}_{G_1} to an identity $1_{\omega(o)}$ of \mathcal{L}_{G_2} for an operation $o \in \mathcal{O}(\mathcal{L}_{G_1})$. Whence, the differential $d\omega$ of ω at $1_o \in \mathcal{L}_{G_1}$ is a linear transformation of $T_{1_o}\mathcal{L}_{G_1}$ into $T_{1_{\omega(o)}}\mathcal{L}_{G_2}$. By Theorem 6.4.7, $d\omega$ naturally induces a linear transformation

$$d\omega : \mathfrak{Y}_1 \rightarrow \mathfrak{Y}_2$$

between Lie algebras on them. We know the following result.

Theorem 6.4.9 *The induced linear transformation $d\omega : \mathfrak{Y}_1 \rightarrow \mathfrak{Y}_2$ is a Lie algebra homomorphism.*

Proof For $\forall X, Y \in \mathcal{X}(\mathcal{L}_{G_1})$ and $f \in \mathcal{X}_p$, we know that

$$\begin{aligned} (d\omega[X, Y]f)\omega &= [X, Y](f\omega) = X(Y(f\omega)) - Y(X(f\omega)) \\ &= X(dY(f\omega)) - Y(d(X(f\omega))) \\ &= (d\omega X(d\omega Y f) - d\omega Y(d\omega X f))(\omega) \\ &= [d\omega X, d\omega Y](f). \end{aligned}$$

Whence, we know that $d\omega[X, Y] = [d\omega X, d\omega Y]$. □

Let \mathcal{L}_{G_i} be Lie multi-groups for $i = 1$ or 2 . We say \mathcal{L}_{G_1} is *locally C^∞ -isomorphic* to \mathcal{L}_{G_2} if for $\forall o \in \mathcal{O}(\mathcal{L}_{G_1})$, there are open neighborhoods U_o^1 and $U_{\omega(o)}^2$ of the respective identity 1_o and $1_{\omega(o)}$ with an isomorphism $\omega : U_o^1 \rightarrow U_{\omega(o)}^2$ of C^∞ -

diffeomorphism, i.e., if $a, b \in U_{\circ}^1$, then $a \circ b \in U_{\circ}^1$ if and only if $\omega(a)\omega(\circ)\omega(b) \in U_{\omega(\circ)}^2$) with $\omega(a \circ b) = \omega(a)\omega(\circ)\omega(b)$, denoted by $\mathcal{L}_{G_1}^L \stackrel{\omega}{\cong} \mathcal{L}_{G_2}^L$. Similarly, if a Lie algebra homomorphism $\varpi : \mathfrak{Y}_1 \rightarrow \mathfrak{Y}_2$ is an isomorphism, then it is said that \mathfrak{Y}_1 is isomorphic to \mathfrak{Y}_2 , denoted by $\mathfrak{Y}_1 \stackrel{\varpi}{\cong} \mathfrak{Y}_2$. For Lie groups, we know the following result gotten by Sophus Lie himself.

Theorem 6.4.10(Lie) *Let \mathfrak{Y}_i be a Lie algebra of a Lie group \mathcal{G}_i for $i = 1, 2$. Then $\mathcal{G}_1^L \stackrel{\omega}{\cong} \mathcal{G}_2^L$ if and only if $\mathfrak{Y}_1 \stackrel{d\omega}{\cong} \mathfrak{Y}_2$.*

This theorem is usually called the *fundamental theorem of Lie*, which enables us knowing that a Lie algebra of a Lie group is a complete invariant of the local structure of this group. For its a proof, the reader is referred to references, such as [Pon1] or [Var1] for examples. Then *what is its revised form of Lie’s fundamental theorem on Lie multi-groups?* We know its an extended form on Lie multi-groups following.

Theorem 6.4.11 *Let $\mathfrak{Y}(\circ, \mathcal{L}_{G_i})$ be a Lie algebra of a Lie multi-group \mathcal{L}_{G_i} for $\circ \in \mathcal{O}(\mathcal{L}_{G_i})$, $i = 1, 2$. Then $\mathcal{L}_{G_1}^L \stackrel{\omega}{\cong} \mathcal{L}_{G_2}^L$ if and only if $\mathfrak{Y}(\circ, \mathcal{L}_{G_1}) \stackrel{d\omega}{\cong} \mathfrak{Y}(\omega(\circ), \mathcal{L}_{G_2})$ for $\forall \circ \in \mathcal{O}(\mathcal{L}_{G_1})$.*

Proof By definition, if $\mathcal{L}_{G_1}^L \stackrel{\omega}{\cong} \mathcal{L}_{G_2}^L$, then for $\circ \in \mathcal{O}(\mathcal{L}_{G_1})$, the mapping

$$d\omega : \mathfrak{Y}(\circ, \mathcal{L}_{G_1}) \rightarrow \mathfrak{Y}(\omega(\circ), \mathcal{L}_{G_2})$$

is an isomorphism by Theorem 6.4.9. Whence, $\mathfrak{Y}(\circ, \mathcal{L}_{G_1}) \stackrel{d\omega}{\cong} \mathfrak{Y}(\omega(\circ), \mathcal{L}_{G_2})$ for $\forall \circ \in \mathcal{O}(\mathcal{L}_{G_1})$.

Conversely, if $\mathfrak{Y}(\circ, \mathcal{L}_{G_1}) \stackrel{d\omega}{\cong} \mathfrak{Y}(\omega(\circ), \mathcal{L}_{G_2})$ for $\forall \circ \in \mathcal{O}(\mathcal{L}_{G_1})$, by Theorem 6.4.10, there is an isomorphism $\omega : U_{\circ}^1 \rightarrow U_{\omega(\circ)}^2$ of C^∞ -diffeomorphism, where U_{\circ}^1 and $U_{\omega(\circ)}^2$ are the open neighborhoods of identities 1_{\circ} and $1_{\omega(\circ)}$, respectively. By definition, we know that $\mathcal{L}_{G_1}^L \stackrel{\omega}{\cong} \mathcal{L}_{G_2}^L$. □

6.4.4 Adjoint Representation. For any operation $\circ \in \mathcal{O}(\mathcal{L}_G)$, an *adjoint representation on* of a Lie multi-group \mathcal{L}_G is the representation $ad^{\circ}(a) = da_a^{\circ} : \mathcal{L}_G \rightarrow L(\mathfrak{Y}(\circ, \mathcal{L}_G), \mathfrak{Y}(\circ, \mathcal{L}_G))$ with an inner automorphism $i_a^{\circ} : \mathcal{L}_G \rightarrow \mathcal{L}_G$ of \mathcal{L}_G defined by $i_a^{\circ} : \mathcal{L}_G \rightarrow \mathcal{L}_G; x \rightarrow a \circ x \circ a^{-1}$ for $a \in \mathcal{L}_G$. If X_1, X_2, \dots, X_l is a basis of $\mathfrak{Y}(\circ, \mathcal{L}_G)$, then the matrix representation of $ad^{\circ}(a) = (a_{ij})_{s \times s}$ is given by

$$ad^\circ(a)X_i = di_a^\circ X_i = \sum_{j=1}^s a_{ji}(a) \circ X_j.$$

By Theorem 6.4.9, the differential of the mapping $ad^\circ(a) : \mathcal{L}_G \rightarrow \text{Aut}(\mathfrak{Y}(\circ, \mathcal{L}_G))$ is an adjoint representation of $\mathfrak{Y}(\circ, \mathcal{L}_G)$, denoted by $Ad^\circ : \mathfrak{Y}(\circ, \mathcal{L}_G) \rightarrow \mathfrak{Y}(GL(n, \mathbf{R}))$. Then we know that

$$Ad^\circ(X) \circ Y = X \circ Y - Y \circ X = [X, Y]|_0.$$

in the references, for example [AbM1] or [Wes1].

6.4.5 Lie Multi-Subgroup. A Lie multi-group \mathcal{L}_H is called a *Lie multi-subgroup* of \mathcal{L}_G if

- (i) \mathcal{L}_H is a smoothly combinatorial submanifold of \mathcal{L}_G , and
- (ii) \mathcal{L}_H is a multi-subgroup of \mathcal{L}_G in algebra.

Particularly, if \mathcal{L}_H is a Lie group, then we say it to be a *Lie subgroup*. The next well-known result is due to *E.Cartan*.

Theorem 6.4.12(Cartan) *A closed subgroup of a Lie group is a lie group.*

The proof of this theorem can be found in references, for example, [Pon1] or [Var1]. Based on this Cartan’s theorem, we know the following result for Lie multi-subgroups.

Theorem 6.4.13 *Let \mathcal{L}_G be a Lie multi-group with conditions in Theorem 5.1.1 hold, where $\widetilde{\mathcal{A}}(\mathcal{L}_G) = \bigcup_{i=1}^m \mathcal{H}_i$ and $\mathcal{O}(\mathcal{L}_G) = \bigcup_{i=1}^m \{\circ_i\}$. Then a multi-subgroup $(\mathcal{H}; \mathcal{O})$ of \mathcal{L}_G is a Lie multi-group if*

- (i) $(\mathcal{H}; \mathcal{O})|_{\circ_i}$ is a closed subgroup of $(\widetilde{\mathcal{A}}; \mathcal{O})|_{\circ_i}$ for any integer $i, 1 \leq i \leq m$.
- (ii) H is an induced subgraph of G .

Proof By the condition (ii), we know that $(\mathcal{H}; \mathcal{O})$ is still a smoothly combinatorial manifold by Theorem 5.1.1. According to Cartan’s theorem, each $(\mathcal{H}; \mathcal{O})|_{\circ_i}$ is a Lie group. Whence, $(\mathcal{H}; \mathcal{O})$ is a Lie multi-group by definition. □

6.4.6 Exponential Mapping. Notice that $(\mathbf{R}; +)$ is a Lie group by Example 6.4.1. Now let $\widetilde{\mathbf{R}}$ be a Lie multi-groups with

$$\mathcal{A}(\widetilde{\mathbf{R}}) = \bigcup_{i=1}^m \mathbf{R}_i \text{ and } \mathcal{O}(\widetilde{\mathbf{R}}) = \{+_i, 1 \leq i \leq m\},$$

where $\mathbf{R}_i = \mathbf{R}$ and $+_i = +$. A homomorphism $\varphi : \widetilde{\mathbf{R}} \rightarrow \mathcal{L}_G$ on Lie multi-groups, i.e., for an integer i , $1 \leq i \leq m$ and $\forall s, t \in \mathbf{R}$, $\varphi(s+_i t) = \varphi(s) \circ_i \varphi(t)$, is called a *one-parameter multi-group*. Particularly, a homomorphism $\varphi : \mathbf{R} \rightarrow \mathcal{L}_G$ is called a *one-parameter subgroup*, as usual. For example, if we chosen a $\circ \in \mathcal{O}(\mathcal{L}_G)$ firstly, then the one-parameter multi-subgroup of \mathcal{L}_G is nothing but a one parameter subgroup of $(\mathcal{H}_\circ; \circ)$. In this special case, for $\forall X, Y \in \mathcal{X}(\widetilde{M})$ we can define the Lie derivative $L_X Y$ of Y with respect to X introduced in Definition 5.7.2 by

$$L_X Y(x) = \lim_{t \rightarrow 0} \frac{1}{t} [\varphi_t^* Y(\varphi_t(x)) - Y(x)]$$

for $x \in \widetilde{M}$, where $\{\varphi_t\}$ is the 1-parameter group generated by X . It can be shown that this definition is equivalent to Definition 5.7.2, i.e., $L_X Y = XY - YX = [X, Y]$.

Notice that $(\mathbf{R}; +)$ is commutative. For any integer i , $1 \leq i \leq m$, we know that $\varphi(t) \circ_i \varphi(s) = \varphi(s+_i t) = \varphi(s) \circ_i \varphi(t)$, i.e., $\{\varphi(t), t \in \mathbf{R}\}$ is a commutative subgroup of $(\mathcal{H}_{\circ_i}; \circ_i)$. Furthermore, since $\varphi(0) \circ_i \varphi(t) = \varphi(0+_i t) = \varphi(t)$, multiplying by $\varphi(t)_{\circ_i}^{-1}$ on the right, we get that $\varphi(0) = 1_{\circ_i}$. Also, by $\varphi(t) \circ_i \varphi(-t) = \varphi(-t) \circ_i \varphi(t) = \varphi(t -_i t) = \varphi(0) = 1_{\circ_i}$, we have that $\varphi_{\circ_i}^{-1}(t) = \varphi(-t)$.

Notice that we can not conclude that $1_{\circ_1} = 1_{\circ_2} = \dots = 1_{\circ_m}$ by $\varphi(0_{+1}) = \varphi(0_{+2}) = \dots = \varphi(0_{+m})$ in the real field \mathbf{R} . In fact, we should have the inequalities $\varphi(0_{+1}) \neq \varphi(0_{+2}) \neq \dots \neq \varphi(0_{+m})$ in the multi-space $\widetilde{\mathbf{R}}$ by definition. Hence, it should be $1_{\circ_1} \neq 1_{\circ_2} \neq \dots \neq 1_{\circ_m}$.

The existence of one-parameter multi-subgroups and one-parameter subgroup of Lie multi-groups is obvious because of the existent one-parameter subgroups of Lie groups. In such case, each one-parameter subgroup $\varphi : \mathbf{R} \rightarrow \mathcal{G}$ is associated with a unique left-invariant vector field $X \in \mathfrak{X}(\mathcal{G})$ on a Lie group \mathcal{G} by

$$X(1_{\mathcal{G}}) : f \rightarrow X_{1_{\mathcal{G}}} f = \left. \frac{df(\varphi(t))}{dt} \right|_{t=0}.$$

Therefore, we characterize the combinatorial behavior on one-parameter multi-subgroups and one-parameter subgroups of Lie multi-groups.

Theorem 6.4.15 *Let \mathcal{L}_G be a Lie multi-groups with $\widetilde{\mathcal{A}}(\mathcal{L}_G) = \bigcup_{i=1}^m \mathcal{H}_i$ and $\mathcal{O}(\mathcal{L}_G) = \bigcup_{i=1}^m \{\circ_i\}$. Then,*

- (i) *if $\varphi : \widetilde{\mathbf{R}} \rightarrow \mathcal{L}_G$ is a one-parameter multi-subgroup, then $G[\varphi(\widetilde{\mathbf{R}})]$ is a*

subgraph of G , and $G[\varphi(\tilde{\mathbf{R}})] = G$ if and only if for any integers $i, j, 1 \leq i, j \leq m$, $\mathcal{H}_i \cap \mathcal{H}_j \neq \emptyset$ implies that there exist integers s, t such that $\varphi(s), \varphi(t) \in \varphi(\mathbf{R}; +_i) \cap \varphi(\mathbf{R}; +_j)$ with $\varphi(t) \circ_i \varphi(s) = \varphi(t) \circ_j \varphi(s)$ holds;

(ii) if $\varphi : \tilde{\mathbf{R}} \rightarrow \mathcal{L}_G$ is a one-parameter subgroup, i.e., $\tilde{\mathbf{R}} = \mathbf{R}$, then there is an integer $i_0, 1 \leq i_0 \leq m$ such that $\varphi(\mathbf{R}) \prec (\mathcal{H}_{i_0}; \circ_{i_0})$.

Proof By definition, each $\varphi(\mathbf{R}, +_i)$ is a commutative subgroup of $(\mathcal{H}_i; \circ_i)$ for any integer $1 \leq i \leq m$. Consequently, $\varphi(\tilde{\mathbf{R}})$ is a commutative multi-subgroup of \mathcal{L}_G . Whence, $G[\varphi(\tilde{\mathbf{R}})]$ is a subgraph of G by Theorem 2.1.1.

Now if $G[\varphi(\tilde{\mathbf{R}})] = G$, then for integers $i, j, \mathcal{H}_i \cap \mathcal{H}_j \neq \emptyset$ implies that $\varphi(\mathbf{R}; +_i) \cap \varphi(\mathbf{R}; +_j) \neq \emptyset$. Let $\varphi(s), \varphi(t) \in \varphi(\mathbf{R}; +_i) \cap \varphi(\mathbf{R}; +_j)$. Then there must be $\varphi(s) \circ_i \varphi(t) = \varphi(s +_i t) = \varphi(s + t) = \varphi(s +_j t) = \varphi(s) \circ_j \varphi(t)$. That is the conclusion (i).

The conclusion (ii) is obvious by definition. In fact, $\circ_{i_0} = \varphi(+)$. □

Let $\varphi : \tilde{\mathbf{R}} \rightarrow \mathcal{L}_G$ be a one-parameter multi-subgroup of \mathcal{L}_G . According to Theorem 6.4.15, we can introduce an *exponential mapping* exp following:

$$\text{exp} : \bigoplus_{\circ \in \mathcal{O}(\mathcal{L}_G)} \mathfrak{V}(\circ, \mathcal{L}_G) \times \mathcal{O}(\mathcal{L}_G) \rightarrow \mathcal{L}_G$$

determined by

$$\text{exp}(X, \circ) = \varphi_X(1_\circ).$$

We have the following result on the exponential mapping.

Theorem 6.4.16 *Let $\varphi : \tilde{\mathbf{R}} \rightarrow \mathcal{L}_G$ be a one-parameter multi-subgroup. Then for $\circ \in \mathcal{O}(\mathcal{L}_G)$ with $\varphi(+)=\circ$,*

- (i) $\varphi_X(t) = \text{exp}(tX, \circ)$;
- (ii) $(\text{exp}(t_1X, \circ)) \circ (\text{exp}(t_2X, \circ)) = \text{exp}((t_1 + t_2)X, \circ)$ and $\text{exp}(t_+^{-1}X, \circ) = \text{exp}^{-1}(tX, \circ)$.

Proof Notice that $s \rightarrow \varphi_X(st), s, t \in \mathbf{R}$ is a one-parameter subgroup of \mathcal{L}_G . Whence, there is a vector field $Y \in \mathfrak{V}(\circ, \mathcal{L}_G)$ such that

$$\varphi_Y(s) = \varphi_X(st) \quad \text{with} \quad Y = d\varphi_Y\left(\frac{d}{ds}\right).$$

Furthermore, we know that $d\varphi_{tX}(\frac{d}{ds}) = tX$. Therefore, $\varphi_{tX} = \varphi_X(st)$. Particularly, let $s = 1$, we finally get that

$$\exp(tX, \circ) = \varphi_{tX}(1_\circ) = \varphi_X(t),$$

which is the equality (i).

For (ii), by the definition of one-parameter subgroup, we know that

$$\begin{aligned} (\exp(t_1X, \circ)) \circ (\exp(t_2X, \circ)) &= \varphi_X(t_1) \circ \varphi_X(t_2) = \varphi_X(t_1 + t_2) \\ &= \exp((t_1 + t_2)X, \circ) \end{aligned}$$

and

$$\exp(t_+^{-1}X, \circ) = \varphi_X(t_+^{-1}) = (\varphi_X(t))_+^{-1} = \exp^{-1}(tX, \circ).$$

□

For an n -dimensional \mathbf{R} -vector space V , \mathcal{L}_G is just a Lie group $GL(n, \mathbf{R})$. In this case, we can show that

$$\exp(tX, \circ) = e^{tX} = \sum_{i=0}^{\infty} \frac{(tX)^i}{i!},$$

where $X^i = \overbrace{X \circ \cdots \circ X}^i$ for $X \in \mathfrak{X}(GL(n, \mathbf{R}))$. To see it make sense, namely the righthand side converges, we show it converges uniformly for X in a bounded region of $GL(n, \mathbf{R})$. In fact, for a given bounded region Λ , by definition there is a number $N > 0$ such that for any matrix $A = (x_{ij}(A))_{n \times n}$ in this region, there are must be $|x_{ij}(A)| \leq N$. Whence, $|x_{ij}(A^k)| \leq n^{k-1}N^k$. Thus, by the Weierstrass M -test, each of the series

$$\sum_{k=0}^{\infty} \frac{x_{ij}(A^k)}{k!}$$

is converges uniformly to $e^{x_{ij}}$. Whence,

$$e^A = (e^{x_{ij}(A)})_{n \times n} = \sum_{k=0}^{\infty} \frac{(A)^k}{k!}.$$

Example 6.4.8 Let the matrix X to be

$$X = \begin{bmatrix} 0 & -1 & 0 \\ 1 & 0 & 0 \\ 0 & 0 & 0 \end{bmatrix}.$$

A direct calculation shows that

$$\begin{aligned} e^{tX} &= I_{3 \times 3} + tX + \frac{t^2 X^2}{2!} + \frac{t^3 X^3}{3!} + \dots \\ &= I_{3 \times 3} + t \begin{bmatrix} 0 & -1 & 0 \\ 1 & 0 & 0 \\ 0 & 0 & 0 \end{bmatrix} + \frac{t^2}{2!} \begin{bmatrix} -1 & 0 & 0 \\ 0 & -1 & 0 \\ 0 & 0 & 0 \end{bmatrix} + \frac{t^3}{3!} \begin{bmatrix} 0 & 1 & 0 \\ -1 & 0 & 0 \\ 0 & 0 & 0 \end{bmatrix} + \dots \\ &= \begin{bmatrix} (1 - \frac{t^2}{2!} + \dots) & -(t - \frac{t^3}{3!} + \dots) & 0 \\ (t - \frac{t^3}{3!} + \dots) & (1 - \frac{t^2}{2!} - \dots) & 0 \\ 0 & 0 & 1 \end{bmatrix} \\ &= \begin{bmatrix} \cos t & -\sin t & 0 \\ \sin t & \cos t & 0 \\ 0 & 0 & 1 \end{bmatrix}. \end{aligned}$$

For a Lie multi-group homomorphism $\omega : \mathcal{L}_{G_1} \rightarrow \mathcal{L}_{G_2}$, there is a relation between $\omega, d\omega$ and \exp on a $\circ \in \mathcal{L}_{G_1}$ following.

Theorem 6.4.17 *Let $\omega : \mathcal{L}_{G_1} \rightarrow \mathcal{L}_{G_2}$ be a Lie multi-group homomorphism with $\omega(\circ) = \bullet \in \mathcal{O}(\mathcal{L}_{G_2})$ for $\circ \in \mathcal{O}(\mathcal{L}_{G_1})$. Then the following diagram*

$$\begin{array}{ccc} \mathcal{L}_{G_1} & \xrightarrow{\omega} & \mathcal{L}_{G_2} \\ \uparrow \text{exp} & & \uparrow \text{exp} \\ \mathfrak{Y}(\circ, \mathcal{L}_{G_1}) & \xrightarrow{d\omega} & \mathfrak{Y}(\bullet, \mathcal{L}_{G_2}) \end{array}$$

is commutative.

Proof Let $X \in \mathfrak{Y}(\circ, \mathcal{L}_{G_1})$. Then $t \rightarrow \omega(\exp(tX, \circ))$ is a differentiable curve in \mathcal{L}_{G_2} whose tangent vector at $0 \in \mathbf{R}$ is $d\omega X(1_\circ)$. Notice it is also a one-parameter subgroup of \mathcal{L}_{G_2} because of ω a Lie multi-group homomorphism. Notice that $t \rightarrow$

$\exp(td\omega(X), \circ)$ is the unique one-parameter subgroup of \mathcal{L}_{G_2} with a tangent vector $d\omega(X)(1_\circ)$. Consequently, $\omega(\exp(tX, \circ)) = \exp(td\omega(X), \circ)$ for $\forall t \in \mathbf{R}$. Whence, $\omega(\exp(X, \circ)) = \exp(d\omega(X), \circ)$. \square

6.4.7 Action of Lie Multi-Group. We have discussed the action of permutation multi-groups on finite multi-sets in Section 2.5. The same idea can be also applied to infinite multi-sets.

Let \widetilde{M} be a smoothly combinatorial manifold consisting of manifolds of M_1, M_2, \dots, M_m and \mathcal{L}_G a Lie multi-group with $(\widetilde{\mathcal{A}}(\mathcal{L}_G); \mathcal{O}(\mathcal{L}_G))$, where $\widetilde{\mathcal{A}}(\mathcal{L}_G) = \bigcup_{i=1}^m \mathcal{H}_i$ and $\mathcal{O}(\mathcal{L}_G) = \bigcup_{i=1}^m \{\circ_i\}$. The Lie multi-group \mathcal{L}_G is called an *action* on \widetilde{M} if there is a differentiable mapping $\phi : \mathcal{L}_G \times \widetilde{M} \times \mathcal{O}(\mathcal{L}_G) \rightarrow \widetilde{M}$ determined by $\phi(g, x, \circ_i) = g \circ_i x$ for $g \in \mathcal{H}_i, x \in M_i, 1 \leq i \leq m$ such that

- (i) for $\forall x, y \in M_i$ and $g \in \mathcal{H}_i, g \circ_i x, g \circ_i y \in g \circ_i M_i$ a manifold;
- (ii) $(g_1 \circ_i g_2) \circ_i x = g_1 \circ_i (g_2 \circ_i x)$ for $g_1, g_2 \in \mathcal{H}_i$;
- (iii) $1_{\circ_i} \circ_i x = x$.

In this case, the mapping $x \rightarrow g \circ x$ for $\circ \in \mathcal{O}(\mathcal{L}_G)$ is a differentiable mapping on \widetilde{M} . By definition, we know that $g_\circ^{-1} \circ (g \circ x) = g \circ (g_\circ^{-1} \circ x) = 1_\circ \circ x = x$. Whence, $x \rightarrow g \circ x$ is a diffeomorphism on \widetilde{M} . We say \mathcal{L}_G is a *faithful acting* on \widetilde{M} if $g \circ x = x$ for $\forall x \in \mathcal{H}_\circ$ implies that $g = 1_\circ$. It is an easy exercise for the reader that *there are no fixed elements in the intersection of manifolds in \widetilde{M} for a faithful action of \mathcal{L}_G on \widetilde{M}* . We say \mathcal{L}_G is a *freely acting* on \widetilde{M} if $g \circ x = x$ only hold for $g = 1_\circ$.

Define $(\mathcal{L}_G)_{x_0}^\circ = \{g \in \mathcal{L}_G | g \circ x_0 = x_0\}$. Then $(\mathcal{L}_G)_{x_0}^\circ$ forms a subgroup of (\mathcal{L}_G) . In fact, if $g \circ x_0 = x_0$, we find that $g_\circ^{-1} \circ (g \circ x_0) = g_\circ^{-1} \circ x_0$. Because of $g_\circ^{-1} \circ (g \circ x_0) = (g_\circ^{-1} \circ g) \circ x_0 = 1_\circ \circ x_0 = x_0$, one obtains that $g_\circ^{-1} \circ x_0 = x_0$. Whence, $g_\circ^{-1} \in (\mathcal{L}_G)_{x_0}^\circ$. Now if $g, h \in (\mathcal{L}_G)_{x_0}^\circ$, then $(g \circ h) \circ x_0 = g \circ (h \circ x_0) = x_0$, i.e., $g \circ h \in (\mathcal{L}_G)_{x_0}^\circ$. Whence, $(\mathcal{L}_G)_{x_0}^\circ$ is a subgroup of \mathcal{L}_G .

Theorem 6.4.18 For $\forall \circ \in \mathcal{O}(\mathcal{L}_G)$, $(\mathcal{L}_G)_{g \circ x}^\circ = g \circ (\mathcal{L}_G)_x^\circ \circ g_\circ^{-1}$.

Proof Let $h \in (\mathcal{L}_G)_x^\circ$. Then we know that $g \circ h \circ g_\circ^{-1} \circ g \circ x = g \circ h \circ x = g \circ (h \circ x) = g \circ x$, which implies that $g \circ (\mathcal{L}_G)_x^\circ \circ g_\circ^{-1} \subset (\mathcal{L}_G)_{g \circ x}^\circ$. Similarly, the same argument enables us to find $g_\circ^{-1} \circ (\mathcal{L}_G)_{g \circ x}^\circ \circ g \subset (\mathcal{L}_G)_x^\circ$, i.e., $(\mathcal{L}_G)_{g \circ x}^\circ \subset g \circ (\mathcal{L}_G)_x^\circ \circ g_\circ^{-1}$. Therefore, $(\mathcal{L}_G)_{g \circ x}^\circ = g \circ (\mathcal{L}_G)_x^\circ \circ g_\circ^{-1}$. \square

Corollary 6.4.6 *Let \mathcal{G} be a Lie group, $x \in \mathcal{G}$. Then $\mathcal{G}_{gx} = g\mathcal{G}_xg^{-1}$*

Analogous to the finite case, we say that \mathcal{L}_G acts transitively on \widetilde{M} if for $\forall x, y \in \widetilde{M}$, there exist elements $g \in \mathcal{L}_G$ and $\circ \in \mathcal{O}(\mathcal{L}_G)$ such that $y = g \circ x$. A smoothly combinatorial manifold \widetilde{M} is called a *homogeneous combinatorial manifold* if there is a Lie multi-group \mathcal{L}_G acting transitively on \widetilde{M} . If \widetilde{M} is just a manifold, a homogeneous combinatorial manifold is also called a *homogeneous manifold*. Then we have a structural result on homogeneous combinatorial manifolds following.

Theorem 6.4.19 *Let \widetilde{M} be a smoothly combinatorial manifold on which a Lie multi-group \mathcal{L}_G acts. Then \widetilde{M} is homogeneous if and only if each manifold in \widetilde{M} is homogeneous.*

Proof If \widetilde{M} is homogeneous, by definition we know that \mathcal{L}_G acts transitively on \widetilde{M} , i.e., for $\forall x, y \in \widetilde{M}$, there exist $g \in \mathcal{L}_G$ and an integer $i, 1 \leq i \leq m$ such that $y = g \circ_i x$. Particularly, let $x, y \in M_i$. Then we know that $g \in \mathcal{H}_i$. Whence, $\mathcal{L}_G|_{\mathcal{H}_i} = (\mathcal{H}_i, \circ_i)$ is transitive on M_i , i.e., M_i is a homogeneous manifold.

Conversely, if each manifold M in \widetilde{M} is homogeneous, i.e. a Lie group \mathcal{G}_M acts transitively M , let $x, y \in \widetilde{M}$. If x and y are in one manifold M_i , by assumption there exists $g \in \mathcal{G}_{M_i}$ with $g : x \rightarrow g \circ_i x$ differentiable such that $g \circ_i x = y$. Now if $x \in M_i$ but $y \in M_j$ with $i \neq j, 1 \leq i, j \leq m$, remember that $G^L[\widetilde{M}]$ is connected, there is a path

$$P(M_i, M_j) = M_{k_0}M_{k_1}M_{k_2} \cdots M_{k_l}M_{k_{l+1}}$$

connecting M_i and M_j in $G^L[\widetilde{M}]$, where $M_{k_0} = M_i, M_{k_{l+1}} = M_j$. Choose $x_i \in M_{k_i} \cap M_{k_{i+1}}, 0 \leq i \leq l$. By assumption, there are elements $g_i \in \mathcal{G}_{M_{k_i}}$ such that $g_i \circ_{k_i} x_i = x_{i+1}$. Now let $g \in \mathcal{G}_{M_i}$ and $h \in \mathcal{G}_{M_j}$ such that $g \circ_{k_0} x = x_0$ and $h \circ_{k_l} x_l = y$. Then we find that

$$(h \circ_j g_l \circ_{k_l} g_{l-1} \circ_{k_{l-1}} \cdots g_2 \circ_{k_2} g_1 \circ_{k_1} g_0) \circ_i x = y.$$

Choose $g = h \circ_j g_l \circ_{k_l} g_{l-1} \circ_{k_{l-1}} \cdots g_2 \circ_{k_2} g_1 \circ_{k_1} g_0 \in \mathcal{L}_G$. It is differentiable by definition. Therefore, \widetilde{M} is homogeneous. □

If \mathcal{L}_G acts transitively on a differentiable \widetilde{M} , then \widetilde{M} can be obtained if knowing \mathcal{L}_G and stabilizers $(\mathcal{L}_G)_x^\circ, \circ \in \mathcal{O}(\mathcal{L}_G)$ of \mathcal{L}_G at $x \in \widetilde{M}$ in advance. In fact, we have the following result.

Theorem 6.4.20 *Let \widetilde{M} be a differentiable combinatorial manifold consisting of manifolds $M_{o_i}, 1 \leq i \leq m$, \mathcal{G}_{o_i} a Lie group acting differentiably and transitively on M_{o_i} . Chosen $x_i \in M_{o_i}$, a projection $\pi_i : \mathcal{G}_{o_i} \rightarrow \mathcal{G}_{o_i}/(\mathcal{G}_{o_i})_x$, then the mapping $\varsigma_i : \mathcal{G}_{o_i} \rightarrow M_{o_i}$ determined by $\varsigma_i(g) = g \circ_i x$ for $g \in \mathcal{G}_{o_i}$ induces a diffeomorphism*

$$\bar{\varsigma} : \bigotimes_{i=1}^m \mathcal{G}_{o_i}/(\mathcal{G}_{o_i})_x \rightarrow \bigotimes_{i=1}^m M_{o_i}$$

with $\bar{\varsigma} = (\bar{\varsigma}_1, \bar{\varsigma}_2, \dots, \bar{\varsigma}_m)$ and $\bar{\varsigma}_i \pi_i = \varsigma_i$. Furthermore, $\bar{\varsigma}$ is a diffeomorphism

$$\bar{\varsigma} : \mathcal{L}_G/(\mathcal{L}_G)_\Delta \rightarrow \widetilde{M},$$

where $\Delta = \{x_i, 1 \leq i \leq m\}$ and $x_i \in M_i \setminus (\widetilde{M} \setminus M_i), 1 \leq i \leq m$.

Proof For a given integer $i, 1 \leq i \leq m$, let $g \in \mathcal{G}_{o_i}$. Then for $\forall g' \in (\mathcal{G}_{o_i})_x$, we have that $g \circ_i g' \in g \circ_i (\mathcal{G}_{o_i})_x$ and $\varsigma(g \circ_i g') = \varsigma(g)$. See the following diagram on the relation among these mappings ς_i, π_i and $\bar{\varsigma}_i$.

$$\begin{array}{ccc} \mathcal{G}_{o_i} & \xrightarrow{\varsigma_i} & M_{o_i} \\ \pi_i \downarrow & \nearrow \bar{\varsigma}_i & \\ \mathcal{G}_{o_i}/(\mathcal{G}_{o_i})_x & & \end{array}$$

Thus the mapping $\pi_i(g) = g \circ_i (\mathcal{G}_{o_i})_x \rightarrow \varsigma_i(g)$ determines a mapping $\bar{\varsigma}_i : \mathcal{G}_{o_i}/(\mathcal{G}_{o_i})_x \rightarrow M_{o_i}$ with $\bar{\varsigma}_i \pi_i(g) = \varsigma_i(g)$. Notice that $\pi_i : \mathcal{G}_{o_i} \rightarrow \mathcal{G}_{o_i}/(\mathcal{G}_{o_i})_x$ induces the identification topology on $\mathcal{G}_{o_i}/(\mathcal{G}_{o_i})_x$ by

$$U \subset \mathcal{G}_{o_i}/(\mathcal{G}_{o_i})_x \text{ is open if and only if } \pi_i^{-1}(U) \text{ is open in } \mathcal{G}_{o_i}.$$

Then we know that $\bar{\varsigma}_i$ and $\bar{\varsigma}_i^{-1}$ are differentiably bijections. Whence, $\bar{\varsigma}_i$ is a diffeomorphism

$$\bar{\varsigma}_i : \mathcal{G}_{o_i}/(\mathcal{G}_{o_i})_x \rightarrow M_{o_i}.$$

Extending such diffeomorphisms linearly on $\bigotimes_{i=1}^m \mathcal{G}_{o_i}/(\mathcal{G}_{o_i})_x$, we know that

$$\bar{\varsigma} : \bigotimes_{i=1}^m \mathcal{G}_{o_i}/(\mathcal{G}_{o_i})_x \rightarrow \bigotimes_{i=1}^m M_{o_i}$$

is a diffeomorphism. Let $x_i \in \Delta$. Notice that $\mathcal{L}_G = \bigcup_{i=1}^m \mathcal{G}_{o_i}, (\mathcal{L}_G)_x = \bigcup_{i=1}^m (\mathcal{G}_{o_i})_x$,

$$\widetilde{M} = \bigcup_{i=1}^m M_i \text{ and}$$

$$\mathcal{L}_G/(\mathcal{L}_G)_\Delta \cong \bigcup_{i=1}^m \mathcal{G}_{\alpha_i}/(\mathcal{G}_{\alpha_i})_x.$$

Therefore, we get a diffeomorphism

$$\overline{\zeta} : \mathcal{L}_G/(\mathcal{L}_G)_\Delta \rightarrow \widetilde{M}. \quad \square$$

Corollary 6.4.7 *Let M be a differentiable manifold on which a Lie group \mathcal{G} acts differentiably and transitively. Then for $x \in M$, a projection $\pi : \mathcal{G} \rightarrow \mathcal{G}/\mathcal{G}_x$, the mapping $\zeta : \mathcal{G} \rightarrow M$ determined by $\zeta(g) = gx$ for $g \in \mathcal{G}$ induces a diffeomorphism*

$$\overline{\zeta} : \mathcal{G}/\mathcal{G}_x \rightarrow M$$

with $\overline{\zeta}\pi = \zeta$.

We present some examples for the action of linear mappings on the complex plane \mathbf{C} , which is isomorphic to \mathbf{R}^2 .

Example 6.4.9 Let \mathbf{C} be a complex plane and the group \mathcal{Q} of \mathbf{C} consisting of $f : \mathbf{C} \rightarrow \mathbf{C}$ by $f(z) = az + b$, $a, b \in \mathbf{C}$ and $a \neq 0$ for $z \in \mathbf{C}$. Calculation shows that

$$\mathcal{Q}_O = \{ az \mid a \neq 0 \},$$

where $O = (0, 0)$.

Example 6.4.10 Consider that action of the linear group $SL(2, \mathbf{R})$ on the upper half plane

$$\mathbf{C}^+ = \{ x + iy \in \mathbf{C} \mid y \geq 0 \}.$$

Notice that an element $f \in SL(n, \mathbf{R})$ has a form

$$f = \begin{bmatrix} a & b \\ c & d \end{bmatrix}, \quad a, b, c, d \in \mathbf{R}, \quad ad - bc = 1$$

with a transitive action

$$f(z) = \frac{az + b}{cz + d}$$

on a point $z \in \mathbf{C}^+$. Let $z = i \in \mathbf{C}^+$. We determine the stabilizer $SL(2, \mathbf{R})_i$. In fact,

$$\frac{az + b}{cz + d} = i \text{ implies that } ai + b = -c + di.$$

Whence, $a = d$ and $b = -c$. Consequently, we know that $ad - bc = a^2 + b^2 = 1$, which means that

$$\begin{bmatrix} a & b \\ c & d \end{bmatrix} = \begin{bmatrix} \cos \theta & -\sin \theta \\ \sin \theta & \cos \theta \end{bmatrix},$$

i.e., a rigid rotation on \mathbf{R}^2 . Therefore, $SL(2, \mathbf{R})_i = SO(2, \mathbf{R})$, the rigid rotation group consisting of all 2×2 real orthogonal matrices of determinant 1.

§6.5 PRINCIPAL FIBRE BUNDLES

6.5.1 Principal Fiber Bundle. Let \tilde{P} , \tilde{M} be a differentially combinatorial manifolds and \mathcal{L}_G a Lie multi-group $(\tilde{\mathcal{A}}(\mathcal{L}_G); \tilde{\mathcal{O}}(\mathcal{L}_G))$ with

$$\tilde{P} = \bigcup_{i=1}^m P_i, \quad \tilde{M} = \bigcup_{i=1}^s M_i, \quad \tilde{\mathcal{A}}(\mathcal{L}_G) = \bigcup_{i=1}^m \mathcal{H}_{\circ_i}, \quad \tilde{\mathcal{O}}(\mathcal{L}_G) = \bigcup_{i=1}^m \{\circ_i\}.$$

A differentiable principal fiber bundle over \tilde{M} with group \mathcal{L}_G consists of a differentially combinatorial manifold \tilde{P} , an action of \mathcal{L}_G on \tilde{P} satisfying following conditions PFB1-PFB3:

PFB1. For any integer i , $1 \leq i \leq m$, \mathcal{H}_{\circ_i} acts differentiably on P_i to the right without fixed point, i.e.,

$$(x, g) \in P_i \times \mathcal{H}_{\circ_i} \rightarrow x \circ_i g \in P_i \text{ and } x \circ_i g = x \text{ implies that } g = 1_{\circ_i};$$

PFB2. For any integer i , $1 \leq i \leq m$, M_{\circ_i} is the quotient space of a covering manifold $P \in \Pi^{-1}(M_{\circ_i})$ by the equivalence relation R induced by \mathcal{H}_{\circ_i} :

$$R_i = \{(x, y) \in P_{\circ_i} \times P_{\circ_i} \mid \exists g \in \mathcal{H}_{\circ_i} \Rightarrow x \circ_i g = y\},$$

written by $M_{\circ_i} = P_{\circ_i} / \mathcal{H}_{\circ_i}$, i.e., an orbit space of P_{\circ_i} under the action of \mathcal{H}_{\circ_i} . There is a canonical projection $\Pi : \tilde{P} \rightarrow \tilde{M}$ such that $\Pi_i = \Pi|_{P_{\circ_i}} : P_{\circ_i} \rightarrow M_{\circ_i}$ is differentiable and each fiber $\Pi_i^{-1}(x) = \{p \circ_i g \mid g \in \mathcal{H}_{\circ_i}, \Pi_i(p) = x\}$ is a closed submanifold of P_{\circ_i} and coincides with an equivalence class of R_i ;

PFB3. For any integer i , $1 \leq i \leq m$, $P \in \Pi^{-1}(M_{\circ_i})$ is locally trivial over M_{\circ_i} , i.e., any $x \in M_{\circ_i}$ has a neighborhood U_x and a diffeomorphism $T : \Pi^{-1}(U_x) \rightarrow U_x \times \mathcal{L}_G$ with

$$T|_{\Pi_i^{-1}(U_x)} = T_i^x : \Pi_i^{-1}(U_x) \rightarrow U_x \times \mathcal{H}_{\circ_i}; \quad x \rightarrow T_i^x(x) = (\Pi_i(x), \epsilon(x)),$$

called a local trivialization (abbreviated to LT) such that $\epsilon(x \circ_i g) = \epsilon(x) \circ_i g$ for $\forall g \in \mathcal{H}_{\circ_i}$, $\epsilon(x) \in \mathcal{H}_{\circ_i}$.

We denote such a principal fibre bundle by $\tilde{P}(\tilde{M}, \mathcal{L}_G)$. If $m = 1$, then $\tilde{P}(\tilde{M}, \mathcal{L}_G) = P(M, \mathcal{H})$, the common principal fiber bundle on a manifold M . Whence, the existence of $\tilde{P}(\tilde{M}, \mathcal{L}_G)$ is obvious at least for $m = 1$.

For an integer i , $1 \leq i \leq m$, let $T_i^u : \Pi_i^{-1}(U_u) \rightarrow U_u \times \mathcal{H}_{\circ_i}$, $T_i^v : \Pi_i^{-1}(U_v) \rightarrow U_v \times \mathcal{H}_{\circ_i}$ be two LTs of a principal fiber bundle $\tilde{P}(\tilde{M}, \mathcal{L}_G)$. The transition function from T_i^u to T_i^v is a mapping ${}^i g_{uv} : U_u \cap U_v \rightarrow \mathcal{H}_{\circ_i}$ defined by ${}^i g_{uv}(x) = \epsilon_u(p) \circ_i \epsilon_v^{-1}(p)$ for $\forall x = \Pi_i(p) \in U_u \cap U_v$.

Notice that ${}^i g_{uv}(x)$ is independent of the choice $p \in \Pi_i^{-1}(x)$ because of

$$\begin{aligned} \epsilon_u(p \circ_i g) \circ_i \epsilon_v^{-1}(p \circ_i g) &= \epsilon_u(p) \circ_i g \circ_i (\epsilon_v(p) \circ_i g)^{-1} \\ &= \epsilon_u(p) \circ_i g \circ_i g_{\circ_i}^{-1} \circ_i \epsilon_v^{-1}(p) = \epsilon_u(p) \circ_i \epsilon_v^{-1}(p). \end{aligned}$$

Whence, these equalities following are obvious.

- (i) ${}^i g_{uu}(z) = 1_{\circ_i}$ for $\forall z \in U_u$;
- (ii) ${}^i g_{vu}(z) = {}^i g_{uv}^{-1}(z)$ for $\forall z \in U_u \cap U_v$;
- (iii) ${}^i g_{uv}(z) \circ_i {}^i g_{vw}(z) \circ_i {}^i g_{wu}(z) = 1_{\circ_i}$ for $\forall z \in U_u \cap U_v \cap U_w$.

A mapping $\Lambda : U \rightarrow \tilde{P}$ for any opened set $U \in \tilde{M}$ is called a local section of a principal fiber bundle $\tilde{P}(\tilde{M}, \mathcal{L}_G)$ if

$$\Pi\Lambda(x) = \Pi(\Lambda(x)) = x \text{ for } \forall x \in U,$$

i.e., the composition mapping $\Pi\Lambda$ fixes every point in U . Particularly, if $U = \tilde{M}$, a local section $\Lambda : U \rightarrow \tilde{P}$ is called a global section. Similarly, if $U = \tilde{M}$ for a local trivialization $T : \Pi^{-1}(U) \rightarrow U \times \mathcal{L}_G$, then T is called a global trivialization. A relation between local sections and local trivializations is shown in the following.

Theorem 6.5.1 *There is a natural correspondence between local sections and local trivializations.*

Proof If $\Lambda : U \rightarrow \tilde{P}$ is a local section, then we define $T : \Pi^{-1}(U) \rightarrow U \times \mathcal{L}_G$ for integers $1 \leq i \leq m$ by $T_i^x(\Lambda(x) \circ_i g) = (x, g)$ for $x \in U_x \subset M_i$.

Conversely, if $T : \Pi^{-1}(U) \rightarrow U \times \mathcal{L}_G$ is a local trivialization, define a local section $\Lambda : U \rightarrow \tilde{P}$ by $\Lambda(x) = (T_i^u)^{-1}(x, 1_{\circ_i})$ for $x \in U_x \subset M_i$. □

6.5.2 Combinatorial Principal Fiber Bundle. A general way for constructing principal fiber bundles $\tilde{P}(\tilde{M}, \mathcal{L}_G)$ over a differently combinatorial manifold \tilde{M} is by a combinatorial technique, i.e., the voltage assignment $\alpha : G^L[\tilde{M}] \rightarrow \mathfrak{G}$ over a finite group \mathfrak{G} . In Section 4.5.4, we have introduced combinatorial fiber bundles $(\tilde{M}^*, \tilde{M}, p, \mathfrak{G})$ consisting of a covering combinatorial manifold \tilde{M}^* , a finite group \mathfrak{G} , a combinatorial manifold \tilde{M} and a projection $p : \tilde{M}^* \rightarrow \tilde{M}$ by the voltage assignment $\alpha : G^L[\tilde{M}] \rightarrow \mathfrak{G}$. Consider the actions of Lie multi-groups on combinatorial manifolds, we find a natural construction way for principal fiber bundles on a smoothly combinatorial manifold \tilde{M} following.

Construction 6.5.1 *For a family of principal fiber bundles over manifolds M_1, M_2, \dots, M_l , such as those shown in Fig.6.5.1,*

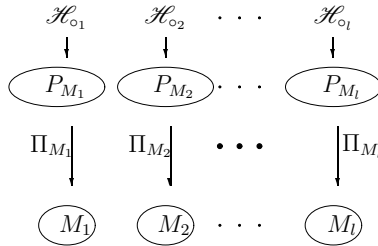

Fig.6.5.1

where \mathcal{H}_{\circ_i} is a Lie group acting on P_{M_i} for $1 \leq i \leq l$ satisfying conditions PFB1-PFB3, let \tilde{M} be a differentiably combinatorial manifold consisting of M_i , $1 \leq i \leq l$ and $(G^L[\tilde{M}], \alpha)$ a voltage graph with a voltage assignment $\alpha : G^L[\tilde{M}] \rightarrow \mathfrak{G}$ over a finite group \mathfrak{G} , which naturally induced a projection $\pi : G^L[\tilde{P}] \rightarrow G^L[\tilde{M}]$. For $\forall M \in V(G^L[\tilde{M}])$, if $\pi(P_M) = M$, place P_M on each lifting vertex $M^{L\alpha}$ in the fiber $\pi^{-1}(M)$ of $G^{L\alpha}[\tilde{M}]$, such as those shown in Fig.6.5.2.

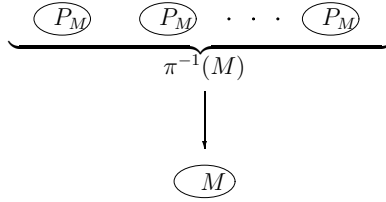

Fig.6.5.2

Let $\Pi = \pi\Pi_M\pi^{-1}$ for $\forall M \in V(G^L[\widetilde{M}])$. Then $\widetilde{P} = \bigcup_{M \in V(G^L[\widetilde{M}])} P_M$ is a smoothly combinatorial manifold and $\mathcal{L}_G = \bigcup_{M \in V(G^L[\widetilde{M}])} \mathcal{H}_M$ a Lie multi-group by definition. Such a constructed combinatorial fiber bundle is denoted by $\widetilde{P}^{L\alpha}(\widetilde{M}, \mathcal{L}_G)$.

For example, let $\mathfrak{G} = Z_2$ and $G^L[\widetilde{M}] = C_3$. A voltage assignment $\alpha : G^L[\widetilde{M}] \rightarrow Z_2$ and its induced combinatorial fiber bundle are shown in Fig.6.5.3.

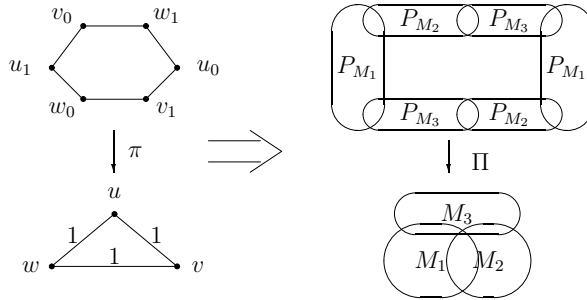

Fig.6.5.3

We search for and research on principal fiber bundles in such constructed combinatorial fiber bundles $\widetilde{P}^{L\alpha}(\widetilde{M}, \mathcal{L}_G)$ in this book only. For this objective, a simple criterion for principal fiber bundle is found following.

Theorem 6.5.2 *A combinatorial fiber bundle $\widetilde{P}^\alpha(\widetilde{M}, \mathcal{L}_G)$ is a principal fiber bundle if and only if for $\forall(M', M'') \in E(G^L[\widetilde{M}])$ and $(P_{M'}, P_{M''}) = (M', M'')^{L\alpha} \in E(G^L[\widetilde{P}])$, $\Pi_{M'}|_{P_{M'} \cap P_{M''}} = \Pi_{M''}|_{P_{M'} \cap P_{M''}}$.*

Proof By Construction 6.5.1, if $\Pi_{M'} : P_{M'} \rightarrow M'$ and $\Pi_{M''} : P_{M''} \rightarrow M''$, then $\Pi_{M'}(P_{M'} \cap P_{M''}) = M' \cap M''$ and $\Pi_{M''}(P_{M'} \cap P_{M''}) = M' \cap M''$. But $\Pi_{M'} = \Pi|_{P_{M'}}$ and

$\Pi_{M''} = \Pi|_{P_{M''}}$. We must have that $\Pi_{M'}|_{P_{M'} \cap P_{M''}} = \Pi|_{P_{M'} \cap P_{M''}} = \Pi_{M''}|_{P_{M'} \cap P_{M''}}$.

Conversely, if for $\forall (M', M'') \in E(G^L[\widetilde{M}])$ and $(P_{M'}, P_{M''}) = (M', M'')^{L\alpha} \in E(G^L[\widetilde{P}])$, $\Pi_{M'}|_{P_{M'} \cap P_{M''}} = \Pi_{M''}|_{P_{M'} \cap P_{M''}}$ in $\widetilde{P}^\alpha(\widetilde{M}, \mathcal{L}_G)$, then $\Pi = \pi \Pi_M \pi^{-1} : \widetilde{P} \rightarrow \widetilde{M}$ is a well-defined mapping. Other conditions of a principal fiber bundle can be verified immediately by Construction 6.5.1. \square

6.5.3 Automorphism of Principal Fiber Bundle. In the following part of this book, we always assume $\widetilde{P}^\alpha(\widetilde{M}, \mathcal{L}_G)$ satisfying conditions in Theorem 6.5.1, i.e., it is a principal fiber bundle over \widetilde{M} . An *automorphism* of $\widetilde{P}^\alpha(\widetilde{M}, \mathcal{L}_G)$ is a diffeomorphism $\omega : \widetilde{P} \rightarrow \widetilde{P}$ such that $\omega(p \circ_i g) = \omega(p) \circ_i g$ for $g \in \mathcal{H}_{\circ_i}$ and

$$p \in \bigcup_{P \in \pi^{-1}(M_i)} P, \quad \text{where } 1 \leq i \leq l.$$

Particularly, if $l = 1$, an automorphism of $\widetilde{P}^\alpha(\widetilde{M}, \mathcal{L}_G)$ with an voltage assignment $\alpha : G^L[\widetilde{M}] \rightarrow Z_0$ degenerates to an automorphism of a principal fiber bundle over a manifold. Certainly, all automorphisms of $\widetilde{P}^\alpha(\widetilde{M}, \mathcal{L}_G)$ forms a group, denoted by $\text{Aut}\widetilde{P}^\alpha(\widetilde{M}, \mathcal{L}_G)$.

An automorphism of a general principal fiber bundle $\widetilde{P}(\widetilde{M}, \mathcal{L}_G)$ can be introduced similarly. For example, if $\omega_i : P_{M_i} \rightarrow P_{M_i}$ is an automorphisms over the manifold M_i for $1 \leq i \leq l$ with $\omega_i|_{P_{M_i} \cap P_{M_j}} = \omega_j|_{P_{M_i} \cap P_{M_j}}$ for $1 \leq i, j \leq l$, then by the Gluing Lemma, there is a differentiable mapping $\omega : \widetilde{P} \rightarrow \widetilde{P}$ such that $\omega|_{P_{M_i}} = \omega_i$ for $1 \leq i \leq l$. Such ω is an automorphism of $\widetilde{P}(\widetilde{M}, \mathcal{L}_G)$ by definition. But we concentrate our attention on the automorphism of $\widetilde{P}^\alpha(\widetilde{M}, \mathcal{L}_G)$ because it can be combinatorially characterized.

Theorem 6.5.3 *Let $\widetilde{P}^\alpha(\widetilde{M}, \mathcal{L}_G)$ be a principal fiber bundle. Then*

$$\text{Aut}\widetilde{P}^\alpha(\widetilde{M}, \mathcal{L}_G) \geq \langle \mathfrak{L} \rangle,$$

where $\mathfrak{L} = \{ \widehat{h}\omega_i \mid \widehat{h} : P_{M_i} \rightarrow P_{M_i} \text{ is } 1_{P_{M_i}} \text{ determined by } h((M_i)_g) = (M_i)_{g \circ_i h} \text{ for } h \in \mathfrak{G} \text{ and } g_i \in \text{Aut}P_{M_i}(M_i, \mathcal{H}_{\circ_i}), 1 \leq i \leq l \}$.

Proof It is only needed to prove that each element ω in \mathfrak{G} is an automorphism of $\widetilde{P}^\alpha(\widetilde{M}, \mathcal{L}_G)$. We verify $\omega = \widehat{h}\omega_i$ is an automorphism of $\widetilde{P}^\alpha(\widetilde{M}, \mathcal{L}_G)$ for $\omega_i \in \text{Aut}P_{M_i}(M_i, \mathcal{H}_{\circ_i})$ and $h \in \mathfrak{G}$ with $h((M_i)_g) = (M_i)_{g \circ_i h}$. In fact, we get that

$$\omega(p \circ_i g) = \widehat{h}\omega_i(p \circ_i g) = \widehat{h}(\omega_i(p) \circ_i g) = \widehat{h}\omega_i(p) \circ_i g$$

for $p \in \bigcup_{P \in \pi^{-1}(M_i)} P$ and $g \in \mathcal{H}_{\circ_i}$. Whence, ω is an automorphism of $\widetilde{P}^\alpha(\widetilde{M}, \mathcal{L}_G)$. \square

A principal fiber bundle $\widetilde{P}(\widetilde{M}, \mathcal{L}_G)$ is called to be *normal* if for $\forall u, v \in \widetilde{P}$, there exists an $\omega \in \text{Aut}\widetilde{P}(\widetilde{M}, \mathcal{L}_G)$ such that $\omega(u) = v$. We get the necessary and sufficient conditions of normally principal fiber bundles $\widetilde{P}^\alpha(\widetilde{M}, \mathcal{L}_G)$ following.

Theorem 6.5.4 $\widetilde{P}^\alpha(\widetilde{M}, \mathcal{L}_G)$ is normal if and only if $P_{M_i}(M_i, \mathcal{H}_{\circ_i})$ is normal, $(\mathcal{H}_{\circ_i}; \circ_i) = (\mathcal{H}; \circ)$ for $1 \leq i \leq l$ and $G^{L_\alpha}[\widetilde{M}]$ is transitive by diffeomorphic automorphisms in $\text{Aut}G^{L_\alpha}[\widetilde{M}]$.

Proof If $\widetilde{P}^\alpha(\widetilde{M}, \mathcal{L}_G)$ is normal, then for $\forall u, v \in \widetilde{P}$, there exists an $\omega \in \text{Aut}\widetilde{P}^\alpha(\widetilde{M}, \mathcal{L}_G)$ such that $\omega(u) = v$. Particularly, let $u, v \in M_i$ for an integer $i, 1 \leq i \leq l$ or $G^{L_\alpha}[\widetilde{M}]$. Consider the actions of $\text{Aut}\widetilde{P}^\alpha(\widetilde{M}, \mathcal{L}_G)|_{P_{M_i}(M_i, \mathcal{H}_{\circ_i})}$ and $\text{Aut}\widetilde{P}^\alpha(\widetilde{M}, \mathcal{L}_G)|_{G^{L_\alpha}[\widetilde{M}]}$, we know that $P_{M_i}(M_i, \mathcal{H}_{\circ_i})$ for $1 \leq i \leq l$ and $G^{L_\alpha}[\widetilde{M}]$ are normal, and particularly, $G^{L_\alpha}[\widetilde{M}]$ is a transitive graph by diffeomorphic automorphisms in $\text{Aut}G^{L_\alpha}[\widetilde{M}]$.

Now choose $u \in M_i$ and $v \in M_j \setminus M_i, 1 \leq i, j \leq l$. By definition, there is an automorphism $\omega \in \text{Aut}\widetilde{P}^\alpha(\widetilde{M}, \mathcal{L}_G)$ such that $\omega(u) = v$. Whence, $\omega(u \circ_i g) = \omega(u) \circ_i g = v \circ_i g$ by definition. But this equality is well-defined only if $(\mathcal{H}_{\circ_i}; \circ_i) = (\mathcal{H}_{\circ_j}; \circ_j)$. Applying the normality of $\widetilde{P}^\alpha(\widetilde{M}, \mathcal{L}_G)$, we find that $(\mathcal{H}_{\circ_i}; \circ_i) = (\mathcal{H}; \circ)$ for any integer $1 \leq i \leq l$.

Conversely, if $P_{M_i}(M_i, \mathcal{H}_{\circ_i})$ is normal, $(\mathcal{H}_{\circ_i}; \circ_i) = (\mathcal{H}; \circ)$ for $1 \leq i \leq l$ and $G^{L_\alpha}[\widetilde{M}]$ is transitive by diffeomorphic automorphisms in $\text{Aut}G^{L_\alpha}[\widetilde{M}]$, let $u, u_0 \in M_i, v, v_0 \in M_j$ and $g(u_0) = v_0$ for a diffeomorphic automorphism $g \in \text{Aut}G^{L_\alpha}[\widetilde{M}]$. Then we know that there exist $\omega_i \in \text{Aut}P_{M_i}(M_i, \mathcal{H}_{\circ_i})$ and $\omega_j \in \text{Aut}P_{M_j}(M_j, \mathcal{H}_{\circ_j})$ such that $\omega_i(u) = u_0, \omega_j(v_0) = v$. Therefore, we know that

$$\omega_j g \omega_i(u) = \omega_j(g(u_0)) = \omega_j(v_0) = v.$$

Notice that ω_i, ω_j and g are diffeomorphisms. We know that $\omega_j g \omega_i$ is also a diffeomorphism. \square

Application of Theorem 4.5.6 enables us to get the following consequence.

Corollary 6.5.1 *Let $G^L[\widetilde{M}]$ be a transitive labeled graph by diffeomorphic automorphisms in $\text{Aut}G^L[\widetilde{M}]$, $\alpha : G^L[M] \rightarrow \mathfrak{G}$ a locally f -invariant voltage assignment and $P(M, \mathcal{H})$ a normal principal fiber bundle. Then the constructed $\widetilde{P}^\alpha(\widetilde{M}, \mathcal{L}_G)$ replacing each $P_{M_i}(M_i, \mathcal{H}_{\circ_i})$, $1 \leq i \leq l$ by $P(M, \mathcal{H})$ in Construction 6.5.1 is normal.*

Proof By Theorem 4.5.6, a diffeomorphic automorphism of $G^L[\widetilde{M}]$ is lifted to $G^{L\alpha}[\widetilde{M}]$. According to Theorems 6.5.3 and 6.5.4, we know that $\widetilde{P}^\alpha(\widetilde{M}, \mathcal{L}_G)$ is a normally principal fiber bundle. \square

6.5.4 Gauge Transformation. An automorphism ω of $\widetilde{P}^\alpha(\widetilde{M}, \mathcal{L}_G)$ naturally induces a diffeomorphism $\overline{\omega} : \widetilde{M} \rightarrow \widetilde{M}$ determined by $\overline{\omega}(\Pi(p)) = \Pi(\omega(p))$. Application of $\overline{\omega}$ motivates us to raise the conception of gauge transformation important in theoretical physics. A *gauge transformation* of a principal fiber bundle $\widetilde{P}^\alpha(\widetilde{M}, \mathcal{L}_G)$ is such an automorphism $\omega : \widetilde{P} \rightarrow \widetilde{P}$ with $\overline{\omega} = \text{identity}$ transformation on \widetilde{M} , i.e., $\Pi(p) = \Pi(\omega(p))$ for $p \in \widetilde{P}$. Similarly, all gauge transformations also forms a group, denoted by $GA(\widetilde{P})$.

There are many gauge transformations on principal fiber bundles. For example, the identity transformations $1_{P_{M_i}}$ induced by the right action of \mathfrak{G} on vertices in $G^{L\alpha}[\widetilde{M}]$, i.e., $h((M_i)_g) = (M_i)_{g\circ_i h}$ for $\forall h \in \mathfrak{G}$, $1 \leq i \leq l$ are all such transformations.

Let $\widetilde{P}^\alpha(\widetilde{M}, \mathcal{L}_G)$ be a principal fiber bundle and $(\mathcal{H}_{\circ_i}; \circ_i)$ act on a manifold F_i to the left, i.e., for each $g \in \mathcal{H}_{\circ_i}$, there is a C^∞ -mapping ${}^iL_g : \mathcal{H}_{\circ_i} \times F_i \rightarrow F_i$ such that ${}^iL_{1_{\circ_i}}(u, \circ_i) = u$ and ${}^iL_{g_1 \circ_i g_2}(u, \circ_i) = {}^iL_{g_1} \circ_i {}^iL_{g_2}(u, \circ_i)$ for $\forall u \in F_i$. Particularly, let F_i be a vector space \mathbf{R}^{n_i} and iL_g a linear mapping on \mathbf{R}^{n_i} . In this case, a homomorphism $\mathcal{H}_{\circ_i} \rightarrow GL(n_i, \mathbf{R})$ determined by $g \rightarrow L_g$ for $g \in \mathcal{H}_{\circ_i}$ is a representation of \mathcal{H}_{\circ_i} . Two such representations $g \rightarrow L_g$ and $g \rightarrow L'_g$ are called to be *equivalent* if there is a linear mapping $T : GL(n_i, \mathbf{R}) \rightarrow GL(n_i, \mathbf{R})$ such that $L'_g = T \circ_i L_g \circ_i T_{\circ_i}^{-1}$ for $\forall g \in \mathcal{H}_{\circ_i}$, $1 \leq i \leq l$.

For an integer i , $1 \leq i \leq l$, define a mapping space

$$C_i(P_{M_i}, F_i) = \{ \varpi : P_{M_i} \rightarrow F_i \mid \varpi(u \circ_i g) = g_{\circ_i}^{-1} \circ_i \varpi(u), \forall u \in P_{M_i}, g \in \mathcal{H}_{\circ_i} \}.$$

Particularly, if $l = 1$ with a trivial voltage group, i.e., $\widetilde{P}^\alpha(\widetilde{M}, \mathcal{L}_G)$ is a principal fiber bundle over a manifold M , $C_i(P_{M_i}, F_i)$ is abbreviated to $C(P_M, F)$. We have a result on gauge transformations of $\widetilde{P}^\alpha(\widetilde{M}, \mathcal{L}_G)$ following.

Theorem 6.5.5 *Let $\tilde{P}^\alpha(\tilde{M}, \mathcal{L}_G)$ be a principal fiber bundle with a voltage assignment $\alpha : G^L[\tilde{M}] \rightarrow \mathfrak{G}$ and $C_i(P_{M_i}, \mathcal{H}_{\circ_i})$ with an action $g(g') = g \circ_i g' \circ_i g_o_i^{-1}$ of \mathcal{H}_{\circ_i} on itself, $1 \leq i \leq l$. Then*

$$GA(\tilde{P}) \cong R(\mathfrak{G}) \bigotimes_{i=1}^l C_i(P_{M_i}, \mathcal{H}_{\circ_i}),$$

where $R(\mathfrak{G})$ denotes all identity transformations $1_{P_{M_i}}$, $1 \leq i \leq l$ induced by the right action of \mathfrak{G} on vertices in $G^{L\alpha}[\tilde{M}]$.

Proof For any $\varpi \in C_i(P_{M_i}, \mathcal{H}_{\circ_i})$, define $\omega : P_{M_i} \rightarrow P_{M_i}$ by $\omega(u) = u \circ_i \varpi(u)$ for $u \in P_{M_i}$. Notice that $\omega(u \circ_i g) = u \circ_i g \circ_i \varpi(u \circ_i g) = u \circ_i g \circ_i g_o_i^{-1} \varpi(u) \circ_i g = u \circ_i \varpi(u) \circ_i g = \omega(u) \circ_i g$. It follows that $\omega \in GA(P_{M_i})$.

Conversely, if $\omega \in GA(P_{M_i})$, define $\varpi : P_{M_i} \rightarrow \mathcal{H}_{\circ_i}$ by the relation $\omega(u) = u \circ_i \varpi(u)$. Then $u \circ_i g \circ \varpi(u \circ_i g) = \omega(u \circ_i g) = \omega(u) \circ_i g = u \circ_i \varpi(u) \circ_i g$. Whence, $\varpi(u \circ_i g) = g_o_i^{-1} \circ_i \varpi(u) \circ_i g$ and it follows that $\varpi \in C_i(P_{M_i}, \mathcal{H}_{\circ_i})$. Furthermore, if $\omega, \omega' \in GA(P_{M_i})$ with $\omega(u) = u \circ_i \varpi(u)$ and $\omega'(u) = u \circ_i \varpi'(u)$, then $\omega\omega'(u) = u \circ_i (\varpi(u)\varpi'(u))$. We know that $GA(P_{M_i}) \cong C_i(P_{M_i}, \mathcal{H}_{\circ_i})$.

Extend such isomorphisms $\iota_i : GA(P_{M_i}) \rightarrow C_i(P_{M_i}, \mathcal{H}_{\circ_i})$ linearly to $\tilde{P}^\alpha(\tilde{M}, \mathcal{L}_G)$. Notice that all identity transformations $1_{P_{M_i}}$ induced by the right action of \mathfrak{G} on vertices in $G^{L\alpha}[\tilde{M}]$ induce gauge transformations of $\tilde{P}^\alpha(\tilde{M}, \mathcal{L}_G)$ by definition, we get that

$$GA(\tilde{P}) \supseteq R(\mathfrak{G}) \bigotimes_{i=1}^l C_i(P_{M_i}, \mathcal{H}_{\circ_i}).$$

Besides, each gauge transformation ω of $\tilde{P}^\alpha(\tilde{M}, \mathcal{L}_G)$ with $\Pi(p) = \Pi(\omega(p))$ can be decomposed into a form $\omega = 1_{M_i} \circ_i \omega_i \circ_i 1_{M_i}$ by Construction 6.5.1, where $\omega_i \in C_i(P_{M_i}, \mathcal{H}_{\circ_i})$ for an integer i , $1 \leq i \leq l$. We finally get that

$$GA(\tilde{P}) = R(\mathfrak{G}) \bigotimes_{i=1}^l C_i(P_{M_i}, \mathcal{H}_{\circ_i}).$$

□

Corollary 6.5.2 *Let $P(M, \mathcal{H})$ be a principal fiber bundle over a manifold M . Then*

$$GA(P) \cong C(P_M, \mathcal{H}).$$

For any integer i , $1 \leq i \leq l$, let $\mathfrak{Y}(\mathcal{L}_G, \circ_i)$ be a Lie algebra of $\tilde{P}^\alpha(\tilde{M}, \mathcal{L}_G)$ with an adjoint representation $ad^{\circ_i} : \mathcal{H}_{\circ_i} \rightarrow GL(\mathfrak{Y}(\mathcal{L}_G, \circ_i))$ given by $g \rightarrow ad^{\circ_i}(g)$ for $\forall g \in \mathcal{H}_{\circ_i}$. Then the space $C_i(P_{M_i}, \mathfrak{Y}(\mathcal{L}_G, \circ_i))$ is called a *gauge algebra* of $P_{M_i}(M_i, \mathcal{H}_{\circ_i})$. If $C_i(P_{M_i}, \mathfrak{Y}(\mathcal{L}_G, \circ_i))$ has be defined for all integers $1 \leq i \leq l$, then the union

$$\bigcup_{i=1}^l C_i(P_{M_i}, \mathfrak{Y}(\mathcal{L}_G, \circ_i))$$

is called a *gauge multi-algebra* of $\tilde{P}^\alpha(\tilde{M}, \mathfrak{Y}(\mathcal{L}_G))$, denoted by $C(\tilde{P}, \mathcal{L}_G)$.

Theorem 6.5.6 *For an integer i , $1 \leq i \leq l$, if $H_i, H'_i \in C_i(P_{M_i}, \mathfrak{Y}(\mathcal{L}_G, \circ_i))$, let $[H_i, H'_i] : P_{M_i} \rightarrow \mathcal{H}_{\circ_i}$ be a mapping defined by $[H_i, H'_i](u) = [H_i(u), H'_i(u)]$ for $\forall u \in P_{M_i}$. Then $[H_i, H'_i] \in C_i(P_{M_i}, \mathfrak{Y}(\mathcal{L}_G, \circ_i))$, i.e., $C_i(P_{M_i}, \mathfrak{Y}(\mathcal{L}_G, \circ_i))$ has a Lie algebra structure. Consequently, $C(\tilde{P}, \mathcal{L}_G)$ has a Lie multi-algebra structure.*

Proof By definition, we know that

$$\begin{aligned} [H_i, H'_i](u \circ_i g) &= [H_i(u \circ_i g), H'_i(u \circ_i g)] \\ &= [ad^{\circ_i}(g_{\circ_i}^{-1})H_i(u), ad^{\circ_i}(g_{\circ_i}^{-1})H'_i(u)] \\ &= ad^{\circ_i}(g_{\circ_i}^{-1})[H_i(u), H'_i(u)] = ad^{\circ_i}(g_{\circ_i}^{-1})[H, H'](u) \end{aligned}$$

for $\forall u \in P_{M_i}$. Whence, $C_i(P_{M_i}, \mathfrak{Y}(\mathcal{L}_G, \circ_i))$ inherits a Lie algebra structure, and $C(\tilde{P}, \mathcal{L}_G)$ has a Lie multi-algebra structure. □

6.5.5 Connection on Principal Fiber Bundle. A *local connection* on a principal fiber bundle $\tilde{P}^\alpha(\tilde{M}, \mathcal{L}_G)$ is a linear mapping ${}^i\Gamma_u : T_x(\tilde{M}) \rightarrow T_u(\tilde{P})$ for an integer i , $1 \leq i \leq l$ and $u \in \Pi_i^{-1}(x) = {}^iF_x$, $x \in M_i$, enjoys the following properties:

- (i) $(d\Pi_i){}^i\Gamma_u$ = identity mapping on $T_x(\tilde{M})$;
- (ii) ${}^i\Gamma_{R_g \circ_i u} = d {}^iR_g \circ_i {}^i\Gamma_u$, where iR_g denotes the right translation on P_{M_i} ;
- (iii) the mapping $u \rightarrow {}^i\Gamma_u$ is C^∞ .

Similarly, a *global connection* on a principal fiber bundle $\tilde{P}^\alpha(\tilde{M}, \mathcal{L}_G)$ is a linear mapping $\Gamma_u : T_x(\tilde{M}) \rightarrow T_u(\tilde{P})$ for a $u \in \Pi^{-1}(x) = F_x$, $x \in \tilde{M}$ with conditions following hold:

- (i) $(d\Pi)\Gamma_u$ = identity mapping on $T_x(\tilde{M})$;

(ii) $\Gamma_{R_g \circ u} = dR_g \circ \Gamma_u$ for $\forall g \in \mathcal{L}_G$ and $\forall u \in \mathcal{O}(\mathcal{L}_G)$, where R_g denotes the right translation on \tilde{P} ;

(iii) the mapping $u \rightarrow \Gamma_u$ is C^∞ .

Certainly, there exist closed relations between the local and global connections on principal fiber bundles. A local or global connection on a principal fiber bundle $\tilde{P}^\alpha(\tilde{M}, \mathcal{L}_G)$ are distinguished by or not by indexes i for $1 \leq i \leq l$ in this subsection. We consider the local connections first, and then the global connections in the following.

Let ${}^iH_u = {}^i\Gamma_u(T_x(\tilde{M}))$ and ${}^iV_u = T_u({}^iF_x)$ the space of vectors tangent to the fiber iF_x , $x \in M_i$ at $u \in P_{M_i}$ with $\Pi_i(u) = x$. Notice that $d\Pi_i : T_u({}^iF_x) \rightarrow T_x(\{x\}) = \{\bar{0}\}$. For $\forall X \in {}^iV_u$, there must be $d\Pi_i(X) = \bar{0}$. These spaces iH_u and iV_u are called *horizontal* or *vertical space* of the connection ${}^i\Gamma_u$ at $u \in \tilde{P}$, respectively.

Theorem 6.5.7 *For an integer i , $1 \leq i \leq l$, a local connection ${}^i\Gamma$ in \tilde{P} is an assignment ${}^iH : u \rightarrow {}^iH_u \subset T_u(\tilde{P})$, of a subspace iH_u of $T_u(\tilde{P})$ to each $u \in {}^iF_x$ with*

- (i) $T_u(\tilde{P}) = {}^iH_u \oplus {}^iV_u$, $u \in {}^iF_x$;
- (ii) $(d {}^iR_g) {}^iH_u = {}^iH_{u \circ g}$ for $\forall u \in {}^iF_x$ and $\forall g \in \mathcal{H}_o$;
- (iii) iH is a C^∞ -distribution on \tilde{P} .

Proof By the linearity of the mapping ${}^i\Gamma_u$, $u \in {}^iF_x$ for $x \in M_i$, iH_u is a linear subspace of the tangent space $T_u(\tilde{P})$. Since $(d\Pi_i) {}^i\Gamma_u = \text{identity mapping on } T_x(\tilde{M})$, we know that $d\Pi_i$ is one-to-one. Whence, $d\Pi_i : {}^iH_u \rightarrow T_{\Pi_i(u)}(\tilde{M})$ is an isomorphism, which alludes that ${}^iH_u \cap {}^iV_u = \{\bar{0}\}$. In fact, if ${}^iH_u \cap {}^iV_u \neq \{\bar{0}\}$, let $X \in {}^iH_u \cap {}^iV_u$, $X \neq \bar{0}$. Then $d\Pi_i X = \bar{0}$ and $d\Pi_i X \in T_x(\tilde{M})$. Because $d\Pi_i : {}^iH_u \rightarrow T_u(\tilde{M})$ is an isomorphism, we know that $\text{Ker} d\Pi_i = \{\bar{0}\}$, which contradicts that $\bar{0} \neq X \in \text{Ker} d\Pi_i$.

Therefore, for $\forall X \in T_u(\tilde{P})$, there is a unique decomposition $X = X_h + X_v$, $X_h \in {}^iH_u$, $X_v \in {}^iV_u$, i.e.,

$$T_u(\tilde{P}) = {}^iH_u \oplus {}^iV_u.$$

Notice that

$${}^iH_{u \circ g} = {}^i\Gamma_{iR_g \circ u}(T_x(\tilde{M})) = (d {}^iR_g) {}^i\Gamma_u(T_x(\tilde{M})) = (d {}^iR_g) {}^iH_u.$$

So the property (ii) holds. Finally, the C^∞ -differentiable of iH is implied by the C^∞ -differentiable of the mapping $u \rightarrow {}^i\Gamma_u$.

Conversely, if ${}^iH : u \rightarrow {}^iH_u$ is a such C^∞ distribution on \tilde{P} , we can define a local connection to be a linear mapping ${}^i\Gamma_u : T_x(\tilde{M}) \rightarrow T_u(\tilde{P})$ for $u \in \Pi_i^{-1}(x) = {}^iF_x$, $x \in M_i$ by ${}^i\Gamma_u(T_u(\tilde{M})) = {}^iH_u$, which is a connection on $\tilde{P}^\alpha(\tilde{M}, \mathcal{L}_G)$. \square

Theorem 6.5.7(i) gives a projection of $T_u(\tilde{P})$ onto the tangent space $T_u({}^iF_x)$ of iF_x with $x \in M_i$ and $\Pi_i(u) = x$ by

$${}^i\nu : T_u(\tilde{P}) \rightarrow T_u({}^iF_x); X = X_v + X_h \rightarrow {}^i\nu X = X_v.$$

Moreover, there is an isomorphism from $\mathfrak{Y}(\mathcal{H}_{\circ_i}, \circ_i)$ to $T_u({}^iF_x)$ by the next result, which enables us to know that a local connection on a principal fiber bundle can be also in terms of a \mathfrak{Y} -valued 1-forms.

Theorem 6.5.8 *Let $\tilde{P}^\alpha(\tilde{M}, \mathcal{L}_G)$ be a principal fiber bundle. Then for any integer i , $1 \leq i \leq l$,*

(i) *there exists an isomorphism $\iota_i : \mathfrak{Y}(\mathcal{H}_{\circ_i}, \circ_i) \rightarrow T_u({}^iF_x)$ for $\forall u \in P_{M_i}$ with $\Pi_i(u) = x$;*

(ii) *if $\iota_i(X) = \hat{X}_v \in \mathfrak{Y}(\mathcal{H}_{\circ_i}, \circ_i)$, then $\iota_i((d {}^iR_g)X) = ad^{\circ_i}(g^{-1})\hat{X}_v \in \mathfrak{Y}(\mathcal{H}_{\circ_i}, \circ_i)$.*

Proof First, any left-invariant vector field $\hat{X} \in \mathcal{X}(\mathcal{H}_{\circ_i})$ gives rise to a vector field $X \in \mathcal{X}(P_{M_i})$ such that the mapping $\mathfrak{Y}(\mathcal{H}_{\circ_i}, \circ_i) \rightarrow P_{M_i}$ determined by $\hat{X} \rightarrow X$ is a homomorphism, which is injective. If $X_u = \bar{0} \in P_{M_i}$ for some $u \in P_{M_i}$, then $\hat{X} = 0_{\circ_i} \in \mathfrak{Y}(\mathcal{H}_{\circ_i}, \circ_i)$. Notice that $u \circ_i g = {}^iR_g u = u \circ_i \exp(tX)$, $g \in \mathcal{H}_{\circ_i}$, lies on the same fiber as u by definition of the principal fiber bundle and Construction 6.5.1. Whence, the mapping $\iota_i : \mathfrak{Y}(\mathcal{H}_{\circ_i}, \circ_i) \rightarrow T_u({}^iF_x)$ is an injection into the tangent space at u to the fiber iF_x with the same dimension as $\mathfrak{Y}(\mathcal{H}_{\circ_i}, \circ_i)$. Therefore, for $\forall Y \in T_u({}^iF_x)$, there exists a unique $\hat{X}_u \in \mathfrak{Y}(\mathcal{H}_{\circ_i}, \circ_i)$ such that $\iota_i(\hat{X}) = Y$, i.e., an isomorphism. That is the assertion of (i).

Notice that if X_v generates a 1-parameter subgroup ${}^i\varphi_t$, then $(d {}^iR_g)X_v$ generates the 1-parameter group ${}^iR_g {}^i\varphi_t {}^iR_g^{-1}$. Let $\gamma_i(t) : \mathbf{R} \rightarrow \mathcal{H}_{\circ_i}$ the 1-parameter subgroup of \mathcal{H}_{\circ_i} generated by $\hat{X} \in \mathfrak{Y}(\mathcal{H}_{\circ_i}, \circ_i)$ and ${}^i\varphi(t) = {}^iR_{\gamma_i(t)}$. Then

$${}^iR_g {}^iR_{\gamma(t)} {}^iR_g^{-1} = {}^iR_{g^{-1} \circ_i \gamma(t) \circ_i g}.$$

Whence, the element of $\mathfrak{Y}(\mathcal{H}_{\circ_i}, \circ_i)$ corresponding to $(d \ ^iR_g)X_v$ generates the 1-parameter subgroup $g^{-1} \circ_i \gamma_i(t) \circ_i g$ of \mathcal{H}_{\circ_i} , i.e., $g^{-1} \circ_i \gamma_i(t) \circ_i g$ is the 1-parameter subgroup generated by $(ad^{\circ_i}(g^{-1}))\widehat{X}_v$ such as those shown in Fig.6.5.4,

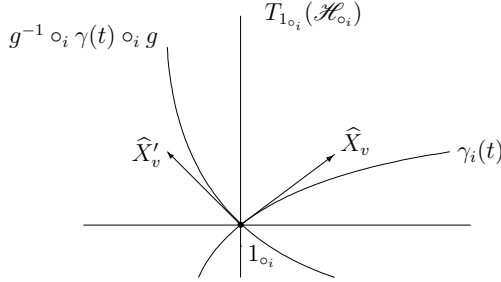

Fig.6.5.4

where $\gamma_i(t) = \text{expt}\widehat{X}_v$, $g^{-1} \circ_i \gamma(t) \circ_i g = g^{-1} \circ_i \text{expt}\widehat{X}_v \circ_i g = \text{expt}(ad^{\circ_i}g^{-1}\widehat{X}_v)$ and $\widehat{X}'_v = (ad^{\circ_i}g^{-1})\widehat{X}_v$, $\widehat{X}_v, \widehat{X}'_v \in \mathfrak{Y}(\mathcal{H}_{\circ_i}, \circ_i)$. □

Application of Theorem 6.5.8 enables us to get a linear mapping $T_u(\widetilde{P}) \rightarrow \mathcal{H}_{\circ_i}$, which defines a $\mathfrak{Y}(\mathcal{H}_{\circ_i}, \circ_i)$ -valued 1-form ${}^i\omega_u = \iota_i{}^i v$ on \widetilde{P} , where ι_i and ${}^i v$ are shown in the following diagram.

$$T_u(\widetilde{P}) \xrightarrow{{}^i v} T_u({}^i F_x) \cong \mathfrak{Y}(\mathcal{H}_{\circ_i}, \circ_i)$$

Theorem 6.5.9 For any integer i , $1 \leq i \leq l$, let ${}^i\Gamma$ be a local connection on $\widetilde{P}^\alpha(\widetilde{M}, \mathcal{L}_G)$. Then there exists a $\mathfrak{Y}(\mathcal{H}_{\circ_i}, \circ_i)$ -valued 1-form ${}^i\omega$ on P_{M_i} , i.e., the connection form satisfying conditions following:

(i) ${}^i\omega(X)$ is vertical, i.e., ${}^i\omega(X) = {}^i\omega(X_v) = \widehat{X}_v$, where $X_v \in {}^iV_u \subset T_u(\widetilde{P})$ and ${}^i\omega(X) = \bar{0}$ if and only if $X \in {}^iH_u$;

(ii) ${}^i\omega((d \ ^iR_g)X) = ad^{\circ_i}g^{-1}{}^i\omega(X)$ for $\forall g \in \mathcal{H}_{\circ_i}$ and $\forall X \in \mathcal{X}(P_{M_i})$.

Proof Let ${}^i\omega = \iota_i{}^i v$. Then ${}^i\omega(X) = \iota_i{}^i v(X) = \iota_i(X_v) = \widehat{X}_v \in \mathfrak{Y}(\mathcal{H}_{\circ_i}, \circ_i)$. Moreover, $X \in {}^iH_u$ if and only if ${}^i v(X) = \bar{0}$, i.e., ${}^i\omega(X) = \bar{0}$, which is equivalent to ${}^i\omega(X) = \bar{0}$.

By Theorem 6.5.8(ii), we know that

$${}^i\omega((d {}^iR_g)X) = {}^i\omega([(d {}^iR_g)X]_v) = {}^i\omega((d {}^iR_g)X_v) = ad^{\circ i}(g^{-1}){}^i\omega(X).$$

For showing that ${}^i\omega$ depends differentiably on u , it suffices to show that for any C^∞ -vector field $X \in \tilde{P}$, ${}^i\omega(X)$ is a differentiable $\mathfrak{Y}(\mathcal{H}_{\circ_i}, \circ_i)$ -valued mapping. In fact, X is C^∞ implies that ${}^i v(X) : u \rightarrow ({}^i vX)_u$ and ${}^i h(X) : u \rightarrow ({}^i hX)_u$ are of class C^∞ and since ${}^i vX$ is differentiable at u , so is $\hat{X}_v = {}^i\omega(X)$.

Conversely, given a differentiable $\mathfrak{Y}(\mathcal{H}_{\circ_i}, \circ_i)$ -valued 1-form ${}^i\omega$ on \tilde{P} with conditions (i)-(ii) hold, define the distribution

$${}^iH_u = \{ X \in T_u(\tilde{P}) \mid {}^i\omega(X) = \bar{0} \}.$$

Then the assignment $u \rightarrow {}^iH_u$ defines a local connection with its connection form ${}^i\omega$. In fact, for $\forall X \in {}^iV_u$, ${}^i\omega(X) \neq \bar{0}$ implies $X \notin {}^iH_u$. Therefore, ${}^iH_u \cap {}^iV_u = \{\bar{0}\}$ and $T_u(\tilde{P}) = {}^iH_u + {}^iV_u$. In fact, let ${}^i\omega(X) = \hat{X}_v$. But we know that ${}^i\omega(X_v) = \hat{X}_v$. Let $Z = X - X_v$. We find that ${}^i\omega(Z) = {}^i\omega(X) - {}^i\omega(X_v) = \bar{0}$. Hence, $Z \in {}^iH_u$, which implies that $T_u(\tilde{P}) = {}^iH_u \oplus {}^iV_u$. That is the condition (i) in Theorem 6.5.7.

Now for any $X \in {}^iH_u$, we have that ${}^i\omega((d {}^iR_g)X) = (ad^{\circ i}g^{-1}) {}^i\omega(X) = \bar{0}$. Whence, $(d {}^iR_g)X$ is horizontal, i.e., $(d {}^iR_g) {}^iH_u \subset {}^iH_{u \circ_i g}$.

Let $X_{u \circ_i g} \in {}^iH_{u \circ_i g}$ with $X_{u \circ_i g} = (d {}^iR_g)X_u$ for some $X_u \in T_u(\tilde{P})$. We show that $X_u \in {}^iH_u$. Notice that $X_{u \circ_i g} = (d {}^iR_g)X_u$ is equivalent to $X_u = (d {}^iR_{g^{-1}})X_{u \circ_i g}$. We get that

$${}^i\omega(X_u) = {}^i\omega((d {}^iR_{g^{-1}})X_{u \circ_i g}) = (ad^{\circ i}g^{-1}) {}^i\omega(X_{u \circ_i g}) = \bar{0},$$

which implies that X_u is horizontal. Furthermore, since $u \rightarrow {}^i\omega(u)$ is of class C^∞ , and X is a C^∞ -vector field, so is ${}^i vX$ and therefore $u \rightarrow {}^iH_u$ is of class C^∞ . \square

Now we turn our attention to the global connections on principal fiber bundles. Notice the proofs of Theorems 6.5.7 and 6.5.9 are directly by the definition of local connection. Whence, the same arguments can also establishes the following results on global connections.

Theorem 6.5.10 *A global connection Γ in \tilde{P} is an assignment $H : u \rightarrow H_u \subset T_u(\tilde{P})$, of a subspace H_u of $T_u(\tilde{P})$ to each $u \in F_x$ with*

$$(i) \quad T_u(\tilde{P}) = H_u \oplus V_u, \quad u \in F_x;$$

- (ii) $(dR_g)H_u = H_{u \circ g}$ for $\forall u \in F_x, \forall g \in \mathcal{L}_G$ and $\circ \in \mathcal{O}(\mathcal{L}_G)$;
- (iii) H is a C^∞ -distribution on \tilde{P} .

Theorem 6.5.11 *Let Γ be a global connection on $\tilde{P}^\alpha(\tilde{M}, \mathcal{L}_G)$. Then there exists a $\mathfrak{Y}(\mathcal{L}_G)$ -valued 1-form ω on \tilde{P} , i.e., the connection form satisfying conditions following:*

- (i) $\omega(X)$ is vertical, i.e., $\omega(X) = \omega(X_v) = \hat{X}_v$, where $X_v \in V_u \subset T_u(\tilde{P})$ and $\omega(X) = \bar{0}$ if and only if $X \in H_u$;
- (ii) $\omega((dR_g)X) = ad^g \omega(X)$ for $\forall g \in \mathcal{L}_G, \forall X \in \mathcal{X}(\tilde{P})$ and $\circ \in \mathcal{O}(\mathcal{L}_G)$.

Certainly, all local connections on a principal fiber bundle exist if a global connection on this principal fiber bundle exist first. But the converse is not obvious. So it is interesting to find conditions under which a global connection exists. We know the following result on this question.

Theorem 6.5.12 *Let ${}^i\Gamma$ be a local connections on $\tilde{P}^\alpha(\tilde{M}, \mathcal{L}_G)$ for $1 \leq i \leq l$. Then a global connection on $\tilde{P}^\alpha(\tilde{M}, \mathcal{L}_G)$ exists if and only if $(\mathcal{H}_{\circ_i}; \circ_i) = (\mathcal{H}; \circ)$, i.e., \mathcal{L}_G is a group and ${}^i\Gamma|_{M_i \cap M_j} = {}^j\Gamma|_{M_i \cap M_j}$ for $(M_i, M_j) \in E(G^L[\tilde{M}])$, $1 \leq i, j \leq l$.*

Proof If there exists a global connection Γ on a principal fiber bundle $\tilde{P}^\alpha(\tilde{M}, \mathcal{L}_G)$, then $\Gamma|_{M_i}, 1 \leq i \leq l$ are local connections on $\tilde{P}^\alpha(\tilde{M}, \mathcal{L}_G)$ with ${}^i\Gamma|_{M_i \cap M_j} = {}^j\Gamma|_{M_i \cap M_j}$ for $(M_i, M_j) \in E(G^L[\tilde{M}])$, $1 \leq i, j \leq l$.

Furthermore, by the condition (ii) in the definition of global connection, $R_g \circ u = u \circ g$ is well-defined for $\forall g \in \mathcal{L}_G, \forall \circ \in \mathcal{O}(\mathcal{L}_G)$, i.e., g acts on all $u \in \tilde{P}$. Whence, $(\mathcal{H}_{\circ_i}; \circ_i) = (\mathcal{H}; \circ)$ if $g \in \mathcal{H}_{\circ_i}, 1 \leq i \leq l$, which means that $\mathcal{L}_G = (\mathcal{H}; \circ)$ is a group.

Conversely, if \mathcal{L}_G is a group and ${}^i\Gamma|_{M_i \cap M_j} = {}^j\Gamma|_{M_i \cap M_j}$ for $(M_i, M_j) \in E(G^L[\tilde{M}])$, $1 \leq i, j \leq l$, we can define a linear mapping $\Gamma_u : T_x(\tilde{M}) \rightarrow T_u(\tilde{P})$ by $\Gamma_u = {}^i\Gamma_u$ for a $u \in \Pi^{-1}(x) = F_x, x \in M_i$. Then it is easily to know that the mapping Γ satisfies conditions of a global connection. In fact, by definition, we know that

- (1) $(d\Pi)\Gamma_u = (d\Pi_i) {}^i\Gamma =$ identity mapping on $T_x(M_i)$ for $1 \leq i \leq l$. Hence, $(d\Pi)\Gamma_u =$ identity mapping on $T_x(\tilde{M})$;
- (2) $\Gamma_{R_g \circ u} = {}^i\Gamma_{R_g \circ u} = dR_g \circ {}^i\Gamma_u$ if $x \in M_i, 1 \leq i \leq l$. That is $\Gamma_{R_g \circ u} = dR_g \circ {}^i\Gamma_u$ for $\forall g \in \mathcal{L}_G$;
- (3) the mapping $u \rightarrow {}^i\Gamma_u$ is C^∞ if $x \in M_i, 1 \leq i \leq l$. Whence, $u \rightarrow \Gamma_u$ is C^∞ .

This completes the proof. □

We have known there exists a connection on a common principal fiber bundle $P(M, \mathcal{H})$ in classical differential geometry. For example, the references [Bell] or [Wes1]. Combining this fact with Theorems 6.5.4 and 6.5.12, we get the next consequence.

Corollary 6.5.3 *There are always exist global connections on a normally principal fiber bundle $\tilde{P}^\alpha(\tilde{M}, \mathcal{L}_G)$.*

6.5.6 Curvature Form on Principal Fiber Bundle. Let $\tilde{P}^\alpha(\tilde{M}, \mathcal{L}_G)$ be a principal fiber bundle associated with local connection form ${}^i\omega$, $1 \leq i \leq l$ or a global connection form ω . A *curvature form* of a local or global connection form is a $\mathfrak{Y}(\mathcal{H}_{\circ_i}, \circ_i)$ or $\mathfrak{Y}(\mathcal{L}_G)$ -valued 2-form

$${}^i\Omega = (d {}^i\omega)h, \quad \text{or} \quad \Omega = (d\omega)h,$$

where

$$(d {}^i\omega)h(X, Y) = d {}^i\omega(hX, hY), \quad (d\omega)h(X, Y) = d\omega(hX, hY)$$

for $X, Y \in \mathcal{X}(P_{M_i})$ or $X, Y \in \mathcal{X}(\tilde{P})$. Notice that a 1-form $\omega h(X_1, X_2) = 0$ if and only if ${}^i h(X_1) = 0$ or ${}^i h(X_2) = 0$. We have the following structural equation on principal fiber bundles.

Theorem 6.5.13(E.Cartan) *Let ${}^i\omega$, $1 \leq i \leq l$ and ω be local or global connection forms on a principal fiber bundle $\tilde{P}^\alpha(\tilde{M}, \mathcal{L}_G)$. Then*

$$(d {}^i\omega)(X, Y) = -[{}^i\omega(X), {}^i\omega(Y)] + {}^i\Omega(X, Y)$$

and

$$d\omega(X, Y) = -[\omega(X), \omega(Y)] + \Omega(X, Y)$$

for vector fields $X, Y \in \mathcal{X}(P_{M_i})$ or $\mathcal{X}(\tilde{P})$.

Proof We only prove the structural equation for local connections, i.e., the equation

$$(d {}^i\omega)(X, Y) = -[{}^i\omega(X), {}^i\omega(Y)] + {}^i\Omega(X, Y).$$

The proof for the structural equation of global connections is similar. We consider three cases following.

Case 1. $X, Y \in {}^iH_u$

In this case, X, Y are horizontal. Whence, ${}^i\omega(X) = {}^i\omega(Y) = 0$. By definition, we know that $(d {}^i\omega)(X, Y) = {}^i\Omega(X, Y) = -[{}^i\omega(X), {}^i\omega(Y)] + {}^i\Omega(X, Y)$.

Case 2. $X, Y \in {}^iV_u$

Applying the equation in Theorem 5.2.5, we know that

$$(d {}^i\omega)(X, Y) = X {}^i\omega(Y) - Y {}^i\omega(X) - {}^i\omega([X, Y]).$$

Notice that ${}^i\omega(X) = {}^i\omega(X_v) = \widehat{X}$ is a constant function. We get that $X {}^i\omega(Y) = Y {}^i\omega(X) = 0$. Hence,

$$(d {}^i\omega)(X_v, Y_v) = - {}^i\omega([X_v, Y_v]) = - {}^i\omega([X, Y]_v) = \widehat{[X, Y]}_v = -[\widehat{X}, \widehat{Y}],$$

which means that the structural equation holds.

Case 3. $X \in {}^iV_u$ and $Y \in {}^iH_u$

Notice that ${}^i\omega(Y) = 0$ and $Y {}^i\omega(X) = 0$ with the same reason as in Case 2. One can show that $[X, Y] \in {}^iH_u$ in this case. In fact, let X be induced by ${}^rR_{\varphi_t}$, where φ_t is the 1-parameter subgroup of $\mathcal{H}_{\mathfrak{o}_i}$ generated by \widehat{X}_v . Then

$$[X, Y] = L_X Y = \lim_{t \rightarrow 0} \frac{1}{t} (d {}^iR_{\varphi_t} Y - Y)$$

implies that $[X, Y] \in {}^iH_u$ since Y and $(d {}^iR_{\varphi_t})Y$ are horizontal by Theorem 6.5.10(ii). Whence, ${}^i\omega([X, Y]) = 0$. Therefore, $(d {}^i\omega)(X, Y) = 0$, which is consistent with the right hand side of the structure equation. \square

Notice that the structural equation can be also written as

$${}^i\Omega = d {}^i\omega + \frac{1}{2} [{}^i\omega, {}^i\omega], \quad \text{and} \quad \Omega = d\omega + \frac{1}{2} [\omega, \omega]$$

since $[\omega, \omega](X, Y) = 2[\omega(X), \omega(Y)]$ for any 1-form ω . Using the structural equation, we can also establish the *Bianchi's identity* for principal fiber bundles $\widetilde{P}^\alpha(\widetilde{M}, \mathcal{L}_G)$ following.

Theorem 6.5.14(Bianchi) *Let ${}^i\omega$, $1 \leq i \leq l$ and ω be local or global connection forms on a principal fiber bundle $\widetilde{P}^\alpha(\widetilde{M}, \mathcal{L}_G)$. Then*

$$(d \ ^i\Omega)h = 0, \quad \text{and} \quad (d\Omega)h = 0.$$

Proof We only check that $(d \ ^i\Omega)h = 0$ since the proof for $(d\Omega)h = 0$ is similar. applying Theorem 6.5.13, by definition, we now that

$$(d \ ^i\Omega)h(X, Y, Z) = dd \ ^i\omega h(X, Y, Z) + \frac{1}{2}d[\ ^i\omega, \ ^i\omega]h(X, Y, Z) = 0$$

because of

$$dd \ ^i\omega h(X, Y, Z) = 0, \quad \text{and} \quad d[\ ^i\omega, \ ^i\omega]h(X, Y, Z) = 0$$

by applying Theorem 5.2.4 and $\ ^i\omega$ vanishes on horizontal vectors. \square

§6.6 REMARKS

6.6.1 Combinatorial Riemannian Submanifold. A combinatorial manifold is a combination of manifolds underlying a connected graph G . So it is natural to characterize its combinatorial submanifolds by properties of its graph and submanifolds. In fact, a special kind of combinatorial submanifolds, i.e., combinatorial in-submanifolds are characterized by such way, for example, the Theorem 4.2.5 etc. in Section 4.2.2. Similarly, not like these *Gauss's*, *Codazzi's* or *Ricci's* formulae in Section 6.1, we can also describe combinatorial Riemannian submanifolds in such way by formulae on submanifolds of Riemannian manifolds and subgraphs of a connected graph. This will enables us to find new characters on combinatorial Riemannian submanifolds.

6.6.2 Fundamental Equations. The discussion in Section 6.2 shows that we can also establish these fundamental equations, such as the *Gauss's*, the *Codazzi's* or the *Ricci's* for combinatorial Riemannian submanifold in global or local forms. But in fact, to solve these partially differential equations, even for Riemannian submanifolds of the Euclidean space \mathbf{R}^n , is very difficult. In references, we can only find a few solutions for special cases, i.e., additional conditions added. So the classical techniques for solving these partially differential equations is not effective. New solving techniques for functional equations, particularly, the partially differential

equations should be produced. Even through, these *Gauss's*, *Codazzi's* or *Ricci's* equations can be also seen as a kind of geometrical equations of fields. So they are important in physics.

6.6.3 Embedding. By the Whitney's result on embedding a smooth manifold in a Euclidean space, any manifold is a submanifold of a Euclidean space. Theorem 6.3.6 generalizes this result to combinatorial Riemannian submanifolds, which definitely answers a question in [Mao12]. Certainly, a combinatorial Riemannian submanifold can be embedded into some combinatorial Euclidean spaces, i.e., the result in Theorem 6.3.7 with its corollary. Even through, there are many research problems on embedding a combinatorial Riemannian manifold or generally, a combinatorial manifold into a combinatorial Riemannian manifold or a smoothly combinatorial manifold. But the fundamental is to embed a smoothly combinatorial manifold into a combinatorial Euclidean space. For this objective, Theorem 6.3.7 is only an elementary such result.

6.6.4 Topological Multi-Group. In modern view point, a topological group is a union of a topological space and a group, i.e., a Smarandache multi-space with multiple 2. That is the motivation introducing topological multi-groups, topological multi-rings or topological multi-fields. The classification of locally compacted topological fields, i.e., Theorem 6.4.4 is a wonderful result obtained by a Russian mathematician *Pontrjagin* in 1930s. This result can be generalized to topological multi-spaces, i.e., Theorem 6.4.5.

In topological groups, a topological subgroup of a topological group is a subgroup of this topological group in algebra. The same is hold for topological multi-group. Besides, the most fancy thing on topological multi-groups is the appearance of homomorphism theorem, i.e., the Theorem 6.4.3 which is as the same as Theorem 2.3.2 for homomorphism theorems in multi-groups.

6.6.5 Lie Multi-Group. Topological groups were gotten attention after S.Lie introducing the conception of Lie group, which is a union of a manifold and a group with group operation differentiable. Today, Lie group has become a fundamental tool in theoretical physics, particularly, in mechanics and gauge theory. Analogy, for dealing with combinatorial fields in the following chapters, we therefore introduce Lie multi-groups, which is a union of a combinatorial manifold and a multi-group with

group operations differentiable. Certainly, it has similar properties as the Lie group, also combinatorial behaviors. Elementary results on Lie groups and Lie algebra are generalized to Lie multi-groups in Section 6.4. But there are still many valuable works on Lie multi-groups should be done, for example, the representation theory for Lie multi-groups, the classification of Lie algebras on Lie multi-groups, \dots , etc..

6.6.6 Principal Fiber Bundle. A classical principal fiber bundle is essentially a combining of a manifold, its covering manifold associated with a Lie group. Today, it has been a fundamental conception in modern differential geometry and physics. The principal fiber bundle discussed in Section 6.5 is an extended one of the classical, which is a Smarandachely principal fiber bundle underlying a combinatorial structure G , i.e., a combinatorial principal fiber bundle.

The voltage assignment technique $\alpha : G^L \rightarrow \mathfrak{G}$ is widely used in the topological graph theory for find a regular covering of a graph G , particularly, to get the genus of a graph in [GrT1]. Certainly, this kind of regular covering $G^{L\alpha}$ of G^L posses many automorphisms, particularly, the right action $R(\mathfrak{G})$ on vertices of $G^{L\alpha}$. More results can be found in references, such as those of [GrT1], [MNS1], [Mao1] and [Whi1].

Combining the voltage assignment technique $\alpha : G^L \rightarrow \mathfrak{G}$ with l classical principal fiber bundles $P_{M_1}(M_1, \mathcal{H}_{o_1}), P_{M_2}(M_2, \mathcal{H}_{o_2}), \dots, P_{M_l}(M_l, \mathcal{H}_{o_l})$ produces the combinatorial principal fiber bundles $\tilde{P}^\alpha(\tilde{M}, \mathcal{L}_G)$ in Construction 6.5.1 in Section 6.5 analogous to classical principal fiber bundles. For example, their gauge transformations are completely determined in Theorem 6.5.5. The behavior of $\tilde{P}^\alpha(\tilde{M}, \mathcal{L}_G)$ likewise to classical principal fiber bundles enables us to introduce those of local or global *Ehresmann* connections, to determine those of local or global curvature forms, and to find structure equations or *Bianchi* identity on such principal fiber bundles. All of these are important in combinatorial fields of Chapter 8.

CHAPTER 7.

Fields with Dynamics

All known matters are made of atoms and sub-atomic particles, held together by four fundamental forces: *gravity*, *electro-magnetism*, *strong nuclear force* and *weak force*, partially explained by the *Relativity Theory* and *Quantum Field Theory*. The former is characterized by actions in external fields, the later by actions in internal fields under the dynamics. Both of these fields can be established by the *Least Action Principle*. For this objective, we introduce variational principle, Lagrangian equations, Euler-Lagrange equations and Hamiltonian equations in Section 7.1. In section 7.2, the gravitational field and Einstein gravitational field equations are presented, also show the Newtonian field to be that of a limitation of Einstein's. Applying the *Schwarzschild metric*, spherical symmetric solutions of Einstein gravitational field equations can be found in this section. This section also discussed the singularity of Schwarzschild geometry. For a preparation of the interaction, we discuss electromagnetism, such as those of electrostatic, magnetostatic and electromagnetic fields in Section 7.3. The Maxwell equations can be found in this section. Section 7.4 is devoted to the interaction, i.e., the gauge fields including *Abelian* and *non-Abelian gauge fields (Yang-Mills fields)* with *Higgs mechanisms* and C , P , T transformations in details. This section also presents the differential geometry of gauge fields and its mathematical meaning of spontaneous symmetry broken in gauge fields. It should be noted that an Greek index μ usually denote the scope 0, 1, 2, \dots , but an arabic i only the scope 1, 2, \dots , i.e., without 0 in the context.

§7.1 MECHANICAL FIELDS

7.1.1 Particle Dynamic. The phase of a physical particle A of quality m is determined by a pair $\{\mathbf{x}, \mathbf{v}\}$ of its position \mathbf{x} and directed velocity \mathbf{v} at \mathbf{x} in its geometrical space P , such as those shown in Fig.7.1.1.

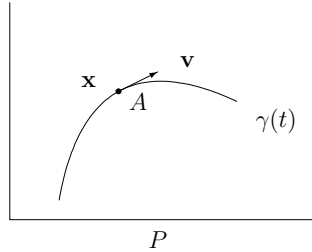

Fig.7.1.1

If A is moving in a conservative field \mathbf{R}^n with potential energy $U(\mathbf{x})$, then $\mathbf{x} = (x_1(t), x_2(t), \dots, x_n(t)) = \gamma(t)$ and

$$\mathbf{v} = (v_1, v_2, \dots, v_n) = \frac{d\mathbf{x}}{dt} = (\dot{x}_1, \dot{x}_2, \dots, \dot{x}_n) \quad (7-1)$$

at t . In other words, \mathbf{v} is a tangent vector at $\mathbf{x} \in \mathbf{R}^n$, i.e., $\mathbf{v} \in T(\mathbf{R}^n)$. In this field, the force acting on A is

$$\mathbf{F} = -\frac{\partial U}{\partial \mathbf{x}} = -\left(\frac{\partial U}{\partial x_1}\mathbf{e}_1 + \frac{\partial U}{\partial x_2}\mathbf{e}_2 + \dots + \frac{\partial U}{\partial x_n}\mathbf{e}_n\right). \quad (7-2)$$

By the second law of Newton, we know the force \mathbf{F} acting on A is

$$\mathbf{F} = m\frac{d^2\mathbf{x}}{dt^2} = m\ddot{\mathbf{x}} \quad (7-3)$$

that is

$$\left(-\frac{\partial U}{\partial x_1}, -\frac{\partial U}{\partial x_2}, \dots, -\frac{\partial U}{\partial x_n}\right) = (m\ddot{x}_1, m\ddot{x}_2, \dots, m\ddot{x}_n). \quad (7-4)$$

By definition, its momentum and moving energy are respective

$$\mathbf{p} = m\mathbf{v} = m\dot{\mathbf{x}}$$

and

$$T = \frac{1}{2}mv_1^2 + \frac{1}{2}mv_2^2 + \cdots + \frac{1}{2}mv_n^2 = \frac{1}{2}m\mathbf{v}^2,$$

where $v = |\mathbf{v}|$. Furthermore, if the particle A moves from times t_1 to t_2 , then

$$\int_{t_1}^{t_2} \mathbf{F} \cdot dt = \mathbf{p}|_{t_2} - \mathbf{p}|_{t_1} = m\mathbf{v}_2 - m\mathbf{v}_1$$

by the momentum theorem in undergraduate physics.

We deduce the *Lagrange equations* for the particle A . First, inner multiply both sides of (7-4) by $d\mathbf{x} = (dx_1, dx_2, \cdots, dx_n)$ on, we find that

$$-\sum_{i=1}^n \frac{\partial U}{\partial x_i} dx_i = \sum_{i=1}^n m\ddot{x}_i dx_i. \tag{7-5}$$

Let $\mathbf{q} = (q_1, q_2, \cdots, q_n)$ be its generalized coordinates of A at t . Then we know that

$$x_i = x_i(q_1, q_2, \cdots, q_n), \quad i = 1, 2, \cdots, n. \tag{7-6}$$

Differentiating (7-6), we get that

$$dx_i = \sum_{k=1}^n \frac{\partial x_i}{\partial q_k} dq_k \tag{7-7}$$

for $i = 1, 2, \cdots, n$. Therefore, we know that

$$\sum_{i=1}^n m\ddot{x}_i dx_i = \sum_{i=1}^n \sum_{k=1}^n m\ddot{x}_i \frac{\partial x_i}{\partial q_k} dq_k = \sum_{k=1}^n \sum_{i=1}^n m\ddot{x}_i \frac{\partial x_i}{\partial q_k} dq_k. \tag{7-8}$$

Notice that

$$dU = \sum_{i=1}^n \frac{\partial U}{\partial x_i} dx_i = \sum_{k=1}^n \frac{\partial U}{\partial q_k} dq_k. \tag{7-9}$$

Substitute (7-8) and (7-9) into (7-5), we get that

$$\sum_{k=1}^n \left(\sum_{i=1}^n m \ddot{x}_i \frac{\partial x_i}{\partial q_k} \right) dq_k = - \sum_{i=1}^n \frac{\partial U}{\partial q_k} dq_k.$$

Since dq_k , $k = 1, 2, \dots, n$ are independent, there must be

$$\sum_{i=1}^n m \ddot{x}_i \frac{\partial x_i}{\partial q_k} = - \frac{\partial U}{\partial q_k}, \quad k = 1, 2, \dots, n. \quad (7-10)$$

Calculation shows that

$$\sum_{i=1}^n m \ddot{x}_i \frac{\partial x_i}{\partial q_k} = \frac{d}{dt} \left(\sum_{i=1}^n m \dot{x}_i \frac{\partial x_i}{\partial q_k} \right) - \sum_{i=1}^n m \dot{x}_i \frac{d}{dt} \frac{\partial x_i}{\partial q_k}. \quad (7-11)$$

Substitute (7-11) into (7-10), we know that

$$\frac{d}{dt} \left(\sum_{i=1}^n m \dot{x}_i \frac{\partial x_i}{\partial q_k} \right) - \sum_{i=1}^n m \dot{x}_i \frac{d}{dt} \frac{\partial x_i}{\partial q_k} = - \sum_{i=1}^n \frac{\partial U}{\partial q_k} dq_k \quad (7-12)$$

for $k = 1, 2, \dots, n$. For simplifying (7-12), we need the differentiations of x_i and $\partial x_i / \partial q_k$ with respect to t following.

$$\dot{x}_i = \frac{dx_i}{dt} = \sum_{k=1}^n \frac{\partial x_i}{\partial q_k} \dot{q}_k, \quad (7-13)$$

$$\frac{d}{dt} \frac{\partial x_i}{\partial q_k} = \sum_{l=1}^n \frac{\partial^2 x_i}{\partial q_k \partial q_l} \dot{q}_l = \frac{\partial}{\partial q_l} \sum_{l=1}^n \frac{\partial x_i}{\partial q_l} \dot{q}_l = \frac{\partial}{\partial q_k} \dot{x}_i. \quad (7-14)$$

Notice that $\partial x_i / \partial q_k$ is independent on \dot{q}_k . Differentiating (7-13) with respect to \dot{q}_k , we get that

$$\frac{\partial \dot{x}_i}{\partial \dot{q}_k} = \frac{\partial x_i}{\partial q_k}. \quad (7-15)$$

Substitute (7-14) and (7-15) into (7-12), we have that

$$\frac{d}{dt} \left(\sum_{i=1}^n m \dot{x}_i \frac{\partial \dot{x}_i}{\partial \dot{q}_k} \right) - \sum_{i=1}^n m \dot{x}_i \frac{\partial \dot{x}_i}{\partial q_k} = - \sum_{i=1}^n \frac{\partial U}{\partial q_k} dq_k \quad (7-16)$$

for $k = 1, 2, \dots, n$. Because of the moving energy of A

$$T = \frac{1}{2} m \mathbf{v}^2 = \sum_{i=1}^n \frac{1}{2} m \dot{x}_i^2,$$

partially differentiating it with respect to q_k and \dot{q}_k , we find that

$$\frac{\partial T}{\partial q_k} = \sum_{i=1}^n m \dot{x}_i \frac{\partial \dot{x}_i}{\partial q_k}, \quad \frac{\partial T}{\partial \dot{q}_k} = \sum_{i=1}^n m \dot{x}_i \frac{\partial \dot{x}_i}{\partial \dot{q}_k}. \quad (7-17)$$

Comparing (7-16) with (7-17), we can rewrite (7-16) as follows.

$$\frac{d}{dt} \frac{\partial T}{\partial \dot{q}_k} - \frac{\partial T}{\partial q_k} = - \frac{\partial U}{\partial q_k}, \quad k = 1, 2, \dots, n. \quad (7-18)$$

Since A is moving in a conservative field, $U(\mathbf{x})$ is independent on \dot{q}_k . We have that $\partial U / \partial \dot{q}_k = 0$ for $k = 1, 2, \dots, n$. By moving the right side to the left in (7-18), we consequently get the *Lagrange equations* for the particle A following.

$$\frac{d}{dt} \frac{\partial \mathcal{L}}{\partial \dot{q}_k} - \frac{\partial \mathcal{L}}{\partial q_k} = 0, \quad k = 1, 2, \dots, n, \quad (7-19)$$

where $\mathcal{L} = T - U$ is called the *Lagrangian* of A and

$$f_k = \frac{\partial \mathcal{L}}{\partial q_k}, \quad p_k = \frac{\partial \mathcal{L}}{\partial \dot{q}_k}, \quad k = 1, 2, \dots, n \quad (7-20)$$

the respective *generalized force* and *generalized momentum* in this conservative field.

7.1.2 Variational Principle. Let \mathcal{X} be a closed set of a normed space \mathcal{B} with a norm $\| \cdot \|$ and $C(\mathcal{X})$ the family of functions on \mathcal{X} . A *functional* J on \mathcal{X} is a mapping $J : C(\mathcal{X}) \rightarrow \mathbf{R}$, denoted by $J[F]$ for $F \in C(\mathcal{X})$. For a chosen function $F_0(\mathcal{X}) \in C(\mathcal{X})$, the difference $F(\mathcal{X}) - F_0(\mathcal{X})$ is called the *variation of $F(\mathcal{X})$* at $F_0(\mathcal{X})$, denoted by

$$\delta F(\mathcal{K}) = F(\mathcal{K}) - F_0(\mathcal{K}).$$

For example, let $\mathcal{K} = [x_0, x_1]$, then we know that $\delta f = f(x) - f_0(x)$ for $f \in C[x_0, x_1]$, $x \in [x_0, x_1]$ and $\delta f(x_0) = \delta f(x_1) = 0$, particularly, $\delta x = 0$. By definition, we furthermore know that

$$\delta \frac{df}{dx} = \frac{df}{dx} - \frac{df_0}{dx} = \frac{d}{dx} \delta f,$$

i.e., $[\delta, \frac{d}{dx}] = 0$. In mechanical fields, the following linear functionals

$$J[y(x)] = \int_{x_0}^{x_1} F(x, y(x), y'(x)) dx \quad (7-21)$$

are fundamental, where $y' = dy/dx$. So we concentrate our attention on such functionals and their variations. Assuming $F \in C[x_0, x_1]$ is 2-differentiable and applying Taylor's formula, then

$$\begin{aligned} \Delta J &= J[y(x) + \delta y] - J[y(x)] \\ &= \int_{x_0}^{x_1} F(x, y(x) + \delta y, y'(x) + \delta y') dx - \int_{x_0}^{x_1} F(x, y(x), y'(x)) dx \\ &= \int_{x_0}^{x_1} (F(x, y(x) + \delta y, y'(x) + \delta y') - F(x, y(x), y'(x))) dx \\ &= \int_{x_0}^{x_1} \left(\frac{\partial F}{\partial y} \delta y + \frac{\partial F}{\partial y'} \delta y' \right) dx + o(D_1[y(x) + \delta y, y(x)]). \end{aligned} \quad (7-22)$$

The first term in (7-22) is called the *first order variation* or just variation of $J[y(x)]$, denoted by

$$\delta J = \int_{x_0}^{x_1} \left(\frac{\partial F}{\partial y} \delta y + \frac{\partial F}{\partial y'} \delta y' \right) dx. \quad (7-23)$$

By calculus, if $F(x, y(x), y'(x))$ is C^∞ -differentiable, then

$$\begin{aligned} \Delta F &= F(x, y(x) + \delta y(x), y'(x) + \delta y'(x)) - F(x, y(x), y'(x)) \\ &= \frac{\partial F}{\partial y} \delta y + \frac{\partial F}{\partial y'} \delta y' + \dots \end{aligned}$$

Whence,

$$\delta F = \frac{\partial F}{\partial y} \delta y + \frac{\partial F}{\partial y'} \delta y'.$$

We can rewrite (7-23) as follows.

$$\delta J = \delta \int_{x_0}^{x_1} F(x, y(x), y'(x)) dx = \int_{x_0}^{x_1} \delta F(x, y(x), y'(x)) dx.$$

Similarly, if the functional

$$J[y_1, y_2, \dots, y_n] = \int_{x_0}^{x_1} F(x, y_1, y_2, \dots, y_n, y'_1, y'_2, \dots, y'_n) dx \quad (7-24)$$

and F, y_i, y'_i for $1 \leq i \leq n$ are differentiable, then

$$\delta J = \int_{x_0}^{x_1} \delta F dx = \int_{x_0}^{x_1} \left(\sum_{i=1}^n \frac{\partial F}{\partial y_i} \delta y_i + \sum_{i=1}^n \frac{\partial F}{\partial y'_i} \delta y'_i \right) dx. \quad (7-25)$$

The following properties of variation are immediately gotten by definition.

- (i) $\delta(F_1 + F_2) = \delta F_1 + \delta F_2;$
- (ii) $\delta(F_1 F_2) = F_1 \delta F_2 + F_2 \delta F_1,$ particularly, $\delta(F^n) = nF^{n-1} \delta F;$
- (iii) $\delta\left(\frac{F_1}{F_2}\right) = \frac{F_2 \delta F_1 - F_1 \delta F_2}{F_2^2};$
- (iv) $\delta F^{(k)} = (\delta F)^{(k)},$ where $f^{(k)} = d^k F / Dx^k;$
- (v) $\delta \int_{x_0}^{x_1} F dx = \int_{x_0}^{x_1} \delta F dx.$

For example, let $F = F(x, y(x), y'(x)).$ Then

$$\begin{aligned} \delta(F_1 F_2) &= \frac{\partial F_1 F_2}{\partial y} \delta y + \frac{\partial F_1 F_2}{\partial y'} \delta y' \\ &= \left(F_1 \frac{\partial F_2}{\partial y} + F_2 \frac{\partial F_1}{\partial y} \right) \delta y + \left(F_1 \frac{\partial F_2}{\partial y'} + F_2 \frac{\partial F_1}{\partial y'} \right) \delta y' \\ &= F_1 \left(\frac{\partial F_2}{\partial y} \delta y + \frac{\partial F_2}{\partial y'} \delta y' \right) + F_2 \left(\frac{\partial F_1}{\partial y} \delta y + \frac{\partial F_1}{\partial y'} \delta y' \right) \\ &= F_1 \delta F_2 + F_2 \delta F_1. \end{aligned}$$

Let $F_0(\mathcal{X}) \in C(\mathcal{X}).$ If for $\forall F(\mathcal{X}) \in C(\mathcal{X}), J[F(\mathcal{X})] - J[F_0(\mathcal{X})] \geq 0$ or $\leq 0,$ then $F_0(\mathcal{X})$ is called the global maximum or minimum value of $J[F(\mathcal{X})]$ in $\mathcal{X}.$ If

$J[F(\mathcal{K})] - J[F_0(\mathcal{K})] \geq 0$ or ≤ 0 hold in a ϵ -neighborhood of $F_0(\mathcal{K})$, then $F_0(\mathcal{K})$ is called the maximal or minimal value of $J[F(\mathcal{K})]$ in \mathcal{K} . For such functional values, we have a simple criterion following.

Theorem 7.1.1 *The functional $J[y(x)]$ in (7-21) has maximal or minimal value at $y(x)$ only if $\delta J = 0$.*

Proof Let ϵ be a small parameter. We define a function

$$\Phi(\epsilon) = J[y(x) + \epsilon\delta y] = \int_{x_0}^{x_1} F(x, y(x) + \epsilon\delta y, y'(x) + \epsilon\delta y') dx.$$

Then $J[y(x)] = \Phi(0)$ and

$$\Phi'(\epsilon) = \int_{x_0}^{x_1} \left(\frac{F(x, y(x) + \epsilon\delta y, y'(x) + \epsilon\delta y')}{\partial y} \delta y + \frac{F(x, y(x) + \epsilon\delta y, y'(x) + \epsilon\delta y')}{\partial y'} \delta y' \right) dx.$$

Whence,

$$\Phi'(0) = \int_{x_0}^{x_1} \left(\frac{\partial F}{\partial y} \delta y + \frac{\partial F}{\partial y'} \delta y' \right) dx = \delta J.$$

For a given $y(x)$ and δy , $\Phi(\epsilon)$ is a function on the variable ϵ . By the assumption, $J[y(x)]$ attains its maximal or minimal value at $y(x)$, i.e., $\epsilon = 0$. By Fermat theorem in calculus, there must be $\Phi'(0) = 0$. Therefore, $\delta J = 0$. \square

7.1.3 Hamiltonian principle. A *mechanical field* is defined to be a particle family Σ constraint on a physical law \mathcal{L} , i.e., each particle in Σ is abided by a mechanical law \mathcal{L} , where Σ maybe discrete or continuous. Usually, \mathcal{L} can be represented by a system of functional equations in a properly chosen reference system. So we can also describe a mechanical field to be all solving particles of a system of functional equations, particularly, partially differential equations. Whence, a geometrical way for representing a mechanical field Σ is by a manifold M consisting of elements following:

(i) A configuration space M of n -differentiable manifold, where n is the freedom of the mechanical field;

(ii) A chosen geometrical structure Ω on the vector field TM and a differentiable energy function $\mathbf{T} : M \times TM \rightarrow \mathbf{R}$, i.e., the Riemannian metric on TM determined by

$$\mathbf{T} = \frac{1}{2} \langle \bar{v}, \bar{v} \rangle, \quad \bar{v} \in TM;$$

(iii) A force field given by a 1-form

$$\omega = \sum_{i=1}^n \omega_i dx_i = \omega_i dx_i.$$

Denoted by $\mathbf{T}(M, \omega)$ a mechanical field. For determining states of mechanical fields, there is a universal principle in physics, i.e., the *Hamiltonian principle* presented in the following.

Hamiltonian Principle *Let $\mathbf{T}(M, \omega)$ be a mechanical field. Then there exists a variational $\mathbf{S} : \mathbf{T}(M, \omega) \rightarrow \mathbf{R}$ action on $\mathbf{T}(M, \omega)$ whose true colors appears at the minimum value of $\mathbf{S}[(\mathbf{T}(M, \omega))]$, i.e., $\delta \mathbf{S} = 0$ by Theorem 7.1.1.*

In philosophy, the Hamiltonian principle reflects a harmonizing ruler for all things developing in the universe, i.e., a minimum consuming for the developing of universe. In fact, all mechanical systems known by human beings are abided this principle. Applying this principle, we can establish classical mechanical fields, such as those of Lagrange's, Hamiltonian, the gravitational fields, . . . , etc. in this chapter.

7.1.4 Lagrange Field. Let $\mathbf{q}(t) = (q_1(t), q_2(t), \dots, q_n(t))$ be a generalized coordinate system for a mechanical field $\mathbf{T}(M, \omega)$. A *Lagrange field* is a mechanical field with a differentiable Lagrangian $L : TM \rightarrow \mathbf{R}$, $\mathcal{L} = \mathcal{L}(t, \mathbf{q}(t), \dot{\mathbf{q}}(t))$, i.e., $\mathbf{T} = \mathcal{L}$. Notice the least action is independent on evolving time of a mechanical field. In a Lagrange field, the variational action is usually determined by

$$S = \int_{t_1}^{t_2} \mathcal{L}(t, \mathbf{q}(t), \dot{\mathbf{q}}(t)) dt. \tag{7-26}$$

In fact, this variational action is as the same as (7-24).

Theorem 7.1.2 *Let $\mathbf{T}(M, \omega)$ be a Lagrange field with a Lagrangian $\mathcal{L}(t, \mathbf{q}(t), \dot{\mathbf{q}}(t))$. Then*

$$\frac{\partial \mathcal{L}}{\partial q_i} - \frac{d}{dt} \frac{\partial \mathcal{L}}{\partial \dot{q}_i} = 0$$

for $i = 1, 2, \dots, n$.

Proof By (7-25), we know that

$$\delta S = \int_{t_1}^{t_2} \left(\sum_{i=1}^n \frac{\partial \mathcal{L}}{\partial q_i} \delta q_i + \sum_{i=1}^n \frac{\partial \mathcal{L}}{\partial \dot{q}_i} \delta \dot{q}_i \right) dt. \quad (7-27)$$

Notice that $\delta \dot{q}_i = \frac{d}{dt} \delta q_i$ and

$$\int_{t_1}^{t_2} \frac{\partial \mathcal{L}}{\partial \dot{q}_i} \delta \dot{q}_i dt = \frac{\partial \mathcal{L}}{\partial \dot{q}_i} \delta q_i \Big|_{t_1}^{t_2} - \int_{t_1}^{t_2} \frac{d}{dt} \frac{\partial \mathcal{L}}{\partial \dot{q}_i} \delta q_i dt$$

Because of $\delta q(t_1) = \delta q(t_2) = 0$, we get that

$$\int_{t_1}^{t_2} \frac{\partial \mathcal{L}}{\partial \dot{q}_i} \delta \dot{q}_i dt = - \int_{t_1}^{t_2} \frac{d}{dt} \frac{\partial \mathcal{L}}{\partial \dot{q}_i} \delta q_i dt \quad (7-28)$$

for $i = 1, 2, \dots, n$. Substituting (7-28) into (7-27), we find that

$$\delta S = \int_{t_1}^{t_2} \sum_{i=1}^n \left(\frac{\partial \mathcal{L}}{\partial q_i} - \frac{d}{dt} \frac{\partial \mathcal{L}}{\partial \dot{q}_i} \right) \delta q_i dt. \quad (7-29)$$

Applying the Hamiltonian principle, there must be $\delta S = 0$ for arbitrary δq_i , $i = 1, 2, \dots, n$. But this can only happens if each coefficient of δq_i is 0 in (7-29), that is,

$$\frac{\partial \mathcal{L}}{\partial q_i} - \frac{d}{dt} \frac{\partial \mathcal{L}}{\partial \dot{q}_i} = 0, \quad i = 1, 2, \dots, n.$$

□

These Lagrange equations can be used to determine the motion equations of mechanical fields, particularly, a particle system in practice. In such cases, a Lagrangian is determined by $\mathcal{L} = T - U$, where T and U are respective the moving energy and potential energy.

Example 7.1.1 A simple pendulum with arm length l (neglect its mass) and a mass m of vibrating ram. Such as those shown in Fig.7.1.2, where θ is the angle between its plumb and arm. Then we know that

$$T = \frac{1}{2} m (l\dot{\theta})^2, \quad U = -mgl \cos \theta$$

and

$$\mathcal{L} = T - U = \frac{1}{2}m(l\dot{\theta})^2 + mgl \cos \theta.$$

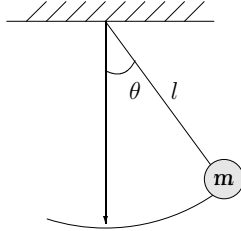

Fig.7.1.2

Applying Theorem 7.1.2, we know that

$$\frac{\partial}{\partial \theta} [\frac{1}{2}m(l\dot{\theta})^2 + mgl \cos \theta] - \frac{d}{dt} \frac{\partial}{\partial \dot{\theta}} [\frac{1}{2}m(l\dot{\theta})^2 + mgl \cos \theta] = 0.$$

That is,

$$\ddot{\theta} + \frac{g}{l} \sin \theta = 0.$$

7.1.5 Hamiltonian Field. A *Hamiltonian field* is a mechanical field with a differentiable Hamiltonian $H : TM \rightarrow \mathbf{R}$ determined by

$$H(t, \dot{\mathbf{q}}(t), \mathbf{p}(t)) = \sum_{i=1}^n p_i \dot{q}_i - \mathcal{L}(t, \mathbf{q}(t), \dot{\mathbf{q}}(t)), \tag{7-30}$$

where $p_i = \partial \mathcal{L} / \partial \dot{q}_i$ is the generalized momentum of field. A Hamiltonian is usually denoted by $H(t, \mathbf{q}(t), \mathbf{p}(t))$. In a Hamiltonian field, the variational action is

$$S = \int_{t_1}^{t_2} (\sum_{i=1}^n p_i \dot{q}_i - \mathcal{L}(t, \mathbf{q}(t), \dot{\mathbf{q}}(t))) dt. \tag{7-31}$$

Applying the Hamiltonian principle, we can find equations of a Hamiltonian field following.

Theorem 7.1.3 Let $\mathbf{T}(M, \omega)$ be a Hamiltonian field with a Hamiltonian $H(t, \mathbf{q}(t), \mathbf{p}(t))$. Then

$$\frac{dq_i}{dt} = \frac{\partial H}{\partial p_i}, \quad \frac{dp_i}{dt} = -\frac{\partial H}{\partial q_i}$$

for $i = 1, 2, \dots, n$.

Proof Consider the variation of S in (7-31). Notice that $\dot{q}_i dt = dq_i$ and $\dot{p}_i dt = dp_i$. Applying (7-25), we know that

$$\delta S = \sum_{i=1}^n \int_{t_1}^{t_2} [\delta p_i dq_i + p_i d\delta q_i - \frac{\partial H}{\partial q_i} \delta q_i dt - \frac{\partial H}{\partial p_i} \delta p_i dt]. \quad (7-32)$$

Since

$$\int_{t_1}^{t_2} p_i d\delta q_i = p_i \delta q_i|_{t_1}^{t_2} - \int_{t_1}^{t_2} \delta q_i dp_i$$

by integration of parts and $\delta q_i(t_1) = \delta q_i(t_2) = 0$, we find that

$$\int_{t_1}^{t_2} p_i d\delta q_i = - \int_{t_1}^{t_2} \delta q_i dp_i. \quad (7-33)$$

Substituting (7-33) into (7-32), we finally get that

$$\delta S = \sum_{i=1}^n \int_{t_1}^{t_2} [(dq_i - \frac{\partial H}{\partial p_i} dt) \delta p_i - (dp_i + \frac{\partial H}{\partial q_i} dt) \delta q_i]. \quad (7-34)$$

According to the Hamiltonian principle, there must be $\delta S = 0$ for arbitrary $\delta q_i, \delta p_i, i = 1, 2, \dots, n$. This can be only happens when each coefficient of $\delta q_i, \delta p_i$ is 0 for $i = 1, 2, \dots, n$, i.e.,

$$\frac{dq_i}{dt} = \frac{\partial H}{\partial p_i}$$

$$\frac{dp_i}{dt} = -\frac{\partial H}{\partial q_i}.$$

This completes the proof. \square

By definition, the Lagrangian and Hamiltonian are related by $H + \mathcal{L} = \sum_{i=1}^n p_i \dot{q}_i$. We can also directly deduce these Hamiltonian equations as follows.

For a fixed time t , we know that

$$d\mathcal{L} = \sum_{i=1}^n \frac{\partial \mathcal{L}}{\partial q_i} dq_i + \sum_{i=1}^n \frac{\partial \mathcal{L}}{\partial \dot{q}_i} d\dot{q}_i.$$

Notice that

$$\frac{\partial \mathcal{L}}{\partial \dot{q}_i} = p_i \quad \text{and} \quad \frac{\partial \mathcal{L}}{\partial q_i} = f_i = \dot{p}_i$$

by (7 – 20). Therefore,

$$d\mathcal{L} = \sum_{i=1}^n \dot{p}_i dq_i + \sum_{i=1}^n p_i d\dot{q}_i. \tag{7 – 35}$$

Calculation shows that

$$d\left(\sum_{i=1}^n p_i \dot{q}_i\right) = \sum_{i=1}^n \dot{q}_i dp_i + \sum_{i=1}^n p_i d\dot{q}_i. \tag{7 – 36}$$

Subtracting the equation (7 – 35) from (7 – 36), we get that

$$d\left(\sum_{i=1}^n p_i \dot{q}_i - \mathcal{L}\right) = \sum_{i=1}^n \dot{q}_i dp_i - \sum_{i=1}^n \dot{p}_i dq_i,$$

i.e.,

$$dH = \sum_{i=1}^n \dot{q}_i dp_i - \sum_{i=1}^n \dot{p}_i dq_i. \tag{7 – 37}$$

By definition, we also know that

$$dH = \sum_{i=1}^n \frac{\partial H}{\partial q_i} dq_i + \sum_{i=1}^n \frac{\partial H}{\partial p_i} dp_i. \tag{7 – 38}$$

Comparing (7 – 37) with (7 – 38), we then get these Hamiltonian equations

$$\frac{dq_i}{dt} = \frac{\partial H}{\partial p_i}, \quad \frac{dp_i}{dt} = -\frac{\partial H}{\partial q_i}, \quad i = 1, 2, \dots, n.$$

7.1.6 Conservation Law. A functional $F(t, \mathbf{q}(t), \mathbf{p}(t))$ on a mechanical field $\mathbf{T}(M, \omega)$ is *conservative* if it is invariable at all times, i.e., $dF/dt = 0$. Calculation shows that

$$\frac{dF}{dt} = \frac{\partial F}{\partial t} + \sum_{i=1}^n \left(\frac{\partial F}{\partial q_i} \frac{dq_i}{dt} + \frac{\partial F}{\partial p_i} \frac{dp_i}{dt} \right). \quad (7-39)$$

Substitute Hamiltonian equations into (7-39). We find that

$$\frac{dF}{dt} = \frac{\partial F}{\partial t} + \sum_{i=1}^n \left(\frac{\partial F}{\partial q_i} \frac{\partial H}{\partial p_i} - \frac{\partial F}{\partial p_i} \frac{\partial H}{\partial q_i} \right). \quad (7-40)$$

Define the *Poisson bracket* $\{H, F\}$ of H, F to be

$$\{H, F\}_{PB} = \sum_{i=1}^n \left(\frac{\partial F}{\partial q_i} \frac{\partial H}{\partial p_i} - \frac{\partial F}{\partial p_i} \frac{\partial H}{\partial q_i} \right). \quad (7-41)$$

Then we have

$$\frac{dF}{dt} = \frac{\partial F}{\partial t} + \{H, F\}_{PB}. \quad (7-42)$$

Theorem 7.1.4 Let $\mathbf{T}(M, \omega)$ be a Hamiltonian mechanical field. Then

$$\frac{dq_i}{dt} = \{H, q_i\}_{PB}, \quad \frac{dp_i}{dt} = \{H, p_i\}_{PB}$$

for $i = 1, 2, \dots, n$.

Proof Let $F = q_i$ in (7-41). Then we have that

$$\{H, q_i\}_{PB} = \sum_{k=1}^n \left(\frac{\partial q_i}{\partial q_k} \frac{\partial H}{\partial p_k} - \frac{\partial q_i}{\partial p_k} \frac{\partial H}{\partial q_k} \right).$$

Notice that q_i and p_i , $i = 1, 2, \dots, n$ are independent. There are must be

$$\frac{\partial q_i}{\partial p_k} = 0, \quad \frac{\partial q_i}{\partial q_k} = \delta_{ik}$$

for $k = 1, 2, \dots, n$. Whence, $\{H, q_i\}_{PB} = \partial H / \partial p_i$. Similarly, $\{H, p_i\}_{PB} = \partial H / \partial q_i$.

According to Theorem 7.1.3, we finally get that

$$\frac{dq_i}{dt} = \{H, q_i\}_{PB}, \quad \frac{dp_i}{dt} = \{H, p_i\}_{PB}$$

for $i = 1, 2, \dots, n$. □

If F is not self-evidently dependent on t , i.e., $F = F(\mathbf{q}(t), \mathbf{p}(t))$, the formula (7-42) comes to be

$$\frac{dF}{dt} = \{H, F\}_{PB}. \tag{7-43}$$

Therefore, F is conservative if and only if $\{H, F\}_{PB} = 0$ in this case. Furthermore, if H is not self-evidently dependent on t , because of $p_i = \partial L / \partial \dot{q}_i$ and $\dot{p}_i = \partial \mathcal{L} / \partial q_i$, we find that

$$\begin{aligned} \frac{dH}{dt} &= \frac{d}{dt} \left[\sum_{i=1}^n p_i \dot{q}_i - \mathcal{L}(\mathbf{q}(t), \dot{\mathbf{q}}(t)) \right] \\ &= \sum_{i=1}^n (\dot{p}_i \dot{q}_i + p_i \ddot{q}_i) - \sum_{i=1}^n \left(\frac{\partial \mathcal{L}}{\partial q_i} \dot{q}_i + \frac{\partial \mathcal{L}}{\partial \dot{q}_i} \ddot{q}_i \right) \\ &= \sum_{i=1}^n (\dot{p}_i \dot{q}_i + p_i \ddot{q}_i) - \sum_{i=1}^n (\dot{p}_i \dot{q}_i + p_i \ddot{q}_i) \\ &= 0, \end{aligned}$$

i.e., H is conservative. Usually, H is called the *mechanical energy* of such fields $\mathbf{T}(M, \omega)$, denoted by E . Whence, we have

Theorem 7.1.5 *If the Hamiltonian H of a mechanical field $\mathbf{T}(M, \omega)$ is not self-evidently dependent on t , then $\mathbf{T}(M, \omega)$ is conservative of mechanical energy.*

7.1.7 Euler-Lagrange Equation. All of the above are finite freedom systems with Lagrangian. For infinite freedom systems such as those of gauge fields in Section 7.4 characterized by a field variable $\phi(\vec{x})$ with infinite freedoms, we need to generalize Lagrange equations in Section 7.1.4 with Lagrange density. In this case, the Lagrangian is chosen to be an integration over the space as follows:

$$\mathcal{L} = \int d^3x \mathcal{L}(\phi, \partial_\mu \phi), \tag{7-44}$$

where $\mathcal{L}(\phi, \partial_\mu\phi)$ is called the *Lagrange density* of field. Applying the Lagrange density, the Lagrange equations are generalized to the *Euler-Lagrange equations* following.

Theorem 7.1.6 *Let $\phi(t, \bar{x})$ be a field with a Lagrangian \mathcal{L} defined by (7–44). Then*

$$\partial_\mu \frac{\partial \mathcal{L}}{\partial \partial_\mu \phi} - \frac{\partial \mathcal{L}}{\partial \phi} = 0.$$

Proof Now the action I is an integration of \mathcal{L} over time x^0 , i.e.,

$$I = \frac{1}{c} \int d^4x \mathcal{L}(\phi, \partial_\mu\phi).$$

Whence, we know that

$$\begin{aligned} \delta I &= \int d^4x \left(\frac{\partial \mathcal{L}}{\partial \phi} \delta\phi + \frac{\partial \mathcal{L}}{\partial(\partial_\mu\phi)} \delta(\partial_\mu\phi) \right) \\ &= \int d^4x \left[\left(\frac{\partial \mathcal{L}}{\partial \phi} - \partial_\mu \frac{\partial \mathcal{L}}{\partial \partial_\mu \phi} \right) \delta\phi + \partial_\mu \left(\frac{\partial \mathcal{L}}{\partial(\partial_\mu\phi)} \delta\phi \right) \right] = 0 \end{aligned}$$

by the Hamiltonian principle. The last term can be turned into a surface integral over the boundary of region of this integration in which $\delta\phi = 0$. Whence, the surface integral vanishes. We get that

$$\delta I = \int d^4x \left(\frac{\partial \mathcal{L}}{\partial \phi} - \partial_\mu \frac{\partial \mathcal{L}}{\partial \partial_\mu \phi} \right) \delta\phi = 0$$

for arbitrary $\delta\phi$. Therefore, we must have

$$\partial_\mu \frac{\partial \mathcal{L}}{\partial \partial_\mu \phi} - \frac{\partial \mathcal{L}}{\partial \phi} = 0.$$

□

§7.2 GRAVITATIONAL FIELD

7.2.1 Newtonian Gravitational Field. Newton's gravitational theory is a \mathbf{R}^3 field theory, independent on the time $t \in \mathbf{R}$, or an absolute time t . In Newton's mechanics, he assumed that the action between particles is *action at a distance*,

which means the interaction take place instantly. Certainly, this assumption is contradicted to the notion of modern physics, in which one assumes the interactions are carrying through intermediate particles. Even so, we would like to begin the discussion at it since it is the fundamental of modern gravitational theory.

The *universal gravitational law* of Newton determines the gravitation F between masses M and m of distance r to be

$$F = -\frac{GMm}{r^2}$$

with $G = 6.673 \times 10^{-8} \text{ cm}^3/\text{gs}^2$, which is the fundamental of Newtonian gravitational field. Let $\rho(\bar{x})$ be the *mass density* of the Newtonian gravitational field at a point $\bar{x} = (x, y, z) \in \mathbf{R}^3$. Then its *potential energy* $\Phi(\bar{x})$ at \bar{x} is defined to be

$$\Phi(\bar{x}) = - \int \frac{G\rho(\bar{x}')}{\|\bar{x} - \bar{x}'\|} d^3\bar{x}'.$$

Then

$$\frac{\partial\Phi(\bar{x})}{\partial x} = - \int \frac{\partial[\frac{G\rho(\bar{x}')}{\|\bar{x} - \bar{x}'\|}]}{\partial x} d^3\bar{x}' = - \int \frac{G\rho(\bar{x}')(x - x')}{\|\bar{x} - \bar{x}'\|^3} d^3\bar{x}' = -\mathbf{F}_x.$$

Similarly,

$$\frac{\partial\Phi(\bar{x})}{\partial y} = - \int \frac{G\rho(\bar{x}')(y - y')}{\|\bar{x} - \bar{x}'\|^3} d^3\bar{x}' = -\mathbf{F}_y,$$

$$\frac{\partial\Phi(\bar{x})}{\partial z} = - \int \frac{G\rho(\bar{x}')(z - z')}{\|\bar{x} - \bar{x}'\|^3} d^3\bar{x}' = -\mathbf{F}_z.$$

Whence, the force acting on a particle with mass m is

$$\mathbf{F} = -m\left(\frac{\partial\Phi(\bar{x})}{\partial x_1}, \frac{\partial\Phi(\bar{x})}{\partial x_2}, \frac{\partial\Phi(\bar{x})}{\partial x_3}\right).$$

These gravitational forces are very weak compared with other forces. For example, the ratio of the gravitational force to the electric force between two electrons are $F_{\text{gravitation}}/F_{\text{electricity}} = 0.24 \times 10^{-42}$. Calculation also shows that $\Phi(\bar{x})$ satisfies the *Poisson equation* following:

$$\frac{\partial^2\Phi(\bar{x})}{\partial x^2} + \frac{\partial^2\Phi(\bar{x})}{\partial y^2} + \frac{\partial^2\Phi(\bar{x})}{\partial z^2} = 4\pi G\rho(\bar{x}),$$

i.e., the potential energy $\Phi(\bar{x})$ is a solution of the Poisson equation at \bar{x} .

7.2.2 Einstein's Spacetime. A *Minkowskian spacetime* is a flat-space with the square of line element

$$d^2s = \eta_{\mu\nu} dx^\mu dx^\nu = -c^2 dt^2 + dx^2 + dy^2 + dz^2$$

where c is the speed of light and $\eta_{\mu\nu}$ is the Minkowskian metrics following,

$$\eta_{\mu\nu} = \begin{bmatrix} -1 & 0 & 0 & 0 \\ 0 & 1 & 0 & 0 \\ 0 & 0 & 1 & 0 \\ 0 & 0 & 0 & 1 \end{bmatrix}.$$

For a particle moving in a gravitational field, there are two kinds of forces acting on it. One is the *inertial force*. Another is the *gravitational force*. Besides, any reference frame for the gravitational field is selected by the observer, as we have shown in Section 7.1. *Wether there are relation among them?* The answer is YES by principles of equivalence and covariance following presented by Einstein in 1915 after a ten years speculation.

[Principle of Equivalence] *These gravitational forces and inertial forces acting on a particle in a gravitational field are equivalent and indistinguishable from each other.*

[Principle of Covariance] *A equation describing the law of physics should have the same form in all reference frame.*

The *Einstein's spacetime* is in fact a curved \mathbf{R}^4 spacetime (x_0, x_1, x_2, x_3) , i.e., a Riemannian space with the square of line element

$$ds^2 = g_{\mu\nu}(\bar{x}) dx_\mu dx_\nu$$

for $\mu, \nu = 0, 1, 2, 3$, where $g_{\mu\nu}(\bar{x})$ are ten functions of the space and time coordinates, called *Riemannian metrics*. According to the principle of equivalence, one can introduce inertial coordinate system in Einstein's spacetime which enables it flat locally, i.e., transfer these Riemannian metrics to Minkowskian ones and eliminate the gravitational forces locally. That is, one entry is positive and other three are negative in the diagonal of the matrix $[g_{\mu\nu}]$. Whence,

$$|g_{\mu\nu}| = \begin{vmatrix} g_{00} & g_{01} & g_{02} & g_{03} \\ g_{10} & g_{11} & g_{12} & g_{13} \\ g_{20} & g_{21} & g_{22} & g_{23} \\ g_{30} & g_{31} & g_{32} & g_{33} \end{vmatrix} < 0.$$

For a given spacetime, let (x^0, x^1, x^2, x^3) be its coordinate system and

$$x'^{\mu} = f^{\mu}(x^0, x^1, x^2, x^3)$$

another coordinate transformation, where $\mu = 0, 1, 2$ and 3 . If the *Jacobian*

$$g = \left| \frac{\partial x'}{\partial x} \right| = \begin{vmatrix} \frac{\partial f^0}{\partial x^0} & \cdots & \frac{\partial f^3}{\partial x^0} \\ \cdots & \cdots & \cdots \\ \frac{\partial f^0}{\partial x^3} & \cdots & \frac{\partial f^3}{\partial x^3} \end{vmatrix} \neq 0,$$

then we can invert the coordinate transformation by

$$x^{\mu} = g^{\mu}(x'^0, x'^1, x'^2, x'^3),$$

and the differential of the two coordinate system are related by

$$dx'^{\mu} = \frac{\partial x'^{\mu}}{\partial x^{\nu}} dx^{\nu} = \frac{\partial f^{\mu}}{\partial x^{\nu}} dx^{\nu},$$

$$dx^{\mu} = \frac{\partial x^{\mu}}{\partial x'^{\nu}} dx'^{\nu} = \frac{\partial g^{\mu}}{\partial x'^{\nu}} dx'^{\nu}.$$

The principle of covariance means that $g_{\mu\nu}$ are tensors, which means we should apply the materials in Chapters 5 – 6 to characterize laws of physics. For example, the transformation ruler for an ordinary covariant tensor $T_{\alpha\beta}$ of order 2 can be seen as a matrix equation

$$T'_{\alpha\beta} = \frac{\partial x^{\mu}}{\partial x'^{\alpha}} T_{\mu\nu} \frac{\partial x^{\nu}}{\partial x'^{\beta}}.$$

Applying the rule for the determinants of a product of matrices, we know that

$$|T'_{\alpha\beta}| = \left| \frac{\partial x}{\partial x'} \right|^2 |T_{\alpha\beta}|,$$

particularly, let $T_{\alpha\beta}$ be the metric tensor $g_{\mu\nu}$, we get that

$$g' = \left| \frac{\partial x}{\partial x'} \right|^2 g. \quad (7-45)$$

Besides, by calculus we have

$$d^4x' = \left| \frac{\partial x}{\partial x'} \right|^2 d^4x. \quad (7-46)$$

Combining the equation (7-45) with (7-46), we get a relation following for volume elements:

$$\sqrt{-g'}d^4x' = \sqrt{-g}d^4x, \quad (7-47)$$

which means that the expression $\sqrt{-g}d^4x$ is an invariant volume element.

7.2.3 Einstein Gravitational Field. By the discussion of Section 7.2.2, these gravitational field equations should be constrained on principles of equivalence and covariance, which will go over into the Poisson equation

$$\nabla^2\Phi(\bar{x}) = 4\pi G\rho(\bar{x}),$$

i.e., Newtonian field equation in a certain limit, where

$$\nabla^2 = \frac{\partial^2}{\partial x^2} + \frac{\partial^2}{\partial y^2} + \frac{\partial^2}{\partial z^2}.$$

In fact, Einstein gave his gravitation field equations as follows:

$$R_{\mu\nu} - \frac{1}{2}g_{\mu\nu}R = \kappa T_{\mu\nu}, \quad (7-48)$$

where $R_{\mu\nu} = R_{\mu\alpha\nu}^{\alpha} = g^{\alpha\beta}R_{\alpha\mu\beta\nu}$, $R = g^{\mu\nu}R_{\mu\nu}$ are the respective *Ricci tensor*, *Ricci scalar curvature* and

$$\kappa = \frac{8\pi G}{c^4} = 2.08 \times 10^{-48} \text{cm}^{-1} \cdot \text{g}^{-1} \cdot \text{s}^2.$$

The Einstein gravitational equations (7–48) can be also deduced by the Hamiltonian principle. Choose the variational action of gravitational field to be

$$I = \int \sqrt{-g}(L_G - 2\kappa L_F)d^4x, \tag{7-49}$$

where $L_G = R$ is the Lagrangian for the gravitational field and $L_F = L_F(g^{\mu\nu}, g^{\mu\nu}_{,\alpha})$ the Lagrangian for all other fields with $f_{,\alpha} = \partial/\partial x^\alpha$ for a function f . Define the energy-momentum tensor $T_{\mu\nu}$ to be

$$T_{\mu\nu} = \frac{2}{\sqrt{-g}} \left\{ \frac{\partial \sqrt{-g} L_F}{\partial g^{\mu\nu}} - \frac{\partial}{\partial x^\alpha} \left[\frac{\partial \sqrt{-g} L_F}{\partial g^{\mu\nu}_{,\alpha}} \right] \right\}.$$

Then we have

Theorem 7.2.1 $\delta I = 0$ is equivalent to equations (7–48).

Proof We prove that

$$\delta I = \int \sqrt{-g}(R_{\mu\nu} - \frac{1}{2}g_{\mu\nu}R - \kappa T_{\mu\nu})\delta g^{\mu\nu}d^4x. \tag{7-50}$$

Varying the first part of the integral (7–49), we find that

$$\begin{aligned} \delta \int \sqrt{-g}Rd^4x &= \delta \int \sqrt{-g}g^{\mu\nu}R_{\mu\nu}d^4x \\ &= \int \sqrt{-g}g^{\mu\nu}\delta R_{\mu\nu}d^4x + \int R_{\mu\nu}\delta(\sqrt{-g}g^{\mu\nu})d^4x \end{aligned} \tag{7-51}$$

Notice that

$$\begin{aligned} \delta R_{\mu\nu} &= \delta \left\{ \frac{\partial \Gamma_{\mu\nu}^\rho}{\partial x^\rho} - \frac{\partial \Gamma_{\mu\rho}^\rho}{\partial x^\nu} + \Gamma_{\mu\nu}^\sigma \Gamma_{\rho\sigma}^\rho - \Gamma_{\mu\rho}^\sigma \Gamma_{\nu\sigma}^\rho \right\} \\ &= \delta \left(\frac{\partial \Gamma_{\mu\nu}^\rho}{\partial x^\rho} \right) - \delta \left(\frac{\partial \Gamma_{\mu\rho}^\rho}{\partial x^\nu} \right) + \delta(\Gamma_{\mu\nu}^\sigma \Gamma_{\rho\sigma}^\rho) - \delta(\Gamma_{\mu\rho}^\sigma \Gamma_{\nu\sigma}^\rho) \\ &= \frac{\partial(\delta \Gamma_{\mu\nu}^\rho)}{\partial x^\rho} - \frac{\partial(\delta \Gamma_{\mu\rho}^\rho)}{\partial x^\nu}. \end{aligned}$$

Consequently, the integrand of the first integral on the right-hand side of (7–51) can be written to

$$\begin{aligned}
\sqrt{-g}g^{\mu\nu}R_{\mu\nu} &= \sqrt{-g}g^{\mu\nu}\left\{\frac{\partial(\delta\Gamma_{\mu\nu}^{\rho})}{\partial x^{\rho}}-\frac{\partial(\delta\Gamma_{\mu\rho}^{\nu})}{\partial x^{\nu}}\right\} \\
&= \sqrt{-g}\left\{\frac{\partial(g^{\mu\nu}\delta\Gamma_{\mu\nu}^{\rho})}{\partial x^{\rho}}-\frac{\partial(g^{\mu\nu}\delta\Gamma_{\mu\rho}^{\nu})}{\partial x^{\nu}}\right\} \\
&= \sqrt{-g}\left\{\frac{\partial(g^{\mu\nu}\delta\Gamma_{\mu\nu}^{\alpha})}{\partial x^{\alpha}}-\frac{\partial(g^{\mu\alpha}\delta\Gamma_{\mu\rho}^{\rho})}{\partial x^{\alpha}}\right\} \\
&= \sqrt{-g}\nabla_{\alpha}V^{\alpha},
\end{aligned}$$

where $V^{\alpha} = g^{\mu\alpha}\delta\Gamma_{\mu\rho}^{\rho} - g^{\mu\alpha}\delta\Gamma_{\mu\rho}^{\rho}$ is a contravariant vector and

$$\nabla_{\alpha}V^{\alpha} = \frac{\partial V^{\alpha}}{\partial x^{\alpha}} + \Gamma_{\mu\alpha}^{\alpha}V^{\mu},$$

where

$$\Gamma_{\mu\alpha}^{\alpha} = g^{\alpha\nu}\Gamma_{\nu\mu\alpha} = \frac{1}{2g}\frac{\partial g}{\partial x^{\nu}} = \frac{1}{\sqrt{-g}}\frac{\partial\sqrt{-g}}{\partial x^{\nu}}.$$

Applying the Gauss theorem, we know that

$$\int\sqrt{-g}g^{\mu\nu}\delta R_{\mu\nu}d^4x = \int\frac{\partial(\sqrt{-g}V^{\alpha})}{\partial x^{\alpha}}d^4x = 0$$

for the first integral on the right-hand side of (7-51).

Now the second integral on the right-hand side of (7-51) gives

$$\begin{aligned}
\int R_{\mu\nu}\delta(\sqrt{-g}g^{\mu\nu})d^4x &= \int\sqrt{-g}R_{\mu\nu}\delta(g^{\mu\nu})d^4x + \int R_{\mu\nu}g^{\mu\nu}\delta(\sqrt{-g})d^4x \\
&= \int\sqrt{-g}R_{\mu\nu}\delta(g^{\mu\nu})d^4x + \int R\delta(\sqrt{-g})d^4x. \quad (7-52)
\end{aligned}$$

Notice that

$$\delta\sqrt{-g} = -\frac{1}{2}\frac{1}{\sqrt{-g}}\delta g = -\frac{1}{2}\sqrt{-g}g_{\mu\nu}\delta g^{\mu\nu}.$$

Whence, we get that

$$\int R_{\mu\nu}\delta(\sqrt{-g}g^{\mu\nu})d^4x = \int\sqrt{-g}(R_{\mu\nu} - \frac{1}{2}g_{\mu\nu}R)\delta g^{\mu\nu}d^4x. \quad (7-53)$$

Now summing up results above, we consequently get the following

$$\delta \int \sqrt{-g} R d^4x = \int \sqrt{-g} (R_{\mu\nu} - \frac{1}{2} g_{\mu\nu} R) \delta g^{\mu\nu} d^4x \quad (7-54)$$

for the variation of the gravitational part of the action (7-51). Notice that $L_F = L_F(g^{\mu\nu}, g^{\mu\nu}_{,\alpha})$ by assumption. For its second part, we obtain

$$\delta \int \sqrt{-g} L_F d^4x = \int \left[\frac{\partial(\sqrt{-g} L_F)}{\partial g^{\mu\nu}} \delta g^{\mu\nu} + \frac{\partial(\sqrt{-g} L_F)}{\partial g^{\mu\nu}_{,\alpha}} \delta g^{\mu\nu}_{,\alpha} \right].$$

The second term on the right-hand-side of the above equation can be written as a surface integral which contributes nothing for its vanishing of the variation at the integration boundaries, minus another term following,

$$\begin{aligned} \delta \int \sqrt{-g} L_F d^4x &= \int \left\{ \frac{\partial(\sqrt{-g} L_F)}{\partial g^{\mu\nu}} \delta g^{\mu\nu} - \frac{\partial}{\partial x^\alpha} \left[\frac{\partial(\sqrt{-g} L_F)}{\partial g^{\mu\nu}_{,\alpha}} \right] \right\} \delta g^{\mu\nu} d^4x \\ &= \frac{1}{2} \int \sqrt{-g} T_{\mu\nu} \delta g^{\mu\nu} d^4x. \end{aligned} \quad (7-55)$$

Summing up equations (7-49), (7-51), (7-54) and (7-55), we finally get that

$$\delta I = \int \sqrt{-g} (R_{\mu\nu} - \frac{1}{2} g_{\mu\nu} R - \kappa T_{\mu\nu}) \delta g^{\mu\nu} d^4x,$$

namely, the equation (7-49). Since this equation is assumed to be valid for an arbitrary variation $\delta g^{\mu\nu}$, we therefore conclude that the integrand in (7-49) should be zero, i.e.,

$$R_{\mu\nu} - \frac{1}{2} g_{\mu\nu} R = \kappa T_{\mu\nu}.$$

This completes the proof. □

7.2.4 Limitation of Einstein's Equation. In the limiting case of $cdt \gg dx^k$, $k = 1, 2, 3$, we obtain the Newtonian field equation from Einstein's equation (7-47) by approximation methods as follows.

Notice that

$$T = T_{\mu\nu} g^{\mu\nu} \simeq T_{\mu\nu} \eta^{\mu\nu} \simeq T_{00} \eta^{00} = T_{00}.$$

Whence,

$$\begin{aligned} R_{00} &= \kappa T_{00} + \frac{1}{2}g_{00}R \\ &\simeq \kappa T_{00} + \frac{1}{2}\eta_{00}R = \frac{1}{2}\kappa T_{00} = \frac{1}{2}\kappa c^2 \rho(\bar{x}), \end{aligned}$$

where $\rho(\bar{x})$ is the mass density of the matter distribution.

Now by Theorem 5.3.4, we know that

$$\begin{aligned} \Gamma_{00}^k &= \frac{1}{2}g^{k\lambda} \left(2\frac{\partial g_{\lambda 0}}{\partial x^0} - \frac{\partial g_{00}}{\partial x^\lambda} \right) \\ &\simeq -\frac{1}{2}\eta^{k\lambda} \frac{\partial g_{00}}{\partial x^\lambda} = \frac{1}{2}\delta^{kl} \frac{\partial g_{00}}{\partial x^l} = \frac{1}{2} \frac{\partial g_{00}}{\partial x^k}. \end{aligned}$$

Therefore,

$$\begin{aligned} R_{00} &= \frac{\partial \Gamma_{00}^\rho}{\partial x^\rho} - \frac{\partial \Gamma_{0\rho}^\rho}{\partial x^0} + \Gamma_{00}^\sigma \Gamma_{\rho\sigma}^\rho - \Gamma_{0\rho}^\sigma \Gamma_{0\sigma}^\rho \\ &\simeq \frac{\partial \Gamma_{00}^\rho}{\partial x^\rho} \simeq \frac{\partial \Gamma_{00}^s}{\partial x^s} \simeq \frac{1}{2} \frac{\partial^2 g_{00}}{\partial x^s \partial x^s} = \frac{1}{2} \nabla^2 g_{00} \simeq \frac{1}{c^2} \nabla^2 \Phi(\bar{x}). \end{aligned}$$

Equating the two expressions on R_{00} , we finally get that

$$\nabla^2 \Phi(\bar{x}) = 4\pi G \rho(\bar{x}),$$

where $\kappa = \frac{8\pi G}{c^4}$.

7.2.5 Schwarzschild Metric. A *Schwarzschild metric* is a spherically symmetric Riemannian metric

$$d^2s = g_{\mu\nu} dx^{\mu\nu} \tag{7-56}$$

used to describe the solution of Einstein gravitational field equations in vacuum due to a spherically symmetric distribution of matter. Usually, the coordinates for such space can be chosen to be the spherical coordinates (r, θ, ϕ) , and consequently (t, r, θ, ϕ) the coordinates of a spherically symmetric spacetime. Then a standard such metric can be written as follows:

$$d^2s = B(r)dt^2 - A(r)dr^2 - r^2d\theta^2 - r^2\sin^2\theta d\phi^2, \quad (7-57)$$

i.e., $g_{00} = g_{tt} = B(r)$, $g_{11} = g_{rr} = -A(r)$, $g_{22} = g_{\theta\theta} = -r^2$, $g_{33} = g_{\phi\phi} = -r^2\sin^2\theta$ and all other metric tensors equal to 0. Therefore, $g^{tt} = 1/B(r)$, $g^{rr} = -1/A(r)$, $g^{\theta\theta} = -1/r^2$ and $g^{\phi\phi} = -1/r^2\sin^2\theta$.

For solving Einstein gravitational field equations, we need to calculate all non-zero connections $\Gamma_{\mu\nu}^\rho$. By definition, we know that

$$\Gamma_{\mu\nu}^\rho = \frac{g^{\rho\sigma}}{2} \left(\frac{\partial g_{\sigma\mu}}{\partial x^\nu} + \frac{\partial g_{\sigma\nu}}{\partial x^\mu} - \frac{\partial g_{\mu\nu}}{\partial x^\sigma} \right).$$

Notice that all non-diagonal metric tensors equal to 0. Calculation shows that

$$\Gamma_{\phi\phi}^r = -\frac{g^{rr}}{2} \frac{\partial g_{\phi\phi}}{\partial x^r} = -\frac{1}{2} \left(\frac{-1}{A} \right) \frac{\partial}{\partial} (r^2\sin^2\theta) = -\frac{r}{A} \sin^2\theta.$$

Similarly,

$$\begin{aligned} \Gamma_{rr}^r &= \frac{A'}{2A}, & \Gamma_{tt}^t &= \frac{B'}{2B}, & \Gamma_{rr}^t &= \frac{B'}{2A}, & \Gamma_{r\theta}^\theta &= \Gamma_{r\phi}^\phi = \frac{1}{r}, \\ \Gamma_{\theta\theta}^r &= -\frac{r}{A}, & \Gamma_{\phi\phi}^r &= -\frac{r}{A} \sin^2\theta, & \Gamma_{\theta\phi}^\phi &= \cot\theta, & \Gamma_{\phi\phi}^\theta &= -\sin\theta \cos\theta, \end{aligned} \quad (7-58)$$

where $A' = \frac{dA}{dr}$, $B' = \frac{dB}{dr}$ and all other connections are equal to 0.

Now we calculate non-zero Ricci tensors. By definition,

$$R_{\mu\nu} = \frac{\partial \Gamma_{\mu\nu}^\rho}{\partial x^\rho} - \frac{\partial \Gamma_{\mu\rho}^\sigma}{\partial x^\nu} + \Gamma_{\mu\nu}^\sigma \Gamma_{\rho\sigma}^\rho - \Gamma_{\mu\rho}^\sigma \Gamma_{\nu\sigma}^\rho.$$

Whence,

$$\begin{aligned} R_{00} = R_{tt} &= -\frac{\partial \Gamma_{tt}^r}{\partial x^r} + 2\Gamma_{rt}^t \Gamma_{tt}^r - \Gamma_{tt}^r (\Gamma_{rr}^r + \Gamma_{r\theta}^\theta + \Gamma_{r\phi}^\phi + \Gamma_{rt}^t) \\ &= -\left(\frac{B'}{2A} \right)' + \frac{B'^2}{2AB} - \frac{B'}{2A} \left(\frac{A'}{2A} + \frac{2}{r} + \frac{B'}{2B} \right) \\ &= -\frac{B''}{2A} + \frac{B'}{4A} \left(\frac{A'}{A} + \frac{B'}{B} \right) - \frac{B'}{rA}, \end{aligned}$$

$$\begin{aligned}
R_{11} = R_{rr} &= -\frac{\partial}{\partial x^r}(\Gamma_{rr}^r + \Gamma_{r\theta}^\theta + \Gamma_{r\phi}^\phi + \Gamma_{rt}^t) - \frac{\partial \Gamma_{rr}^r}{\partial x^r} \\
&\quad + (\Gamma_{rr}^r \Gamma_{rr}^r + \Gamma_{r\theta}^\theta \Gamma_{r\theta}^\theta + \Gamma_{r\phi}^\phi \Gamma_{r\phi}^\phi + \Gamma_{rt}^t \Gamma_{rt}^t) \\
&\quad - \Gamma_{rr}^r (\Gamma_{rr}^r + \Gamma_{r\theta}^\theta + \Gamma_{r\phi}^\phi + \Gamma_{rt}^t) \\
&= \left(\frac{2}{r} + \frac{B'}{2B}\right)' + \left(\frac{2}{r^2} + \frac{B'^2}{4B^2}\right) - \frac{A'}{2A} \left(\frac{2}{r} + \frac{B'}{2B}\right) \\
&= \frac{BB'' - B'^2}{2B^2} + \frac{B'^2}{4B^2} - \frac{A'B'}{4AB} - \frac{A'}{rA}.
\end{aligned}$$

Similar calculations show that all Ricci tensors are as follows:

$$\begin{aligned}
R_{tt} &= -\frac{B''}{2A} + \frac{B'}{4A} \left(\frac{A'}{A} + \frac{B'}{B}\right) - \frac{B'}{rA}, \\
R_{rr} &= \frac{B''}{2B} - \frac{B'}{4B} \left(\frac{A'}{A} + \frac{B'}{B}\right) - \frac{A'}{rA}, \\
R_{\theta\theta} &= \frac{r}{2A} \left(-\frac{A'}{A} + \frac{B'}{B}\right) + \frac{1}{A} - 1, \\
R_{\phi\phi} &= \sin^2 \theta R_{\theta\theta} \quad \text{and} \quad R_{\mu\nu} = 0 \quad \text{if} \quad \mu \neq \nu.
\end{aligned} \tag{7-59}$$

Our object is to solve Einstein gravitational field equations in vacuum space, i.e., $R_{\mu\nu} = 0$. Notice that

$$\frac{R_{tt}}{B} + \frac{R_{rr}}{A} = -\frac{1}{rA} \left(\frac{A'}{A} + \frac{B'}{B}\right) = -\frac{BA' + AB'}{rA^2B} = 0,$$

that is, $BA' + AB' = (AB)' = 0$. Whence, $AB = \text{constant}$.

Now at the infinite point ∞ , the line element (7-56) should turn to the Minkowskian metric

$$ds^2 = dt^2 - dx^2 - dy^2 - dz^2 = dt^2 - dr^2 - r^2 d\theta^2 - r^2 \sin^2 \theta d\phi^2.$$

Therefore, $\lim_{r \rightarrow \infty} A(r) = \lim_{r \rightarrow \infty} B(r) = 1$. So

$$A(r) = \frac{1}{B(r)}, \quad A' = -\frac{B'}{B^2}. \tag{7-60}$$

Substitute (7-60) into $R_{\theta\theta} = 0$, we find that

$$R_{\theta\theta} = rB' + B - 1 = \frac{d}{dr}(rB) - 1 = 0.$$

Therefore, $rB(r) = r - r_g$, i.e., $B(r) = 1 - r_g/r$. When $r \rightarrow \infty$, the spacetime should turn to flat. In this case, Einstein gravitational field equations will turn to Newtonian gravitational equation, i.e., $r_g = 2Gm$. Thereafter,

$$B(r) = 1 - \frac{2Gm}{r}. \quad (7-61)$$

Substituting (7-61) into (7-57), we get the Schwarzschild metric as follows:

$$ds^2 = \left(1 - \frac{2mG}{r}\right) dt^2 - \frac{dr^2}{1 - \frac{2mG}{r}} - r^2 d\theta^2 - r^2 \sin^2 \theta d\phi^2,$$

or

$$ds^2 = \left(1 - \frac{r_g}{r}\right) dt^2 - \frac{dr^2}{1 - \frac{r_g}{r}} - r^2 d\theta^2 - r^2 \sin^2 \theta d\phi^2. \quad (7-62)$$

We therefore obtain the covariant metric tensor for the spherically symmetric gravitational field following:

$$g_{\mu\nu} = \begin{bmatrix} 1 - \frac{r_g}{r} & 0 & 0 & 0 \\ 0 & -\left(1 - \frac{r_g}{r}\right)^{-1} & 0 & 0 \\ 0 & 0 & -r^2 & 0 \\ 0 & 0 & 0 & -r^2 \sin^2 \theta \end{bmatrix}. \quad (7-63)$$

By (7-63), we also know that the infinitesimal distance of two points in time or in space is

$$\left(1 - \frac{r_g}{r}\right) dt^2, \quad dl^2 = \frac{dr^2}{1 - \frac{r_g}{r}} + r^2 d\theta^2 + r^2 \sin^2 \theta d\phi^2,$$

respectively.

The above solution is assumed that A and B are independent on time t in the spherically symmetric coordinates. Generally, let $A = A(r, t)$ and $B = B(r, t)$, i.e., the line element is

$$ds^2 = B(r, t)dt^2 - A(r, t)dr^2 - r^2(d\theta^2 + \sin^2 \theta d\phi^2).$$

Then there are 3 non-zero connections $\Gamma_{\mu\nu}^\rho$ more than (7-58) in this case following:

$$\Gamma_{tr}^r = \frac{\dot{A}}{2A}, \quad \Gamma_{tt}^t = \frac{\dot{B}}{2B}, \quad \Gamma_{rr}^r = \frac{\dot{A}}{2B},$$

where $\dot{A} = \frac{\partial A}{\partial t}$ and $\dot{B} = \frac{\partial B}{\partial t}$. These formulae (7-59) are turned to the followings:

$$\begin{aligned} R_{rr} &= \frac{B''}{2B} - \frac{B'^2}{4B^2} - \frac{A'B'}{4AB} - \frac{A'}{Ar} + \frac{\ddot{A}}{2B} - \frac{\dot{A}\dot{B}}{4B^2} - \frac{\dot{A}^2}{4AB}, \\ R_{\theta\theta} &= -1 + \frac{1}{A} - \frac{rA'}{2A^2} + \frac{rB'}{2AB}, \\ R_{\phi\phi} &= R_{\theta\theta} \sin^2 \theta, \\ R_{tt} &= -\frac{B''}{2A} + \frac{A'B'}{4A^2} - \frac{B'}{Ar} + \frac{B'^2}{4AB} + \frac{\ddot{A}}{2A} - \frac{\dot{A}^2}{4A^2} - \frac{\dot{A}\dot{B}}{4AB}, \\ R_{tr} &= -\frac{\dot{A}}{Ar} \end{aligned}$$

and all other Ricci tensors $R_{r\theta} = R_{r\phi} = R_{\theta\phi} = R_{\theta t} = R_{\phi t} = 0$. Now the equation $R_{\mu\nu} = 0$ implies that $\dot{A} = 0$. Whence, A is independent on t . We find that

$$R_{rr} = \frac{B''}{2B} - \frac{B'^2}{4B^2} - \frac{A'B'}{4AB} - \frac{A'}{Ar},$$

and

$$R_{tt} = -\frac{B''}{2A} + \frac{A'B'}{4A^2} - \frac{B'}{Ar} + \frac{B'^2}{4AB}.$$

They are the same as in (7-59). Similarly,

$$\frac{R_{rr}}{A} + \frac{R_{tt}}{B} = -\frac{1}{rA} \left(\frac{A'}{A} + \frac{B'}{B} \right) = 0, \quad \text{and } R_{\theta\theta} = 0.$$

We get that $(AB)' = 0$ and $(r/A)' = 1$. Whence,

$$A(r) = \frac{1}{1 - \frac{r_g}{r}}, \quad B(r, t) = f(t) \left(1 - \frac{r_g}{r} \right),$$

i.e., the line element

$$ds^2 = f(t) \left(1 - \frac{r_g}{r} \right) dt^2 - \frac{1}{1 - \frac{r_g}{r}} dr^2 - r^2 (d\theta^2 + \sin^2 \theta d\phi^2).$$

There is another way for solving Einstein gravitational field equations due to a spherically symmetric distribution of matter, i.e., expresses the coefficients of dt^2 and dr^2 in exponential forms following

$$ds^2 = e^\nu dt^2 - e^\lambda dr^2 - r^2(d\theta^2 + \sin^2 \theta d\phi^2).$$

In this case, the metric tensors are as follows:

$$g_{\mu\nu} = \begin{bmatrix} e^\nu & 0 & 0 & 0 \\ 0 & -e^\lambda & 0 & 0 \\ 0 & 0 & -r^2 & 0 \\ 0 & 0 & 0 & -r^2 \sin^2 \theta \end{bmatrix}.$$

Then the nonzero connections are then given by

$$\begin{aligned} \Gamma_{tt}^t &= \frac{\dot{\nu}}{2}, \quad \Gamma_{tr}^t = \frac{\nu'}{2}, \quad \Gamma_{rr}^t = \frac{\dot{\lambda}}{2} e^{\lambda-\nu}; \\ \Gamma_{tt}^r &= \frac{\nu'}{2} e^{\lambda-\nu}, \quad \Gamma_{tr}^r = \frac{\dot{\lambda}}{2}, \quad \Gamma_{rr}^r = \frac{\lambda'}{2}; \\ \Gamma_{\theta\theta}^r &= -r e^{-\lambda}, \quad \Gamma_{\phi\phi}^r = -r^2 \sin^2 \theta e^{-\lambda}, \quad \Gamma_{r\theta}^\theta = \frac{1}{r}; \\ \Gamma_{\phi\phi}^\theta &= -\sin \theta \cos \theta, \quad \Gamma_{r\phi}^\phi = \frac{1}{r}, \quad \Gamma_{\theta\phi}^\phi = \cot \theta. \end{aligned}$$

Then we can determine all nonzero Ricci tensors $R_{\mu\nu}$ and find the solution (7 – 62) of equations $R_{\mu\nu} = 0$.

7.2.6 Schwarzschild Singularity. In the solution (7 – 62), the number r_g is important to the structure of Schwarzschild spacetime (ct, r, θ, ϕ) . The *Schwarzschild radius* r_s is defined to be

$$r_s = \frac{r_g}{c^2} = \frac{2Gm}{c^2}.$$

At its surface $r = r_s$, these metric tensors g_{rr} diverge and g_{tt} vanishes, which giving the existence of a singularity in Schwarzschild spacetime.

One can show that each line with constants t, θ and ϕ are geodesic lines. These geodesic lines are spacelike if $r > r_s$ and timelike if $r < r_s$. But the tangent vector of a geodesic line undergoes a parallel transport along this line and can not change

from timelike to spacelike. Whence, the two regions $r > r_s$ and $r < r_s$ can not join smoothly at the surface $r = r_s$.

We can also find this fact if we examine the radical null directions along $d\theta = \phi = 0$. In such a case, we have

$$ds^2 = \left(1 - \frac{r_s}{r}\right) dt^2 - \left(1 - \frac{r_s}{r}\right)^{-1} dr^2 = 0.$$

Therefore, the radical null directions must satisfy the following equation

$$\frac{dr}{dt} = \pm \left(1 - \frac{r_s}{r}\right)$$

in units in which the speed of light is unity. Notice that the timelike directions are contained within the light cone, we know that in the region $r > r_s$ the opening of light cone decreases with r and tends to 0 at $r = r_s$, such as those shown in Fig.7.2.1 following.

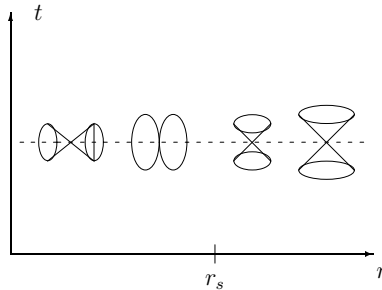

Fig. 7.2.1

In the region $r < r_s$ the parametric lines of the time t become spacelike. Consequently, the light cones rotate 90° , such as those shown in Fig.4.2.1, and their openings increase when moving from $r = 0$ to $r = r_s$. Comparing the light cones on both sides of $r = r_s$, we can easily find that these regions on the two sides of the surface $r = r_s$ do not join smoothly at $r = r_s$.

7.2.7 Kruskal Coordinate. For removing the singularity appeared in Schwarzschild spacetime, Kruskal introduced a new spherically symmetric coordinate system, in which radical light rays have the slope $dr/dt = \pm 1$ everywhere. Then the metric will have a form

$$g_{\mu\nu} = \begin{bmatrix} f^2 & 0 & 0 & 0 \\ 0 & -f^2 & 0 & 0 \\ 0 & 0 & -r^2 & 0 \\ 0 & 0 & 0 & -r^2 \sin^2 \theta \end{bmatrix}. \quad (7-64)$$

Identifying (7-63) with (7-64), and requiring the function f to depend only on r and to remain finite and nonzero for $u = v = 0$, we find a transformation between the exterior of the *spherically singularity* $r > r_s$ and the quadrant $u > |v|$ with new variables following:

$$v = \left(\frac{r}{r_s} - 1\right)^{\frac{1}{2}} \exp\left(\frac{r}{2r_s}\right) \sinh\left(\frac{t}{2r_s}\right),$$

$$u = \left(\frac{r}{r_s} - 1\right)^{\frac{1}{2}} \exp\left(\frac{r}{2r_s}\right) \cosh\left(\frac{t}{2r_s}\right).$$

The inverse transformations are given by

$$\left(\frac{r}{r_s} - 1\right) \exp\left(\frac{r}{r_s}\right) = u^2 - v^2,$$

$$\frac{t}{2r_s} = \operatorname{arctanh}\left(\frac{v}{u}\right)$$

and the function f is defined by

$$f^2 = \frac{32Gm^3}{r} \exp\left(-\frac{r}{r_s}\right)$$

= a transcendental function of $u^2 - v^2$.

This new coordinates present an analytic extension E of the limited region S of the Schwarzschild spacetime without singularity for $r > r_s$. The metric in the extended region joins on smoothly and without singularity to the metric at the boundary of S at $r = r_s$. This fact may be seen by a direction examination of the geodesics, i.e., every geodesic followed in which ever direction, either runs into the *barrier* of intrinsic singularity at $r = 0$, i.e., $v^2 - u^2 = 1$, or is continuable infinitely.

Notice that this transformation also presents a *bridge* between two otherwise Euclidean spaces in topology, which can be interpreted as the *throat of a wormhole* connecting two distant regions in a Euclidean space.

§7.3 ELECTROMAGNETIC FIELD

An *electromagnetic field* is a physical field produced by electrically charged objects. It affects the behavior of charged objects in the vicinity of the field and extends indefinitely throughout space and describes the electromagnetic interaction.

This field can be viewed as a combination of an electric field and a magnetic field. The electric field is produced by stationary charges, and the magnetic field by moving charges, i.e., currents, which are often described as the sources of the electromagnetic field. Usually, the charges and currents interact with the electromagnetic field is described by Maxwell's equations and the Lorentz force law.

7.3.1 Electrostatic Field. An *electrostatic field* is a region of space characterized by the existence of a force generated by electric charge. Denote by \mathbf{F} the force acting on an electrically charged particle with charge q located at \bar{x} , due to the presence of a charge q' located at \bar{x}' . Let $\nabla = (\frac{\partial}{\partial x_1}, \frac{\partial}{\partial x_2}, \frac{\partial}{\partial x_3})$. According to *Coulomb's law* this force in vacuum is given by the expression

$$\mathbf{F}(\bar{x}) = \frac{qq'}{4\pi\epsilon_0} \frac{\bar{x} - \bar{x}'}{|\bar{x} - \bar{x}'|^3} = -\frac{qq'}{4\pi\epsilon_0} \nabla \left(\frac{1}{|\bar{x} - \bar{x}'|} \right), \quad (7 - 65)$$

A *vectorial electrostatic field* \mathbf{E}^{stat} is defined by a limiting process

$$\mathbf{E}^{stat} = \lim_{q \rightarrow 0} \frac{\mathbf{F}}{q},$$

where \mathbf{F} is the force defined in equation (7 - 65), from a net electric charge q' on the test particle with a small electric net electric charge q . Since the purpose of the limiting process is to assure that the test charge q does not distort the field set up by q' , the expression for \mathbf{E}^{stat} does not depend explicitly on q but only on the charge q' and the relative radius vector $\bar{x} - \bar{x}'$. Applying (7 - 65), the electric field \mathbf{E}^{stat} at the observation point \bar{x} due to a field-producing electric charge q' at the source point \bar{x}' is determined by

$$\mathbf{E}^{stat}(\bar{x}) = \frac{q'}{4\pi\epsilon_0} \frac{\bar{x} - \bar{x}'}{|\bar{x} - \bar{x}'|^3} = -\frac{q'}{4\pi\epsilon_0} \nabla \left(\frac{1}{|\bar{x} - \bar{x}'|} \right). \quad (7-66)$$

If there are m discrete electric charges q'_i located at the points \bar{x}'_i for $i = 1, 2, 3, \dots, m$, the assumption of linearity of vacuum allows us to superimpose their individual electric fields into a total electric field

$$\mathbf{E}^{stat}(\bar{x}) = \frac{1}{4\pi\epsilon_0} \sum_{i=1}^m q'_i \frac{\bar{x} - \bar{x}'_i}{|\bar{x} - \bar{x}'_i|^3}. \quad (7-67)$$

Denote the *electric charge density* located at \bar{x} within a volume V by $\rho(\bar{x})$, which is measured in C/m^3 in SI units. Then the summation in (7-67) is replaced by an integration following:

$$\begin{aligned} \mathbf{E}^{stat}(\bar{x}) &= \frac{1}{4\pi\epsilon_0} \int_V d^3(\bar{x}') \rho(\bar{x}') \frac{\bar{x} - \bar{x}'}{|\bar{x} - \bar{x}'|^3} \\ &= -\frac{1}{4\pi\epsilon_0} \int_V d^3(\bar{x}') \rho(\bar{x}') \nabla \left(\frac{1}{|\bar{x} - \bar{x}'|} \right) \\ &= -\frac{1}{4\pi\epsilon_0} \nabla \int_V d^3(\bar{x}') \frac{\rho(\bar{x}')}{|\bar{x} - \bar{x}'|}, \end{aligned} \quad (7-68)$$

where we use the fact that $\rho(\bar{x}')$ does not depend on the unprimed coordinates on which ∇ operates. Notice that under the assumption of linear superposition, the equation (7-68) is valid for an arbitrary distribution of electric charges including discrete charges, in which case ρ can be expressed in the *Dirac delta distributions* following:

$$\rho(\bar{x}) = \sum_i q_i \delta(\bar{x} - \bar{x}'_i).$$

Inserting this expression into (7-68), we have (7-67) again. By (7-68), we know that

$$\begin{aligned} \nabla \cdot \mathbf{E}^{stat}(\bar{x}) &= \nabla \cdot \frac{1}{4\pi\epsilon_0} \int_{V'} d^3(\bar{x}') \rho(\bar{x}') \frac{\bar{x} - \bar{x}'}{|\bar{x} - \bar{x}'|^3} \\ &= -\frac{1}{4\pi\epsilon_0} \int_{V'} d^3(\bar{x}') \rho(\bar{x}') \nabla \cdot \nabla \left(\frac{1}{|\bar{x} - \bar{x}'|} \right) \end{aligned}$$

$$\begin{aligned}
&= -\frac{1}{4\pi\epsilon_0} \int_{V'} d^3(\bar{x}') \rho(\bar{x}') \nabla^2 \left(\frac{1}{|\bar{x} - \bar{x}'|} \right) \\
&= \frac{1}{\epsilon_0} \int_{V'} d^3(\bar{x}') \rho(\bar{x}') \delta(\bar{x} - \bar{x}') = \frac{\rho(\bar{x})}{\epsilon_0}. \quad (7-69)
\end{aligned}$$

Notice that $\nabla \times (\nabla \alpha(\bar{x})) = \bar{0}$ for any scalar field $\alpha(\bar{x})$, $\bar{x} \in \mathbf{R}^3$. We immediately get that

$$\nabla \times \mathbf{E}^{stat}(\bar{x}) = -\frac{1}{4\pi\epsilon_0} \nabla \times \left(\nabla \int_{V'} d^3(\bar{x}') \frac{\rho(\bar{x}')}{|\bar{x} - \bar{x}'|} \right) = \bar{0}, \quad (7-70)$$

which means that \mathbf{E}^{stat} is an irrotational field. Whence, an electrostatic field can be characterized in terms of two equations following:

$$\nabla \cdot \mathbf{E}^{stat}(\bar{x}) = -\frac{\rho(\bar{x})}{\epsilon_0}, \quad (7-71)$$

$$\nabla \times \mathbf{E}^{stat}(\bar{x}) = \bar{0}. \quad (7-72)$$

7.3.2 Magnetostatic Field. A *magnetostatic field* is generated when electric charge carriers such as electrons move through space or within an electrical conductor, and the interaction between these currents. Let \mathbf{F} denote such a force acting on a small loop C , with tangential line element $d\mathbf{l}$ located at \bar{x} and carrying a current I in the direction of $d\mathbf{l}$, due to the presence of a small loop C' with tangential line element $d\mathbf{l}'$ located at \bar{x}' and carrying a current I' in the direction of $d\mathbf{l}'$, such as those shown in Fig.7.3.1.

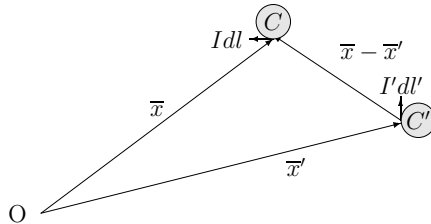

Fig.7.3.1

According to *Ampère's law*, this force in vacuum is given by

$$\begin{aligned} \mathbf{F}(\bar{x}) &= \frac{\mu_0 I I'}{4\pi} \oint_C dl \oint_{C'} dl' \times \frac{\bar{x} - \bar{x}'}{|\bar{x} - \bar{x}'|^3} \\ &= -\frac{\mu_0 I I'}{4\pi} \oint_C dl \times \oint_{C'} dl' \times \nabla \left(\frac{1}{|\bar{x} - \bar{x}'|} \right), \end{aligned}$$

where $\mu_0 = 4\pi \times 10^{-7} \approx 1.2566 \times 10^{-6} H/m$. Since $\mathbf{a} \times (\mathbf{b} \times \mathbf{c}) = \mathbf{b}(\mathbf{a} \cdot \mathbf{c}) - \mathbf{c}(\mathbf{a} \cdot \mathbf{b}) = \mathbf{b}\mathbf{a} \cdot \mathbf{c} - \mathbf{c}\mathbf{a} \cdot \mathbf{b}$, we know that

$$\mathbf{F}(\bar{x}) = -\frac{\mu_0 I I'}{4\pi} \oint_C dl' \oint_{C'} dl \nabla \left(\frac{1}{|\bar{x} - \bar{x}'|} \right) - \frac{\mu_0 I I'}{4\pi} \oint_C \oint_{C'} \left(\frac{\bar{x} - \bar{x}'}{|\bar{x} - \bar{x}'|^3} \right) dl dl'.$$

Notice that the integrand in the first integral is an exact differential and it vanishes. We get that

$$\mathbf{F}(\bar{x}) = -\frac{\mu_0 I I'}{4\pi} \oint_C \oint_{C'} \left(\frac{\bar{x} - \bar{x}'}{|\bar{x} - \bar{x}'|^3} \right) dl dl'. \quad (7-73)$$

A static vectorial magnetic field \mathbf{B}^{stat} is defined by

$$d\mathbf{B}^{stat}(\bar{x}) = \frac{\mu_0 I'}{4\pi} dl' \times \frac{\bar{x} - \bar{x}'}{|\bar{x} - \bar{x}'|^3},$$

which means that $d\mathbf{B}^{stat}$ at \bar{x} is set up by the line element dl' at \bar{x}' , called the *magnetic flux density*. Let $dl' = \mathbf{j}(\bar{x}') d^3x'$. Then

$$\begin{aligned} \mathbf{B}^{stat}(\bar{x}) &= \frac{\mu_0}{4\pi} \int_{V'} d^3x' \mathbf{j}(\bar{x}') \times \frac{\bar{x} - \bar{x}'}{|\bar{x} - \bar{x}'|^3} \\ &= -\frac{\mu_0}{4\pi} \int_{V'} d^3x' \mathbf{j}(\bar{x}') \times \nabla \left(\frac{1}{|\bar{x} - \bar{x}'|} \right) \\ &= \frac{\mu_0}{4\pi} \nabla \times \int_{V'} d^3x' \frac{\mathbf{j}(\bar{x}')}{|\bar{x} - \bar{x}'|}, \end{aligned} \quad (7-74)$$

where we use the fact that $\mathbf{j}(\bar{x}')$ does not depend on the unprimed coordinates on which ∇ operates. By his definition, we also know that

$$\mathbf{F}(\bar{x}) = I \oint_C dl \times \mathbf{B}^{stat}(\bar{x}). \quad (7-75)$$

Since $\nabla \cdot (\nabla \times \mathbf{a}) = \mathbf{0}$ for any \mathbf{a} , we get that

$$\nabla \cdot \mathbf{B}^{stat}(\bar{x}) = \frac{\mu_0}{4\pi} \nabla \cdot \left(\nabla \times \int_{V'} d^3x' \frac{\mathbf{j}(\bar{x}')}{|\bar{x} - \bar{x}'|} \right) = 0. \quad (7-76)$$

Applying $\nabla \times (\nabla \times \mathbf{a}) = \nabla(\nabla \cdot \mathbf{a}) - \nabla^2 \mathbf{a} = \nabla \nabla \cdot \mathbf{a} - \nabla \cdot \nabla \mathbf{a}$, we then know that

$$\begin{aligned} \nabla \times \mathbf{B}^{stat}(\bar{x}) &= \frac{\mu_0}{4\pi} \nabla \times \left(\nabla \times \int_{V'} d^3x' \frac{\mathbf{j}(\bar{x}')}{|\bar{x} - \bar{x}'|} \right) \\ &= -\frac{\mu_0}{4\pi} \int_{V'} d^3x' \mathbf{j}(\bar{x}') \nabla^2 \left(\frac{1}{|\bar{x} - \bar{x}'|} \right) + \frac{\mu_0}{4\pi} \int_{V'} d^3x' [\mathbf{j}(\bar{x}') \cdot \nabla'] \nabla' \left(\frac{1}{|\bar{x} - \bar{x}'|} \right). \end{aligned}$$

Notice that $\nabla \cdot (\alpha \mathbf{a}) = \mathbf{a} \cdot \nabla \alpha + \alpha \nabla \cdot \mathbf{a}$. Integrating the second one by parts, we know that

$$\begin{aligned} &\int_{V'} d^3x' [\mathbf{j}(\bar{x}') \cdot \nabla'] \nabla' \left(\frac{1}{|\bar{x} - \bar{x}'|} \right) \\ &= \hat{\mathbf{x}}_k \int_{V'} d^3x' \nabla' \left\{ \mathbf{j}(\bar{x}') \left[\frac{\partial}{\partial x'_k} \left(\frac{1}{|\bar{x} - \bar{x}'|} \right) \right] \right\} - \int_{V'} d^3x' [\nabla' \cdot \mathbf{j}(\bar{x}')] \nabla' \left(\frac{1}{|\bar{x} - \bar{x}'|} \right) \\ &= \hat{\mathbf{x}}_k \int_{S'} d^3x' \hat{\mathbf{n}} \mathbf{j}(\bar{x}') \frac{\partial}{\partial x'_k} \left(\frac{1}{|\bar{x} - \bar{x}'|} \right) - \int_{V'} d^3x' [\nabla' \cdot \mathbf{j}(\bar{x}')] \nabla' \left(\frac{1}{|\bar{x} - \bar{x}'|} \right), \end{aligned}$$

where $\hat{\mathbf{n}}$ is the normal unit vector of S' directed along the outward pointing,

$$\begin{aligned} \hat{x}_1 &= \sin \theta \cos \phi \hat{r} + \cos \theta \cos \phi \hat{\theta} + \sin \phi \hat{\phi}, \\ \hat{x}_2 &= \sin \theta \sin \phi \hat{r} + \cos \theta \sin \phi \hat{\theta} + \cos \phi \hat{\phi}, \\ \hat{x}_3 &= \cos \theta \hat{r} - \sin \theta \hat{\theta} \end{aligned}$$

and

$$\begin{aligned} \hat{r} &= \sin \theta \cos \phi \hat{x}_1 + \sin \theta \sin \phi \hat{x}_2 + \cos \theta \hat{x}_3, \\ \hat{\theta} &= \cos \theta \cos \phi \hat{x}_1 + \cos \theta \sin \phi \hat{x}_2 - \sin \theta \hat{x}_3, \\ \hat{\phi} &= -\sin \phi \hat{x}_1 + \cos \phi \hat{x}_2. \end{aligned}$$

So $dS = d^2x \hat{\mathbf{n}}$. Applying Gauss's theorem, also note that $\nabla \cdot \mathbf{j} = 0$, we know this integral vanishes. Therefore,

$$\nabla \times \mathbf{B}^{stat}(\bar{x}) = \mu_0 \int_{V'} d^3x' \mathbf{j}(\bar{x}') \delta(\bar{x} - \bar{x}') = \mu_0 \mathbf{j}(\bar{x}). \quad (7-77)$$

Whence, a magnetostatic field can be characterized in terms of two equations following:

$$\nabla \cdot \mathbf{B}^{stat}(\bar{x}) = 0, \tag{7-78}$$

$$\nabla \times \mathbf{B}^{stat}(\bar{x}) = \mu_0 \mathbf{j}(\bar{x}). \tag{7-79}$$

7.3.3 Electromagnetic Field. A electromagnetic field characterized by \mathbf{E} , \mathbf{B} are dependent on both position \bar{x} and time t . In this case, let $\mathbf{j}(t, \bar{x})$ denote the time-dependent electric current density, particularly, it can be defined as $\mathbf{j}(t, \bar{x}) = v\rho(t, \bar{x})$ where v is the velocity of the electric charge density ρ for simplicity. Then the electric charge conservation law can be formulated in the equation of continuity

$$\frac{\partial \rho(t, \bar{x})}{\partial t} + \nabla \cdot \mathbf{j}(t, \bar{x}) = 0,$$

i.e., the time rate of change of electric charge $\rho(t, x)$ is balanced by a divergence in the electric current density $\mathbf{j}(t, \bar{x})$. Set $\nabla \cdot \mathbf{j}(t, \bar{x}) = -\partial \rho(t, \bar{x})/\partial t$. Similar to the derivation of equation (7-77), we get that

$$\begin{aligned} \nabla \times \mathbf{B}(t, \bar{x}) &= \mu_0 \int_{V'} d^3x' \mathbf{j}(t, \bar{x}') \delta(\bar{x} - \bar{x}') + \frac{\mu_0}{4\pi} \frac{\partial}{\partial t} \int_{V'} d^3x' \rho(t, \bar{x}') \nabla' \left(\frac{1}{|\bar{x} - \bar{x}'|} \right) \\ &= \mu_0 \mathbf{j}(t, \bar{x}) + \mu_0 \frac{\partial}{\partial t} \varepsilon_0 \mathbf{E}(t, \bar{x}), \end{aligned}$$

where

$$\mathbf{E}(t, \bar{x}) = -\frac{1}{4\pi\varepsilon_0} \nabla \int_{V'} d^3x' \frac{\rho(t, \bar{x}')}{|\bar{x} - \bar{x}'|}$$

and it is assumed that

$$\frac{1}{4\pi\varepsilon_0} \int_{V'} d^3x' \rho(t, \bar{x}') \nabla \left(\frac{1}{|\bar{x} - \bar{x}'|} \right) = \frac{\partial}{\partial t} \left[-\frac{1}{4\pi\varepsilon_0} \nabla \int_{V'} d^3x' \frac{\rho(t, \bar{x}')}{|\bar{x} - \bar{x}'|} \right] = \frac{\partial}{\partial t} \mathbf{E}(t, \bar{x}).$$

Notice that $\varepsilon_0 \mu_0 = \frac{10^7}{4\pi c^2} \times 4\pi \times 10^{-7} (H/m) = 1/c^2 (s^2/m^2)$. We finally get that

$$\nabla \times \mathbf{B}(t, \bar{x}) = \mu_0 \mathbf{j}(t, \bar{x}) + \frac{1}{c^2} \frac{\partial}{\partial t} \mathbf{E}(t, \bar{x}). \tag{7-80}$$

If the current is caused by an applied electric field $\mathbf{E}(t, \bar{x})$ applied to a conducting medium, this electric field will exert work on the charges in the medium and there

would be some energy loss unless the medium is superconducting. The rate at which this energy is expended is $\mathbf{j} \cdot \mathbf{E}$ per unit volume. If \mathbf{E} is irrotational (conservative), \mathbf{j} will decay away with time. Stationary currents therefore require that an electric field which corresponds to an *electromotive force (EMF)*, denoted by \mathbf{E}^{EMF} . In the presence of such a field \mathbf{E}^{EMF} , the *Ohm's law* takes the form following

$$\mathbf{j}(t, \bar{x}) = \sigma(\mathbf{E}^{stat} + \mathbf{E}^{EMF}),$$

where σ is the *electric conductivity* (S/m). Then the *electromotive force* is defined by

$$\mathcal{E} = \oint_C dl \cdot (\mathbf{E}^{stat} + \mathbf{E}^{EMF}),$$

where dl is a tangential line element of the closed loop C . By (7-70), $\nabla \times \mathbf{E}^{stat}(\bar{x}) = 0$, which means that \mathbf{E}^{stat} is a conservative field. This implies that the closed line integral of \mathbf{E}^{stat} in above vanishes. Whence,

$$\mathcal{E} = \oint_C dl \cdot \mathbf{E}^{EMF}. \quad (7-81)$$

Experimentally, a nonconservative EMF field can be produced in a closed circuit C if the magnetic flux through C varies with time. In Fig.7.3.2, it is shown that a varying magnetic flux induced by a loop C which moves with velocity v in a spatially varying magnetic field $B(\bar{x})$.

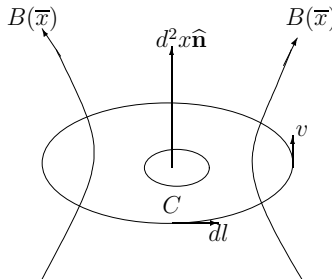

Fig.7.3.2

Whence,

$$\begin{aligned} \mathcal{E}(t) &= \oint_C dl \cdot \mathbf{E}(t, \bar{x}) = -\frac{d}{dt}\Phi_m(t) \\ &= -\frac{d}{dt} \int_S d^2x \hat{\mathbf{n}} \cdot \mathbf{B}(t, \bar{x}) = -\int_S d^2x \hat{\mathbf{n}} \cdot \frac{\partial}{\partial t} \mathbf{B}(t, \bar{x}), \end{aligned} \quad (7-82)$$

where Φ_m is the *magnetic flux* and S the surface encircled by C . Applying *Stokes' theorem*

$$\oint_C \mathbf{a} \cdot dl = \int_S dS \cdot (\nabla \times \mathbf{a})$$

in \mathbf{R}^3 to (7-82), we find the differential equation following

$$\nabla \times \mathbf{E}(t, \bar{x}) = -\frac{\partial}{\partial t} \mathbf{B}(t, \bar{x}). \quad (7-83)$$

Similarly, we can also get the following likewise that of equation (7-76).

$$\nabla \cdot \mathbf{B}(t, \bar{x}) = 0 \quad \text{and} \quad \nabla \cdot \mathbf{E}(t, \bar{x}) = \frac{1}{\epsilon_0} \rho(\bar{x}) \quad (7-84)$$

7.3.4 Maxwell Equation. All of (7-80), (7-83) and (7-84) consist of *Maxwell equations*, i.e.,

$$\begin{aligned} \nabla \cdot \mathbf{E}(t, \bar{x}) &= \frac{1}{\epsilon_0} \rho(\bar{x}), \\ \nabla \times \mathbf{E}(t, \bar{x}) &= -\frac{\partial}{\partial t} \mathbf{B}(t, \bar{x}), \\ \nabla \cdot \mathbf{B}(t, \bar{x}) &= 0, \\ \nabla \times \mathbf{B}(t, \bar{x}) &= \mu_0 \mathbf{j}(t, \bar{x}') + \frac{1}{c^2} \frac{\partial}{\partial t} \mathbf{E}(t, \bar{x}) \end{aligned}$$

on electromagnetic field, where $\rho(t, \bar{x})$, $\mathbf{j}(t, \bar{x})$ are respective the electric charge and electric current.

According to Einstein's general relativity, we need to express the electromagnetic fields in a tensor form where the components are functions of the covariant form of the four-potential $A^\mu = (\phi/c, \mathbf{A})$. Define the four tensor

$$F_{\mu\nu} = \frac{\partial A^\nu}{\partial x^\mu} - \frac{\partial A^\mu}{\partial x^\nu} = \partial^\mu A^\nu - \partial^\nu A^\mu$$

of rank 2 called the *electromagnetic field tensor*, where $\partial_\mu = (\partial_t, \nabla)$. In matrix representation, the contravariant field tensor can be written as follows:

$$F^{\mu\nu} = \begin{bmatrix} 0 & E_x/c & E_y/c & E_z/c \\ E_x/c & 0 & B_z & B_y \\ E_y/c & B_z & 0 & B_x \\ E_z/c & B_y & B_x & 0 \end{bmatrix}.$$

Similarly, the covariant field tensor is obtained from the contravariant field tensor in the usual manner by index lowering

$$F_{\mu\nu} = g_{\mu\kappa}g_{\nu\lambda}F^{\kappa\lambda} = \partial_\mu A_\nu - \partial_\nu A_\mu$$

with a matrix representation

$$F_{\mu\nu} = \begin{bmatrix} 0 & E_x/c & E_y/c & E_z/c \\ -E_x/c & 0 & -B_z & B_y \\ -E_y/c & B_z & 0 & -B_x \\ -E_z/c & -B_y & B_x & 0 \end{bmatrix}.$$

Then the two Maxwell source equations can be written

$$\partial_\mu F^{\mu\nu} = \mu_0 j^\nu. \quad (7-85)$$

In fact, let $\nu = 0$ corresponding to the first/leftmost column in the matrix representation of the covariant component form of the electromagnetic field tensor $F^{\mu\nu}$, we find that

$$\begin{aligned} \frac{\partial F^{00}}{\partial x^0} + \frac{\partial F^{10}}{\partial x^1} + \frac{\partial F^{20}}{\partial x^2} + \frac{\partial F^{30}}{\partial x^3} &= 0 + \frac{1}{c} \left(\frac{\partial E_x}{\partial x} + \frac{\partial E_y}{\partial y} + \frac{\partial E_z}{\partial z} \right) \\ &= \frac{1}{c} \nabla \cdot \mathbf{E} = \mu_0 j^0 = \mu_0 c \rho = \rho / \varepsilon_0, \end{aligned}$$

i.e.,

$$\nabla \cdot \mathbf{E} = \frac{\rho}{\varepsilon_0}.$$

For $\nu = 1$, the equation (7-85) yields that

$$\frac{\partial F^{01}}{\partial x^0} + \frac{\partial F^{11}}{\partial x^1} + \frac{\partial F^{21}}{\partial x^2} + \frac{\partial F^{31}}{\partial x^3} = -\frac{1}{c^2} \frac{\partial E_x}{\partial t} + 0 + \frac{\partial B_z}{\partial y} - \frac{\partial B_y}{\partial z} = \mu_0 j^1 = \mu_0 j_x,$$

which can be rewritten as

$$\frac{\partial B_z}{\partial y} - \frac{\partial B_y}{\partial z} - \varepsilon_0 \mu_0 \frac{\partial E_x}{\partial t} = \mu_0 j_x,$$

i.e.,

$$(\nabla \times \mathbf{B})_x = \mu_0 j_x + \varepsilon_0 \mu_0 \frac{\partial E_x}{\partial t}$$

and similarly for $\nu = 2, 3$. Consequently, we get the result in three-vector form

$$\nabla \times \mathbf{B} = \mu_0 \mathbf{j}(t, \vec{x}) + \varepsilon_0 \mu_0 \frac{\partial \mathbf{E}}{\partial t}.$$

Choose the Lagrange density \mathcal{L}^{EM} of a electromagnetic field to be

$$\mathcal{L}^{EM} = j^\nu A_\nu + \frac{1}{4\mu_0} F^{\mu\nu} F_{\mu\nu}.$$

Then the equation (7 – 85) is implied by the lagrange equations shown in the next result.

Theorem 7.3.1 *The equation (7 – 85) is equivalent to the Euler-Lagrange equations*

$$\frac{\partial \mathcal{L}^{EM}}{\partial A_\nu} - \partial_\mu \left[\frac{\partial \mathcal{L}^{EM}}{\partial (\partial_\mu A_\nu)} \right] = 0.$$

Proof By definition of $F^{\mu\nu}$ and $F_{\mu\nu}$, we know that

$$\begin{aligned} F^{\mu\nu} F_{\mu\nu} &= -2E_x^2/c^2 - 2E_y^2/c^2 - 2E_z^2/c^2 + 2B_x^2 + 2B_y^2 + 2B_z^2 \\ &= -2E^2/c^2 + 2B^2 = 2(B^2 - E^2/c^2). \end{aligned}$$

Whence,

$$\frac{\partial \mathcal{L}^{EM}}{\partial A_\nu} = j^\nu. \tag{7 – 86}$$

Notice that

$$\begin{aligned}
\partial_\mu \left[\frac{\partial \mathcal{L}^{EM}}{\partial(\partial_\mu A_\nu)} \right] &= \frac{1}{4\mu_0} \partial_\mu \left[\frac{\partial}{\partial(\partial_\mu A_\nu)} (F^{\kappa\lambda} F_{\kappa\lambda}) \right] \\
&= \frac{1}{4\mu_0} \partial_\mu \left\{ \frac{\partial}{\partial(\partial_\mu A_\nu)} [(\partial^\kappa A^\lambda - \partial^\lambda A^\kappa)(\partial_\kappa A_\lambda - \partial_\lambda A_\kappa)] \right\} \\
&= \frac{1}{2\mu_0} \partial_\mu \left[\frac{\partial}{\partial(\partial_\mu A_\nu)} (\partial^\kappa A^\lambda \partial_\kappa A_\lambda - \partial^\kappa A^\lambda \partial_\lambda A_\kappa) \right].
\end{aligned}$$

But

$$\begin{aligned}
\frac{\partial}{\partial(\partial_\mu A_\nu)} (\partial^\kappa A^\lambda \partial_\kappa A_\lambda) &= \partial^\kappa A^\lambda \frac{\partial}{\partial(\partial_\mu A_\nu)} \partial_\kappa A_\lambda + \partial_\kappa A_\lambda \frac{\partial}{\partial(\partial_\mu A_\nu)} \partial^\kappa A^\lambda \\
&= \partial^\kappa A^\lambda \frac{\partial}{\partial(\partial_\mu A_\nu)} \partial_\kappa A_\lambda + \partial_\kappa A_\lambda \frac{\partial}{\partial(\partial_\mu A_\nu)} g^{\kappa\alpha} \partial_\alpha g^{\lambda\beta} A_\beta \\
&= \partial^\kappa A^\lambda \frac{\partial}{\partial(\partial_\mu A_\nu)} \partial_\kappa A_\lambda + g^{\kappa\alpha} g^{\lambda\beta} \partial_\kappa A_\lambda \frac{\partial}{\partial(\partial_\mu A_\nu)} \partial_\alpha A_\beta \\
&= \partial^\kappa A^\lambda \frac{\partial}{\partial(\partial_\mu A_\nu)} \partial_\kappa A_\lambda + \partial^\alpha A^\beta \frac{\partial}{\partial(\partial_\mu A_\nu)} \partial_\alpha A_\beta \\
&= 2\partial^\mu A^\nu.
\end{aligned}$$

Similarly,

$$\frac{\partial}{\partial(\partial_\mu A_\nu)} (\partial^\kappa A^\lambda \partial_\lambda A_\kappa) = 2\partial^\nu A^\mu.$$

Whence,

$$\partial_\mu \left[\frac{\partial \mathcal{L}^{EM}}{\partial(\partial_\mu A_\nu)} \right] = \frac{1}{\mu_0} \partial_\mu (\partial^\mu A^\nu - \partial^\nu A^\mu) = \frac{1}{\mu_0} \partial_\mu F^{\mu\nu}.$$

Thereafter, we get that

$$\frac{\partial \mathcal{L}^{EM}}{\partial A_\nu} - \partial_\mu \left[\frac{\partial \mathcal{L}^{EM}}{\partial(\partial_\mu A_\nu)} \right] = j^\nu - \frac{1}{\mu_0} \partial_\mu F^{\mu\nu} = 0$$

by Euler-Lagrange equations, which means that

$$\partial_\mu F^{\mu\nu} = \mu_0 j^\nu,$$

which is the equation (7 – 86). □

Similarly, let

$$\epsilon^{\mu\nu\kappa\lambda} = \begin{cases} 1 & \text{if } \mu\nu\kappa\lambda \text{ is an even permutation of } 0, 1, 2, 3, \\ 0 & \text{if at least two of } \mu, \nu, \kappa, \lambda \text{ are equal,} \\ -1 & \text{if } \mu\nu\kappa\lambda \text{ is an odd permutation of } 0, 1, 2, 3. \end{cases}$$

Then the *dual electromagnetic tensor* $*F^{\mu\nu}$ is defined by

$$*F^{\mu\nu} = \frac{1}{2}\epsilon^{\mu\nu\kappa\lambda}F_{\kappa\lambda},$$

or in a matrix form of the dual field tensor following

$$*F^{\mu\nu} = \begin{bmatrix} 0 & -cB_x & -cB_y & -cB_z \\ cB_x & 0 & E_z & -E_y \\ cB_y & -E_z & 0 & E_x \\ cB_z & E_y & -E_x & 0 \end{bmatrix}.$$

Then the covariant form of the two Maxwell field equations

$$\nabla \times \mathbf{E}(t, \bar{x}) = -\frac{\partial}{\partial t}\mathbf{B}(t, \bar{x}),$$

$$\nabla \cdot \mathbf{B}(t, \bar{x}) = 0$$

can then be written

$$\partial *F^{\mu\nu} = 0,$$

or equivalently,

$$\partial_\kappa F_{\mu\nu} + \partial_\mu F_{\nu\kappa} + \partial_\nu F_{\kappa\mu} = 0, \quad (7-87)$$

which is just the *Jacobi identity*.

7.3.5 Electromagnetic Field with Gravitation. We determine the gravitational field with a nonvanishing energy-momentum tensor $T_{\mu\nu}$, i.e., the solution of Einstein gravitational field equations in vacuum due to a spherically symmetric distribution of a body with mass m and charged q . In this case, such a metric can be also written as

$$d^2s = B(r)dt^2 - A(r)dr^2 - r^2d\theta^2 - r^2\sin^2\theta d\phi^2.$$

By (7-66), we know that $E(r) = q/r^2$ and

$$F^{\mu\nu} = \frac{E(r)}{c^2} \begin{bmatrix} 0 & -1 & 0 & 0 \\ 1 & 0 & 0 & 0 \\ 0 & 0 & 0 & 0 \\ 0 & 0 & 0 & 0 \end{bmatrix} \quad \text{and} \quad F_{\mu\nu} = \frac{E(r)}{c^2} \begin{bmatrix} 0 & 1 & 0 & 0 \\ -1 & 0 & 0 & 0 \\ 0 & 0 & 0 & 0 \\ 0 & 0 & 0 & 0 \end{bmatrix},$$

i.e., $F_{01} = F^{10} = E/c^2$, $F_{10} = F^{01} = -E/c^2$ and all other entries vanish in such a case, where indexes $0 = t$, $1 = r$, $2 = \theta$ and $3 = \phi$. Calculations show that

$$F_{01}F^{01} = F_{10}F^{10} = -E^2/c^2,$$

$$F_{\lambda\tau}F^{\lambda\tau} = F_{10}F^{01} + F_{01}F^{10} = -2E^2.$$

In an electromagnetic field, we know that $T_{\mu\nu} = -(g_{\sigma\nu}F_{\mu\lambda}F^{\sigma\lambda} + \frac{E^2}{2}g_{\mu\nu})$ by definition. Whence,

$$T_{00} = -(g_{0\sigma}F_{0\lambda}F^{\sigma\lambda} + \frac{E^2}{2}g_{00}) = \frac{E^2}{2c^4}B,$$

$$T_{11} = -g_{11}(F_{10}F^{10} + \frac{E^2}{2}) = -\frac{E^2}{2c^4}A,$$

$$T_{22} = \frac{E^2}{2c^4}r^2, \quad T_{33} = \frac{E^2}{2c^4}r^2 \sin^2 \theta$$

and all of others $T_{\mu\nu} = 0$, i.e.,

$$T_{\mu\nu} = \frac{E(r)}{c^2} \begin{bmatrix} B & 0 & 0 & 0 \\ 0 & -A & 0 & 0 \\ 0 & 0 & r^2 & 0 \\ 0 & 0 & 0 & r^2 \sin^2 \theta \end{bmatrix}.$$

These Ricci's tensors are the same as (7-58). Now we need to solve the Einstein gravitational field equations

$$R_{\mu\nu} = -8\pi GT_{\mu\nu},$$

i.e.,

$$R_{tt} = -\frac{4G\pi q^2}{c^4 r^4} B, \quad R_{rr} = \frac{4G\pi q^2}{c^4 r^4} A,$$

$$R_{\theta\theta} = -\frac{4G\pi q^2}{c^4 r^2}, \quad R_{\phi\phi} = \frac{4G\pi q^2}{c^4 r^2} \sin^2 \theta.$$

Similarly, we also know that

$$\frac{R_{tt}}{B} + \frac{R_{rr}}{A} = 0,$$

which implies that $A = 1/B$ and

$$R_{\theta\theta} = \frac{d}{dr}(rB) - 1 = -\frac{4G\pi q^2}{c^4 r^2}.$$

Integrating this equation, we find that

$$rB - r = \frac{4G\pi q^2}{c^4 r} + k.$$

Whence,

$$B(r) = 1 + \frac{4G\pi q^2}{c^4 r^2} + \frac{k}{r}.$$

Notice that if $r \rightarrow \infty$, then

$$g_{tt} = 1 - \frac{2Gm}{c^2 r} = 1 + \frac{4G\pi q^2}{c^4 r^2} + \frac{k}{r}.$$

Whence $k = -2Gm/c^2$ and

$$B(r) = 1 + \frac{4G\pi q^2}{c^4 r^2} - \frac{2Gm}{c^2 r}.$$

Consequently, We get that

$$ds^2 = \left(1 + \frac{4G\pi q^2}{c^4 r^2} - \frac{2Gm}{c^2 r}\right) dt^2 - \frac{dr^2}{1 + \frac{4G\pi q^2}{c^4 r^2} - \frac{2Gm}{c^2 r}} - r^2 d\theta^2 - r^2 \sin^2 \theta d\phi^2.$$

Denote by $r_s = 2Gm/c^2$ and $r_q^2 = 4G\pi q^2/c^4$, then we have the metric of a charged q body with mass m following:

$$ds^2 = \left(1 + \frac{r_q^2}{r^2} - \frac{r_s}{r}\right) dt^2 - \frac{dr^2}{1 + \frac{r_q^2}{r^2} - \frac{r_s}{r}} - r^2 d\theta^2 - r^2 \sin^2 \theta d\phi^2. \quad (7-88)$$

§7.4 GAUGE FIELD

These symmetry transformations lies in the Einstein's principle of covariance, i.e., *laws of physics should take the same form independently of any coordinate frame* are referred to as *external symmetries*. For knowing the behavior of the world, one also needs internal parameters, such as those of charge, baryonic number, ..., etc., *called gauge basis* which uniquely determine the behavior of the physical object under consideration. The correspondent symmetry transformations on these internal parameters, usually called *gauge transformation*, leaving invariant of physical laws which are functional relations in internal parameters are termed *internal symmetries*.

A *gauge field* is such a mathematical model with local or global symmetries under a group, a finite-dimensional Lie group in most cases action on its gauge basis at an individual point in space and time, together with a set of techniques for making physical predictions consistent with the symmetries of the model, which is a generalization of Einstein's principle of covariance to that of internal field. Whence, the gauge theory can be applied to describe interaction of elementary particles, and perhaps, it maybe unifies the existent four forces in physics. Usually, this gauge invariance is adopted in a mathematical form following.

Gauge Invariant Principle *A gauge field equation, particularly, the Lagrange density of a gauge field is invariant under gauge transformations on this field.*

7.4.1 Gauge Scalar Field. Let $\phi(\bar{x})$ be a complex scalar field with a mass m . Then its Lagrange density can be written as

$$\mathcal{L} = \partial_\mu \phi^\dagger \partial^\mu \phi - m^2 \phi^\dagger \phi,$$

where ϕ^\dagger is the *Hermitian conjugate* of ϕ , $\partial^\mu = (\partial_t, -\nabla)$ and ϕ , ϕ^\dagger are independent. In this case, the Euler-Lagrange equations are respective

$$\begin{aligned} \partial_\mu \frac{\partial \mathcal{L}}{\partial(\partial_\mu \phi^\dagger)} - \frac{\partial \mathcal{L}}{\partial \phi^\dagger} &= \partial_\mu \partial^\mu \phi + m^2 \phi = (\partial^2 + m^2)\phi = 0, \\ \partial_\mu \frac{\partial \mathcal{L}}{\partial(\partial_\mu \phi)} - \frac{\partial \mathcal{L}}{\partial \phi} &= \partial_\mu \partial^\mu \phi^\dagger + m^2 \phi^\dagger = (\partial^2 + m^2)\phi^\dagger = 0. \end{aligned}$$

Consider its gauge transformation $\phi \rightarrow \phi' = e^{i\gamma} \phi$ for a real number γ . By the gauge principle of invariance, the Lagrange density \mathcal{L} is invariant under this

transformation. In this case, $\delta\phi = i\gamma\phi$, $\delta\phi^\dagger = -i\gamma\phi^\dagger$, $\delta\partial_\mu\phi = i\gamma\partial_\mu\phi$, $\delta\partial_\mu\phi^\dagger = -i\gamma\partial_\mu\phi^\dagger$. Whence, we get that

$$\begin{aligned} \delta\mathcal{L} &= i\gamma\left(\frac{\partial\mathcal{L}}{\partial\phi}\phi - \phi^\dagger\frac{\partial\mathcal{L}}{\partial\phi^\dagger} + \frac{\partial\mathcal{L}}{\partial\partial_\mu\phi}\partial_\mu\phi - \partial_\mu\phi^\dagger\frac{\partial\mathcal{L}}{\partial\partial_\mu\phi^\dagger}\right) \\ &= i\gamma\partial_\mu\left(\frac{\partial\mathcal{L}}{\partial\partial_\mu\phi}\phi - \phi^\dagger\frac{\partial\mathcal{L}}{\partial\partial_\mu\phi^\dagger}\right) \end{aligned} \quad (7-89)$$

by applying

$$\partial_\mu\frac{\partial\mathcal{L}}{\partial(\partial_\mu\phi)} - \frac{\partial\mathcal{L}}{\partial\phi} = 0, \quad \partial_\mu\frac{\partial\mathcal{L}}{\partial(\partial_\mu\phi^\dagger)} - \frac{\partial\mathcal{L}}{\partial\phi^\dagger} = 0.$$

Let $\delta\mathcal{L} = 0$ in (7-89), we get the continuous equation

$$\partial_\mu j^\mu = 0,$$

where

$$j^\mu = \frac{q}{i}\left(\frac{\partial\mathcal{L}}{\partial\partial_\mu\phi}\phi - \phi^\dagger\frac{\partial\mathcal{L}}{\partial\partial_\mu\phi^\dagger}\right),$$

$i^2 = -1$ and q is a real number. Therefore,

$$j^\mu = iq(\phi^\dagger\partial^\mu\phi - (\partial^\mu\phi^\dagger)\phi).$$

If γ is a function of \bar{x} , i.e., $\gamma(\bar{x})$, we need to find the Lagrange density \mathcal{L} in this case. Notice that

$$\partial_\mu(e^{i\gamma}\phi) = e^{i\gamma}(\partial_\mu + i\partial_\mu\gamma)\phi.$$

For ensuring the invariance of \mathcal{L} , we need to replace the operator ∂_μ acting on ϕ by $D_\mu = \partial_\mu + irA_\mu$, where $A_\mu = A_\mu(\bar{x})$ is a field and r a constant. We choose

$$D_\mu \rightarrow D'_\mu = \partial_\mu + irA'_\mu,$$

$$A_\mu \rightarrow A'_\mu = A_\mu - \frac{1}{q}\partial_\mu\gamma$$

and

$$\mathcal{L} = (D_\mu \phi)^\dagger (D^\mu \phi) - m^2 \phi^\dagger \phi.$$

Then we have

$$D_\mu \phi \rightarrow (D_\mu \phi)' = D'_\mu \phi' = e^{i\gamma} D_\mu \phi,$$

i.e., \mathcal{L} is invariant under the transformation $\phi \rightarrow \phi' = e^{i\gamma} \phi$.

Now consider a set of n non-interacting complex scalar fields with equal masses m . Then an action is the sum of the usual action for each scalar field ϕ_i , $1 \leq i \leq n$ following

$$I = \int d^4x \sum_{i=1}^n \left(\frac{1}{2} \partial_\mu \phi_i \partial^\mu \phi_i - \frac{1}{2} m^2 \phi_i^2 \right).$$

Let $\Phi = (\phi_1, \phi_2, \dots, \phi_n)^t$. In this case, the Lagrange density can be compactly written as

$$\mathcal{L} = \frac{1}{2} (\partial_\mu \Phi)^t \partial^\mu \Phi - \frac{1}{2} m^2 \Phi^t \Phi.$$

Then it is clear that the Lagrangian is invariant under the transformation $\Phi \rightarrow G\Phi$ whenever G is a $n \times n$ matrix in orthogonal group $O(n)$.

7.4.2 Maxwell Field. If a field ϕ is gauge invariant in the transformation $\phi(\vec{x}) \rightarrow \phi'(\vec{x}) = e^{i\gamma(\vec{x})} \phi(\vec{x})$, then there must exist a coupling field $A_\mu(\vec{x})$ of $\phi(\vec{x})$ such that $A_\mu(\vec{x})$ is invariant under the gauge transformation

$$A_\mu(\vec{x}) \rightarrow A'_\mu(\vec{x}) = A_\mu(\vec{x}) + \partial_\mu \chi(\vec{x}),$$

where $\chi(\vec{x}) \propto \gamma(\vec{x})$ is a real function. In this case, the gauge field $F^{\mu\nu}$ and the Lagrange density \mathcal{L} can be respectively chosen as

$$F^{\mu\nu} = \partial^\mu A^\nu - \partial^\nu A^\mu, \quad \mathcal{L} = -\frac{1}{4} F_{\mu\nu} F^{\mu\nu}.$$

We call \mathcal{L} the *Maxwell-Lagrange density* and A_μ the *Maxwell field*. Applying the Euler-Lagrange equations, the Maxwell field should be determined by equations

$$\frac{\mathcal{L}}{\partial A_\mu} - \partial_\mu \frac{\mathcal{L}}{\partial \partial_\mu A_\nu} = 0 + \partial_\mu \partial^\mu A^\nu - \partial_\mu \partial^\nu A^\mu = \partial_\mu F^{\mu\nu} = 0.$$

By the definition of $F^{\mu\nu}$ and Jacobian identity established in Theorem 5.1.2, the following identity

$$\partial_\lambda F_{\mu\nu} + \partial_\mu F_{\nu\lambda} + \partial_\nu F_{\lambda\mu} = 0$$

holds. Whence, a Maxwell field is determined by

$$\begin{aligned} \partial_\mu F^{\mu\nu} &= 0, \\ \partial_\kappa F_{\mu\nu} + \partial_\mu F_{\nu\kappa} + \partial_\nu F_{\kappa\mu} &= 0. \end{aligned}$$

By the definition of $F^{\mu\nu}$, the 4 coordinates used to describe the field A_μ are not complete independent. So we can choose additional gauge conditions as follows.

Lorentz Gauge: $\partial_\mu A^\mu = 0$.

Lorentz gauge condition is coinvariant, but it can not removes all non-physical freedoms appeared in a Maxwell filed. In fact, the number of freedom of a Maxwell filed is 3 after the Lorentz gauge added.

Coulomb Gauge: $\nabla \cdot \mathbf{A} = 0$ and $\nabla^2 A^0 = -\rho$, where ρ is the charge density of field.

Radiation Gauge: $\nabla \cdot \mathbf{A} = 0$ and $A^0 = 0$.

The Coulomb gauge and radiation gauge conditions remove all these non-physical freedoms in a Maxwell field, but it will lose the invariance of filed. In fact, the number of freedom of a Maxwell filed is 2 after the Coulomb gauge or radiation gauge added.

7.4.3 Weyl Field. A *Weyl field* $\psi(\bar{x})$ is determined by an equation following

$$\partial_0 \psi = b^i \partial_i \psi + C \psi,$$

where b^i and C are undetermined coefficients and $\psi(\bar{x})$ characterizes the *spinor of field*. Acting by ∂_0 on both sides of this equation, we find that

$$\begin{aligned} \partial_0^2 \psi &= (b^i \partial_i + C) \partial_0 \psi = (b^i \partial_i + C)^2 \psi \\ &= \left[\frac{1}{2} (b^i b^j + b^j b^i) \partial_i \partial_j + 2C b^i \partial_i + C^2 \right] \psi. \end{aligned} \tag{7-90}$$

Let $C = 0$ and $\{b^i, b^j\} = b^i b^j + b^j b^i = -2g^{ij}$. Then we obtain the *d'Alembert equation*

$$\partial_\mu \partial^\mu \psi = 0$$

from the equation (7-90). Notice b^i must be a matrix if $b^i b^j + b^j b^i = -2g^{ij}$ and ψ in a vector space with dimensional ≥ 2 . For dimensional 2 space, we have

$$b^i = \pm \sigma^i$$

where

$$\sigma^1 = \begin{bmatrix} 0 & 1 \\ 1 & 0 \end{bmatrix}, \quad \sigma^2 = \begin{bmatrix} 0 & -i \\ i & 0 \end{bmatrix}, \quad \sigma^3 = \begin{bmatrix} 1 & 0 \\ 0 & -1 \end{bmatrix}$$

are *Pauli matrixes* and $\{\sigma^i, \sigma^j\} = -2g^{ij}$. In this case, the Weyl equation comes to be

$$\partial_0 \psi = \pm \sigma^i \partial_i \psi. \quad (7-91)$$

Let

$$x^i \rightarrow x^{i'} = a_j^i x^j$$

be a rotation transformation of the external field of dimensional 3. Whence, $[a_j^i]$ is a 3×3 real orthogonal matrix with $a_k^i a_j^k = \delta_j^i$. Correspondent to this rotation transformation, let

$$\psi \rightarrow \psi' = \Lambda \psi$$

be a rotation transformation of the internal field. Substitute this transformation and $\partial_i = a_i^j \partial'_j$ into (7-91), we find that

$$\partial_0 \psi' = \pm \Lambda \sigma^i \Lambda^{-1} a_i^j \partial'_j \psi'. \quad (7-92)$$

If the form of equation (7-92) is as the same as (7-91), we should have

$$a_i^j \Lambda \sigma^i \Lambda^{-1} = \sigma^j,$$

or equivalently,

$$\Lambda^{-1} \sigma^i \Lambda = a_j^i \sigma^j. \quad (7-93)$$

We show the equation (7-93) indeed has solutions. Consider an infinitesimal rotation

$$a_j^i = g_j^i + \epsilon_{jk}^i \theta^k.$$

of the external field. Then its correspondent infinitesimal rotation of the internal can be written as

$$\Lambda = 1 + i\varepsilon_i \sigma^i.$$

Substituting these two formulae into (7-93) and neglecting the terms with power more than 2 of ε_i , we find that

$$\sigma^i + i\varepsilon_j (\sigma^i \sigma^j - \sigma^j \sigma^i) = \sigma^i + \epsilon_{jk}^i \sigma^j \theta^k.$$

Solving this equation, we get that $\varepsilon_i = \theta_i/2$. Whence,

$$\Lambda = 1 - \frac{i}{2} \theta \cdot \sigma, \tag{7-94}$$

where $\theta = (\theta^1, \theta^2, \theta^3)$. Consequently, the Weyl equation is gauge invariant under the rotation of external field if the internal field rotates with $\psi \rightarrow \Lambda\psi$ in (7-94).

The reflection P and time-reversal transformation T on a field are respective $x^i \rightarrow a_j^i x^j$, $x^i \rightarrow b_j^i x^j$ with (a_j^i) , (b_j^i) following

$$(a_\nu^\mu) = \begin{bmatrix} 1 & 0 & 0 & 0 \\ 0 & -1 & 0 & 0 \\ 0 & 0 & -1 & 0 \\ 0 & 0 & 0 & -1 \end{bmatrix} \quad \text{and} \quad (b_\nu^\mu) = \begin{bmatrix} -1 & 0 & 0 & 0 \\ 0 & 1 & 0 & 0 \\ 0 & 0 & 1 & 0 \\ 0 & 0 & 0 & 1 \end{bmatrix}.$$

Similarly, we can show the Weyl equation is not invariant under the reflection P and time-reversal transformation T , but invariant under a reflection following a time-reversal transformations PT and TP .

A *particle-antiparticle transformation* C is a substitution a particle p by its antiparticle $Ant - p$. For Weyl field, since $\sigma^2(\sigma^i)^* = -\sigma^i\sigma^2$, we get

$$\partial_0 \psi_C = \mp \sigma^i \partial_i \psi_C$$

for a field transformation $\psi \rightarrow \psi_C = C\psi = \eta_C \sigma^2 \psi^*$, where η_C is a constant with $\eta_C^* \eta_C = 1$. Comparing this equation with the Weyl equation, this equation char-

acterizes a particle ψ_C with a reverse spiral of ψ . Whence, the Weyl field is not invariant under particle-antiparticle transformations C , but is invariant under CP .

7.4.4 Dirac Field. The *Dirac field* $\psi(\bar{x})$ is determined by an equation following:

$$(i\gamma^\mu \partial_\mu - m)\psi = 0, \quad (7-95)$$

where γ^μ is a 4×4 matrix, called *Dirac matrix* and ψ a 4-component spinor. Calculation shows that

$$\{\gamma^\mu, \gamma^\nu\} = \gamma^\mu \gamma^\nu + \gamma^\nu \gamma^\mu = 2g^{\mu\nu}$$

and

$$\gamma^0 = \begin{bmatrix} I_{2 \times 2} & 0_{2 \times 2} \\ 0_{2 \times 2} & -I_{2 \times 2} \end{bmatrix}, \quad \gamma^i = \begin{bmatrix} 0_{2 \times 2} & \sigma^i \\ -\sigma^i & 0_{2 \times 2} \end{bmatrix}.$$

Now let

$$\psi = \begin{pmatrix} \psi_L \\ \psi_R \end{pmatrix},$$

where ψ_L, ψ_R are *left-handed* and *right-handed Weyl spinors*. Then the Dirac equation can be rewritten as

$$(i\gamma^\mu \partial_\mu - m)\psi = \begin{bmatrix} -m & i(\partial_0 + \sigma \cdot \nabla) \\ i(\partial_0 - \sigma \cdot \nabla) & m \end{bmatrix} \begin{pmatrix} \psi_L \\ \psi_R \end{pmatrix} = 0.$$

If we set $m = 0$, then the Dirac equation are decoupled to two Weyl equations

$$i(\partial_0 - \sigma \cdot \nabla)\psi_L = 0, \quad i(\partial_0 + \sigma \cdot \nabla)\psi_R = 0.$$

Let $X^\mu \rightarrow x^{\mu'} = a_{\nu}^{\mu'} x^\nu$ be a *Lorentz transformation* of external field with $\psi \rightarrow \Lambda\psi$ the correspondent transformation of the internal. Substituting $\psi' = \Lambda\psi$ and $\partial_\mu = a_{\nu}^{\mu'} \partial_{\nu}'$ into the equation (7-95), we know that

$$(i\Lambda\gamma^\mu \Lambda^{-1} a_{\mu}^{\nu'} \partial_{\nu}' - m)\psi' = 0.$$

If its form is the same as (7-95), we must have

$$\Lambda\gamma^\mu \Lambda^{-1} a_{\mu}^{\nu'} = \gamma^{\nu'},$$

or equivalently,

$$\Lambda\gamma^\mu\Lambda^{-1} = a_\nu^\mu\gamma^\nu. \quad (7-96)$$

Now let

$$\Lambda = I_{4\times 4} + \frac{1}{4}\varepsilon_{\mu\nu}\gamma^\mu\gamma^\nu = 1 + \frac{1}{8}\varepsilon_{\mu\nu}(\gamma^\mu\gamma^\nu - \gamma^\nu\gamma^{\mu\nu}), \quad (7-97)$$

where $\varepsilon_{\nu\mu} = -\varepsilon_{\mu\nu}$. It can be verified that the identify (7-96) holds, i.e., the Dirac equation (7-95) is covariant under the Lorentz transformation.

Similar to the discussion of Weyl equation, we consider the invariance of Dirac equation under rotation, reflection and time-reversal transformations.

(1)Rotation. For an infinitesimal rotation, $\varepsilon_{ij} = \epsilon_{ijk}^i\theta^k$ and $\varepsilon_{0i} = 0$. Substitute them into (7-97), we find that

$$\Lambda = 1 - \frac{i}{2}\theta \cdot \Sigma,$$

where $\theta = (0, \theta^1, \theta^2, \theta^3)$ and

$$\Sigma^i = -\frac{i}{2}\epsilon_{ijk}^i\gamma^j\gamma^k = \begin{bmatrix} \sigma^i & 0_{2\times 2} \\ 0_{2\times 2} & \sigma^i \end{bmatrix}.$$

(2)Reflection. Let $x^\mu \rightarrow a_\nu^\mu x^\nu$ be a reflection. Substituting it into (7-96), we have

$$\Lambda^{-1}\gamma^0\Lambda = \gamma^0, \quad \Lambda^{-1}\gamma^i\Lambda = \gamma^i.$$

Solving these equations, we get that $\Lambda = \eta_P\gamma^0$, where η_P is a constant with $\eta_P^*\eta_P = 1$.

(3)Time-Reverse. Let $x^\mu \rightarrow a_\nu^\mu x^\nu$ be a time-reversal transformation. Consider the complex conjugate of the Dirac equation (7-95), we know

$$(-i\gamma^{\mu*}\partial_\mu - m)\psi^* = 0,$$

i.e.,

$$[i(-\gamma^0\partial_0 - \gamma^1\partial_1 + \gamma^2\partial_2 - \gamma^3\partial_3) - m]\psi^* = 0.$$

Substituting it with $\partial_\mu = a_\nu^\mu\partial'_\nu$, we find that

$$[i(\gamma^0\partial'_0 - \gamma^1\partial'_1 + \gamma^2\partial'_2 - \gamma^3\partial'_3) - m]\psi^* = 0. \quad (7-98)$$

Acting by Λ on the left side of (7-98), we get that

$$[i(\Lambda\gamma^0\Lambda^{-1}\partial'_0 - \Lambda\gamma^1\Lambda^{-1}\partial'_1 + \Lambda\gamma^2\Lambda^{-1}\partial'_2 - \Lambda\gamma^3\Lambda^{-1}\partial'_3) - m]\Lambda\psi^* = 0. \quad (7-99)$$

Comparing (7-99) with (7-95), we know that

$$\begin{aligned} \Lambda\gamma^0\Lambda^{-1} &= \gamma^0, & \Lambda\gamma^1\Lambda^{-1} &= -\gamma^1, \\ \Lambda\gamma^2\Lambda^{-1} &= \gamma^2, & \Lambda\gamma^3\Lambda^{-1} &= -\gamma^3. \end{aligned}$$

Solving these equations, we get that $\Lambda = \eta_T\gamma^2\gamma^3$, where η_T is a constant with $\eta_T^*\eta_T = 1$. Whence, the time-reversal transformation of Dirac spinor is $\psi \rightarrow \psi_T = T\psi = \eta_T\gamma^2\gamma^3\psi^*$.

(4) Particle-Antiparticle. A particle-antiparticle transformation C on Dirac field is $\psi \rightarrow \psi_C = C\psi = i\gamma^2\psi^*$. Assume spinor fields is gauge invariant. By introducing a gauge field A_μ , the equation (7-95) turns out

$$[\gamma^\mu(i\partial_\mu - qA_\mu) - m]\psi = 0, \quad (7-100)$$

where the coupled number q is called charge. The complex conjugate of the equation (7-100) is

$$[\gamma^{\mu*}(-i\partial_\mu - qA_\mu) - m]\psi^* = 0. \quad (7-101)$$

Notice that A_μ is real and $\gamma^{2*} = -\gamma^2$. Acting by $i\gamma^2$ on the equation (7-101), we finally get that

$$[\gamma^\mu(i\partial_\mu + qA_\mu) - m]\psi_C = 0, \quad (7-102)$$

Comparing the equation (7-102) with (7-100), we know that equation (7-102) characterizes a Dirac field of charge $-q$. Whence, Dirac field is C invariant. Consequently, Dirac field is symmetric with respect to C , P and T transformations.

7.4.5 Yang-Mills Field. These gauge fields in Sections 7.4.1-7.4.4 are all Abelian, i.e., $\phi(\vec{x}) \rightarrow \phi'(\vec{x}) = e^{i\gamma(\vec{x})}\phi(\vec{x})$ with a commutative $\gamma(\vec{x})$, but the *Yang-Mills field* is non-Abelian characterizing of interactions. First, we explain the Yang-Mills $SU(2)$ -field following.

Let a field ψ be an isospin doublet $\psi = \begin{pmatrix} \psi_1 \\ \psi_2 \end{pmatrix}$. Under a local $SU(2)$ transformation, we get that

$$\psi(\bar{x}) \rightarrow \psi'(\bar{x}) = e^{\frac{-i\sigma \cdot \theta(\bar{x})}{2}} \psi(\bar{x}),$$

where $\sigma = (\sigma^1, \sigma^2, \sigma^3)$ are the Pauli matrices satisfying

$$\left[\frac{\sigma^i}{2}, \frac{\sigma^j}{2} \right] = i\varepsilon_{ijk} \frac{\sigma^k}{2}, \quad 1 \leq i, j, k \leq 3$$

and $\theta = (\theta_1, \theta_2, \theta_3)$. For constructing a gauge-invariant Lagrange density, we introduce the vector gauge fields $\mathbf{A}_\mu = (A_\mu^1, A_\mu^2, A_\mu^3)$ to form covariant derivative

$$D_\mu \psi = \left(\partial_\mu - ig \frac{\sigma \cdot \mathbf{A}_\mu}{2} \right) \psi,$$

where g is the coupling constant. By gauge invariant principle, $D_\mu \psi$ must have the same transformation property as ψ , i.e.,

$$D_\mu \psi \rightarrow (D_\mu \psi)' = e^{\frac{-i\sigma \cdot \theta(\bar{x})}{2}} D_\mu \psi.$$

This implies that

$$\left(\partial_\mu - ig \frac{\sigma \cdot \mathbf{A}'_\mu}{2} \right) \left(e^{\frac{-i\sigma \cdot \theta(\bar{x})}{2}} \psi \right) = e^{\frac{-i\sigma \cdot \theta(\bar{x})}{2}} \left(\partial_\mu - ig \frac{\sigma \cdot \mathbf{A}_\mu}{2} \right) \psi,$$

i.e.,

$$\left(\partial_\mu e^{\frac{-i\sigma \cdot \theta(\bar{x})}{2}} - ig \frac{\sigma \cdot \mathbf{A}'_\mu}{2} e^{\frac{-i\sigma \cdot \theta(\bar{x})}{2}} \right) \psi = -ig e^{\frac{-i\sigma \cdot \theta(\bar{x})}{2}} \frac{\sigma \cdot \mathbf{A}_\mu}{2} \psi.$$

Whence, we get that

$$\frac{\sigma \cdot \mathbf{A}'_\mu}{2} = e^{\frac{-i\sigma \cdot \theta(\bar{x})}{2}} \frac{\sigma \cdot \mathbf{A}_\mu}{2} e^{\frac{i\sigma \cdot \theta(\bar{x})}{2}} - \frac{i}{g} (\partial_\mu e^{\frac{-i\sigma \cdot \theta(\bar{x})}{2}}) e^{\frac{i\sigma \cdot \theta(\bar{x})}{2}},$$

which determines the transformation law for gauge fields. For an infinitesimal variation $\theta(\bar{x}) \ll 1$, we know that

$$e^{\frac{-i\sigma \cdot \theta(\bar{x})}{2}} \approx 1 - i \frac{\sigma \cdot \theta(\bar{x})}{2}$$

and

$$\begin{aligned} \frac{\sigma \cdot \mathbf{A}'_\mu}{2} &= \frac{\sigma \cdot \mathbf{A}_\mu}{2} - i\theta^j A_\mu^k \left[\frac{\sigma^i}{2}, \frac{\sigma^j}{2} \right] - \frac{1}{g} \left(\frac{\sigma}{2} \cdot \partial_\mu \theta \right) \\ &= \frac{\sigma \cdot \mathbf{A}_\mu}{2} + \frac{1}{2} \varepsilon^{ijk} \sigma^i \theta^j A_\mu^k - \frac{1}{g} \left(\frac{\sigma}{2} \cdot \partial_\mu \theta \right), \end{aligned}$$

i.e.,

$$A_\mu^i = A_\mu^i + \varepsilon^{ijk}\theta^j A_\mu^k - \frac{1}{g}\partial_\mu\theta^i.$$

Similarly, consider the combination

$$(D_\mu D_\nu - D_\nu D_\mu)\psi = ig\left(\frac{\sigma^i}{2}F_{\mu\nu}^i\right)\psi$$

with

$$\frac{\sigma \cdot \mathbf{F}_{\mu\nu}}{2} = \partial_\mu \frac{\sigma \cdot \mathbf{A}_\nu}{2} - \partial_\nu \frac{\sigma \cdot \mathbf{A}_\mu}{2} - ig\left[\frac{\sigma \cdot \mathbf{A}_\mu}{2}, \frac{\sigma \cdot \mathbf{A}_\nu}{2}\right],$$

i.e.,

$$F_{\mu\nu}^i = \partial_\mu A_\nu^i - \partial_\nu A_\mu^i + g\varepsilon^{ijk}A_\mu^j A_\nu^k. \quad (7-103)$$

By the gauge invariant principle, we have

$$[(D_\mu D_\nu - D_\nu D_\mu)\psi]' = e^{-\frac{i\sigma \cdot \theta(\mathbf{x})}{2}}(D_\mu D_\nu - D_\nu D_\mu)\psi. \quad (7-104)$$

Substitute $F_{\mu\nu}^i$ in (7-103) into (7-104), we know that

$$\sigma \cdot \mathbf{F}'_{\mu\nu} e^{-\frac{i\sigma \cdot \theta(\mathbf{x})}{2}} \psi = e^{-\frac{i\sigma \cdot \theta(\mathbf{x})}{2}} \sigma \cdot \mathbf{F}_{\mu\nu} \psi,$$

i.e.,

$$\sigma \cdot \mathbf{F}'_{\mu\nu} = e^{-\frac{i\sigma \cdot \theta(\mathbf{x})}{2}} \sigma \cdot \mathbf{F}_{\mu\nu} e^{\frac{i\sigma \cdot \theta(\mathbf{x})}{2}}.$$

For an infinitesimal transformation $\theta_i \ll 1$, this translates into

$$F_{\mu\nu}^i = F_{\mu\nu}^i + \varepsilon^{ijk}\theta^j F_{\mu\nu}^k.$$

Notice $F_{\mu\nu}$ is not gauge invariant in this case. Whence, $\frac{1}{4}F_{\mu\nu}F^{\mu\nu}$ is not a gauge invariant again. But

$$\frac{1}{2}\text{tr}(F_{\mu\nu}F^{\mu\nu}) = -\frac{1}{4}F_{\mu\nu}^i F^{i\mu\nu}$$

is a gauge invariant. We can choose

$$\mathcal{L} = \frac{1}{2}\text{tr}(F_{\mu\nu}F^{\mu\nu}) = -\frac{1}{4}F_{\mu\nu}^i F^{i\mu\nu}$$

to be its Lagrange density and find its equations of motion by Euler-Lagrange equations, where

$$F_{\mu\nu}^i = \partial_\mu A_\nu^i - \partial_\nu A_\mu^i + g\varepsilon^{ijk} A_\mu^j A_\nu^k,$$

$$D_\mu \psi = \left(\partial_\mu - ig \frac{\sigma \cdot \mathbf{A}_\mu}{2} \right) \psi.$$

Generally, the Lagrange density of Yang-Mills $SU(n)$ -field is determined by

$$\mathcal{L} = -\frac{1}{2} \text{Tr}(F_a^{\mu\nu} F_{\mu\nu}^a).$$

Applying the Euler-Lagrange equations, we can also get the equations of motion of Yang-Mills $SU(n)$ fields for $n \geq 2$.

7.4.6 Higgs Mechanism. The gauge invariance is in the central place of quantum field theory. But it can be broken in adding certain non-invariant terms to its Lagrangian by a *spontaneous symmetry broken* mechanism.

For example, let ϕ^4 be a complex scalar field with Lagrange density

$$\mathcal{L} = \partial_\mu \phi^\dagger \partial^\mu \phi - V(\phi, \phi^\dagger) = \partial_\mu \phi^\dagger \partial^\mu \phi - m^2 \phi^\dagger \phi - \lambda^2 (\phi^\dagger \phi)^2,$$

where m and λ are two parameters of ϕ . We have known that this field is invariant under the transformation

$$\phi \rightarrow \phi' = e^{i\gamma} \phi$$

for a real number γ . Its ground state, i.e., the *vacuum state* ϕ_0 appearing in points with minimal potential, namely,

$$\frac{\partial V}{\partial \phi^\dagger} = m^2 \phi + 2\lambda \phi (\phi^\dagger \phi) = 0. \tag{7-105}$$

If $m^2 > 0$, the minimal point appears at $\phi = \phi^\dagger = 0$. The solution of equation (7-105) is unique. Whence, its vacuum state is unique.

If $m^2 < 0$, the potential surface is a U-shape shown in Fig.7.4.1 and the minimal points appear at

$$|\phi|^2 = -\frac{m^2}{2\lambda} = a^2, \quad \lambda > 0,$$

i.e., $|\phi| = a$. The equation (7 – 105) has infinite many solutions. But the exact vacuum state is only one of them, i.e., the gauge symmetry is broken, there are no gauge symmetry in this case. Such field is called *Higgs field*. Its correspondent particle is called *Higgs particle*.

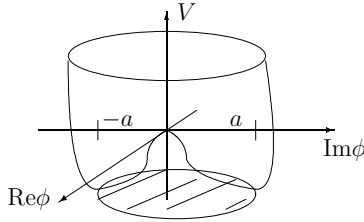

Fig.7.4.1

One can only observe the excitation on its average value a of a field by experiment. So we can write

$$\phi(\vec{x}) = a + \frac{1}{\sqrt{2}}(h(\vec{x}) + i\rho(\vec{x})), \tag{7 – 106}$$

where, by using the Dirac's vector notation

$$\langle v| = (v_1, v_2, \dots), \quad |v\rangle = (v_1, v_2, \dots)^t$$

and

$$\langle v| \cdot |u\rangle = (v_1, v_2, \dots) \cdot \begin{pmatrix} u_1 \\ u_2 \\ \vdots \end{pmatrix} = v_1u_1 + v_2u_2 + \dots = \langle v|u\rangle,$$

there is $\langle 0|h|0\rangle = \langle 0|\rho|0\rangle = 0$, i.e., $h(\vec{x})$, $\rho(\vec{x})$ can be observed by experiment. Substitute this into the formula of \mathcal{L} , we get that

$$\mathcal{L} = \frac{1}{2}(\partial_\mu h)^2 + \frac{1}{2}(\partial_\mu \rho)^2 - \lambda v^2 h^2 - \lambda v h(h^2 + \rho^2) - \frac{\lambda}{4}(h^2 + \rho^2)^2$$

with $v = \sqrt{2}a$. By this formula, we know that the field h has mass $\sqrt{2\lambda}v$, a direct ratio of a , also a field ρ without mass, called *Goldstone particle*.

Now we consider the symmetry broken of local gauge fields following.

Abelian Gauge Field. Consider a complex scalar field ϕ^4 . Its Lagrange density is

$$\begin{aligned} \mathcal{L} &= (\partial_\mu - igA_\mu)\phi^\dagger(\partial^\mu + igA^\mu)\phi - m^2\phi^\dagger\phi - \lambda(\phi^\dagger\phi)^2 - \frac{1}{4}F_{\mu\nu}F^{\mu\nu} \\ &= \partial_\mu\phi^\dagger\partial^\mu\phi - m^2\phi^\dagger\phi - \lambda(\phi^\dagger\phi)^2 - ig\phi^\dagger\overleftrightarrow{\partial}_\mu\phi A^\mu + g^2\phi^\dagger\phi A_\mu A^\mu - \frac{1}{4}F_{\mu\nu}F^{\mu\nu}, \end{aligned}$$

where A_μ is an Abelian gauge field, $F_{\mu\nu} = \partial_\mu A_\nu - \partial_\nu A_\mu$ and $\overleftrightarrow{\partial}_\mu$ is determined by

$$A \overleftrightarrow{\partial}_\mu B = A \frac{\partial B}{\partial x^\mu} - \frac{\partial A}{\partial x^\mu}$$

with formulae following hold

$$\begin{aligned} A \overleftrightarrow{\partial}_\mu (B + C) &= A \overleftrightarrow{\partial}_\mu B + A \overleftrightarrow{\partial}_\mu C, \\ (A + B) \overleftrightarrow{\partial}_\mu C &= A \overleftrightarrow{\partial}_\mu C + B \overleftrightarrow{\partial}_\mu C, \\ A \overleftrightarrow{\partial}_\mu B &= -B \overleftrightarrow{\partial}_\mu A, \\ A \overleftrightarrow{\partial}_\mu A &= 0. \end{aligned}$$

Choose the vacuum state ϕ in (7 – 106) and neglect the constant term. We have that

$$\begin{aligned} \mathcal{L} &= \frac{1}{2}(\partial_\mu h)^2 + \frac{1}{2}(\partial_\mu \rho)^2 - \lambda v^2 h^2 - \frac{1}{4}F_{\mu\nu}F^{\mu\nu} + \frac{1}{2}g^2 v^2 A_\mu A^\mu \\ &\quad - \lambda v h(h^2 + \rho^2) - \frac{\lambda}{4}(h^2 + \rho^2)^2 + gv\partial_\mu \rho A^\mu \\ &\quad + gh \overleftrightarrow{\partial}_\mu \rho A^\mu + g^2 v h A_\mu A^\mu + \frac{1}{2}g^2(h^2 + \rho^2)A_\mu A^\mu. \end{aligned}$$

Here, the first row arises in the fields h , ρ and the gauge field A_μ , and the last two rows arise in the self-interactions in h , ρ and their interaction with A_μ . In this case, the gauge field acquired a mass gv .

In the case of *unitary gauge*, i.e., $\rho = 0$ in the gauge transformation $\phi \rightarrow e^{i\gamma(\vec{\Phi})}$. Then the Lagrange density turns into

$$\begin{aligned} \mathcal{L} &= -\frac{1}{4}F_{\mu\nu}F^{\mu\nu} + \frac{1}{2}g^2 v^2 A_\mu A^\mu + \frac{1}{2}(\partial_\mu h)^2 - \lambda v^2 h^2 \\ &\quad - \lambda v h^3 - \frac{1}{4}\lambda h^4 + g^2 v h A_\mu A^\mu + \frac{1}{2}g^2 h^2 A_\mu A^\mu. \end{aligned}$$

Whence, there are only gauge A^μ and Higgs, but without Goldstone's particles in a unitary gauge field.

Non-Abelian Gauge Field. Consider an isospin doublet $\psi = \begin{pmatrix} \psi_1 \\ \psi_2 \end{pmatrix}$ gauge field under local $SU(2)$ transformations. Its Lagrange density is

$$\mathcal{L} = (D_\mu \phi)^\dagger D^\mu \phi - m^2 \phi^\dagger \phi - \lambda (\phi^\dagger \phi)^2 - \frac{1}{4} F_{\mu\nu}^i F^{i\mu\nu}.$$

For $m^2 < 0$, the vacuum state is in

$$\langle 0 | \phi^\dagger \phi | 0 \rangle = -\frac{m^2}{2\lambda} = a^2.$$

Now $\phi_1 = \chi_1 + i\chi_2$ and $\phi_2 = \chi_3 + i\chi_4$. Therefore,

$$\phi^\dagger \phi = \chi_1^2 + \chi_2^2 + \chi_3^2 + \chi_4^2,$$

a sphere of radius a in the space of dimension 4. Now we can choose the vacuum state

$$\phi(\bar{x}) = \frac{1}{\sqrt{2}} \begin{bmatrix} 0 \\ v + h(\bar{x}) \end{bmatrix}.$$

Calculations show that

$$V = m^2 \phi^\dagger \phi + \lambda (\phi^\dagger \phi)^2 = \lambda (\phi^\dagger \phi) (\phi^\dagger \phi - v^2) = \frac{\lambda}{4} ((h^2 + 2vh)^2 - v^4),$$

$$\begin{aligned} (D_\mu \phi)^\dagger D^\mu \phi &= \partial_\mu \phi^\dagger \partial^\mu \phi + ig \partial_\mu \phi^\dagger A^\mu \phi - ig \phi^\dagger A_\mu \partial^\mu \phi + g^2 \phi^\dagger A_\mu A^\mu \phi \\ &= \frac{1}{2} (\partial_\mu h)^2 + \frac{1}{2} g^2 (v + h)^2 A_\mu A^\mu. \end{aligned}$$

Whence, we get its Lagrange density to be

$$\begin{aligned} \mathcal{L} &= -\frac{1}{4} F_{\mu\nu}^i F^{i\mu\nu} + \frac{1}{2} g^2 v^2 A_\mu A^\mu + \frac{1}{2} (\partial_\mu h)^2 - \lambda v^2 h^2 \\ &\quad - \lambda v h^3 - \frac{1}{4} \lambda h^4 + g^2 v h A_\mu A^\mu + \frac{1}{2} g^2 h^2 A_\mu A^\mu + \frac{1}{4} \lambda v^4, \end{aligned}$$

where the first row arises in the coupling of the gauge and Higgs particles and in the second row, the first two terms arise in the coupling of Higgs particle, the third and fourth terms in their coupling with gauge particle.

7.4.7 Geometry of Gauge Field. Geometrically, a gauge basis is nothing but a choice of a local sections of principal bundle $P(M, G)$ and a gauge transformation is a mapping between such sections. We establish such a model for gauge fields in this subsection.

Let $P(M, \mathcal{G})$ be a principal fibre bundle over a manifold M , a spacetime. Then by definition, there is a projection $\pi : P \rightarrow M$ and a Lie-group \mathcal{G} acting on P with conditions following hold:

(1) \mathcal{G} acts differentiably on P to the right without fixed point, i.e., $(x, g) \in P \times \mathcal{G} \rightarrow x \circ g \in P$ and $x \circ g = x$ implies that $g = 1_{\mathcal{G}}$;

(2) The projection $\pi : P \rightarrow M$ is differentiably onto and each fiber $\pi^{-1}(x) = \{p \circ g | g \in \mathcal{G}, \pi(p) = x\}$ is a closed submanifold of P for $x \in M$;

(3) For $x \in M$, there is a local trivialization, also called a *choice of gauge* T_u of P over M , i.e., any $x \in M$ has a neighborhood U_x and a diffeomorphism $T_u : \pi^{-1}(U_x) \rightarrow U_x \times \mathcal{G}$ with $T_u(p) = (\pi(p), s_u(p))$ such that

$$s_u : \pi^{-1}(U_x) \rightarrow \mathcal{G}, \quad s_u(pg) = s_u(p)g$$

for $\forall g \in \mathcal{G}, p \in \pi^{-1}(U_x)$.

By definition, a principal fibre bundle $P(M, \mathcal{G})$ is \mathcal{G} -invariant. So we can view it to be a gauge field and find its potential and strength in mathematics. Let ω be the connection 1-form, $\Omega = d\omega$ the curvature 2-form of a connection on $P(M, \mathcal{G})$ and $s : M \rightarrow P, \pi \circ s = \text{id}_M$ be a local cross section of $P(M, \mathcal{G})$. Consider

$$A = s^*\omega = \sum_{\mu} A_{\mu} dx^{\mu} \in F^1(M^4), \tag{7-107}$$

$$F = s^*\Omega = \sum F_{\mu\nu} dx^{\mu} \wedge dx^{\nu} \in F^2(M^4), \quad dF = 0. \tag{7-108}$$

Then we identify forms in (7-107) and (7-108) with the *gauge potential* and *field strength*, respectively.

Let $\Lambda : M \rightarrow \mathbf{R}$ and $s' : M \rightarrow P, s'(\bar{x}) = e^{i\Lambda(\bar{x})} s(\bar{x})$. If $A' = s'^*\omega$, then we have

$$\omega'(X) = g^{-1}\omega(X')g + g^{-1}dg, \quad g \in \mathcal{G}, \quad dg \in T_g(\mathcal{G}), \quad X = dR_g X', \tag{7-109}$$

which yields that

$$A' = A + dA, \quad dF' = dF.$$

We explain the gauge fields discussed in this section are special forms of this model, particularly, the Maxwell and Yang-Mills $SU(2)$ gauge fields and the essentially mathematical meaning of spontaneous symmetry broken following.

Maxwell Gauge Field ψ . $\dim M = 4$ and $G = SO(2)$

Notice that $SO(2)$ is the group of rotations in the plane which leaves a plane vector $\bar{v}^2 = \bar{v} \cdot \bar{v}^t$ invariant. Any irreducible representation of $SO(2) = S^1$ and equivalent to one of the unitary representation $\varphi_n : S^1 \rightarrow S^1$ by $\varphi_n(z) = z^n$ for $\forall z \in S^1$. In this case, any section of $P(M, SO(2))$ can be represented by a mapping $s(ez) = z^{-n}$ for $e \in P, z \in S^1$.

Consider the 1-form A as the local principal gauge potential of an invariant connection on a principal $U(1)$ -bundle and the electromagnetic 2-form F as its curvature. We have shown in Subsection 7.3.4 that Maxwell field is determined by equations $\partial_\mu F^{\mu\nu} = \mu_0 j^\nu$ with the Jacobi identity. Let $\Psi : M \rightarrow \mathbf{C}^2$ be the pull-back of ψ by a section $s : \Psi = \psi s = s^* \psi$. Then it is a gauge transformation of ψ .

Yang-Mills Field. The *Yang-Mills potentials* $A^\alpha = A_\mu^\alpha dx^\mu$ give rise to the *Yang-Mills field*

$$B_{\mu\nu}^\alpha = \frac{\partial A_\nu^\alpha}{\partial x^\mu} - \frac{\partial A_\mu^\alpha}{\partial x^\nu} + \frac{1}{2} c_{\rho\sigma}^\alpha (A_\mu^\rho A_\nu^\sigma - A_\nu^\rho A_\mu^\sigma),$$

where $c_{\rho\sigma}^\alpha$ is determined in $[X_\rho, X_\sigma] = c_{\rho\sigma}^\alpha X_\alpha$. Then

$$A^2 = A_\mu A_\nu d^\mu d^\nu = \frac{1}{2} [A_\mu, A_\nu] dx^\mu dx^\nu.$$

Now the gauge transformation in (7-109) is

$$A \rightarrow A' = UAU^\dagger + U dU^\dagger = UAU^\dagger + U \partial U^\dagger dx^\mu.$$

Whence,

$$dA \rightarrow dA' = dUAU^\dagger + U(dA)U^\dagger - UAdU^\dagger + (dU)dU^\dagger,$$

$$\begin{aligned} A^2 \rightarrow A'^2 &= UA^2U^\dagger + UAdU^\dagger + U(dU^\dagger)UAU^\dagger + U(dU^\dagger)UdU^\dagger \\ &= UA^2U^\dagger + UAdU^\dagger - (dU)AU^\dagger - (dU)du^\dagger. \end{aligned}$$

We finally find that

$$dA + A^2 \rightarrow dA' + A'^2 = U(dA + A^2)U^\dagger,$$

i.e., $F = dA + A^2$ is gauge invariant with local forms

$$F_{\mu\nu} = \partial_\mu A_\nu - \partial_\nu A_\mu + [A_\mu, A_\nu],$$

which is just the $F_{\mu\nu}$ of the Yang-Mills fields by a proper chosen constant iq in A_μ .

Spontaneous Symmetry Broken. Let Φ_0 be the *vacuum state* in a field ψ with the Lagrangian $\mathcal{L} = \mathcal{L}_1 + V(\Phi)$, where $V(\Phi)$ stands for the interaction potential, \mathcal{G} a gauge group and $g \rightarrow \varphi(g)$ a representation of \mathcal{G} . Define

$$M_0 = \varphi(\mathcal{G})\Phi_0 = \{\varphi(g)\Phi_0 | g \in \mathcal{G}\} \tag{7-107}$$

and $\mathcal{G}_{\Phi_0} = \mathcal{G}_0 = \{g \in \mathcal{G} | \varphi(g)\Phi_0 = \Phi_0\}$ is the isotropy subgroup of \mathcal{G} at Φ_0 . Then M_0 is a *homogenous space* of \mathcal{G} , i.e.,

$$M_0 = \mathcal{G}/\mathcal{G}_0 = \{g\mathcal{G}_0 | g \in \mathcal{G}\}. \tag{7-108}$$

Definition 7.4.1 A gauge symmetry \mathcal{G} associated with a Lagrangian field theoretical model \mathcal{L} is said to be *spontaneously broken* if and only if there is a vacuum manifold M_0 defined in (7-108) obtained from a given vacuum state Φ_0 defined in (7-107).

If we require that $V(\Phi_0) = 0$ and $V(\varphi(g)\Phi) = V(\Phi)$, then $V(\varphi(g)\Phi_0) = 0$. Consequently, we can rewrite M_0 as

$$M_0 = \{\Phi | V(\Phi) = 0\}.$$

Generally, one classifies the following cases:

Case 1. $\mathcal{G} = \mathcal{G}_0$

In this case, the gauge symmetry is exact and the vacuum Φ_0 is unique.

Case 2. $1_g \in \mathcal{G}_0 \subset \mathcal{G}$

In this case, the gauge symmetry is partly spontaneously broken.

Case 3. $\mathcal{G} = \{1_g\}$

In this case, the gauge symmetry is completely broken.

Physically, \mathcal{G}_0 is important since it is the exact symmetry group of the field, i.e., the original gauge symmetry \mathcal{G} is broken down to \mathcal{G}_0 by Φ_0 .

For example, let $\mathcal{L} = \mathcal{L}_1 + V(\Phi)$ be an $SO(3)$ -invariant Lagrange density and $V(\Phi) = \frac{1}{2}\mu^2\Phi_i^2 - \frac{1}{4}\lambda(\Phi_i^2)^2$, $\lambda > 0$. Then the necessary conditions for the minimum value of $V(\Phi)$ which characterizes spontaneous symmetry broken requires

$$\left. \frac{\partial V}{\partial \Phi_i} \right|_{\Phi_i = \Phi_i^0} = 0 = \mu^2\Phi_i^2 - \lambda\Phi_i^2\Phi_i \quad \Rightarrow \quad \Phi_i^{02} = \frac{\mu^2}{\lambda}.$$

Whence, the vacuum manifold M_0 of field that minimize the potential $V(\Phi)$ is given by

$$M_0 = S^2 = \left\{ \Phi_i \mid \Phi_i^2 = \frac{\mu^2}{\lambda} \right\},$$

which corresponds to a spontaneous symmetry broken $\mathcal{G} = SO(3) \rightarrow SO(2) = \mathcal{G}_0$. By Definition 7.4.1, we know that

$$M_0 = SO(3)/SO(2) \cong S^2$$

on account of

$$\varphi(g)\Phi_0^\alpha = \Phi_0^\alpha \Leftrightarrow \varphi(g) = \begin{bmatrix} & & 0 \\ & A & 0 \\ 0 & 0 & 1 \end{bmatrix}, \quad A \in SO(2),$$

where $\Phi_0^\alpha = (0, 0, \Phi_0)$, $\Phi_0 = \sqrt{\mu^2/\lambda}$. Consequently, the natural C^∞ -action

$$SO(3) \times S^2 \rightarrow S^2; \quad (g, \Phi) \rightarrow \varphi(g)\Phi; \quad \|\varphi(g)\Phi\| = \|\Phi\| = \sqrt{\frac{\mu^2}{\lambda}}$$

is a transitive transformation.

§7.5 REMARKS

7.5.1 Operator Equation. Let \mathbf{S} , \mathbf{P} be two metric spaces and $\widehat{\mathbf{T}} : \mathbf{S} \rightarrow \mathbf{P}$ a continuous mapping. For $f \in M \subset \mathbf{P}$, the equation

$$\widehat{\mathbf{T}}u = f$$

with some boundary conditions is called an operator equation. Applying the inverse mapping theorem, its solution is generally a manifold constraints on conditions if

M is a manifold. Certainly, those of Weyl's, Dirac's, Maxwell's and Yang-Mills's partially differential equations discussed in this chapter are such equations. In fact, a behavior of fields usually reflects geometrical properties with invariants, particularly, the dynamics behavior of fields. This fact enables us to determine the behavior of a field not dependent on the exact solutions of equations since it is usually difficult to obtain, but on their differentially geometrical properties of manifolds. That is why we survey the gauge fields by principal fibre bundles in Section 7.4.7. Certainly, there are many such works should be carried out on this trend.

7.5.2 Equation of Motion. The combination of the least action principle with the Lagrangian can be used both to the external and internal fields, particularly for determining the equations of motion of a field. More techniques for such ideas can be found in references [Ble1], [Car1], [ChL1], [Wan1], [Sve1], etc. on fields. In fact, the quantum field theory is essentially a theory established on Lagrangian by the least action principle. Certainly, there are many works in this field should be done, both in theoretical and practise, and find the inner motivation in matters.

7.5.3 Gravitational Field. In Newtonian's gravitational theory, the gravitation is transferred by *either* and the action is at a distance, i.e., the action is takes place instantly. Einstein explained the gravitation to be concretely in spacetime, i.e., a character of spacetime, not an external action. This means the central role of Riemannian geometry in Einstein's gravitational theory. Certainly, different metric ds deduces different structure of spacetime, such as those solutions in [Car1] for different metric we can find. *Which is proper for our WORLD?* Usually, one chose the simplest metric, i.e., the Schwarzschild metric and its solutions to explain the nature. *Is it really happens so?*

7.5.4 Electromagnetic Field. The electromagnetic theory is a unified theory of electric and magnetic theory, which turns out the Maxwell equations of electromagnetic field. More materials can be found in [Thi1] and [Wan1]. For establishing a covariant theory for electromagnetic fields, one applies the differential forms and proved that these Maxwell equations can be also included in Euler-Lagrange equations of motion. However, the essence of electromagnetism is still an open problem for human beings, for example, we do not even know its dimension. Certainly, the existent electromagnetic field is attached with a Minkowskian spacetime, i.e.,

4-dimensional. But if we distinct the observed matter in a dimensional 4-space from electromagnetism, we do not even know weather the rest is still a dimensional 4. So the dimension 4 in electromagnetic theory is added by human beings. Then *what is its true color?*

7.5.5 Gauge Field with Interaction. Einstein's principle of covariance means that a physical of external field is independent on the artificially reference frame chosen by human beings. This is essentially a kind of symmetry of external fields. A gauge symmetry is such a generalization for interaction. More results can be found in references [Ble1], [ChL1], [Wan1] and [Sve1]. For its geometry counterpart, the reader is refereed to [Ble1]. Certainly, a gauge symmetry is dependent on its gauge basis. Then how to choose its basis is a fundamental question. *Weather can we find a concise ruler for all gauge fields?* The theory of principal fibre bundles presents such a tool. That is why we can generalize gauge symmetry to combinatorial fields in next chapter.

7.5.6 Unified Field. Many physicists, such as those of Einstein, Weyl, Klein, Veblen, Pauli, Schouten and Thirty, \dots etc. had attempted to constructing a unified field theory, i.e., the gravitational field with quantum field since 1919. Today, we have know an effective theory to unify the gravitational with electromagnetic field, for example, in references [Ble1], [Car1] and [Wes1]. By allowing the increasing of dimensional from 4 to 11, the *String theory* also presents a mathematical technique to unify the gravitational field with quantum field. In next chapter, we will analyze their space structure by combinatorial differential geometry established in Chapters 4–6 and show that we can establish infinite many such unified field theory under the combinatorial notion in Section 2.1. So the main objective for us is to distinguish which is effective and which can be used to our WORLD.

CHAPTER 8.

Combinatorial Fields with Applications

The combinatorial manifold can presents a naturally mathematical model for combinations of fields. This chapter presents a general idea for such works, i.e., *how to establish such a model and how to determine its behavior by its geometrical properties or results on combinatorial manifolds*. For such objectives, we give a combinatorial model for fields with interactions in Section 8.1. Then, we determine the equations of fields in Section 8.2, which are an immediately consequence of Euler-Lagrange equations. It should be noted that the form of equations of combinatorial field is dependent on the Lagrange density $\mathcal{L}_{\tilde{M}}$ with that of fields M_i for integers $1 \leq i \leq m$, in which each kind of equations determine a geometry of combinatorial fields. Notice the spherical symmetric solution of Einstein's field equations in vacuum is well-known. We determine the line element ds of combinatorial gravitational fields in Section 8.3, which is not difficult if all these line elements ds_i , $1 \leq i \leq m$ are known beforehand. By considering the gauge bases and their combination, we initially research in what conditions on gauge bases can bring a combinatorial gauge field in Section 8.4. We also give a way for determining Lagrange density by embedded graphs on surfaces, which includes \mathbf{Z}_2 gauge theory as its conclusion. Applications of combinatorial fields to establishing model of many-body systems are present in Section 8.5, for example, the many-body mechanics, cosmology and physical structure. Besides, this section also establish models for economic fields in general by combinatorial fields, particularly, the circulating economical field, which suggests a quantitative method for such economical systems.

§8.1 COMBINATORIAL FIELDS

8.1.1 Combinatorial Field. The multi-laterality of WORLD implies the combinatorial fields in discussion. A *combinatorial field* \mathcal{C} consists of fields C_1, C_2, \dots, C_n with interactions between C_i and C_j for some integers $i, j, 1 \leq i \neq j \leq n$. Two combinatorial fields are shown in Fig.8.1.1, where in (a) each pair $\{C_i, C_j\}$ has interaction for integers $1 \leq i \neq j \leq 4$, but in (b) only pair $\{C_i, C_{i+1}\}$ has interaction, $i, i + 1 \equiv (\text{mod}4)$.

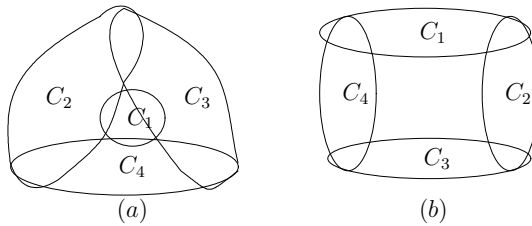

Fig. 8.1.1

Such combinatorial fields with interactions are widely existing. For example, let C_1, C_2, \dots, C_n be n electric fields $\mathbf{E}_1^{stat}, \mathbf{E}_2^{stat}, \dots, \mathbf{E}_n^{stat}$. Then it is a electrically combinatorial field with interactions. A combinatorial field \mathcal{C} naturally induces a *multi-action* \mathcal{S} . For example, let $\mathbf{F}_{\mathbf{E}_i \mathbf{E}_j}$ be the force action between $\mathbf{E}_i, \mathbf{E}_j$. We immediately get a multi-action $\mathcal{S} = \cup_{i,j} \mathbf{F}_{\mathbf{E}_i \mathbf{E}_j}$ between $\mathbf{E}_1^{stat}, \mathbf{E}_2^{stat}, \dots, \mathbf{E}_n^{stat}$. The two multi-actions induced by combinatorial fields in Fig.8.1.1 are shown in Fig.8.1.2.

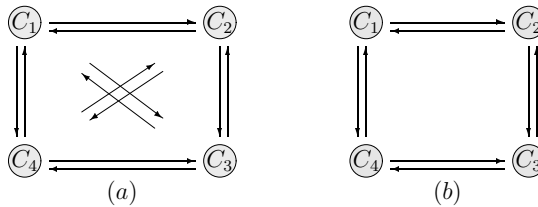

Fig. 8.1.2

In fact, all things in our WORLD are local or global combinatorial fields. The question now is *how can we characterize such systems by mathematics?*

Notice that an action \vec{A} always appears with an anti-action \overleftarrow{A} . Consequently, such a pair of action can be denoted by an edge $\vec{A}\overleftarrow{A}$. This fact enables us to define a vertex-edge labeled graph $G^L[\mathcal{C}]$ for a combinatorial field \mathcal{C} by

$$V(G^L[\mathcal{C}]) = \{v_1, v_2, \dots, v_n\},$$

$$E(G^L[\mathcal{C}]) = \{v_i v_j \mid \exists \vec{C}_i \overleftarrow{C}_j \text{ between } C_i \text{ and } C_j \text{ for } 1 \leq i \neq j \leq n\}$$

with labels

$$\theta_L(v_i) = C_i, \quad \theta_L(v_i v_j) = \vec{C}_i \overleftarrow{C}_j.$$

For example, the vertex-edge labeled graphs correspondent to combinatorial fields in Fig.8.1.1 are shown in Fig.8.1.3, in where the vertex-edge labeled graphs in (a), (b) are respectively correspondent to the combinatorial field (a) or (b) in Fig.8.1.1.

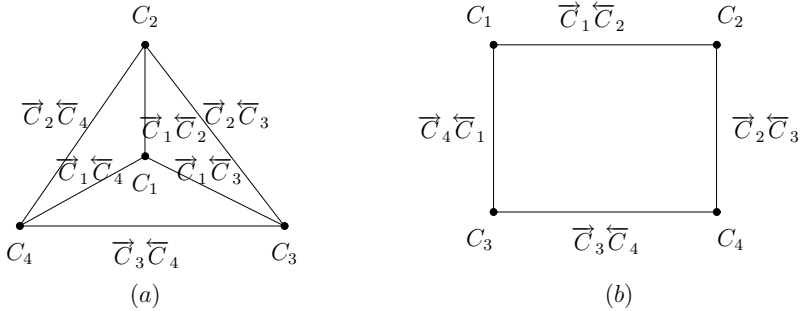

Fig.8.1.3

We have know that a field maybe changes dependent on times in the last chapter. Certainly, a combinatorial field maybe also varies on times. In this case, a combinatorial field \mathcal{C} is functional of the times t_1, t_2, \dots, t_n , where t_i is the time parameter of the field C_i for $1 \leq i \leq n$, denoted by $\mathcal{C}(t_1, t_2, \dots, t_n)$. If there exists a mapping T transfers each time parameter t_i , $1 \leq i \leq n$ to one time parameter t , i.e., there is a time parameter t for fields C_1, C_2, \dots, C_n , we denote such a combinatorial field by $\mathcal{C}(t)$. Correspondingly, its vertex-edge labeled graph denoted by $G^L[\mathcal{C}(t_1, t_2, \dots, t_n)]$ or $G^L[\mathcal{C}(t)]$.

We classify actions \vec{A} between fields C_1 and C_2 by the dimensions of action spaces $C_1 \cap C_2$. An action \vec{A} is called a k -dimensional action if $\dim(C_1 \cap C_2) = k$

for an integer $k \geq 1$. Generally, if $\dim(C_1 \cap C_2) = 0$, there are no actions between C_1 and C_2 , and one can only observe 3-dimensional actions. So we need first to research the structure of configuration space for combinatorial fields.

8.1.2 Combinatorial Configuration Space. As we have shown in Chapter 7, a field can be presented by its a state function $\psi(\vec{x})$ in a reference frame $\{\vec{x}\}$, and characterized by partially differential equations, such as those of the following:

$$\begin{aligned} \text{Scalar field:} & \quad (\partial^2 + m^2)\psi = 0, \\ \text{Weyl field:} & \quad \partial_0\psi = \pm\sigma^i\partial_i\psi, \\ \text{Dirac field:} & \quad (i\gamma^\mu\partial_\mu - m)\psi = 0, \end{aligned}$$

These configuration spaces are all the Minkowskian. Then *what can we do for combinatorial fields?* Considering the character of fields, a natural way is to characterize each field C_i , $1 \leq i \leq n$ of them by itself reference frame $\{\vec{x}\}$. Consequently, we get a combinatorial configuration space, i.e., a combinatorial Euclidean space for combinatorial fields. This enables us to classify combinatorial fields of C_1, C_2, \dots, C_n into two categories:

Type I. $n = 1$.

In this category, the external actions between fields are all the same. We establish principles following on actions between fields.

Action Principle of Fields. *There are always exist an action \vec{A} between two fields C_1 and C_2 of a Type I combinatorial field, i.e., $\dim(C_1 \cap C_2) \geq 1$.*

Infinite Principle of Action. *An action between two fields in a Type I combinatorial field can be found at any point on a spatial direction in their intersection.*

Applying these principles enables us to know that if the configuration spaces C_1, C_2, \dots, C_n are respective $\mathbf{R}_1^4 = (ict_1, x_1, y_1, z_1)$, $\mathbf{R}_2^4 = (ict_2, x_2, y_2, z_2)$, \dots , $\mathbf{R}_n^4 = (ict_n, x_n, y_n, z_n)$, then the configuration space $\mathcal{C}(t_1, t_2, \dots, t_n)$ of C_1, C_2, \dots, C_n is a combinatorial Euclidean space $\mathcal{E}_G(4)$. Particularly, if $\mathbf{R}_1^4 = \mathbf{R}_2^4 = \dots = \mathbf{R}_n^4 = \mathbf{R}^4 = (ict, x, y, z)$, the configuration space $\mathcal{C}(t)$ is still $\mathbf{R}^4 = (ict, x, y, z)$. Notice that the underlying graph of $\mathcal{E}_G(4)$ is K_n . According to Theorems 4.1.2 and 4.1.4, we know the maximum dimension of \mathcal{C} to be $3n + 1$ and the minimum dimension

$$\dim_{\min} \mathcal{C} = 4 + s,$$

where the integer $s \geq 0$ is determined by

$$\binom{r+s-1}{r} < n \leq \binom{r+s}{r}.$$

Now if we can establish a time parameter t for all fields C_1, C_2, \dots, C_n , then Theorems 4.1.2 and 4.1.5 imply the maximum dimension $2n + 2$ and the minimum dimension

$$\dim_{\min} \mathcal{C} = \begin{cases} 4, & \text{if } n = 1, \\ 5, & \text{if } 2 \leq n \leq 4, \\ 6, & \text{if } 5 \leq n \leq 10, \\ 3 + \lceil \sqrt{n} \rceil, & \text{if } n \geq 11. \end{cases}$$

of $\mathcal{C}(t)$. In this case, the action on a field C_i comes from all other fields $C_j, j \neq i, 1 \leq j \leq n$ in a combinatorial field $\mathcal{C}(t)$, which can be depicted as in Fig.8.1.4.

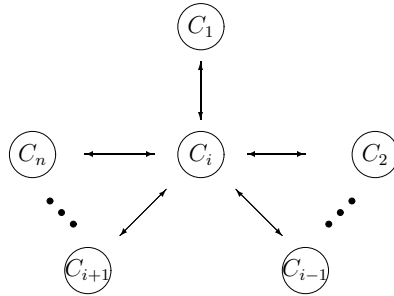

Fig.8.1.4

Therefore, there are always exist an action between fields C_i and C_j for any integers $i, j, 1 \leq i, j \leq n$ in Type I combinatorial fields. However, if $\vec{A} \approx 0$, i.e., there are asymptotically no actions between C_i and C_j for any integers $i, j, 1 \leq i, j \leq n$ in consideration, the combinatorial field $\mathcal{C}(t)$ is called to be *free*, which can be characterized immediately by equation systems of these fields.

Let the reference frames of field C_i be $\{ict, x_{i1}, x_{i2}, x_{i3}\}$ for $1 \leq i \leq n$ with $\{x_{i1}, x_{i2}, x_{i3}\} \cap \{x_{j1}, x_{j2}, x_{j3}\} \neq \emptyset$ for $1 \leq i \neq j \leq n$. Then we can characterize

a Type *I* combinatorial free-field $\mathcal{C}(t)$ of scalar fields, Weyl fields or Dirac fields C_1, C_2, \dots, C_n by partially differential equation system as follows:

Combinatorial Scalar Free-Fields:

$$\begin{aligned}
 (\partial^2 + m_1^2)\psi(ict, x_{11}, x_{12}, x_{13}) &= 0, \\
 (\partial^2 + m_2^2)\psi(ict, x_{21}, x_{22}, x_{23}) &= 0, \\
 \dots\dots\dots, \\
 (\partial^2 + m_n^2)\psi(ict, x_{n1}, x_{n2}, x_{n3}) &= 0.
 \end{aligned}$$

Combinatorial Weyl Free-Field:

$$\begin{aligned}
 \partial_0\psi(ict, x_{11}, x_{12}, x_{13}) &= \pm\sigma^i\partial_i\psi(ict, x_{11}, x_{12}, x_{13}), \\
 \partial_0\psi(ict, x_{21}, x_{22}, x_{23}) &= \pm\sigma^i\partial_i\psi(ict, x_{21}, x_{22}, x_{23}), \\
 \dots\dots\dots, \\
 \partial_0\psi(ict, x_{n1}, x_{n2}, x_{n3}) &= \pm\sigma^i\partial_i\psi(ict, x_{n1}, x_{n2}, x_{n3}).
 \end{aligned}$$

Combinatorial Dirac Free-Field:

$$\begin{aligned}
 (i\gamma^\mu\partial_\mu - m_1)\psi(ict, x_{11}, x_{12}, x_{13}) &= 0, \\
 (i\gamma^\mu\partial_\mu - m_2)\psi(ict, x_{21}, x_{22}, x_{23}) &= 0, \\
 \dots\dots\dots, \\
 (i\gamma^\mu\partial_\mu - m_n)\psi(ict, x_{n1}, x_{n2}, x_{n3}) &= 0.
 \end{aligned}$$

Type II. $n \geq 2$.

In this category, the external actions between fields are multi-actions and $0 \leq \dim(C_1 \cap C_2) \leq \min\{\dim C_1, \dim C_2\}$, i.e., there maybe exists or non-exists actions between fields in a Type *II* combinatorial field.

Let $\Omega_i = \{ict, x_{i1}, x_{i2}, x_{i3}\}$ be the domain of field C_i for $1 \leq i \leq n$ with $\{x_{i1}, x_{i2}, x_{i3}\} \cap \{x_{j1}, x_{j2}, x_{j3}\} \neq \emptyset$ for some integers $1 \leq i \neq j \leq n$. Similar to Type *I* combinatorial free-fields, we can also characterize a Type *II* combinatorial free-field $\mathcal{C}(t)$ of scalar fields, Weyl fields and Dirac fields C_1, C_2, \dots, C_n by partially differential equation system as follows:

$$(\partial^2 + m_1^2)\psi(ict, x_{11}, x_{12}, x_{13}) = 0,$$

$$\begin{aligned}
 &(\partial^2 + m_2^2)\psi(ict, x_{21}, x_{22}, x_{23}) = 0, \\
 &\dots\dots\dots, \\
 &(\partial^2 + m_k^2)\psi(ict, x_{k1}, x_{k2}, x_{k3}) = 0. \\
 &\partial_0\psi(ict, x_{(k+1)1}, x_{(k+1)2}, x_{(k+1)3}) = \pm\sigma^i\partial_i\psi(ict, x_{(k+1)1}, x_{(k+1)2}, x_{(k+1)3}), \\
 &\partial_0\psi(ict, x_{(k+2)1}, x_{(k+2)2}, x_{(k+2)3}) = \pm\sigma^i\partial_i\psi(ict, x_{(k+2)1}, x_{(k+2)2}, x_{(k+2)3}), \\
 &\dots\dots\dots, \\
 &\partial_0\psi(ict, x_{l1}, x_{l2}, x_{l3}) = \pm\sigma^i\partial_i\psi(ict, x_{l1}, x_{l2}, x_{l3}). \\
 &(i\gamma^\mu\partial_\mu - m_{l+1})\psi(ict, x_{(l+1)1}, x_{(l+1)2}, x_{(l+1)3}) = 0, \\
 &(i\gamma^\mu\partial_\mu - m_{l+2})\psi(ict, x_{(l+2)1}, x_{(l+2)2}, x_{(l+2)3}) = 0, \\
 &\dots\dots\dots, \\
 &(i\gamma^\mu\partial_\mu - m_n)\psi(ict, x_{n1}, x_{n2}, x_{n3}) = 0.
 \end{aligned}$$

In this combinatorial field, there are respective complete subgraphs K_k, K_{l-k+1} and K_{n-l+1} in its underlying graph $G^L[\mathcal{C}(t)]$.

8.1.3 Geometry on Combinatorial Field. In the view of experiment, we can only observe behavior of particles in the field where we live, and get a multi-information in a combinatorial reference frame. So it is important to establish a geometrical model for combinatorial fields.

Notice that each configuration space in last subsection is in fact a combinatorial manifold. This fact enables us to introduce a geometrical model on combinatorial manifold for a combinatorial field $\mathcal{C}(t)$ following:

(i) A configuration space $\widetilde{M}(n_1, \dots, n_m)$, i.e., a combinatorial differentiable manifold of manifolds $M^{n_1}, M^{n_2}, \dots, M^{n_m}$;

(ii) A chosen geometrical structure Ω on the vector field $T\widetilde{M}$ and a differentiable energy function $\mathbf{T} : \widetilde{M} \times T\widetilde{M} \rightarrow \mathbf{R}$, i.e., the combinatorial Riemannian metric on $T\widetilde{M}$ determined by

$$\mathbf{T} = \frac{1}{2} \langle \bar{v}, \bar{v} \rangle, \quad \bar{v} \in T\widetilde{M};$$

(iii) A force field given by a 1-form

$$\omega = \sum_{\mu,\nu} \omega^{\mu\nu} dx_{\mu\nu} = \omega^{\mu\nu} dx_{\mu\nu}.$$

This model establishes the the dynamics on a combinatorial field, which enables us to apply results in Chapters 4 – 6, i.e., combinatorial differential geometry for characterizing the behaviors of combinatorial fields, such as those of tensor fields $T_s^r(\widetilde{M})$, k -forms $\Lambda^k(\widetilde{M})$, exterior differentiation $\tilde{d} : \Lambda(\widetilde{M}) \rightarrow \Lambda(\widetilde{M})$ connections \tilde{D} , Lie multi-groups \mathcal{L}_G and principle fibre bundles $\tilde{P}(\widetilde{M}, \mathcal{L}_G)$, \dots , etc. on combinatorial Riemannian manifolds. Whence, we can apply the Einstein’s covariance principle to construct equations of combinatorial manifolds, i.e., tensor equations on its correspondent combinatorial manifold \widetilde{M} of a combinatorial field, where $G^L[\widetilde{M}]$ maybe any connected graph.

For example, we have known the interaction equations of gravitational field, Maxwell field and Yang-Mills field are as follows:

Gravitational field: $R_{\mu\nu} - \frac{1}{2}g_{\mu\nu}R = \kappa T_{\mu\nu},$

Maxwell field: $\partial_\mu F^{\mu\nu} = 0 \text{ and } \partial_\kappa F_{\mu\nu} + \partial_\mu F_{\nu\kappa} + \partial_\nu F_{\kappa\mu} = 0,$

Yang-Mills field: $D^\mu F_{\mu\nu}^a = 0 \text{ and } D_\kappa F_{\mu\nu}^a + D_\mu F_{\nu\kappa}^a + D_\nu F_{\kappa\mu}^a = 0.$

Whence, we can characterize the behavior of combinatorial fields by equations of connection, curvature tensors, metric tensors, \dots with a form following:

$$\mathcal{F}_{(\mu_1\nu_1)\dots(\mu_s\nu_s)}^{(\kappa_1\lambda_1)\dots(\kappa_r\lambda_r)} = 0.$$

Notice we can only observe behavior of particles in \mathbf{R}^4 in practice. So considering the tensor equation

$$\mathcal{F}_{(\mu_1\nu_1)(\mu_2\nu_2)}^{(\kappa_1\lambda_1)(\kappa_2\lambda_2)} = 0.$$

of type (2, 2) is enough in consideration.

8.1.4 Covariance Principle in Combinatorial Field. As we known, there are two kind of *anthropic principles* following:

Weak Anthropic Principle *All observations of human beings on the WORLD are limited by our survival conditions.*

This principle also alluded by an ancient Chinese philosopher LAO ZI in his

book TAO TEH KING by words that *all things we can acknowledge is determined by our eyes, or ears, or nose, or tongue, or body or passions, i.e., these six organs.* In other words, with the help of developing technology, we can only extend our recognized scope. This recognizing process is endless. So an asymptotic result on the WORLD with a proper precision is enough for various applications of human beings.

Strong Anthropic Principle *The born of life is essentially originated in the characterization of WORLD at sometimes.*

This principle means that the born of human beings is not accidental, but inevitable in the WORLD. Whence, there is a deep regulation of WORLD which forces the human being come into being. In other words, one can finds that regulation and then finally recognizes the whole WORLD, i.e., life appeared in the WORLD is a definite conclusion of this regulation. So one wishes to find that regulation by mathematics, for instance the *Theory of Everything*.

It should be noted that one can only observes unilateral results on the WORLD, alluded also in the mortal of the proverb of six blind men and an elephant. Whence, each observation is meaningful only in a particular reference frame. But the Einstein’s general relativity theory essentially means that a physical law is independent on the reference frame adopted by a researcher. That is why we need combinatorial tensor equations to characterize a physical law in a combinatorial field. For determining the behavior of combinatorial fields, we need the *projective principle* following, which is an extension of Einstein’s covariance principle to combinatorial fields.

Projective Principle *A physics law in a combinatorial field is invariant under a projection on its a field.*

By combinatorial differential geometry established in Chapters 4 – 6, this principle can be rephrase as follows.

Projective Principle *Let $(\widetilde{M}, g, \widetilde{D})$ be a combinatorial Riemannian manifold and $\mathcal{F} \in T_s^r(\widetilde{M})$ with a local form $\mathcal{F}_{(\mu_1\nu_1)\dots(\mu_s\nu_s)}^{(\kappa_1\lambda_1)\dots(\kappa_r\lambda_r)} e_{\kappa_1\lambda_1} \otimes \dots \otimes e_{\kappa_r\lambda_r} \omega^{\mu_1\nu_1} \otimes \dots \otimes \omega^{\mu_s\nu_s}$ in $(U_p, [\varphi_p])$. If*

$$\mathcal{F}_{(\mu_1\nu_1)\dots(\mu_s\nu_s)}^{(\kappa_1\lambda_1)\dots(\kappa_r\lambda_r)} = 0$$

for integers $1 \leq \mu_i \leq s(p), 1 \leq \nu_i \leq n_{\mu_i}$ with $1 \leq i \leq s$ and $1 \leq \kappa_j \leq s(p), 1 \leq \lambda_j \leq n_{\kappa_j}$ with $1 \leq j \leq r$, then for any integer $\mu, 1 \leq \mu \leq s(p)$, there must be

$$\mathcal{F}_{(\mu\nu_1)\dots(\mu\nu_s)}^{(\mu\lambda_1)\dots(\mu\lambda_r)} = 0$$

for integers $\nu_i, 1 \leq \nu_i \leq n_{\mu}$ with $1 \leq i \leq s$.

Applying this projective principle enables us to find solutions of combinatorial tensor equation characterizing a combinatorial field underlying a combinatorial structure G in follows sections.

§8.2 EQUATION OF COMBINATORIAL FIELD

8.2.1 Lagrangian on Combinatorial Field. For establishing these motion equations of a combinatorial field $\mathcal{C}(t)$, we need to determine its Lagrangian density first. Generally, this Lagrange density can be constructed by applying properties of its vertex-edge labeled graph $G^L[\mathcal{C}(t)]$ for our objective. Applying Theorem 4.2.4, we can formally present this problem following.

Problem 8.2.1 Let $G^L[\widetilde{M}]$ be a vertex-edge labeled graph of a combinatorial manifold \widetilde{M} consisting of n manifolds M_1, M_2, \dots, M_n with labels

$$\theta_L : V(G^L[\widetilde{M}]) \rightarrow \{\mathcal{L}_{M_i}, 1 \leq i \leq n\},$$

$$\theta_L : E(G^L[\widetilde{M}]) \rightarrow \{\mathcal{T}_{ij} \text{ for } \forall(M_i, M_j) \in E(G^L[\widetilde{M}])\},$$

where $\mathcal{L}_{M_i} : TM_i \rightarrow \mathbf{R}, \mathcal{T}_{ij} : T(M_i \cap M_j) \rightarrow \mathbf{R}$. Construct a function

$$\mathcal{L}_{G^L[\widetilde{M}]} : G^L[\widetilde{M}] \rightarrow \mathbf{R}$$

such that $G^L[\widetilde{M}]$ is invariant under the projection of $\mathcal{L}_{G^L[\widetilde{M}]}$ on M_i for $1 \leq i \leq n$.

There are many ways for constructing the function $\mathcal{L}_{G^L[\widetilde{M}]}$ under conditions in Problem 8.2.1. If $\mathcal{L}_{G^L[\widetilde{M}]}$ is a homogeneous polynomial of degree l , let $\mathcal{K}_H(\mathcal{L}, \mathcal{T})$ be an algebraic linear space generated by homogeneous polynomials of $\mathcal{L}_{M_i}, \mathcal{T}_{ij}$ of degree l over field \mathbf{R} for $1 \leq i, j \leq n$. Then $\mathcal{L}_{G^L[\widetilde{M}]} \in \mathcal{K}_H(\mathcal{L}, \mathcal{T})$ in this case. By elements in $\mathcal{K}_H(\mathcal{L}, \mathcal{T})$, we obtain various Lagrange density. However, we only classify these $\mathcal{L}_{G^L[\widetilde{M}]}$ by linearity or non-linearity for consideration following.

Case 1. *Linear*

In this case, the general expression of the Lagrange density $\mathcal{L}_{G^L[\widetilde{M}]}$ is

$$\mathcal{L}_{G^L[\widetilde{M}]} = \sum_{i=1}^n a_i \mathcal{L}_{M_i} + \sum_{(M_i, M_j) \in E(G^L[\widetilde{M}])} b_{ij} \mathcal{F}_{ij} + C,$$

where a_i , b_{ij} and C are undetermined coefficients in \mathbf{R} . Consider the projection $\mathcal{L}|_{M_i}$ of $\mathcal{L}_{G^L[\widetilde{M}]}$ on M_i , $1 \leq i \leq n$. We get that

$$\mathcal{L}_{G^L[\widetilde{M}]}|_{M_i} = a_i \mathcal{L}_{M_i} + \sum_{(M_i, M_j) \in E(G^L[\widetilde{M}])} b_{ij} \mathcal{F}_{ij} + C.$$

Let $a_i = 1$ and $b_{ij} = 1$ for $1 \leq i, j \leq n$ and

$$\mathcal{L}_{int}^i = \mathcal{L}_{M_i}, \quad \mathcal{L}_{ext}^i = \sum_{(M_i, M_j) \in E(G^L[\widetilde{M}])} \mathcal{F}_{ij} + C.$$

Then we know that

$$\mathcal{L}_{G^L[\widetilde{M}]}|_{M_i} = \mathcal{L}_{int}^i + \mathcal{L}_{ext}^i,$$

i.e., the projection $\mathcal{L}|_{M_i}$ of $\mathcal{L}_{G^L[\widetilde{M}]}$ on field M_i consists of two parts. The first comes from the interaction \mathcal{L}_i in field M_i and the second comes from the external action \mathcal{L}_{ext}^i from fields M_j to M_i for $\forall (M_i, M_j) \in E(G^L[\widetilde{M}])$, which also means that external actions \mathcal{L}_{ext}^i between fields M_i, M_j for $\forall (M_i, M_j) \in E(G^L[\widetilde{M}])$ are transferred to an interaction of the combinatorial field $\mathcal{C}(t)$.

If we choose $a_i = 1$ but $b_{ij} = -1$ for $1 \leq i, j \leq n$, then

$$\mathcal{L}_{G^L[\widetilde{M}]} = \sum_{i=1}^n \mathcal{L}_{M_i} - \sum_{(M_i, M_j) \in E(G^L[\widetilde{M}])} \mathcal{F}_{ij} - C$$

with its projection

$$\mathcal{L}_{G^L[\widetilde{M}]}|_{M_i} = \mathcal{L}_{int}^i - \mathcal{L}_{ext}^i$$

on M_i for $1 \leq i \leq n$. This can be explained to be a *net Lagrange density* on M_i without intersection.

The simplest case of $\mathcal{L}_{G^L[\widetilde{M}]}$ is by choosing $a_i = 1$ and $b_{ij} = 0$ for $1 \leq i, j \leq n$, i.e.,

$$\mathcal{L}_{G^L[\widetilde{M}]} = \sum_{i=1}^n \mathcal{L}_{M_i}.$$

This Lagrange density has meaning only if there are no actions between fields M_i, M_j for any integers $1 \leq i, j \leq n$, i.e., $E(G^L[\widetilde{M}]) = \emptyset$. We have assumed that $G^L[\widetilde{M}]$

is connected in Chapter 4, which means that $E(G^L[\widetilde{M}]) = \emptyset$ only if $n = 1$. So we do not choose this formula to be the Lagrange density of combinatorial fields in the discussion following.

Case 2. *Non-Linear*

In this case, the Lagrange density $\mathcal{L}_{G^L[\widetilde{M}]}$ is a non-linear function of \mathcal{L}_{M_i} and \mathcal{F}_{ij} for $1 \leq i, j \leq n$. Let the minimum and maximum indexes j for $(M_i, M_j) \in E(G^L[\widetilde{M}])$ are i^l and i^u , respectively. Denote by

$$\bar{x} = (x_1, x_2, \dots) = (\mathcal{L}_{M_1}, \mathcal{L}_{M_2}, \dots, \mathcal{L}_{M_n}, \mathcal{F}_{11^l}, \dots, \mathcal{F}_{11^u}, \dots, \mathcal{F}_{22^l}, \dots).$$

If $\mathcal{L}_{G^L[\widetilde{M}]}$ is $k + 1$ differentiable, $k \geq 0$ by Taylor's formula we know that

$$\begin{aligned} \mathcal{L}_{G^L[\widetilde{M}]} &= \mathcal{L}_{G^L[\widetilde{M}]}(\bar{0}) + \sum_{i=1}^n \left[\frac{\partial \mathcal{L}_{G^L[\widetilde{M}]}}{\partial x_i} \right]_{x_i=0} x_i + \frac{1}{2!} \sum_{i,j=1}^n \left[\frac{\partial^2 \mathcal{L}_{G^L[\widetilde{M}]}}{\partial x_i \partial x_j} \right]_{x_i, x_j=0} x_i x_j \\ &+ \dots + \frac{1}{k!} \sum_{i_1, i_2, \dots, i_k=1}^n \left[\frac{\partial^k \mathcal{L}_{G^L[\widetilde{M}]}}{\partial x_{i_1} \partial x_{i_2} \dots \partial x_{i_k}} \right]_{x_{i_j}=0, 1 \leq j \leq k} x_{i_1} x_{i_2} \dots x_{i_k} \\ &+ R(x_1, x_2, \dots), \end{aligned}$$

where

$$\lim_{\|\bar{x}\| \rightarrow 0} \frac{R(x_1, x_2, \dots)}{\|\bar{x}\|} = 0.$$

Certainly, we can choose the first s terms

$$\begin{aligned} &\mathcal{L}_{G^L[\widetilde{M}]}(\bar{0}) + \sum_{i=1}^n \left[\frac{\partial \mathcal{L}_{G^L[\widetilde{M}]}}{\partial x_i} \right]_{x_i=0} x_i + \frac{1}{2!} \sum_{i,j=1}^n \left[\frac{\partial^2 \mathcal{L}_{G^L[\widetilde{M}]}}{\partial x_i \partial x_j} \right]_{x_i, x_j=0} x_i x_j \\ &+ \dots + \frac{1}{k!} \sum_{i_1, i_2, \dots, i_k=1}^n \left[\frac{\partial^k \mathcal{L}_{G^L[\widetilde{M}]}}{\partial x_{i_1} \partial x_{i_2} \dots \partial x_{i_k}} \right]_{x_{i_j}=0, 1 \leq j \leq k} x_{i_1} x_{i_2} \dots x_{i_k} \end{aligned}$$

to be the asymptotic value of Lagrange density $\mathcal{L}_{G^L[\widetilde{M}]}$, particularly, the linear parts

$$\mathcal{L}_{G^L[\widetilde{M}]}(\bar{0}) + \sum_{i=1}^n \left[\frac{\partial \mathcal{L}_{G^L[\widetilde{M}]}}{\partial \mathcal{L}_{M_i}} \right]_{\mathcal{L}_{M_i}=0} \mathcal{L}_{M_i} + \sum_{(M_i, M_j) \in E(G^L[\widetilde{M}])} \left[\frac{\partial \mathcal{L}_{G^L[\widetilde{M}]}}{\partial \mathcal{F}_{ij}} \right]_{\mathcal{F}_{ij}=0} \mathcal{F}_{ij}$$

in most cases on combinatorial fields.

Now we consider the net value of Lagrange density on combinatorial fields \widetilde{M} without intersections. Certainly, we can determine it by applying the inclusion-exclusion principle. For example, if $G^L[\widetilde{M}]$ is K_3 -free, similar to the proof of Corollary 4.2.4, we know that the net Lagrange density is

$$\begin{aligned} \mathcal{L}_{G^L[\widetilde{M}]} &= \sum_{(M_i, M_j) \in E(G^L[\widetilde{M}])} (\mathcal{L}_{M_i} + \mathcal{L}_{M_j} - \mathcal{I}_{ij}) \\ &= \sum_{(M_i, M_j) \in E(G^L[\widetilde{M}])} (\mathcal{L}_{M_i} + \mathcal{L}_{M_j}) - \sum_{(M_i, M_j) \in E(G^L[\widetilde{M}])} \mathcal{I}_{ij} \\ &= \sum_{M_i \in V(G^L[\widetilde{M}])} \mathcal{L}_{M_i}^2 - \sum_{(M_i, M_j) \in E(G^L[\widetilde{M}])} \mathcal{I}_{ij}, \end{aligned}$$

which is a polynomial of degree 2 with a projection

$$\mathcal{L}_{G^L[\widetilde{M}]}|_{M_i} = \mathcal{L}_{M_i}^2 - \sum_{(M_i, M_j) \in E(G^L[\widetilde{M}])} \mathcal{I}_{ij}$$

on the field M_i .

Similarly, we also do not choose the expression

$$\mathcal{L}_{M_1}^{s_1} + \mathcal{L}_{M_2}^{s_2} + \dots + \mathcal{L}_{M_n}^{s_n}$$

with $s_i \geq 2$ for $1 \leq i \leq n$ to be the Lagrange density $\mathcal{L}_{G^L[\widetilde{M}]}$ because it has meaning only if there are no actions between fields M_i, M_j for any integers $1 \leq i, j \leq n$, i.e., $E(G^L[\widetilde{M}]) = \emptyset$ since it has physical meaning only if $n = 1$.

We can verify immediately that the underlying graph $G^L[\widetilde{M}]$ is invariant under the projection of $\mathcal{L}_{G^L[\widetilde{M}]}$ on each M_i for $1 \leq i \leq n$ for all Lagrange densities in Cases 1 and 2.

8.2.2 Hamiltonian on Combinatorial Field. We have know from Section 7.1.5 that the Hamiltonian \mathcal{H} of a field $\phi(\overline{x})$ is defined by

$$H = \int d^3\overline{x} \mathcal{H},$$

where $\mathcal{H} = \pi \dot{\phi} - \mathcal{L}$ is the *Hamilton density* of the field $\phi(\overline{x})$ with $\pi = \partial \mathcal{L} / \partial \dot{\phi}$.

Likewise the Lagrange density, we can also determine the equations of a field $\phi(\bar{x})$ by Hamilton density such as those of equations in Theorem 7.1.3 following

$$\frac{d}{dt} \left(\frac{\partial \mathcal{L}}{\partial \dot{\phi}} \right) = - \frac{\partial \mathcal{H}}{\partial \phi}, \quad \frac{d\phi}{dt} = \frac{\partial \mathcal{H}}{\partial \left(\frac{\partial \mathcal{L}}{\partial \dot{\phi}} \right)}.$$

Whence, for determining the equations of motion of a combinatorial field, it is also enough to find its Hamilton density. Now the disguise of Problem 8.2.1 is turned to the following.

Problem 8.2.2 *Let $G^L[\widetilde{M}]$ be a vertex-edge labeled graph of a combinatorial manifold \widetilde{M} consisting of n manifolds M_1, M_2, \dots, M_n with labels*

$$\theta_L : V(G^L[\widetilde{M}]) \rightarrow \{\mathcal{H}_{M_i}, 1 \leq i \leq n\},$$

$$\theta_L : E(G^L[\widetilde{M}]) \rightarrow \{\mathcal{H}_{ij} \text{ for } \forall (M_i, M_j) \in E(G^L[\widetilde{M}])\},$$

where $\mathcal{H}_{M_i} : TM_i \rightarrow \mathbf{R}$, $\mathcal{H}_{ij} : T(M_i \cap M_j) \rightarrow \mathbf{R}$. Construct a function

$$\mathcal{H}_{G^L[\widetilde{M}]} : G^L[\widetilde{M}] \rightarrow \mathbf{R}$$

such that $G^L[\widetilde{M}]$ is invariant under the projection of $\mathcal{H}_{G^L[\widetilde{M}]}$ on M_i for $1 \leq i \leq n$.

For fields $M_i, M_i \cap M_j, 1 \leq i, j \leq n$, we have known their Hamilton densities to be respective

$$\mathcal{H}_{M_i} = \pi_i \dot{\phi}_{M_i} - \mathcal{L}_{M_i} \quad \text{and} \quad \mathcal{H}_{ij} = \pi_{ij} \dot{\phi}_{M_i \cap M_j} - \mathcal{F}_{ij} \quad (8-1)$$

by definition, where $\pi_i = \partial \mathcal{L}_{M_i} / \partial \dot{\phi}_{M_i}$ and $\pi_{ij} = \partial \mathcal{F}_{ij} / \partial \dot{\phi}_{M_i \cap M_j}$. Similar to the case of Lagrange densities, we classify these Hamilton densities on linearity following.

Case 1. *Linear*

In this case, the general expression of the Hamilton density $\mathcal{H}_{G^L[\widetilde{M}]}$ is

$$\begin{aligned} \mathcal{H}_{G^L[\widetilde{M}]} &= \sum_{i=1}^n a_i \mathcal{H}_{M_i} + \sum_{(M_i, M_j) \in E(G^L[\widetilde{M}])} b_{ij} \mathcal{H}_{ij} + C \\ &= \sum_{i=1}^n a_i (\pi_i \dot{\phi}_{M_i} - \mathcal{L}_{M_i}) + \sum_{(M_i, M_j) \in E(G^L[\widetilde{M}])} b_{ij} (\pi_{ij} \dot{\phi}_{M_i \cap M_j} - \mathcal{F}_{ij}) + C \end{aligned}$$

$$\begin{aligned}
 &= \sum_{i=1}^n a_i \pi_i \dot{\phi}_{M_i} + \sum_{(M_i, M_j) \in E(G^L[\widetilde{M}])} b_{ij} \pi_{ij} \dot{\phi}_{M_i \cap M_j} \\
 &- \sum_{i=1}^n a_i \mathcal{L}_{M_i} - \sum_{(M_i, M_j) \in E(G^L[\widetilde{M}])} b_{ij} \mathcal{T}_{ij} + C
 \end{aligned}$$

Similarly, let the minimum and maximum indexes j for $(M_i, M_j) \in E(G^L[\widetilde{M}])$ are i^l and i^u , respectively. Denote by

$$\begin{aligned}
 \overline{\phi} &= (a_1 \dot{\phi}_{M_1}, \dots, a_n \dot{\phi}_{M_n}, b_{11^l} \dot{\phi}_{M_1 \cap M_{1^l}}, \dots, b_{11^u} \dot{\phi}_{M_1 \cap M_{1^u}}, \dots, b_{nn^u} \dot{\phi}_{M_n \cap M_{n^u}}), \\
 \overline{\pi} &= (\pi_1, \pi_2, \dots, \pi_n, \pi_{11^l}, \dots, \pi_{11^u}, \dots, \pi_{nn^u}).
 \end{aligned}$$

Then

$$\langle \overline{\phi}, \overline{\pi} \rangle = \sum_{i=1}^n a_i \pi_i \dot{\phi}_{M_i} + \sum_{(M_i, M_j) \in E(G^L[\widetilde{M}])} b_{ij} \pi_{ij} \dot{\phi}_{M_i \cap M_j}.$$

Choose a linear Lagrange density of the vertex-edge labeled graph $G^L[\widetilde{M}]$ to be

$$\mathcal{L}_{G^L[\widetilde{M}]} = \sum_{i=1}^n a_i \mathcal{L}_{M_i} + \sum_{(M_i, M_j) \in E(G^L[\widetilde{M}])} b_{ij} \mathcal{T}_{ij} - C.$$

We finally get that

$$\mathcal{H}_{G^L[\widetilde{M}]} = \langle \overline{\phi}, \overline{\pi} \rangle - \mathcal{L}_{G^L[\widetilde{M}]}, \tag{8-2}$$

which is a generalization of the relation of Hamilton density with that of Lagrange density of a field. Furthermore, if $\{\mathcal{H}_{M_i}, \mathcal{H}_{ij}; 1 \leq i, j \leq n\}$ and $\{\mathcal{L}_{M_i}, \mathcal{L}_{ij}; 1 \leq i, j \leq n\}$ are orthogonal in this case, then we get the following consequence.

Theorem 8.2.1 *If the Hamilton density $\mathcal{H}_{G^L[\widetilde{M}]}$ is linear and $\{\mathcal{H}_{M_i}, \mathcal{H}_{ij}; 1 \leq i, j \leq n\}$, $\{\mathcal{L}_{M_i}, \mathcal{L}_{ij}; 1 \leq i, j \leq n\}$ are both orthogonal, then*

$$\langle \mathcal{H}_{M_i}, \mathcal{H} \rangle = \langle \mathcal{L}_{M_i}, \mathcal{L} \rangle, \quad \langle \mathcal{H}_{ij}, \mathcal{H} \rangle = \langle \mathcal{T}_{ij}, \mathcal{L} \rangle$$

for integers $1 \leq i, j \leq n$.

Case 2. *Non-Linear*

In this case, the Hamilton density $\mathcal{H}_{G^L[\widetilde{M}]}$ is a non-linear function of \mathcal{H}_{M_i} and \mathcal{H}_{ij} , also a non-linear function of \mathcal{L}_{M_i} , \mathcal{T}_{ij} and ϕ_{M_i} , $\phi_{M_i \cap M_j}$ for $1 \leq i, j \leq n$, i.e.,

$$\begin{aligned}\mathcal{H}_{G^L[\widetilde{M}]} &= \mathcal{H}_{G^L[\widetilde{M}]}(\mathcal{H}_{M_i}, \mathcal{H}_{ij}; 1 \leq i, j \leq n) \\ &= \mathcal{H}_{G^L[\widetilde{M}]}(\pi_i \dot{\phi}_{M_i} - \mathcal{L}_{M_i}, \pi_{ij} \dot{\phi}_{M_i \cap M_j} - \mathcal{F}_{ij}; 1 \leq i, j \leq n)\end{aligned}$$

Denote by

$$\bar{y} = (y_1, y_2, \dots) = (\mathcal{H}_{M_1}, \mathcal{H}_{M_2}, \dots, \mathcal{H}_{M_n}, \mathcal{H}_{11}, \dots, \mathcal{H}_{11^l}, \dots, \mathcal{H}_{11^u}, \mathcal{H}_{22^l}, \dots).$$

If $\mathcal{H}_{G^L[\widetilde{M}]}$ is $s + 1$ differentiable, $s \geq 0$, by Taylor's formula we know that

$$\begin{aligned}\mathcal{H}_{G^L[\widetilde{M}]} &= \mathcal{H}_{G^L[\widetilde{M}]}(\bar{0}) + \sum_{i=1}^n \left[\frac{\partial \mathcal{H}_{G^L[\widetilde{M}]}}{\partial y_i} \right]_{y_i=0} y_i + \frac{1}{2!} \sum_{i,j=1}^n \left[\frac{\partial^2 \mathcal{H}_{G^L[\widetilde{M}]}}{\partial y_i \partial y_j} \right]_{y_i, y_j=0} y_i y_j \\ &+ \dots + \frac{1}{s!} \sum_{i_1, i_2, \dots, i_s=1}^n \left[\frac{\partial^s \mathcal{H}_{G^L[\widetilde{M}]}}{\partial y_{i_1} \partial y_{i_2} \dots \partial y_{i_s}} \right]_{y_{i_j}=0, 1 \leq j \leq s} y_{i_1} y_{i_2} \dots y_{i_s} \\ &+ K(y_1, y_2, \dots),\end{aligned}$$

where

$$\lim_{\|\bar{y}\| \rightarrow 0} \frac{K(y_1, y_2, \dots)}{\|\bar{y}\|} = 0.$$

Certainly, we can also choose the first s terms

$$\begin{aligned}\mathcal{H}_{G^L[\widetilde{M}]}(\bar{0}) &+ \sum_{i=1}^n \left[\frac{\partial \mathcal{H}_{G^L[\widetilde{M}]}}{\partial y_i} \right]_{y_i=0} y_i + \frac{1}{2!} \sum_{i,j=1}^n \left[\frac{\partial^2 \mathcal{H}_{G^L[\widetilde{M}]}}{\partial y_i \partial y_j} \right]_{y_i, y_j=0} y_i y_j \\ &+ \dots + \frac{1}{s!} \sum_{i_1, i_2, \dots, i_s=1}^n \left[\frac{\partial^s \mathcal{H}_{G^L[\widetilde{M}]}}{\partial y_{i_1} \partial y_{i_2} \dots \partial y_{i_s}} \right]_{y_{i_j}=0, 1 \leq j \leq s} y_{i_1} y_{i_2} \dots y_{i_s}\end{aligned}$$

to be the asymptotic value of Hamilton density $\mathcal{H}_{G^L[\widetilde{M}]}$, particularly, the linear parts

$$\mathcal{H}_{G^L[\widetilde{M}]}(\bar{0}) + \sum_{i=1}^n \left[\frac{\partial \mathcal{H}_{G^L[\widetilde{M}]}}{\partial \mathcal{H}_{M_i}} \right]_{\mathcal{H}_{M_i}=0} \mathcal{H}_{M_i} + \sum_{(M_i, M_j) \in E(G^L[\widetilde{M}])} \left[\frac{\partial \mathcal{H}_{G^L[\widetilde{M}]}}{\partial \mathcal{H}_{ij}} \right]_{\mathcal{H}_{ij}=0} \mathcal{H}_{ij}$$

in most cases on combinatorial fields. Denote the linear part of $\mathcal{H}_{G^L[\widetilde{M}]}$ by $\mathcal{H}_{G^L[\widetilde{M}]}$,

$$\bar{\Phi} = (A_1 \dot{\phi}_{M_1}, \dots, A_n \dot{\phi}_{M_n}, B_{11^l} \dot{\phi}_{M_1 \cap M_{1^l}}, \dots, B_{11^u} \dot{\phi}_{M_1 \cap M_{1^u}}, \dots, B_{nn^u} \dot{\phi}_{M_n \cap M_{n^u}}),$$

$$\bar{\pi} = (\pi_1, \pi_2, \dots, \pi_n, \pi_{11^l}, \dots, \pi_{11^u}, \dots, \pi_{nn^u})$$

and

$$\mathcal{L}_{G^L[\tilde{M}]}^L = -\mathcal{H}_{G^L[\tilde{M}]}(\bar{0}) + \sum_{i=1}^n A_i \mathcal{L}_{M_i} + \sum_{(M_i, M_j) \in E(G^L[\tilde{M}])} B_{ij} \mathcal{T}_{ij},$$

where

$$A_i = \left(\left[\frac{\partial \mathcal{H}_{G^L[\tilde{M}]}}{\partial \mathcal{H}_{M_i}} \right]_{\mathcal{H}_{M_i}=0} \right), \quad B_{ij} = \left[\frac{\partial \mathcal{H}_{G^L[\tilde{M}]}}{\partial \mathcal{H}_{ij}} \right]_{\mathcal{H}_{ij}=0}$$

for $1 \leq i, j \leq n$. Applying formulae in (8 – 1), we know that

$$\begin{aligned} \mathcal{H}_{G^L[\tilde{M}]}^L &= \mathcal{H}_{G^L[\tilde{M}]}(\bar{0}) + \sum_{i=1}^n A_i \mathcal{H}_{M_i} + \sum_{(M_i, M_j) \in E(G^L[\tilde{M}])} B_{ij} \mathcal{H}_{ij} \\ &= \mathcal{H}_{G^L[\tilde{M}]}(\bar{0}) + \sum_{i=1}^n A_i (\pi_i \dot{\phi}_{M_i} - \mathcal{L}_{M_i}) \\ &\quad + \sum_{(M_i, M_j) \in E(G^L[\tilde{M}])} B_{ij} (\pi_{ij} \dot{\phi}_{M_i \cap M_j} - \mathcal{T}_{ij}) \\ &= \langle \bar{\Phi}, \bar{\pi} \rangle - \mathcal{L}_{G^L[\tilde{M}]}^L. \end{aligned}$$

That is,

$$\mathcal{H}_{G^L[\tilde{M}]}^L = \langle \bar{\Phi}, \bar{\pi} \rangle - \mathcal{L}_{G^L[\tilde{M}]}^L, \tag{8 – 3}$$

i.e., a generalization of the relation of Hamilton density with Lagrange density.

Generally, there are no relation (8 – 3) for the non-linear parts of Hamilton density

$\mathcal{H}_{G^L[\tilde{M}]}$ with that of Lagrange density $\mathcal{L}_{G^L[\tilde{M}]}$.

8.2.3 Equation of Combinatorial Field. By the Euler-Lagrange equation, we know that the equation of motion of a combinatorial field $\mathcal{C}(t)$ are

$$\partial_\mu \frac{\partial \mathcal{L}_{G^L[\tilde{M}]}}{\partial \partial_\mu \phi_{\tilde{M}}} - \frac{\partial \mathcal{L}_{G^L[\tilde{M}]}}{\partial \phi_{\tilde{M}}} = 0, \tag{8 – 4}$$

where $\phi_{\tilde{M}}$ is the wave function of combinatorial field $\mathcal{C}(t)$. Applying the equation (8 – 4) and these linear Lagrange densities in last subsection, we consider combinatorial scalar fields, Dirac fields and gravitational fields, gauge fields following.

Combinatorial Scalar Fields.

For a scalar field $\phi(\vec{x})$, we have known its Lagrange density is chosen to be

$$\mathcal{L} = \frac{1}{2}(\partial_\mu\phi\partial^\mu\phi - m^2\phi^2).$$

Now if fields M_1, M_2, \dots, M_n are harmonizing, i.e., we can establish a wave function $\phi_{\widetilde{M}}$ on a reference frame $\{ict, x_1, x_2, x_3\}$ for the combinatorial field $\widetilde{M}(t)$, then we can choose the Lagrange density $\mathcal{L}_{G^L[\widetilde{M}]}$ to be

$$\mathcal{L}_{G^L[\widetilde{M}]} = \frac{1}{2}(\partial_\mu\phi_{\widetilde{M}}\partial^\mu\phi_{\widetilde{M}} - m^2\phi_{\widetilde{M}}^2).$$

Applying (8 – 4), we know that its equation is

$$\partial_\mu \frac{\partial \mathcal{L}_{G^L[\widetilde{M}]}}{\partial \partial_\mu \phi_{\widetilde{M}}} - \frac{\partial \mathcal{L}_{G^L[\widetilde{M}]}}{\partial \phi_{\widetilde{M}}} = \partial_\mu \partial^\mu \phi_{\widetilde{M}} + m^2 \phi_{\widetilde{M}} = (\partial^2 + m^2) \phi_{\widetilde{M}} = 0,$$

which is the same as that of scalar fields. But in general, M_1, M_2, \dots, M_n are not harmonizing. So we can only find the equation of $\widetilde{M}(t)$ by combinatorial techniques.

Without loss of generality, let

$$\phi_{\widetilde{M}} = \sum_{i=1}^n c_i \phi_{M_i},$$

$$\mathcal{L}_{G^L[\widetilde{M}]} = \frac{1}{2} \sum_{i=1}^n (\partial_{\mu_i} \phi_{M_i} \partial^{\mu_i} \phi_{M_i} - m_i^2 \phi_{M_i}^2) + \sum_{(M_i, M_j) \in E(G^L[\widetilde{M}])} b_{ij} \phi_{M_i} \phi_{M_j} + C,$$

i.e.,

$$\mathcal{L}_{G^L[\widetilde{M}]} = \sum_{i=1}^n \mathcal{L}_{M_i} + \sum_{(M_i, M_j) \in E(G^L[\widetilde{M}])} b_{ij} \mathcal{I}_{ij} + C$$

with $\mathcal{L}_{M_i} = \frac{1}{2}(\partial_{\mu_i}\phi_{M_i}\partial^{\mu_i}\phi_{M_i} - m_i^2\phi_{M_i}^2)$, $\mathcal{I}_{ij} = \phi_{M_i}\phi_{M_j}$, $\mu_i = \mu_{M_i}$ and constants b_{ij} , m_i , c_i , C for integers $1 \leq i, j \leq n$. Calculations show that

$$\frac{\partial \mathcal{L}_{G^L[\widetilde{M}]}}{\partial \partial_\mu \phi_{\widetilde{M}}} = \sum_{i=1}^n \frac{\partial \mathcal{L}_{G^L[\widetilde{M}]}}{\partial \partial_{\mu_i} \phi_{M_i}} \frac{\partial \partial_{\mu_i} \phi_{M_i}}{\partial \partial_\mu \phi_{\widetilde{M}}} = \sum_{i=1}^n \frac{1}{c_i} \partial^{\mu_i} \phi_{M_i}$$

and

$$\sum_{i=1}^n (\partial_\mu \partial^{\mu_i} + m_i^2) \phi_{M_i} - \sum_{(M_i, M_j) \in E(G^L[\widetilde{M}])} b_{ij} (\phi_{M_j} + \phi_{M_i}) = 0.$$

Applying the projective principle again, we get the equations of combinatorial scalar field with interactions following.

$$\left\{ \begin{array}{l} (\partial_1^2 + m_1^2 - \sum_{(M_1, M_j) \in E(G^L[\widetilde{M}])} b_{1j}) \phi_{M_1} = 0 \\ (\partial_2^2 + m_2^2 - \sum_{(M_2, M_j) \in E(G^L[\widetilde{M}])} b_{2j}) \phi_{M_2} = 0 \\ \dots\dots\dots \\ (\partial_n^2 + m_n^2 - \sum_{(M_n, M_j) \in E(G^L[\widetilde{M}])} b_{nj}) \phi_{M_n} = 0. \end{array} \right.$$

where, for an integer i , $1 \leq i \leq n$, $\sum_{(M_i, M_j) \in E(G^L[\widetilde{M}])} b_{ij} \phi_{M_i}$ is a term of linear action of fields M_j to M_i for any integer j such that $(M_i, M_j) \in E(G^L[\widetilde{M}])$. This partial differential equation system can be used to determine the behavior of combinatorial scalar fields. Certainly, we can also apply non-linear action term to analyze their behavior and find more efficient results on combinatorial scalar fields.

Combinatorial Dirac Fields.

For a Dirac field $\phi(\vec{x})$, we have known its Lagrange density is

$$\mathcal{L} = \bar{\psi}(i\gamma^\mu \partial_\mu - m)\psi.$$

For simplicity, we consider the linear Lagrange density $\mathcal{L}_{G^L[\widetilde{M}]}$ on \mathcal{L}_{M_i} and \mathcal{F}_{ij} for $1 \leq i, j \leq n$, i.e.,

$$\begin{aligned} \phi_{\widetilde{M}} &= \sum_{i=1}^n c_i \phi_{M_i}; \\ \mathcal{L}_{G^L[\widetilde{M}]} &= \sum_{i=1}^n \bar{\psi}_{M_i} (i\gamma^{\mu_i} \partial_{\mu_i} - m_i) \psi_{M_i} + \sum_{(M_i, M_j) \in E(G^L[\widetilde{M}])} b_{ij} \psi_{M_i} \psi_{M_j} + C, \end{aligned}$$

where b_{ij} , m_i , c_i , C are constants for integers $1 \leq i, j \leq n$. Applying the Euler-Lagrange equation (8-4), we get the equation of combinatorial Dirac field following

$$\sum_{i=1}^n \frac{1}{c_i} (i\gamma^{\mu_i} \partial_\mu - m_i) \psi_{M_i} - \sum_{(M_i, M_j) \in E(G^L[\widetilde{M}])} b_{ij} \left(\frac{\psi_{M_j}}{c_i} + \frac{\psi_{M_i}}{c_j} \right) = 0. \quad (8-6)$$

$$\begin{aligned}
& \sum_{i=1}^k \frac{1}{c_i} (\partial_\mu \partial^{\mu_i} + m_i^2) \phi_{M_i} + \sum_{j=1}^s \frac{1}{c^j} (i\gamma^{\mu_i} \partial_\mu - m'_j) \psi_{M^j} \\
& - \sum_{(M_i, M_j) \in E(G_S^L)} b_{ij}^1 \left(\frac{\phi_{M_j}}{c_i} + \frac{\phi_{M_i}}{c_j} \right) - \sum_{(M^i, M^j) \in E(G_B^L)} b_{ij}^2 \left(\frac{\psi_{M^j}}{c^i} + \frac{\psi_{M^i}}{c^j} \right) \\
& - \sum_{(M_i, M^j) \in E(G_S^L, G_B^L)} b_{ij}^3 \left(\frac{\psi_{M^j}}{c_i} + \frac{\phi_{M_i}}{c^j} \right) = 0.
\end{aligned}$$

For simplicity, let $c_i = c^j = 1$, $1 \leq i \leq k$, $1 \leq j \leq s$. Then applying the projective principle on a scalar field M_i , we get that

$$\left\{ \begin{array}{l}
(\partial_1^2 + m_1^2 - \sum_{(M_1, M_j) \in E(G_S^L)} b_{1j}^1 - \sum_{(M_1, M^j) \in E(G_S^L, G_B^L)} b_{1j}^3) \phi_{M_1} = 0 \\
(\partial_2^2 + m_2^2 - \sum_{(M_2, M_j) \in E(G_S^L)} b_{2j}^1 - \sum_{(M_2, M^j) \in E(G_S^L, G_B^L)} b_{2j}^3) \phi_{M_2} = 0 \\
\cdots \cdots \cdots \\
(\partial_k^2 + m_k^2 - \sum_{(M_k, M_j) \in E(G_S^L)} b_{kj}^1 - \sum_{(M_k, M^j) \in E(G_S^L, G_B^L)} b_{kj}^3) \phi_{M_k} = 0. \quad (8-8)
\end{array} \right.$$

Applying the projective principle on a Dirac field M^j , we get that

$$\left\{ \begin{array}{l}
(i\gamma^{\mu_1} \partial_{\mu_1} - m'_1 - \sum_{(M_1, M_j) \in E(G_B^L)} b_{1j}^2 - \sum_{(M_1, M^j) \in E(G_S^L, G_B^L)} b_{1j}^3) \psi_{M_1} = 0 \\
(i\gamma^{\mu_2} \partial_{\mu_2} - m'_2 - \sum_{(M_2, M_j) \in E(G_B^L)} b_{2j}^2 - \sum_{(M_2, M^j) \in E(G_S^L, G_B^L)} b_{2j}^3) \psi_{M_2} = 0 \\
\cdots \cdots \cdots \\
(i\gamma^{\mu_s} \partial_{\mu_s} - m'_s - \sum_{(M_s, M_j) \in E(G_B^L)} b_{sj}^2 - \sum_{(M_s, M^j) \in E(G_S^L, G_B^L)} b_{sj}^3) \psi_{M_s} = 0. \quad (8-9)
\end{array} \right.$$

In equations (8-8) and (8-9), for an integer i , $1 \leq i \leq n$,

$$\sum_{(M_i, M_j) \in E(G_S^L)} b_{ij}^1 \phi_{M_i}, \quad \sum_{(M^i, M^j) \in E(G_B^L)} b_{ij}^2 \psi_{M^j}$$

and

$$\sum_{(M_i, M^j) \in E(G_S^L, G_B^L)} b_{ij}^3 \phi_{M_i}, \quad \sum_{(M_i, M^j) \in E(G_S^L, G_B^L)} b_{ij}^3 \psi_{M^i}$$

are linear action terms. We can use (8 – 8) and (8 – 9) to determine the behavior of combinatorial scalar and Dirac fields.

8.2.4 Tensor Equation on Combinatorial Field. Applying the combinatorial geometrical model of combinatorial field established in Subsection 8.1.3, we can characterize these combinatorial fields $\widetilde{M}(t)$ of gravitational field, Maxwell field or Yang-Mills field M_1, M_2, \dots, M_n by tensor equations following.

Combinatorial Gravitational Field:

For a gravitational field, we have known its Lagrange density is chosen to be

$$\mathcal{L} = R - 2\kappa\mathcal{L}_F,$$

where R is the Ricci scalar curvature, $\kappa = -8\pi G$ and \mathcal{L}_F the Lagrange density for all other fields. We have shown in Theorem 7.2.1 that by this Lagrange density, the Euler-Lagrange equations of gravitational field are tensor equations following

$$R_{\mu\nu} - \frac{1}{2}g_{\mu\nu}R = \kappa\mathcal{E}_{\mu\nu}.$$

Now for a combinatorial field $\widetilde{M}(t)$ of gravitational fields M_1, M_2, \dots, M_n , by the combinatorial geometrical model established in Section 8.1.3, we naturally choose its Lagrange density $\mathcal{L}_{G^L[\widetilde{M}]}$ to be

$$\mathcal{L} = \widetilde{R} - 2\kappa\mathcal{L}_F,$$

where

$$\widetilde{R} = g^{(\mu\nu)(\kappa\lambda)}\widetilde{R}_{(\mu\nu)(\kappa\lambda)}, \quad \widetilde{R}_{(\mu\nu)(\kappa\lambda)} = \widetilde{R}_{(\mu\nu)(\sigma\varsigma)(\kappa\lambda)}^{\sigma\varsigma}.$$

Then by applying the Euler-Lagrange equation, we get the equation of combinatorial gravitational field following

$$\widetilde{\mathcal{R}}_{(\mu\nu)(\kappa\lambda)} - \frac{1}{2}\widetilde{R}g_{(\mu\nu)(\kappa\lambda)} = \kappa\mathcal{E}_{(\mu\nu)(\kappa\lambda)}, \tag{8 – 10}$$

Applying the projective principle on a gravitational field M_i , we then get equations of gravitational field following

$$R_{\mu\nu} - \frac{1}{2}g_{\mu\nu}R = \kappa\mathcal{E}_{\mu\nu}$$

since $\widetilde{\mathcal{R}}_{(\mu\nu)(\kappa\lambda)}|_{C_i} = R_{\mu\nu}$, $\widetilde{R}|_{C_i} = R$, $g_{(\mu\nu)(\kappa\lambda)}|_{C_i} = g_{\mu\nu}$ and $\mathcal{E}_{(\mu\nu)(\kappa\lambda)}|_{C_i} = \mathcal{E}_{\mu\nu}$.

Certainly, the equations (8–10) can be also established likewise Theorem 7.2.1. We will find special solutions of (8–10) in Section 8.3.

Combinatorial Yang-Mills Fields.

We have known the Lagrange density of a Yang-Mills field is chosen to be

$$\mathcal{L} = \frac{1}{2} \text{tr}(F_{\mu\nu} F^{\mu\nu}) = -\frac{1}{4} F_{\mu\nu}^i F^{i\mu\nu}$$

with equations

$$D^\mu F_{\mu\nu}^a = 0 \quad \text{and} \quad D_\kappa F_{\mu\nu}^a + D_\mu F_{\nu\kappa}^a + D_\nu F_{\kappa\mu}^a = 0.$$

For a combinatorial field $\widetilde{M}(t)$ of gauge fields M_1, M_2, \dots, M_n , we choose its Lagrange density $\mathcal{L}_{GL[\widetilde{M}]}$ to be

$$\mathcal{L}_{GL[\widetilde{M}]} = \frac{1}{2} \text{tr}(F_{(\mu\nu)(\kappa\lambda)} F^{(\mu\nu)(\kappa\lambda)}) = -\frac{1}{4} F_{(\mu\nu)(\kappa\lambda)}^t F^{t(\mu\nu)(\kappa\lambda)}.$$

Then applying the Euler-Lagrange equation (8–4), we can establish the equations of combinatorial Yang-Mills field as follows.

$$\widetilde{D}^{\mu\nu} F^{(\mu\nu)(\sigma\tau)} = 0 \quad \text{and} \quad \widetilde{D}_{\kappa\lambda} F_{(\mu\nu)(\sigma\tau)} + \widetilde{D}_{\mu\nu} F_{(\sigma\tau)(\kappa\lambda)} + \widetilde{D}_{\sigma\tau} F_{(\kappa\lambda)(\mu\nu)} = 0.$$

As a special case of the equations of combinatorial Yang-Mills fields, we consequently get the equations of combinatorial Maxwell field following:

$$\partial_{\mu\nu} F^{(\mu\nu)(\sigma\tau)} = 0 \quad \text{and} \quad \partial_{\kappa\lambda} F_{(\mu\nu)(\sigma\tau)} + \partial_{\mu\nu} F_{(\sigma\tau)(\kappa\lambda)} + \partial_{\sigma\tau} F_{(\kappa\lambda)(\mu\nu)} = 0.$$

It should be noted that $\widetilde{D}^{\mu\nu}|_{M_i} = D^\mu$, $F^{(\mu\nu)(\sigma\tau)}|_{M_i} = F^{\mu\nu}$, $F_{(\mu\nu)(\sigma\tau)}|_{M_i} = F_{\mu\nu}$, $\widetilde{D}_{\kappa\lambda}|_{M_i} = D_\kappa$. Applying the projective principle, we consequently get the equations of Yang-Mills field

$$D^\mu F_{\mu\nu}^a = 0 \quad \text{and} \quad D_\kappa F_{\mu\nu}^a + D_\mu F_{\nu\kappa}^a + D_\nu F_{\kappa\mu}^a = 0.$$

Combinatorial Gravitational and Yang-Mills Fields.

Theoretically, the equation (8–4) can enables us to find equations of combinatorial fields consists of scalar fields, Dirac fields, gravitational fields and Yang-Mills fields. The main work is to find its Lagrange density. For example, let $\widetilde{M}(t)$ be a

combinatorial field \widetilde{M} of gravitational fields M_i , $1 \leq i \leq k$ and Yang-Mills fields M^j , $1 \leq j \leq s$ with $G^L[\widetilde{M}] = G_S^L + G_D^L$, where G_S^L , G_D^L are the respective induced subgraphs of gravitational fields or Yang-Mills fields in $G^L[\widetilde{M}]$, we can chosen the Lagrange density $\mathcal{L}_{G^L[\widetilde{M}]}$ to be a linear combination

$$\mathcal{L}_{G^L[\widetilde{M}]} = \widetilde{R} - 2\kappa\mathcal{L}_F + \frac{1}{2}\text{tr}(F_{\mu\nu}F^{\mu\nu}) + \sum_{(M_i, M^j) \in E(G_S^L, G_D^L)} b_{ij}\phi_{M_i}\psi_{M^j} + C$$

with

$$\phi_{\widetilde{M}} = \sum_{i=1}^k c_i\phi_{M_i} + \sum_{j=1}^s c^j\psi_{M^j},$$

where κ , b_{ij} , c_i , c^j are constants for $1 \leq i \leq k$, $1 \leq j \leq s$ and then find the equation by the Euler-Lagrange equation, or directly by the least action principle following:

$$R_{(\mu\nu)(\sigma\tau)} - \frac{1}{2}g_{(\mu\nu)(\sigma\tau)}R + \kappa\mathcal{E}_{(\mu\nu)(\sigma\tau)} + \widetilde{D}_{\mu\nu}F^{(\mu\nu)(\sigma\tau)} - \sum_{(M_i, M^j) \in E(G_S^L, G_D^L)} b_{ij} \left(\frac{\psi_{M^j}}{c_i} + \frac{\phi_{M_i}}{c^j} \right) = 0$$

For simplicity, let $c_i = c^j = 1$ for $1 \leq i \leq k$, $1 \leq j \leq s$. Applying the projective principle on gravitational fields M_i , $1 \leq i \leq k$, we find that

$$R_{(\mu\nu)(\sigma\tau)} - \frac{1}{2}g_{(\mu\nu)(\sigma\tau)}R + \kappa\mathcal{E}_{(\mu\nu)(\sigma\tau)} - \sum_{(M_i, M^j) \in E(G_S^L, G_D^L)} b_{ij}\phi_{M_i} = 0.$$

Now if we adapt the Einstein's idea of geometrization on gravitation in combinatorial gravitational fields, then $b_{ij} = 0$ for integers i, j such that $(M_i, M^j) \in E(G_S^L, G_D^L)$, i.e.

$$R_{(\mu\nu)(\sigma\tau)} - \frac{1}{2}g_{(\mu\nu)(\sigma\tau)}R + \kappa\mathcal{E}_{(\mu\nu)(\sigma\tau)} = 0,$$

which are called equations of combinatorial gravitational field and will be further discussed in next section. Similarly, applying the projective principle on Yang-Mills fields M^j , $1 \leq j \leq s$, we know that

$$\widetilde{D}_{\mu\nu}F^{(\mu\nu)(\sigma\tau)} - \sum_{(M_i, M^j) \in E(G_S^L, G_D^L)} b_{ij}\psi_{M^j} = 0.$$

Particularly, if we apply the projective principle on a Yang-Mills field or a Maxwell field M^{j_0} for an integer $j_0, 1 \leq j_0 \leq s$, we get that

$$D_\mu F^{\mu\nu} - \sum_{(M_i, M^{j_0}) \in E(G_S^L, G_D^L)} b_{ij}\psi_{M^{j_0}} = 0,$$

$$\partial_\mu F^{\mu\nu} - \sum_{(M_i, M^{j_0}) \in E(G_S^L, G_D^L)} b_{ij}\psi_{M^{j_0}} = 0$$

for $\widetilde{D}_{\mu\nu}|_{M^{j_0}} = D_\mu$ and $\widetilde{D}_\mu|_{M^{j_0}} = \partial_\mu$ if M^{j_0} is a Maxwell field. In the extremal case of $b_{ij} = 0$, i.e., there are no actions between gravitational fields and Yang-Mills fields, we get the system of Einstein's and Yang-Mills equations

$$R_{(\mu\nu)(\sigma\tau)} - \frac{1}{2}g_{(\mu\nu)(\sigma\tau)}R = \kappa\mathcal{E}_{(\mu\nu)(\sigma\tau)}, \quad D_{\mu\nu}F^{(\mu\nu)(\sigma\tau)} = 0.$$

§8.3 COMBINATORIAL GRAVITATIONAL FIELDS

For given integers $0 < n_1 < n_2 < \dots < n_m, m \geq 1$, a *combinatorial gravitational field* $\widetilde{M}(t)$ is a combinatorial Riemannian manifold $(\widetilde{M}, g, \widetilde{D})$ with $\widetilde{M} = \widetilde{M}(n_1, n_2, \dots, n_m)$ determined by tensor equations

$$R_{(\mu\nu)(\sigma\tau)} - \frac{1}{2}g_{(\mu\nu)(\sigma\tau)}R = -8\pi G\mathcal{E}_{(\mu\nu)(\sigma\tau)}.$$

We find their solutions under additional conditions in this section.

8.3.1 Combinatorial Metric. Let $\widetilde{\mathcal{A}}$ be an atlas on $(\widetilde{M}, g, \widetilde{D})$. Choose a local chart $(U; \varpi)$ in $\widetilde{\mathcal{A}}$. By definition, if $\varphi_p : U_p \rightarrow \bigcup_{i=1}^{s(p)} B^{n_i(p)}$ and $\widehat{s}(p) = \dim(\bigcap_{i=1}^{s(p)} B^{n_i(p)})$, then $[\varphi_p]$ is an $s(p) \times n_{s(p)}$ matrix shown following.

$$[\varphi_p] = \begin{bmatrix} \frac{x^{11}}{s(p)} & \dots & \frac{x^{1\widehat{s}(p)}}{s(p)} & x^{1(\widehat{s}(p)+1)} & \dots & x^{1n_1} & \dots & 0 \\ \frac{x^{21}}{s(p)} & \dots & \frac{x^{2\widehat{s}(p)}}{s(p)} & x^{2(\widehat{s}(p)+1)} & \dots & x^{2n_2} & \dots & 0 \\ \dots & \dots & \dots & \dots & \dots & \dots & \dots & \dots \\ \frac{x^{s(p)1}}{s(p)} & \dots & \frac{x^{s(p)\widehat{s}(p)}}{s(p)} & x^{s(p)(\widehat{s}(p)+1)} & \dots & \dots & x^{s(p)n_{s(p)-1}} & x^{s(p)n_{s(p)}} \end{bmatrix}$$

with $x^{is} = x^{js}$ for $1 \leq i, j \leq s(p), 1 \leq s \leq \widehat{s}(p)$. A *combinatorial metric* is defined by

$$ds^2 = g_{(\mu\nu)(\kappa\lambda)} dx^{\mu\nu} dx^{\kappa\lambda}, \tag{8 - 11}$$

where $g_{(\mu\nu)(\kappa\lambda)}$ is the Riemannian metric in $(\widetilde{M}, g, \widetilde{D})$. Generally, we can choose a orthogonal basis $\{\bar{e}_{11}, \dots, \bar{e}_{1n_1}, \dots, \bar{e}_{s(p)n_{s(p)}}\}$ for $\varphi_p[U], p \in \widetilde{M}(t)$, i.e., $\langle \bar{e}_{\mu\nu}, \bar{e}_{\kappa\lambda} \rangle = \delta_{(\mu\nu)}^{(\kappa\lambda)}$. Then the formula (8 - 11) turns to

$$\begin{aligned} ds^2 &= g_{(\mu\nu)(\mu\nu)} (dx^{\mu\nu})^2 \\ &= \sum_{\mu=1}^{s(p)} \sum_{\nu=1}^{\widehat{s}(p)} g_{(\mu\nu)(\mu\nu)} (dx^{\mu\nu})^2 + \sum_{\mu=1}^{s(p)} \sum_{\nu=1}^{\widehat{s}(p)+1} g_{(\mu\nu)(\mu\nu)} (dx^{\mu\nu})^2 \\ &= \frac{1}{s^2(p)} \sum_{\nu=1}^{\widehat{s}(p)} \left(\sum_{\mu=1}^{s(p)} g_{(\mu\nu)(\mu\nu)} \right) dx^\nu + \sum_{\mu=1}^{s(p)} \sum_{\nu=1}^{\widehat{s}(p)+1} g_{(\mu\nu)(\mu\nu)} (dx^{\mu\nu})^2. \end{aligned}$$

Then we therefore find an important relation of combinatorial metric with that of its projections following.

Theorem 8.3.1 *Let ${}_\mu ds^2$ be the metric of $\phi_p^{-1}(B^{n_\mu(p)})$ for integers $1 \leq \mu \leq s(p)$. Then*

$$ds^2 = {}_1 ds^2 + {}_2 ds^2 + \dots + {}_{s(p)} ds^2.$$

Proof Applying the projective principle, we immediately know that

$${}_\mu ds^2 = ds^2|_{\phi_p^{-1}(B^{n_\mu(p)})}, \quad 1 \leq \mu \leq s(p).$$

Whence, we find that

$$\begin{aligned} ds^2 &= g_{(\mu\nu)(\mu\nu)} (dx^{\mu\nu})^2 = \sum_{\mu=1}^{s(p)} \sum_{\nu=1}^{n_\mu(p)} g_{(\mu\nu)(\mu\nu)} (dx^{\mu\nu})^2 \\ &= \sum_{\mu=1}^{s(p)} ds^2|_{\phi_p^{-1}(B^{n_\mu(p)})} = \sum_{\mu=1}^{s(p)} {}_\mu ds^2. \end{aligned}$$

□

This relation enables us to solve the equations of combinatorial gravitational fields $\widetilde{M}(t)$ by using that of gravitational fields known.

8.3.2 Combinatorial Schwarzschild Metric. Let M be a gravitational field. We have known its Schwarzschild metric, i.e., a spherically symmetric solution of Einstein's gravitational equations in vacuum is

$$ds^2 = \left(1 - \frac{r_s}{r}\right) dt^2 - \frac{dr^2}{1 - \frac{r_s}{r}} - r^2 d\theta^2 - r^2 \sin^2 \theta d\phi^2 \tag{8 - 12}$$

in last chapter, where $r_s = 2Gm/c^2$. Now we generalize it to combinatorial gravitational fields to find the solutions of equations

$$R_{(\mu\nu)(\sigma\tau)} - \frac{1}{2}g_{(\mu\nu)(\sigma\tau)}R = -8\pi G\mathcal{E}_{(\mu\nu)(\sigma\tau)}$$

in vacuum, i.e., $\mathcal{E}_{(\mu\nu)(\sigma\tau)} = 0$. By the *Action Principle of Fields* in Subsection 8.1.2, the underlying graph of combinatorial field consisting of m gravitational fields is a complete graph K_m . For such a objective, we only consider the homogenous combinatorial Euclidean spaces $\widetilde{M} = \bigcup_{i=1}^m \mathbf{R}^{n_i}$, i.e., for any point $p \in \widetilde{M}$,

$$[\varphi_p] = \begin{bmatrix} x^{11} & \dots & x^{1\widehat{m}} & x^{1(\widehat{m}+1)} & \dots & x^{1n_1} & \dots & 0 \\ x^{21} & \dots & x^{2\widehat{m}} & x^{2(\widehat{m}+1)} & \dots & x^{2n_2} & \dots & 0 \\ \dots & \dots & \dots & \dots & \dots & \dots & \dots & \dots \\ x^{m1} & \dots & x^{m\widehat{m}} & x^{m(\widehat{m}+1)} & \dots & \dots & \dots & x^{mn_m} \end{bmatrix}$$

with $\widehat{m} = \dim\left(\bigcap_{i=1}^m \mathbf{R}^{n_i}\right)$ a constant for $\forall p \in \bigcap_{i=1}^m \mathbf{R}^{n_i}$ and $x^{il} = \frac{x^l}{m}$ for $1 \leq i \leq m, 1 \leq l \leq \widehat{m}$.

Let $\widetilde{M}(t)$ be a combinatorial field of gravitational fields M_1, M_2, \dots, M_m with masses m_1, m_2, \dots, m_m respectively. For usually undergoing, we consider the case of $n_\mu = 4$ for $1 \leq \mu \leq m$ since line elements have been found concretely in classical gravitational field in these cases. Now establish m spherical coordinate subframe $(t_\mu; r_\mu, \theta_\mu, \phi_\mu)$ with its originality at the center of such a mass space. Then we have known its a spherically symmetric solution by (8 - 12) to be

$$ds_\mu^2 = \left(1 - \frac{r_{\mu s}}{r_\mu}\right) dt_\mu^2 - \left(1 - \frac{r_{\mu s}}{r_\mu}\right)^{-1} dr_\mu^2 - r_\mu^2 (d\theta_\mu^2 + \sin^2 \theta_\mu d\phi_\mu^2).$$

for $1 \leq \mu \leq m$ with $r_{\mu s} = 2Gm_\mu/c^2$. By Theorem 8.3.1, we know that

$$ds^2 = {}_1ds^2 + {}_2ds^2 + \dots + {}_m ds^2,$$

where ${}_{\mu}ds^2 = ds_{\mu}^2$ by the projective principle on combinatorial fields. Notice that $1 \leq \widehat{m} \leq 4$. We therefore get combinatorial metrics dependent on \widehat{m} following.

Case 1. $\widehat{m} = 1$, i.e., $t_{\mu} = t$ for $1 \leq \mu \leq m$.

In this case, the combinatorial metric ds is

$$ds^2 = \sum_{\mu=1}^m \left(1 - \frac{2Gm_{\mu}}{c^2 r_{\mu}}\right) dt^2 - \sum_{\mu=1}^m \left(1 - \frac{2Gm_{\mu}}{c^2 r_{\mu}}\right)^{-1} dr_{\mu}^2 - \sum_{\mu=1}^m r_{\mu}^2 (d\theta_{\mu}^2 + \sin^2 \theta_{\mu} d\phi_{\mu}^2).$$

Case 2. $\widehat{m} = 2$, i.e., $t_{\mu} = t$ and $r_{\mu} = r$, or $t_{\mu} = t$ and $\theta_{\mu} = \theta$, or $t_{\mu} = t$ and $\phi_{\mu} = \phi$ for $1 \leq \mu \leq m$.

We consider the following subcases.

Subcase 2.1. $t_{\mu} = t$, $r_{\mu} = r$.

In this subcase, the combinatorial metric is

$$ds^2 = \sum_{\mu=1}^m \left(1 - \frac{2Gm_{\mu}}{c^2 r}\right) dt^2 - \left(\sum_{\mu=1}^m \left(1 - \frac{2Gm_{\mu}}{c^2 r}\right)^{-1}\right) dr^2 - \sum_{\mu=1}^m r^2 (d\theta_{\mu}^2 + \sin^2 \theta_{\mu} d\phi_{\mu}^2),$$

which can only happens if these m fields are at a same point O in a space. Particularly, if $m_{\mu} = M$ for $1 \leq \mu \leq m$, the masses of M_1, M_2, \dots, M_m are the same, then $r_{\mu g} = 2GM$ is a constant, which enables us knowing that

$$ds^2 = \left(1 - \frac{2GM}{c^2 r}\right) m dt^2 - \left(1 - \frac{2GM}{c^2 r}\right)^{-1} m dr^2 - \sum_{\mu=1}^m r^2 (d\theta_{\mu}^2 + \sin^2 \theta_{\mu} d\phi_{\mu}^2).$$

Subcase 2.2. $t_{\mu} = t$, $\theta_{\mu} = \theta$.

In this subcase, the combinatorial metric is

$$\begin{aligned} ds^2 &= \sum_{\mu=1}^m \left(1 - \frac{2Gm_{\mu}}{c^2 r_{\mu}}\right) dt^2 \\ &\quad - \sum_{\mu=1}^m \left(1 - \frac{2Gm_{\mu}}{c^2 r_{\mu}}\right)^{-1} dr_{\mu}^2 - \sum_{\mu=1}^m r_{\mu}^2 (d\theta^2 + \sin^2 \theta d\phi_{\mu}^2). \end{aligned}$$

Subcase 2.3. $t_\mu = t$, $\phi_\mu = \phi$.

In this subcase, the combinatorial metric is

$$ds^2 = \sum_{\mu=1}^m \left(1 - \frac{2Gm_\mu}{c^2 r_\mu}\right) dt^2 - \left(\sum_{\mu=1}^m \left(1 - \frac{2Gm_\mu}{c^2 r_\mu}\right)^{-1}\right) dr_\mu^2 - \sum_{\mu=1}^m r_\mu^2 (d\theta_\mu^2 + \sin^2 \theta_\mu d\phi^2).$$

Case 3. $\widehat{m} = 3$, i.e., $t_\mu = t$, $r_\mu = r$ and $\theta_\mu = \theta$, or $t_\mu = t$, $r_\mu = r$ and $\phi_\mu = \phi$, or or $t_\mu = t$, $\theta_\mu = \theta$ and $\phi_\mu = \phi$ for $1 \leq \mu \leq m$.

We consider three subcases following.

Subcase 3.1. $t_\mu = t$, $r_\mu = r$ and $\theta_\mu = \theta$.

In this subcase, the combinatorial metric is

$$ds^2 = \sum_{\mu=1}^m \left(1 - \frac{2Gm_\mu}{c^2 r}\right) dt^2 - \sum_{\mu=1}^m \left(1 - \frac{2Gm_\mu}{c^2 r}\right)^{-1} dr^2 - mr^2 d\theta^2 - r^2 \sin^2 \theta \sum_{\mu=1}^m d\phi_\mu^2.$$

Subcase 3.2. $t_\mu = t$, $r_\mu = r$ and $\phi_\mu = \phi$.

In this subcase, the combinatorial metric is

$$ds^2 = \sum_{\mu=1}^m \left(1 - \frac{2Gm_\mu}{c^2 r}\right) dt^2 - \sum_{\mu=1}^m \left(1 - \frac{2Gm_\mu}{c^2 r}\right)^{-1} dr^2 - r^2 \sum_{\mu=1}^m (d\theta_\mu^2 + \sin^2 \theta_\mu d\phi^2).$$

There subcases 3.1 and 3.2 can be only happen if the centers of these m fields are at a same point O in a space.

Subcase 3.3. $t_\mu = t$, $\theta_\mu = \theta$ and $\phi_\mu = \phi$.

In this subcase, the combinatorial metric is

$$ds^2 = \sum_{\mu=1}^m \left(1 - \frac{2Gm_\mu}{c^2 r_\mu}\right) dt^2 - \sum_{\mu=1}^m \left(1 - \frac{2Gm_\mu}{c^2 r_\mu}\right)^{-1} dr_\mu^2 - \sum_{\mu=1}^m r_\mu (d\theta^2 + \sin^2 \theta d\phi^2).$$

Case 4. $\widehat{m} = 4$, i.e., $t_\mu = t$, $r_\mu = r$, $\theta_\mu = \theta$ and $\phi_\mu = \phi$ for $1 \leq \mu \leq m$.

In this subcase, the combinatorial metric is

$$ds^2 = \sum_{\mu=1}^m \left(1 - \frac{2Gm_\mu}{c^2 r}\right) dt^2 - \sum_{\mu=1}^m \left(1 - \frac{2Gm_\mu}{c^2 r}\right)^{-1} dr^2 - mr^2(d\theta^2 + \sin^2 \theta d\phi^2).$$

Particularly, if $m_\mu = M$ for $1 \leq \mu \leq m$, we get that

$$ds^2 = \left(1 - \frac{2GM}{c^2 r}\right) m dt^2 - \left(1 - \frac{2GM}{c^2 r}\right)^{-1} m dr^2 - mr^2(d\theta^2 + \sin^2 \theta d\phi^2).$$

Define a coordinate transformation $(t, r, \theta, \phi) \rightarrow ({}_s t, {}_s r, {}_s \theta, {}_s \phi) = (t\sqrt{m}, r\sqrt{m}, \theta, \phi)$. Then the previous formula turns to

$$ds^2 = \left(1 - \frac{2GM}{c^2 r}\right) d_s t^2 - \frac{d_s r^2}{1 - \frac{2GM}{c^2 r}} - {}_s r^2(d_s \theta^2 + \sin^2 {}_s \theta d_s \phi^2)$$

in this new coordinate system $({}_s t, {}_s r, {}_s \theta, {}_s \phi)$, whose geometrical behavior likes that of the gravitational field.

8.3.3 Combinatorial Reissner-Nordström Metric. The Schwarzschild metric is a spherically symmetric solution of the Einstein’s gravitational equations in conditions $\mathcal{E}_{(\mu\nu)(\sigma\tau)} = 0$. In some special cases, we can also find their solutions for the case $\mathcal{E}_{(\mu\nu)(\sigma\tau)} \neq 0$. The *Reissner-Nordström metric* is such a case with

$$\mathcal{E}_{(\mu\nu)(\sigma\tau)} = \frac{1}{4\pi} \left(\frac{1}{4} g_{\mu\nu} F_{\alpha\beta} F^{\alpha\beta} - F_{\mu\alpha} F_\nu^\alpha \right)$$

in the Maxwell field with total mass m and total charge e , where $F_{\alpha\beta}$ and $F^{\alpha\beta}$ are given in Subsection 7.3.4. Its metrics takes the following form:

$$g_{\mu\nu} = \begin{bmatrix} 1 - \frac{r_s}{r} + \frac{r_e^2}{r^2} & 0 & 0 & 0 \\ 0 & -\left(1 - \frac{r_s}{r} + \frac{r_e^2}{r^2}\right)^{-1} & 0 & 0 \\ 0 & 0 & -r^2 & 0 \\ 0 & 0 & 0 & -r^2 \sin^2 \theta \end{bmatrix},$$

where $r_s = 2Gm/c^2$ and $r_e^2 = 4G\pi e^2/c^4$. In this case, its line element ds is given by

$$ds^2 = \left(1 - \frac{r_s}{r} + \frac{r_e^2}{r^2}\right) dt^2 - \left(1 - \frac{r_s}{r} + \frac{r_e^2}{r^2}\right)^{-1} dr^2 - r^2(d\theta^2 + \sin^2 \theta d\phi^2). \quad (8-13)$$

Obviously, if $e = 0$, i.e., there are no charges in the gravitational field, then the equations (8 – 13) turns to the Schwarzschild metric (8 – 12).

Now let $\widetilde{M}(t)$ be a combinatorial field of charged gravitational fields M_1, M_2, \dots, M_m with masses m_1, m_2, \dots, m_m and charges e_1, e_2, \dots, e_m , respectively. Similar to the case of Schwarzschild metric, we consider the case of $n_\mu = 4$ for $1 \leq \mu \leq m$. We establish m spherical coordinate subframe $(t_\mu; r_\mu, \theta_\mu, \phi_\mu)$ with its originality at the center of such a mass space. Then we know its a spherically symmetric solution by (8 – 13) to be

$$ds_\mu^2 = \left(1 - \frac{r_{\mu s}}{r_\mu} + \frac{r_{\mu e}^2}{r_\mu^2}\right) dt_\mu^2 - \left(1 - \frac{r_{\mu s}}{r_\mu} + \frac{r_{\mu e}^2}{r_\mu^2}\right)^{-1} dr_\mu^2 - r_\mu^2(d\theta_\mu^2 + \sin^2 \theta_\mu d\phi_\mu^2).$$

Likewise the case of Schwarzschild metric, we consider combinatorial fields of charged gravitational fields dependent on the intersection dimension \widehat{m} following.

Case 1. $\widehat{m} = 1$, i.e., $t_\mu = t$ for $1 \leq \mu \leq m$.

In this case, by applying Theorem 8.3.1 we get the combinatorial metric

$$ds^2 = \sum_{\mu=1}^m \left(1 - \frac{r_{\mu s}}{r_\mu} + \frac{r_{\mu e}^2}{r_\mu^2}\right) dt^2 - \sum_{\mu=1}^m \left(1 - \frac{r_{\mu s}}{r_\mu} + \frac{r_{\mu e}^2}{r_\mu^2}\right)^{-1} dr_\mu^2 - \sum_{\mu=1}^m r_\mu^2(d\theta_\mu^2 + \sin^2 \theta_\mu d\phi_\mu^2).$$

Case 2. $\widehat{m} = 2$, i.e., $t_\mu = t$ and $r_\mu = r$, or $t_\mu = t$ and $\theta_\mu = \theta$, or $t_\mu = t$ and $\phi_\mu = \phi$ for $1 \leq \mu \leq m$.

Consider the following three subcases.

Subcase 2.1. $t_\mu = t$, $r_\mu = r$.

In this subcase, the combinatorial metric is

$$ds^2 = \sum_{\mu=1}^m \left(1 - \frac{r_{\mu s}}{r} + \frac{r_{\mu e}^2}{r^2}\right) dt^2 - \sum_{\mu=1}^m \left(1 - \frac{r_{\mu s}}{r} + \frac{r_{\mu e}^2}{r^2}\right)^{-1} dr^2 - \sum_{\mu=1}^m r^2(d\theta_\mu^2 + \sin^2 \theta_\mu d\phi_\mu^2),$$

which can only happens if these m fields are at a same point O in a space. Particularly, if $m_\mu = M$ and $e_\mu = e$ for $1 \leq \mu \leq m$, we find that

$$ds^2 = \left(1 - \frac{2GM}{c^2 r} + \frac{4\pi G e^4}{c^4 r^2}\right) m dt^2 - \frac{m dr^2}{1 - \frac{2GM}{c^2 r} + \frac{4\pi G e^4}{c^4 r^2}} - \sum_{\mu=1}^m r^2 (d\theta_\mu^2 + \sin^2 \theta_\mu d\phi_\mu^2).$$

Subcase 2.2. $t_\mu = t, \theta_\mu = \theta$.

In this subcase, by applying Theorem 8.3.1 we know that the combinatorial metric is

$$ds^2 = \sum_{\mu=1}^m \left(1 - \frac{r_{\mu s}}{r_\mu} + \frac{r_{\mu e}^2}{r_\mu^2}\right) dt^2 - \sum_{\mu=1}^m \left(1 - \frac{r_{\mu s}}{r_\mu} + \frac{r_{\mu e}^2}{r_\mu^2}\right)^{-1} dr_\mu^2 - \sum_{\mu=1}^m r_\mu^2 (d\theta^2 + \sin^2 \theta d\phi_\mu^2).$$

Subcase 2.3. $t_\mu = t, \phi_\mu = \phi$.

In this subcase, we know that the combinatorial metric is

$$ds^2 = \sum_{\mu=1}^m \left(1 - \frac{r_{\mu s}}{r_\mu} + \frac{r_{\mu e}^2}{r_\mu^2}\right) dt^2 - \sum_{\mu=1}^m \left(1 - \frac{r_{\mu s}}{r_\mu} + \frac{r_{\mu e}^2}{r_\mu^2}\right)^{-1} dr_\mu^2 - \sum_{\mu=1}^m r_\mu^2 (d\theta_\mu^2 + \sin^2 \theta_\mu d\phi^2).$$

Case 3. $\widehat{m} = 3$, i.e., $t_\mu = t, r_\mu = r$ and $\theta_\mu = \theta$, or $t_\mu = t, r_\mu = r$ and $\phi_\mu = \phi$, or or $t_\mu = t, \theta_\mu = \theta$ and $\phi_\mu = \phi$ for $1 \leq \mu \leq m$.

We consider three subcases following.

Subcase 3.1. $t_\mu = t, r_\mu = r$ and $\theta_\mu = \theta$.

In this subcase, by applying Theorem 8.3.1 we obtain that the combinatorial metric is

$$ds^2 = \sum_{\mu=1}^m \left(1 - \frac{r_{\mu s}}{r} + \frac{r_{\mu e}^2}{r^2}\right) dt^2 - \sum_{\mu=1}^m \left(1 - \frac{r_{\mu s}}{r} + \frac{r_{\mu e}^2}{r^2}\right)^{-1} dr^2 - \sum_{\mu=1}^m r^2 (d\theta^2 + \sin^2 \theta d\phi_\mu^2).$$

Particularly, if $m_\mu = M$ and $e_\mu = e$ for $1 \leq \mu \leq m$, then we get that

$$ds^2 = \left(1 - \frac{2GM}{c^2 r} + \frac{4\pi G e^4}{c^4 r^2}\right) m dt^2 - \frac{m dr^2}{1 - \frac{2GM}{c^2 r} + \frac{4\pi G e^4}{c^4 r^2}} - \sum_{\mu=1}^m r^2 (d\theta^2 + \sin^2 \theta d\phi_\mu^2).$$

Subcase 3.2. $t_\mu = t$, $r_\mu = r$ and $\phi_\mu = \phi$.

In this subcase, the combinatorial metric is

$$ds^2 = \sum_{\mu=1}^m \left(1 - \frac{r_{\mu s}}{r} + \frac{r_{\mu e}^2}{r^2} \right) dt^2 - \sum_{\mu=1}^m \left(1 - \frac{r_{\mu s}}{r} + \frac{r_{\mu e}^2}{r^2} \right)^{-1} dr^2 - \sum_{\mu=1}^m r^2 (d\theta_\mu^2 + \sin^2 \theta_\mu d\phi^2).$$

Particularly, if $m_\mu = M$ and $e_\mu = e$ for $1 \leq \mu \leq m$, then we get that

$$ds^2 = \left(1 - \frac{2GM}{c^2 r} + \frac{4\pi G e^4}{c^4 r^2} \right) m dt^2 - \frac{m dr^2}{1 - \frac{2GM}{c^2 r} + \frac{4\pi G e^4}{c^4 r^2}} - \sum_{\mu=1}^m r^2 (d\theta_\mu^2 + \sin^2 \theta_\mu d\phi^2).$$

Subcase 3.3. $t_\mu = t$, $\theta_\mu = \theta$ and $\phi_\mu = \phi$.

In this subcase, the combinatorial metric is

$$ds^2 = \sum_{\mu=1}^m \left(1 - \frac{r_{\mu s}}{r_\mu} + \frac{r_{\mu e}^2}{r_\mu^2} \right) dt^2 - \sum_{\mu=1}^m \left(1 - \frac{r_{\mu s}}{r_\mu} + \frac{r_{\mu e}^2}{r_\mu^2} \right)^{-1} dr_\mu^2 - \sum_{\mu=1}^m r_\mu^2 (d\theta^2 + \sin^2 \theta d\phi^2).$$

Case 4. $\hat{m} = 4$, i.e., $t_\mu = t$, $r_\mu = r$, $\theta_\mu = \theta$ and $\phi_\mu = \phi$ for $1 \leq \mu \leq m$.

In this subcase, the combinatorial metric is

$$\begin{aligned} ds^2 &= \sum_{\mu=1}^m \left(1 - \frac{r_{\mu s}}{r} + \frac{r_{\mu e}^2}{r^2} \right) dt^2 \\ &\quad - \sum_{\mu=1}^m \left(1 - \frac{r_{\mu s}}{r} + \frac{r_{\mu e}^2}{r^2} \right)^{-1} dr^2 - m r^2 (d\theta^2 + \sin^2 \theta d\phi^2). \end{aligned}$$

Furthermore, if $m_\mu = M$ and $e_\mu = e$ for $1 \leq \mu \leq m$, we obtain that

$$ds^2 = \left(1 - \frac{2GM}{c^2 r} + \frac{4\pi G e^4}{c^4 r^2} \right) m dt^2 - \frac{m dr^2}{1 - \frac{2GM}{c^2 r} + \frac{4\pi G e^4}{c^4 r^2}} - m r^2 (d\theta^2 + \sin^2 \theta d\phi^2).$$

Similarly, we define the coordinate transformation $(t, r, \theta, \phi) \rightarrow ({}_s t, {}_s r, {}_s \theta, {}_s \phi) = (t\sqrt{m}, r\sqrt{m}, \theta, \phi)$. Then the previous formula turns to

$$ds^2 = \left(1 - \frac{2GM}{c^2 r} + \frac{4\pi G e^4}{c^4 r^2}\right) dt^2 - \frac{d_s r^2}{1 - \frac{2GM}{c^2 r} + \frac{4\pi G e^4}{c^4 r^2}} - r^2(d_s \theta^2 + \sin^2 \theta d_s \phi^2)$$

in this new coordinate system $({}_s t, {}_s r, {}_s \theta, {}_s \phi)$, whose geometrical behavior likes that of a charged gravitational field.

8.3.4 Multi-Time System. Let $\widetilde{M}(\vec{t})$ be a combinatorial field consisting of fields M_1, M_2, \dots, M_m on reference frames $(t_1, r_1, \theta_1, \phi_1), \dots, (t_m, r_m, \theta_m, \phi_m)$, respectively. These combinatorial fields discussed in last two subsections are all with $t_\mu = t$ for $1 \leq \mu \leq m$, i.e., we can establish one time variable t for all fields in this combinatorial field. But if we can not determine all the behavior of living things in the WORLD implied in the *weak anthropic principle*, for example, the uncertainty of micro-particles, we can not find such a time variable t for all fields. Then we need a multi-time system for describing the WORLD.

A *multi-time system* is such a combinatorial field $\widetilde{M}(\vec{t})$ consisting of fields M_1, M_2, \dots, M_m on reference frames $(t_1, r_1, \theta_1, \phi_1), \dots, (t_m, r_m, \theta_m, \phi_m)$, and there are always exist two integers $\kappa, \lambda, 1 \leq \kappa \neq \lambda \leq m$ such that $t_\kappa \neq t_\lambda$. The philosophical meaning of multi-time systems is nothing but a refecation of the strong anthropic principle. So it is worth to characterize such systems.

For this objective, a more interesting case appears in $\widehat{m} = 3, r_\mu = r, \theta_\mu = \theta, \phi_\mu = \phi$, i.e., beings live in the same dimensional 3 space, but with different notions on the time. Applying Theorem 8.3.1, we know the Schwarzschild and Reissner-Nordström metrics in this case following.

Schwarzschild Multi-Time System. In this case, the combinatorial metric is

$$ds^2 = \sum_{\mu=1}^m \left(1 - \frac{2Gm_\mu}{c^2 r}\right) dt_\mu^2 - \sum_{\mu=1}^m \left(1 - \frac{2Gm_\mu}{c^2 r}\right)^{-1} dr^2 - mr^2(d\theta^2 + \sin^2 \theta d\phi^2).$$

Applying the projective principle to this equation, we get metrics on gravitational fields M_1, M_2, \dots, M_m following:

$$ds_1^2 = \left(1 - \frac{2Gm_1}{c^2 r}\right) dt_1^2 - \left(1 - \frac{2Gm_1}{c^2 r}\right)^{-1} dr^2 - r^2(d\theta^2 + \sin^2 \theta d\phi^2),$$

$$ds_2^2 = \left(1 - \frac{2Gm_2}{c^2r}\right) dt_2^2 - \left(1 - \frac{2Gm_2}{c^2r}\right)^{-1} dr^2 - r^2(d\theta^2 + \sin^2 \theta d\phi^2),$$

.....,

$$ds_m^2 = \left(1 - \frac{2Gm_m}{c^2r}\right) dt_m^2 - \left(1 - \frac{2Gm_m}{c^2r}\right)^{-1} dr^2 - r^2(d\theta^2 + \sin^2 \theta d\phi^2),$$

Particularly, if $m_\mu = M$ for $1 \leq \mu \leq m$, we then get that

$$ds^2 = \left(1 - \frac{2GM}{c^2r}\right) \sum_{\mu=1}^m dt_\mu^2 - \left(1 - \frac{2GM}{c^2r}\right)^{-1} mdr^2 - mr^2(d\theta^2 + \sin^2 \theta d\phi^2).$$

Its projection on the gravitational field M_μ is

$$ds_\mu^2 = \left(1 - \frac{2GM}{c^2r}\right) dt_\mu^2 - \left(1 - \frac{2GM}{c^2r}\right)^{-1} dr^2 - r^2(d\theta^2 + \sin^2 \theta d\phi^2),$$

i.e., the Schwarzschild metric on M_μ , $1 \leq \mu \leq m$.

Reissner-Nordström Multi-Time System. In this case, the combinatorial metric is

$$ds^2 = \sum_{\mu=1}^m \left(1 - \frac{2Gm_\mu}{c^2r} + \frac{4\pi G e_\mu^4}{c^4 r^2}\right) dt_\mu^2 - \sum_{\mu=1}^m \left(1 - \frac{2Gm_\mu}{c^2r} + \frac{4\pi G e_\mu^4}{c^4 r^2}\right)^{-1} dr^2 - mr^2(d\theta^2 + \sin^2 \theta d\phi^2).$$

Similarly, by the projective principle we obtain the metrics on charged gravitational fields M_1, M_2, \dots, M_m following.

$$ds_1^2 = \left(1 - \frac{2Gm_1}{c^2r} + \frac{4\pi G e_1^4}{c^4 r^2}\right) dt_1^2 - \left(1 - \frac{2Gm_1}{c^2r} + \frac{4\pi G e_1^4}{c^4 r^2}\right)^{-1} dr^2 - r^2(d\theta^2 + \sin^2 \theta d\phi^2),$$

$$ds_2^2 = \left(1 - \frac{2Gm_2}{c^2r} + \frac{4\pi G e_2^4}{c^4 r^2}\right) dt_2^2 - \left(1 - \frac{2Gm_2}{c^2r} + \frac{4\pi G e_2^4}{c^4 r^2}\right)^{-1} dr^2 - r^2(d\theta^2 + \sin^2 \theta d\phi^2),$$

.....,

$$ds_m^2 = \left(1 - \frac{2Gm_m}{c^2r} + \frac{4\pi Ge_m^4}{c^4r^2}\right) dt_m^2 - \left(1 - \frac{2Gm_2}{c^2r} + \frac{4\pi Ge_2^4}{c^4r^2}\right)^{-1} dr^2 - r^2(d\theta^2 + \sin^2\theta d\phi^2).$$

Furthermore, if $m_\mu = M$ and $e_\mu = e$ for $1 \leq \mu \leq m$, we obtain that

$$ds^2 = \left(1 - \frac{2GM}{c^2r} + \frac{4\pi Ge^4}{c^4r^2}\right) \sum_{\mu=1}^m dt^2 - \left(1 - \frac{2GM}{c^2r} + \frac{4\pi Ge^4}{c^4r^2}\right)^{-1} mdr^2 - mr^2(d\theta^2 + \sin^2\theta d\phi^2).$$

Its projection on the charged gravitational field M_μ is

$$ds_\mu^2 = \left(1 - \frac{2GM}{c^2r} + \frac{4\pi Ge^4}{c^4r^2}\right) dt_\mu^2 - \left(1 - \frac{2GM}{c^2r} + \frac{4\pi Ge^4}{c^4r^2}\right)^{-1} dr^2 - r^2(d\theta^2 + \sin^2\theta d\phi^2)$$

i.e., the Reissner-Nordström metric on M_μ , $1 \leq \mu \leq m$.

As a by-product, these calculations and formulas mean that these beings with time notion different from that of human beings will recognize differently the structure of our universe if these beings are intellectual enough to do so.

8.3.5 Physical Condition. A simple calculation shows that the dimension of the homogenous combinatorial Euclidean space $\widetilde{M}(t)$ in Subsections 8.3.2 – 8.3.3 is

$$\dim\widetilde{M}(t) = 4m + (1 - m)\widehat{m}, \tag{8 - 14}$$

for example, $\dim\widetilde{M}(t) = 9, 11, 13$ if $\widehat{m} = 1$ and $m = 4, 5, 6$. In this subsection, we analyze these combinatorial metrics in Subsections 8.3.2 – 8.3.3 by observation of human beings. So we need to discuss two fundamental questions following:

Firstly, *what is the visible geometry of human beings?* The visible geometry is determined by the structure of our eyes. In fact, it is the spherical geometry of dimensional 3. That is why the sky looks like a spherical surface. For this result, see

references [Rei1], [Yaf1] and [Bel1] in details. In these geometrical elements, such as those of point, line, ray, block, body, \dots , etc., we can only see the image of bodies on our spherical surface, i.e., surface blocks.

Secondly, *what is the geometry of transferring information?* Here, the term *information* includes information known or not known by human beings. So the geometry of transferring information consists of all possible transferring routes. In other words, a combinatorial geometry of dimensional ≥ 1 . Therefore, not all information transferring can be seen by our eyes. But some of them can be felt by our six organs with the helps of apparatus if needed. For example, the *magnetism* or *electromagnetism* can be only detected by apparatus.

These geometrical notions enable us to explain the physical conditions on combinatorial metrics, for example, the Schwarzschild or Reissner-Nordström metrics.

Case 1. $\widehat{m} = 4$.

In this case, by the formula (8 – 14) we get that $\dim \widetilde{M}(t) = 4$, i.e., all fields M_1, M_2, \dots, M_m are in \mathbf{R}^4 , which is the most enjoyed case by human beings. We have gotten the Schwarzschild metric

$$ds^2 = \sum_{\mu=1}^m \left(1 - \frac{2Gm_{\mu}}{c^2 r} \right) dt^2 - \sum_{\mu=1}^m \left(1 - \frac{2Gm_{\mu}}{c^2 r} \right)^{-1} dr^2 - mr^2(d\theta^2 + \sin^2 \theta d\phi^2)$$

for combinatorial gravitational fields or the Reissner-Nordström metric

$$ds^2 = \sum_{\mu=1}^m \left(1 - \frac{r_{\mu s}}{r} + \frac{r_{\mu e}^2}{r^2} \right) dt^2 - \frac{dr^2}{\sum_{\mu=1}^m \left(1 - \frac{r_{\mu s}}{r} + \frac{r_{\mu e}^2}{r^2} \right)} - mr^2(d\theta^2 + \sin^2 \theta d\phi^2)$$

for charged combinatorial gravitational fields in vacuum in Subsections 8.3.2 – 8.3.3. If it is so, all the behavior of WORLD can be realized finally by human beings, particularly, the observed interval is ds and all natural things can be come true by experiments. This also means that the discover of science will be ended, i.e., we can find an ultimate theory for the WORLD - the *Theory of Everything*. This is the earnest wish of Einstein himself beginning, and then more physicists devoted all their lifetime to do so in last century.

But unfortunately, the existence of *Theory of Everything* is contradicts to the weak anthropic principle, and more and more natural phenomenons show that the WORLD is a multiple one. Whence, this case maybe wrong.

Case 2. $\widehat{m} \leq 3$.

If the WORLD is so, then $\dim \widetilde{M}(t) \geq 5$. In this case, we know the combinatorial Schwarzschild metrics and combinatorial Reissner-Nordström metrics in Subsection 8.2.2–8.2.3, for example, if $t_\mu = t$, $r_\mu = r$ and $\phi_\mu = \phi$, the combinatorial Schwarzschild metric is

$$ds^2 = \sum_{\mu=1}^m \left(1 - \frac{r_{\mu s}}{r}\right) dt^2 - \sum_{\mu=1}^m \frac{dr^2}{\left(1 - \frac{r_{\mu s}}{r}\right)} - \sum_{\mu=1}^m r^2 (d\theta_\mu^2 + \sin^2 \theta_\mu d\phi^2)$$

and the combinatorial Reissner-Nordström metric is

$$ds^2 = \sum_{\mu=1}^m \left(1 - \frac{r_{\mu s}}{r} + \frac{r_{\mu e}^2}{r^2}\right) dt^2 - \sum_{\mu=1}^m \frac{dr^2}{\left(1 - \frac{r_{\mu s}}{r} + \frac{r_{\mu e}^2}{r^2}\right)} - \sum_{\mu=1}^m r^2 (d\theta_\mu^2 + \sin^2 \theta_\mu d\phi^2).$$

Particularly, if $m_\mu = M$ and $e_\mu = e$ for $1 \leq \mu \leq m$, then we get that

$$ds^2 = \left(1 - \frac{2GM}{c^2 r}\right) m dt^2 - \frac{m dr^2}{\left(1 - \frac{2GM}{c^2 r}\right)} - \sum_{\mu=1}^m r^2 (d\theta_\mu^2 + \sin^2 \theta_\mu d\phi^2)$$

for combinatorial gravitational field and

$$ds^2 = \left(1 - \frac{2GM}{c^2 r} + \frac{4\pi G e^4}{c^4 r^2}\right) m dt^2 - \frac{m dr^2}{\left(1 - \frac{2GM}{c^2 r} + \frac{4\pi G e^4}{c^4 r^2}\right)} - \sum_{\mu=1}^m r^2 (d\theta_\mu^2 + \sin^2 \theta_\mu d\phi^2)$$

for charged combinatorial gravitational field in vacuum. In this case, the observed interval in the field M_o where human beings live is

$$ds_o = a(t, r, \theta, \phi) dt^2 - b(t, r, \theta, \phi) dr^2 - c(t, r, \theta, \phi) d\theta^2 - d(t, r, \theta, \phi) d\phi^2.$$

Then *how to we explain the differences $ds - ds_o$ in physics?* Notice that we can only observe the line element ds_o , namely, a projection of ds on M_o . Whence, all contributions in $ds - ds_o$ come from the spatial direction not observable by human

beings. In this case, we are difficult to determine the exact behavior, sometimes only partial information of the WORLD, which means that each law on the WORLD determined by human beings is an approximate result and hold with conditions.

Furthermore, if $\widehat{m} \leq 3$ holds, since there are infinite underlying connected graphs, i.e., there are infinite combinations of existent fields, we can not find an ultimate theory for the WORLD, i.e., there are no a *Theory of Everything* on the WORLD. This means the science is approximate and only a real **SCIENCE** constraint on conditions, which also implies that the discover of science will endless forever.

§8.4 COMBINATORIAL GAUGE FIELDS

A *combinatorial gauge field* $\widetilde{M}(t)$ is a combinatorial field of gauge fields M_1, M_2, \dots, M_m underlying a combinatorial structure G with local or global symmetries under a finite-dimensional Lie multi-group action on its gauge basis at an individual point in space and time, which leaves invariant of physical laws, particularly, the Lagrange density \mathcal{L} of $\widetilde{M}(t)$. We mainly consider the following problem in this section.

Problem 8.4.1 For gauge fields M_1, M_2, \dots, M_m with respective Lagrange densities $\mathcal{L}_{M_1}, \mathcal{L}_{M_2}, \dots, \mathcal{L}_{M_m}$ and action by Lie groups $\mathcal{H}_{o_1}, \mathcal{H}_{o_2}, \dots, \mathcal{H}_{o_m}$, find conditions on $\mathcal{L}_{G^L[\widetilde{M}(t)]}$, the Lie multi-group $\widetilde{\mathcal{H}}$ and $G^L[\widetilde{M}(t)]$ such that the combinatorial field $\widetilde{M}(t)$ consisting of M_1, M_2, \dots, M_m is a combinatorial gauge field.

8.4.1 Gauge Multi-Basis. For any integer i , $1 \leq i \leq m$, let M_i be gauge fields with a basis B_{M_i} and $\tau_i : B_{M_i} \rightarrow B_{M_i}$ a gauge transformation, i.e., $\mathcal{L}_{M_i}(B_{M_i}^{\tau_i}) = \mathcal{L}_{M_i}(B_{M_i})$. We first determine a gauge transformation

$$\tau_{\widetilde{M}} : \bigcup_{i=1}^m B_{M_i} \rightarrow \bigcup_{i=1}^m B_{M_i}$$

on the gauge multi-basis $\bigcup_{i=1}^m B_{M_i}$ and a Lagrange density $\mathcal{L}_{\widetilde{M}}$ with

$$\tau_{\widetilde{M}}|_{M_i} = \tau_i, \quad \mathcal{L}_{\widetilde{M}}|_{M_i} = \mathcal{L}_{M_i}$$

for integers $1 \leq i \leq m$ such that

$$\mathcal{L}_{\widetilde{M}}\left(\bigcup_{i=1}^m B_{M_i}\right)^{\tau_{\widetilde{M}}} = \mathcal{L}_{\widetilde{M}}\left(\bigcup_{i=1}^m B_{M_i}\right).$$

By Theorem 3.1.2 the Gluing Lemma, we know that if τ_i agree on overlaps, i.e., $\tau_i|_{B_{M_i} \cap B_{M_j}} = \tau_j|_{B_{M_i} \cap B_{M_j}}$ for all integers $1 \leq i, j \leq m$, then there exists a unique continuous $\tau_{\widetilde{M}} : \bigcup_{i=1}^m B_{M_i} \rightarrow \bigcup_{i=1}^m B_{M_i}$ with $\tau_{\widetilde{M}}|_{M_i} = \tau_i$ for all integers $1 \leq i \leq m$.

Notice that $\tau_i|_{B_{M_i} \cap B_{M_j}} = \tau_j|_{B_{M_i} \cap B_{M_j}}$ hold only if $(B_{M_i} \cap B_{M_j})^{\tau_i} = B_{M_i} \cap B_{M_j}$ for any integer $1 \leq j \leq m$. This is hold in condition. For example, if each τ_i is the identity mapping, i.e., $\tau_i = 1_{B_{M_i}}$, $1 \leq i \leq m$, then it is obvious that $(B_{M_i} \cap B_{M_j})^{\tau_i} = B_{M_i} \cap B_{M_j}$, and furthermore, $\tau_i|_{B_{M_i} \cap B_{M_j}} = \tau_j|_{B_{M_i} \cap B_{M_j}}$ for integers $1 \leq i, j \leq m$.

Now we define a characteristic mapping χ_{M_i} on $\{B_{M_i}; 1 \leq i \leq m\}$ as follows:

$$\chi_{M_i}(X) = \begin{cases} 1, & \text{if } X = B_{M_i}, \\ 0, & \text{otherwise.} \end{cases}$$

Then

$$\tau_{\widetilde{M}} = \sum_{i=1}^m \chi_{M_i} \tau_i.$$

In this case, the Lagrange density

$$\mathcal{L}_{\widetilde{M}} = \sum_{i=1}^m \chi_{M_i} \mathcal{L}_{M_i}$$

on \widetilde{M} holds with $\mathcal{L}_{\widetilde{M}}|_{M_i} = \mathcal{L}_{M_i}$ for each integer $1 \leq i \leq m$. Particularly, if $M_i = M$, $1 \leq i \leq m$, then

$$\bigcup_{i=1}^m B_{M_i} = B_M.$$

Whence,

$$\tau_{\widetilde{M}} = (\chi_{M_1} + \chi_{M_2} + \cdots + \chi_{M_m})\tau_M,$$

$$\mathcal{L}_{\widetilde{M}} = (\chi_{M_1} + \chi_{M_2} + \cdots + \chi_{M_m})\mathcal{L}_M,$$

where τ_M is a gauge transformation on the gauge field M . Notice that $\chi_{M_1} + \chi_{M_2} + \cdots + \chi_{M_m}$ is a constant on $\{B_{M_i}, 1 \leq i \leq m\}$, i.e.,

$$(\chi_{M_1} + \chi_{M_2} + \cdots + \chi_{M_n})(B_{M_i}) = 1$$

for integers $1 \leq i \leq m$, but it maybe not a constant on $\bigcup_{i=1}^m B_{M_i}$ for different positions of fields M_i , $1 \leq i \leq m$ in space.

Let the motion equation of gauge fields M_i be $\mathcal{F}_i(\mathcal{L}_{M_i}) = 0$ for $1 \leq i \leq m$. Applying Theorem 7.1.6, we then know the field equation of combinatorial field \widetilde{M} of M_1, M_2, \cdots, M_m to be

$$\chi_{M_1} \mathcal{F}_1(\mathcal{L}_{M_1}) + \chi_{M_2} \mathcal{F}_2(\mathcal{L}_{M_2}) + \cdots + \chi_{M_m} \mathcal{F}_m(\mathcal{L}_{M_m}) = 0$$

for the linearity of differential operation $\partial/\partial\phi$. For example, let \widetilde{M} be a combinatorial field consisting of just two gauge field, a scalar field M_1 and a Dirac field M_2 . Then the field equation of \widetilde{M} is as follows:

$$\chi_{M_1}(\partial^2 + m^2)\psi_{M_1} + \chi_{M_2}(i\gamma^\mu\partial_\mu - m)\psi_{M_2} = 0.$$

8.4.2 Combinatorial Gauge Basis. Let \widetilde{M} be a combinatorial field of gauge fields M_1, M_2, \cdots, M_m . The multi-basis $\bigcup_{i=1}^m B_{M_i}$ is a *combinatorial gauge basis* if for any automorphism $g \in \text{Aut}^{G^L}[\widetilde{M}]$,

$$\mathcal{L}_{\widetilde{M}}(\bigcup_{i=1}^m B_{M_i})^{\tau_{\widetilde{M}} \circ g} = \mathcal{L}_{\widetilde{M}}(\bigcup_{i=1}^m B_{M_i}),$$

where $\tau_{\widetilde{M}} \circ g$ means $\tau_{\widetilde{M}}$ compositing with an automorphism g , a bijection on gauge multi-basis $\bigcup_{i=1}^m B_{M_i}$. Now if $\Omega_1, \Omega_2, \cdots, \Omega_s$ are these orbits of fields M_1, M_2, \cdots, M_m under the action of $\text{Aut}^{G^L}[\widetilde{M}]$, then there must be that

$$M_1^\alpha = M_2^\alpha \quad \text{if } M_1^\alpha, M_2^\alpha \in \Omega_\alpha, \quad 1 \leq \alpha \leq s$$

by the condition $\tau_{\widetilde{M}}|_{M_i^g} = \tau_i$, $1 \leq i \leq m$. Applying the characteristic mapping χ_{M_i} in Section 8.4.1, we know that

$$\tau_{\widetilde{M}} = \sum_{\alpha=1}^s \left(\sum_{M_i^\alpha \in \Omega_\alpha} \chi_{M_i^\alpha} \right) \tau_i.$$

In this case, the Lagrange density

$$\mathcal{L}_{\widetilde{M}} = \sum_{\alpha=1}^s |(\sum_{M_i^\alpha \in \Omega_\alpha} \chi_{M_i^\alpha}) \mathcal{L}_{M_i}$$

on \widetilde{M} holds with $\mathcal{L}_{\widetilde{M}}|_{M_i} = \mathcal{L}_{M_i}$ for each integer $1 \leq i \leq m$.

We discussed two interesting cases following.

Case 1. $G^L[\widetilde{M}]$ is transitive.

Because $G^L[\widetilde{M}]$ is transitive, there are only one orbit $\Omega = \{M_1, M_2, \dots, M_m\}$. Whence, $M_i = M$ for integers $1 \leq i \leq m$, i.e., the combinatorial field \widetilde{M} is consisting of one gauge field M underlying a transitive graph $G^L[\widetilde{M}]$.

In this case, we easily know that

$$\bigcup_{i=1}^m B_{M_i} = B_M,$$

$$\tau_{\widetilde{M}} = (\chi_{M_1} + \chi_{M_2} + \dots + \chi_{M_m})\tau_M$$

and

$$\mathcal{L}_{\widetilde{M}} = (\chi_{M_1} + \chi_{M_2} + \dots + \chi_{M_m})\mathcal{L}_M,$$

which is the same as the case of gauge multi-basis with a combinatorial gauge basis.

Case 2. $G^L[\widetilde{M}]$ is non-symmetric.

Since $G^L[\widetilde{M}]$ is non-symmetric, i.e., $\text{Aut}G^L[\widetilde{M}]$ is trivial, there fields M_1, M_2, \dots, M_m are distinct two by two. Whence, the combinatorial field \widetilde{M} is consisting of gauge fields M_1, M_2, \dots, M_m underlying a non-symmetric graph $G^L[\widetilde{M}]$ with $\tau_i|_{B_{M_i} \cap B_{M_j}} = \tau_j|_{B_{M_i} \cap B_{M_j}}$ for all integers $1 \leq i, j \leq m$.

In this case, $\tau_{\widetilde{M}}$ and $\mathcal{L}_{\widetilde{M}}$ are also the same as the case of gauge multi-basis with a combinatorial gauge basis.

8.4.3 Combinatorial Gauge Field. By gauge principle, a *globally or locally combinatorial gauge field* is a combinatorial field \widetilde{M} under a gauge transformation $\tau_{\widetilde{M}} : \widetilde{M} \rightarrow \widetilde{M}$ independent or dependent on the field variable \vec{x} . If a combinatorial gauge field \widetilde{M} is consisting of gauge fields M_1, M_2, \dots, M_m , we can easily find that \widetilde{M} is a *globally combinatorial gauge field only if each gauge field is global*. By the discussion of Subsection 8.4.2, we have known that a combinatorial field consisting

of gauge fields M_1, M_2, \dots, M_m is a combinatorial gauge field if $M_1^\alpha = M_2^\alpha$ for $\forall M_1^\alpha, M_2^\alpha \in \Omega_\alpha$, where Ω_α , $1 \leq \alpha \leq s$ are orbits of M_1, M_2, \dots, M_m under the action of $\text{Aut}G^L[\widetilde{M}]$. In this case, each gauge transformation can be represented by $\tau \circ g$, where τ is a gauge transformation on a gauge field M_i , $1 \leq i \leq m$ and $g \in \text{Aut}G^L[\widetilde{M}]$ and

$$\tau_{\widetilde{M}} = \sum_{\alpha=1}^s \left(\sum_{M_i^\alpha \in \Omega_\alpha} \chi_{M_i^\alpha} \right) \tau_i, \quad \mathcal{L}_{\widetilde{M}} = \sum_{\alpha=1}^s \left| \left(\sum_{M_i^\alpha \in \Omega_\alpha} \chi_{M_i^\alpha} \right) \mathcal{L}_{M_i} \right|.$$

All of these are dependent on the characteristic mapping χ_{M_i} , $1 \leq i \leq m$, and difficult for use. Then

whether can we construct the gauge transformation $\tau_{\widetilde{M}}$ and Lagrange density $\mathcal{L}_{\widetilde{M}}$ independent on χ_{M_i} , $1 \leq i \leq m$?

Certainly, the answer is YES! We can really construct locally combinatorial gauge fields by applying embedded graphs on surfaces as follows.

Let $\varsigma : G^L[\widetilde{M}] \rightarrow S$ be an embedding of the graph $G^L[\widetilde{M}]$ on a surface S , i.e., a compact 2-manifold without boundary with a face set $\mathcal{F} = \{F_1, F_2, \dots, F_l\}$ on S . By assumption, if $(M_{i_1}, M_{i_2}) \in E(G^L[\widetilde{M}])$, then $M_{i_1} \cap M_{i_2}$ is also a gauge field under the action of $\tau_{i_1}|_{M_{i_1} \cap M_{i_2}} = \tau_{i_2}|_{M_{i_1} \cap M_{i_2}}$. Whence, we can always choose a Lagrange density $\mathcal{L}_{M_{i_1} \cap M_{i_2}}$.

Now relabel vertices and edges of $G^L[\widetilde{M}]$ by

$$M_i^L = \mathcal{L}_{M_i}, \quad (M_i, M_j)^L = \mathcal{L}_{M_{i_1} \cap M_{i_2}} \text{ for } 1 \leq i, j \leq m$$

with $(M_j, M_i)^L = -(M_i, M_j)^L$, and if $F_i = M_{i_1} M_{i_2} \dots M_{i_s}$, then label the face F_i by

$$F_i^L = \mathcal{L}_{M_{i_1} \cap M_{i_2}} + \mathcal{L}_{M_{i_2} \cap M_{i_3}} + \dots + \mathcal{L}_{M_{i_s} \cap M_{i_1}},$$

called the *fluctuation on F_i* . Choose the Lagrange density

$$\mathcal{L}_{\widetilde{M}} = \frac{1}{4c_1} \sum_{\substack{(M_i, M_j) \in E(\mathcal{F}) \\ F \in \mathcal{F}}} (\dot{\mathcal{L}}_{M_i \cap M_j} + \mathcal{L}_{M_i} - \mathcal{L}_{M_j})^2 - \frac{c_2}{2} \sum_{F \in \mathcal{F}} (F^L)^2,$$

where c_1, c_2 are constants. Then $\mathcal{L}_{\widetilde{M}}$ is invariant under the action of $\tau \circ g$ for a gauge transformation τ on a gauge field M_i , $1 \leq i \leq m$ and $g \in \text{Aut}G^L[\widetilde{M}]$. Furthermore, define a transformation

$$\iota : \mathcal{L}_{M_i \cap M_j} \rightarrow \mathcal{L}_{M_i \cap M_j} + \phi_j(t) - \phi_i(t),$$

$$\iota : L_{M_i}(t) \rightarrow L_{M_i}(t) + \dot{\phi}_i(t),$$

where $\phi_i(t)$ is a function on field M_i , $1 \leq i \leq m$. Calculation shows that

$$\begin{aligned} \iota & : \dot{\mathcal{L}}_{M_i \cap M_j} + \mathcal{L}_{M_i} - \mathcal{L}_{M_j} \\ & \rightarrow \dot{\mathcal{L}}_{M_i \cap M_j} + \dot{\phi}_j(t) - \dot{\phi}_i(t) + \mathcal{L}_{M_i} + \dot{\phi}_i(t) - \mathcal{L}_{M_j} - \dot{\phi}_j(t) \\ & = \dot{\mathcal{L}}_{M_i \cap M_j} + \mathcal{L}_{M_i} - \mathcal{L}_{M_j} \end{aligned}$$

and

$$\begin{aligned} \iota & : F_i^L = \mathcal{L}_{M_{i_1} \cap M_{i_2}} + \mathcal{L}_{M_{i_2} \cap M_{i_3}} + \cdots + \mathcal{L}_{M_{i_s} \cap M_{i_1}} \\ & \rightarrow \mathcal{L}_{M_{i_1} \cap M_{i_2}} + \dot{\phi}_{i_2}(t) - \dot{\phi}_{i_1}(t) + \cdots + \mathcal{L}_{M_{i_s} \cap M_{i_1}} + \dot{\phi}_{i_1}(t) - \dot{\phi}_{i_s}(t) \\ & = \mathcal{L}_{M_{i_1} \cap M_{i_2}} + \mathcal{L}_{M_{i_2} \cap M_{i_3}} + \cdots + \mathcal{L}_{M_{i_s} \cap M_{i_1}} = F_i^L. \end{aligned}$$

Therefore, $\mathcal{L}_{\tilde{M}}^L = \mathcal{L}_{\tilde{M}}$, i.e., ι is a gauge transformation. This construction can be used to describe physical objectives. For example, let $G^L[\tilde{M}]$ be a normal lattice partially show in Fig.8.4.1 following,

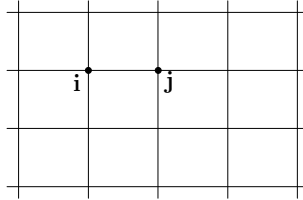

Fig.8.4.1

Let the label on vertex \mathbf{i} be $\mathcal{L}_i = a_0(\mathbf{i})$, a scalar and a label on edge (\mathbf{i}, \mathbf{j}) be $\mathcal{L}_{M_i \cap M_j} = a_{ij}$, a vector with $a_{ji} = -a_{ij}$. Choose constants $c_1 = J$ and $c_2 = q$ and

$$\mathcal{L}_{\tilde{M}} = \frac{1}{4J} \sum_{\mathbf{i}, \mu = \mathbf{x}, \mathbf{y}} (\dot{a}_{\mathbf{i}, \mathbf{i} + \mu} + a_0(\mathbf{i}) - a_0(\mathbf{i} + \mu))^2 - \frac{q}{2} \sum_F (F^L)^2.$$

Then as it was done in [Wen1], we can use this combinatorial gauge field to describe spin liquids, also explain some fundamental questions in physics.

8.4.4 Geometry on Combinatorial Gauge Field. We have presented a geometrical model of combinatorial field in Subsection 8.1.3. Combining this model with combinatorially principal fiber bundles discussed in Section 6.5, we can establish a geometrical model of combinatorial gauge field, which also enables us to know what is the gauge basis of a combinatorial gauge field.

Likewise the geometrical model of gauge field, let $\tilde{P}^\alpha(\tilde{M}, \mathcal{L}_G)$ be a combinatorially principal fibre bundle over a differentially combinatorial manifold \tilde{M} consisting of $M_i, 1 \leq i \leq l, (G^L[\tilde{M}], \alpha)$ a voltage graph with a voltage assignment $\alpha : G^L[\tilde{M}] \rightarrow \mathfrak{G}$ over a finite group \mathfrak{G} , which naturally induced a projection $\pi : G^L[\tilde{P}] \rightarrow G^L[\tilde{M}]$ and $P_{M_i}(M_i, \mathcal{H}_{o_i}), 1 \leq i \leq l$ a family of principal fiber bundles over manifolds M_1, M_2, \dots, M_l . By Construction 6.5.1, $\tilde{P}^\alpha(\tilde{M}, \mathcal{L}_G)$ is constructed by for $\forall M \in V(G^L[\tilde{M}])$, place P_M on each lifting vertex $M^{L\alpha}$ in the fiber $\pi^{-1}(M)$ of $G^{L\alpha}[\tilde{M}]$ if $\pi(P_M) = M$. Consequently, we know that

$$\tilde{P} = \bigcup_{M \in V(G^L[\tilde{M}])} P_M, \quad \mathcal{L}_G = \bigcup_{M \in V(G^L[\tilde{M}])} \mathcal{H}_M$$

and a projection $\Pi = \pi \Pi_M \pi^{-1}$ for $\forall M \in V(G^L[\tilde{M}])$. By definition, a combinatorial principal fiber bundle $\tilde{P}^\alpha(\tilde{M}, \mathcal{L}_G)$ is $\text{Aut}^{G^{L\alpha}}[\tilde{M}] \times \mathcal{L}_G$ -invariant. So it is naturally a combinatorial gauge field under the action of $\text{Aut}^{G^{L\alpha}}[\tilde{M}] \times \mathcal{L}_G$. We clarify its gauge and gauge transformations first.

For a combinatorial principal fiber bundle $\tilde{P}^\alpha(\tilde{M}, \mathcal{L}_G)$, we know its a local trivialization LT is such a diffeomorphism $T^x : \Pi^{-1}(U_x) \rightarrow U_x \times \mathcal{L}_G$ for $\forall x \in M_{o_i}$ with

$$T^x|_{\Pi^{-1}(U_x)} = T_i^x : \Pi_i^{-1}(U_x) \rightarrow U_x \times \mathcal{H}_{o_i}; x \rightarrow T_i^x(x) = (\Pi_i(x), \epsilon(x)),$$

such that $\epsilon(x \circ_i g) = \epsilon(x) \circ_i g$ for $\forall g \in \mathcal{H}_{o_i}, \epsilon(x) \in \mathcal{H}_{o_i}$. In physics, such a local trivialization $T^x, x \in \tilde{M}$ is called a *gauge*.

If we denote by B_{M_i} the gauge basis of $P_{M_i}(M_i, \mathcal{H}_{o_i})$ consisting of such gauges $T^x, x \in M_i$ for integers $1 \leq i \leq l$, then we know the gauge basis of combinatorial gauge field \tilde{M} is $\bigcup_{i=1}^l B_{M_i}$ underlying the graph $G^L[\tilde{M}]$. According to the discussion in Subsections 8.4.1 – 8.4.2, we can always find a general form of gauge transformation $\tau_{\tilde{M}}$ action on $\bigcup_{i=1}^l B_{M_i}$ by applying gauge transformations τ_i on M_i and characteristic mapping χ_{M_i} for integers $1 \leq i \leq l$.

Notice that an automorphism of \tilde{P} can not ensure the invariance of Lagrange density $\mathcal{L}_{\tilde{M}}$ in general. A *gauge transformation* of $\tilde{P}^\alpha(\tilde{M}, \mathcal{L}_G)$ is such an automorphism $\omega : \tilde{P} \rightarrow \tilde{P}$ with $\bar{\omega}$ =identity transformation on \tilde{M} , i.e., $\Pi(p) = \Pi(\omega(p))$ for $p \in \tilde{P}$. Whence, $\mathcal{L}_{\tilde{M}}$ is invariant under the action of ω , i.e.,

$$\mathcal{L}_{\tilde{M}}\left(\bigcup_{i=1}^l B_{M_i}\right)^\omega = \mathcal{L}_{\tilde{M}}\left(\bigcup_{i=1}^l B_{M_i}\right).$$

As we have discussed in Subsections 6.5.3 – 6.5.4, there gauge transformations come from two sources. One is the gauge transformations τ_{M_i} of the gauge field M_i , $1 \leq i \leq l$. Another is the symmetries of the lifting graph $G^{L\alpha}[\tilde{M}]$, which extends the inner symmetries to the outer in a combinatorial field. Whence, the combinatorial principal fiber bundle enables us to find more gauge fields for applications.

Now let $\overset{1}{\omega}$ be the local connection 1-form, $\overset{2}{\Omega} = \tilde{d} \overset{1}{\omega}$ the curvature 2-form of a local connection on $\tilde{P}^\alpha(\tilde{M}, \mathcal{L}_G)$ and $\Lambda : \tilde{M} \rightarrow \tilde{P}$, $\Pi \circ \Lambda = \text{id}_{\tilde{M}}$ be a local cross section of $\tilde{P}^\alpha(\tilde{M}, \mathcal{L}_G)$. Similar to that of gauge fields, we consider

$$\tilde{A} = \Lambda^* \overset{1}{\omega} = \sum_{\mu\nu} A_{\mu\nu} dx^{\mu\nu},$$

$$\tilde{F} = \Lambda^* \overset{2}{\Omega} = \sum F_{(\mu\nu)(\kappa\lambda)} dx^{\mu\nu} \wedge dx^{\kappa\lambda}, \quad \tilde{d} \tilde{F} = 0,$$

which are called the *combinatorial gauge potential* and *combinatorial field strength*, respectively. Let $\gamma : \tilde{M} \rightarrow \mathbf{R}$ and $\Lambda' : \tilde{M} \rightarrow \tilde{P}$, $\Lambda'(\bar{x}) = e^{i\gamma(\bar{x})}\Lambda(\bar{x})$. If $\tilde{A}' = \Lambda'^* \overset{1}{\omega}$, then we have

$$\overset{1}{\omega}'(X) = g^{-1} \overset{1}{\omega}(X')g + g^{-1}dg, \quad g \in \mathcal{L}_G,$$

for $dg \in T_g(\mathcal{L}_G)$, $X = \tilde{d}R_g X'$ by properties of local connections on combinatorial principal fiber bundles discussed in Section 6.5, which finally yields equations following

$$\tilde{A}' = \tilde{A} + \tilde{d} \tilde{A}, \quad \tilde{d} \tilde{F}' = \tilde{d} \tilde{F}, \tag{8 – 15}$$

i.e., the gauge transformation law on field. The equation (8 – 15) enables one to obtain the local form of \tilde{F} as they contributions to Maxwell or Yang-Mills fields in Subsection 7.4.7.

Now if we choose $\overset{1}{\omega}$ and $\overset{2}{\Omega} = \tilde{d} \overset{1}{\omega}$ be the global connection 1-form, the curvature 2-form of a global connection on $\tilde{P}^\alpha(\tilde{M}, \mathcal{L}_G)$, respectively, we can similarly establish equations (8 – 15) by applying properties of global connections on a combinatorial principal fiber bundle $\tilde{P}^\alpha(\tilde{M}, \mathcal{L}_G)$ established in Section 6.5, and then apply them to determine the behaviors of combinatorial gauge fields.

8.4.5 Higgs Mechanism on Combinatorial Gauge Field. Let $\Phi_{\tilde{M}_0}$ be the *vacuum state* in a combinatorial gauge field \tilde{M} consisting of gauge fields M_1, M_2, \dots, M_m with the Lagrangian $\mathcal{L}_{\tilde{M}} = \mathcal{L}_1 + V_{\tilde{M}}(\Phi_{\tilde{M}})$, where $V_{\tilde{M}}(\Phi_{\tilde{M}})$ stands for the interaction potential in \tilde{M} , $\text{Aut}^{G^L}[\tilde{M}] \times \mathcal{L}_G$ a gauge multi-group and $g \rightarrow \varphi(g)$ a representation of $\text{Aut}^{G^L}[\tilde{M}] \times \mathcal{L}_G$. Define

$$\Phi_{\tilde{M}_0} = \varphi(\text{Aut}^{G^L}[\tilde{M}] \times \mathcal{L}_G)\Phi_{\tilde{M}_0} = \{\varphi(g)\Phi_{\tilde{M}_0} | g \in \text{Aut}^{G^L}[\tilde{M}] \times \mathcal{L}_G\}, \quad (8-16)$$

and $(\text{Aut}^{G^L}[\tilde{M}] \times \mathcal{L}_G)_0 = \{g \in \text{Aut}^{G^L}[\tilde{M}] \times \mathcal{L}_G | \varphi(g)\Phi_{\tilde{M}_0} = \Phi_{\tilde{M}_0}\}$. Then \tilde{M}_0 is called a *homogenous space* of $\text{Aut}^{G^L}[\tilde{M}] \times \mathcal{L}_G$, that is,

$$\begin{aligned} \tilde{M}_0 &= \text{Aut}^{G^L}[\tilde{M}] \times \mathcal{L}_G / (\text{Aut}^{G^L}[\tilde{M}] \times \mathcal{L}_G)_0 \\ &= \{\varphi(g)\Phi_{\tilde{M}_0} | g \in \text{Aut}^{G^L}[\tilde{M}] \times \mathcal{L}_G\}. \end{aligned} \quad (8-17)$$

Similarly, a gauge symmetry in $\text{Aut}^{G^L}[\tilde{M}] \times \mathcal{L}_G$ associated with a combinatorial gauge field is said to be *spontaneously broken* if and only if there is a vacuum manifold \tilde{M}_0 defined in (8 – 17) gotten by a vacuum state $\Phi_{\tilde{M}_0}$ defined in (8 – 16). Furthermore, if we let $V_{\tilde{M}}(\Phi_{\tilde{M}_0}) = 0$ and $V_{\tilde{M}}(\varphi(g)\Phi_{\tilde{M}}) = V(\Phi_{\tilde{M}})$, then there must be $V_{\tilde{M}}(\varphi(g)\Phi_{\tilde{M}_0}) = 0$. Therefore, we can rewrite $\tilde{M}_0 = \{\Phi_{\tilde{M}} | V_{\tilde{M}}(\Phi_{\tilde{M}}) = 0\}$.

Notice that $\Phi_{\tilde{M}}|_{M_i} = \Phi_{M_i}$ and $V_{\tilde{M}}|_{M_i} = V_{M_i}$ for $1 \leq i \leq m$. Whence, by ap[p]lying the characteristic mapping χ_{M_i} we know that

$$\begin{aligned} \Phi_{\tilde{M}} &= \sum_{i=1}^m \chi_{M_i} \Phi_{M_i}, \\ V_{\tilde{M}} &= \sum_{i=1}^m \chi_{M_i} V_{M_i}. \end{aligned}$$

Now if $V_{M_i}(\Phi_{M_i^0}) = 0$, define \tilde{M}^0 to be a combinatorial field consisting of M_i^0 , $1 \leq i \leq m$, i.e.,

$$\Phi_{\widetilde{M}^0} = \sum_{i=1}^m \chi_{M_i} \Phi_{M_i^0}.$$

Then we get that

$$\begin{aligned} V_{\widetilde{M}}(\Phi_{\widetilde{M}^0}) &= V_{\widetilde{M}}\left(\sum_{k=1}^m \chi_{M_k} \Phi_{M_k^0}\right) \\ &= \sum_{k=1}^m \chi_{M_k} V_{M_k}\left(\sum_{i=1}^m \chi_{M_i} \Phi_{M_i^0}\right) \\ &= \sum_{k=1}^m \chi_{M_k} V_{M_k}(\Phi_{M_k^0}) = 0. \end{aligned}$$

Conversely, if $V_{\widetilde{M}}(\Phi_{\widetilde{M}^0}) = 0$, then $V_{\widetilde{M}}(\Phi_{\widetilde{M}^0})|_{M_i} = 0$, i.e., $V_{M_i}(\Phi_{\widetilde{M}^0})|_{M_i} = 0$ for integers $1 \leq i \leq m$. Let $M_i^0 = \widetilde{M}^0|_{M_i}$. Then $\Phi_{M_i^0} = \Phi_{\widetilde{M}^0}|_{M_i}$. We get that $V_{M_i}(\Phi_{M_i^0}) = 0$, i.e.,

$$\Phi_{\widetilde{M}^0} = \sum_{i=1}^m \chi_{M_i} \Phi_{M_i^0}.$$

Summing up all discussion in the above, we get the next result.

Theorem 8.4.1 *Let \widetilde{M} be consisting of gauge fields M_1, M_2, \dots, M_m with the Lagrangian $\mathcal{L}_{\widetilde{M}} = \mathcal{L}_1 + V_{\widetilde{M}}(\Phi_{\widetilde{M}})$. If $\Phi_{\widetilde{M}^0}$ is its vacuum state of \widetilde{M} and $\Phi_{\widetilde{M}^0}|_{M_i} = \Phi_{M_i^0}$, $1 \leq i \leq m$, Then \widetilde{M}^0 is a combinatorial field consisting of M_i^0 for $1 \leq i \leq m$.*

Particularly, if $M_i = M$ for integers $1 \leq i \leq m$, then we get that

$$V_{\widetilde{M}}(\Phi_{\widetilde{M}}) = 0 \quad \Leftrightarrow \quad \left(\sum_{i=1}^m \chi_{M_i}\right)V_M(\Phi_M) = 0.$$

Notice that we can not get

$$V_{\widetilde{M}}(\Phi_{\widetilde{M}}) = 0 \quad \Leftrightarrow \quad V_M(\Phi_M) = 0 \quad (8-18)$$

in general. Now if (8-18) hold, then we must get that $\chi_1 = \chi_2 = \dots = \chi_m = 1_M$, i.e., $G^L[\widetilde{M}]$ is a transitive graph and all these gauge fields M are in a same space, for example, the Minkowskian space $\{(ict, x, y, z) \mid x, y, z \in \mathbf{R}^3, t \in \mathbf{R}\}$.

§8.5 APPLICATIONS

The multi-laterality of WORLD alludes multi-lateralities of things in the WORLD, also more applicable aspects of combinatorial fields. In fact, as we wish to recognize the behavior of a family of things with interactions, the best model of candidates is nothing but a combinatorial field.

8.5.1 Many-Body Mechanics. The many-body mechanics is an area which provides the framework for understanding the collective behavior of vast assemblies of interacting particles, such as those of solar system, milky way, \dots , etc.. We have known a physical laws that govern the motion of an individual particle may be simple or not, but the behavior of collection particles can be extremely complex. For being short of mathematical means on many-bodies over a long period of time, one know few laws of many-body systems, even for two-body systems.

Let \widetilde{M} be a many-body system consisting of bodies M_1, M_2, \dots, M_n . For example, let \widetilde{M} be the solar system, then $M_1 = \text{Sun}$, $M_2 = \text{Mercury}$, $M_3 = \text{Venus}$, $M_4 = \text{Earth}$, $M_5 = \text{Mars}$, $M_6 = \text{Jupiter}$, Saturn, $M_7 = \text{Uranus}$ and $M_8 = \text{Neptune}$ such as those shown in Fig. 8.5.1.

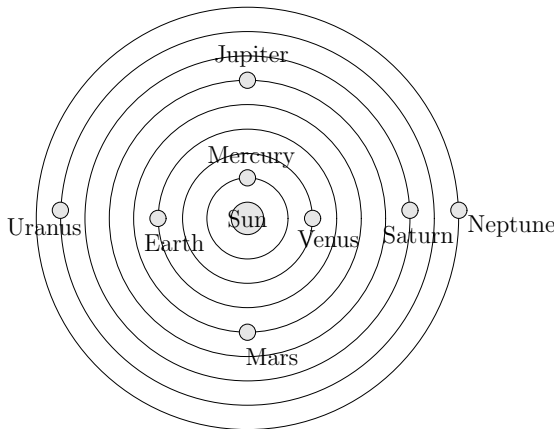

Fig.8.5.1

Now if we wish to characterize the dynamic behavior of solar system, not just one of its planet, we can apply the combinatorial field \widetilde{M} with $G^L[\widetilde{M}] = K_9$ for its

development in \mathbf{R}^3 on the time t .

Notice that the solar system is not a conservation system. It is an opened system. As we turn these actions between planets to internal actions of \widetilde{M} , there are still external actions coming from other planets not in solar system. So we can only find an approximate model by combinatorial field. More choice of planets in the universe beyond the solar system, for example, a combinatorial field on milky way, then more accurate result on the behavior of solar system will be found.

8.5.2 Cosmology. Modern cosmology was established upon Einstein's general relativity, which claims that our universe was brought about a Big Bang and from that point, the time began. But there are no an argument explaining *why just exploded once*. It seems more reasonable that exploded many times if one Big Bang is allowed to happen for the WORLD. Then the universe is not lonely existent, but parallel with other universes. If so, a right model of the WORLD should be a combinatorial one \widetilde{U} consisting of universes U_1, U_2, \dots, U_n for some integers $n \geq 2$, where U_i is an universe brought about by the i th Big Bang, a manifold in mathematics.

Applying the sheaf structure of space in algebraic geometry, a multi-space model for the universe was given in references [Mao3] and [Mao10]. Combining that model with combinatorial fields, we present a combinatorial model of the universe following.

A *combinatorial universe* is constructed by a triple (Ω, Δ, T) , where

$$\Omega = \bigcup_{i \geq 0} \Omega_i, \quad \Delta = \bigcup_{i \geq 0} O_i$$

and $T = \{t_i; i \geq 0\}$ are respectively called the universes, the operation or the time set with the following conditions hold.

(1) (Ω, Δ) is a combinatorial field $\widetilde{M}(t_i; i \geq 0)$ underling a combinatorial structure G and dependent on T , i.e., (Ω_i, O_i) is dependent on time parameter t_i for any integer $i, i \geq 0$.

(2) For any integer $i, i \geq 0$, there is a sub-field sequence

$$(S) : \Omega_i \supset \dots \supset \Omega_{i1} \supset \Omega_{i0}$$

in the field (Ω_i, O_i) and for two sub-fields (Ω_{ij}, O_i) and (Ω_{il}, O_i) , if $\Omega_{ij} \supset \Omega_{il}$, then there is a homomorphism $\rho_{\Omega_{ij}, \Omega_{il}} : (\Omega_{ij}, O_i) \rightarrow (\Omega_{il}, O_i)$ such that

(i) for $\forall(\Omega_{i1}, O_i), (\Omega_{i2}, O_i)(\Omega_{i3}, O_i) \in (S)$, if $\Omega_{i1} \supset \Omega_{i2} \supset \Omega_{i3}$, then

$$\rho_{\Omega_{i1}, \Omega_{i3}} = \rho_{\Omega_{i1}, \Omega_{i2}} \circ \rho_{\Omega_{i2}, \Omega_{i3}},$$

where “ \circ ” denotes the composition operation on homomorphisms.

(ii) for $\forall g, h \in \Omega_i$, if for any integer i , $\rho_{\Omega, \Omega_i}(g) = \rho_{\Omega, \Omega_i}(h)$, then $g = h$.

(iii) for $\forall i$, if there is an $f_i \in \Omega_i$ with

$$\rho_{\Omega_i, \Omega_i \cap \Omega_j}(f_i) = \rho_{\Omega_j, \Omega_i \cap \Omega_j}(f_j)$$

for integers $i, j, \Omega_i \cap \Omega_j \neq \emptyset$, then there exists an $f \in \Omega$ such that $\rho_{\Omega, \Omega_i}(f) = f_i$ for any integer i .

If we do not consider its combinatorial structure $G^L[\widetilde{M}]$, $\widetilde{M}(t_i; i \geq 0)$ is become a multi-space. Because the choice of $G^L[\widetilde{M}]$ and integer n is arbitrary, we can establish infinite such combinatorial models for the universe. The central problem in front of us is to determine *which is the proper one*.

Certainly, the simplest case is $|G^L[\widetilde{M}]| = 1$, overlooking the combinatorial structure $G^L[\widetilde{M}]$. For example, for dimensional 5 or 6 spaces, it has been established a dynamical theory in [Pap1]and [Pap2]. In this dynamics, we look for a solution in the Einstein’s equation of gravitational field in 6-dimensional spacetime with a metric of the form

$$ds^2 = -n^2(t, y, z)dt^2 + a^2(t, y, z)d\sum_k^2 + b^2(t, y, z)dy^2 + d^2(t, y, z)dz^2$$

where $d\sum_k^2$ represents the 3-dimensional spatial sections metric with $k = -1, 0, 1$, corresponding to the hyperbolic, flat and elliptic spaces, respectively. For a 5-dimensional spacetime, deletes the undefinite z in this metric form. Now consider a 4-brane moving in a 6-dimensional *Schwarzschild-ADS spacetime*, the metric can be written as

$$ds^2 = -h(z)dt^2 + \frac{z^2}{l^2}d\sum_k^2 + h^{-1}(z)dz^2,$$

where

$$d \sum_k^2 = \frac{dr^2}{1 - kr^2} + r^2 d\Omega_{(2)}^2 + (1 - kr^2) dy^2,$$

$$h(z) = k + \frac{z^2}{l^2} - \frac{M}{z^3}$$

and the energy-momentum tensor on the brane is

$$\hat{T}_{\mu\nu} = h_{\nu\alpha} T_{\mu}^{\alpha} - \frac{1}{4} T h_{\mu\nu}$$

with $T_{\mu}^{\alpha} = \text{diag}(-\rho, p, p, p, \hat{p})$. Then the equation of a 4-dimensional universe moving in a 6-spacetime is

$$2 \frac{\ddot{R}}{R} + 3 \left(\frac{\dot{R}}{R}\right)^2 = -3 \frac{\kappa_{(6)}^4}{64} \rho^2 - \frac{\kappa_{(6)}^4}{8} \rho p - 3 \frac{\kappa}{R^2} - \frac{5}{l^2}$$

by applying the *Darmois-Israel conditions* for a moving brane, i.e., $[K_{\mu\nu}] = -\kappa_{(6)}^2 \hat{T}_{\mu\nu}$, where $K_{\mu\nu}$ is the extrinsic curvature tensor. Similarly, for the case of $a(z) \neq b(z)$, the equations of motion of the brane are

$$\frac{d^2 \dot{R} - d\ddot{R}}{\sqrt{1 + d^2 \dot{R}^2}} - \frac{\sqrt{1 + d^2 \dot{R}^2}}{n} (d\dot{n}\dot{R} + \frac{\partial_z n}{d} - (d\partial_z n - n\partial_z d)\dot{R}^2) = -\frac{\kappa_{(6)}^4}{8} (3(p + \rho) + \hat{p}),$$

$$\frac{\partial_z a}{ad} \sqrt{1 + d^2 \dot{R}^2} = -\frac{\kappa_{(6)}^4}{8} (\rho + p - \hat{p}),$$

$$\frac{\partial_z b}{bd} \sqrt{1 + d^2 \dot{R}^2} = -\frac{\kappa_{(6)}^4}{8} (\rho - 3(p - \hat{p})).$$

Problem 8.5.1 *Establish dynamics of combinatorial universe by solve combinatorial Einstein's gravitational equations in Section 8.2 for a given structure G, particularly, the complete graph K_n for $n \geq 2$.*

8.5.3 Physical Structure. The uncertainty of particle reflects its multi-laterality, also reveals the shortage of classical wave function in physics. As we have seen in Subsection 8.5.1, the multi-laterality of particle should be best characterized by a combinatorial model, i.e., the wave function $\phi(\overline{x})$ is on a combinatorial space $\widetilde{M}(t)$ consisting of spaces $M_1(t), M_2(t), \dots, M_n(t)$ for $n \geq 2$. For example, to determine the behavior of freely electron, we can apply the combinatorial Dirac field, such as

$$\phi_{\widetilde{M}} = \sum_{i=1}^n c_i \phi_{M_i};$$

$$\mathcal{L}_{G^L[\widetilde{M}]} = \sum_{i=1}^n \bar{\psi}_{M_i} (i\gamma^{\mu_i} \partial_{\mu_i} - m_i) \psi_{M_i} + \sum_{(M_i, M_j) \in E(G^L[\widetilde{M}])} b_{ij} \psi_{M_i} \psi_{M_j} + C,$$

where b_{ij} , m_i , c_i , C are constants for integers $1 \leq i, j \leq n$ and with

$$\sum_{i=1}^n \frac{1}{c_i} (i\gamma^{\mu_i} \partial_{\mu_i} - m_i) \psi_{M_i} - \sum_{(M_i, M_j) \in E(G^L[\widetilde{M}])} b_{ij} \left(\frac{\psi_{M_j}}{c_i} + \frac{\psi_{M_i}}{c_j} \right) = 0$$

the equation of field established in Subsection 8.2.3.

Another application of combinatorial field to physical structure is that it presents a model for atoms and molecules. As we said, the combinatorial field can provides a physical model for many-body systems, which can naturally be used for quantum many-body system, such as those of atoms, molecules and other substances.

8.5.4 Economical Field. An *economical field* is an organized system of functional arrangement of parts. Let $P_1(t, \bar{x}), P_2(t, \bar{x}), \dots, P_s(t, \bar{x})$, $s \geq 1$ be parts dependent on factors \bar{x} in an economical field \widetilde{E}_S . Certainly, some of $P_1(t, \bar{x}), P_2(t, \bar{x}), \dots, P_s(t, \bar{x})$ may be completely or partially confined by others. If we view each parts $P_i(t, \bar{x})$ to be a field, or a smooth manifold in mathematics, then \widetilde{E}_S is a combinatorial fields consisting of fields $P_1(t, \bar{x}), P_2(t, \bar{x}), \dots, P_s(t, \bar{x})$. Therefore, we can apply results, such as those of differential properties on combinatorial manifolds in Chapters 4 – 6 to grasp the behavior of an economical field and then release the econometric forecasting for regional or global economy.

As a special case, a *circulating economical field* is a combinatorial field $\widetilde{M}(t)$ consisting of economical fields $M_1(t), M_2(t), \dots, M_s(t)$ underlying a circuit $G^L[\widetilde{M}] = C_s$ for an integer $s \geq 2$, such as those shown in Fig.8.5.2.

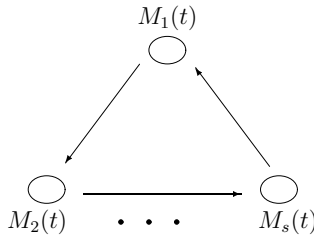

Fig.8.5.2

Today, nearly every regional economy is open with interplay. Besides the development of economy, an urgent thing is to set up a conservation system of human being with nature in harmony, i.e., to make use of matter and energy rationally and everlastingly, to decrease the unfavorable effect that economic activities may make upon our natural environment as far as possible, which implies to establish a circulating field for the global economy following.

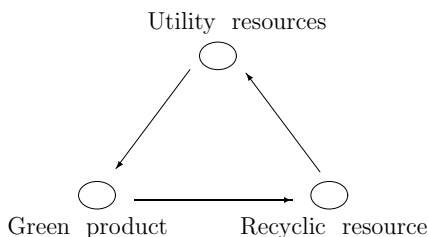

Fig.8.5.3

Whence, we can establish a combinatorial model consisting of economic communities in our society. Therefore, we decide the economic growth rates for the globalism by combinatorial differential geometry in Chapters 5 – 6, i.e., a rational rate of the development of human being’s society harmoniously with the natural WORLD, which can be determined if all factors in this economical field and the acting strength are known. That is a global economical science for our social world and need to research furthermore.

Besides applications of combinatorial fields to physics and economics, there are many other aspects for which combinatorial fields can be applied, for example, the *exploit resource with utilizing*, the *epidemic illness control*, \dots , etc.. Generally, the combinatorial field can presents a mathematical tool for describing the global behavior of any system with interactions between parts, or in other words, many-body systems in natural or social science.

References

- R.Abraham and J.E.Marsden
[AbM1] Foundation of Mechanics(2nd edition), Addison-Wesley, Reading, Mass, 1978.
- R.Abraham, J.E.Marsden and T.Ratiu
[AMR1] Manifolds, Tensors Analysis and Applications, Addison-Wesley Publishing Company, Inc., 1983.
- M.A.Armstrong
[Arm1] Basic Topology, McGraw-Hill, Berkshire, England, 1979.
- G.Bassini and S.Capozziello
[BaC1] Multi-spaces and many worlds from conservation laws, *Progress in Physics*, Vol.4(2006), 65-72.
- G.Belot
Bel1 Remarks on the geometry of visibles, *Philosophical Quarterly*, Vol.55(2003), 581-586.
- N.L.Biggs and A.T.White
[BiW1] Permutation Groups and Combinatoric Structure, Cambridge University Press, 1979.
- G.Birkhoff and S.MacLane
[BiM1] A Survey of Modern Algebra (4th edition), Macmillan Publishing Co., Inc, 1977.
- D.Bleecker
[Ble1] Gauge Theory and Variational Principles, Addison-Wesley Publishing Company, Inc, 1981.

J.A.Bondy and U.S.R.Murty

[BoM1] Graph Theory with Applications, The Macmillan Press Ltd, 1976.

P.Brass, W.Moser and J.Pach

[BMP1] Research Problems in Discrete Geometry, Springer Science + Business Media, Ltc, 2005.

M.Capobianco and J.C.Molluzzo

[CaM1] Examples and Counterexamples in Graph Theory, Elsevier North-Holland Inc, 1978.

M.Carmeli

[Car1] Classical Fields–General Relativity and Gauge Theory, World Scientific, 2001.

G.Chartrand and L.Lesniak

[ChL1] Graphs & Digraphs, Wadsworth, Inc., California, 1986.

T.P.Cheng and L.F.Li

[ChL1] Gauge Theory of Elementary Particle Physics, Oxford University Press, 1984.

S.S.Chern and W.H.Chern

[ChC1] Lectures in Differential Geometry(in Chinese), Peking University Press, 2001.

W.H.Chern and X.X.Li

[ChL1] Introduction to Riemannian Geometry (in Chinese), Peking University Press, 2002.

B.Chow, P.Lu and L.Ni

[CLN1] Hamilton's Ricci Flow, Science Press, Beijing,2006.

D.Deleanu

[Del1] A Dictionary of Smarandache Mathematics, Buxton University Press, London & New York,2.

P.Erdős, A.Goodman and L.Pósa

[EGP1] The representation of a graph by set intersections, *Canda. J. Math.*, 18(1966), 106-112.

J.E.Graver and M.E.Watkins

[GrW1] Combinatorics with Emphasis on the Theory of Graphs, Springer-Verlag, New York Inc,1977.

J.L.Gross and T.W.Tucker

[GrT1] Topological Graph Theory, John Wiley & Sons, 1987.

B.Grümbaum

[Grü1] Convex Polytopes, London Interscience Publishers, 1967.

L.G.Hua

[Hua1] Introduction to Number Theory (in Chinese), Science Publish Press, Beijing, 1979.

H.Iseri

[Ise1] Smarandache manifolds, American Research Press, Rehoboth, NM,2002.

D.M.Jackson and T.I.Visentin

[JaV1] A character theoretic approach to embeddings of rooted maps in an orientable surface of given genus, *Trans. Amer. Math. Soc.* 322(1990), 343-363.

L.Kuciuk and M.Antholy

[KuA1] An Introduction to Smarandache Geometries, *JP Journal of Geometry and Topology*, 5(1), 2005,77-81.

J.H.Kwak and J.Lee

[KwL1] Enumeration of graph embeddings, *Discrete Math*, 135(1994), 129-151.

John M.Lee

[Lee1] Introduction to topological manifolds, Springer-Verlag New York, Inc., 2000.

V.A.Liskovets

[Lis1] Enumeration of non-isomorphic planar maps, *Sel. Math. Sov*, 4;4(1985), 303-323.

[Lis2] A reductive technique for Enumerating non-isomorphic planar maps, *Discrete Math*, 156(1996), 197-217.

V.A.Liskovets and T.R.S.Walsh

[LiW1] The enumeration of non-isomorphic 2-connected planar maps, *Canad.J.Math*, 35(1983), 417-435.

Y.P.Liu

[Liu1] Embeddability in Graphs, Kluwer Academic Publishers, Dordrecht/ Boston/ London, 1995.

- [Liu2] Enumerative Theory of Maps, Kluwer Academic Publishers, Dordrecht/ Boston/ London, 1999.
- [Liu3] Advances in Combinatorial Maps (in Chinese), Northern Jiaotong University Publisher, Beijing, 2003.
- [Liu4] Algebraic Principles of Maps (in Chinese), Higher Education Press, 2006
- J.C.Lu
- [Luj1] Fangfo Analyzing LAO ZHI - Explaining TAO TEH KING by TAI JI (in Chinese), Tuan Jie Publisher, Beijing, 2004.
- [Luj2] Originality's Come - Fangfo Explaining the Vajra Paramita Sutra (in Chinese), Beijing Tuan Jie Publisher, 2004.
- A.Malnič, R.Nedela and M.Škovirea
- [MNS1] Lifting graph automorphisms by voltage assignments, *Europ.J. Combinatorics*, 21(2000), 927-947.
- L.F.Mao
- [Mao1] Automorphism Groups of Maps, Surfaces and Smarandache Geometries, American Research Press, 2005.
- [Mao2] On automorphism groups of maps, surfaces and Smarandache geometries, *Scientia Magna*, Vol.1(2005), No.2,55-73.
- [Mao3] Smarandache Multi-Space Theory, Hexis, Phoenix,American 2006.
- [Mao4] Selected Papers on Mathematical Combinatorics, World Academic Union, 2006.
- [Mao5] On algebraic multi-group spaces, *Scientia Magna*, Vol.2, No.1 (2006), 64-70.
- [Mao6] On multi-metric spaces, *Scientia Magna*, Vol.2,No.1(2006), 87-94.
- [Mao7] On algebraic multi-vector spaces, *Scientia Magna*, Vol.2,No.2 (2006), 1-6.
- [Mao8] On algebraic multi-ring spaces, *Scientia Magna*, Vol.2,No.2(2006), 48-54.
- [Mao9] Smarandache multi-spaces with related mathematical combinatorics, in Yi Yuan and Kang Xiaoyu ed. *Research on Smarandache Problems*, High American Press, 2006.
- [Mao10] Combinatorial speculation and combinatorial conjecture for mathematics, *International J.Math. Combin.* Vol.1(2007), No.1, 1-19.
- [Mao11] An introduction to Smarandache multi-spaces and mathematical combinatorics, *Scientia Magna*, Vol.3, No.1(2007), 54-80.
- [Mao12] Pseudo-manifold geometries with applications, *International J. Math. Combin.*

Vol.1(2007), No.1, 45-58.

- [Mao13] A combinatorial generalized Stokes theorem on integration, *International J.Math. Combin.* Vol.1(2007), No.1, 67-86.
- [Mao14] Geometrical theory on combinatorial manifolds, *JP J.Geometry and Topology*, Vol.7, No.1(2007),65-114.
- [Mao15] Curvature equations on combinatorial manifolds with applications to theoretical physics, *International J.Math.Combin.*, Vol.1(2008), No.1, 16-35.
- [Mao16] Combinatorially Riemannian Submanifolds, *International J. Math. Combin.*, Vol. 2(2008), No.1, 23-45.
- [Mao17] Differential geometry on Smarandache manifolds, in Yuhua Fu, Linfan Mao and Mihaly Bencze ed: *Scientific Elemwnts*, Vol.1, InfoLearnQuest Press, 2007.
- [Mao18] Combinatorially differential geometry, in Yuhua Fu, Linfan Mao and Mihaly Bencze ed: *Scientific Elemwnts*, Vol.1, InfoLearnQuest Press, 2007.
- [Mao19] Extending homomorphism theorem to multi-systems, *International J.Math. Combin.* Vol.3(2008), 1-27.
- [Mao20] Action of multi-groups on finite multi-sets, *International J.Math. Combin.* Vol.3(2008), 111-121.
- [Mao21] Topological multi-groups and multi-fields, *International J.Math. Combin.* Vol.1 (2009), 08-17.
- [Mao22] Euclidean pseudo-geometry on \mathbf{R}^n , *International J.Math. Combin.* Vol.1 (2009), 90-95.

L.F.Mao and Y.P.Liu

- [MaL1] New automorphism groups identity of trees, *Chinese Advance in Mathematics*,113-117,5(2002).
- [MaL2] Group action approach for enumerating maps on surfaces, *J. Applied Math. & Computing*, Vol.13, No.1-2,201-215.
- [MaL3] A new approach for enumerating maps on orientable surfaces, *Australasian J. Combinatorics*, Vol.30(2004), 247-259.

L.F.Mao and F.Tian

- [MaT1] A combinatorial refinement of Hurwitz theorem on Riemann surfaces, *Collection papers in The Symposia of 2004 Postdoctoral Forum on Frontal & Interdisciplinary Sciences of Chinese Academy of Sciences*, 75-89, December 2004.

- [MaT2] On oriented 2-factorable graphs, *J. Applied Math. & Computing*, Vol.17, No.1-2, 25-38.
L.F.Mao, Y.P.Liu and F.Tian
- [MLT1] Automorphisms of maps with a given underlying graph and their application to enumeration, *Acta.Math.Sinica*, Vol.21, 2(2005), 225-236.
L.F.Mao, Y.P.Liu and E.L.Wei
- [MLW1] The semi-arc automorphism group of a graph with application to map enumeration, *Graphs and Combinatorics*, Vol.22, No.1(2006) 93-101.
W.S.Massey
- [Mas1] Algebraic topology: an introduction, Springer-Verlag, New York, etc.(1977).
[Mas2] Singular Homology Theory, Springer-Verlag, New York, etc.(1980).
Michio Kaku
- [Kak1] Parallel Worlds, Doubleday, An imprint of Random House, 2004.
B.Mohar and C.Thomassen
- [MoT1] Graphs on Surfaces, The Johns Hopkins University Press, London, 2001.
B.P.Mull
- [Mull1] Enumerating the orientable 2-cell imbeddings of complete bipartite graphs, *J.Graph Theory*, vol 30, 2(1999),77-90.
B.P.Mull,R.G.Rieper and A.T.White
- [MRW1] Enumeration 2-cell imbeddings of connected graphs,*Proc.Amer. Math.Soc.*, 103(1988), 321 330.
R.Nedela and M.Škoviera
- [NeS1] Regular maps from voltage assignments and exponent groups, *Europ.J.Combinatorics*, 18(1997), 807-823.
L.Z.Nie and S.S.Ding
- [NiD1] Introduction to Algebra (in Chinese), Higher Education Publishing Press, 1994.
V.V.Nikulín and I.R.Shafarevich
- [NiS1] Geometries and Groups, Springer-Verlag Berlin Heidelberg, 1987.
E.Papantonopoulos
- [Pap1] Braneworld cosmological models, *arXiv: gr-qc/0410032*.

- [Pap2] Cosmology in six dimensions, *arXiv: gr-qc/0601011*.
P.Petersen
- [Pet1] Riemannian Geometry (Second Edition), Springer Science + Business Media, Ltc, 2006.
Pontrjagin L.S
- [Pon1] Topological Groups, 2nd ed, Gordon and Breach, New York, 1966.
- [Pon2] Über stetige algebraische Körper, *Ann. of Math.*, 33(1932), 163-174.
T.Reid
- [Rei1] An inquiry into the human mind on the principles of common sense, in D.Brookes ed., Edinburgh University Press, 1997.
M.B.Robinson, K.R.Bland, G.B.Cleaver and J.R.Dittmann
- [RBBB] A Simple Introduction to Particle Physics(I)- Foundations and the Standard Model, *arXiv: hep-th/0810.3328v1*, 18 Oct/2008.
Joseph J.Rotman
- [Rot1] An introduction to algebraic topology, Springer-Verlag New York Inc. 1988.
H.J.Ryser
- [Rys1] Combinatorial Mathematics, The Mathematical Association of America, 1963.
Z.Sima
- [Sim1] Completely TAO TEH KING (in Chinese), China Changan Publisher, Beijing, 2007.
F.Smarandache
- [Sma1] A Unifying Field in Logics. Neutrosopy: Neturosophic Probability, Set, and Logic, American research Press, Rehoboth, 1999.
- [Sma2] Mixed noneuclidean geometries, *eprint arXiv: math/0010119*, 10/2000.
F.Smarandache, V.Christianto, Y.H.Fu et.al
- [SCF1] Unfolding the Labyrinth: Open Problems in Physics, Mathematics, Astrophysics and Other Areas of Science, Hexis, Phoenix, 2006.
J.Stillwell
- [Sti1] Classical Topology and Combinatorial Group Theory, Springer-Verlag New York Inc., (1980).

J.C.Su

[Suj1] Topology on Manifolds (in Chinese), Wuhan University Press, 2005

G.Svetlichny

[Sve1] Preparation of Gauge Theory, *arXiv: math-hp/9902027v3*, 12 Mar/1999.

M.Tegmark

[Teg1] Parallel Universes, in *Science and Ultimate Reality: Quantum Theory, Cosmology and Complexity*, ed. by J.D.Barrow, P.C.W.Davies and C.L.Harper, Cambridge University Press, 2004.

Bo Thidé

[Thi1] Electromagnetic Field Theory, Upsilon Books, Uppsala, Sweden, 1997, also in: www.plasma.uu.se/CED.

W.T.Tutte

[Tut1] Graph Theory, Cambridge University Press, 2001.

V.S.Varadarajan

[Var1] Lie Groups, Lie Algebras, and Their Representations, Springer-Verlag New York Inc., (1984).

W.B.Vasantha Kandasamy

[Vas1] Bialgebraic structures and Smarandache bialgebraic structures, American Research Press, 2003.

W.B.Vasantha Kandasamy and F.Smarandache

[VaS1] Basic Neutrosophic Algebraic Structures and Their Applications to Fuzzy and Neutrosophic Models, Hexis, Church Rock, 2004.

[VaS2] N-Algebraic Structures and S-N-Algebraic Structures, HEXIS, Phoenix, Arizona, 2005.

T.R.S.Walsh and A.B.Lehman

[WaL1] Counting rooted maps by genus (I), *J. Comb.Theory*, B13(1972), 192- 218.

T.M.Wang

[Wan1] Concise Quantum Field Theory (in Chinese), Peking University Press, 2008.

D.Y.Wang and S.Y.Wang

[WaW1] Taiji Analysis (in Chinese), China Economic Times Publisher, Beijing, 2007.

X.G.Wen

[Wen1] Theory of Quantum Many-Body Systems (In Chinese), Higher Education Press, Beijing, 2004.

C.Von Westenholz

[Wes1] Differential Forms in Mathematical Physics (Revised edition), North-Holland Publishing Company, 1981.

A.T.White

[Whi1] Graphs of Group on Surfaces-interactions and models, Elsevier Science B.V. 2001.

C.X.Wu and G.H.Li

[WuL1] Geometry on Submanifolds (in Chinese), Science Press, Beijing, 2002.

M.Y.Xu

[Xum1] Introduction to Group Theory (in Chinese)(I), Science Press, Beijing, 1999.

M.Y.Xu, J.H.Huang, H.L.Li and S.R.Li

[XHL1] Introduction to Group Theory (in Chinese)(II), Science Press, Beijing, 1999.

G.Yaffe

[Yaf1] Reconsidering Reid's geometry of visibles', *Philosophical Quarterly*, 52(2002), 602-620.

C.Y.You

[You1] Lectures on Fundamental of Topology (in Chinese), Peking University Press, 1997.

Index

A

- action at a distance 362
- action of Lie multi-group 324
- action of multi-group 70
- action principle of field 416
- adjoint representation 318
- algebraic multi-system 78
- algebraic subsystem 49
- algebraic system 46
- associative law 46
- automorphism of ...
 - multi-system 54
 - principal fiber bundle 332
 - system 49

B

- basis 113
- Boolean algebra 5
- Boolean polynomials 8
- boundary homomorphism 105
- bracket operation 226
- Burnside's Lemma 73

C

- Cayley diagrams 85
- chain complex 106
- C^k -diffeomorphism 121
- circulating economical field 466
- Codazzi equation 291

- combinatorial conjecture 45
- combinatorial ...
 - connection space 243
 - curvature operator 243
 - differential manifold 223
 - Dirac field 432
 - embedded submanifold 295
 - equivalence 181
 - Euclidean space 155
 - fan-space 166
 - fiber bundle 218
 - field 414
 - field strength 459
 - Finsler geometry 276
 - free-field 417
 - gauge basis 454
 - gauge field 452, 455
 - gauge potential 459
 - Gauss' theorem 274
 - gravitational field 435
 - in-submanifold 178
 - manifold 172
- combinatorial ...
 - metric 439
 - principal fiber bundle 330
 - Riemannian curvature 252
 - Riemannian geometry 241
 - scalar field 430
 - space 155
 - Schwarzschild metric 440
 - Stokes' theorem 267
 - submanifold 178
 - universe 463

system 43
 Yang-Mills field 436
 commutative law 46
 complete graph 24
 connection on tensor 238
 conservation law 360
 continuous mapping 90
 contractible space 188
 coordinate matrix 224
 co-tangent vector space 144, 230
 countable set 18
 covering space 99
 curvature forms 249
 curvature forms
 on principal fiber bundle 342
 curvature tensor 247

D

d-connectedness 174
 deformation retract 188
 differential ...
 k-form 122
 manifold 140
 mapping 118
 Smarandache manifold 141
 dimensions of action 415
 Dirac field 398
 distributive multi-system 57

E

economical field 466
 edge-induced graph 23

edge labeled graph 23
 Einstein gravitational equation 366
 electromotive force 384
 electromagnetic field 378
 electromagnetic field tensor 385
 electrostatic field 378
 elliptic vertex 127, 134, 138
 embedded graph 25
 Euclidean space 111
 Euclidean vertex 127, 134, 138
 Euler-Lagrange equation 362
 Euler-Poincarè characteristic 107
 exact chain 201
 exact differential form 122
 exterior differential 122, 235

F

finite combinatorial manifold 172
 finite dimensional multi-module 64
 fundamental d-group 189
 fundamental group 95
 fundamental theorem of ...
 Lie group 318
 Lie multi-group 318

G

gauge field 392
 gauge invariant principle 392
 gauge multi-basis 452
 gauge scalar field 392
 gauge transformation 334
 Gauss equation 290

Gauss formula 284
 global connection on
 principal fiber bundle 336
 Gluing Lemma 90
 graph 19
 group 49

H

Hamiltonian field 357
 Hamiltonian
 on combinatorial field 827
 Hamiltonian principle 355
 Hasse diagram 12
 Higgs field 404
 Higgs particle 404
 homology sequence 20
 homomorphic multi-system 54
 homomorphic system 49
 homotopic equivalence 183
 homotopic mapping 95 2
 homotopy equivalence 195
 hyperbolic vertex 127, 134, 138

I

implicit function theorem 121
 inclusion-exclusion principle 27
 infinite principle of action 416
 inner product of matrixes 166
 integral multi-ring 59
 integration of forms 264
 intersection problem 156
 isomorphism of systems 49

J

Jacobian matrix 119

K

k-connected graph 20
 Kruskal coordinate 376

L

labeled lifting 209
 Lagrange equations 351
 Lagrange field 355
 Lagrangian on
 combinatorial field 422
 Lebesgue Lemma 93
 Lie algebra 312
 Lie multi-group 310
 Lie multi-subgroup 319
 lifting automorphism of
 voltage labeled graph 212
 lifting of a
 voltage labeled graph 211
 linear extension 13
 linear mapping 115
 local connection on
 principal fiber bundle 336
 locally ...
 A-invariant 214
 left-invariant vector field 312

M

magnetic flux 385

magnetostatic field 380
 map geometry ...
 with boundary 132
 without boundary 128
 mathematical system 41
 Maxwell equation 385
 Maxwell field 394
 Mayer-Vietoris theorem 203
 metric space 92
 Minkowskian norm 145
 Minkowskian spacetime 364
 multi-field 58
 multi-group 58
 multi-ideal 60
 multilinear mappings 117
 multi-module 61
 multi-operation system 53
 multi-poset 14
 multi-ring 58
 multi-set 9
 multi-subfield 58
 multi-subgroup 58
 multi-subring 58
 multi-time system 447

N

n -manifold 108
 normal basis 114
 normal principal fiber bundle 333
 normal space 283
 normal subgroup 51

O

one-parameter multi-group 320
 open sets 89
 orbit 71
 ordered set 13

P

parking problem 155
 partially ordered set 12
 particle-antiparticle
 transformation 397, 400
 partition of unity 259
 Pauli matrix 396
 Poisson equation 363
 polyhedron 104
 power set 3
 principal fiber bundle 146, 328
 principle of covariance 364
 principle of equivalence 364
 projective principle 421
 pseudo-Euclidean space 133
 pseudo-manifold 138
 pseudo-manifold geometry 145

Q

quotient multi-ring 60
 quotient set 49, 54

R

relative homology group 201
 retract 188
 Ricci equation 292
 Riemannian metric 364

S

Schwarzschild metric 370
 Schwarzschild radius 375
 Seifert and Van-Kampen 98
 simplicial homology group 106
 simplex 103
 simply d -connected 195
 singular homology group 198, 207
 s -manifold 127
 Smarandache geometry 126
 Smarandache manifold 141
 Smarandache multi-space 43
 Smarandache system 42
 spanning subgraph 23
 spinor of field 395
 spontaneous symmetry broken 403
 stabilizer 71
 standard n -dimensional poset 13
 standard p -simplex 123
 structural equation 249
 subgraph 22
 subgroup 49
 subposet 13
 strong anthropic principle 421

T

tangent space 283
 tangent vector space 142, 226
 tensor 117, 231
 tensor field 232
 time-reversal transformation 397
 topological group 304

topological multi-field 309
 topological multi-group 303
 topological multi-ring 308
 topological multi-subgroup 306
 topological space 89
 torsion-free 241
 transitive multi-group 73
 triangulation 109

U

unified field 412
 universal gravitational law 363

V

valency sequence of graph 20
 variation 351
 vector field 226
 vertex-edge labeled graph 23
 vertex-induced graph 23
 vertex labeled graph 23
 voltage labeled graph 209

W

weak anthropic principle 420
 wedge operation 232
 Weingarten formula 285
 Weyl field 395

Y

Yang-Mills field 400



Linfan Mao is a researcher in the *Chinese Academy of Mathematics and System Science*, also a deputy general secretary of the *China Tendering & Bidding Association*, in Beijing. He got his Ph.D in Northern Jiaotong University in 2002 and finished his postdoctoral report for *Chinese Academy of Sciences* in 2005. His main interesting focus on Mathematical Combinatorics and Smarandache multi-spaces with applications to sciences, particularly,

the parallel universe.

ABSTRACT: This monograph is motivated with surveying mathematics and physics by CC conjecture, i.e., *a mathematical science can be reconstructed from or made by combinatorialization*. Topics covered in this book include fundamental of mathematical combinatorics, differential Smarandache n -manifolds, combinatorial or differentiable manifolds and submanifolds, Lie multi-groups, combinatorial principal fiber bundles, gravitational field, quantum fields with their combinatorial generalization, also with discussions on fundamental questions in epistemology. All of these are valuable for researchers in combinatorics, topology, differential geometry, gravitational or quantum fields.

