

## Specific Composite Numbers Consist of Infinitely Many Arithmetic Progressions.

park ,jongsoo  
oofbird7@naver.com

abstract. Ben Green and Terence Tao showed that for any positive integer  $k$ , there exist infinitely many arithmetic progressions of length  $k$  consisting only of prime numbers. [14] Four parallel proofs of Szemerédi's theorem have been achieved; one by direct combinatorics, one by ergodic theory, one by hypergraph theory, and one by Fourier analysis and additive combinatorics. Even with so many proofs, Professor T. Tao points out that with this problem, there remains a sense that our understanding of this result is incomplete; for instance, none of the approaches were powerful enough to detect progressions in the primes, mainly due to the sparsity of the prime sequence. [22] Oliver Lonsdale Atkin introduced a prime sieve using irreducible binary quadratic forms and modular arithmetic; the algorithm enumerates representations of integers by certain binary quadratic forms. A way that uses modular arithmetic is widely known:  $6n + \delta$ ,  $12n + \delta$ ,  $30n + \delta$ ,  $60n + \delta$ . [31] In this paper, we assert that the composite number of the  $12n + 1, 5, 7, 11$  series as selected by a Modular Arithmetic and Multiplication Table are not random but consist of very structural and regular arithmetic progression groups.

## 1. Introduction

Look through a list of prime numbers and you'll find that it's impossible to predict when the next prime will appear. The list seems chaotic, random, and offers no clues as to how determine the next number. It is hard to guess at a formula that could generate this kind of pattern. In fact, this procession of primes resembles a random succession of numbers much more than it does a nice orderly pattern. [8] [21]

This paper starts from the question of "Can we express prime numbers and recognize them spatially such as Prime Spiral?" The prime spiral, also known as Ulam's spiral, is a plot in which the positive integers are arranged in a spiral, with primes indicated in some way along the spiral.

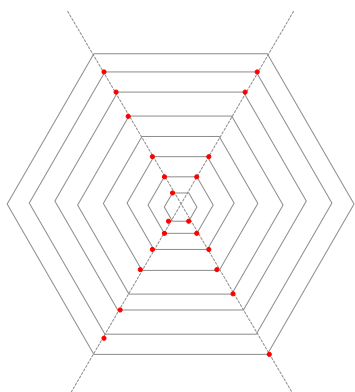

*Figure –1)* Prime numbers are aligned to X-shape of 4 groups with a period of  $12n$  .(except 2, 3)

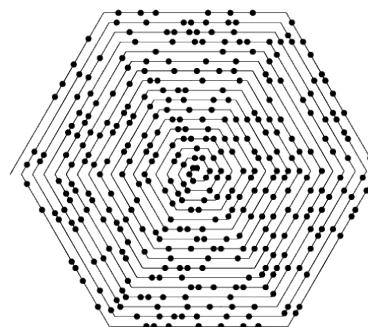

*Figure –2)* A hexagonal prime spiral can also be constructed, as illustrated above (Abbott 2005, wolfram).

### 1.1. Primes in Modular Arithmetic

If  $a$  and  $d$  are integers, with  $d$  non-zero, then a remainder is an integer  $r$  such that  $a = qd + r$  for some integer  $q$ , and with  $0 \leq r < |d|$ . [46] Putting prime numbers on the regular hexagon, every prime number except 2 and 3 is contained in the  $12n + 1, 5, 7, 11$  series, is sorted into 4 kinds of remainder groups—1,5,7, and 11—and belongs to at least one of these 4 groups.

### 1.2 Primes in Arithmetic Progression

Dirichlet's theorem, states that for any two positive coprime integers  $a$  and  $d$ , there are infinitely many primes of the form  $a + nd$ , where  $n \geq 0$ . In other words: there are infinitely many primes which are congruent to  $a$  modulo  $d$ . The numbers of the form  $a + nd$  form an arithmetic progression [37]

$$a, a+d, a+2d, a+3d, \dots a+nd$$

and Dirichlet's theorem states that this sequence contains infinitely many prime numbers. [33] Szemerédi's theorem generalizes the statement of van der Waerden's theorem. A theorem of Szemerédi asserts that all subsets of the integers with positive upper density will contain arbitrarily long arithmetic progressions. [22] Also any given arithmetic progression of primes has a finite length. Green-Tao settled an Szemerédi' conjecture by proving the Green-Tao theorem (The primes contain arbitrarily long arithmetic progressions). It follows immediately that there are infinitely many AP- $k$  for any  $k$  (integer  $k \geq 3$ , an AP- $k$  (also called PAP- $k$ ) is  $k$  primes in arithmetic progression) [23]

## 2. The Specific Composite Numbers of the $12n + 1, 5, 7, 11$ series

Like prime numbers, composite numbers appear intuitively irregular and seem to be difficult to group into a pattern. But, the specific composite numbers are generated by a certain rule and that rule is that composite

numbers consist of sixteen arithmetic progression groups of different lengths; each group and each arithmetic progression included in that group forms that rule.

$$25 = 5 \times 5, \quad 35 = 5 \times 7, \quad 49 = 7 \times 7, \quad 55 = 5 \times 11, \quad 65 = 5 \times 13, \quad 77 = 7 \times 11,$$

$$85 = 5 \times 17, \quad 95 = 5 \times 19, \quad 115 = 5 \times 23, \quad 119 = 7 \times 17$$

## 2.1 Generating the Composite Number of the $12n+1, 5, 7, 11$ series

Let us denote the set  $A_n$  is all elements of the  $12n+1, 5, 7, 11$  series ( $n=0, 1, 2, \dots$ ); the set  $P_n$  is all elements of prime numbers as comprised in  $A_n$ ; the set  $C_n$  is all elements of composite numbers as comprised in  $A_n$

1	2	3	4	5	6	7	8	9	10	11	12
13	14	15	16	17	18	19	20	21	22	23	24
<span style="border: 1px solid black; padding: 2px;">25</span>	26	27	28	29	30	31	32	33	34	<span style="border: 1px solid black; padding: 2px;">35</span>	36
37	38	39	40	41	42	43	44	45	46	47	48
<span style="border: 1px solid black; padding: 2px;">49</span>	50	51	52	53	54	<span style="border: 1px solid black; padding: 2px;">55</span>	56	57	58	59	60
61	62	63	64	<span style="border: 1px solid black; padding: 2px;">65</span>	66	67	68	69	70	71	72
73	74	75	76	<span style="border: 1px solid black; padding: 2px;">77</span>	78	79	80	81	82	83	84
<span style="border: 1px solid black; padding: 2px;">85</span>	86	87	88	89	90	<span style="border: 1px solid black; padding: 2px;">91</span>	92	93	94	<span style="border: 1px solid black; padding: 2px;">95</span>	96
$\vdots$	$\vdots$	$\vdots$	$\vdots$	$\vdots$	$\vdots$	$\vdots$	$\vdots$	$\vdots$	$\vdots$	$\vdots$	$\vdots$
$12n+1$	$12n+2$	$12n+3$	$12n+4$	$12n+5$	$12n+6$	$12n+7$	$12n+8$	$12n+9$	$12n+10$	$12n+11$	$12n+12$

*Table – 1*) All elements of the  $12n+1, 5, 7, 11$  series are not multiples of 2 and 3. Therefore, all prime numbers except 2 and 3 are contained in the  $12n+1, 5, 7, 11$  series. The number in the box denotes the elements of  $C_n$ .

**Theorem 1.1)** All prime numbers but 2 and 3 exist in forms of  $12n+1, 5, 7, 11$  with a period of  $12n$ .

**Proof A)**

(i) All natural numbers can be represented with a period of 12.

(ii) All even numbers but 2 are not prime numbers

Elements of  $12n+2, 4, 6, 8, 10, 12$  are all even. ( $n=0, 1, 2, \dots, n$ )

Therefore, all  $12n+2, 4, 6, 8, 10, 12$  's but 2 are not prime numbers.

(iii) All  $12n+3$  's but 3 are not prime numbers.

$12n+3 = (3 \times 4)n + 3$  is a multiple of 3.

(iv)  $12n+9$  is not a prime number.

$12n+9 = (3 \times 4)n + 9$  is a multiple of 3.

As in Theorem 1), every prime number but 2 and 3 is contained in the periodic  $A_n$ . So, let us denote this series as follows:

$$A_n = \begin{cases} A_1, & \text{if remainder} \equiv 1 \pmod{12} \\ A_5, & \text{if remainder} \equiv 5 \pmod{12} \\ A_7, & \text{if remainder} \equiv 7 \pmod{12} \\ A_{11}, & \text{if remainder} \equiv 11 \pmod{12} \end{cases}$$

In *Figure – 2) Figure – 3)*, the  $A_n$  series are multiplied infinitely and we can find 10 basics equations which falls into one of the 4 groups.

$\times$	$A_1$	$A_5$	$A_7$	$A_{11}$
$A_1$	$A_1 \times A_1$	$A_1 \times A_5$	$A_1 \times A_7$	$A_1 \times A_{11}$
$A_5$	$A_5 \times A_1$	$A_5 \times A_5$	$A_5 \times A_7$	$A_5 \times A_{11}$
$A_7$	$A_7 \times A_1$	$A_7 \times A_5$	$A_7 \times A_7$	$A_7 \times A_{11}$
$A_{11}$	$A_{11} \times A_1$	$A_{11} \times A_5$	$A_{11} \times A_7$	$A_{11} \times A_{11}$

*Figure – 3)* Multiplication Table

$\times$	$++(A_1)$	$-+(A_5)$	$--(A_7)$	$+-(A_{11})$
$++(A_1)$	$++$	$-+$	$--$	$+ -$
$-+(A_5)$	$-+$	$++$	$+ -$	$--$
$--(A_7)$	$--$	$+ -$	$++$	$- +$
$+-(A_{11})$	$+ -$	$--$	$- +$	$++$

*Figure – 4)* Sign Assignments in the Multiplication Table

If we assign signs, we can summarize them as follows:

Multiplication	Sign	Equation	Remainder
$A_1 \times A_1$	$++(A_1)$	$(12x + 1)(12y + 1)$	1 (mod 12)
$A_5 \times A_5$	$++(A_1)$	$(12x + 5)(12y + 5)$	1 (mod 12)
$A_7 \times A_7$	$++(A_1)$	$(12x + 7)(12y + 7)$	1 (mod 12)
$A_{11} \times A_{11}$	$++(A_1)$	$(12x + 11)(12y + 11)$	1 (mod 12)
$A_1 \times A_5$	$-+(A_5)$	$(12x + 1)(12y + 5)$	5 (mod 12)
$A_7 \times A_{11}$	$-+(A_5)$	$(12x + 7)(12y + 11)$	5 (mod 12)
$A_1 \times A_7$	$--(A_7)$	$(12x + 1)(12y + 7)$	7 (mod 12)
$A_5 \times A_{11}$	$--(A_7)$	$(12x + 5)(12y + 11)$	7 (mod 12)
$A_1 \times A_{11}$	$+-(A_{11})$	$(12x + 1)(12y + 11)$	11 (mod 12)
$A_5 \times A_7$	$+-(A_{11})$	$(12x + 5)(12y + 7)$	11 (mod 12)

*Table – 2)* The Result List of Multiplication Table

**Theorem 1.2)** All elements of the  $A_n \times A_n$  table multiplication are contained in set  $A_n$ .

**Proof B)**

$$(12x + \alpha)(12y + \beta), (\alpha, \beta \in \{1, 5, 7, 11\}) =$$

$$144xy + 12\beta x + 12\alpha y + \alpha\beta = \begin{cases} \alpha\beta \in \{1, 25, 49, 121\}, & \text{if remainder} \equiv 1 \pmod{12} \\ \alpha\beta \in \{5, 77\}, & \text{if remainder} \equiv 5 \pmod{12} \\ \alpha\beta \in \{7, 55\}, & \text{if remainder} \equiv 7 \pmod{12} \\ \alpha\beta \in \{11, 35\}, & \text{if remainder} \equiv 11 \pmod{12} \end{cases}$$

Therefore,  $\alpha\beta \in \{1, 5, 7, 11, 25, 35, 49, 55, 77, 121\}$

**Theorem 1.3)** All elements of the  $A_n$  table multiplication are contained in the set of the  $A_n \times A_n$  table multiplication.

**Proof C)**

For any element  $k$  of the set  $A_n$ :  $k \in P_n$  or  $k \in C_n$ ,

$$\text{if } k \text{ is } \begin{cases} P_n : P_n \times 1, k \in (12x + \alpha) \times 1 \text{ or } 1 \times (12y + \beta) \\ C_n : \begin{cases} P_n \times P_n, k \in (12x + \alpha) \times (12y + \beta) \\ P_n \times C_n, k \in (12x + \alpha) \times (12y + \beta) \\ C_n \times C_n, k \in (12x + \alpha) \times (12y + \beta) \end{cases} \end{cases}$$

Therefore,  $C_n \geq 25$ . Additionally, it is possible to find all values of  $C_n$  of the  $12n + 1, 5, 7, 11$  series in the results of a matrix-multiplication of  $A_n \times A_n$  that are greater than 5.

	5	7	11	13	17	19	23	25
5	25							
7	35	49						
11	55	77	121					
13	65	91	143	169				
17	85	119	187	221	289			
19	95	133	209	247	223	361		
23	115	161	253	299	391	437	529	
25	125	175	275	325	425	475	575	625

$12y + 1, 5, 7, 11$  (except 1)

Figure – 2) Multiplication Table of  $12n + 1, 5, 7, 11$  series

## 2.2 Prime Sieve

In the third century B.C., the scholar Eratosthenes came up with a simple algorithm for listing all the prime numbers up to a given  $N$ , referred to as the sieve of Eratosthenes. A standard improvement in the sieve of Eratosthenes is to enumerate values of  $xy$  not divisible by 2, 3, or 5. [30]

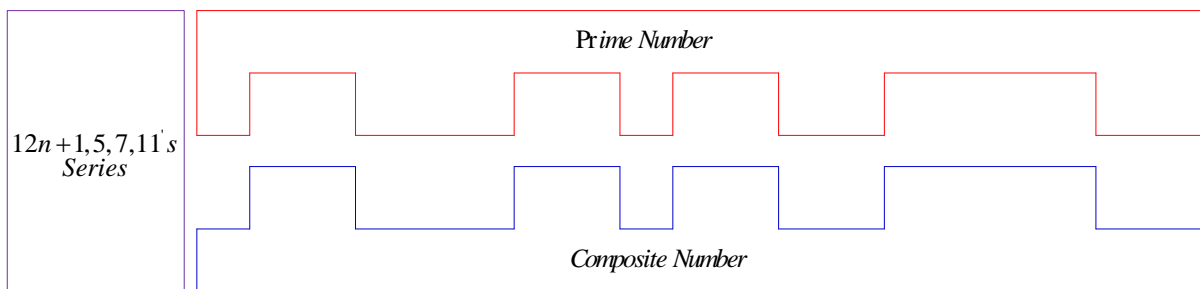

Figure 2.2.a) Prime numbers and composite numbers have complementary relationship regarding  $12n + 1, 5, 7, 11$  series.

In the following [Attached document 1], the prime numbers under 1000 are being filtered using  $C_n$ . More specifically, you can see that arithmetic progressions,  $G_{a_n} \sim G_{p_n}$ , are intertwined. Of course, since the number of arithmetic progressions of each group increases as  $N$  increases, the complexity of intertwining of further arithmetic progressions increases. The composite numbers intuitively appear to be irregular and seem to be difficult to group into a pattern. However, the composite numbers are sorted into sixteen arithmetic groups ( $G_{a_n} \sim G_{p_n}$ ) and are generated regularly by arithmetic progressions of each group.

### 2.3 The Structure of a matrix-multiplication of $A_n \times A_n$

Unlike prime numbers, which are unpredictable, the composite numbers are formed by sixteen arithmetic progression groups. This means that composite numbers in principle are predictable because whole composite numbers follow this rule. However, the composite numbers are made up of sixteen arithmetic progressions and it is difficult to see the whole of the arithmetic progressions, whose number increases, without necessary computations and information media that can store the computed results. If you can find the computed results of various arithmetic progressions intuitively, you can predict the rule that governs the composite numbers. This immediately means that you will be able to find the rule that governs the prime numbers. It is not a problem of whether or not the composite numbers are predictable but a problem of human perception.

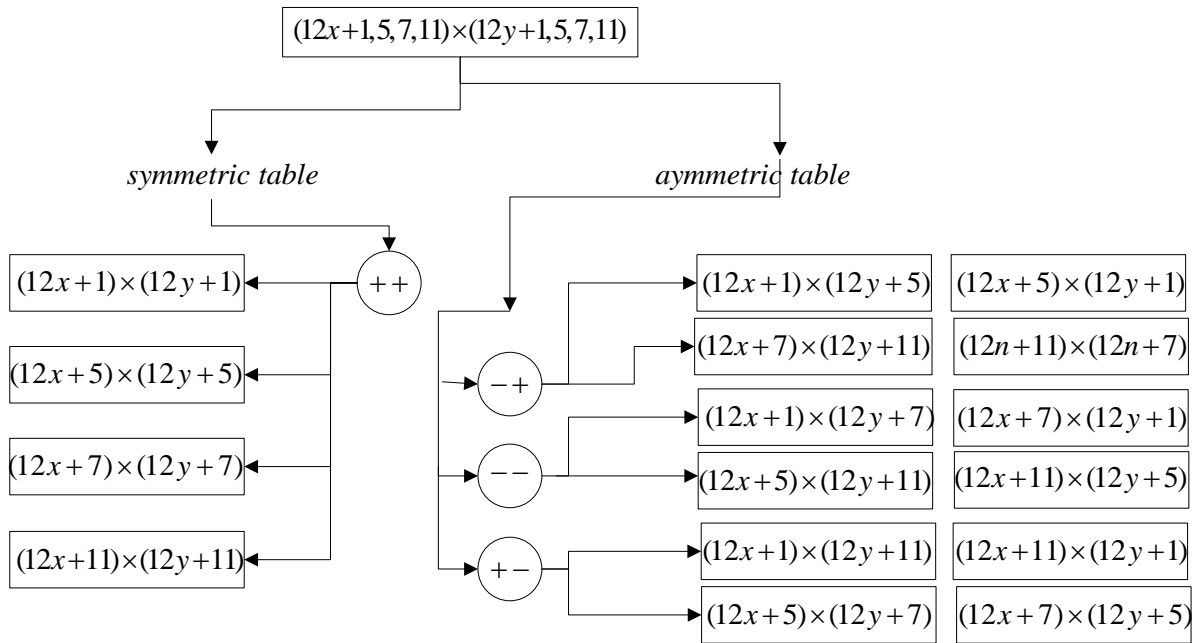

Figure – 2.3.a) Structure of Multiplication Table

- ⊗  $G$  is a temporary mark used in this paper.
- ⊗  $a \sim p$  are marked in alphabetical order.
- ⊗  $n$  is marked to clarify that composite numbers are a set of arithmetic progressions.

$N$	Group Name	$a_1$ (first term)	$d$ (common difference)	$n = 1, 2, 3, \dots, n$
1	$Ga_n$	$(12x+1)(12y+1)$	$12 \times (12x+1)$	$x = n, y = n$
2	$Gb_n$	$(12x+5)(12y+5)$	$12 \times (12x+5)$	$x = n-1, y = n-1$
3	$Gc_n$	$(12x+7)(12y+7)$	$12 \times (12x+7)$	$x = n-1, y = n-1$
4	$Gd_n$	$(12x+11)(12y+11)$	$12 \times (12y+11)$	$x = n-1, y = n-1$
5	$Ge_n$	$(12x+5)(12y+1)$	$12 \times (12y+5)$	$x = n-1, y = n$
6	$Gf_n$	$(12x+1)(12y+5)$	$12 \times (12x+1)$	$x = n, y = n-1$
7	$Gg_n$	$(12x+11)(12y+7)$	$12 \times (12x+1)$	$x = n-1, y = n-1$
8	$Gh_n$	$(12x+7)(12y+11)$	$12 \times (12x+7)$	$x = n-1, y = n-1$
9	$Gi_n$	$(12x+7)(12y+1)$	$12 \times (12x+7)$	$x = n-1, y = n$
10	$Gj_n$	$(12x+1)(12y+7)$	$12 \times (12x+1)$	$x = n, y = n-1$
11	$Gk_n$	$(12x+5)(12y+11)$	$12 \times (12x+5)$	$x = n-1, y = n-1$
12	$Gl_n$	$(12x+11)(12y+5)$	$12 \times (12x+11)$	$x = n-1, y = n-1$
13	$Gm_n$	$(12x+1)(12y+11)$	$12 \times (12x+1)$	$x = n, y = n-1$
14	$Gn_n$	$(12x+11)(12y+1)$	$12 \times (12x+11)$	$x = n-1, y = n$
15	$Go_n$	$(12x+5)(12y+7)$	$12 \times (12x+5)$	$x = n-1, y = n-1$
16	$Gp_n$	$(12x+7)(12y+5)$	$12 \times (12x+7)$	$x = n-1, y = n-1$

Table – 3) The composite numbers of the  $12n + 1, 5, 7, 11$  series are sorted into a total of sixteen groups( $Ga_n \sim Gp_n$ ).

#### 2.4 Symmetric table and Asymmetric table

Analyzing the table of the  $12n + 1, 5, 7, 11$  series, by the values of horizontal axis( $\alpha$ ) and vertical axis( $\beta$ ), the table divides into a symmetric table if  $\alpha = \beta$ , and into an asymmetric table if  $\alpha \neq \beta$ . Therefore, we can find the following results.

i) Symmetric table,  $\alpha = \beta$

$$(12x+1) \times (12y+1), (x, y \geq 1)$$

$$(12x+5) \times (12y+5),$$

$$(12x+7) \times (12y+7),$$

$$(12x+11) \times (12y+11)$$

Since  $\alpha = \beta$ , the results are the same, reflecting along the diagonal elements independent of the orders of  $\alpha$  and  $\beta$ . So, the symmetric table has four cases.

ii) Asymmetric table,  $\alpha \neq \beta$

$$(12x+1) \times (12y+5), (x \geq 1), (12x+7) \times (12y+11)$$

$$(12x+1) \times (12y+7), (x \geq 1), (12x+5) \times (12y+11)$$

$$(12x+1) \times (12y+11), (x \geq 1), (12x+5) \times (12y+7)$$

However, the commutative law does not hold if  $\alpha \neq \beta$ . So, depending on the orders of  $\alpha$  and  $\beta$ , the results are different for the diagonal elements. An asymmetric table has twelve cases.

$\alpha$	$\beta$	Sign	Equation
1	5	-+	$(12x+1) \times (12y+5), (x \geq 1)$
5	1	-+	$(12x+5) \times (12y+1), (x \geq 1)$
7	11	-+	$(12x+7) \times (12y+11)$
11	7	-+	$(12x+11) \times (12y+7)$
1	7	--	$(12x+1) \times (12y+7), (x \geq 1)$
7	1	--	$(12x+7) \times (12y+1), (x \geq 1)$
5	11	--	$(12x+5) \times (12y+11)$
11	5	--	$(12x+11) \times (12y+5)$
1	11	+-	$(12x+1) \times (12y+11), (x \geq 1)$
11	1	+-	$(12x+11) \times (12y+1), (x \geq 1)$
5	7	+-	$(12x+5) \times (12y+7)$
7	5	+-	$(12x+7) \times (12y+5)$

Table – 4) The Equation of Asymmetric Table

The composite numbers of the  $12n+1,5,7,11$  series divide into a total of sixteen arithmetic progression groups in the matrix multiplication,  $(12x+\alpha) \times (12y+\beta)$ ,  $(\alpha, \beta = 1,5,7,11)$ , depending on  $\alpha = \beta$  and  $\alpha \neq \beta$ .

### 3. Composites in Arithmetic Progression

#### 3.1 $(12x+1)(12y+1), (Ga_n)$

$\times$	13	25	37	49	61	73	85	97	$12x+1$
13	169								
25	325	625							
37	481	925	1369						
49	637	1225	1813	2401					
61	793	1525	2257	2989	3721				
73	949	1825	2701	3577	4453	5329			
85	1105	2125	3145	4165	5185	6205	7225		
97	1261	2425	3589	4753	5917	7081	8245	9409	
	$12y+1$								

Figure 3.1.a) From the matrix multiplication, each of the diagonal elements becomes the initial terms of the arithmetic progressions.

- $Ga_1 : 169(a_1) \quad 325(a_2) \quad 481(a_3) \quad 637(a_4) \quad 793(a_5) \quad 949(a_6) \quad 1105(a_7) \quad 1261(a_8)$
- $Ga_2 : 625(a_1) \quad 925(a_2) \quad 1225(a_3) \quad 1525(a_4) \quad 1825(a_5) \quad 2125(a_6) \quad 2425(a_7)$
- $Ga_3 : 1369(a_1) \quad 1813(a_2) \quad 2257(a_3) \quad 2701(a_4) \quad 3145(a_5) \quad 3589(a_6)$
- $Ga_4 : 2401(a_1) \quad 2989(a_2) \quad 3577(a_3) \quad 4165(a_4) \quad 4753(a_5)$
- $Ga_5 : 3721(a_1) \quad 4453(a_2) \quad 5185(a_3) \quad 5917(a_4)$
- $Ga_6 : 5329(a_1) \quad 6205(a_2) \quad 7018(a_3)$
- $Ga_7 : 7225(a_1) \quad 8545(a_2)$
- $Ga_8 : 9409(a_1)$

Figure 3.1.b) We have listed the symmetric matrix results for each arithmetic progression. ( $a_1$  =first term,  $d$  =common difference)



$Ga_1 : a_1 = (12x+1)(12y+1) = 169, \quad d = 12 \times (12x+1) = 156, (x=1, y=1)$
$Ga_2 : a_1 = (12x+1)(12y+1) = 625, \quad d = 12 \times (12x+1) = 300, (x=2, y=2)$
$Ga_3 : a_1 = (12x+1)(12y+1) = 1369, \quad d = 12 \times (12x+1) = 444, (x=3, y=3)$
$Ga_4 : a_1 = (12x+1)(12y+1) = 2401, \quad d = 12 \times (12x+1) = 588, (x=4, y=4)$
$Ga_5 : a_1 = (12x+1)(12y+1) = 3721, \quad d = 12 \times (12x+1) = 732, (x=5, y=5)$
$Ga_6 : a_1 = (12x+1)(12y+1) = 5329, \quad d = 12 \times (12x+1) = 876, (x=6, y=6)$
$Ga_7 : a_1 = (12x+1)(12y+1) = 7225, \quad d = 12 \times (12x+1) = 1020, (x=7, y=7)$
$Ga_8 : a_1 = (12x+1)(12y+1) = 9409, \quad d = 12 \times (12x+1) = 1164, (x=8, y=8)$
$\vdots$
$Ga_n : a_1 = (12x+1)(12y+1) = 144xy + 12x + 12y + 1, \quad d = 12 \times (12x+1), (x=n, y=n)$

Figure 3.1.c) Table multiplication results are arithmetic progressions that have initial terms and common differences and have a general formula. ( $a_1$  =first term,  $d$  =common difference)

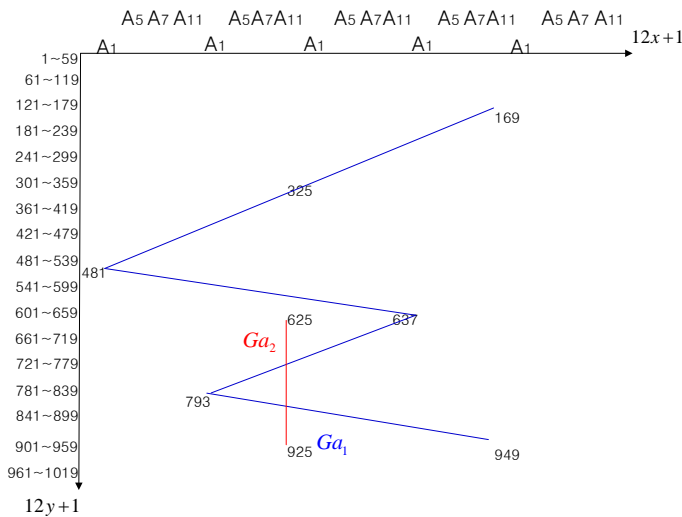

Figure 3.1.d) The contour of the arithmetic progression that belongs to  $Ga_n$

The Figure 3.1.d) shows the contour of the arithmetic progression, cutting by 60 up to 1000. If  $N$  increases, more arithmetic progressions are generated. A point to note here is that they appear as different contours because they have different initial terms and common differences that belong to  $Ga_n$ .

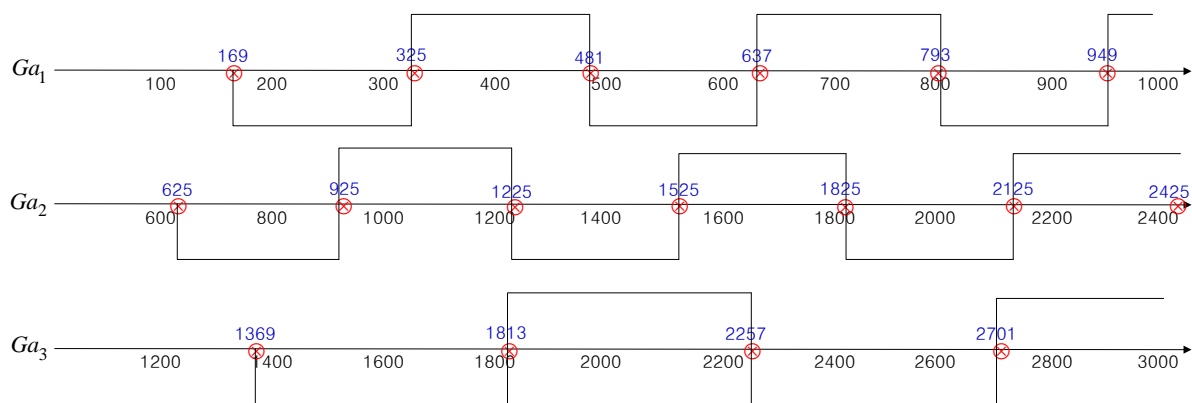

Figure 3.1.e) In  $Ga_n$ , there exist, under rules, a number of arithmetic progressions that have different initial terms and

common differences.

$Ga_1, Ga_2, Ga_3 \sim Ga_n$  make up arithmetic progression groups that have initial terms,

$(12x+1)(12y+1), (x, y = n)$  and common differences,  $12(12x+1), (x = n)$ . Of course, as  $n$  increases, the values of the initial term and the common difference increase.

$N$	<i>current value</i>	<i>new value</i>
$Ga_1 : a_1(169)$	$Ga_1$	$Ga_1$
$Ga_2 : a_1(625)$	$Ga_1, Ga_2$	$Ga_2$
$Ga_3 : a_1(1369)$	$Ga_1, Ga_2, Ga_3$	$Ga_3$
$Ga_4 : a_1(2401)$	$Ga_1, Ga_2, Ga_3, Ga_4$	$Ga_4$
$Ga_5 : a_1(3721)$	$Ga_1, Ga_2, Ga_3, Ga_4, Ga_5$	$Ga_5$
$\vdots$	$\vdots$	$\vdots$
$Ga_n : a_1$	$Ga_1, Ga_2, Ga_3, Ga_4, Ga_5, \dots, Ga_n$	$Ga_n$

*Figure 3.1.f)* As the natural number  $N$ , increases, new arithmetic progressions accumulate and keep increasing.

In *Figure 3.1.f)*, since new arithmetic progressions accumulate as the natural number  $N$  increases, the distribution density of the composite numbers in each region becomes high. For example, the number of composite numbers of the arithmetic progression,  $Ga_n$ , is higher in the 1,000-2,000 region than in the 11,000-12,000 region. Just like a timer that rings after a certain period of time, for a certain  $N$ , the corresponding arithmetic progression operates.

**Theorem 2)** As  $N$  increases, the density of composite numbers becomes higher. In other words, it means that, as  $N$  increases, prime number density becomes low. (of the sparsity of the prime sequence.)

When writing the list of prime numbers, you will find that prime numbers become more and more sparse.

$n$	$\pi(n)$	$\pi(n) / n$
10	4	0.4
$10^2$	25	0.25
$10^3$	168	0.168
$10^4$	1,229	0.1229
$10^5$	9,592	0.09592
$10^6$	78,498	0.078498
$10^7$	664,579	0.066458
$10^8$	5,761,455	0.057615
$10^9$	50,847,534	0.050848
$10^{10}$	455,052,512	0.045505

*Table – 5)* The Sparse of Prime Numbers

The number of prime numbers between 1 and 100 is greater than that between 101 and 200. There are 4 prime numbers (40%) between 0 and 10, 25 prime numbers (25%) between 0 and 100, 168(16.8%) between 0 and 1000, 1,229 (12.3%) between 0 and 10000, 9592 (9.5%) between 0 and 100000, and 78,498 (7.8%) between 0 and 1000000. The percentage gradually decreases. [9][10]

Section	The count of prime	The count of composite	Total
$0 \sim 10^2$	25(0.25)	9(0.09)	34
$10^2 \sim 2 \times 10^2$	21(0.21)	13(0.13)	34
$2 \times 10^2 \sim 3 \times 10^2$	16(0.16)	17(0.17)	33
$3 \times 10^2 \sim 4 \times 10^2$	16(0.16)	17(0.17)	33
$4 \times 10^2 \sim 5 \times 10^2$	17(0.17)	17(0.17)	34
$5 \times 10^2 \sim 6 \times 10^2$	14(0.14)	19(0.19)	33
$6 \times 10^2 \sim 7 \times 10^2$	16(0.16)	17(0.17)	33
$7 \times 10^2 \sim 8 \times 10^2$	14(0.14)	20(0.20)	34
$8 \times 10^2 \sim 9 \times 10^2$	15(0.15)	18(0.18)	33
$9 \times 10^2 \sim 10^3$	14(0.14)	19(0.19)	33

*Table – 6)* Densities of Prime and Composite Numbers in Each Region

Therefore, if you know reason that the number of composite numbers increases, you will know why prime number density decreases. This is because, at least, we know the rules under which composite numbers are generated. This phenomenon is a natural result because new arithmetic progressions accumulate as a natural number,  $N$ , increases. As  $Ga_n, Gb_n, Gc_n \sim Gp_n$  make up groups that all have different initial terms and common differences. Therefore, they make up sixteen groups of arithmetic progressions.

### 3.2 $(12x+5)(12y+5), (Gb_n)$

×	5	17	29	41	53	65	77	89
5	25							
17	85	289						
29	145	493	841					
41	205	697	1189	1681				
53	265	901	1537	2173	2809			
65	325	1105	1885	2665	3445	4225		
77	385	1309	2233	3157	4081	5005	5929	
89	445	1513	2581	3649	4717	5785	6853	7921

- $Gb_1 : 25(a_1) \quad 85(a_2) \quad 145(a_3) \quad 205(a_4) \quad 265(a_5) \quad 325(a_6) \quad 385(a_7) \quad 445(a_8)$
- $Gb_2 : 289(a_1) \quad 493(a_2) \quad 697(a_3) \quad 901(a_4) \quad 1105(a_5) \quad 1903(a_6) \quad 1513(a_7)$
- $Gb_3 : 841(a_1) \quad 1189(a_2) \quad 1537(a_3) \quad 1885(a_4) \quad 2233(a_5) \quad 2581(a_6)$
- $Gb_4 : 1681(a_1) \quad 2173(a_2) \quad 2665(a_3) \quad 3157(a_4) \quad 3649(a_5)$
- $Gb_5 : 2809(a_1) \quad 3445(a_2) \quad 4081(a_3) \quad 4717(a_4)$
- $Gb_6 : 4225(a_1) \quad 5005(a_2) \quad 5785(a_3)$
- $Gb_7 : 5929(a_1) \quad 6853(a_2)$
- $Gb_8 : 7921(a_1)$

- $Gb_1 : a_1 = (12x+5)(12y+5) = 25, \quad d = 12 \times (12y+5) = 60, (x=0, y=0)$
- $Gb_2 : a_1 = (12x+5)(12y+5) = 289, \quad d = 12 \times (12y+5) = 204, (x=1, y=1)$
- $Gb_3 : a_1 = (12x+5)(12y+5) = 841, \quad d = 12 \times (12y+5) = 348, (x=2, y=2)$
- $Gb_4 : a_1 = (12x+5)(12y+5) = 1681, \quad d = 12 \times (12y+5) = 492, (x=3, y=3)$
- $Gb_5 : a_1 = (12x+5)(12y+5) = 2809, \quad d = 12 \times (12y+5) = 636, (x=4, y=4)$
- $Gb_6 : a_1 = (12x+5)(12y+5) = 4225, \quad d = 12 \times (12y+5) = 780, (x=5, y=5)$
- $Gb_7 : a_1 = (12x+5)(12y+5) = 5929, \quad d = 12 \times (12y+5) = 924, (x=6, y=6)$
- $Gb_8 : a_1 = (12x+5)(12y+5) = 7921, \quad d = 12 \times (12y+5) = 1068, (x=7, y=7)$
- ⋮
- $Gb_n : a_1 = (12x+5)(12y+5) = 144xy + 60x + 60y + 25, \quad d = 12 \times (12x+5), (x=n-1, y=n-1)$

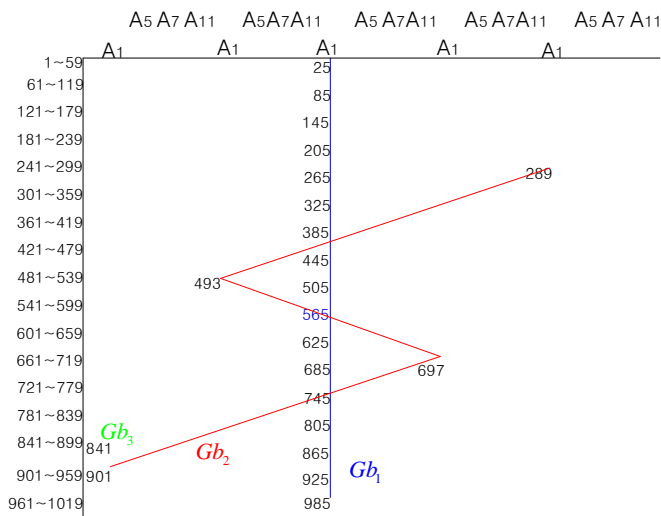

### 3.3 $(12x+7)(12y+7), (Gc_n)$

×	7	19	31	43	55	67	79	91
7	49							
19	133	361						
31	217	589	961					
43	301	817	1333	1849				
55	385	1045	1705	2365	3025			
67	469	1273	2077	2881	3685	4489		
79	553	1501	2449	3397	4345	5293	6241	
91	637	1729	2821	3913	5005	6097	7189	8281

- $Gc_1 : 49(a_1) \quad 133(a_2) \quad 217(a_3) \quad 301(a_4) \quad 385(a_5) \quad 469(a_6) \quad 553(a_7) \quad 637(a_8)$
- $Gc_2 : 361(a_1) \quad 589(a_2) \quad 817(a_3) \quad 1045(a_4) \quad 1273(a_5) \quad 1501(a_6) \quad 1729(a_7)$
- $Gc_3 : 961(a_1) \quad 1333(a_2) \quad 1705(a_3) \quad 2077(a_4) \quad 2449(a_5) \quad 2821(a_6)$
- $Gc_4 : 1849(a_1) \quad 2365(a_2) \quad 2881(a_3) \quad 3397(a_4) \quad 3913(a_5)$
- $Gc_5 : 3025(a_1) \quad 3685(a_2) \quad 4345(a_3) \quad 5005(a_4)$
- $Gc_6 : 4489(a_1) \quad 5293(a_2) \quad 6097(a_3)$
- $Gc_7 : 6241(a_1) \quad 7189(a_2)$
- $Gc_8 : 8281(a_1)$

$Gc_1 : a_1 = (12x+7)(12y+7) = 49, \quad d = 12 \times (12y+7) = 84, (x=0, y=0)$   
 $Gc_2 : a_1 = (12x+7)(12y+7) = 361, \quad d = 12 \times (12y+7) = 228, (x=1, y=1)$   
 $Gc_3 : a_1 = (12x+7)(12y+7) = 961, \quad d = 12 \times (12y+7) = 372, (x=2, y=2)$   
 $Gc_4 : a_1 = (12x+7)(12y+7) = 1849, \quad d = 12 \times (12y+7) = 516, (x=3, y=3)$   
 $Gc_5 : a_1 = (12x+7)(12y+7) = 3025, \quad d = 12 \times (12y+7) = 660, (x=4, y=4)$   
 $Gc_6 : a_1 = (12x+7)(12y+7) = 4489, \quad d = 12 \times (12y+7) = 804, (x=5, y=5)$   
 $Gc_7 : a_1 = (12x+7)(12y+7) = 6241, \quad d = 12 \times (12y+7) = 948, (x=6, y=6)$   
 $Gc_8 : a_1 = (12x+7)(12y+7) = 8281, \quad d = 12 \times (12y+7) = 1092, (x=7, y=7)$   
 $\vdots$   
 $Gc_n : a_1 = (12x+7)(12y+7) = 144xy + 84x + 84y + 49, \quad d = 12 \times (12x+7), (x=n-1, y=n-1)$

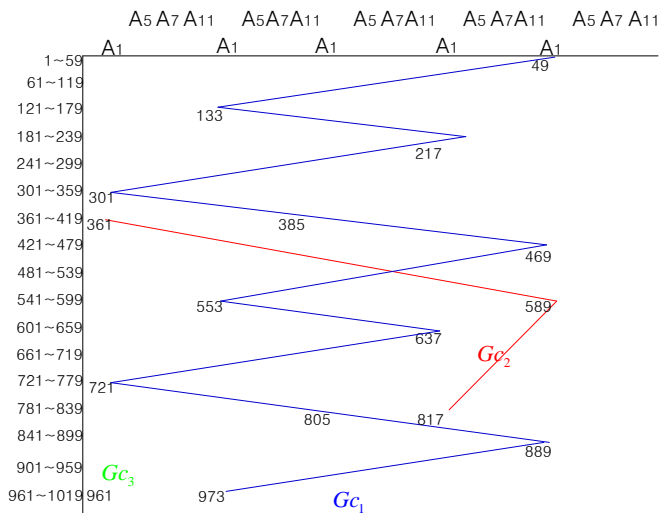

### 3.4 $(12x+11)(12y+11), (Gd_n)$

×	11	23	35	47	59	71	83	95
11	121							
23	253	529						
35	385	805	1225					
47	517	1081	1645	2209				
59	649	1357	2065	2773	3481			
71	781	1633	2485	3337	4189	5041		
83	913	1909	2905	3901	4897	5893	6889	
95	1045	2185	3325	4465	5605	6745	7885	9025

- $Gd_1 : 121(a_1) \quad 253(a_2) \quad 385(a_3) \quad 517(a_4) \quad 649(a_5) \quad 781(a_6) \quad 913(a_7) \quad 1045(a_8)$   
 $Gd_2 : 529(a_1) \quad 805(a_2) \quad 1081(a_3) \quad 1357(a_4) \quad 1633(a_5) \quad 1909(a_6) \quad 2185(a_7)$   
 $Gd_3 : 1225(a_1) \quad 1645(a_2) \quad 2065(a_3) \quad 2485(a_4) \quad 2905(a_5) \quad 3325(a_6)$   
 $Gd_4 : 2209(a_1) \quad 2773(a_2) \quad 3337(a_3) \quad 3901(a_4) \quad 4465(a_5)$   
 $Gd_5 : 3481(a_1) \quad 4189(a_2) \quad 4897(a_3) \quad 5605(a_4)$   
 $Gd_6 : 5041(a_1) \quad 5893(a_2) \quad 6745(a_3)$   
 $Gd_7 : 6889(a_1) \quad 7885(a_2)$   
 $Gd_8 : 9025(a_1)$

- $Gd_1 : a_1 = (12x+11)(12y+11) = 121, \quad d = 12 \times (12y+11) = 132, (x=0, y=0)$   
 $Gd_2 : a_1 = (12x+11)(12y+11) = 529, \quad d = 12 \times (12y+11) = 276, (x=1, y=1)$   
 $Gd_3 : a_1 = (12x+11)(12y+11) = 1225, \quad d = 12 \times (12y+11) = 420, (x=2, y=2)$   
 $Gd_4 : a_1 = (12x+11)(12y+11) = 2209, \quad d = 12 \times (12y+11) = 564, (x=3, y=3)$   
 $Gd_5 : a_1 = (12x+11)(12y+11) = 3481, \quad d = 12 \times (12y+11) = 708, (x=4, y=4)$   
 $Gd_6 : a_1 = (12x+11)(12y+11) = 5041, \quad d = 12 \times (12y+11) = 852, (x=5, y=5)$   
 $Gd_7 : a_1 = (12x+11)(12y+11) = 6889, \quad d = 12 \times (12y+11) = 996, (x=6, y=6)$   
 $Gd_8 : a_1 = (12x+11)(12y+11) = 9025, \quad d = 12 \times (12y+11) = 1140, (x=7, y=7)$   
 $\vdots$   
 $Gd_n : a_1 = (12x+11)(12y+11) = 144xy + 132x + 132y + 121, \quad d = 12 \times (12y+11), (x=n-1, y=n-1)$

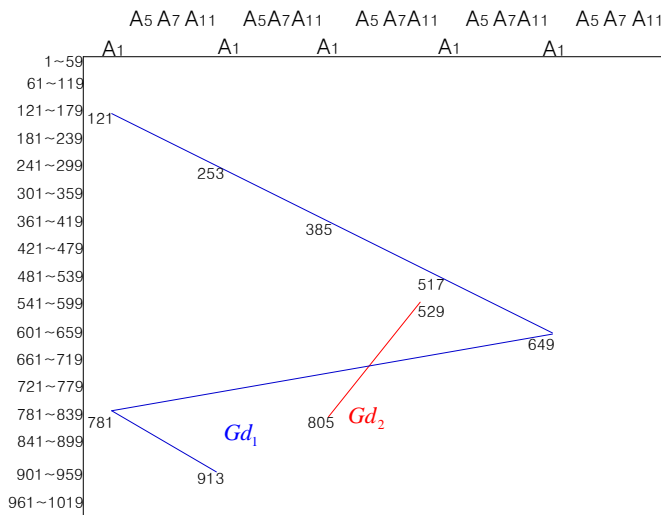

### 3.5 $(12x+1)(12y+5), (Ge_n)$

×	13	25	37	49	61	73	85	97
5	65							
17	221	425						
29	377	725	1073					
41	533	1025	1517	2009				
53	689	1325	1961	2597	3233			
65	845	1625	2405	3185	3965	4745		
77	1001	1925	2849	3773	4697	5621	6545	
89	1157	2225	3293	4361	5429	6497	7565	8633

- $Ge_1: 65(a_1) \quad 221(a_2) \quad 377(a_3) \quad 533(a_4) \quad 689(a_5) \quad 845(a_6) \quad 1001(a_7) \quad 1157(a_8)$   
 $Ge_2: 425(a_1) \quad 725(a_2) \quad 1025(a_3) \quad 1325(a_4) \quad 1625(a_5) \quad 1925(a_6) \quad 2225(a_7)$   
 $Ge_3: 1073(a_1) \quad 1517(a_2) \quad 1961(a_3) \quad 2405(a_4) \quad 2849(a_5) \quad 3293(a_6)$   
 $Ge_4: 2009(a_1) \quad 2597(a_2) \quad 3185(a_3) \quad 3773(a_4) \quad 4361(a_5)$   
 $Ge_5: 3233(a_1) \quad 3965(a_2) \quad 4697(a_3) \quad 5429(a_4)$   
 $Ge_6: 4745(a_1) \quad 5621(a_2) \quad 6497(a_3)$   
 $Ge_7: 6545(a_1) \quad 7565(a_2)$   
 $Ge_8: 8633(a_1)$

$Ge_1: a_1 = (12x+1)(12y+5) = 65, \quad d = 12 \times (12x+1) = 156(x=1, y=0)$   
 $Ge_2: a_1 = (12x+1)(12y+5) = 425, \quad d = 12 \times (12x+1) = 300(x=2, y=1)$   
 $Ge_3: a_1 = (12x+1)(12y+5) = 1073, \quad d = 12 \times (12x+1) = 444(x=3, y=2)$   
 $Ge_4: a_1 = (12x+1)(12y+5) = 2009, \quad d = 12 \times (12x+1) = 588(x=4, y=3)$   
 $Ge_5: a_1 = (12x+1)(12y+5) = 3233, \quad d = 12 \times (12x+1) = 732(x=5, y=4)$   
 $Ge_6: a_1 = (12x+1)(12y+5) = 4745, \quad d = 12 \times (12x+1) = 876(x=6, y=5)$   
 $Ge_7: a_1 = (12x+1)(12y+5) = 6545, \quad d = 12 \times (12x+1) = 1020(x=7, y=6)$   
 $Ge_8: a_1 = (12x+1)(12y+5) = 8633, \quad d = 12 \times (12x+1) = 1164(x=8, y=7)$   
 $\vdots$   
 $Ge_n: a_1 = (12x+1)(12y+5) = 144xy + 60x + 12y + 5, \quad d = 12 \times (12x+1)(x=n, y=n-1)$

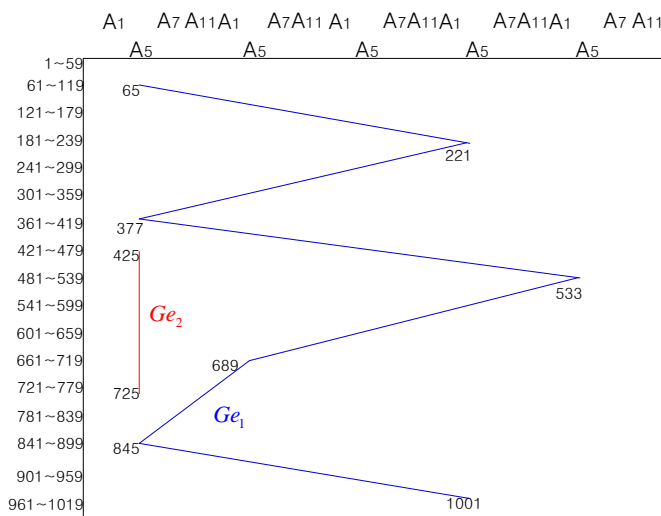

### 3.6 $(12x+5)(12y+1), (Gf_n)$

×	5	17	29	41	53	65	77	89
13	65							
25	125	425						
37	185	629	1073					
49	245	833	1421	2009				
61	305	1037	1769	2501	3233			
73	365	1241	2117	2993	3869	4745		
85	425	1445	2465	3485	4505	5525	6545	
97	485	1649	2813	3977	5141	6305	7469	8633

- $Gf_1: 65(a_1) \quad 125(a_2) \quad 185(a_3) \quad 245(a_4) \quad 305(a_5) \quad 365(a_6) \quad 425(a_7) \quad 485(a_8)$
- $Gf_2: 425(a_1) \quad 629(a_2) \quad 833(a_3) \quad 1037(a_4) \quad 1241(a_5) \quad 1445(a_6) \quad 1649(a_7)$
- $Gf_3: 1073(a_1) \quad 1421(a_2) \quad 1769(a_3) \quad 2117(a_4) \quad 2465(a_5) \quad 2813(a_6)$
- $Gf_4: 2009(a_1) \quad 2501(a_2) \quad 2993(a_3) \quad 3485(a_4) \quad 3977(a_5)$
- $Gf_5: 3233(a_1) \quad 3869(a_2) \quad 4505(a_3) \quad 5141(a_4)$
- $Gf_6: 4745(a_1) \quad 5525(a_2) \quad 6305(a_3)$
- $Gf_7: 6545(a_1) \quad 7469(a_2)$
- $Gf_8: 8633(a_1)$

$Gf_1: a_1 = (12x+5)(12y+1) = 65, \quad d = 12 \times (12x+5) = 60 (x=0, y=1)$   
 $Gf_2: a_1 = (12x+5)(12y+1) = 425, \quad d = 12 \times (12x+5) = 204 (x=1, y=2)$   
 $Gf_3: a_1 = (12x+5)(12y+1) = 1073, \quad d = 12 \times (12x+5) = 348 (x=2, y=3)$   
 $Gf_4: a_1 = (12x+5)(12y+1) = 2009, \quad d = 12 \times (12x+5) = 492 (x=3, y=4)$   
 $Gf_5: a_1 = (12x+5)(12y+1) = 3233, \quad d = 12 \times (12x+5) = 636 (x=4, y=5)$   
 $Gf_6: a_1 = (12x+5)(12y+1) = 4745, \quad d = 12 \times (12x+5) = 780 (x=5, y=6)$   
 $Gf_7: a_1 = (12x+5)(12y+1) = 6545, \quad d = 12 \times (12x+5) = 924 (x=6, y=7)$   
 $Gf_8: a_1 = (12x+5)(12y+1) = 8633, \quad d = 12 \times (12x+5) = 1068 (x=7, y=8)$   
 $\vdots$   
 $Gf_n: a_1 = (12x+5)(12y+1) = 144xy + 12x + 60y + 5, \quad d = 12 \times (12y+5) (x=n-1, y=n)$

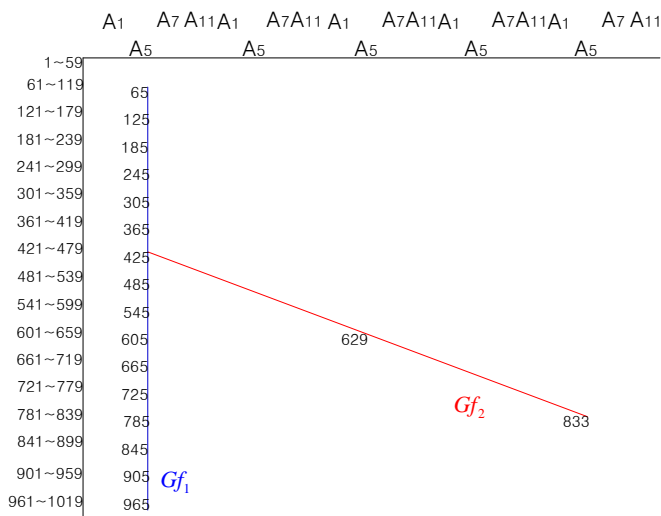



### 3.7 $(12x+7)(12y+11), (Gg_n)$

×	7	19	31	43	55	67	79	91
11	77							
23	161	437						
35	245	665	1085					
47	329	893	1457	2021				
59	413	1121	1829	2537	3245			
71	497	1349	2201	3053	3905	4757		
83	581	1577	2573	3569	4565	5561	6557	
95	665	1805	2945	4085	5225	6365	7505	8645

- Gg<sub>1</sub> : 77(a<sub>1</sub>)    161(a<sub>2</sub>)    245(a<sub>3</sub>)    329(a<sub>4</sub>)    413(a<sub>5</sub>)    497(a<sub>6</sub>)    581(a<sub>7</sub>)    665(a<sub>8</sub>)
- Gg<sub>2</sub> : 437(a<sub>1</sub>)    665(a<sub>2</sub>)    893(a<sub>3</sub>)    1121(a<sub>4</sub>)    1349(a<sub>5</sub>)    1577(a<sub>6</sub>)    1805(a<sub>7</sub>)
- Gg<sub>3</sub> : 1085(a<sub>1</sub>)    1457(a<sub>2</sub>)    1829(a<sub>3</sub>)    2201(a<sub>4</sub>)    2573(a<sub>5</sub>)    2945(a<sub>6</sub>)
- Gg<sub>4</sub> : 2021(a<sub>1</sub>)    2537(a<sub>2</sub>)    3053(a<sub>3</sub>)    3569(a<sub>4</sub>)    4085(a<sub>5</sub>)
- Gg<sub>5</sub> : 3245(a<sub>1</sub>)    3905(a<sub>2</sub>)    4565(a<sub>3</sub>)    5225(a<sub>4</sub>)
- Gg<sub>6</sub> : 4757(a<sub>1</sub>)    5561(a<sub>2</sub>)    6365(a<sub>3</sub>)
- Gg<sub>7</sub> : 6557(a<sub>1</sub>)    7505(a<sub>2</sub>)
- Gg<sub>8</sub> : 8645(a<sub>1</sub>)

$Gg_1 : a_1 = (12x+7)(12y+11) = 77, \quad d = 12 \times (12x+7) = 84 (x=0, y=0)$   
 $Gg_2 : a_1 = (12x+7)(12y+11) = 437, \quad d = 12 \times (12x+7) = 228 (x=1, y=1)$   
 $Gg_3 : a_1 = (12x+7)(12y+11) = 1085, \quad d = 12 \times (12x+7) = 372 (x=2, y=2)$   
 $Gg_4 : a_1 = (12x+7)(12y+11) = 2021, \quad d = 12 \times (12x+7) = 516 (x=3, y=3)$   
 $Gg_5 : a_1 = (12x+7)(12y+11) = 3245, \quad d = 12 \times (12x+7) = 660 (x=4, y=4)$   
 $Gg_6 : a_1 = (12x+7)(12y+11) = 4757, \quad d = 12 \times (12x+7) = 804 (x=5, y=5)$   
 $Gg_7 : a_1 = (12x+7)(12y+11) = 6557, \quad d = 12 \times (12x+7) = 948 (x=6, y=6)$   
 $Gg_8 : a_1 = (12x+7)(12y+11) = 8645, \quad d = 12 \times (12x+7) = 1092 (x=7, y=7)$   
 $\vdots$   
 $Gg_n : a_1 = (12x+7)(12y+11) = 144xy + 132x + 84y + 77, \quad d = 12 \times (12x+7) (x=n-1, y=n-1)$

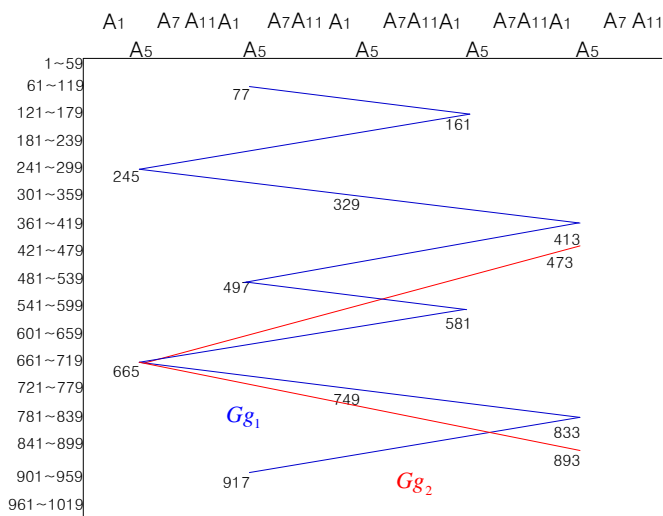

### 3.8 $(12x+11)(12y+7), (Gh_n)$

×	11	23	35	47	59	71	83	95
7	77							
19	209	437						
31	341	713	1085					
43	473	989	1505	2021				
55	605	1265	1925	2585	3245			
67	737	1541	2345	3149	3953	4757		
79	869	1817	2765	3713	4661	5609	6557	
91	1001	2093	3185	4277	5369	6461	7553	8645

- Gh<sub>1</sub> : 77(a<sub>1</sub>)    209(a<sub>2</sub>)    341(a<sub>3</sub>)    473(a<sub>4</sub>)    605(a<sub>5</sub>)    737(a<sub>6</sub>)    869(a<sub>7</sub>)    1001(a<sub>8</sub>)
- Gh<sub>2</sub> : 437(a<sub>1</sub>)    713(a<sub>2</sub>)    989(a<sub>3</sub>)    1265(a<sub>4</sub>)    1541(a<sub>5</sub>)    1817(a<sub>6</sub>)    2093(a<sub>7</sub>)
- Gh<sub>3</sub> : 1085(a<sub>1</sub>)    1505(a<sub>2</sub>)    1925(a<sub>3</sub>)    2345(a<sub>4</sub>)    2765(a<sub>5</sub>)    3185(a<sub>6</sub>)
- Gh<sub>4</sub> : 2021(a<sub>1</sub>)    2585(a<sub>2</sub>)    3149(a<sub>3</sub>)    3713(a<sub>4</sub>)    4277(a<sub>5</sub>)
- Gh<sub>5</sub> : 3245(a<sub>1</sub>)    3965(a<sub>2</sub>)    4661(a<sub>3</sub>)    5369(a<sub>4</sub>)
- Gh<sub>6</sub> : 4757(a<sub>1</sub>)    5609(a<sub>2</sub>)    6461(a<sub>3</sub>)
- Gh<sub>7</sub> : 6557(a<sub>1</sub>)    7553(a<sub>2</sub>)
- Gh<sub>8</sub> : 8645(a<sub>1</sub>)

Gh<sub>1</sub> : a<sub>1</sub> = (12x+11)(12y+7) = 77,    d = 12 × (12x+11) = 132 (x=0, y=0)  
 Gh<sub>2</sub> : a<sub>1</sub> = (12x+11)(12y+7) = 437,    d = 12 × (12x+11) = 276 (x=1, y=1)  
 Gh<sub>3</sub> : a<sub>1</sub> = (12x+11)(12y+7) = 1085,    d = 12 × (12x+11) = 420 (x=2, y=2)  
 Gh<sub>4</sub> : a<sub>1</sub> = (12x+11)(12y+7) = 2021,    d = 12 × (12x+11) = 564 (x=3, y=3)  
 Gh<sub>5</sub> : a<sub>1</sub> = (12x+11)(12y+7) = 3245,    d = 12 × (12x+11) = 708 (x=4, y=4)  
 Gh<sub>6</sub> : a<sub>1</sub> = (12x+11)(12y+7) = 4757,    d = 12 × (12x+11) = 852 (x=5, y=5)  
 Gh<sub>7</sub> : a<sub>1</sub> = (12x+11)(12y+7) = 6557,    d = 12 × (12x+11) = 996 (x=6, y=6)  
 Gh<sub>8</sub> : a<sub>1</sub> = (12x+11)(12y+7) = 8645,    d = 12 × (12x+11) = 1140 (x=7, y=7)  
 :  
 Gh<sub>n</sub> : a<sub>1</sub> = (12x+11)(12y+7) = 144xy + 84x + 132y + 77,    d = 12 × (12x+11) (x=n-1, y=n-1)

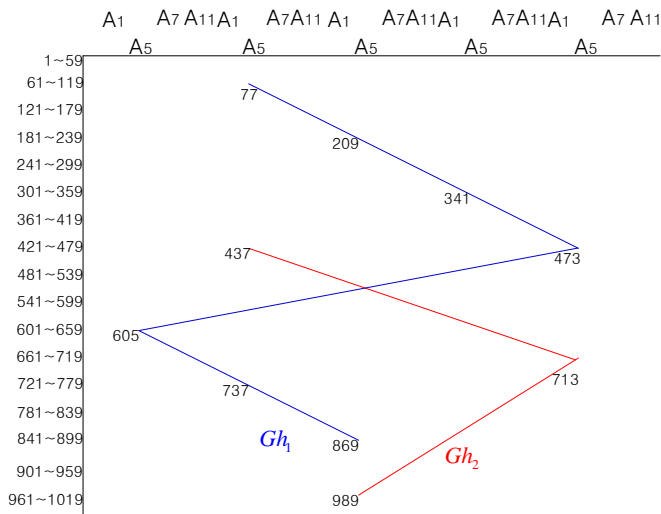

### 3.9 $(12x+1)(12y+7), (Gi_n)$

×	13	25	37	49	61	73	85	97
7	91							
19	247	475						
31	403	775	1147					
43	559	1075	1591	2107				
55	715	1375	2035	2695	3355			
67	871	1675	2479	3283	4087	4891		
79	1027	1975	2923	3871	4819	5767	6715	
91	1183	2275	3367	4459	5551	6643	7735	8827

- $Gi_1: 91(a_1) \quad 247(a_2) \quad 403(a_3) \quad 559(a_4) \quad 715(a_5) \quad 871(a_6) \quad 1027(a_7) \quad 1183(a_8)$
- $Gi_2: 475(a_1) \quad 775(a_2) \quad 1075(a_3) \quad 1375(a_4) \quad 1675(a_5) \quad 1975(a_6) \quad 2275(a_7)$
- $Gi_3: 1147(a_1) \quad 1591(a_2) \quad 2035(a_3) \quad 2479(a_4) \quad 2923(a_5) \quad 3367(a_6)$
- $Gi_4: 2107(a_1) \quad 2695(a_2) \quad 3283(a_3) \quad 3871(a_4) \quad 4459(a_5)$
- $Gi_5: 3355(a_1) \quad 4087(a_2) \quad 4819(a_3) \quad 5551(a_4)$
- $Gi_6: 4891(a_1) \quad 5767(a_2) \quad 6643(a_3)$
- $Gi_7: 6715(a_1) \quad 7735(a_2)$
- $Gi_8: 8827(a_1)$

$Gi_1: a_1 = (12x+1)(12y+7) = 91, \quad d = 12 \times (12x+1) = 156(x=1, y=0)$   
 $Gi_2: a_1 = (12x+1)(12y+7) = 475, \quad d = 12 \times (12x+1) = 300(x=2, y=1)$   
 $Gi_3: a_1 = (12x+1)(12y+7) = 1147, \quad d = 12 \times (12x+1) = 444(x=3, y=2)$   
 $Gi_4: a_1 = (12x+1)(12y+7) = 2107, \quad d = 12 \times (12x+1) = 588(x=4, y=3)$   
 $Gi_5: a_1 = (12x+1)(12y+7) = 3355, \quad d = 12 \times (12x+1) = 732(x=5, y=4)$   
 $Gi_6: a_1 = (12x+1)(12y+7) = 4891, \quad d = 12 \times (12x+1) = 876(x=6, y=5)$   
 $Gi_7: a_1 = (12x+1)(12y+7) = 6715, \quad d = 12 \times (12x+1) = 1020(x=7, y=6)$   
 $Gi_8: a_1 = (12x+1)(12y+7) = 8827, \quad d = 12 \times (12x+1) = 1164(x=8, y=7)$   
 $\vdots$   
 $Gi_n: a_1 = (12x+1)(12y+7) = 144xy + 84x + 12y + 7, \quad d = 12 \times (12x+1)(x=n, y=n-1)$

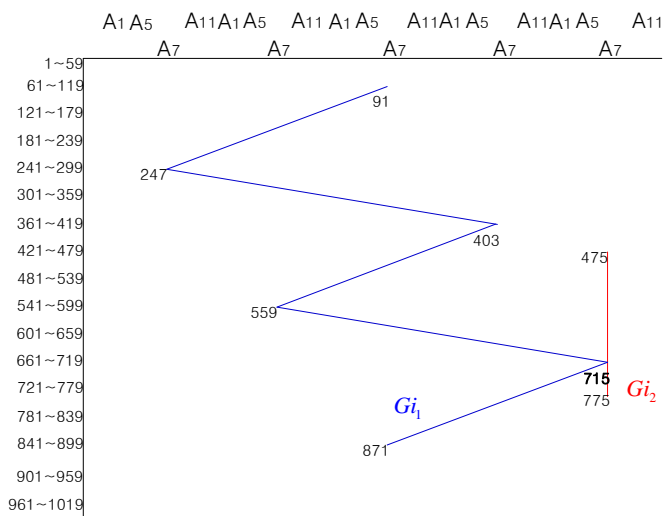

### 3.10 $(12x+7)(12y+1), (G_j^n)$

×	7	19	31	43	55	67	79	91
13	91							
25	175	475						
37	259	703	1147					
49	343	931	1519	2107				
61	427	1159	1891	2623	3355			
73	511	1387	2263	3139	4015	4891		
85	595	1615	2635	3655	4675	5695	6715	
97	679	1843	3007	4171	5335	6499	7663	8827

- $G_{j_1}: 91(a_1) \quad 175(a_2) \quad 259(a_3) \quad 343(a_4) \quad 427(a_5) \quad 511(a_6) \quad 595(a_7) \quad 679(a_8)$
- $G_{j_2}: 475(a_1) \quad 703(a_2) \quad 931(a_3) \quad 1159(a_4) \quad 1387(a_5) \quad 1615(a_6) \quad 1843(a_7)$
- $G_{j_3}: 1147(a_1) \quad 1519(a_2) \quad 1891(a_3) \quad 2263(a_4) \quad 2635(a_5) \quad 3007(a_6)$
- $G_{j_4}: 2107(a_1) \quad 2623(a_2) \quad 3139(a_3) \quad 3655(a_4) \quad 4171(a_5)$
- $G_{j_5}: 3355(a_1) \quad 4015(a_2) \quad 4675(a_3) \quad 5335(a_4)$
- $G_{j_6}: 4891(a_1) \quad 5695(a_2) \quad 6499(a_3)$
- $G_{j_7}: 6715(a_1) \quad 7663(a_2)$
- $G_{j_8}: 8827(a_1)$

- $G_{j_1}: a_1 = (12x+7)(12y+1) = 91, \quad d = 12 \times (12x+7) = 84(x=0, y=1)$
- $G_{j_2}: a_1 = (12x+7)(12y+1) = 475, \quad d = 12 \times (12x+7) = 228(x=1, y=2)$
- $G_{j_3}: a_1 = (12x+7)(12y+1) = 1147, \quad d = 12 \times (12x+7) = 372(x=2, y=3)$
- $G_{j_4}: a_1 = (12x+7)(12y+1) = 2107, \quad d = 12 \times (12x+7) = 516(x=3, y=4)$
- $G_{j_5}: a_1 = (12x+7)(12y+1) = 3355, \quad d = 12 \times (12x+7) = 660(x=4, y=5)$
- $G_{j_6}: a_1 = (12x+7)(12y+1) = 4891, \quad d = 12 \times (12x+7) = 804(x=5, y=6)$
- $G_{j_7}: a_1 = (12x+7)(12y+1) = 6715, \quad d = 12 \times (12x+7) = 948(x=6, y=7)$
- $G_{j_8}: a_1 = (12x+7)(12y+1) = 8827, \quad d = 12 \times (12x+7) = 1092(x=7, y=8)$
- ⋮
- $G_{j_n}: a_1 = (12x+7)(12y+1) = 144xy + 12x + 84y + 7, \quad d = 12 \times (12x+7)(x=n-1, y=n)$

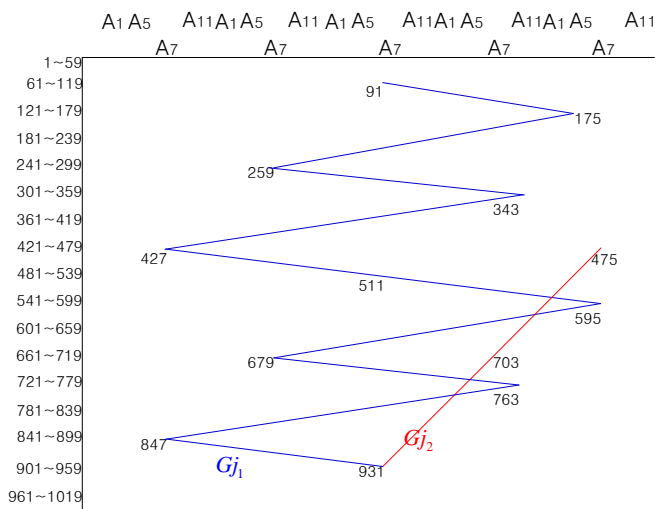

### 3.11 $(12x+5)(12y+11), (Gk_n)$

×	5	17	29	41	53	65	77	89
11	55							
23	115	391						
35	175	595	1015					
47	235	799	1363	1927				
59	295	1003	1711	2419	3127			
71	355	1207	2059	2911	3763	4615		
83	415	1411	2407	3403	4399	5395	6391	
95	475	1615	2755	3895	5035	6175	7315	8455

- Gk<sub>1</sub> : 55(a<sub>1</sub>)    115(a<sub>2</sub>)    175(a<sub>3</sub>)    235(a<sub>4</sub>)    295(a<sub>5</sub>)    355(a<sub>6</sub>)    415(a<sub>7</sub>)    475(a<sub>8</sub>)
- Gk<sub>2</sub> : 391(a<sub>1</sub>)    595(a<sub>2</sub>)    799(a<sub>3</sub>)    1003(a<sub>4</sub>)    1207(a<sub>5</sub>)    1411(a<sub>6</sub>)    1615(a<sub>7</sub>)
- Gk<sub>3</sub> : 1015(a<sub>1</sub>)    1363(a<sub>2</sub>)    1711(a<sub>3</sub>)    2059(a<sub>4</sub>)    2407(a<sub>5</sub>)    2755(a<sub>6</sub>)
- Gk<sub>4</sub> : 1927(a<sub>1</sub>)    2419(a<sub>2</sub>)    2911(a<sub>3</sub>)    3403(a<sub>4</sub>)    3895(a<sub>5</sub>)
- Gk<sub>5</sub> : 3127(a<sub>1</sub>)    3763(a<sub>2</sub>)    4399(a<sub>3</sub>)    5035(a<sub>4</sub>)
- Gk<sub>6</sub> : 4615(a<sub>1</sub>)    5395(a<sub>2</sub>)    6175(a<sub>3</sub>)
- Gk<sub>7</sub> : 6391(a<sub>1</sub>)    7315(a<sub>2</sub>)
- Gk<sub>8</sub> : 8455(a<sub>1</sub>)

- Gk<sub>1</sub> : a<sub>1</sub> = (12x+5)(12y+11) = 55,    d = 12 × (12x+5) = 60 (x=0, y=0)
- Gk<sub>2</sub> : a<sub>1</sub> = (12x+5)(12y+11) = 391,    d = 12 × (12x+5) = 204 (x=1, y=1)
- Gk<sub>3</sub> : a<sub>1</sub> = (12x+5)(12y+11) = 1015,    d = 12 × (12x+5) = 348 (x=2, y=2)
- Gk<sub>4</sub> : a<sub>1</sub> = (12x+5)(12y+11) = 1927,    d = 12 × (12x+5) = 492 (x=3, y=3)
- Gk<sub>5</sub> : a<sub>1</sub> = (12x+5)(12y+11) = 3127,    d = 12 × (12x+5) = 636 (x=4, y=4)
- Gk<sub>6</sub> : a<sub>1</sub> = (12x+5)(12y+11) = 4615,    d = 12 × (12x+5) = 780 (x=5, y=5)
- Gk<sub>7</sub> : a<sub>1</sub> = (12x+5)(12y+11) = 6391,    d = 12 × (12x+5) = 924 (x=6, y=6)
- Gk<sub>8</sub> : a<sub>1</sub> = (12x+5)(12y+11) = 8455,    d = 12 × (12x+5) = 1068 (x=7, y=7)
- ⋮
- Gk<sub>n</sub> : a<sub>1</sub> = (12x+5)(12y+11) = 144xy + 132x + 60y + 55,    d = 12 × (12x+5) (x = n-1, y = n-1)

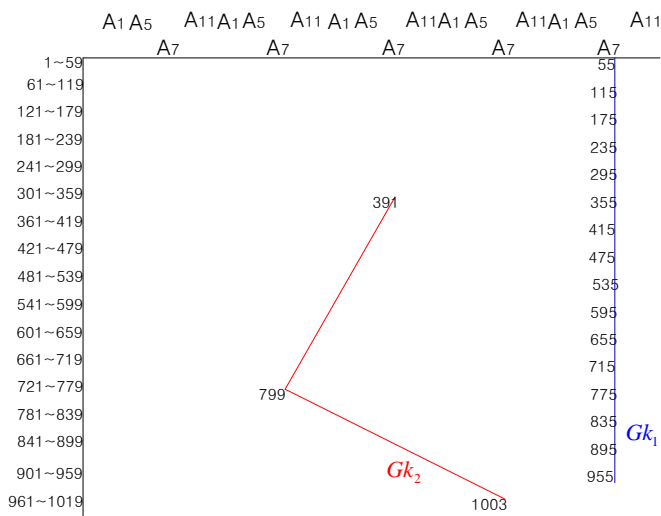

### 3.12 $(12x+11)(12y+5), (Gl_n)$

×	11	23	35	47	59	71	83	95
5	55							
17	187	391						
29	319	667	1015					
41	451	943	1435	1927				
53	583	1219	1855	2491	3127			
65	715	1495	2275	3055	3835	4615		
77	847	1771	2695	3619	4543	5467	6391	
89	979	2047	3115	4183	5251	6319	7387	8455

- $Gl_1: 55(a_1) \quad 187(a_2) \quad 319(a_3) \quad 451(a_4) \quad 583(a_5) \quad 715(a_6) \quad 847(a_7) \quad 979(a_8)$
- $Gl_2: 391(a_1) \quad 667(a_2) \quad 943(a_3) \quad 1219(a_4) \quad 1495(a_5) \quad 1771(a_6) \quad 2047(a_7)$
- $Gl_3: 1015(a_1) \quad 1435(a_2) \quad 1855(a_3) \quad 2275(a_4) \quad 2695(a_5) \quad 3115(a_6)$
- $Gl_4: 1927(a_1) \quad 2491(a_2) \quad 3055(a_3) \quad 3619(a_4) \quad 4183(a_5)$
- $Gl_5: 3127(a_1) \quad 3835(a_2) \quad 4543(a_3) \quad 5251(a_4)$
- $Gl_6: 4615(a_1) \quad 5467(a_2) \quad 6319(a_3)$
- $Gl_7: 6391(a_1) \quad 7387(a_2)$
- $Gl_8: 8455(a_1)$

$Gl_1 : a_1 = (12x+11)(12y+5) = 55, \quad d = 12 \times (12x+11) = 132 (x=0, y=0)$   
 $Gl_2 : a_1 = (12x+11)(12y+5) = 391, \quad d = 12 \times (12x+11) = 276 (x=1, y=1)$   
 $Gl_3 : a_1 = (12x+11)(12y+5) = 1015, \quad d = 12 \times (12x+11) = 420 (x=2, y=2)$   
 $Gl_4 : a_1 = (12x+11)(12y+5) = 1927, \quad d = 12 \times (12x+11) = 564 (x=3, y=3)$   
 $Gl_5 : a_1 = (12x+11)(12y+5) = 3127, \quad d = 12 \times (12x+11) = 708 (x=4, y=4)$   
 $Gl_6 : a_1 = (12x+11)(12y+5) = 4615, \quad d = 12 \times (12x+11) = 852 (x=5, y=5)$   
 $Gl_7 : a_1 = (12x+11)(12y+5) = 6391, \quad d = 12 \times (12x+11) = 996 (x=6, y=6)$   
 $Gl_8 : a_1 = (12x+11)(12y+5) = 8455, \quad d = 12 \times (12x+11) = 1140 (x=7, y=7)$   
 $\vdots$   
 $Gl_n : a_1 = (12x+11)(12y+5) = 144xy + 60x + 132y + 55, \quad d = 12 \times (12x+11) (x=n-1, y=n-1)$

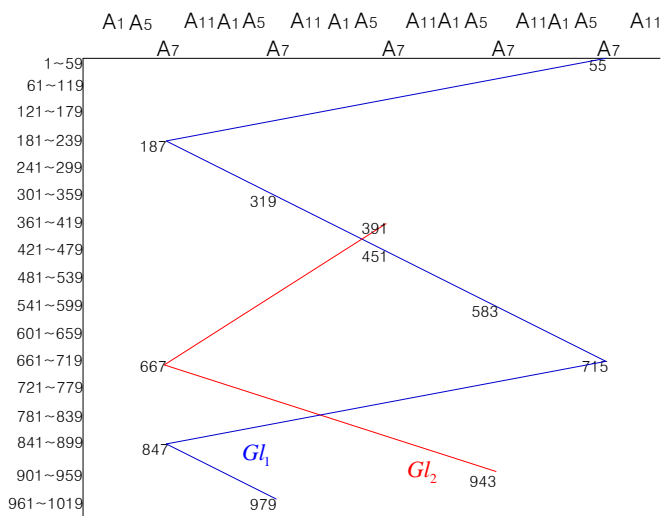

### 3.13 $(12x+1)(12y+11), (Gm_n)$

×	13	25	37	49	61	73	85	97
11	143							
23	299	575						
35	455	875	1295					
47	611	1175	1739	2303				
59	767	1475	2183	2891	3599			
71	923	1775	2627	3479	4331	5183		
83	1079	2075	3071	4067	5063	6059	7055	
95	1235	2375	3515	4655	5795	6935	8075	9215

- $Gm_1 : 143(a_1) \quad 299(a_2) \quad 455(a_3) \quad 611(a_4) \quad 767(a_5) \quad 923(a_6) \quad 1079(a_7) \quad 1235(a_8)$   
 $Gm_2 : 575(a_1) \quad 875(a_2) \quad 1175(a_3) \quad 1475(a_4) \quad 1775(a_5) \quad 2075(a_6) \quad 2375(a_7)$   
 $Gm_3 : 1295(a_1) \quad 1739(a_2) \quad 2183(a_3) \quad 2627(a_4) \quad 3071(a_5) \quad 3515(a_6)$   
 $Gm_4 : 2303(a_1) \quad 2891(a_2) \quad 3479(a_3) \quad 4067(a_4) \quad 4655(a_5)$   
 $Gm_5 : 3599(a_1) \quad 4331(a_2) \quad 5063(a_3) \quad 5795(a_4)$   
 $Gm_6 : 5183(a_1) \quad 6059(a_2) \quad 6935(a_3)$   
 $Gm_7 : 7055(a_1) \quad 8075(a_2)$   
 $Gm_8 : 9215(a_1)$

$Gm_1 : a_1 = (12x+1)(12y+11) = 143, \quad d = 12 \times (12x+1) = 156 (x=1, y=0)$   
 $Gm_2 : a_1 = (12x+1)(12y+11) = 575, \quad d = 12 \times (12x+1) = 300 (x=2, y=1)$   
 $Gm_3 : a_1 = (12x+1)(12y+11) = 1295, \quad d = 12 \times (12x+1) = 444 (x=3, y=2)$   
 $Gm_4 : a_1 = (12x+1)(12y+11) = 2303, \quad d = 12 \times (12x+1) = 588 (x=4, y=3)$   
 $Gm_5 : a_1 = (12x+1)(12y+11) = 3599, \quad d = 12 \times (12x+1) = 732 (x=5, y=4)$   
 $Gm_6 : a_1 = (12x+1)(12y+11) = 5183, \quad d = 12 \times (12x+1) = 876 (x=6, y=5)$   
 $Gm_7 : a_1 = (12x+1)(12y+11) = 7055, \quad d = 12 \times (12x+1) = 1020 (x=7, y=6)$   
 $Gm_8 : a_1 = (12x+1)(12y+11) = 9215, \quad d = 12 \times (12x+1) = 1164 (x=8, y=7)$   
 $\vdots$   
 $Gm_n : a_1 = (12x+1)(12y+11) = 144xy + 132x + 12y + 11, \quad d = 12 \times (12x+1) (x=n, y=n-1)$

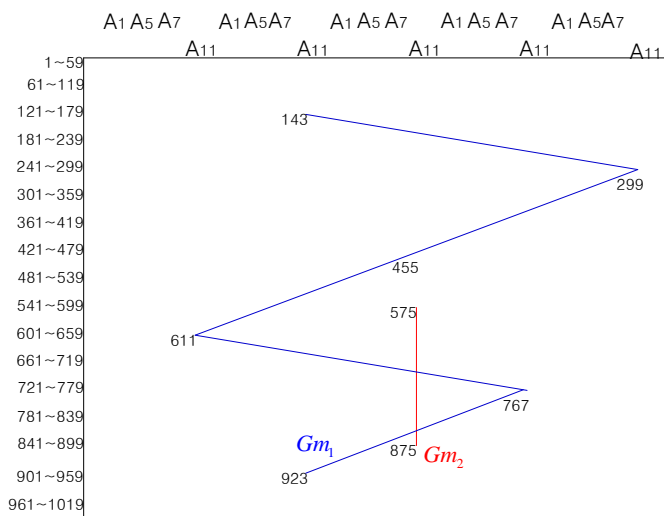

### 3.14 $(12x+11)(12y+1), (Gn_n)$

×	11	23	35	47	59	71	83	95
13	143							
25	275	575						
37	407	851	1295					
49	539	1127	1715	2303				
61	671	1403	2135	2867	3599			
73	803	1679	2555	3431	4307	5183		
85	935	1955	2975	3995	5015	6035	7055	
97	1067	2231	3395	4559	5723	6887	8051	9215

- $Gn_1 : 143(a_1) \quad 275(a_2) \quad 407(a_3) \quad 539(a_4) \quad 671(a_5) \quad 803(a_6) \quad 935(a_7) \quad 1067(a_8)$   
 $Gn_2 : 575(a_1) \quad 851(a_2) \quad 1127(a_3) \quad 1403(a_4) \quad 1679(a_5) \quad 1955(a_6) \quad 2231(a_7)$   
 $Gn_3 : 1295(a_1) \quad 1715(a_2) \quad 2135(a_3) \quad 2555(a_4) \quad 2975(a_5) \quad 3395(a_6)$   
 $Gn_4 : 2303(a_1) \quad 2867(a_2) \quad 3431(a_3) \quad 3995(a_4) \quad 4559(a_5)$   
 $Gn_5 : 3599(a_1) \quad 4307(a_2) \quad 5015(a_3) \quad 5723(a_4)$   
 $Gn_6 : 5183(a_1) \quad 6035(a_2) \quad 6887(a_3)$   
 $Gn_7 : 7055(a_1) \quad 8051(a_2)$   
 $Gn_8 : 9215(a_1)$

$Gn_1 : a_1 = (12x+11)(12y+1) = 143, \quad d = 12 \times (12x+11) = 132(x=0, y=1)$   
 $Gn_2 : a_1 = (12x+11)(12y+1) = 575, \quad d = 12 \times (12x+11) = 276(x=1, y=2)$   
 $Gn_3 : a_1 = (12x+11)(12y+1) = 1295, \quad d = 12 \times (12x+11) = 420(x=2, y=3)$   
 $Gn_4 : a_1 = (12x+11)(12y+1) = 2303, \quad d = 12 \times (12x+11) = 564(x=3, y=4)$   
 $Gn_5 : a_1 = (12x+11)(12y+1) = 3599, \quad d = 12 \times (12x+11) = 708(x=4, y=5)$   
 $Gn_6 : a_1 = (12x+11)(12y+1) = 5183, \quad d = 12 \times (12x+11) = 852(x=5, y=6)$   
 $Gn_7 : a_1 = (12x+11)(12y+1) = 7055, \quad d = 12 \times (12x+11) = 996(x=6, y=7)$   
 $Gn_8 : a_1 = (12x+11)(12y+1) = 9215, \quad d = 12 \times (12x+11) = 1140(x=7, y=8)$   
 $\vdots$   
 $Gn_n : a_1 = (12x+11)(12y+1) = 144xy + 12x + 132y + 11, \quad d = 12 \times (12x+11)(x=n-1, y=n)$

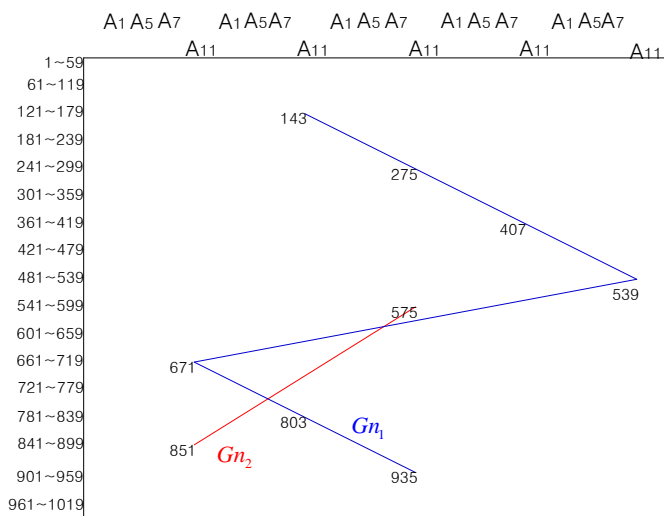



### 3.15 $(12x+5)(12y+7), (Go_n)$

×	5	17	29	41	53	65	77	89
7	35							
19	95	323						
31	155	527	899					
43	215	731	1247	1763				
55	275	935	1595	2255	2915			
67	335	1139	1943	2747	3551	4355		
79	395	1343	2291	3239	4187	5135	6083	
91	455	1547	2639	3731	4823	5915	7007	8099

- $Go_1 : 35(a_1) \quad 95(a_2) \quad 155(a_3) \quad 215(a_4) \quad 275(a_5) \quad 335(a_6) \quad 395(a_7) \quad 455(a_8)$
- $Go_2 : 323(a_1) \quad 527(a_2) \quad 731(a_3) \quad 935(a_4) \quad 1139(a_5) \quad 1343(a_6) \quad 1547(a_7)$
- $Go_3 : 899(a_1) \quad 1247(a_2) \quad 1595(a_3) \quad 1943(a_4) \quad 2291(a_5) \quad 2639(a_6)$
- $Go_4 : 1763(a_1) \quad 2255(a_2) \quad 2747(a_3) \quad 3239(a_4) \quad 3731(a_5)$
- $Go_5 : 2915(a_1) \quad 3551(a_2) \quad 4187(a_3) \quad 4823(a_4)$
- $Go_6 : 4355(a_1) \quad 5135(a_2) \quad 5915(a_3)$
- $Go_7 : 6083(a_1) \quad 7007(a_2)$
- $Go_8 : 8099(a_1)$

$Go_1 : a_1 = (12x+5)(12y+7) = 35, \quad d = 12 \times (12x+5) = 60(x=0, y=0)$   
 $Go_2 : a_1 = (12x+5)(12y+7) = 323, \quad d = 12 \times (12x+5) = 204(x=1, y=1)$   
 $Go_3 : a_1 = (12x+5)(12y+7) = 899, \quad d = 12 \times (12x+5) = 348(x=2, y=2)$   
 $Go_4 : a_1 = (12x+5)(12y+7) = 1763, \quad d = 12 \times (12x+5) = 492(x=3, y=3)$   
 $Go_5 : a_1 = (12x+5)(12y+7) = 2915, \quad d = 12 \times (12x+5) = 636(x=4, y=4)$   
 $Go_6 : a_1 = (12x+5)(12y+7) = 4355, \quad d = 12 \times (12x+5) = 780(x=5, y=5)$   
 $Go_7 : a_1 = (12x+5)(12y+7) = 6083, \quad d = 12 \times (12x+5) = 924(x=6, y=6)$   
 $Go_8 : a_1 = (12x+5)(12y+7) = 8099, \quad d = 12 \times (12x+5) = 1068(x=7, y=7)$   
 $\vdots$   
 $Go_n : a_1 = (12x+5)(12y+7) = 144xy + 84x + 60y + 35, \quad d = 12 \times (12x+5)(x=n-1, y=n-1)$

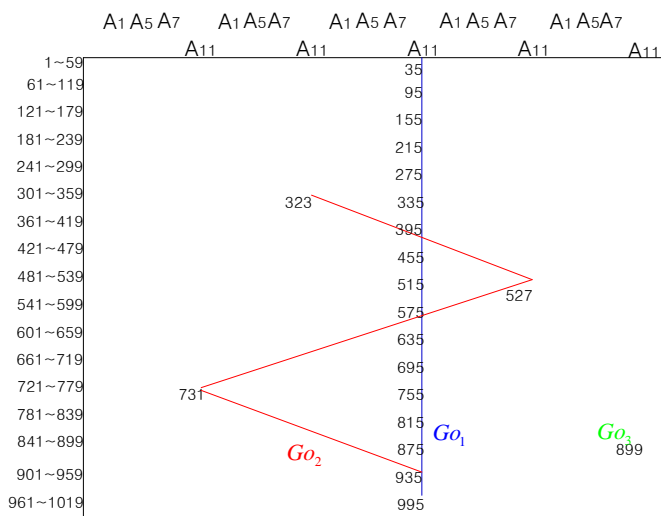

### 3.16 $(12x+7)(12y+5), (Gp_n)$

×	7	19	31	43	55	67	79	91
5	35							
17	119	323						
29	203	551	899					
41	287	779	1271	1763				
53	371	1007	1643	2279	2915			
65	455	1235	2015	2795	3575	4355		
77	539	1463	2387	3311	4235	5159	6083	
89	623	1691	2759	3827	4895	5963	7031	8099

- $Gp_1: 35(a_1) \quad 119(a_2) \quad 203(a_3) \quad 287(a_4) \quad 371(a_5) \quad 455(a_6) \quad 539(a_7) \quad 623(a_8)$
- $Gp_2: 323(a_1) \quad 551(a_2) \quad 779(a_3) \quad 1007(a_4) \quad 1235(a_5) \quad 1463(a_6) \quad 1691(a_7)$
- $Gp_3: 899(a_1) \quad 1271(a_2) \quad 1643(a_3) \quad 2015(a_4) \quad 2387(a_5) \quad 2759(a_6)$
- $Gp_4: 1763(a_1) \quad 2279(a_2) \quad 2795(a_3) \quad 3311(a_4) \quad 3827(a_5)$
- $Gp_5: 2915(a_1) \quad 3575(a_2) \quad 4235(a_3) \quad 4895(a_4)$
- $Gp_6: 4355(a_1) \quad 5159(a_2) \quad 5963(a_3)$
- $Gp_7: 6083(a_1) \quad 7031(a_2)$
- $Gp_8: 8099(a_1)$

$Gp_1: a_1 = (12x+7)(12y+5) = 35, \quad d = 12 \times (12x+7) = 84(x=0, y=0)$   
 $Gp_2: a_1 = (12x+7)(12y+5) = 323, \quad d = 12 \times (12x+7) = 228(x=1, y=1)$   
 $Gp_3: a_1 = (12x+7)(12y+5) = 899, \quad d = 12 \times (12x+7) = 372(x=2, y=2)$   
 $Gp_4: a_1 = (12x+7)(12y+5) = 1763, \quad d = 12 \times (12x+7) = 516(x=3, y=3)$   
 $Gp_5: a_1 = (12x+7)(12y+5) = 2915, \quad d = 12 \times (12x+7) = 660(x=4, y=4)$   
 $Gp_6: a_1 = (12x+7)(12y+5) = 4355, \quad d = 12 \times (12x+7) = 804(x=5, y=5)$   
 $Gp_7: a_1 = (12x+7)(12y+5) = 6083, \quad d = 12 \times (12x+7) = 948(x=6, y=6)$   
 $Gp_8: a_1 = (12x+7)(12y+5) = 8099, \quad d = 12 \times (12x+7) = 1092(x=7, y=7)$   
 $\vdots$   
 $Gp_n: a_1 = (12x+7)(12y+5) = 144xy + 60x + 84y + 35, \quad d = 12 \times (12x+7)(x=n-1, y=n-1)$

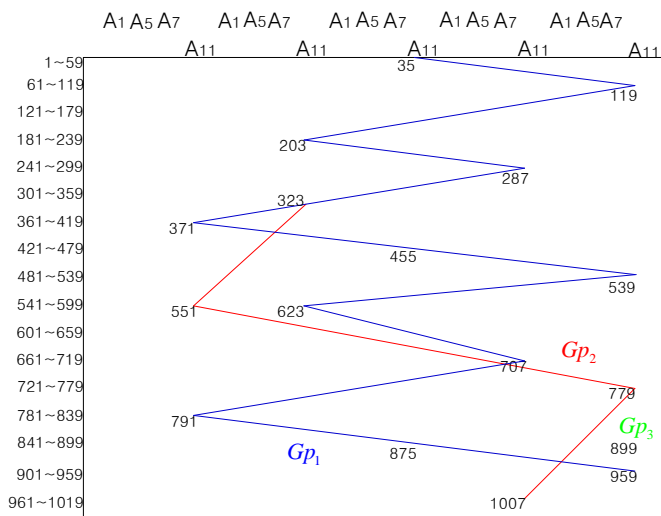

#### 4. Conclusion

This paper asserts that the composite numbers of the  $12n+1, 5, 7, 11$  series make up sixteen arithmetic progression groups. We were able to indirectly deduce the uncertainty of prime numbers through the composite numbers. It is true that, unlike the prime numbers, the composite numbers are governed by a rule that is structural and regular.]

#### Acknowledgements

I am very grateful to Professor Youn, cheong and to Lim, sang-tae for their advice and for the patience they showed, assisting me.

#### [Reference]

- [1] David M. Burton, Elementary Number Theory, McGraw Hill India; Sixth edition (September 27, 2005), pages 39-50
  - [2] G. H. Hardy, An Introduction to the Theory of Numbers, Publisher: Oxford University Press, USA; 6 edition (September 15, 2008), pages 17-21
  - [3] H. E. Rose, A Course in Number Theory, Oxford University Press, USA; 2 edition (December 14, 1995), pages 237-245
  - [4] Richard K. Guy, Unsolved Problems in Number Theory (Problem Books in Mathematics, Springer; 3rd edition (July 13, 2004), pages 3-5
  - [5] David Bressoud, A Course in Computational Number Theory (Key Curriculum Press), Wiley (June 10, 2008), pages 97-143
  - [6] G. H. Hardy, An Introduction to the Theory of Numbers, Oxford University Press, USA; 6 edition (September 15, 2008), pages 14-16
  - [7] Hans Riesel, Prime Numbers and Computer Methods for Factorization (Progress in Mathematics), Birkhauser Boston; 2nd edition (October 1, 1994), pages 6-9
  - [8] Marcus Du Sautoy, The Music of the Primes, Harper Perennial (April 27, 2004), pages 3-5
  - [9] John Derbyshire, Prime Obsession, Plume (May 25, 2004), pages 32-47
  - [10] H. Davenport, The Higher Arithmetic: An Introduction to the Theory of Numbers, Cambridge University Press; 8 edition (November 17, 2008), Page at 1-9
  - [11] Phillip J. Davis, The Mathematical Experience, Mariner Books (January 14, 1999), pages 209-214
  - [12] Tom M. Apostol, Introduction to Analytic Number Theory (Undergraduate Texts in Mathematics), Springer; 1ST edition (May 11, 1976), pages 14-16, 146-155
  - [13] Gareth A. Jones, Elementary Number Theory, Springer; Corrected edition (January 14, 1998), pages 19-35
- [Arithmetic Progression]
- [14] B. Green and T. Tao, The primes contain arbitrarily long arithmetic progressions, preprint at arXiv:math/0404188
  - [15] T. Tao, The dichotomy between structure and randomness, arithmetic progressions, and the primes, arXiv:math/0512114v2
  - [16] B. Green, Long arithmetic progressions of primes, arXiv:math/0508063

- [17] T. Tao, Obstructions to uniformity, and arithmetic patterns in the primes, arXiv:math/0505402
- [18] T. Tao, The dichotomy between structure and randomness, arithmetic progressions, and the primes, arXiv:math/0512114
- [19] T. Tao, Arithmetic progressions and the primes - El Escorial lectures, arXiv:math/0411246
- [20] T. Tao, Linear Equations in Primes, arXiv:math/0606088
- [21] T. Tao, Structure and randomness in the prime numbers, a small selection of results in number theory, Science colloquium January 17, 2007
- [22] T. Tao, What is good mathematics?, arXiv:math/0702396
- [23] E. Szemerédi, On sets of integers containing no  $k$  elements in arithmetic progression, Acta Arithmetica XXVII(1975)
- [24] B. Kra, *The Green-Tao Theorem on arithmetic progressions in the primes: an ergodic point of view*, preprint.
- [25] H. Dubner, T. Forbes, N. Lygeros, M. Mizony, H. Nelson, P. Zimmermann, Ten Consecutive primes in arithmetic progression, Math. Comp. 71 (2002), 1323-1328.
- [26] J. Pintz, Are there arbitrarily long arithmetic progressions in the sequence of twin primes?, preprint at arXiv:1002.2899
- [27] Andrei V. Vityazev, Galina V. Pechernikova, Structure of the Prime Distribution within the Sequence of Natural Numbers, preprint at arXiv:math/0609797
- [28] Paulo R. A. Campos\*, Viviane M. de Oliveira, Ronaldo Giro, and Douglas S. Galvão, Emergence of Prime Numbers as the Result of Evolutionary Strategy, Phys. Rev. Lett. 93, 098107 (2004) [4 pages]
- [29] G. Tenenbaum, M. Mendès France, The prime numbers and their distribution, American Mathematical Society (May 2000), Pages at 52-60
- [30] H. Davenport, Multiplicative Number Theory, Springer; 3rd edition (October 31, 2000), Pages 1-27
- [31] Atkin, A. O. L. and Bernstein, D. J. Prime sieves using binary quadratic forms, Math. Comp. 73 (2004), 1023-1030
- [32] R. Crandall and C. Pomerance, Prime Number (A Computational Perspective), Springer; 2nd edition (August 4, 2005), Pages at 121-156
- [33] A. E. Ingham, The distribution of prime numbers, Cambridge University Press (September 28, 1990), Page at 9-40, 86-107
- [34] J. Barkley Rosser and Lowell Schoenfeld, Approximate formulas for some functions of prime numbers, Illinois J. Math. Volume 6, Issue 1 (1962), 64-94.
- [35] Harold N. Shapiro, On Prime in arithmetic progression, Annals of Mathematics, April 26, 1949
- [36] W. Narkiewicz, The Development of Prime Number Theory, Springer; 1 edition (May 25, 2000), pages at 49-93
- [37] Atle Selberg, An Elementary Proof of Dirichlet's Theorem About Primes in an Arithmetic Progression, Annals of Mathematics 1949, pages at 297
- [38] G.H. Hardy, The General Theory Of Dirichlets Series, Book Jungle (June 8, 2009)

External links

- [39] [http://en.wikipedia.org/wiki/Primes\\_in\\_arithmetic\\_progression](http://en.wikipedia.org/wiki/Primes_in_arithmetic_progression)
- [40] [http://en.wikipedia.org/wiki/Sieve\\_of\\_Eratosthenes](http://en.wikipedia.org/wiki/Sieve_of_Eratosthenes)
- [41] [http://en.wikipedia.org/wiki/Modular\\_Arithmetic](http://en.wikipedia.org/wiki/Modular_Arithmetic)
- [42] [http://mersennewiki.org/index.php/Modular\\_arithmetic](http://mersennewiki.org/index.php/Modular_arithmetic)
- [43] <http://www.cut-the-knot.org/blue/Modulo.shtml>
- [44] <http://en.wikipedia.org/wiki/Remainder>
- [45] In this [modular art](#) article, one can learn more about applications of modular arithmetic in art.
- [46] [Modular Arithmetic and patterns in addition and multiplication tables](#)
- [47] Weisstein, Eric W., "[Modular Arithmetic](#)" from MathWorld.

<attached document 1>

5	7	11	13	17	19	23	25	29	31	35	37	41	43	47	49	53	55	59		
							25 <sub>(Gb<sub>1</sub>)</sub>			35 <sub>(Go<sub>1</sub>Gp<sub>1</sub>)</sub>					49 <sub>(Gc<sub>1</sub>)</sub>		55 <sub>(Gk<sub>1</sub>Gl<sub>1</sub>)</sub>			
5	7	11	13	17	19	23		29	31			37	41	43	47		53	59		
61	65	67	71	73	77	79	83	85	89	91	95	97	101	103	107	109	113	115	119	
	65 <sub>(Ge<sub>1</sub>Gf<sub>1</sub>)</sub>				77 <sub>(Gg<sub>1</sub>gh<sub>1</sub>)</sub>			85 <sub>(Gb<sub>1</sub>)</sub>		91 <sub>(Gi<sub>1</sub>Gj<sub>1</sub>)</sub>	95 <sub>(Go<sub>1</sub>)</sub>						115 <sub>(Gk<sub>1</sub>)</sub>	119 <sub>(Gp<sub>1</sub>)</sub>		
61		67	71	73			79	83		89					97	101	103	107	109	113
121	125	127	131	133	137	139	143	145	149	151	155	157	161	163	167	169	173	175	179	
121 <sub>(Gd<sub>1</sub>)</sub>	125 <sub>(Gf<sub>1</sub>)</sub>			133 <sub>(Gc<sub>1</sub>)</sub>			143 <sub>(Gm<sub>1</sub>Gn<sub>1</sub>)</sub>	145 <sub>(Gb<sub>1</sub>)</sub>			155 <sub>(Go<sub>1</sub>)</sub>		161 <sub>(Gg<sub>1</sub>)</sub>		169 <sub>(Gu<sub>1</sub>)</sub>		175 <sub>(Gj<sub>1</sub>Gk<sub>1</sub>)</sub>			
		127	131			137	139			149	151		157		163	167		173	179	
181	185	187	191	193	197	199	203	205	209	211	215	217	221	223	227	229	233	235	239	
	185 <sub>(Gf<sub>1</sub>)</sub>	187 <sub>(Gl<sub>1</sub>)</sub>					203 <sub>(Gp<sub>1</sub>)</sub>	205 <sub>(Gb<sub>1</sub>)</sub>	209 <sub>(Gh<sub>1</sub>)</sub>		215 <sub>(Go<sub>1</sub>)</sub>	217 <sub>(Gc<sub>1</sub>)</sub>	221 <sub>(Ge<sub>1</sub>)</sub>					235 <sub>(Gk<sub>1</sub>)</sub>		
181			191	193	197	199				211					223	227	229	233		239
241	245	247	251	253	257	259	263	265	269	271	275	277	281	283	287	289	293	295	299	
	245 <sub>(Gf<sub>1</sub>Gg<sub>1</sub>)</sub>	247 <sub>(Gi<sub>1</sub>)</sub>		253 <sub>(Gd<sub>1</sub>)</sub>		259 <sub>(Gj<sub>1</sub>)</sub>		265 <sub>(Gb<sub>1</sub>)</sub>			275 <sub>(Gn<sub>1</sub>Go<sub>1</sub>)</sub>				287 <sub>(Gp<sub>1</sub>)</sub>	289 <sub>(Gb<sub>2</sub>)</sub>		295 <sub>(Gk<sub>1</sub>)</sub>	299 <sub>(Gm<sub>1</sub>)</sub>	
241			251		257		263		269	271			277	281	283			293		
301	305	307	311	313	317	319	323	325	329	331	335	337	341	343	347	349	353	355	359	
301 <sub>(Gc<sub>1</sub>)</sub>	305 <sub>(Gf<sub>1</sub>)</sub>						319 <sub>(Gl<sub>1</sub>)</sub>	323 <sub>(Go<sub>2</sub>Gp<sub>2</sub>)</sub>	325 <sub>(Gd<sub>1</sub>Gh<sub>1</sub>)</sub>	329 <sub>(Gg<sub>1</sub>)</sub>		335 <sub>(Go<sub>1</sub>)</sub>		341 <sub>(Gh<sub>1</sub>)</sub>	343 <sub>(Gj<sub>1</sub>)</sub>			355 <sub>(Gk<sub>1</sub>)</sub>		
		307	311	313	317					331		337				347	349	353		359
361	365	367	371	373	377	379	383	385	389	391	395	397	401	403	407	409	413	415	419	
361 <sub>(Gc<sub>2</sub>)</sub>	365 <sub>(Gf<sub>1</sub>)</sub>		371 <sub>(Gp<sub>1</sub>)</sub>		377 <sub>(Ge<sub>1</sub>)</sub>			385 <sub>(Gh<sub>1</sub>Gc<sub>1</sub>Gd<sub>1</sub>)</sub>		391 <sub>(Gk<sub>2</sub>Gl<sub>2</sub>)</sub>	395 <sub>(Go<sub>1</sub>)</sub>			403 <sub>(Gi<sub>1</sub>)</sub>	407 <sub>(Gn<sub>1</sub>)</sub>		413 <sub>(Gg<sub>1</sub>)</sub>	415 <sub>(Gk<sub>1</sub>)</sub>		
		367		373		379	383		389				397	401		409			419	

421	425	427	431	433	437	439	443	445	449	451	455	457	461	463	467	469	473	475	479
	425 <sub>(Gf,Ge,Gf2)</sub>	427 <sub>(Gf1)</sub>			437 <sub>(Gg2,Gh2)</sub>			445 <sub>(Gh1)</sub>		451 <sub>(Gi1)</sub>	455 <sub>(Gm,Go,Gp1)</sub>					469 <sub>(Gc1)</sub>	473 <sub>(Gh1)</sub>	475 <sub>(Gk,Gi,Gj2)</sub>	
421			431	433			439	443		449			457	461	463	467			479
481	485	487	491	493	497	499	503	505	509	511	515	517	521	523	527	529	533	535	539
481 <sub>(Ga1)</sub>	485 <sub>(Gf1)</sub>			493 <sub>(Gh2)</sub>	497 <sub>(Gg1)</sub>			505 <sub>(Gh1)</sub>		511 <sub>(Gj1)</sub>	515 <sub>(Go1)</sub>	517 <sub>(Gd1)</sub>			527 <sub>(Go2)</sub>	529 <sub>(Gd2)</sub>	533 <sub>(Ge1)</sub>	535 <sub>(Gk1)</sub>	539 <sub>(Gn,Gp1)</sub>
		487	491				499	503		509			521	523					
541	545	547	551	553	557	559	563	565	569	571	575	577	581	583	587	589	593	595	599
	545 <sub>(Gf1)</sub>		551 <sub>(Gp2)</sub>	553 <sub>(Gc1)</sub>		559 <sub>(Gi1)</sub>		565 <sub>(Gh1)</sub>			575 <sub>(Gm2,Gn2,Go1)</sub>		581 <sub>(Gg1)</sub>	583 <sub>(Gj1)</sub>		589 <sub>(Gc2)</sub>		595 <sub>(Gj,Gk,Gl2)</sub>	
541		547			557		563		569	571		577			587		593		599
601	605	607	611	613	617	619	623	625	629	631	635	637	641	643	647	649	653	655	659
	605 <sub>(Gf,Gh1)</sub>		611 <sub>(Gm1)</sub>				623 <sub>(Gp1)</sub>	625 <sub>(Ga2,Gb1)</sub>	629 <sub>(Gf2)</sub>		635 <sub>(Go1)</sub>	637 <sub>(Ga,Gc1)</sub>				649 <sub>(Gd1)</sub>		655 <sub>(Gk1)</sub>	
601		607		613	617	619				631			641	643	647		653		659
661	665	667	671	673	677	679	683	685	689	691	695	697	701	703	707	709	713	715	719
	665 <sub>(Gf,Gg,Gg2)</sub>	667 <sub>(Gl2)</sub>	671 <sub>(Gn1)</sub>			679 <sub>(Gj1)</sub>		685 <sub>(Gh1)</sub>	689 <sub>(Ge1)</sub>		695 <sub>(Ga1)</sub>	697 <sub>(Gh2)</sub>		703 <sub>(Gj2)</sub>	707 <sub>(Gp1)</sub>		713 <sub>(Gh2)</sub>	715 <sub>(Gi,Gk,Gl1)</sub>	
661				673	677		683			691			701			709			719
721	725	727	731	733	737	739	743	745	749	751	755	757	761	763	767	769	773	775	779
721 <sub>(Gc1)</sub>	725 <sub>(Gf,Ge2)</sub>		731 <sub>(Go2)</sub>		737 <sub>(Gh1)</sub>			745 <sub>(Gh1)</sub>	749 <sub>(Gg1)</sub>		755 <sub>(Go1)</sub>			763 <sub>(Gj1)</sub>	767 <sub>(Gm1)</sub>			775 <sub>(Gi2,Gk1)</sub>	779 <sub>(Gp2)</sub>
		727		733		739	743			751		757	761			769	773		
781	785	787	791	793	797	799	803	805	809	811	815	817	821	823	827	829	833	835	839
781 <sub>(Gd1)</sub>	785 <sub>(Gf1)</sub>		791 <sub>(Gp1)</sub>	793 <sub>(Ga1)</sub>		799 <sub>(Gk2)</sub>	803 <sub>(Gn1)</sub>	805 <sub>(Gh,Gc,Gd2)</sub>			815 <sub>(Go1)</sub>	817 <sub>(Gc2)</sub>					833 <sub>(Gg,Gf2)</sub>	835 <sub>(Gk1)</sub>	
		787			797				809	811			821	823	827	829			839
841	845	847	851	853	857	859	863	865	869	871	875	877	881	883	887	889	893	895	899
841 <sub>Gh3</sub>	845 <sub>(Ge,Gf1)</sub>	847 <sub>(Gj,Gl1)</sub>	851 <sub>(Gn2)</sub>					865 <sub>(Gh1)</sub>	869 <sub>(Gh1)</sub>	871 <sub>(Gi1)</sub>	875 <sub>(Go,Gp,Gm2)</sub>					889 <sub>(Gc1)</sub>	893 <sub>(Gg2)</sub>	895 <sub>(Gk1)</sub>	899 <sub>(Go,Gp2)</sub>
				853	857	859	863					877	881	883	887				
901	905	907	911	913	917	919	923	925	929	931	935	937	941	943	947	949	953	955	959
901 <sub>(Gh2)</sub>	905 <sub>(Gf1)</sub>			913 <sub>(Gd1)</sub>	917 <sub>(Gg1)</sub>		923 <sub>(Gm1)</sub>	925 <sub>(Gh,Ga2)</sub>		931 <sub>(Gj,Gj2)</sub>	935 <sub>(Gn,Go,Go2)</sub>			943 <sub>(Gl2)</sub>		949 <sub>(Ga1)</sub>		955 <sub>(Gk1)</sub>	959 <sub>(Gp1)</sub>
		907	911			919				929			937	941		947		953	
961	965	967	971	973	977	979	983	985	989	991	995	997							
961 <sub>Gc3</sub>	965 <sub>(Gf1)</sub>			973 <sub>(Gc1)</sub>		979 <sub>(Gl1)</sub>		985 <sub>(Gh1)</sub>	989 <sub>(Gh2)</sub>		995 <sub>(Go1)</sub>								
		967	971		977		983			991		997							

Figure ) If you knew the composite numbers less than 1000, you can filter out the prime numbers.