

Author name

Giuliano Bettini

Title

Clifford Algebra and Dirac equation for TE, TM in waveguide.

Abstract

Following Hestenes and others we explore the possibility that the electron is a (sort of) bound electromagnetic wave.

To do this a waveguide analogy is considered. The E, H field components in waveguide satisfy the second order Klein Gordon equation. The question is if a (first order) Dirac equation is involved.

Making use of Clifford Algebra, by first it is shown that a spinor ψ satisfying Dirac equation describes, through the relativistic energy impulse four vector, the energy propagation of the electromagnetic field into a waveguide and in free space. At the same time ψ automatically describes TE and TM modes (TEM in free space), each with Right or Left polarization.

It is shown that this description with Dirac equation has been implicit in the waveguide theory all the time. The equivalence is embedded in the usual V and I mode description [1].

The Dirac equation for TE, TM modes opens new interesting interpretations. For example the effect on ψ of a gauge transformation with the electromagnetic gauge group generator ($i\sigma_3$ in the Hestenes notation [2]) is readily interpreted as a modification of the TE, TM group velocity. This acts as the electromagnetic force on a charge, and requires two opposite sign of (fictitious) charges for TE or TM.

Obviously this suggest an analogy with electron, positron and possibly neutrino for the TEM.

[1] S. Ramo, J. R. Whinnery, T. van Duzer, "Fields and Waves in Communication Electronics", John Wiley (1994)

[2] D. Hestenes, "Space-time structure of weak and electromagnetic interactions", Found. Phys. 12, 153-168 (1982)

Clifford Algebra and Dirac equation for TE, TM in waveguide.

Introduction

Following Hestenes and others we explore the possibility that the electron is a (sort of) bound electromagnetic wave.

To do this a waveguide analogy is considered. The E, H field components in waveguide, taking into account only the dependence from propagation coordinate, obey to a second order equation which mathematically speaking is the Klein Gordon equation, as for a relativistic particle.

Since this is a relativistic equation of 2nd order one wonders if there are, and what are the corresponding relativistic equations of 1st order.

In the electromagnetic theory or in the theory of waveguides such kind of equations for TE, TM modes do not exist. We have Maxwell equations of course, but they give the second order wave equation and not the Klein Gordon equation.

In analogy with the electron we suppose that such equations are the Dirac equations. This is, in fact, true.

To show this, Clifford Algebra is employed.

(Note: useful references (electromagnetism, Clifford Algebra etc.) are in [1]..... [7], and in [8].....[14] for electron models, Dirac equation and so on).

It is also shown that this description with Dirac equation has been implicit in the waveguide theory all the time. The equivalence is embedded in the usual (see for example [7]) V and I mode description.

A Dirac spinor ψ describes TE, TM modes in such a way that only global characteristics are accounted, I mean energy, impulse and polarization.

Practically the action of ψ is to give the relativistic energy impulse four vector of the mode (the total energy-momentum vector), and also polarization.

The ψ solutions for TE, TM (and TEM) modes corresponds to the electron, positron (and neutrino) plane wave solutions of the Dirac equations.

But obviously the Dirac equation for TE, TM modes opens new interesting interpretations. For example the effect on ψ of a gauge transformation with the electromagnetic gauge group generator ($i\sigma_3$ in the Hestenes notation [12]) is readily interpreted as a modification of the TE, TM group velocity. This acts as the electromagnetic force on a charge, and requires two opposite sign of (fictitious) charges for TE or TM.

Maxwell equations with Clifford Algebra

Maxwell equations are obtained introducing the Clifford number (see A4) or “even number”:

$$(1) \quad F = (E_t + jE_l) + Tji(H_t + jH_l)$$

(in MKSA units $\sqrt{\epsilon}E$ e $\sqrt{\mu}H$).

The analyticity condition:

$$(2) \quad \partial^* F = 0$$

$$(3) \quad \partial^* = \frac{\partial}{\partial x} + i \frac{\partial}{\partial y} + j \frac{\partial}{\partial z} + T \frac{\partial}{\partial \tau}$$

provides:

$$\left(\frac{\partial}{\partial x} - i \frac{\partial}{\partial y} \right) iH_l + \frac{\partial}{\partial z} iH_l + \frac{\partial}{\partial \tau} E_t = 0$$

$$\left(\frac{\partial}{\partial x} + i \frac{\partial}{\partial y} \right) iH_l - \frac{\partial}{\partial z} iH_l + \frac{\partial}{\partial \tau} E_t = 0$$

(4)

$$\left(\frac{\partial}{\partial x} - i \frac{\partial}{\partial y} \right) E_t + \frac{\partial}{\partial z} E_t + \frac{\partial}{\partial \tau} iH_t = 0$$

$$\left(\frac{\partial}{\partial x} + i \frac{\partial}{\partial y} \right) E_t - \frac{\partial}{\partial z} E_t + \frac{\partial}{\partial \tau} iH_t = 0$$

where:

$$E_t = E_x + iE_y$$

$$E_l = E_z + iE_\tau$$

(5)

$$H_t = H_x + iH_y$$

$$H_l = H_z + iH_\tau$$

Equations (4) coincide with the Maxwell equations for F^* (basically changing the sign for y,z components of F).

Note that this corresponds to the usual property of the plane analytic functions: the analyticity condition $\partial^* f = 0$ means the field equations for a field having the conjugate components f^* .

From a different point of view the analyticity for F means also the analyticity of $F\hat{i}$, who has the physical components of \vec{E} , \vec{H} . We have:

$$(6) \quad \partial^* F\hat{i} = 0$$

where:

$$(7) \quad F\hat{i} = E_x \hat{i} + E_y \hat{j} + E_z \hat{k} + Tji(H_x \hat{i} + H_y \hat{j} + H_z \hat{k}) \rightarrow F\hat{i} = \vec{E} + Tji\vec{H}$$

so that in (7) y e z components are not the same as (5), but the same with change of sign.

In (7) I also posed $E_r = 0$ e $H_r = 0$ in order to have Maxwell equations in empty space. (Note: really \vec{E}, \vec{H} are "time-like bivectors" (Hestenes, [3]), so we should consider $F\hat{i}\hat{T}$, not $F\hat{i}$, but for the present scope (7) is enough).

Is immediate and very smart from (7) to derive the Maxwell's equations with div and rot. See Appendix 11.

From the even number F we may form several "squares" for example, from $F = E + TjiH$:

$$(8) \quad FF^* = (EE^* - HH^*) + Tji(EH^* + HE^*) = \left(|\vec{E}|^2 - |\vec{H}|^2 \right) + 2Tji\vec{E} \cdot \vec{H}$$

or:

$$(9) \quad \frac{1}{2} FF^* = L + Tji\vec{E} \cdot \vec{H}$$

invariant under Lorentz transformations and "Lagrangian density" of the electromagnetic field.

Another interesting “square” is:

$$(10) \quad \frac{1}{2} F \hat{T} F^* = \frac{1}{2} (E E^* + H H^*) \hat{T} + \frac{1}{2} T_{ji} (-E H^* + H E^*) \hat{T}$$

which further develops:

$$(11) \quad \frac{1}{2} F \hat{T} F^* = \frac{1}{2} (|\vec{E}|^2 + |\vec{H}|^2) \hat{T} - \vec{E} \times \vec{H}$$

This is the fourth row of the energy momentum tensor and provides energy momentum density.

Dirac equation with Clifford algebra

The Dirac equation is obtained by introducing an 8-component "even number" structured exactly as (1), unless the different notations for the components. Let:

$$(12) \quad \psi = \psi_1 + j\psi_2 + Tj\psi_3 + T\psi_4$$

where $\psi_1\psi_2\psi_3\psi_4$ are number with indexes $1, i$. The Dirac equation is:

$$(13) \quad \partial^* \psi = -im\psi \hat{T}$$

or indifferently:

$$(14) \quad \partial_\nu \psi = -m\psi \hat{T}$$

$$(15) \quad \partial_\nu = \hat{i}\partial^* = \frac{\partial}{\partial x} \hat{i} + \frac{\partial}{\partial y} \hat{j} + \frac{\partial}{\partial z} \hat{k} + \frac{\partial}{\partial \tau} \hat{T}$$

Developing and equating the components we obtain the Dirac equation in extended form:

$$(16) \quad \begin{aligned} & \left(\frac{\partial}{\partial x} - i \frac{\partial}{\partial y} \right) \psi_4 + \frac{\partial}{\partial z} \psi_3 + \left(\frac{\partial}{\partial \tau} + im \right) \psi_1 = 0 \\ & \left(\frac{\partial}{\partial x} + i \frac{\partial}{\partial y} \right) \psi_3 - \frac{\partial}{\partial z} \psi_4 + \left(\frac{\partial}{\partial \tau} + im \right) \psi_2 = 0 \\ & \left(\frac{\partial}{\partial x} - i \frac{\partial}{\partial y} \right) \psi_2 + \frac{\partial}{\partial z} \psi_1 + \left(\frac{\partial}{\partial \tau} - im \right) \psi_3 = 0 \\ & \left(\frac{\partial}{\partial x} + i \frac{\partial}{\partial y} \right) \psi_1 - \frac{\partial}{\partial z} \psi_2 + \left(\frac{\partial}{\partial \tau} - im \right) \psi_4 = 0 \end{aligned}$$

A comparison with (4) putting $m=0$, neutrino equations

$$\left(\frac{\partial}{\partial x} - i\frac{\partial}{\partial y}\right)\psi_4 + \frac{\partial}{\partial z}\psi_3 + \frac{\partial}{\partial \tau}\psi_1 = 0$$

$$\left(\frac{\partial}{\partial x} + i\frac{\partial}{\partial y}\right)\psi_3 - \frac{\partial}{\partial z}\psi_4 + \frac{\partial}{\partial \tau}\psi_2 = 0$$

(16bis)

$$\left(\frac{\partial}{\partial x} - i\frac{\partial}{\partial y}\right)\psi_2 + \frac{\partial}{\partial z}\psi_1 + \frac{\partial}{\partial \tau}\psi_3 = 0$$

$$\left(\frac{\partial}{\partial x} + i\frac{\partial}{\partial y}\right)\psi_1 - \frac{\partial}{\partial z}\psi_2 + \frac{\partial}{\partial \tau}\psi_4 = 0$$

provides the formal identification:

$$E_t = \psi_1$$

$$E_l = \psi_2$$

(17)

$$iH_t = \psi_3$$

$$iH_l = \psi_4$$

$$(18) \quad \begin{bmatrix} \psi_1 \\ \psi_2 \\ \psi_3 \\ \psi_4 \end{bmatrix} = \begin{bmatrix} E_x + iE_y \\ E_z + iE_\tau \\ i(H_x + iH_y) \\ i(H_z + iH_\tau) \end{bmatrix}$$

From the even number ψ may form several "squares" for example the modulus:

$$(19) \quad \psi\psi^*$$

or the four velocity \hat{u} (see.A3)

$$(20) \quad \psi\hat{\Gamma}\psi^* = \hat{u} \quad \hat{u}^2 = -1$$

true if ψ is unitary, i.e. if ψ is a "rotor":

$$(21) \quad \psi = R \quad \rightarrow \quad RR^* = 1$$

Conditions of relativistic invariance for 13), i.e. invariance with respect to spacetime rotations of an angle φ , make that ψ transforms with half angle $\varphi/2$. This implies (the fact is a consequence of the other and vice versa) all quantities like $\psi \hat{T} \psi^*$ transform like vectors (see.A6). Particularly if ψ is the unitary the quantities:

$$\begin{aligned}
 \psi \hat{i} \psi^* &= \hat{e}_1 \\
 \psi \hat{j} \psi^* &= \hat{e}_2 \\
 \psi \hat{k} \psi^* &= \hat{e}_3 \\
 \psi \hat{T} \psi^* &= \hat{e}_0 = \hat{u}
 \end{aligned}
 \tag{22}$$

form a set of axes rotated with respect to $\hat{i}, \hat{j}, \hat{k}, \hat{T}$.

This establishes a relationship with the relativistic kinematics of a small rigid body (Hestenes).

If ψ is a function of time such including a term:

$$e^{\hat{i}\hat{j}\alpha} = e^{i\alpha}$$

(rotation according the bivector $\hat{i}\hat{j}$) then (22) determine position and movement of an axis system e_μ rotating with respect to fixed axis $\hat{i} \hat{j} \hat{k} \hat{T}$, where $\psi \hat{T} \psi^* = \hat{e}_0 = \hat{u}$ is the four velocity and $\psi \hat{k} \psi^* = \hat{e}_3 = \hat{s}$ is the spin.

The energy – momentum four vector

The mathematical physical keystone of the whole affair is as follows. An object that has mass has a momentum in the language of relativity (tensors, four-vectors, etc.) which holds:

$$(23) \quad p_i = mu_i$$

where m is the rest mass and u_i the four velocity. m is a scalar and u_i, p_i transform like four vectors.

In simple with this description the object is treated as a whole, its internal structure is ignored, and is described by the energy momentum p_i . a four-vector.

Even a radar pulse or a wave packet that propagates into a waveguide is in its way an object that propagates with momentum and energy as a whole. Therefore we can propose to represent it as an object which its external characteristics, ignoring the internal structure and complexity, describing it as a whole with a four vector.

Now $\frac{1}{2}F\hat{T}F^*$ is or would be strong candidate to represent this, except that is not a four-vector but is a line of energy momentum density tensor, i.e. does not change how (and is not) a four-vector.

Of course $F\hat{T}F^*e \psi\hat{T}\psi^*$ are noticeably similar both in form and substance and if ψ is a spinor $\psi\hat{T}\psi^*$ transforms like a four vector (see A6).

Therefore a quantity structured as $\psi\hat{T}\psi^*$ is a good candidate to represent the total momentum and energy of the electromagnetic field considered as a whole, ignoring its internal structure.

$\frac{1}{2}F\hat{T}F$ does the same thing but giving an internal description point by point, what we are assuming foreclosed.

Note however that the volume integral of $\frac{1}{2}F\hat{T}F^*$ gives the total energy momentum of the field, and they form a four vector (Wolfgang Pauli, [5]).

V and I in waveguide

In the theory of waveguides is introduced with a certain degree of arbitrariness which remains available, a set of quantities V and I, voltage and current, although precisely (Franceschetti) "in the "not TEM" modes is no longer immediate the identification of V and I".

We pose with regard to transverse fields:

$$(24) \quad \begin{aligned} \vec{E}_t(x, y, z) &= V(z)\vec{e}(x, y) \\ \vec{H}_t(x, y, z) &= I(z)\vec{h}(x, y) \end{aligned}$$

with the condition:

$$(25) \quad P = \frac{1}{2} \operatorname{Re} \int_s \vec{E}_t \times \vec{H}_t \cdot \hat{n} dS = \frac{1}{2} \operatorname{Re}(VI^*)$$

(Note: unfortunately I have not in this moment the references of the beautiful book of Franceschetti).

The physical meaning of (24) is that in V and I deliberately ignores the detailed features in the transverse plane, putting it equal to constant.

The meaning of (25) is that it requires however that the magnitudes V and I correctly reproduce the value of the total energy that propagates.

Place

$$(26) \quad \frac{V}{I} = Z$$

However, there is a degree of arbitrariness in V and I. We can alter V and I and simultaneously \vec{e}, \vec{h} as follows:

$$(27) \quad \begin{aligned} V' &= \alpha V, \vec{e}' = \frac{1}{\alpha} \vec{e} \\ I' &= \frac{1}{\alpha} I, \vec{h}' = \alpha \vec{h} \end{aligned}$$

maintaining condition:

$$(28) \quad P = \frac{1}{2} \operatorname{Re}(VI^*) = \frac{1}{2} \operatorname{Re}(V'I'^*)$$

With the new values is

$$(29) \quad Z' = \frac{V'}{I'} = \alpha^2 \frac{V}{I} = \alpha^2 Z$$

The new choice does not affect both the value of the transverse fields and the value of the energy that propagates, which have a physical meaning independent of any breakdown.

Different choices would depend on the definition, arbitrary, of the impedance V/I .

Comparison of equations for V and the Dirac equation

We can now to compare the equations of V and I with the equations between two individual components of the Dirac ψ .

For example, the equations for a TE, with the sign convention IEEE $e^{+i\omega t}$, are:

$$(30) \quad \frac{dV}{dz} = -i\omega\mu I$$

$$\frac{dI}{dz} = -i\omega\epsilon \left(1 - \frac{\omega_0^2}{\omega^2}\right) V$$

We look for a plane wave solution of Dirac equation with the dependence $e^{+i\omega t}$ and for propagation along z. We also seek the solution in the form $\psi_2, \psi_4 = 0$ and with only ψ_3 and ψ_1 different from zero. Equations (16) provide (assuming $c = 1$ and $\omega_0 = m$):

$$(31) \quad \frac{\partial \psi_3}{\partial z} + (i\omega + i\omega_0)\psi_1 = 0$$

$$\frac{\partial \psi_1}{\partial z} + (i\omega - i\omega_0)\psi_3 = 0$$

We try a solution in the form:

$$(32) \quad \psi_3 = Ae^{i\omega t - ik_z z}$$

$$\psi_1 = Be^{i\omega t - ik_z z}$$

Substituting in (31) yields:

$$(33) \quad -ik_z A + (i\omega + i\omega_0)B = 0$$

$$-ik_z B + (i\omega - i\omega_0)A = 0$$

which with a little steps is necessary:

$$(34) \quad k_z^2 = \omega^2 - \omega_0^2$$

and finally (A arbitrary, A = 1):

$$\psi_3 = e^{i\omega t - ik_z z}$$

(35)

$$\psi_1 = \frac{k_z}{\omega + \omega_0} e^{i\omega t - ik_z z}$$

This is in quantum mechanics the classical solution for the positron (positron = $e^{+i\omega t}$ with the sign convention of quantum mechanics).

The solutions of V and I (30) for the TE mode do not appear these, but it is easy to show that in fact these are, the apparent diversity only depends on an arbitrary definition of voltage and current and impedance according to (27) (29).

For those familiar with the transmission lines can help a digression of Electrical Engineering, who does not wish he could jump directly to (41).

Equations (30) can be thought of as those of the propagation in a dispersive line with cut off ω_0 .

The equations of the line are:

$$\frac{dV}{dz} = -ZI$$

(36)

$$\frac{dI}{dz} = -YV$$

where Z and Y depend on the line and $\sqrt{Z/Y}$ is the characteristic impedance of the line. With (30) thus assumes implicitly

$$Z = \omega\mu$$

(37)

$$Y = \omega\epsilon \left(1 - \frac{\omega_0^2}{\omega^2} \right)$$

and the characteristic impedance:

$$(38) \quad \sqrt{Z/Y} = \sqrt{\frac{\mu/\epsilon}{1 - \frac{\omega_0^2}{\omega^2}}}$$

is equal to the mode impedance Z_{TE} ("choice of Schelkunoff"):

$$(39) \quad \frac{Z_0}{\sqrt{1 - \frac{\omega_0^2}{\omega^2}}} = Z_{TE}$$

The line has equivalent Z and Y this way:

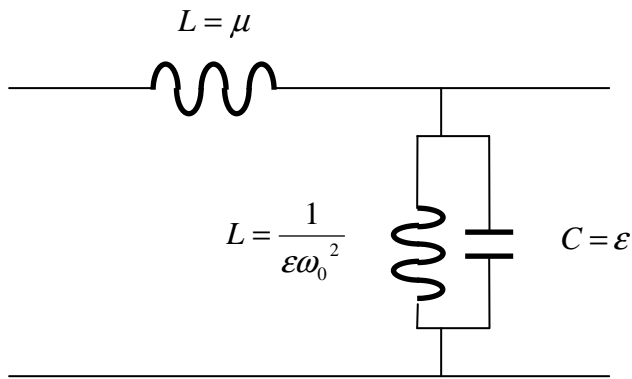

The line is dispersive because the characteristic impedance (38) is not constant but depends on the frequency. The line resonates to:

$$(40) \quad \omega = \frac{1}{\sqrt{LC}} = \omega_0$$

Now put in (27):

$$(41) \quad \alpha = \frac{\sqrt{\omega + \omega_0}}{\sqrt{\omega}}$$

Substituting into (30) we have:

$$(42) \quad \begin{aligned} \frac{dV'}{dz} + (i\omega + i\omega_0)\mu I' &= 0 \\ \frac{dI'}{dz} + (i\omega - i\omega_0)\epsilon V' &= 0 \end{aligned}$$

And the new Z goes for (29)

$$(43) \quad Z' = \frac{V'}{I'} = \frac{\omega + \omega_0}{\omega} Z_{TE}$$

So equations for voltage and current are actually the Dirac equation for ψ_3 and ψ_1 .
Note: correctly equation holds for $\sqrt{\mu}I'$ and $\sqrt{\epsilon}V'$, being ψ_3 and ψ_1 without dimension..

Not yet shown that V and I can form a complete 8 components spinor ψ , or a 4 complex components $\psi_1\psi_2\psi_3\psi_4$ spinor, but it is easily feasible and is done in the Appendix. We anticipate some conclusions.

Begin to consider the solution for the positron at rest than for (35) is $\psi_3 = e^{+i\alpha t}, \psi_1 = 0$. For the line, this means that there is voltage V and no current I, but with reference to the original meaning of V and I in (24) we can also say that there is no transverse magnetic field and there is transverse electric field.

In these conditions, the quantities V and I or transverse electric field and transverse magnetic field describe what you can say an equivalent plane wave, not propagating, being zero the Poynting vector (* see note).

We can give an electrical interpretation of ψ explicitly linking to it an electric field vector $\vec{E}_t = \psi \hat{i} = e^{i\alpha t} \hat{i}$, "fictitious" as defined by the same degree of arbitrariness with which V was defined.

The electric field rotates on the transverse plane with $e^{+i\alpha t}$.

But now $e^{+i\alpha t}$ takes on real meaning of physical rotation and informs us that the transverse electric field is rotating in a precise sense.

In this case, then what was the original solution of the line with "complex V" is enriched by an information of polarization. Now the Dirac equation has 2 distinct solutions for the positron at rest, solutions which are with opposite spin:

-only $\psi_3 \neq 0$

-only $\psi_4 \neq 0$

and these corresponds to a TE right and a TE left.

If you repeat the discussion done here with that of the line equivalent to the TM modes, one find a solution at rest with only transverse rotating magnetic field. In conclusion we find that the Dirac equation has 4 distinct solutions at rest:

-only $\psi_1 \neq 0$

-only $\psi_2 \neq 0$

-only $\psi_3 \neq 0$

-only $\psi_4 \neq 0$

and these provide TE and TM in opposite polarizations (fig. 1):

(fig. 1)

TE in opposite polarizations

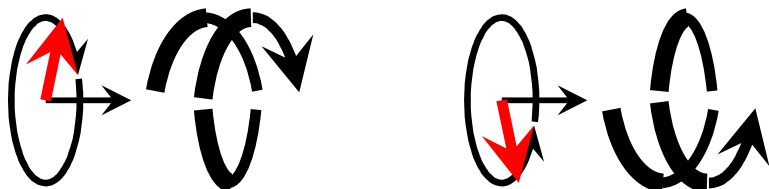

TM in opposite polarizations

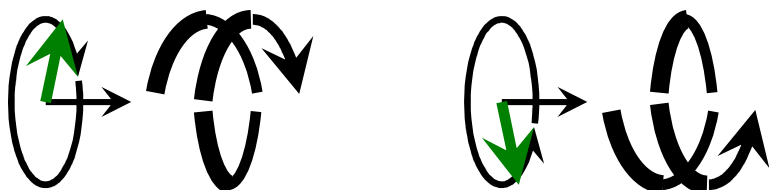

The description of the electromagnetic field with a spinor ψ so not only is shown to be equivalent to the description with complex V and I, but is enriched with a precise physical meaning due to Clifford algebra.

In essence, the conventional writing V and I with exponential ($e^{+i\omega t}$ for example, with the conventions of IEEE) becomes in itself a representation of a rotating physical thing or physical field.

V (Volt) becomes (Volt/meter) and I (Ampere) becomes (Ampere/meter) and the equivalent line becomes an equivalent medium in which an equivalent plane wave propagates, but traveling in a dispersive medium.

If we consider this spinor generalization is only a “small” variation from the Schroedinger point of view, but the variant takes account of polarization, and is relativistic(not for nothing are the Dirac equation)

* Note: while at rest the correspondence $V \rightarrow \vec{E}_t \rightarrow TE$ is physically reasonable, the correspondence $TE \leftrightarrow \text{positron} \leftrightarrow (\psi_3 \neq 0)$ is ambiguous because it depends on the conventions on exponential that are (.....of course) opposed.

For IEEE positive frequencies are $e^{+i\omega t}$ while in quantum mechanics positive energies (frequencies) are $e^{-i\omega t}$. If the mathematics of the positron become the mathematics of the electron the TE-at rest would be represented by $(\psi_1 \neq 0)$, more like pleasantly the formal identification (18).

Radar polarization

Notations of radar polarization propose, for example, a write of the electric field with the Jones vector:

$$(44) \quad \vec{E} = \text{Re} \left\{ \begin{bmatrix} \cos \Phi & -\sin \Phi \\ \sin \Phi & \cos \Phi \end{bmatrix} \begin{bmatrix} \cos \tau \\ i \sin \tau \end{bmatrix} e^{i\alpha} \right\}$$

i.e. (note by the usual convention $e^{+i\alpha}$ of the IEEE):

$$(45) \quad \vec{E} = \text{Re} \left[(\cos \Phi \cos \tau - i \sin \Phi \sin \tau) e^{i\alpha} \right] \hat{a}_x + \text{Re} \left[(\sin \Phi \cos \tau + i \cos \Phi \sin \tau) e^{i\alpha} \right] \hat{a}_y$$

from which the ellipse of polarization depicted in Figure 2.

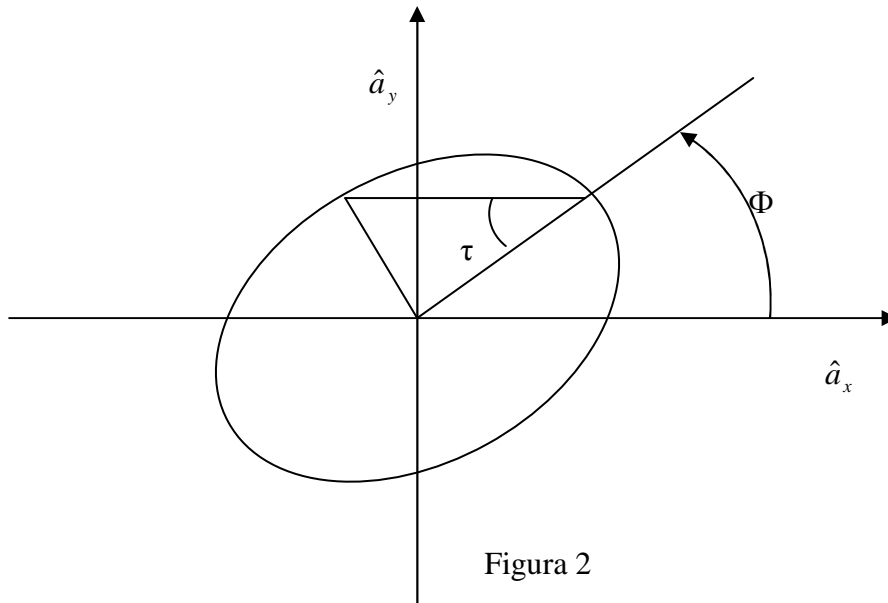

We will show that the polarization is represented in Clifford algebra with the number (4 components "Clifford number" $1, i, j, ij$)

$$(46) \quad \psi = e^{-i\Phi} e^{-j\tau} e^{\frac{j\pi}{4}} e^{-i\alpha}$$

A similar notation appears in the texts on the radar polarization, with the Pauli matrices with exponent, but ... difference is that here (46) is a spinor solution of Dirac equation at rest, then be able to completely describe the four-vector of the electromagnetic field in all conditions of motion.

More if you calculate the rotated position of the unit vector \hat{k} i.e. following Hestenes the unit spin vector $\hat{e}_3 = \hat{\psi} \hat{k} \psi^*$, we see that \hat{e}_3 has a position in space in a way that reproduces the Poincaré sphere.

The demonstrations were quickly made.

The fact that (46) is a spinor solution of Dirac equation at rest (16) is shown in the following paragraphs and in any case is directly verified by substitution.

To associate an electric field, for reasons that will be justified later, use the following rule. First separates ψ in "spin up" and "spin down" components:

$$(47) \quad \psi = \psi_+ + \psi_-$$

where:

$$(48) \quad \begin{aligned} \psi_+ &= \frac{1}{2}(\psi - i\psi i) \\ \psi_- &= \frac{1}{2}(\psi + i\psi i) \end{aligned}$$

(This of course introduces a further resemblance between (46) and a wave function, all to appreciate and interpret. From a purely mathematical point of view, the (48) separating the components, respectively, with commute and anticommute with i). Next associate with ψ an electric field (or in general electromagnetic) with:

$$(49) \quad \vec{E} = \psi_+ \hat{i} + \psi_- (-j) \hat{i} \qquad (49bis) \quad \vec{E} + Tj i \vec{H} = \psi_+ \hat{i} + \psi_- (-j) \hat{i}$$

And now verify that (46) and provides a full expression of the polarization. If you in fact develop further (45) yields:

$$(51) \quad \vec{E} = (\cos \Phi \cos \tau \cos \omega t + \sin \Phi \sin \tau \sin \omega t) \hat{a}_x + (\sin \Phi \cos \tau \cos \omega t - \cos \Phi \sin \tau \sin \omega t) \hat{a}_y,$$

whereas if it develops (46) with (49) is obtained after several passages

$$(52) \quad \vec{E} = \sqrt{2}(\cos \Phi \cos \tau \cos \omega t + \sin \Phi \sin \tau \sin \omega t) \hat{j} + \sqrt{2}(\sin \Phi \cos \tau \cos \omega t - \cos \Phi \sin \tau \sin \omega t) \hat{j}$$

i.e. the same as (51) (except for a $\sqrt{2}$ different normalization).

Clearly we've reproduced the physics of the elliptical motion so we have reproduced the ellipse and the conventions of figure 2.

Same spinor ψ carries a position of \hat{e}_3 in physical space x, y, z.

And in fact:

$$(53) \quad \hat{e}_3 = \psi \hat{k} \psi^*$$

with some step from which we obtain:

$$(54) \quad \hat{e}_3 = \psi \hat{k} \psi^* = (\cos 2\Phi \cos 2\tau) \hat{i} + (\sin 2\Phi \cos 2\tau) \hat{j} + (\sin 2\tau) \hat{k}$$

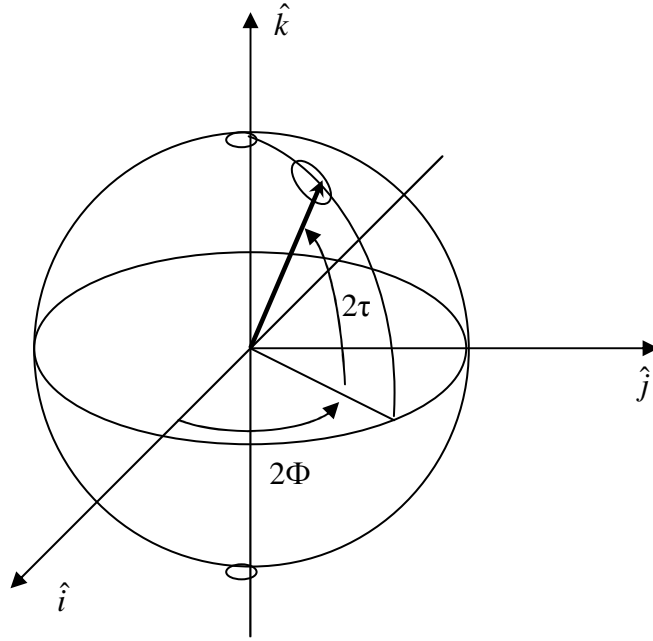

Is mentioned here the Stokes vector of components $g_1 g_2 g_3$. But here $g_1 g_2 g_3$ is not an abstract space but is a physical space, that of the position of $\hat{e}_3 = \psi \hat{k} \psi^*$ which is nothing but \hat{k} rotated through ψ or following Hestenes the axis of rotation of the rigid body.

These aspects are all to appreciate and understand.

We can follow the explicit steps leading \hat{k} to \hat{e}_3 through successive rotations.

$$(55) \quad \begin{aligned} \psi \hat{k} \psi^* &= e^{-i\Phi} e^{-j\tau} e^{j\frac{\pi}{4}} e^{-i\alpha} \hat{k} e^{+i\alpha} e^{-j\frac{\pi}{4}} e^{j\tau} e^{i\Phi} = \\ &= e^{-i\Phi} e^{-j\tau} e^{j\frac{\pi}{4}} \hat{k} e^{-j\frac{\pi}{4}} e^{j\tau} e^{i\Phi} = \\ &= e^{-i\Phi} e^{-j\tau} \left(\hat{k} e^{-j\frac{\pi}{2}} \right) e^{j\tau} e^{i\Phi} = \\ &= e^{-i\Phi} e^{-j\tau} \hat{i} e^{j\tau} e^{i\Phi} = \\ &= e^{-i\Phi} \hat{i} e^{j2\tau} e^{i\Phi} \end{aligned}$$

The last step rotate \hat{i} of an angle 2τ towards \hat{k} , and the whole is then rotated 2Φ towards \hat{j} . (Note the differences which \hat{j} and j , since $j = \hat{i}\hat{k}$).

The mapping between spinors and plane waves

We noted that according to (24) with the "complex" quantities V and I (indices 1, i) we introduce complex quantities (1, i) that are in fact fields. Transversal fields, respectively electric and magnetic fields, namely constant field in x, y and a function only of z . Fields are "fictitious" at least as are the quantities V, I , but still adequate to describe correctly the transport of energy in waveguide.

It happens that at rest V , or E , has two solutions (1, i) corresponding to the two circular polarizations of a TE.

Two other solutions are there for TM, for a total of two electric and two magnetic solutions, in all 4 solutions (1, i).

It remains to determine how to associate these 4 components (1, i) to the components $\psi_1\psi_2\psi_3\psi_4$ of a spinor ψ .

In other words, the question is what in ψ is "electric" and what is "magnetic".

In a previous section I noted that "the correspondence $TE \leftrightarrow \text{positron} \leftrightarrow (\psi_3 \neq 0)$ is ambiguous "and that" if the mathematics of the positron become the mathematics of the electron the TE at rest would be represented by $(\psi_1 \neq 0)$, more like pleasantly to formal identification (18)".

To follow the formal identification (18) assume that the components 1, i, j, ij of ψ correspond to electric fields.

At this point it presents a second difficulty.

The Dirac equation for plane wave at rest has the following 4 solutions

$$\begin{aligned}
 \psi &= e^{-i\alpha z} & \psi_1 &\neq 0, \text{ electron} \\
 \psi &= je^{-i\alpha z} & \psi_2 &\neq 0, \text{ electron} \\
 \psi &= Tj e^{+i\alpha z} & \psi_3 &\neq 0, \text{ positron} \\
 \psi &= Tj i (j e^{+i\alpha z}) & \psi_4 &\neq 0, \text{ positron}
 \end{aligned}
 \tag{56}$$

Note that $Tj i$

$$Tj i = \hat{i} \hat{j} \hat{k} \hat{T}
 \tag{57}$$

is the "imaginary of spacetime", squared (-1) $(Tj i)^2 = -1$ and commute with all elements 1, i, j, T, ij, iT, jT, Tji of even algebra. Is sometimes referred to as "i" in the notation of Hestenes or Cambridge.

Take the two solutions "electron"

$$(58) \quad \begin{aligned} \psi &= e^{-i\alpha t} & \psi_1 &\neq 0, \text{ elettrone} \\ \psi &= je^{-i\alpha t} & \psi_2 &\neq 0, \text{ elettrone} \end{aligned}$$

The two solutions have components $1, i, j, ij$.

The first of the two components $1, i$ is interpreted in a natural way as transverse electric field, just ask $\vec{E}_i = \psi \hat{i} = e^{-i\alpha t} \hat{i}$.

For the second component j, ij you can not have an interpretation as a transverse field. They do not see a reason.

Moreover certainly in quantum mechanics it represents the solution "electron" with opposite spin. In order to have $1, i$ components and rotate in the opposite direction multiply $-j$ from right. The final formula is (49).

Therefore the mapping that we have established with the (47) .. (49) between the even number ψ and the vector \vec{E} is so done, that the positions j, ij are still related to transverse components $1, i$, but rotating in opposite directions.

The same applies to the ψ components having Tji in front, which have the same meaning but are magnetic components.

As saying that the mapping (49) holds even if ψ is 8 components, and this provides not only \vec{E} but also \vec{H} in the form

$$(49\text{bis}) \quad \vec{E} + Tji\vec{H} = \psi_+ \hat{i} + \psi_- (-j)\hat{i}$$

Summary

We can now take stock and to go back over the progress made.

Starting this time from the Dirac equation we arrive in a few moments to the complete representation of the electromagnetic field in various TE and TM modes and in various polarizations.

$\psi = e^{-i\alpha x}$ and $\psi = je^{-i\alpha x}$ are solutions of the Dirac equation for plane wave at rest.

(Note: the same is repeated with the same solution with Tji in front).

Therefore it is also solution

$$(59) \quad \psi = \cos \rho e^{-i\alpha x} + \sin \rho (je^{-i\alpha x})$$

or any other linear combination of the type ($\psi\psi^* = 1$):

$$(60) \quad \psi = e^{-i\Phi} \cos \rho e^{-i\alpha x} + e^{-i\Phi} \sin \rho (je^{-i\alpha x})$$

which is a linear combination of the two basic solutions that appear in (59) and, for convenience, normalized to 1.

The (60) can be rewritten either:

$$\psi = e^{-i\Phi} (\cos \rho + j \sin \rho) e^{-i\alpha x} = e^{-i\Phi} e^{j\rho} e^{-i\alpha x}$$

or:

$$(61) \quad \psi = e^{-i\Phi} e^{-j\tau} e^{j\frac{\pi}{4}} e^{-i\alpha x}$$

just to put

$$(62) \quad \rho = -\tau + \frac{\pi}{4}$$

Apart from the irrelevance of the notations (use ρ or τ means having, for example, the circular $e^{-i\alpha x}$ for $\rho = 0$ or $\tau = \frac{\pi}{4}$) the (60) thus contains the polarization term used in the theory of polarization radar that is to say ("dropping the propagation factor "as they say in books) the factor:

$$(63) \quad e^{-i\Phi} e^{-j\tau} e^{j\frac{\pi}{4}}$$

However now (63) has very different meanings.

By a factor of propagation $e^{-i\alpha x}$ becomes the solution of the Dirac equation (61) for an electric field in elliptical polarization, at rest.

By a factor of propagation $e^{+i\omega t}$ and Tj

$$(64) \quad \psi = Tj e^{-i\Phi} e^{-j\tau} e^{j\frac{\pi}{4}} e^{+i\omega t}$$

becomes the solution of the Dirac equation for a magnetic field in elliptical polarization, at rest.

By a factor of propagation (see A5)

$$(65) \quad \psi = (1 + Tj) e^{-i\Phi} e^{-j\tau} e^{j\frac{\pi}{4}} e^{-i\omega t + ik_z z}$$

becomes "a polarization $e^{-i\Phi} e^{-j\tau} e^{j\frac{\pi}{4}} e^{-i\omega t}$ at the speed of light". In short in terms of quantum mechanics, a neutrino or rather a collection of neutrinos. In terms of electromagnetic field a TEM that propagates in the positive z direction.

Thus summing up the same factor of polarization (63) appears in all the formulas (61) (64) (65) except that now we are no longer in the presence of conventional scriptures of polarization but solutions of the Dirac equation.

(From a radar point of view (63) can be considered the baseband signal after purified by "coho").

(61) and (64) can "get moving" at speed v remaining solutions of Dirac equation, whereas (65) has no reference at rest, as it inevitably is moving with speed c.

If you remain in circular base is immediate in each case derive the electromagnetic field in the usual form \vec{E} and \vec{H} .

For example from (61) occurs in sequence:

$$(66) \quad \psi = e^{-i\Phi} e^{j\rho} e^{-i\omega t} = \cos \rho e^{-i\Phi} e^{-i\omega t} + \sin \rho e^{-i\Phi} e^{+i\omega t} j$$

from which is easy to recognize the components (respectively), with commute and anticommute with i .

$$(67) \quad \psi_+ = \cos \rho e^{-i\Phi} e^{-i\omega t}$$

$$\psi_- = \sin \rho e^{-i\Phi} e^{+i\omega t} j$$

and then with $\vec{E} + Tj\vec{H} = \psi_+ \hat{i} + \psi_- (-j)\hat{i}$

$$(68) \quad \vec{E} = \cos \rho \hat{i} e^{+i\Phi} e^{+i\omega t} + \sin \rho \hat{i} e^{+i\Phi} e^{-i\omega t}$$

Are clearly highlighted two opposing circular polarizations starting for $t = 0, \Phi = 0$ from the \hat{i} axis, while for $\Phi \neq 0$ starting from $\hat{i}e^{i\Phi}$.

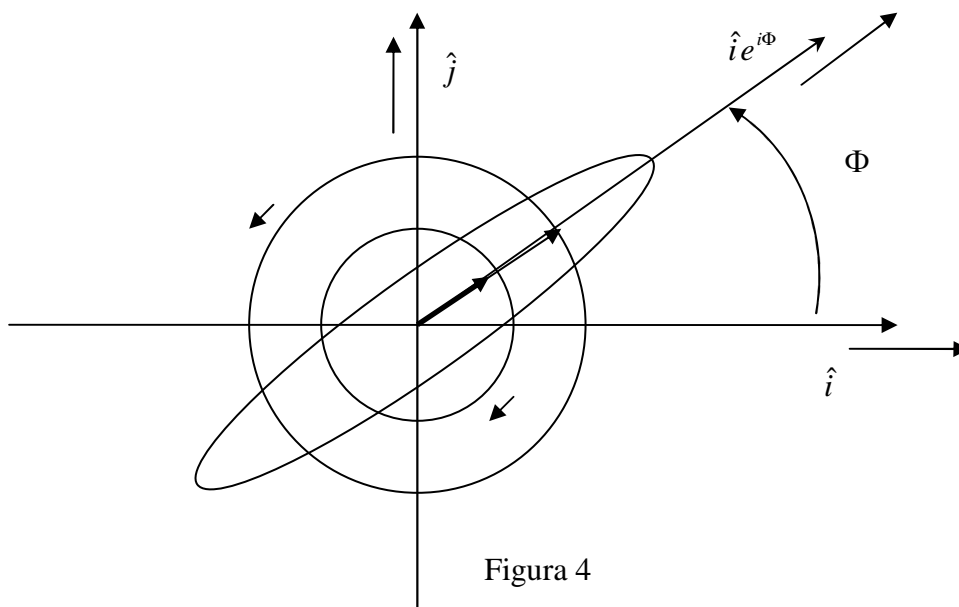
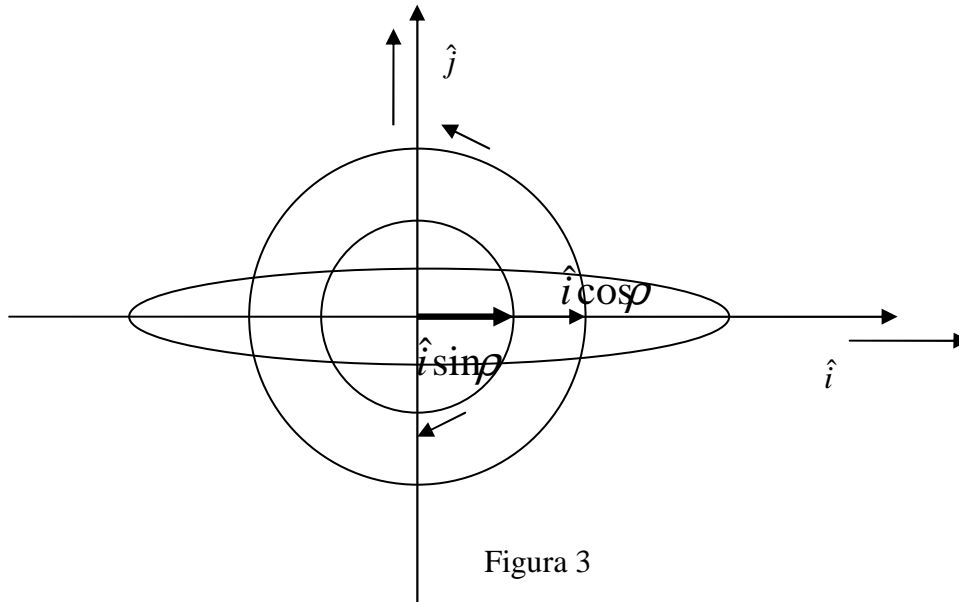

Let's look instead. (65), for example the case of pure circular polarization

$$(69) \quad \psi = (1 + Tj)e^{-i\omega t + ik_z z}$$

and then with a few quick moves (is $\psi \equiv \psi_+$ because it commutes with i)

$$(70) \quad \vec{E} + \mathbb{T}ji\vec{H} = \psi_+ \hat{i} = (e^{-i\omega t + ik_z z} + \mathbb{T}je^{-i\omega t + ik_z z}) \hat{i} = e^{-i\omega t + ik_z z} \hat{i} + \mathbb{T}jje^{-i\omega t + ik_z z} \hat{j}$$

Here are two vectors, electric and magnetic vectors of equal magnitude and corotating, but for $t = 0$ $z = 0$ the electric one start from \hat{i} and the other from \hat{j} . The situation then is that which is represented by a plane wave with Poynting vector directed according to the positive z direction and right rotation (R) in the IEEE conventions.



Figura 5

Conclusions

As I mentioned in the introduction to interest me in particular philosophical considerations. To be more explicit, not being able to show that the electron is an electromagnetic field, I set out to demonstrate that an electromagnetic field can be described as the electron with the Dirac equation.

The polarization radar is reinterpreted with possible consequences theoretical or practical, Clifford algebra has here one of the applications in which they can better appreciate the geometrical meaning (for further considerations see A9, A10).

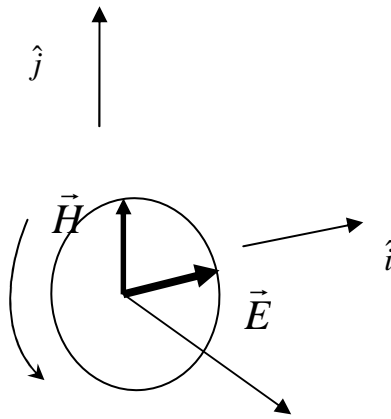
A1

Without losing the physical meaning of the unambiguous application of the Dirac equation for a spinor characterizing TEM TE and TM, I can not say whether it has some basis the analogy TE \leftrightarrow electron and / or TM \leftrightarrow positron. It is possible that the analogy means that at rest for a TE or TM

$$(71) \quad \psi\psi^* = E^2 - H^2$$

So for a TE or TM where there was only E or only H:

$$(72) \quad \psi\psi^* = E^2 > 0$$

$$(73) \quad \psi\psi^* = -H^2 < 0$$

Since $\psi\psi^*$ is invariant under Lorentz transformations, this value at rest is valid forever. Therefore (72) and (73) inform us that there are two different entities of this kind.

Another reason for the analogy might lie in the "charge" positive or negative we must assign to TE and TM to describe their behavior when they are accelerated or slowed. This analogy (see below, A8) seems to depend on the opposite sign of ω in $e^{i\omega t}$.

A2

It is interesting to note that \hat{i} \hat{j} \hat{k} are isomorphic with the Pauli matrices

$$(74) \quad \sigma_x = \begin{bmatrix} 0 & 1 \\ 1 & 0 \end{bmatrix} \quad \sigma_y = \begin{bmatrix} 0 & -i \\ i & 0 \end{bmatrix} \quad \sigma_z = \begin{bmatrix} 1 & 0 \\ 0 & -1 \end{bmatrix}$$

In fact:

$$(75) \quad \sigma_\mu^2 = 1 \quad \sigma_i \sigma_k = -\sigma_k \sigma_i \quad \sigma_x \sigma_y = i \sigma_z$$

and they coincide exactly with the formulas (see below, A4)

$$(76) \quad \hat{i}^2 = 1 \quad \hat{j}^2 = 1 \quad \hat{k}^2 = 1 \quad \hat{j}\hat{i} = -\hat{i}\hat{j} \quad \text{etc} \\ \hat{i}\hat{j} = I\hat{k} \quad \text{with } I = \hat{i}\hat{j}\hat{k}$$

Note that $I = \hat{i}\hat{j}\hat{k}$ play a role of the imaginary in the \hat{i} \hat{j} \hat{k} algebra because commute and has square -1.

So too are isomorphic with the Pauli matrices:

$$(77) \quad \hat{i}\hat{T} \quad \hat{j}\hat{T} \quad \hat{k}\hat{T}$$

Instead are isomorphic with the symbols of Hamilton, see (88) (89), then $1a + ib + jc + jid$ is a quaternion of Hamilton.

A3

I remember that the time axis \hat{T} rotated through a Lorentz transformation becomes the four-velocity \hat{u} ($\hat{T}^2 = -1, \hat{u}^2 = -1$).

Indeed let for example:

$$(78) \quad R = e^{-\hat{k}\hat{T}\frac{\varphi}{2}}$$

and rotate \hat{T} doing

$$(79) \quad R\hat{T}R^* = e^{-\hat{k}\hat{T}\frac{\varphi}{2}}\hat{T}e^{\hat{k}\hat{T}\frac{\varphi}{2}} = \hat{T}e^{\hat{k}\hat{T}\varphi}$$

But it is developing the exponential

$$(80) \quad \hat{T}e^{\hat{k}\hat{T}\varphi} = \hat{T} \left(\frac{1}{\sqrt{1-\frac{v^2}{c^2}}} + \hat{k}\hat{T} \frac{\frac{v}{c}}{\sqrt{1-\frac{v^2}{c^2}}} \right)$$

where

$$(81) \quad \varphi = \operatorname{arcth} \frac{v}{c}$$

for which

$$(82) \quad \hat{u} = \hat{T}e^{\hat{k}\hat{T}\varphi} = \left(\frac{\hat{T}}{\sqrt{1-\frac{v^2}{c^2}}} + \hat{k} \frac{\frac{v}{c}}{\sqrt{1-\frac{v^2}{c^2}}} \right)$$

is the four-velocity of the body. Its square is (-1) for any velocity v . In the case of (82) motion is the Z axis having been made a Lorentz transformation (rotation) according to the bivector $\hat{k}\hat{T}$ normal to the plane (z, τ) .

A4

Algebra here is based on 4 elements $\hat{i} \hat{j} \hat{k} \hat{T}$, unit vectors in spacetime (sometimes referred to the authors e_1, e_2, e_3, e_0). They have the following properties:

$$(83) \quad \hat{i}^2 = 1 \quad \hat{j}^2 = 1 \quad \hat{k}^2 = 1 \quad \hat{T}^2 = -1 \quad \hat{j}\hat{i} = -\hat{i}\hat{j} \text{ etc}$$

and I use the symbols $i j T$ to generalize the usual imaginary unit i of the xy plane

$$(84) \quad i = \hat{i}\hat{j} \quad j = \hat{i}\hat{k} \quad T = \hat{i}\hat{T}$$

All this, combined with the rule concerning the conjugates

$$(85) \quad (AB)^* = B^* A^*$$

generates all properties of interest.

In fact is enough to admit that fact $\hat{i} \hat{j} \hat{k}$ do not change by conjugation (as it is intuitive that it should be) to derive for example, or rediscover, the usual rule for the conjugate i^* :

$$(86) \quad i^* = (\hat{i}\hat{j})^* = \hat{j}^* \hat{i}^* = \hat{j}\hat{i} = -\hat{i}\hat{j} = -i$$

and so is obtained

$$(87) \quad j^* = -j \quad T^* = -T$$

Apply, as a consequence of (83) and (84),

$$(88) \quad i^2 = -1 \quad j^2 = -1 \quad T^2 = 1$$

$$(89) \quad ij = -ji \quad iT = -Ti \quad jT = -Tj$$

The 16 elements algebra

1, $\hat{i} \hat{j} \hat{k} \hat{T}$ (4 elements), $\hat{i}\hat{j} \hat{i}\hat{T}$ etc. (6 elements), $\hat{i}\hat{j}\hat{k}$ etc. (4 elements), $\hat{i}\hat{j}\hat{k}\hat{T}$

contains a subalgebra of 8 elements ("even subalgebra of a Clifford algebra", Hestenes)

$$1, \quad \hat{i}\hat{j} \hat{i}\hat{T} \text{ etc. (6 elements),} \quad \hat{i}\hat{j}\hat{k}\hat{T}$$

rewritten at will as consisting of all possible products between

1, i, j, T, ij, iT, jT, Tji

Element Tji hence the previous property benefits of:

$$(90) \quad (Tji)^* = Tji$$

$$(91) \quad (Tji)^2 = -1$$

The complex

$$(92) \quad z = x + iy \quad (\bar{x} = \hat{i}z = x\hat{i} + y\hat{j})$$

generalizes in spacetime with

$$(93) \quad z = x + iy + jz + T\tau \quad (\bar{x} = \hat{i}z = x\hat{i} + y\hat{j} + z\hat{k} + \tau\hat{T})$$

(not confuse z in first and second member, sorry).

We have

$$(94) \quad zz^* = x^2 + y^2 + z^2 - \tau^2 \quad (\bar{x}^2 = \bar{x}\bar{x} = zz^*)$$

On xy plane symbols or operators

$$(95) \quad \partial = \frac{\partial}{\partial x} - i \frac{\partial}{\partial y}$$

$$\partial^* = \frac{\partial}{\partial x} + i \frac{\partial}{\partial y}$$

are, respectively, to express the derivative and the Cauchy Riemann conditions.

These are generalized in

$$(96) \quad \partial = \frac{\partial}{\partial x} - i \frac{\partial}{\partial y} - j \frac{\partial}{\partial z} - T \frac{\partial}{\partial \tau}$$

$$\partial^* = \frac{\partial}{\partial x} + i \frac{\partial}{\partial y} + j \frac{\partial}{\partial z} + T \frac{\partial}{\partial \tau}$$

and the property is

$$(97) \quad \partial\partial^* = \partial^*\partial = \frac{\partial^2}{\partial x^2} + \frac{\partial^2}{\partial y^2} + \frac{\partial^2}{\partial z^2} - \frac{\partial^2}{\partial \tau^2}$$

Alternatively to the symbol or operator ∂^* used to express the analyticity one can use the operator that is obtained by multiplying by \hat{i} from left
(Note: if $\partial^* f = 0$ also $\hat{i}\partial^* f = 0$ and vice versa).

The operator thus obtained

$$(98) \quad \hat{i}\partial^* = \frac{\partial}{\partial x}\hat{i} + \frac{\partial}{\partial y}\hat{j} + \frac{\partial}{\partial z}\hat{k} + \frac{\partial}{\partial \tau}\hat{T} = \bar{\partial}_v$$

is formally a four-vector, as \bar{x} .

So on.

This algebra differs from the STA for the choice of the base with the properties (83). The STA choice is for spacelike unit vectors γ_k ($k=1,2,3$) having square (-1). Thus there is a basis in spacetime that instead of (83) has the properties:

$$(99) \quad \gamma_k^2 = -1, \gamma_0^2 = 1$$

So doing to obtain a unit vector basis x, y, z in space should be defined three bivectors (Hestenes, [3]):

$$(100) \quad \sigma_k = \gamma_k \gamma_0$$

Hestenes note explicitly the opportunities of either choice ([3], p.25):

“If instead we had chosen $\gamma_k^2 = 1, \gamma_0^2 = -1$ we could entertain the solution $\sigma_k = \gamma_k$, which may seem more natural, because...”,

because vectors in spacetime would also be vectors in space.

I prefer to keep this option best suits to engineers (unit vectors $\hat{i} \hat{j} \hat{k}$ with square +1, imaginary unit i , complex number $x + iy$, etc.).

Plus (Doran, [2]) for any of the two choices the even algebras are isomorphic, so working in even algebra there is no change in anything.

I should also note that all the conditions that I used as a vector, complex number, imaginary unit and so on recall mnemonically concepts of the past and we can sometimes help but are materially misleading. All the entities we have introduced are simply numbers, and we can correctly call "Clifford numbers", simple underlying rules, sum product and division, of the Clifford algebra. The same goes for symbols such as asterisk or the arrow for vectors etc., here have the sole function of mnemonic recall. What matters are only the properties of algebra I have briefly summarized.

A5

Spinorial solutions on TEM have some special properties which should be considered. We have seen that for the TE TM (with $\omega_0 = m$ cut off frequency of the mode) the equation holds:

$$(101) \quad \partial^* \psi = -\hat{i} m \psi \hat{T}$$

and for TEM

$$(102) \quad \partial^* \psi = 0$$

A solution of (102) is for example

$$(103) \quad \psi = (1 + Tj) e^{-i\alpha t + ik_z z}$$

who is "what becomes the polarization $e^{-i\alpha t}$ reaching the speed of light". In terms of spinors a neutrino, in terms of the em field the spinor describing a TEM.

Note that formally the equation for ψ is the same as for the electromagnetic field F , but it is obviously different the rule for the Lorentz transformation. The plane wave, fictitious, equivalent to the spinor ψ , is obtained from

$$(104) \quad \vec{E} + Tj\vec{H} = \psi_+ \hat{i} + \psi_- (-j)\hat{i}$$

while if it were a em field would be achieved by

$$(105) \quad F\hat{i} = E_x \hat{i} + E_y \hat{j} + E_z \hat{k} + Tj(H_x \hat{i} + H_y \hat{j} + H_z \hat{k})$$

(the situation is not very different from that in plane admits as analytic functions z and \sqrt{z}).

The presence of the term

$$(106) \quad (1 + Tj) = (1 + \hat{k}\hat{T})$$

in (103) gives rise to some special properties such

$$(107) \quad \psi \equiv \psi \hat{k}\hat{T}$$

Computing the four-velocity and spin through the usual relations:

$$(108) \quad \hat{u} = \psi \hat{T} \psi^* \quad \hat{s} = \psi \hat{k} \psi^*$$

we find using (107)

$$(109) \quad \hat{u} = -\hat{s}$$

We can calculate explicitly the four-velocity that corresponds to the signal (103). In this case the normalization $\psi \psi^* = 1$ is not possible because $\psi \psi^* = 0$, but use an arbitrary normalization of ψ with $\sqrt{2}$. Thus we have

$$(110) \quad \psi \hat{T} \psi^* = 1/2 (1+Tj) e^{-i\alpha + ik_z z} \hat{T} e^{+i\alpha - ik_z z} (1-Tj) = 1/2 (1+Tj) \hat{T} (1-Tj)$$

and finally using (106)

$$(111) \quad \psi \hat{T} \psi^* = \hat{u} = \hat{T} - \hat{k}$$

The module of the four-velocity is zero and its correct meaning is (energy) = (momentum).

The spin for the (109) is

$$(112) \quad \hat{s} = \hat{k} - \hat{T}$$

a four-vector with $\hat{s}^2 = 0$.

Consider the other solution with opposite spin

The solution of (102) with ψ_2 and ψ_4 nonzero provides:

$$(114) \quad \psi \equiv -\psi \hat{k} \hat{T}$$

This is "what becomes the polarization $j e^{-i\alpha}$ at velocity c".

This time is instead of (107)

$$(114) \quad \psi \equiv -\psi \hat{k} \hat{T}$$

Similar calculations as the previous one lead to

$$(115) \quad \hat{u} = \hat{s}$$

$$(116) \quad \hat{u} = \hat{T} - \hat{k}$$

$$(117) \quad \hat{s} = \hat{T} - \hat{k}$$

The result is quite logical because the four-velocity can not be different from before (always the impulse is traveling toward the positive z). Instead we get a meaningful information about polarization that is that the spin in the two cases is opposite.

We can identify the components of \hat{s} with the 4 components of the Stokes vector of the radar polarization for which

$$(118) \quad g_0^2 = g_1^2 + g_2^2 + g_3^2$$

A6

Review the meaning of wanting to describe a four vector by a spinor associated with it.

Let's start from the study of a plane motion with complex numbers, rather than through the velocity vector tangent to the trajectory. Placing

$$\vec{v} = \rho e^{i\varphi} \hat{i}$$

instead of the analysis in terms of velocity vector

$$\vec{v}$$

leads to the study of complex number

$$z = \rho e^{i\varphi}$$

We can say (after Hestenes) that the operation that has made here introduced a Clifford algebra constructed on the basis of the two unit vector of the plane:

$$\hat{i}, \hat{j}$$

and having identified as "imaginary" the bivector

$$i = \hat{i}\hat{j}$$

The space of complex numbers z is thus identified as "even subalgebra of a Clifford algebra" of components, so if you want to call it "real" 1 and "imaginary" i . The essential thing is that everything is clear, all roles, including geometric, are clarified. The word "complex" or "imaginary" is essentially useless or misleading.

Facciamo ora il salto successivo che è quello di passare dal piano 2D allo spazio 3D. Let us now jump next to move from 2D to 3D space. Everything is repeated with the added fact that I consider irrelevant even if it is necessary, that now the complex number must be applied half right and half left. All of this is known.

The number now has 4 components and is called quaternion.

With the usual language and the clarity of clarification we owe to David Hestenes (although my symbols) we can say that this introduces an "even subalgebra of a Clifford algebra constructed on a 3 unit vector space:

$$\hat{i}, \hat{j}, \hat{k}$$

The components of quaternions are precisely the components "even" of algebra $1, \hat{i}\hat{j}, \hat{i}\hat{k}, \hat{j}\hat{k}$

The last and decisive step is to pass in 4D, i.e. the study of a vector in spacetime or four-vector with a complex number, according to the usual technique that we have seen in 2D and 3D space.

It is necessary (and sufficient) to introduce a Clifford algebra on a basis of 3 unit vectors spacelike and one timelike:

$$\hat{i}, \hat{j}, \hat{k}, \hat{T}$$

and this identifies a "even subalgebra of a Clifford algebra" to 8 components

$$1, \hat{i}\hat{j}, \hat{i}\hat{k}, \hat{j}\hat{k}, \hat{i}\hat{T}, \hat{j}\hat{T}, \hat{k}\hat{T}, \hat{i}\hat{j}\hat{k}\hat{T}$$

Complex numbers ψ are now Dirac spinors with the exception of details and / or notations. Even now, the complex number must be applied half right and half left. For example, if \vec{P} is an energy momentum vector then $\vec{P} = \psi\hat{T}\psi^*$ as with the quaternions (except here the use of \hat{T}) and so on. The essential thing is that everything is clear, all roles, including geometric, are clarified.

Note that the sub-case with components $1, \hat{i}\hat{j}, \hat{i}\hat{k}, \hat{j}\hat{k}$ provides the aforementioned quaternions in 3D space while the components $1, \hat{i}\hat{j}$ give the ordinary complex numbers in the 2D xy plane.

Among the various consequences of the rotation in spacetime there is one now eg. a four-velocity can be rotated with a bivector like $\hat{i}\hat{j}$ and then rotate on \hat{i}, \hat{j} plane, but also with a bivector like $\hat{i}\hat{T}$ and then rotate on \hat{i}, \hat{T} plane or speeds up or slows down.

The law of transformation "single-sidedly" of spinors is summarized effectively by Doran et. al. (see, for example. "States and operators in the Spacetime Algebra", Found. Phys. 23 (9), 1993).

If a vector such

$$(119) \quad \hat{s} = \psi\hat{k}\psi^*$$

is rotated through $R'(_)R'^*$, the result of the rotation is

$$(120) \quad \hat{s}' = R'\hat{s}R'^*$$

then the corresponding spinor must transform

$$(121) \quad \psi' = R'\psi$$

“We use the term spinor to denote any object which transforms single-sidedly under a rotor R” (Doran).

A7

We show that the equations of transmission lines for TE and TM modes in waveguide are the Dirac equations.

The treatment of TM along with TE leads to these equations (e.g. by Franceschetti or [6], [7]):

$$\begin{aligned} \text{TE} \quad \frac{dV}{dz} &= -i\omega\mu I \\ \frac{dI}{dz} &= -i\omega\epsilon \left(1 - \frac{\omega_0^2}{\omega^2}\right) V \end{aligned} \quad (122)$$

$$\begin{aligned} \text{TM} \quad \frac{dV}{dz} &= -i\omega\mu \left(1 - \frac{\omega_0^2}{\omega^2}\right) I \\ \frac{dI}{dz} &= -i\omega\epsilon V \end{aligned}$$

Let in (27) with respect to TM

$$(123) \quad \alpha = \frac{\sqrt{\omega + \omega_0}}{\sqrt{\omega}}$$

and so you get a new set of equations for the TM similar to (41) for the TE. By grouping all

$$\begin{aligned} \text{TE} \quad \frac{dV'}{dz} + (i\omega + i\omega_0)\mu I' &= 0 \\ \frac{dI'}{dz} + (i\omega - i\omega_0)\epsilon V' &= 0 \\ \text{TM} \quad \frac{dV'}{dz} + (i\omega - i\omega_0)\mu I' &= 0 \\ \frac{dI'}{dz} + (i\omega + i\omega_0)\epsilon V' &= 0 \end{aligned} \quad (124)$$

Conventions in use (eg Ramo) assumed an exponential dependence $e^{+i\alpha z}$ hence $i\omega$ comes from a derivative $\frac{\partial}{\partial t}$ and therefore we can rewrite the formulas for what they really mean (pitch for simplicity a system with V, I equidimensional, $c = 1$)

$$\frac{dV'}{dz} + \left(\frac{\partial}{\partial \tau} + i\omega_0 \right) I' = 0$$

TE

$$\frac{dI'}{dz} + \left(\frac{\partial}{\partial \tau} - i\omega_0 \right) V' = 0$$

(125)

$$\frac{dV'}{dz} + \left(\frac{\partial}{\partial \tau} - i\omega_0 \right) I' = 0$$

TM

$$\frac{dI'}{dz} + \left(\frac{\partial}{\partial \tau} + i\omega_0 \right) V' = 0$$

Recalling (24) we can explain the various $V(z)$ and $I(z)$ in their sense of complex quantities (1, i) representatives of constant transverse fields, respectively TE and TM

$$\frac{dE_{TE}}{dz} + \left(\frac{\partial}{\partial \tau} + i\omega_0 \right) H_{TE} = 0$$

TE

$$\frac{dH_{TE}}{dz} + \left(\frac{\partial}{\partial \tau} - i\omega_0 \right) E_{TE} = 0$$

(126)

$$\frac{dE_{TM}}{dz} + \left(\frac{\partial}{\partial \tau} - i\omega_0 \right) H_{TM} = 0$$

TM

$$\frac{dH_{TM}}{dz} + \left(\frac{\partial}{\partial \tau} + i\omega_0 \right) E_{TM} = 0$$

The Dirac equation for a plane wave in z are

$$\left(\frac{\partial}{\partial z} \psi_3 + \left(\frac{\partial}{\partial \tau} + im \right) \psi_1 = 0 \right.$$

$$\left. - \frac{\partial}{\partial z} \psi_4 + \left(\frac{\partial}{\partial \tau} + im \right) \psi_2 = 0 \right)$$

(127)

$$\frac{\partial}{\partial z} \psi_1 + \left(\frac{\partial}{\partial \tau} - im \right) \psi_3 = 0$$

$$- \frac{\partial}{\partial z} \psi_2 + \left(\frac{\partial}{\partial \tau} - im \right) \psi_4 = 0$$

How are grouped 4 complex quantities $(1, i) H_{TE} E_{TE} H_{TM} E_{TM}$ in a Dirac spinor $\psi = \psi_1 + j\psi_2 + Tj\psi_3 + T\psi_4$ where $\psi_1\psi_2\psi_3\psi_4$ are number $(1, i)$? Use for this the correspondence (49bis) already established between spinors and fields I remember here and then developed in full. We have:

$$(128) \quad \vec{E} + Tji\vec{H} = \psi_+ \hat{i} + \psi_- (-j)\hat{i}$$

and being

$$(129) \quad \psi = \psi_1 + j\psi_2 + Tj\psi_3 + T\psi_4$$

is obtained from (48)

$$(130) \quad \psi_+ = (\psi_1 + Tj\psi_3)$$

$$(131) \quad \psi_- = (j\psi_2 + T\psi_4)$$

from which

$$(132) \quad \vec{E} + Tji\vec{H} = \psi_+ \hat{i} + \psi_- (-j)\hat{i} = (\psi_1 + Tj\psi_3 + j\psi_2(-j) + T\psi_4(-j))\hat{i}$$

This can also explicitly write with the fields that correspond to ψ_+ and ψ_-

$$(133) \quad \vec{E} + Tji\vec{H} = F\hat{i} = (E_+ + TjiH_+ + E_- + TjiH_-)\hat{i}$$

Given the significance of the various terms you'll find that it is written the spinor ψ differently. For comparison:

$$(134) \quad \begin{aligned} E_+ &= \psi_1 \\ TjiH_+ &= Tj\psi_3 \\ E_- &= j\psi_2(-j) \\ TjiH_- &= T\psi_4(-j) \end{aligned}$$

Obtaining $\psi_1\psi_2\psi_3\psi_4$ and replacing in the Dirac equation (127) it comes with a long but easy steps

$$\begin{aligned}
 & \frac{dH_+}{dz} + \left(\frac{\partial}{\partial \tau} + i\omega_0 \right) E_+ = 0 \\
 & \frac{dH_-}{dz} + \left(\frac{\partial}{\partial \tau} - i\omega_0 \right) E_- = 0 \\
 (135) \quad & \frac{dE_+}{dz} + \left(\frac{\partial}{\partial \tau} - i\omega_0 \right) iH_+ = 0 \\
 & \frac{dE_-}{dz} + \left(\frac{\partial}{\partial \tau} + i\omega_0 \right) iH_- = 0
 \end{aligned}$$

which are precisely the equations (126) in waveguides by Franceschetti - Ramo but also the Dirac equation where it is simply done the following name change in ψ components:

$$(136) \quad \begin{bmatrix} \psi_1 \\ \psi_2 \\ \psi_3 \\ \psi_4 \end{bmatrix} = \begin{bmatrix} E_+ \\ jE_-j \\ iH_+ \\ ijH_-j \end{bmatrix}$$

A8

We start from the Dirac equation (127) for free particle with the components ψ_1 and ψ_3 :

$$(137) \quad \frac{\partial}{\partial z} \psi_3 + \left(\frac{\partial}{\partial \tau} + im \right) \psi_1 = 0$$

$$\frac{\partial}{\partial z} \psi_1 + \left(\frac{\partial}{\partial \tau} - im \right) \psi_3 = 0$$

These may be a TE or a TM depending on if resolved at rest with $\psi_1 \neq 0$ or with $\psi_3 \neq 0$.

The Dirac equation in the presence of potential energy U for an electron becomes

$$(138) \quad \frac{\partial}{\partial z} \psi_3 + \left(\frac{\partial}{\partial \tau} + iU + im \right) \psi_1 = 0$$

$$\frac{\partial}{\partial z} \psi_1 + \left(\frac{\partial}{\partial \tau} + iU - im \right) \psi_3 = 0$$

These resolved with $\psi_1 \neq 0$ at rest provide (placing $m \rightarrow \omega_0$)

$$(139) \quad \psi_1 = e^{-i\alpha x + ik_z z} \quad \psi_3 = B e^{-i\alpha x + ik_z z} \quad B = \frac{\sqrt{(\omega - U) - \omega_0}}{\sqrt{(\omega - U) + \omega_0}}$$

$$(140) \quad k_z^2 = (\omega - U)^2 - \omega_0^2$$

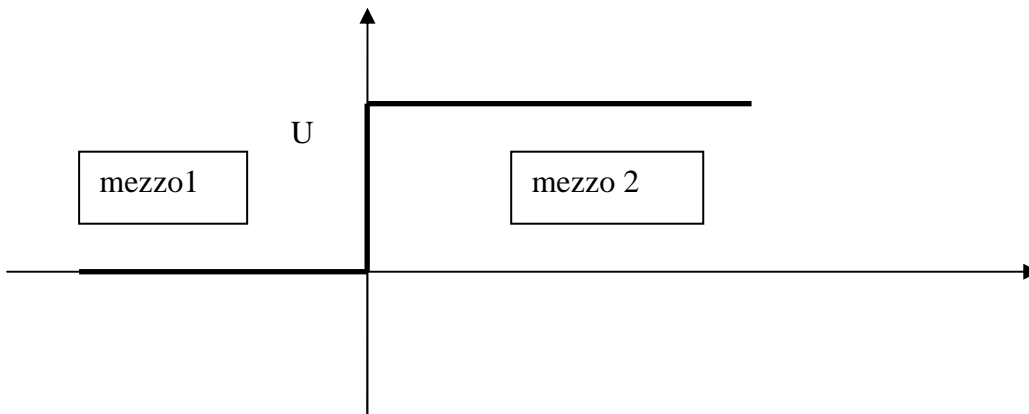

Formula (140) for k_z allows the calculation of speed in medium 2 and therefore also allows an analogy with the propagation of TE in a waveguide 2 with a different cutoff frequency (or size d_2).

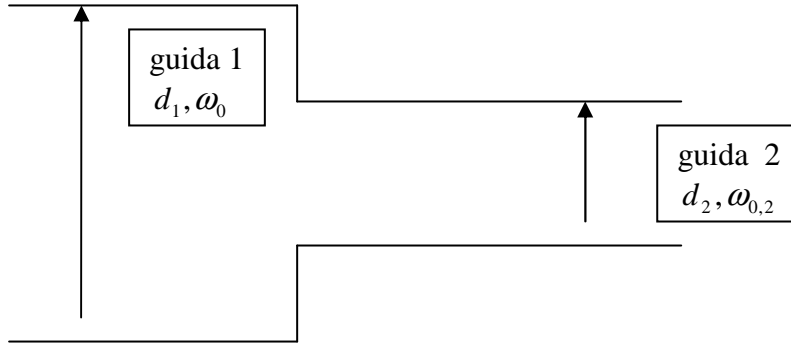

For this we use the formula $v_g = \frac{d\omega}{dk_z}$ for the group velocity in a waveguide.

From (140) is obtained

$$(141) \quad k_z = \sqrt{(\omega - U)^2 - \omega_0^2} \quad \text{so}$$

$$(142) \quad v_g = \frac{d\omega}{dk_z} = \sqrt{1 - \frac{\omega_{0,2}^2}{\omega^2}} \quad \text{where}$$

$$(143) \quad \omega_{0,2} = \frac{\omega_0}{1 - \frac{U}{\omega}}$$

The (143) implicitly provides the size of the waveguide 2 with respect to the waveguide 1. Conversely given a transition between a guide 1 of size d_1 and a second guide of size d_2 the (143) gives the value of U to be included in the Dirac equation to represent this transition between waveguides.

The analogy provides useful information for the interpretation of the "Klein paradox". In short for $U = \omega - \omega_0$ the (143) provides $\omega \equiv \omega_{0,2}$ i.e. waveguide 2 is at cutoff and the wave becomes evanescent. If U increases further, for $U = \omega$ waveguide 2 closes completely and a further growth of U has no physical sense. Explicitly $d_2 = (1 - U/\omega)d_1$ and thus if $U \geq \omega$ the size of the second waveguide was negative i.e. the equation (138) is no longer representative of the phenomenon.

Now suppose that the same transition between waveguides of the previous case interests instead of a TE a TM.

From the electromagnetic point of view with the same parameters ω, ω_0 and size of the waveguide 2 makes no difference whether it is a TM or a TE in the sense that the final velocity of the field in medium 2 is the same. However to achieve this is necessary as we will take hours instead of (138) other equations in which the potential energy is changed in sign, as happens with the change of sign of electric charge ($U = \pm eV$) in the Dirac equation.

Precisely the equations must be like those of the positron

$$(144) \quad \frac{\partial}{\partial z} \psi_3 + \left(\frac{\partial}{\partial \tau} - iU + im \right) \psi_1 = 0$$

$$\frac{\partial}{\partial z} \psi_1 + \left(\frac{\partial}{\partial \tau} - iU - im \right) \psi_3 = 0$$

They actually have solutions

$$(145) \quad \psi_3 = e^{+i\omega\tau - ik_z z} \quad \psi_1 = B e^{+i\omega\tau - ik_z z} \quad B = \frac{\sqrt{(\omega - U) - \omega_0}}{\sqrt{(\omega - U) + \omega_0}}$$

$$k_z^2 = (\omega - U)^2 - \omega_0^2$$

From these derive the same formulas (141) (142) (143) and the same speed in the guide 2, which would have a TE.

A9

In summary, if one describe an electromagnetic field as a whole without looking inside, you find that it is described by a Dirac spinor and the Dirac equation for the electron.

The simple mechanism, and the reason why this happens is as follows: describing a given electromagnetic field through total energy momentum vector (ie the volume integral of density given by the energy and momentum tensor) they form a four vector.

At this point the game is done because, as shown in STA or Space Time Algebra (Hestenes, Doran etc.) to give a four vector you must (or can) give a Dirac spinor. From here, a lot of consequences and reflections in various directions.

One, for example, clarifying the role of 'entity' spinor. Consider the quaternions that one right and one left, describing a 3D vector. Well as you can see with the mathematics of the STA the Dirac spinors, one operating from the right and one left, are used to give a four vector, 4D (relativistic).

(the game so he did appear spinors and Dirac equation is exactly what you want to describe the electromagnetic field with a given four vector, with the volume integral of energy momentum density, i.e. as a whole, i.e. without looking inside).

More, the Dirac equation, which underlie the spinors, we find very elegant and nothing but the equation, relativistic and written in terms STA, of the usual equations of EM fields in waveguide written in terms of V and I.

There are several other consequences. He recalls a few.

Chosen as em field a field in waveguide that will also travel to velocity v different from c , the spinor has been provided without the required two distinct types of field, which turns out to be the TE and TM each in right or left polarization, for a total of 4 possible solutions. At the speed of light instead they are provided only 2 (logical, because a TE at this point is indistinct from a TM).

We now want to give our electric field the ability to go faster or slower?

In the Dirac equation, which underlie the spinors, we must introduce a coupling parameter formally identical to the electric charge, after which widen or tighten the guide (ie, vary the speed of the field) appear in the equation with a scalar electric potential similar to the electrical potential "phi".

So also it appears likely the opportunity to clarify some things about our methods.

Example, the Dirac equation, which is still subject of debate and discussion (see ex. [8],.....[12] or [13] D. Hestenes, "Mysteries and Insights of Dirac's Theory"), provides in automatic dual possibility of particle / antiparticle and a double spin state. Now it is certainly significant that with only the mathematical condition to describe a four vector with the spinor associated with it, for an electromagnetic field automatically follows a double possibility of state TE / TM in a double state of circular polarization.

I.e. a complete analogy exists and is not the only one. It follows that the Dirac equation lends itself to be investigated in this case than in the case, less "accessible", the electron.

A10

Among the various consequences, I think (and this is one of the many reasons for this paper) that the study of radar scattering from a target, with the notations of Clifford algebra we can draw a parallel to the interactions between signal-to-target and electroweak interactions.

Notations of Clifford algebra are not obviously essential but to create a parallel could be extremely educational and physical.

Perhaps we could deepen, with a concrete example, which is visible, that is ... the example of scattering from a radar target, what are the various conventions, methodology, rules, particles, interactions and so on and so forth that appear in the Standard Model.

I go into some detail.

The basic observation from which to start is as follows.

We have seen that ψ was ultimately responsible for providing the four-vector $\psi\hat{T}\psi^*$. It is assigned a spinor with 8 parameters while 4 are enough to assign a four vector. So there is a fourfold arbitrariness in ψ (Hestenes, [11], [14]), which is represented by the 4 parameters transformation:

$$(146) \quad \psi' \rightarrow \psi e^{\text{T}ji\beta+ij\nu-i\Phi+j\rho}$$

It is indeed significant that an arbitrary transformation of this kind leaves $\psi\hat{T}\psi^*$ unchanged.

Now the group $e^{\text{T}ji\beta+ij\nu-i\Phi+j\rho}$ is the group $SU(2)\otimes U(1)$ (i, j, ij is $SU(2)$). It follows that in the description of the electromagnetic field with a four-vector $\psi\hat{T}\psi^*$ you can submit ψ to a transformation $SU(2)\otimes U(1)$ without altering the energy momentum vector. $SU(2)\otimes U(1)$ therefore acts as an "internal symmetry".

We may then assume with a little imagination

a) that the (146) is accepted as a legitimate global transformation into a new equation that can accept it ("a modification of the Dirac equation to accommodate the larger gauge group", Hestenes [11]).

The Dirac equation (13) as it is formulated only accepts the 'electromagnetic gauge group' " $e^{-i\Phi}$ ".

The new equation could be (?) the equation of a neutrino or from a radar point of view a TEM namely:

$$(147) \quad \partial^* \psi = 0;$$

b) that in the new equation the transformation from global to local gives, following the usual techniques of the gauge fields, the various electroweak forces acting on a TEM / neutrino and / or TE / TM, but this time it is clearly visible meanings.

Let's stop here with the imagination.

In the words of Hestenes to finish one of his most imaginative articles:
"That's enough speculation for one paper!"

A11

From:

$$(7) \quad F\hat{i} = E_x\hat{i} + E_y\hat{j} + E_z\hat{k} + Tji(H_x\hat{i} + H_y\hat{j} + H_z\hat{k}) \rightarrow F\hat{i} = \vec{E} + Tji\vec{H}$$

is immediate and very elegant derive Maxwell's equations with div and rot.

Here is a (long) introduction on a property of the product in Clifford algebra, properties that I don't mentioned in A4.

In Clifford algebra arises naturally a product that incorporates scalar product and vector product.

It starts from the obvious equality:

$$(147) \quad ab = \frac{1}{2}(ab + ba) + \frac{1}{2}(ab - ba)$$

This truism becomes a raison d'etre for the fact that there are elements of Clifford Algebra which anticommute, so it makes sense to speak of ba distinct from ab .

They are also potentially opposite.

An analysis of (147) with some examples immediately shows that

$$(148) \quad \frac{1}{2}(ab + ba) = a \bullet b$$

is the usual inner product between vectors and is a scalar, while what should be called exterior product:

$$(149) \quad \frac{1}{2}(ab - ba) = a \wedge b$$

remember, but do not call it that, the vector product $a \times b$.

For if a and b are vectors $a \wedge b$ is a bivector, while $a \times b$ is a vector.

Between the two the formula holds:

$$(150) \quad a \wedge b = (\hat{i}\hat{j}\hat{k})(a \times b)$$

you can also use reversed

$$(151) \quad a \times b = -(\hat{i}\hat{j}\hat{k})(a \wedge b)$$

The (151) is not necessary to send her to mind because it is easily remembered by the example:

$$(152) \quad \hat{i}\hat{j} = (\hat{i}\hat{j}\hat{k})\hat{k}$$

that relates the bivector $\hat{i}\hat{j}$ with the associate vector $\hat{i} \times \hat{j} = \hat{k}$.

(Note: this involved the faults and merits of Gibbs. He took the blame and the credit to understand that $a \wedge b$, born as bivector, was a vector, and as such he is in fact $a \times b$ and so the engineers deal with for example $\vec{E} \times \vec{H}$, as a vector).

This hides the true quality of the product of two orthogonal vectors, which are those of an entity bivector. However (151) make things right).

We extend the (151) to vector operator $\vec{\partial}_v$ (3D):

$$(98) \quad \frac{\partial}{\partial x} \hat{i} + \frac{\partial}{\partial y} \hat{j} + \frac{\partial}{\partial z} \hat{k} = \vec{\partial}_v$$

From (147) ... (150) we have successively

$$(152) \quad \vec{\partial}_v a = \vec{\partial}_v \bullet a + \vec{\partial}_v \wedge a = \vec{\partial}_v \bullet a + (\hat{i}\hat{j}\hat{k})(\vec{\partial}_v \times a)$$

and therefore the operators div and rot are "embedded" in the 'Clifford algebra through the relation:

$$(153) \quad \vec{\partial}_v a = \text{div} a + (\hat{i}\hat{j}\hat{k})(\text{rot} a)$$

Then immediately derive Maxwell's equations with div and rot.

From:

$$(6) \quad \partial^* F \hat{i} = 0 \rightarrow \hat{i} \partial^* F \hat{i} = 0$$

$$(7) \quad F \hat{i} = E_x \hat{i} + E_y \hat{j} + E_z \hat{k} + T_{ji} (H_x \hat{i} + H_y \hat{j} + H_z \hat{k}) \rightarrow F \hat{i} = \vec{E} + T_{ji} \vec{H}$$

immediately:

$$(154) \quad \left(\frac{\partial}{\partial x} \hat{i} + \frac{\partial}{\partial y} \hat{j} + \frac{\partial}{\partial z} \hat{k} + \frac{\partial}{\partial \tau} \hat{T} \right) (\vec{E} + T_{ji} \vec{H}) = \left(\vec{\partial}_v + \frac{\partial}{\partial \tau} \hat{T} \right) (\vec{E} + \hat{i}\hat{j}\hat{k} \hat{T} \vec{H}) = 0$$

Development and separation of the indices comes quickly:

$$(152) \quad \text{rot} \vec{E} = \frac{\partial \vec{H}}{\partial \tau}, \text{rot} \vec{H} = -\frac{\partial \vec{E}}{\partial \tau}, \text{div} \vec{E} = 0, \text{div} \vec{H} = 0$$

which are the Maxwell equations.

References

- [1] D. Hestenes “A unified language for Mathematics and Physics”, in “Clifford Algebras and their Applications in Mathematical Physics”, NATO ASI Series, Reidel (1986)
- [2] C. Doran et al.,”States and Operators in the Spacetime Algebra”, Found. Phys. 23(9), 1239 (1993)
- [3] D. Hestenes, “Space time algebra”, Gordon and Breach (1966)
- [4] S. Gull et al., “Imaginary numbers are not real – the geometric algebra of spacetime”, Found. Phys. 23(9):1175, (1993)
- [5] W. Pauli, “Teoria della relatività”, Boringhieri (1958)
- [6] M.I. Skolnik, “Radar Handbook”, Mc Graw Hill (1970)
- [7] S. Ramo, J. R. Whinnery, T. van Duzer, “Fields and Waves in Communication Electronics”, John Wiley (1994)
- [8] D. Hestenes, “Quantum mechanics from self – interaction”, Found. Phys. 15, 63-87 (1985)
- [9] D. Hestenes, “Zitterbewegung modeling”, Found. Phys. 23, 365-387,(1993)
- [10] D Hestenes, “The zitterbewegung interpretation of quantum mechanics”, Found. Phys. 20, 1213-1232 (1990)
- [11] D. Hestenes, “Clifford Algebra and the interpretation of quantum mechanics”, in “Clifford Algebras and their Applications in Mathematical Physics”, NATO ASI Series, Reidel (1986)
- [12] D. Hestenes, “Space-time structure of weak and electromagnetic interactions”, Found. Phys. 12, 153-168 (1982)
- [13] D. Hestenes, “Mysteries and Insights of Dirac Theory”, available on line at <http://modelingnts.la.asu.edu> .
- [14] D. Hestenes, “Spacetime calculus”, available on line at <http://modelingnts.la.asu.edu> .