

ATOMS

Vladislav Konovalov

Abstract

In the article the theory of hydrogen-like atoms is given and some details of an electron motion in atom are described

The THEORY of a HYDROGEN-LIKE ATOM

From this article it will become clear, that the modern theory of a hydrogen-like atom grounded on a quantum mechanics and the set up theory of atom of alternate new physics on relation to each other stands heels over head. Who from them stands on a head - to judge to the reader. The quantum mechanics is as a matter of fact suitable only for the description of atoms and their nuclei, since the behavior macro objects cannot be described by this theory - they "classic", and to elementary particles it is impossible to apply owing to, that: "...the quantum mechanics is not applicable to the description of processes described by the sizes of areas of their passing of the order 10^{-13} cm and less". (N.I. Kariakin etc. Brief reference book on physics. "Higher School", M., 1962, page 417).

Much from that is set up below, with success can be applied to the description of space systems.

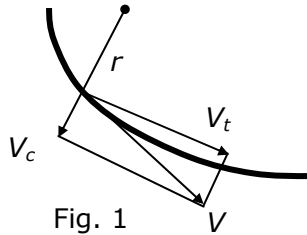

Fig. 1

The equation (2.2) [1] is deduced for circular orbits, when the velocity vector of an electron is perpendicular to radius - vector. For orbit of the arbitrary form (figure 1):

$$E_{ie} = -\frac{Ze^2}{r} + \frac{mV^2}{2} \quad (1),$$

where V - speed of a body on orbit.

The vector V on two related orthogonally components are decomposable: a tangential velocity V_t and centrifugal speed V_c so, that:

$$V^2 = V_t^2 + V_c^2 \quad (2).$$

In spite of the fact that the Bohr enabled a capability of motion of an electron with an aliquot moment of momentum and the modern physics approves it, we shall not sin against the fixed laws of the nature, especially fundamental. As the mobile electron has an angular momentum \hbar , it and remain to those on any orbit, including in a ground state (circular orbit). Earlier we were convinced that the principle of conservation of moment of momentum is fair even at motion of a body on a straight line. For an arbitrary trajectory of an electron (if an electron not relativistic), this law will look so:

$$V_t \cdot r = \alpha \quad (3).$$

By substituting (3) and (2) in (1), we shall discover:

$$E_{ie} = -\frac{Ze^2}{r} + \frac{m\alpha^2}{2r^2} + \frac{mV_c^2}{2} \quad (4).$$

The known law that a system aims at a minimum of potential energy and on achievement it is taken a steady (basic) condition, requires essential elaboration included therein, that thus there should be a dissipation of energy at a rate of a difference of energy in initial and ground state, i.e. the system should be opened, instead of insulated. If a dissipation of energy does not take place, bottom of a potential well the system can not achieve (for example, the pendulum will be rocked eternally) - it the energy conservation law requires. In mechanical systems the dissipation of energy takes place at the expense of friction, in space - at the expense of tidal and other forces, and in a microcosmos - at the expense of radiation of photons (or pairs an electron - positron, if the energy has enough for their formation). As only last term (4) distinguishes this equation from (2.2) [1], $\frac{mV_c^2}{2}$ is that reserve, from which one there is a dissipation of energy of an excited atom by radiation of photons.

$$\text{From (4): } V_c = \sqrt{\frac{2E_{tie}}{m} + \frac{2Ze^2}{mr} - \frac{\alpha^2}{r^2}} \quad (5).$$

Differentiated (5) on radius - vector and by equating a derivative to zero point, we shall discover, that maximum value V_c on a trajectory at $r = r_0 = \frac{m\alpha^2}{Ze^2}$, where r_0 - radius of a circular orbit in a ground state. By substituting this value in (5) and by agree that:

$$E_{tie} = KE^0 = -\frac{KZ^2e^4}{2m\alpha^2} \quad (6),$$

where E^0 - bond energy in a ground state, we shall discover:

$$V_c^{\max} = \frac{Ze^2}{m\alpha^2} \sqrt{1-K} = V_0 \sqrt{1-K} \quad (7),$$

where V_0 - the speed of an electron on a circular orbit, i.e. V_c^{\max} depends only on electron-binding energy.

Apparently, in this case, that energy of a photon:

$$h\nu = \frac{mV_{c1}^2}{2} - \frac{mV_{c2}^2}{2} \quad (8).$$

Converting (8) with the registration (6) and (7), we shall discover:

$$h\nu = E'_{tie} - E''_{tie} \quad (9).$$

The same outcome we can receive and from (2), recording it for two orbits with V_1 and V_2 and allowing, that V_t to both these orbits is identical. It is easy to show, that if $E_{tie}=0$, the trajectory of an electron for a nucleus will be a parabola, if $E_{tie}=E^0$ - circular orbit, and in all intermediate cases - elliptical orbits. For these orbits parameter of a parabola is peer to parameter of ellipses and is peer r_0 , i.e. all orbits are intersected in two points to a diametrically opposite nucleus. In one of these points (where V_c is directed from a nucleus) there is a radiation of photons (in opposite - occluding) and transition of an electron from one orbit on another.

Let's suspect, that in a point of radiation of a parabolic trajectory is beamed only one photon which is picking up completely energy $\frac{mV_c^2}{2}$ (at it an electron at once will pass on a circular orbit). In this case energy of a photon will correspond to ionization energy of atom (limit of a spectral serial Lyman). From a principle of conservation of moment of momentum, moment of an electron, bound with V_c should be transmitted to a photon (simultaneously it and condition that the photon can be beamed only in the whole kind), therefore:

$$(V_0 - V_c)r = N\alpha \quad (10),$$

where: N - the number of radiated photons, $V_0 = V_c^0$ in a point of radiation of a parabolic trajectory, since in it $V = V_0\sqrt{2}$, r - has mathematical sense of radius for satisfaction of a law of conservation of angular momentum (it not radius of motion of an electron):

$$mV_c \cdot r = \alpha \cdot m \quad (11).$$

We shall be now saved of it. From (10):

$$V_c = V_0 - \frac{N\alpha}{r} \quad (12),$$

By substituting in (12) r from (11), we shall discover:

$$V_c = \frac{V_0}{N+1} \quad (13).$$

Apparently, that number n of steady orbit, if not takes place of a further dissipation of energy:

$$n=N+1 \quad (14),$$

by substituting in (13), we shall receive:

$$V_c = \frac{V_0}{n} \quad (15).$$

Comparing (15) with (7), we shall discover K :

$$K = 1 - \frac{1}{n^2} \quad (16).$$

By substituting value K from (16) in (6), we shall discover bond energy in hydrogen-like atoms depending on n , it is impossible to consider which one for our case as that by a quantum number, that in orthodox physics:

$$E_{tie} = -\left(1 - \frac{1}{n^2}\right) \frac{Z^2 e^4}{2m\alpha^2} \quad (17).$$

Remaining - matter of technique. For example, by substituting (16) in (9) with the registration (6), we shall discover:

$$h\nu = E^0 \left(\frac{1}{n_1^2} - \frac{1}{n_2^2} \right) \quad (18).$$

Thus, the radiation of photons takes place at motion of an electron in a potential well, and quantize is determined only by integrity of a photon and to a stationary constitution of atoms of any relation has not. The repetition factor of an angular momentum of an electron in the theory of the Bohr and quantum mechanics has not relation to an electron, and is only consequent that for all photons the angular momentum same and is peer \hbar , and the photon can be released or to be occluded only in the whole kind.

In this connection of logic of official science is faulty in the respect that it, watching excited atoms, mechanically transfers outcomes on a constitution of stationary atoms. We would make the same error, making conclusions about character of the man, when is observed him in an extremely excited state. If to be precise, the quantum mechanics is compelled so to do, since the solutions of a Schrodinger equation do not enable any "orbits" of an electron, except for a definite set. New physics considers, that in a ground state in atom the position of orbits of electrons is determined by a minimum of potential energy of a system as a whole, and quantumness is exhibited only in excited states of electrons. Let's put here quotation from: "Physics of a microcosmos", "Soviet encyclopedia", M., 1980, page 183: "It is necessary to mark, that, strictly speaking, in a quantum mechanics all allowed condition of atom (received at the solution of the applicable Schrodinger equation) - both basic, and excited, are steady, stable. The instability of excited levels is conditioned by interplay of atomic electrons with a virtual electromagnetic field, or with photon vacuum (?!). Therefore for the consistent description of quantum transitions in atom accompanied by radiation, it is necessary to allow for this interplay".

As we see, orthodox physics completely freely can explain something more or less understandable absolutely not clear, identifying boundary of nonsense with an inaccessible horizon.

Using (16), (6) and (4), we can calculate all parameters of possible orbits of an electron around of a nucleus, which one are shown in table 1. It is made simply: being set value n , from (16) we discover K , we substitute in (6), we shall discover electron-binding energy with a nucleus on this orbit, which one we substitute in (4) and, deciding a quadratic equation relatively r , we shall discover a perihelion and aphelion of orbit.

n	Orbit	Energy of connection (in E^0)	Distance from a nucleus in perihelion (in r_0)	Distance from a nucleus in aphelion (in r_0)	Eccentricity, e
1	Lyman	0	1/2	∞	1
2	Balmer	3/4	2/3	2	1/2
3	Paschen	8/9	3/4	3/2	1/3
4	Bracket	15/16	4/5	4/3	1/4
5	Phund	24/25	5/6	5/4	1/5
...
∞	Bohr (ground state)	1	1	1	0
Relation from n		$1 - \frac{1}{n^2}$	$\frac{n}{n+1}$	$\frac{n}{n-1}$	$\frac{1}{n}$

The eccentricity of orbit can be found from a known polar equation of curves of the second order. "In polar coordinates the curves of the 2-nd order have an equation $\rho = \frac{P}{1 + e \cos \varphi}$, where P - focal parameter, e - eccentricity of the given curve, the pole is in focal point, the polar axis is directed from focal point to the proximate top". I.N. Bronstein and K.A. Semendiaev "Reference book on mathematics for the engineers and learner technical colleges", M., 1962, page 213.

We suppose in this equation focal parameter $P=r_0$, then:

$$r_p = \frac{r_0}{1+e} \quad (19), \quad \text{a} \quad r_a = \frac{r_0}{1-e} \quad (20),$$

where e - eccentricity.

Any other orbit parameters easily will be from known ratio for a parabola and ellipse.

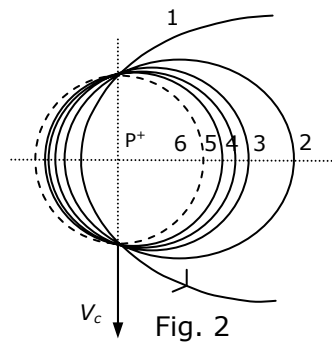

On a figure 2 five orbits of an excited state of atom of hydrogen (their infinite set) and ground state (dotted line) are to scale figured. By arrow V_c labels a place of transition from one orbit on another at radiation of photons.

On a figure: 1 - orbit of the Lyman, 2 - orbit of the Balmer, 3 - orbit of the Paschen, 4 - orbit of the Bracket, 5 - orbit of the Phund, 6 - orbit of the Bohr.

The transition of an electron on any orbit - business of its own desire, but transition on near orbit in connection with an inertness of an electron is more preferential, that determines large intensity of lines H_α in each spectral serial, specially for high-eccentric orbits. The sizes of atom in any excited state a little differ from sizes of a nonexcited atom, then, as the official science assigns progressive increase of the sizes of an excited atom. The quantum mechanics results in the same expression for energy of a hydrogen-like atom,

as simple theory of the Bohr: $E_n = -\frac{Z^2 e^4 m}{2\hbar^2} \cdot \frac{1}{n^2}$ (a) (N.I. Kariakin etc. "Brief reference book

on physics", "Higher School", M., 1962, page 408). Accordingly, radius of a hydrogen-like atom will be proportional to a square of a main quantum number n .

Both at interplay of gravitational charges and at interplay of electrostatic charges (if mass of a central charge is much greater orbital) the following ratio (virial theorem) is executed: $E_{rep} = E_{bond} = 1/2E_{att}$ (b), where E_{rep} - energy of repulsing, E_{bond} - bond energy, E_{att} - energy of attraction. If to accept for value of an angular momentum of an electron $\hbar = mVr$ (c), substituting this value in (a), we shall discover for a ground state of hydrogen-like

atoms under any theory (allowing, that $E_{rep} = \frac{mV^2}{2}$ (d)): $E_{bond} = -\frac{Z^2 e^4 m}{2m^2 V^2 r^2} = \frac{Z^2 e^4}{4E_{rep} r^2}$ (e).

By substituting (b) in (e), we shall discover: $E_{att} = \frac{Ze^2}{r}$, that corresponds to true. Thus, (c)

really is an angular momentum of an electron in atom, and (d) - universal energy of repulsing.

In any spectral series it is possible to count up to hundred lines (their actual quantity indefinitely), thus the size of an excited atom should be increased not less, than in 10000 times, that leaves for frameworks of sensible physical sense (as a matter of fact, the modern physics considers, that the size of an excited atom radiating photons of a limit of any spectral series, including infrared, is perpetual, but does not advertise it). Look in this article «Rydberg atoms».

If we have managed not only to arrange orbits of electrons in atoms in parallel planes (that it is possible to make with the help of a magnetic field), but also would make so that the big semi major axes of orbits too are parallel, the radiation of all atoms will be in space strictly distributed depending on energy of photons for given sort of atoms.

Now we shall demonstrate a regularity of a figure 2 and by that an inaccuracy of the official theory of atom. For this purpose at first it is necessary to determine tangents of slope angles tangents to orbits in transition points from one orbit on another. It is two intersection points of focal parameter P with ellipses. From known relations for an ellipse and allowing, that by the equation of focal parameter will be:

$$x_0 = C \quad (21),$$

where C - distance from centre of an ellipse before focus. Substituting (21) in the canonical equation of an ellipse and further in the equation by tangent to an ellipse in a point (x_0, y_0) after some transformations we shall discover:

$$tg\alpha = \pm C/a = e \quad (22),$$

where a - semimajor axis of an ellipse, e - eccentricity of an ellipse. Thus, the tangents of a slope angle of orbits in intersection points with focal parameter numerically are peer to a eccentricity of an ellipse, for example (see table 1) the orbit Lyman has a slope angle to a horizontal 45° , and orbit of the Bohr, naturally, 0° . Now it is easy to count up, as the energy of an electron will vary at radiation of a photon, using a law of conservation of impulse and calculating scheme introduced on a figure 3:

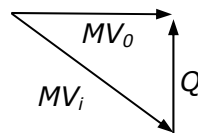

Fig. 3

On a figure 3: mV_0 - impulse of an electron on an orbit of the Bohr, mV_i - impulse of an electron on any other quasistable orbit, Q - recoil impulse received by an electron at radiation of a photon by atom. Thus, at transition of an electron from any orbit in a ground state in this state the impulse of an electron will be:

$$mV_0 = mV_i \cdot \cos\alpha \quad (23).$$

The change of energy of an electron will make:

$$\Delta E = \frac{m}{2}(V_i^2 - V_0^2) \quad (24).$$

By substituting (23) in (24), we shall receive:

$$\Delta E = \frac{mV_0^2}{2} \cdot e^2 \quad (25).$$

In (25) V_0 it is possible to determine by two equivalent manners: or from equilibrium of an electron on a circular orbit:

$$\frac{mV_0^2}{a_0} = \frac{e^2}{a_0^2} \quad (26),$$

or allowing, that the spin of an electron is peer \hbar (instead of half of this value!):

$$\hbar = mV_0 a_0 \quad (27),$$

where a_0 - radius of an orbit of the Bohr. To us is now more suitable (26) to substitute in (25) and to discover a difference of energies in eV. Simultaneously we shall substitute numerical values of constants and conversion factor an erg in eV ($e_e = 4.80286 \cdot 10^{-10}$ CGSE, $a_0 = 5.29172 \cdot 10^{-9}$ cm, $1 \text{ eV} = 1.60206 \cdot 10^{-12}$ ergs):

$$\Delta E = 13.605 \cdot e^2 \quad (28).$$

From (28) it is visible, that for an orbit of the Bohr ($e=0$) transitions to the same orbit do not change energy of an electron, and for an orbit Lyman ($e=1$) the photon with energy of an equal ionization energy is radiated. The same formula confirms the below-mentioned scheme of energy levels (fig. 4). For an orbit, for example, Balmer ($e=0.5$) at transition in a ground state the photon with energy 3.401 eV will be radiated, and that from this orbit to ionize atom it is necessary to expend energy $13.605 - 3.401 = 10.204$ eV.

From a figure 3 it is easy to receive the formula (28) on change of a kinetic energy of an electron at transition to a stationary orbit if to take into account, that $mV_0 = mV_i \cdot \cos \alpha$:

$$\Delta E = \frac{mV_i^2}{2} - \frac{mV_0^2}{2} = E_0 \cdot \cos^2 \alpha = E_0 e^2 \quad (28a).$$

The formula (28a) displays, that the radiation of atom is a braking radiation. The electron loses a kinetic energy along an orbit, therefore photon is radiated perpendicularly to it.

The formula (28) allows considering with what level electrons transfer in a ground state at heat exchange at any temperature, utilizing the law Wien. We shall copy it for energy of a photon relevant to a maximum of radiation at a Kelvin temperature T expressed in eV:

$$E_{max} = 0.42809 \cdot 10^{-3} \cdot T \text{ eV} \quad (29).$$

By substituting (29) in (28) thus at (28) instead of eccentricity we shall substitute its expression through the number of an orbit from table 1:

$$n = \frac{178,27}{\sqrt{T}} \quad (30).$$

From the formula (30) it is visible, that for $n=1$ (thus there occurs thermoionization of hydrogen) temperature 31780^0 is necessary. At ambient temperature (293^0K) the heat exchange in basic is yielded by photons radiated at transition in a ground state from the orbit N^o 10, and "relict" radiation (at $T=2.7^0\text{K}$) from an orbit N^o 108. These calculations display that at heat exchange the electrons are near to a ground state. In a considered occasion official physics anything intelligible to tell can not.

We have considered "fall" of an electron on a proton in a plane of normal section of a screw trajectory of a mobile electron. Precisely same result we shall receive and at "fall" of an electron on a proton lengthwise axis of screw trajectory of a mobile electron, i.e. in a perpendicular direction. Therefore, the same result will be and at "fall" under any arbitrary angle. Really, we shall start up an electron up to energy; equal potential of an atomic ionization of hydrogen, then under the formula (2.10) [1] radius of a screw trajectory of such electron will be precisely to correspond to radius of a stationary orbit of an electron in atom of hydrogen. If such electron "will put on" on a proton, beforehand by losing an ionization energy, since the energy of its headway is peer to energy of a motion on coils of a screw trajectory, it will appear at the bottom potential wells, nothing differing from the electron which has hitting there from a perpendicular direction. Certainly, the differences of these two electrons can be noted on thin structure of spectral lines, since the slope angles of circumgyration axes of electrons and their precessional movement (both electrons and their orbits) will be various. These two trajectories of a motion of an electron to a nucleus differ as well by that in first case of the photons are radiated in orbital plane, and in second - in a perpendicular direction, that is exhibited in effects (longitudinal and cross) Zeeman and Stark. Superimposing an exterior magnetic field on radiating substance (Zeeman

Effect), we orientated orbits perpendicularly to field. Therefore at one motion of an electron all orbit under activity of force of the Lorentz a little is squeezed, and at an opposite motion of an electron - is dilated. Then we shall watch a spectral line not f_0 , and $f_0 \pm \Delta f$ in radiation along a field. At radiation across a field the same force of the Lorentz brakes transition of an electron to the necessary orbit with higher and accelerates an electron at transition with lower. Thus, the frequency shift of photons is compensated and across a field are watched three components $f_0 \pm \Delta f$ and f_0 , and f_0 (π -component) twice more intensive $f_0 \pm \Delta f$ (σ -components). If a field feeble, neutralization can be incomplete and then we shall to watch some additional lines (abnormal Zeeman Effect).

The gravidynamic aspect above-stated is, that in length of any orbit of an electron one wave length de Broglie is stacked only, instead of the multiple, as is considered by a modern physics, if not to allow of multiquantum occluding at an intensive laser radiation (see for chapter rydberg atoms).

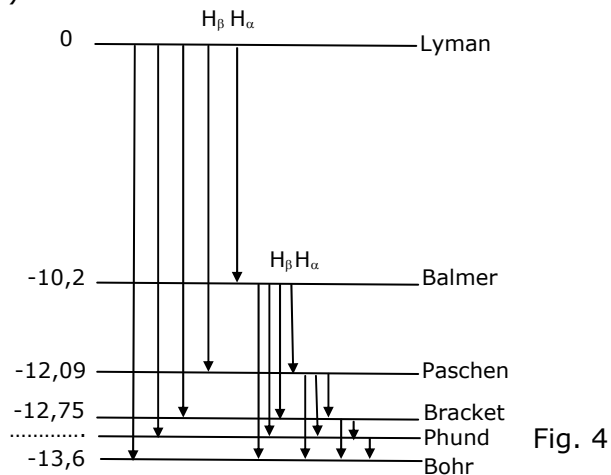

The energy levels of atom of hydrogen are shown on a figure 4. In matching with official representations, they are figured to within on the contrary, i.e. be posed from a head on legs and that is why. The law of the Kirchhoff stating, that the substance immerses those spectral lines, which one it radiates - fixed experimental fact. The atoms immerse the same lengths of waves, which one emits is a law of the Kirchhoff (1824-1887) and Bunzen (1811-1899). With this fact the level diagram ϕ иг. 4 is completely co-ordinates. For example, to receive an absorption line in a series of Phund, it is necessary to irradiate hydrogen with infrared rays with energy of photons less than 0.6 eV. Official the science assigns for deriving an absorption line in this series beforehand to excite atom by energy not less than 13.1 eV, and that and at all to ionize atom that enters a glaring contradiction with experiment. The exit of this inconsistency can be seen by own eyes in oof of paints of a surrounding world, be the official version of energy levels of electrons in atoms valid, and all paints here will vanish. About this inconsistency prefer to keep mum, since differently will be destroyed not only modern theory of atom, but also all quantum mechanics and will become vain those grandiose efforts, which one were spent for adjustment of the theory under experiment.

The energy levels of an excited atom should be densely arranged near to the basic nonexcited state; differently equilibrium thermal radiation is impossible. At standard conditions all atoms are in a ground state and that they could something radiate, the electrons need to be transferred even to the first excited level. If to accept on a faith the official scheme of excited levels, that the substance radiated, it needs to be heated on tens thousand degrees (10.2 eV for transfer of an electron of hydrogen in the first excited state corresponds to temperature approximately 100000⁰K). In the tendered scheme of energy levels it is enough for excitation of atom infinitesimal of action; therefore equilibrium thermal radiation of substance is possible down to temperature of absolute zero.

The official notions about energy levels considerably differ from introduced on a figure 4. The orthodox physics gives the following scheme of levels of energy in atom of hydrogen (see, for example, B.M. Javorsky and A.A. Detlaph "Manual on physics for the engineers and students of high schools", "Science", M., 1964, page 671).

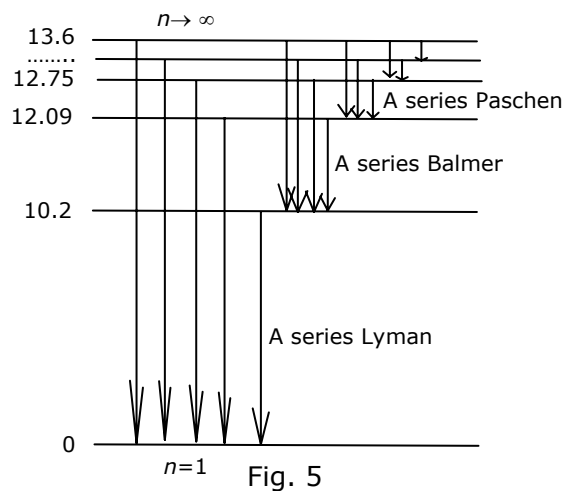

Fig. 5

The formula of the Planck for emitting ability of an ideal black body can trust not only owing to its correspondence to experiment, but also because from it as the corollary is gained the law Stephen - Boltzmann and Wien displacement law, which one also correspond to experiment. Therefore all spectrum of a thermal radiation is determined by transitions of electrons from one energy level on another. Thus has not value, whether such transitions in solid bodies, fluids either gases in molecules or separate atoms are carried out. For simplicity we shall consider a thermal radiation of atomic hydrogen. On notions of a modern physics to transfer atom of hydrogen in an excited state, the minimum portion of energy in 10.2 eV is indispensable. Thus the electron will transfer on the second level. At returning in a ground state the atom will radiate one most long-wave line of a series Lyman ($1215.68 \cdot 10^{-8}$ cm). In a radiation spectrum we are more any other lines we shall not find out. To the indicated energy there corresponds temperature of an atomic hydrogen 78916 °K. In the chapter dedicated to photons is shown, that the energy not less $5kT$ is necessary for formation of a photon. This fact enables simply to receive a Wien displacement law: $\lambda_{max} \cdot T = 0.2896$. For this purpose we shall note a requirement of formation of a photon: $5kT = h\nu = hc/\lambda$, whence $\lambda_{max} \cdot T = 0.2878$. At house temperature (293 °K) the minimum energy for formation of a photon is indispensable as a particle $5kT = 0.1267$ eV. From these calculations it is visible, that the heat exchange by radiation and capture of photons at house temperature is impossible since the indispensable energy for this purpose in 80 times exceeds stock. Thus, the scheme of levels of atom of hydrogen of official physics is erroneous, since does not ensure heat exchange by radiation and does not correspond to a Planck formula. The scheme of levels introduced on a figure 13.4 indicates absolutely other behaviour of an electron in atom. For transfer of atom in an excited state the thermal energy even near to absolute zero of temperature suffices. To transfer an electron to the same second energy level the energy not 10.2 eV and 3.4 eV is necessary. Thus the electron will take an orbit Balmer, and in radiation we shall not see lines of a series Lyman, but completely all series, starting from a series Balmer and finishing a series of radiation in radiofrequency region. As near to an orbit of the Bohr the energy levels are arranged very densely, the discernibility of levels will depend on temperature of hydrogen and, with depression it, we can discover more and more close to a ground state of a line of radiation. The radio-frequency spectral lines in thousand times are feebler than spectral lines of optical range because of very small energy of quantum. Besides they can be watched only on a background of a more intensive continuous spectrum as hardly distinctive peaks. Under the literary data (for example, "Physics of space", Moscow, 1976, page 484) following radio-frequency spectral lines of hydrogen are experimentally retrieved (in brackets the transition between the numbers of energy levels relevant to this radiation is indicated) ~3.4 cm (90→91), ~5,2 cm (104→105), ~6 cm (109→110), ~18 cm (156→157, 157→158). Results of calculation of a wave length of a radio-frequency radiation at the indicated transitions and according to the tendered scheme of energy levels: 90→91 3.37 cm, 104→105 5.20 cm, 109→110 5.98 cm, 156→157 17.49 cm, 157→158 17.8 cm. Concurrence to an apparent wave length not incidentally since the numeration of levels of energy in official and new physics is identical, but the arrangement them is opposite. Here it is necessary to remind to the reader, that on notions of official physics radius of atom is

proportional to a square of a main quantum number (in this case - number of a level). Therefore for a level of 158 radius of atom of hydrogen will be increased in 25000 times and will make 1.32 microns, i.e. it can literally be felt. These data indicate that the modern theory of atom is erroneous. E.M. Gershenzon in the article «Research of single atoms» (Soros Educational Journal, № 1, 1995) cites data, that the minimum energy quantum, observed in radioastronomical experiments, at transitions between high excited states of carbon atoms at $\lambda = 18$ m corresponds 10^{-19} ergs. Radius of such atom will make 28 microns at a main quantum number $n = 733$. Energy of electron connection will be $3.34 \cdot 10^{-17}$ ergs. It is easy to count up, that the indicated energy will be had with quanta of a maximum of a black-body radiation at temperature 0.242 K. Therefore any photon of relict radiation ionizes under consideration atom. Allowing huge concentration of relict photons the atoms with high excited states do not have any chances to keep integrity. Allowing, that the atoms beam photons with energy of relict radiation (2.7 K) from orbit № 108 (see. the formula (30)), the existence of neutral atoms with quantum numbers is higher 100 it is impossible because of their ionization by relict radiation. The reduced data demonstrate a regularity of a system of energy levels of atoms tendered new physics and inaccuracy of a quantum mechanics in the fundamental initial concepts. All inconsistencies with experiment fade if to allow for insipidating energy levels near to a ground state instead of far from it. Then, in this case, the speech is necessary for a message not about highexcited atoms, and about very «cold» with temperature is not higher 0.2 K.

Introduced on a figure 4 scheme of energy levels explain also relative intensity of spectral lines, which one in due time have hurried to pronounce indefinable in model of the Bohr. Let's suspect that the electron is on an orbit Lyman and comes nearer to a point of radiation. In this point the electron should pass on more close to a ground state an orbit, but the transition probability is various, as is bound to necessity of deriving of an indispensable recoil impulse at radiation of a photon. Maximum likelihood to pass to an adjacent orbit, thus the most long-wave and intensive line from a series Lyman is radiated. Prolonging this process of series transition on adjacent orbits, we shall receive the most intensive lines of all possible series. Apparently, that the intensity of these lines gradually decreases, and the lines of a far infrared series practically do not differ on intensity because of a small difference in energy of levels. In radiated system of atoms always there will be such in which one an electron has transferred on any level, but in total of atoms a share of atoms in which one the electron has taken at once close to a ground state levels will decrease since probability of such transition small. Therefore in a given series intensity of spectral lines in the side more short waves decrease, and the lines near to a limit of a given spectral series practically do not differ on intensity.

To a critic of the official scheme of energy levels of atom of hydrogen it is possible to add following. Let's suspect that we supervise all completely series Balmer. Apparently, that on notions of official physics the electrons given this series everyone are on the second energy level and they nothing need to do as, to pass in a ground state with radiation α -lines of a series Lyman. Therefore intensity by this α -line should be not less summary intensity of all lines of a series Balmer that does not correspond to a real. Besides the returning force, proportional tangent of a slope angle of the graph of a potential energy, far from bottom of a potential well is significant, and it a ground state (at the bottom potential wells) is peer to zero point. Therefore any small external action outputs system from equilibrium because of an insipidation of energy levels for bottom of a potential well. The scheme of energy levels of orthodox physics explicitly contradicts the law of conservation of energy. Let's suspect, that we irradiate hydrogen with photons relevant to a limit of a spectral series Humphry (0.38 eV). These photons hydrogen is obliged to absorb under the laws of radiation. Thus the electrons of atoms will place close $n=\infty$. How they itself behavior in further? Apparently, that they will give all possible spectral lines of all spectral series including a line relevant to a limit of a series Lyman (13.6 eV). Thus, our device, immersing small energy, will yield big of anything. It is a hard blow on orthodox notions. It is necessary to throw out in a waste basket all crazy theoretical gorges XX centuries, to return for hundred years back and to start all from a beginning. All modern physics represents a pyramid, standing sharp end on a basis of energy levels of atom of hydrogen. The author managed now to take out this basis.

To put the last point in an arrangement of energy levels of atoms, we shall find out physical sense of the known formulas of a thermal radiation of an ideal black body. The

formula Raleigh - Jeans for a spectral density of an emittance of an ideal black body looks like this:

$$r_{0,\nu,T} = \frac{2\pi}{C^2} \nu^2 kT \text{ ergs/cm}^2. \quad (31).$$

Let's look, in what the physical content of this formula from a point of view of new physics consists. For this purpose we shall copy (31) through a wave length of radiation:

$$r_{0,\nu,T} = \frac{2\pi kT}{\lambda^2} \quad (32).$$

The new physics states, that the wave length of a photon is peer to a circumference of a cross-section of its screw trajectory:

$$\lambda = 2\pi r \quad (33),$$

where r - radius of a screw trajectory. Substituting (33) in (32), we shall discover:

$$r_{0,\nu,T} = \frac{kT}{2\pi r^2} \quad (34).$$

Thus, the formula Raleigh - Jeans describe a thermal energy of one degree of freedom (along a trajectory of a photon) coming on a cross-sectional area of a trajectory of a photon.

The formula of the Planck for a viewed case:

$$r_{0,\nu,T} = \frac{2\pi h\nu}{C^2} \nu^2 \cdot \frac{1}{e^{\frac{h\nu}{kT}} - 1} \quad (35).$$

The formula (35) differs from (31) factor:

$$f(\nu, T) = \frac{h\nu / kT}{e^{\frac{h\nu}{kT}} - 1} \quad (36).$$

As a matter of fact factor (36) exchanges in (31) thermal energy on energy of a photon, and the denominator of this factor allows for a Boltzmann distribution law on energy levels near to a ground state of electrons. I shall remind, that the new physics considers, that here levels are strongly inspissated, therefore separate lines of radiation at transitions of electrons on these levels merges in a continuous spectrum. Only from here there are photons of a thermal radiation, and the orthodox physics can not answer a problem, such photons whence appears.

Now we shall understand with a "excited" electron and we shall look, whether it can radiate or to immerse photons, and also "to bear them with itself". The term "an excited electron" is extremely unsuccessful for the reason that the excited electron on the structure by nothing differs from not excited. On the other hand, it is completely inapplicable to such super excited electron, which one at all has come off atom, i.e. to a mobile electron. Relating an opportunity of radiation or absorbing of photons with change of a kinetic energy of an electron, rotary around of a nucleus, we doom ourselves to an infinite walk on a maze of logic docks, without any hope to find any exit. Therefore it is necessary at once to refuse viewing a kinetic energy of an electron, and to consider as its universal potential energy of repulsion. In this case we are forced to view all associates on interaction, i.e. system: an electron - nucleus (atom as a whole). The viewing of a potential energy only of electron without the associate on interaction is senseless. Analogy to an electrical oscillatory circuit radiating a radio wave here is pertinent. Without change of a potential energy of an electric field in the condenser and potential energy of a magnetic field in an inductance coil the radiation is impossible. At the same time, radiates radio waves a oscillatory circuit as a whole, instead of its any part. Thus, radiates or immerses photons atom as a whole, instead of its any part, and electron photons with itself has not.

The repetition factor of value \hbar of a moment of momentum of an electron on a "allowed" orbit as a matter of fact means, that the electron in accordance with transition to more high-altitude orbits is covered by the increasing number of photons, more correctly by their moments of impulses. As the jumps at once through some levels are possible, it means, that some photons with small energy, combining, give a photon with big energy. In this case non-radiating transitions should not be watched. Apparently, that the similar notions

are erroneous - moment of momentum of an electron on "allowed" orbits is identical except for circular orbits with an aliquot angular momentum for of rydberg atoms.

Comments of the author: 1. The orthodoxes themselves have put a bomb under a quantum physics.

In connection with elaboration lasers the existence so-called of rydberg atoms was revealed. They metastable also exist in a very rarefied space gas cloud. In natural earth conditions they will not be formed. The principle of their formation is simple and obeys to the theory of atoms of the Bohr. The atom occludes a photon with angular momentum $h/2\pi$. The photon fades, and its energy is transmitted to an electron, which one will take higher energy level concerning a ground state. The angular momentum of a photon can not vanish together with it, and is transmitted to an electron. Thus, at series occluding of photons the orbital electron is allotted with a multiple of moments of a photon, that completely corresponds to the theory of the Bohr. The levels of energy are inspissated far from a nucleus. In this chapter the theory of atoms is given, where the levels of energy are inspissated near to a ground state and is shown, that these notions adequately mirror experimental observations. Both theory of the Bohr, and theory of atoms of a quantum physics are applicable only for of rydberg atoms. The orthodoxes so endeavours to adapt the theory under the final formulas of the theory of the Bohr (thus incriminating last in an inaccuracy), that have not noticed, how have put a bomb under a quantum physics. Soon they realize the error, but the clock-work already ticks and hardly will manage something to be collected from wreckages of a modern wave quantum mechanics. Apparently, that the favourite method of the low schoolboys of adjustment under the answer this time with adult uncles has played a malicious joke.

Some particulars of an electron orbital motion

The velocity of an electron on an orbit of the Bohr is peer $2.1877 \cdot 10^8$ cm/sec. On any excited level the electron on the average is 10^{-8} sec. For this time it transits on an orbit more than 2 cm or does about 66 millions revolutions around of a nucleus. At each revolution the electron has chance to pass on higher or more low level, including at absorption by atom of a thermal radiation. Therefore except for Doppler expansion of spectral lines at the expense of heat motion of atoms there will be an expansion of lines at the expense of "jar" of an electron on any of time orbits, which one represent a composition from numerous close of arranged sublevels, on which one the electron skips at orbital motion. At transition of an electron to more low level it as a matter of fact from a casual sublevel more the high level transfers on a casual sublevel more low level. The miscellaneous atoms radiate thus photons by close each other, but not equal energy, that gives in expansion of a spectral line in some correspondence with a radiation spectrum of an ideal black body.

As the potential energy of repulsion depends on distance from nucleus, stronger than the potential energy of an attraction, at transition of an electron from one orbit on another because of an electron inertia an electron oscillates about a stable orbit. At removal from a nucleus the repulsive force decreases also sharply attractive force returns an electron on an orbit, and at approach to a nucleus a repulsive force is incremented sharply.

Birth of photons at formation of hydrogen atom.

The theory of atom of the Bohr envisages aliquot value of angular momentum of an electron on steady orbit:

$$m_e v r = n \hbar \quad (37).$$

The wave mechanics too is convinced a capability of aliquot value of electron angular momentum. In this occasion new physics has following opposition.

Law of conservation of angular momentum one of the fundamental laws of the nature. Neither for the Bohr, nor in a quantum mechanics is not illustrated, whence for an electron the infinite number of moments arises, as the quantum number n theoretically can be infinite. Whence there are these moments? Below is shown, that for impart to a particle of angular momentum it is necessary to expend definite energy. Where there is a source of

this energy in official physics? If this source do not indicate, it means direct violation of one of the fundamental laws, since in this case angular momentum arises from nowhere.

In this article is shown, that a reserve for birth of photons at formation of hydrogen atom is the kinetic energy E_c , bound with radial component motions of an electron V_c in relation to a nucleus:

$$E_c = \frac{m_e V_c^2}{2} \quad (38).$$

At radiation of photons the radial velocity of an electron decreases in an integer of time in relation to maximum radial velocity, which one is reached apart of radius of orbit of the Bohr and becomes of an equal orbital velocity V_0 of an electron on this orbit (formula (13)):

$$V_c = \frac{V_0}{N+1} \quad (39),$$

where N - number of radiated photons. By substituting (39) in (38), we shall receive:

$$E_c = \frac{m_e V_0^2}{2(N+1)^2} \quad (40).$$

The formula (40) demonstrates, that with each radiated photon kinetic energy, bound with radial velocity of an electron, decreases fourfold. For example, at radiation of the first photon E_c becomes equal: $13.6054 = 3.4$ eV, and energy 10.2 eV takes off a photon. At $N \rightarrow \infty$ this kinetic energy is spent completely for formation of photons and there is only kinetic energy, bound with a tangential velocity of an electron on a circular orbit E_r :

$$E_r = \frac{m_e V_0^2}{2} \quad (41),$$

where V_0 - orbital velocity of an electron in a ground state.

To create a photon, it is necessary to impart to it angular momentum on a screw trajectory and to expend the same energy for impart translational motion on this trajectory. It is known, that the kinetic energy of a rotated body E_{rot} is determined by the formula:

$$E_{rot} = \frac{J\omega^2}{2} \quad (42),$$

where: J - moment of inertia of a body, ω - angular rotating speed.

In (42) we shall decrypt in applying to a photon a moment of inertia it on a screw trajectory and connection of peripheral speed at rotation on an coil (equal speed of light) with radius of an coil:

$$E_{rot} = \frac{m_{ph} \cdot cr_c \omega}{2} \quad (43),$$

where: m_{ph} - mass of a photon, c - speed of light, r_c - radius of an coil of a screw trajectory of a photon. Allowing, that the angular momentum of a photon is peer \hbar , and $\omega = 2\pi\nu$, where ν - frequency of the revolution of a photon on a screw trajectory, the formula (43) to become:

$$E_{rot} = \frac{h\nu}{2} \quad (44).$$

Apparently, that for translational motion it is necessary to a photon to give the same energy, since tangential and forward speed on a screw trajectory are peer. Then energy of a photon:

$$E = h\nu \quad (45).$$

Thus, we have defined a power source for originating photons, and have found a principle of consumption of this energy.

Official physics is afraid directly to state, that the motion of an electron in atom is orbital motion. As soon as it recognizes it, automatically falls under wheels of the own machine, by which one it has crushed the theory of the Bohr. At the same time without any confusion considers a spin-orbit interaction, though on its notions of orbital motion of an electron should result in to continuous energy loss at the expense of radiation. Electron orbits in atom, both under the theory of the Bohr, and on a wave mechanics circumferential, i.e.

radial component orbital velocities misses and there is no incentive for an electron to come nearer to a nucleus. It is necessary to attract the far-fetched interplay with vacuum to explain instability of excited states of atom. For many reasons official physics is under the necessity to refuse visual notions. But just the visual notions are the basis of logic, including the physical logic. The waiving them is equivalent to analysis of a surrounding world with the knotted eyes.

As atoms are forms

If the electron comes nearer to a "bare" nucleus, having in perpetuity zero velocity, its velocity is incremented up to value "of the second solar escape velocity", the trajectory becomes parabolic, and it again leaves in perpetuity. If the initial velocity was not zero, the trajectory will be hyperbolic. From this point of view an electron capture with formation of atom the same as also capture of space bodies are impossible. This corollary of the law of conservation of energy. That the capture has taken place, even the small power loss by an electron is indispensable. The universal power loss in a similar case, both for space bodies, and for an electron is identical: transmission of a part of an impulse to all system as a whole. For space bodies it is an alone expedient of capture and further evolution of an orbit. For an electron there is an opportunity to lose exuberant energy with a radiated photon. But the radiation does not cancel power loss by transmission of a part of an impulse, which one it is impossible to avoid. Let's enter concept of excess velocity of an electron. The excess velocity is a difference between velocity in pericentre of an elliptic orbit V_p and velocity on a circular orbit V_0 or orbit with a smaller eccentricity V_{p2} :

$$V_{exc} = V_p - V_0 \quad \text{или} \quad V_{exc} = V_{p1} - V_{p2} \quad (46)$$

Angular momentum of an electron:

$$r_p m V_p = \hbar \quad \text{и} \quad r_0 m V_0 = \hbar \quad (47).$$

From (47):

$$\frac{V_p}{V_0} = \frac{r_0}{r_p} \quad (48).$$

In (48) we shall substitute (46) and known expression for distance up to pericentre (19). After small transformation we shall discover expression for an eccentricity of orbit:

$$e = \frac{V_{exc}}{V_0} \quad (49).$$

If the electron had initial velocity peer to zero point, it before capture will gain excess velocity V_0 , the eccentricity is peer 1, a trajectory parabolic and the capture is impossible. Radiation of a photon and the transition to more low-altitude orbit though is possible, but is unlikely, since the electron is near to a nucleus only $0.5 \cdot 10^{-16}$ sec. However as a result of interaction with a nucleus the electron has gained some impulse, what its part will transmit to a nucleus, we now find out. On a law of conservation of impulse:

$$mV_{exc} = MV_M - mV_p \quad (50),$$

where MV_M - impulse received by a nucleus mV_p - stayed "exuberant" impulse of an electron.

The energy balance:

$$mV_{exc}^2 = MV_M^2 + mV_p^2 \quad (51).$$

Solving jointly (50) and (51), we shall discover:

$$V_p = V_{exc} \frac{M - m}{M + m} \quad (52).$$

Thus, the electron has lost a small part of the energy. But it is quite enough of it that the parabolic trajectory was turn into elliptic, i.e. there was an capture. For second and subsequent revolutions around of a nucleus:

$$V_{exc} = V_0 \left(\frac{M - m}{M + m} \right)^N \quad (53),$$

where N - speed around of a nucleus. By substituting (49) in (53) we shall discover, as the eccentricity of orbit varies:

$$e = \left(\frac{M - m}{M + m} \right)^N \quad (54).$$

The calculation on (54) gives following values of a eccentricity after the first revolution around of a nucleus: for hydrogen $e_H = 0.99891$, for uranium $e_U = 0.9999953$. Despite of a huge difference between masses of uranium nucleus and electron transmitted to a nucleus an impulse quite is appreciable.

The third Kepler's Law can be conversed to a view:

$$T = \frac{T_0}{\sqrt{(1 - e^2)^3}} \quad (55),$$

where T - period of rotation on an elliptic orbit, T_0 - period of rotation on a circular orbit.

The calculation on (55) with the registration (54) gives a period of rotation on the first revolution around of a nucleus for hydrogen $1.49 \cdot 10^{-12}$ sec, and for uranium $0.622 \cdot 10^{-12}$ sec. Also it is easy to count up, how much energy will be lost by an electron after the first revolution: $\Delta W = 13.6(1 - e^2) = 0.03$ eV. It is interesting to count up, how many revolutions around of a nucleus should be given by an electron, that from an orbit Lyman to pass on an orbit Balmer. For this purpose in (55) we shall substitute indispensable numerals: $0.5 = 0.99891^N$ whence $N = 636$ revolutions. As much of sublevels will be between these two levels. The density of sublevels is incremented on more low-altitude orbits since the impulse, transmitted to a nucleus, with each revolution decreases. The presence of numerous sublevels in energy levels of atom causes an continuous spectrum after a limit of any spectral series. Explanations of official physics, that the continuous spectrum after a limit of a spectral series is stipulated by that the electron before capture has some energy, are erroneous since such electron can not be captured, will not lose yet this exuberant energy. Besides from a point of view of official physics it is not clear, how the electron in atom in some cases can appear between energy levels. Now it is necessary to answer a problem: why at transition of an electron from one level on another the photons are radiated, and at transition with each revolution from one sublevel on another we not visuals photons? At transition on levels the excess velocity of an electron decreases in an integer of time, that causes considerable change of energy of an electron.

If the atom "has missed" to radiate a photon, while the electron was at a given level, it prolongs to be lowered on sublevels, the not following opportunity will not appear yet to radiate a photon. At transition on each revolution from one sublevel on another (to skip through them an electron can not) the energy of an electron varies lightly, that is shown above, therefore it as a matter of fact transfers non-radiating in energy of heat motion of atom in the whole. Photons in this case are radiated mediate because of a thermal exchange of radiation under the law of the Planck.

In conclusion of this section it is necessary to mark, that the author can not accept many concepts of a modern physics, them to not number, here only some: a centripetal acceleration, S-electrons, spin, Pauli's exclusion principle, indeterminacy principle of the Heisenberg, tunnel effect, laws of a microcosm, quantum mechanics, independence of apparent velocity of light of a motion of the spectator, contortion of space, deceleration of a course of time, black holes etc. If fully to shock this or that branch of physics, these concepts burst, as the soap bubbles, but not on one, and on a chain, which they are bound. Watching this picture, involuntarily it would be desirable to supplement the J.J. Thomson by that by most relevant for science by service is not only introduction of new ideas, but also comprehension of the perversity old.

Atom of hydrogen

Wave quantum mechanics. On notions of official physics, the potential well for an electron near to a proton has a view shown on a figure 6 (to the left of proton a picture is symmetrical).

Pay attention to that the walls of a pit in each point have miscellaneous curvature and are not perpendicular anywhere to any level of energy. In three-dimensional space the potential well will look as an orb with a proton at centre for a certain potential energy. For other level of energy radius of an orb will be more or less depending on a standing of this

level. What view will in space more than three-dimensional know only perverters of sensible physical sense.

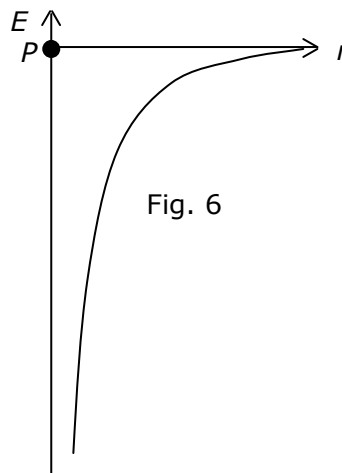

For this problem again will utilize a stationary Schrodinger equation, that means, that in space between a wall of a potential well and proton the system of standing spherical waves should be formed. Thus, in atom of hydrogen each chunk of the particle, sliced on a part, swollen as a bubble and these bubbles are inserted each other. But because of curvature of walls of a pit the reflected wave can not be spread in precision on a direction of an incident wave, i.e. the formation of standing waves anywhere is impossible. The formation of standing waves in official physics also prohibits a principle of indeterminacy of the Heisenberg, since at reflection from a wall of a potential well the position of a particle is known precisely, but neither direction of an impulse of a particle, nor its value it is impossible to point. It concerns not only problem concerning to atom of hydrogen, but also all problems, the solutions which one are grounded on a Schrodinger equation. On this warrant it is possible to state, that this equation is useless because it could not be applied. It is confirmed also by results of applying of a Schrodinger equation to atom of hydrogen. Thus the levels of energies condensed to a state of a mobile electron are gained.

There is one more principled difficulty for a wave quantum mechanics, which one is forced always to be address to standing waves to remain quantum. In a loop of a standing wave the slice of a charged particle oscillates across a wave and represents an electric dipole, radiating electromagnetic waves, the radiation which one is directional along a wave. Therefore energy of a particle should promptly be diffused, and the radiation spectrum will be continuous. Official physics puts from an ill head on healthy, shifting this principled difficulty on circular motion of an electron around of a nucleus, comparing this motion with an electric dipole. It is possible to point and one more principled difficulty for a wave quantum mechanics and on it enumeration of difficulties we shall conclude, for funeral already will suffice. Applying for a viewed problem the stationary equation, naturally, is gained also the stationary solutions - stable levels of energy in atom of hydrogen. But actually ground state is stable only, at remaining levels of energy the electron is not impeded more than 10^{-8} seconds. Therefore it is necessary to attract one more "invention" of orthodox physics - "virtual particles of empty space", that how to explain stability of energy levels.

Classic mechanics. In chapter 2 [1] the formula for radius of an orbit of an electron in a hydrogen-like atom (2.3) [1] and electron-binding energy with a nucleus (2.4) [1] is received on the basis of only classic notions not attracting quantumness in any view.

Corpuscular quantum mechanics. In a start of this chapter enough detail this problem is developed. Therefore here it is better to be stopped on some circumstances of the theory of atom. For this purpose we shall take advantage of the data of table 1 and figure 2. It is as a matter of convenience, the part of a figure 2 in the simplified view is shown on a figure 7.

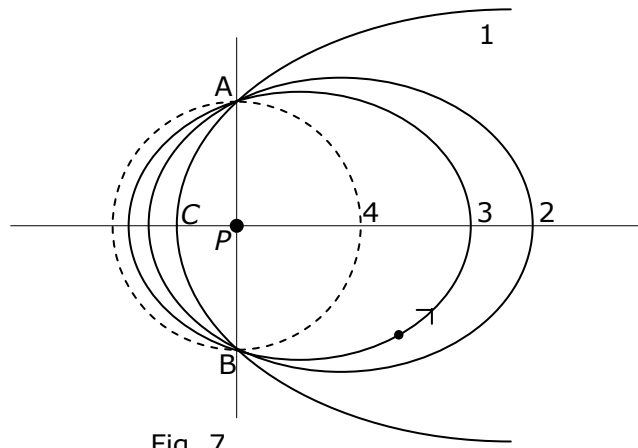

Fig. 7

Ground state of an electron on a circular orbit of the Bohr 4, shown a dotted line. We visualise, that the electron at a motion on elliptic orbits oscillates concerning an orbit of the Bohr, coming nearer to a proton (in pericentre), being deleted from it (in an apocenter). Thus, the electron represents an oscillator with equilibrium point continuous to an intersection point to an orbit of the Bohr (of the points A and B). Here it has maximal radial velocity and maximal kinetic energy, bound with this velocity. In points of pericentre and apocenter of an orbit the radial velocity of an electron is peer to zero point and it has a maximal potential energy in these points (concerning an orbit of the Bohr). Apparently, that if the electron in a point A will have a kinetic energy more than 13.6 eV, it will be moves on a hyperbolic orbit through a point A, in pericentre between a point C and proton and through a point B. On a braking phase AC to be captured, the electron is obliged to have time to radiate a photon with energy even hardly more its exuberant energy relatively 13.6 eV to pass in a point B to an elliptic orbit. The provisional time diagram of change of a potential energy at oscillations of an electron concerning an orbit of the Bohr is shown on a figure 8 for the first three values of a quantum number.

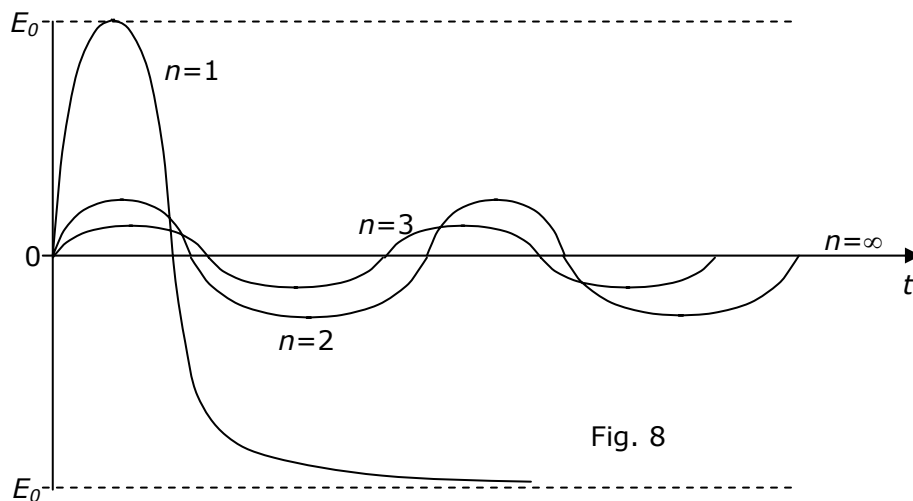

Fig. 8

Let's accept a beginning of timing from the moment of passage by an electron of a point A of intersection of orbits. At $n=1$ first half-period of oscillations of an electron will be completed rather promptly, since the tangential velocity of a motion of an electron in pericentre is maximum. In a point of pericentre the potential energy of an electron is maximal and numerically is peer to ionization energy. At intersection orbit of the Bohr (point B) the potential energy of an electron (concerning a ground state) accepted zero value. The extremity of the second half-period of oscillations we not awaited, since on a parabolic orbit the electron is deleted on perpetuity and its potential energy concerning a ground state again becomes of an equal ionization energy, and kinetic accepts zero value. At increase of a quantum number the first half-period of oscillations slightly is incremented, and the second half-period rather sharply is reduced, the oscillations amplitude decreases, the oscillations more and more come nearer to simple harmonic motions, and shape of an orbit to a circle. At $n \rightarrow \infty$ the oscillations fade and together with them the radiation fades. The

electron takes a ground state on an orbit of the Bohr. On hyperbolic trajectories the potential energy of an electron in pericentre always is more than a level E_0 (fig. 8).

To find dependence of a potential energy of an oscillator in atom of hydrogen from value of a quantum number, we shall take advantage of the formulas (2.2), (2.3) and (2.4) chapter 2 [1]. In these formulas we shall substitute the formulas for distance from a nucleus in pericentre and apocenter depending on a quantum number from table 1:

$$r_p = r_0 \frac{n}{n+1} \quad (56)$$

for pericentre and:

$$r_a = r_0 \frac{n}{n-1} \quad (57)$$

for an apocenter.

Substituting (56) in (2.2) with the registration (2.3) and (2.4) of chapter 2 [1], we shall receive a potential energy in pericentre:

$$E = -2E_0 \frac{n+1}{n} + E_0 \frac{(n+1)^2}{n^2} = E_0 \left(\frac{n^2-1}{n^2} \right) \quad (58).$$

To find a potential energy of an oscillator concerning its equilibrium state (orbit of the Bohr), it is necessary from its blanket potential energy in pericentre on (58) to subtract a potential energy in a stationary state E_0 :

$$E_{osc.p} = E_0 \left(\frac{n^2-1}{n^2} \right) - E_0 = -\frac{E_0}{n^2} \quad (59).$$

As well as it was necessary to expect, the potential energy of an oscillator is negative in matching with an orbit of the Bohr, and its numerical value coincides the theory of atom of new physics.

Substituting (57) by a similar way we shall discover a potential energy of an oscillator concerning an orbit of the Bohr in an apocenter:

$$E_{osc.a} = E_0 - E_0 \left(\frac{n^2-1}{n^2} \right) = \frac{E_0}{n^2} \quad (60).$$

Thus, we have found out the physical reason of radiation of atom. Besides from a figure 8 it is visible, that at transitions from one orbits on another the electric dipole changes in strong degree oscillations amplitude and in a small degree an oscillation frequency. The frequency of a half-period, bound with pericentre always is little bit higher than frequency of a half-period, bound with an apocenter. Therefore electron in points of an orbit A and B will radiate photons with little bit distinguished energy (doublets of spectral lines). Especially this difference is appreciable at small values n .

Scoring more thin effects, it is necessary to pay attention that the electron at orbital motion is "dragged" behind itself and proton, though its mass almost in 2000 times more. Besides at the expense of electron inertia its orbit is gyrated in the side of a motion of an electron. The velocity of this gyration is determined only by eccentricity of orbit of an electron and value of a major axis. That this deduction was clearer, we are address to a figure 9.

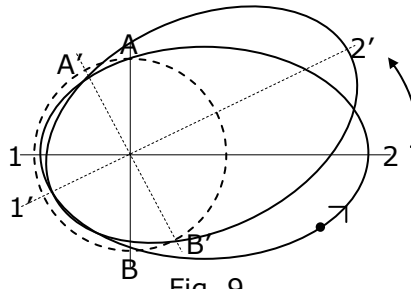

Fig. 9

At a motion of an electron from an apocenter 2 to a point A, its radial velocity is incremented from zero point up to a maximum, and after passage of a point A its radial velocity sharply drops, since in a point 1 pericentre it again should accept zero value. The electron inertia gives that the intersection point with an orbit of the Bohr displaces counter-clockwise on value, proportional acceleration of an electron, which one depends on an eccentricity of orbit and semimajor axis (point A'). The position of pericentre too displaces (point 1'). The second intersection point with an orbit of the Bohr (point B') for the same reason displaces also. In result and the position of an apocenter appears in the other place (point 2'). The same reasoning are valid and for gyration of elliptic orbits of planets.

The indispensable requirements for radiation of photons. The main requirement for radiation by free or bound electrically charged particles - negative acceleration of electric charge. In a bound state (in atom or molecule) except for negative acceleration should be fulfilled the requirement of radiation only integers of photons (radial velocity can decrease only in an integer of time of comparatively parabolic velocity). Therefore on an elliptic orbit, on which one the indicated requirement is not fulfilled (for example, between energy levels), the oscillator though oscillates, but nothing radiates. On such orbit it is forced to lose a part of energy at each revolution around of a nucleus at the expense of transmission to atom in the whole part of the impulse until the indicated requirement will be carried out.

Energy of connection in a ground state from the formulas (2.3) and (2.4) [1]:

$$E_0 = \frac{Ze^2}{2r_0} \quad (61),$$

where r_0 - radius of an orbit of the Bohr. The formula (13.3.6) will be valid and for electron-binding energy in a position of pericentre r_p and apocenter r_a . Apparently, that the potential energy concerning an orbit of the Bohr for pericentre should be peer to a potential energy concerning an orbit of the Bohr for an apocenter, that the law of conservation of energy in an antiradiation condition was fulfilled:

$$\Delta E_{tie.p} = E_{tie.p} - E_0 = \frac{Ze^2}{2} \left(\frac{1}{r_p} - \frac{1}{r_0} \right) \quad (62),$$

$$\Delta E_{tie.a} = E_0 - E_{tie.a} = \frac{Ze^2}{2} \left(\frac{1}{r_0} - \frac{1}{r_a} \right) \quad (63).$$

Let's designate $r_p = r_0 P$ and $r_a = r_0 A$, where P and A - share of pericentre and apocenter from radius of the Bohr. Allowing these designations and equating (62) and (63), we shall discover:

$$2 = \frac{1}{P} + \frac{1}{A} \quad (64).$$

The equation (64) has uncountable set of the solutions, and all of them meet the requirement maintenances of energy. Now it is necessary to receive expressions P and A through a quantum number n . By it we from uncountable set of the solutions (64) shall select only «integer» solutions that physically mean the requirement of a wholeness of a radiated photon. Apparently, that at $n=1$ $A=\infty$, and from (64) $P=1/2$. At $n=\infty$ from (64) $P=A=1$. It is uneasy to guess, that such property has the functions at r_0 of expressions (56)

and (57). Thus, both at a motion to a ground state, and at a motion to a state of an atomic ionization the electron beforehand "knows" parameters of all orbits, on which one it is authorized to it to radiate photons. On all remaining orbits the electron is an oscillator, but the radiation is forbidden. On an orbit of the Bohr the radiation is authorized, but on it the electron does not oscillate - radiation is not present. Too concerns a motion of an electron on an isopotential orbit of any shape, for example, in molecules. On such orbits the electron is not an oscillator.

In connection with enunciated, some words are necessary for telling about multielectronic atoms. In a ground state of these atoms the electrons motion on circular orbits is impossible because of influence of electrons against each other. Therefore electrons should be moves though is self-consistent, but on ellipsoidal orbits, on which one the requirement of a wholeness of radiated photons is not fulfilled, therefore radiation is not present. They also can be moves on an isopotential surface of any shape, on which one also radiation is forbidden, as the potential energy of an electron remains to a stationary value. Besides the orbits of electrons should be symmetrical concerning a nucleus of atom. In this case change of an orbit of an electron at the expense of transmission of a part of its impulse to atom as a whole is impossible, since the vector addition of impulses received from all electrons should give zero point. Motion on a "forbidden" or isopotential orbit and impossibility of its self-maintained change ensure existence and stability of all present atoms.

The electron with a total energy is more than zero point in atom of hydrogen

Radius of a screw trajectory of an electron is bound to its velocity by a relation:

$$r = \frac{\alpha}{V} \quad (65),$$

where V - forward speed of an electron, $\alpha = 1.1576 \text{ cm}^2/\text{sec}$ (see chapter 2 [1]). For a mobile electron a kinetic energy of headway of a particle:

$$E_k^{for} = \frac{mV^2}{2} \quad (66).$$

By substituting (66) in (65), we shall discover connection of radius of a screw trajectory with a kinetic energy of headway:

$$r = \alpha \sqrt{\frac{m}{2E_k^{for}}} \quad (67).$$

As it is visible, the formula (67) does not contradict physical sense. Substituting in it the relevant numerical values and $E_k=13.6 \text{ eV}$ ($1 \text{ eV} = 1.602 \cdot 10^{-12} \text{ ergs}$), we shall receive value of radius to equal radius of an orbit of the Bohr. It means that if the total energy of an electron (in perpetuity) is more than zero point, radius of its screw trajectory always is less than radius of an orbit of the Bohr. In connection with enunciated, the hyperbolic orbits of an electron around of a proton are impossible in their classic comprehension. The trajectory of an electron with a total energy is more than zero point near to a proton is shown on a figure 10.

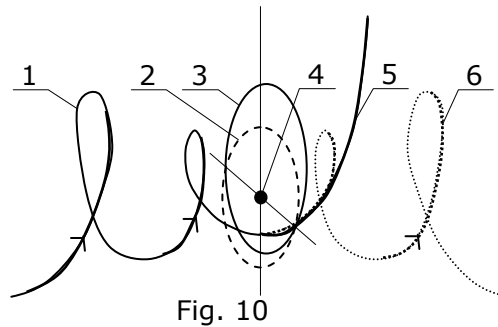

Fig. 10

Designations on a figure 10.

1. Trajectory of an electron in perpetuity having a kinetic energy 13.6 eV. Radius of a screw trajectory is peer to radius of an orbit of the Bohr. At approach to orbit of the Bohr the energy of an electron will increase up to 27.2 eV.

2. Orbit of the Bohr.

3. One of elliptic orbits after a braking radiation of a photon with energy is more 13.6 eV.

4. Proton.

5. Parabolic orbit at a braking radiation of a photon with energy equal 13.6 eV.

6. The prolongation of a trajectory of an electron, if a braking radiation missed. At removal on perpetuity the electron loses 13.6 eV from 27.2 eV and its energy again becomes equal 13.6 eV.

Summing up audit of bases of a modern quantum mechanics, it is possible confidently to state, that these fundamentals do not withstand criticism and should be exchanged by new notions. Already it is clear, that the orthodoxes can not put forward the argued oppositions in protection of an official quantum mechanics or in refutation of new physics, therefore further events are uneasy for foreseeing. New physics in the beginning waits an ignoring, then billingsgate and, at last, blanket recognizing in accordance with extinction of the fans of official physics.

Rydberg atoms

More in detail about rydberg atoms it is possible to read, for example, in Soros Educational Journal 1998, № 4, page 64. They represent macro atoms on the size (up to 0.02 mms) located in a condition of high excitation on the verge of ionization with a main quantum number about 1000 on presentations of official physics. Accordingly, radius of such atom in 10^6 times more radius of a normal atom. The capability of creation and existence of rydberg atoms allows, at last, finally to be disassembled in differences of official and new physics on a constitution of atoms.

1. At first we shall be disassembled with official notions about radiation and occluding of energy by atom. They outgo from a capability of an aliquot angular momentum of an electron on «orbit»:

$$m_0 V r = n \hbar \tag{68},$$

where m_0 - no relativistic electronic mass, V - its orbital velocity, r - orbit radius, n - integer, \hbar - constant of the Planck. Apparently, that (68) is direct violation of law of preservation of angular momentum so long as we shall not find out, this aliquot increase of angular momentum of an electron whence arises. For this purpose it is necessary to consider angular momentum of an electron on orbit at $n = 1$ same, as well as angular momentum of a photon, i.e. \hbar . I shall remind to the reader, that the law of conservation of angular momentum requires, that the angular momentum of a mobile electron also should be peer \hbar . The theory of circular orbits of an electron is set up in chapter 2 [1]. Let's consider the formula (2.3) [1] for radius of a circular orbit and (2.4) [1] for electron-binding energy on a circular orbit:

$$r = \frac{m_0 \alpha^2}{Ze^2} \quad (69),$$

where:

$$\alpha = Vr \quad (70)$$

$$E = -\frac{Z^2 e^4}{2m_0 \alpha^2} \quad (71).$$

As an electron in atom always not relativistic (see chapter 7.2.1 [1]), the repetition factor of electron angular momentum in atom is connected to repetition factor of product Vr :

$$\alpha = n \cdot \alpha_0 \quad (72).$$

At $n = 1$ electron is in a ground state on orbit of the Bohr (in atom of hydrogen). To transfer it in an excited state with $Vr = 2$ it is necessary, that the atom has occluded the applicable photon and has transmitted energy and impulse of this photon to an electron. Thus the electron again will be on a circular orbit, radius by which one is 4 times more radius of a ground state. Any circular orbit is stationary, being on it an electron anything to beam can not. That there was an energy loss, some exuberant energy, distorting circular orbit in elliptical is indispensable. Further again is necessary occluding a photon and transfer of an electron in a condition with $Vr = 3$ etc. Thus, the transition of an electron from one energy level on another from the point of view of official physics is possible only at series occluding of photons, and jumping through one or greater number of levels it is impossible, if there is no simultaneous occluding of several photons. Outcomes of the official theory we shall receive, by substituting (72) in (69) and (71):

$$r = \frac{m_0 \alpha_0^2}{Ze^2} n^2 \quad (73),$$

$$E = -\frac{Z^2 e^4}{2m_0 \alpha_0^2 n^2} \quad (74)$$

whence it is visible, what on considered notions of levels of energy are insipidated at nearing to an ionization energy of atom $n \rightarrow \infty$, $E \rightarrow 0$. At $n = 1$ electron is on orbit of the Bohr. The surprising commonality macro and micro cosmos is confirmed by that circumstance, that in the coerced analysis of official outcomes radius of a circular orbit of an electron is proportional to a square of a quantum number n , and the speed of an electron on any circular orbit in an integer of time (n) is less than speed on orbit of the Bohr. In chapters [1]: 20 and 21 the precisely same conclusion is made concerning quantum condition of planets and their satellites (see figure 21.4 [1]). From above set up clear, that rydberg the atoms can be received only at continuous occluding of photons with continuously decreasing energy down to boundary of ionization. Electron-binding energy in such atoms is insignificant; therefore any impact with extraneous particles results in ionization of rydberg atoms. If impacts to avoid, rydberg atoms metastable, that confirms an antiradiation condition at motion of a charge on a circumference at absence of motion in a radial direction.

2. The notions of new physics concerning radiation and occluding of energy by atom are particularized in chapter 13 [1] and in the subsequent chapters. From the point of view of new physics there is only one circular orbit of the Bohr, therefore electron on it does not beam. All remaining orbits elliptical, for which one is present radial component running speeds being a reserve for radiation of photons and impart to it of angular momentum, which one for the electron remains constant and equal \hbar . Electron-binding energy (see chapter 13 [1]):

$$E = -\left(1 - \frac{1}{n_*^2}\right) \frac{Z^2 e^4}{2m_0 \alpha_0^2} \quad (75),$$

where n_* - integer quantum number, which one differs from a quantum number n of the official theory of atom.

From (75) it is visible, what the energy levels are inspissated near to orbit of the Bohr and at $n_* \rightarrow \infty$, $E \rightarrow E_0 = 13.6$ eV for hydrogen. At $n_* = 1$ electron is on parabolic orbit (Lyman orbit for hydrogen). The it is more n_* , the closer form of electron orbit to a circumference and the exited state is more stable, on a circular orbit of the Bohr the radiation completely misses, therefore this condition is absolutely stable. At the same time, the slightest effect on atom results in its excitation and transition of an electron to levels with large value n_* . That the atom beamed from levels of high values n_* , the very low ambient temperature and absence of extraneous particles is necessary, which one excite atom. In this regard atoms with electronic orbits near to a ground state are similar on rydberg atoms. They also can beam within the range long-wave because of a minor difference in energy of low levels, but thus to be ionized from additional small effect can not because of strong connection with a nucleus. Conditionally we shall call such atoms «cold».

From (74) and (75) it is easy to find connection between quantum numbers n and n_* :

$$n = \frac{n_*}{\sqrt{n_*^2 - 1}} \quad (76).$$

At $n_* = 1$, $n = \infty$. At $n_* = \infty$, $n = 1$.

Though the energy levels of official physics and new physics stands on attitude to each other «upward by legs», but the differences of energies between two any levels with identical values n and n_* are peer among themselves, of what it is possible to be convinced from (76).

As a result of these reasons there is a problem: when we receive from space radiation of atoms in a radio-frequency range, what atoms dispatch it? Rydberg or «cold»? I am seduced for the benefit of «cold» and I consider, that rydberg atoms can be created only in special laboratory conditions. For the benefit of «cold» atoms it is possible to result following arguments.

A. When the positive proton captures an electron, there is a radiation spectrum, in which one it is possible to watch all known spectral serials, including in the region of long waves. Radiation spectrum generated by rydberg atoms is impossible since the circular orbits are impossible (there is no place to take energy for supply of photons by angular momentum).

B. Each spectral serial has a limit of a serial. This limit from the point of view of official physics corresponds to an ionization energy of atom ($n \rightarrow \infty$), though except for a limit of Lyman serial all remaining lie in the area of energies far from an atomic ionization.

C. The transition of an electron in rydberg atoms is possible only between adjacent levels, for more distant transitions the multiple photon absorption or radiation is necessary.

D. Electron-binding energy in rydberg atoms so is small, that any photon of relict radiation (density which one very large) is capable to ionize atom. Therefore in a cloud of ionized atoms can be watched only single neutral (rydberg) atoms.

E. That was received rydberg atom the smoothly varying reduction of frequency of irradiation of atom is necessary, that this frequency was all time pursuant to frequency of photons, which one is capable to occlude atom on sequentially up energy levels. In space conditions such process is improbable.

Apparently, that for «cold» atoms of listed problems does not arise.

On a figure 11 both systems of atomic energy levels for hydrogen are figured. At the left - official scheme, on the right levels scheme of new physics. In certain conditions of occluding and radiation of energy by atom correctly to image a situation there will be this or that scheme. For example, at acquisition by a positive proton of a mobile electron the radiation spectrum will correspond to the right scheme, and at multiquantum occluding with series transition of an electron to more high-altitude orbits, the radiation spectrum at transition of an electron in a ground state will correspond to the official scheme.

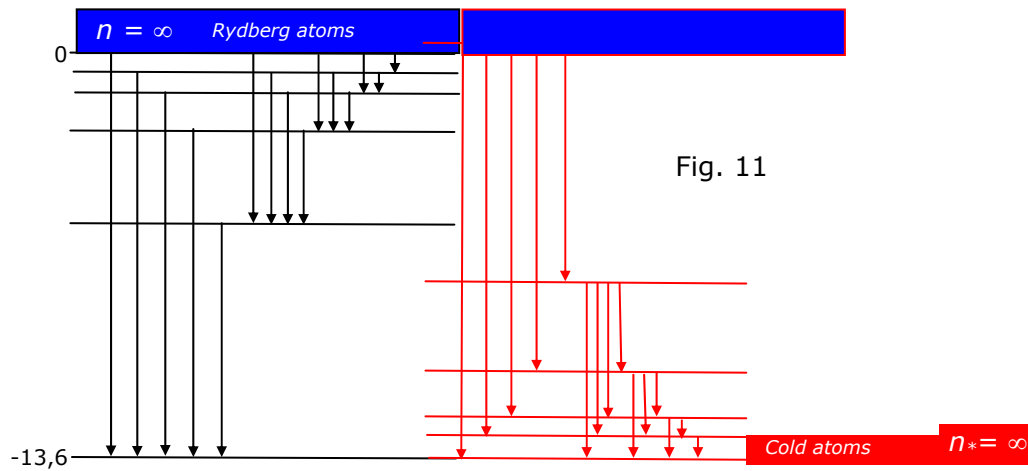

Effective charge and influence of magnetic orbital interaction

As the electron-binding energy in atom is proportional to a quadrate of effective nuclear charge, it is possible to note the ratio:

$$\frac{E_H}{E_i} = \left(\frac{Z}{Z_{eff}} \right)^2 \quad (77),$$

whence:

$$Z_{eff} = Z \sqrt{\frac{E_i}{E_H}} \quad (78),$$

where E_i - binding energy (ionization) of an electron in i -th atom or ion with a charge Z from a certain energy level, E_H - binding energy (ionization) of a hydrogen-like atom with a charge Z from an energy level that the number.

For lithium in a ground state: $E_i=5.39$ eV, $E_H=13.6$ eV, $Z_{eff}=0.629$. The diminution of a charge is stipulated by proximity of inner-shell electrons to outside. As the attractive force to a nucleus is proportional to a charge in the first degree, and the repulsive force from inner-shell electrons is inversely proportional to a quadrate of distance, they strongly reduce an ionization energy.

For Li^+ in a ground state: $E_i=75.7$ eV, $E_H=54.1$ eV, $Z_{eff}=1.182$. In this case magnetic orbital attraction of two electrons, which have stayed in lithium, gives in increase of ionization energy (effective charge). Thus, the presence of inner-shell electrons gives in diminution of an effective charge and the orbital magnetic interaction of a given electron with other electrons of atom yields the same activity as increase of an effective charge.

Energy of connection of an electron at any level of a hydrogen-like atom E_H we already know (formula 13.17 [1]). Apparently, that the similar formula for any electron in any atom will differ only by value of an effective charge Z_{eff} instead of Z . A difference of these binding energies:

$$\Delta E = E_H - E_i \quad (79),$$

From (79) we shall discover E_i :

$$E_i = E_0 Z_{eff}^2 \left(1 - \frac{1}{n^2} \right) \quad (80),$$

where E_0 - ionization energy of atom of hydrogen.

From (80) it is visible, that the effective nuclear charge varies not only depending on a degree of ionization, but also from an energy level, on which one there is an electron, i.e. from distance up to inner-shell electrons and shape of an orbit.

Energy of a photon, which one is radiated at transition to lower layers, is peer to difference of a binding energy on final and original level. For this case the formula (80) starts a view:

$$h\nu = E_0 \left[Z_{eff2}^2 \left(1 - \frac{1}{n_2^2} \right) - Z_{eff1}^2 \left(1 - \frac{1}{n_1^2} \right) \right] \quad (81).$$

Near to a ground state the levels of energy are arranged densely, therefore effective charge remains practically identical. For this case (81) is simplified:

$$h\nu = E_0 Z_{eff}^2 \left(\frac{1}{n_1^2} - \frac{1}{n_2^2} \right) \quad (82).$$

Naturally, that the formula (81) will give precise values of energy of radiated photons, but practically to use it is to deceive myself, since Z_{eff} depends from n and while can be retrieved only from experimental data. It is more useful to use the formula (78), that on an effective charge to judge a constitution of atom. Then it is possible to construct the theory for analytical definition of an effective charge and the formula (81) will become very useful.

Here it is necessary to mark one more key difference in views on radiation of photons by atom in the modern and introduced reader to alternate physics. The modern physics considers, that the reason of radiation is the transition of an electron to other orbit (more correctly, in other state, since it does not recognize neither orbits, nor electron, as integrated particle in atom), and the radiation of a photon is a corollary of such transition. Apparently, that, in this case, the reason of transition of an electron in a new state remains vague, besides photon appears in an inconvenient standing, as should "to remember" a original state of an electron, which one can be by anyone. The quantum mechanics as the solutions of a Schrodinger equation gains not metastable, and invariable "excited" states of electrons in atom, therefore is forced to explain instability of such states by interaction of an electron with virtual particles born in vacuum.

The new physics considers, that the atom radiates a photon owing to aspiration to a minimum of a potential energy, and it can radiate any photon in limits solved centrifugal velocity of an electron and a requirement of diminution of this velocity in an integer of time, and the new orbit with a binding energy by more close to bottom of a potential well will be a corollary of radiation. In all sincerity it is necessary to recognize, that to a modern physics at all from an arm to be engaged in clearing up of causal connection of radiation of a photon and state of an electron, as at anyone apportionment the photon should "to foresee" a final state of an electron or "to remember" initial. As it manages to do - official science to explain be not capable and it is not agglomerated to do, since a quantum mechanics - statistical theory disclaiming a determinism in a microcosm (see of an indeterminacy relation of the Heisenberg).

Some words are necessary for telling about thin structure of spectral lines, which one the author associates (in particular) to precessional movements. The reason of a precession of an orbit of an electron is the declination of a rotation axis of an electron to orbital plane that, in turn, is a corollary of a motion of a mobile electron on a screw line. The trajectory of an electron in a plane, perpendicular precession axis is similar to Lissajous figures and depends on a relation of frequencies of a precession and circulation of an electron around of a nucleus. Except for a precession of an orbit of an electron, simultaneously there is also precession of a rotation axis of the electron (orbits component its neutrino, see chapter about "elementary" particles) and precession of rotation axes the neutrino from which one consists an electron. The precessional movements split levels of electron-binding energy with a nucleus on a series of sublevels, as the mechanism of their formation has many similar features with the mechanism of formation of invariable orbits of an electron in atom (allowed orbits). Are available some more reasons resulting in to split of levels of energy, on which one to stop we shall not be, for example, one of the reasons is the interior constitution of an electron, which one very much resembles atom, in which one function of electrons fulfill a neutrino. Here only we shall mark, that the official physics of one of the reasons of thin structure of spectral lines considers relativistic increase of electronic mass in velocity function. But this increase happens not quantize, and smoothly, therefore, in any way can not create additional quantized levels of energies exhibited as close set spectral lines. "The thin structure of spectral lines is quantum relativistic effect. It is explained by result of activity of two factors: by 1) interaction of an own magnet moment of an electron

with a magnet moment of orbital motion of an electron; by 2) relativistic dependence of electronic mass on velocity". N.I. Kariakin etc. "The brief manual on physics", "Higher School", M., 1962, page 350.

Mesoatoms

The new physics states, that radius of a motion of an electron in atom is proportional to electronic mass (see formula 2.3 [1]). The official physics holds on to the opposite statement: distance of an electron from a nucleus of atom is inversely proportional to electronic mass (see chapter 2 [1]). The mesoatoms contain in the composition instead of an electron a meson (μ , π , K etc.). The sizes of mesoatoms are less than the sizes of customary atoms in as much time, in how many of time mass of mesons is more than electronic mass, i.e. correspond to the official formula for radius of atom, where the electronic mass (meson) stands in a denominator. From this fact it would be possible to draw a conclusion that the deductions of new physics on a given problem are erroneous, however at more close examination of a problem it appears, that the error is done by orthodox physics. The conflict consists in following. Apparently, that the gravitational interaction of an electron with a nucleus insignificantly also can not influence behavior of an electron. At the same time, the electronic mass can exhibit itself only as inertia at a motion of an electron on a certain orbit, incrementing its radius. On notions of a quantum mechanics the electron in atom has not orbital motion, therefore electronic mass at all should not figure in the formula for radius, and the occurrence it in a denominator contradicts physical sense, since except for inertia of any other functions it to bear can not. To decide the indicated conflict, it is necessary to pay attention to a moment of momentum on an orbit, which one as a result of operation of law of maintenance of an angular momentum maintains constant value: $S=mVr$. At the same angular momentum of miscellaneous particles (the new physics demonstrates, that it is peer 1 in terms of $h/2\pi$) according to activity of this law radius of an orbit of a particle will be inversely proportional to its mass at the same velocity of orbital motion (this velocity near to a nucleus comes nearer to speed of light, that is convincingly shown in chapter 5.1 [1]). Thus, physically are just and are valid two outwardly opposite statements: in the formula for radius of an orbit the particle mass should stand in numerator from a point of view of inertia of a particle and in a denominator from a point of view of maintenance of an angular momentum, if we shall decrypt it, but it cannot be made, since it is a constant. Unfortunately, the orthodox physics does not understand physical substance it's of the formulas.

References:

- 1 <http://www.new-physics.narod.ru>