

Temporal Mechanics (B): Time-Space Constants

Stephen H. Jarvis

email: shj@equusspace.com

©2020 Equus Aerospace Pty Ltd

Abstract: In this paper Temporal Mechanics moves beyond the description of time-space circuits to explain the constants of energy and mass integral to those time-space circuits, and what the overall resultant manifolds are for energy and mass, from the microscopic scale to the macroscopic scale. Here the Oort Cloud derivation is accompanied by the derivation of the Heliopause and associated Bow Shock, and why they exist upon the general uniform CMBR backdrop consistent with the plane of the solar system, thereby providing a solution to the “Axis of Evil” and “Horizon” problems. With such a description, the fundamental phenomena of particle “pair production” via the EM-DIR effect (EM destructive interference resonance) is presented, accompanied by a proposed experiment to demonstrate the production of positrons and how they can be used for thrust-applications.

Keywords: temporal mechanics; temporal calculus; axis of evil, horizon problem; Oort Cloud; Heliopause; Bow Shock; CMBR; vacuum energy; redshift; hologram; positron; antimatter; Voyager 1; Voyager 2; MQS; EM-DIR; time-space circuit

1. Introduction

Temporal Mechanics is a newly proposed approach to physics theory using a *mathematical application* for time called *temporal calculus*, a time-equation enlisting time-points in space to describe all known data-based physical phenomena. Quite simply, it is a process of adding more temporal dimensional *depth* to the known arrow of time thus gaining greater resolution of theory for standard 4d spacetime.

<http://orcid.org/0000-0003-3869-7694> (ORCID)

Web: www.equusspace.com

As Temporal Mechanics is a new approach to the analysis of physical phenomena, it requires a new a priori, and as it happens, a new description of the idea of bodies in relative motion. There is a dataset therefore of papers for Temporal Mechanics to be acquainted to, as a required background knowledge for this paper, as per papers 1-31 [1-31]. The previous paper, paper 31, provides nonetheless a good summary of Temporal Mechanics in its presentation of the time-space circuit (*TSC*) [31], detailing the basic idea of non-local time-points, and how that relates to a time-equation involving time-before, time-now, and time-after and its relationship to c .

The closest analogy of Temporal Mechanics and associated *temporal calculus* is Maxwell's equations, namely the wave-model of light, yet here in not using a luminiferous particle aether which Maxwell assumed to exist, yet an aether of time-points in space.

The problem with what has happened in physics from the late 19th century to early 20th century is that the idea of aether that held for many centuries was considered as a luminiferous *particle* realm, a *passive* entity conveying processes and being subject thereof to "*winds*"; no one knew what aether was, just that it was there to assume a carrier status for waves. So the "assumption" of what that aether was, what aether could be, particle, space, or time, *was dismissed* and given way to the photon and associated mathematical formalism owing to Einstein's interpretation of the Michelson-Morley experiment results, replaced by using "*clocks*" for time and enlisting space as an assumed 3-d geometrical mathematical entity, an entity that could do whatever it wanted *provided the mathematics fit* in measuring the nature of *the movement of mass*, while using "*light*" as the process of measuring bodies in motion central to their inertial status.

Such is the key problem that physics is faced with today, namely using *light to measure the movement of mass* with *clocks* in a *mathematical space*, a set of principles that Einstein granted to the idea of 4d spacetime, defining gravity as spacetime, a large-scale phenomenon that came with a whole host of problems, problems central to the energy required to explain the redshift of light in using a metric expansion of space. Although his postulates were correct, they merely described c as being a constant for all frames of reference while then, strangely, making "time" a secondary consideration, ignoring the fundamental postulate itself that at c time does not pass.

As a solution, the fundamental issue of a time-space circuit (*TSC*), of time-points in space finding relativity with each other, as a circuitry, is *where indeed* that process of time as a constancy at c is brought into focus, as a *continuous* time-equation describing the processes of energy and mass.

To demonstrate this proposal further, time-space *constants* (*TSA*) for *energy* and *mass* and their associated manifolds in space are forwarded here in this paper, as the speed of light " c " and the known cosmological constant value (Λ) and how that relates with **known** astronomical manifolds of this solar system, namely the Oort Cloud, Bow shock, and Heliopause, all related to the CMBR, here properly deriving the qualities of each and their respective distance from the Sun, and thus **why** they exist.

Given the complexity of the issue of energy and time, a new paper following this is proposed, describing the *time-space manifolds* (*TSA*), namely a description of the performance of the general spatial manifolds, introduced already as the *MQS* scheme, there though specifically deriving the phenomena of the stars and associated redshift effect, detailing the nature of energy with light in space beyond the atom,

and validating that proposal with the derivation of the known metrics of the solar system astronomical manifolds.

To arrive at these derivations, one fundamental constant is being focused upon in this paper, namely “ c ”, as how time measures space, as proposed in paper 30 ([30]: p13-14), at which speed time does not pass.

In short, for a time-point to bear reference to another time-point reference is to entertain a new concept of time as a *duration* of time in assuming the idea of “speed”, namely spatial distance per however many units of time are being determined as time-points, timestamps, to be crossed through. This was presented simply in paper 20 in figure 6 ([20]: p13, fig6). There, it was proposed that time-points quantifying space as a speed of information-transfer is set at a certain rate of time (as a type of spatial timestamp grid) through a certain distance of space, as “ c ”; although the time-points are in an immediate entanglement with each other, as paradoxical as it seems, given at c time does not pass, the time for one time-point to measure another would take “ c ” as a transit through space, a secondary concept for time, which thence gives the idea of distance to space, and represents the description of how the time-before, time-now, and time-after time points *interrelate*.

Such was point (D) in paper 30 ([30]: p12). A fuller description for the time-points and how motion can be accorded in space is given in paper 20 ([20]: p11-18). Yet here in this paper the idea of time-points being central to c and thence the CMBR is focussed upon, and how those constants relate to, ultimately, the key known astronomical manifolds (to be taken up more rigorously in the next paper on time-space manifolds).

Ultimately, the approach with Temporal Mechanics has been to get the small scale right first, using the *temporal calculus*, to solve and predict all the phenomena that Einsteinian 4d spacetime physics has, which *temporal calculus* also has, and to then have that Temporal Mechanics theoretic model extend to a cosmological scale and let that tell its story, and then compare those findings with known data.

On the broad scale, the aim here in this paper is to solve two key features as known problems in cosmology theory, namely the “Axis of Evil” and the “Horizon” problems, in focussing on the time-space circuits and constants in addressing those two issues. This paper will execute the following as a solution to those two key known problems:

- (1) Introduction
- (2) The “Axis of Evil” and the “Horizon” Problem
- (3) The light constant, c
- (4) CMBR manifolds
- (5) CMBR Manifold particle and energy generation and dynamics
- (6) EM^{DIR} Antimatter production and propulsion
- (7) Conclusion

In short, in *temporal calculus* having successfully derived the CMBR for this local solar system reality ([14]: p25, eq12), the next step is to derive features known to this solar system, features such as

the Oort Cloud and the Bow Shock and Heliopause, as based on the constants of the CMBR (A) and c . The next step there will be to properly and thoroughly explain what powers this overall event in time, following which the overall large-scale manifolds will be proposed with those known energies in play, proposing an explanation for the redshift effect and nature of the phenomena of the stars (Time-space Manifolds).

2. The “Axis of Evil” and the “Horizon” problems

The "Axis of Evil" describes a known anomaly in cosmology central to the CMBR, an anomaly that quite oddly puts the plane of this solar system in league with the Copernican principle, namely that the solar system would appear to be the centre of the universe, yet more to this, that there is a correlation of the plane of the Earth with the Sun (*SOL*) according to CMBR data [32], and thus according to the overall universe itself.

Something therefore is having the CMBR present the case that this solar system resides in an overall bubble, and that the stars are projected to us as though through a giant bubble plasma screen, like a hologram. As ludicrous as that sounds, this concept is strangely familiar to Mach's principle [33], Mach who was in many ways a forerunner Einstein's relativity theory.

Mach essentially presented the case of inertial frames of reference between an observer and the outer system of cosmology, presenting the analogy of swinging one's arms around while spinning the torso, and presenting the case that if the stars could whirl around us then our arms should naturally swing out likewise. Mach basically presented the case that there would need to be a physical law that relates the motion of the distant stars to the local inertial frame. So, Einstein attempted to use Mach's Principle and make it non-inertial. With what success?

The “Horizon” problem (or as otherwise stated, the “cosmological constant problem”) [34], a problem by virtue of needing to explain the redshift of light as per a metric expansion of space and those energies that would be required to achieve such, resulted, given there being a constant CMBR value in play. Simply, Einstein still depended on his inertial based mathematical formalism of Special Relativity warranting a need to explain the energies required for a metric expansion of space and associated forces to explain the redshift effect, *deployed* to a "big bang" requiring dark energy and dark matter, the problem there being the actual observed reality of a constant CMBR, a constant vacuum energy.

The absurdity now is this, namely that the “Axis of Evil” problem presents the case of our solar system being the thing that effects all of what is observed in cosmology as per the CMBR findings, and not just such findings alone, yet the coupled finding of a relatively uniform energy value for the vacuum of space, inferring the unlikelihood of a metric expansion of space.

So, two key problems, namely the “Axis of Evil” problem, and the “Horizon” problem (almost refuting the idea of a metric expansion of space given the energy of the universe thus appears flat, appears uniform), namely that the Earth and Sun, that plane, appear to represent the centre of the universe, contradicting the current Λ CDM model of the big bang.

Was Copernicus right? Is there a *valid* theoretic model *allowable* to explain the data for the "Axis of Evil" and resolve the "Horizon" problem, through explaining the stars as a type of display of light through a type of more predominant bubble we would exist in, a bubble that would *lens* light in a fashion that delivers light as the appearance of the stars, over-arching what would be a reality that is defined predominantly by the plane and existence of this solar system?

There is only one way to tackle this issue, and that is from first principles, to accept that relativity is unable to explain the data, certainly not with principles of inertia or mass as the baseline mathematical components of inquiry, and that a new mathematical formalism and associated theory is required, proposed here as *temporal calculus* and its described time-space circuits and constants.

3. The light constant, c

Temporal Mechanics and associated *temporal calculus* have presented the case of re-defining the first principles of time and space, using "time" as the thing that measures space, as per a time-algorithm that is more closely related to the human temporal perception ability than mass. Here it is found that in using such a time-equation that " c " is not just a *constant* yet a way time measures space, namely as associated to time-points in space allowing the transmission of energy through space, through the vacuum, at " c ". Simply, " c " is the most fundamental component to the time-point theory as how a time-point is requested to quantify the vacuum of space it is being associated to.

For instance, to measure a distance in space requires (if space is a dimensionless vacuum, no scale, other than our own 3-d perceptive constraints) "two" time-points while then having a line in time drawn between two time-points. How can a time-point measure distance in space? How can a line be drawn between those two time points as a value of measuring space? Simply, for a time-point to bear reference to another time-point reference is to entertain a new concept of time as a **duration** of time in assuming the idea of "speed", namely spatial distance per however many units of time are being determined as time-points, timestamps, to be crossed through. This was presented in paper 20 figure 6 ([20]: p13, fig6):

The result this would have would be the as per figure 6, namely "three" "now" zones of time.

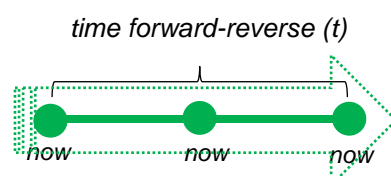

Paper 20, Figure 6: three "now" zones of time from the joining of the *run* of time; red arrow-head to blue arrow-head, red square-tail to blue square-tail.

Although the now>now>now arrow event seems abstract, something new takes shape, quite literally, namely the concept of space and motion as though this represents motion where time doesn't pass, a concept known to the feature itself of light.

There, it was proposed that time-points quantifying space as a speed of information transfer are set at a certain rate of time (as a type of spatial time-stamp grid) through a certain distance of space, as "c". The actual value of "c" was derived in paper 2 ([2]: p13, eq10):

Thus, what we are considering is that ~20 times the wavelength of the electron "per" its charge (it's fundamental representation of energy and thus "time") is in fact its "speed", the speed of the wavelength, as the whole equation for the atom runs as a way time can find "π", and thus a progression in the form of time. What type of progression of time? Electromagnetism, and in this case the monopolar charge of a source electron (which shall be demonstrated). The following value results:

$$\frac{19.8 \cdot \lambda}{e_c} = \frac{19.8 \cdot 2.426 \cdot 10^{-12}}{1.60218 \cdot 10^{-19}} = 2.998 \cdot 10^8 \text{ ms}^{-1} \quad (10)$$

Associated to this was derived the value of the fine-structure constant based on the way time-points interact with each other as a wave-function, a mathematical description of how time-space circuits are wired ([2]: p12, eq9):

Simply, the fine structure constant would be indicative of the electromagnetic strength between the elementary charged particles, and thus the value of ~1/138 would be slightly greater in considering this electromagnetic strength, hence the contemporary calculated value with 1/137, for the value of ~1/138 is what the theory suggests from first principles. Thus, in recalibrating our "22" it brings it to 21.8 (eq.9), a recalibration to be verified in subsequent papers.

$$\frac{\lambda}{2\pi} = \frac{a^0}{2\pi \cdot 21.8} = \frac{a^0}{137} \quad (9)$$

Associated to this derivation was the value of Planck's constant paper 3 ([3]: p3, eq1):

Now, if we apply $e_p = m_p c^2$ ([2]: p16, eq.15), the mass of a photon would represent the energy of the photon E , as the photon has 0 mass in travelling at the speed of light. Here though also we are considering light fractioned by 19.8 as a quantum of light, differentiated by 19.8, $\frac{c}{19.8}$, as the equation for light was generated thus ([2]: p16, eq.15), with such differentiation. Thus, the following equation would suit:

$$e_c \cdot f = E \cdot \left(\frac{c}{19.8}\right)^2 \quad (1)$$

Now, if we change the equation to look like $E = e_c \left(\frac{19.8}{c}\right)^2 f$, then $e_c \left(\frac{19.8}{c}\right)^2$ is by our knowledge of the Planck equation $E = hf$ [8] the value for h .

Is the value the same?

The value $e_c \left(\frac{19.8}{c}\right)^2$ is $7.0163 \cdot 10^{-34} \text{ C m}^{-2} \text{ s}^2$. This value is slightly higher than the value for h ($6.626 \cdot 10^{-34} \text{ Js}$) as we didn't factor in the notion that 19.8 is a held level within the atom, and when the "19.8" (21.8) standard is lifted from fine structure atomic axioms between the electron and the proton, then the value should drop 0.5 points on the fine structure gradient to 19.3, the same value the $\frac{-1}{\phi}$ was initially "out" in the initial modelling ([2]; p11, fig15).

We now get a perfect result as $e_c \left(\frac{19.3}{c}\right)^2 = 6.626 \cdot 10^{-34} \text{ C m}^{-2} \text{ s}^2$ albeit using a different set of dimensional variables.

Here, by this process, c effectively represents the link between the time-before, time-now, and time-after time-points, as a time-space circuit.

Through the papers [1-31], an atomic construct became the *key* task to *derive*. With that achieved, together with the particle qualities and associated field force carriers, through this entire process of construction, light presented itself as a wave travelling at " c " through the CMBR medium of space and associated time-points, that basic vacuum energy which was derived from the basic manner in which time-points communicate with atoms.

One interesting feature that was discovered was how light interacts with the electron shells, as though passing through a *refractive* medium, effectively extending the distance of a wavelength of light by the need for a quantum of light to follow the magnetic shell structure, the *MQS*, in the atom in a spherical helical manner ([30]: p16-17), presenting the case of light *slowing* in a medium dense with atoms, a feature known to physics as per Snell's Law, of course fundamental to the idea of the law of conservation of energy.

It is no surprise therefore that the most fundamental feature to Temporal Mechanics is the idea of a *steady state system*, namely as a principle of conservation of energy in regard to light, namely that if light appears to slow in a medium as it encounters a *MQS*, then the only way it can have its energy conserved in the medium is to give light an extra kick with frequency, a known finding in optics. Simply, if light slows as it passes through a medium, then according to $E = hf$ for that medium reference and given " h " is a *constant* for an atomic medium (as derived in paper3 ([3]: p3, eq1), then frequency must be enhanced.

In taking the next step of theory, given the CMBR is also a constant as a medium, then the frequency of light as it passes through space was naturally considered to remain constant, given the CMBR was derived to be atomic-based and generated.

Temporal Mechanics goes one step further though and presents the case of a **variable** “ h ” outside of a refractive medium, outside of the atom, that the scale “ h ” for light from the atom goes from a value of h to “1” ([13]: p9-11), effectively suggesting that the value of energy of the overall spherical wavefront of light is *increasing*, as though being created, which seems to contradict the need to conserve energy. The solution Temporal Mechanics presents here is by its very design of the time-points in space, namely that as light moves out in space, as it extends from a point out spherically, then of course that surface area becomes larger and thus represents a greater number of time-points *and* thus time-space circuits (*TSC*), *and* therefore energy, noting that the vacuum energy was derived as a *uniform* value for volume and thence surface area.

The question though is, “are there energy manifolds related to the CMBR (and not just an outer manifold specific to $E = f$ as the Oort Cloud) to further clarify the energy status and associated nature of light and particles from *SOL* to the Oort Cloud?”.

4. CMBR Manifolds

Reality exists as it does, presents phenomena as it does, and the question science asks is “how?”.

The data of physical phenomena has led physics to adopt Einstein’s Special and General theories of Relativity. Together with this is Quantum Mechanics describing light, and the Standard Model of particles explaining elementary particle phenomenon. All such models though have failed to fully link with each other, most basically as Einstein’s GR and SR being unable to account for particles that the Standard Model presents the case of existing sub-light.

In further analysis of this problem that exists between the disciplines of physics theory, the only common thread between all the disciplines is *SR* and the Λ CDM mode, namely that the energy of that proposed entire scheme arose from an event called the *big bang*, a huge type of apparent explosion where both space and time came into existence as an outpouring of mass and energy. So, in a general way, the disciplines of physics consider that time, space, energy and mass all arose from the *big bang*.

Temporal Mechanics and associated *temporal calculus* employ a different approach.

The fundamental feature to the time-point theory of *temporal calculus*, Temporal Mechanics, is the idea of time-points that interact together in the form of a wavefunction that seeks to define “ π ”. The “circle” then is a concept fundamental to “ c ”. The overall mechanism of “ c ”, of the wavefunction in reality, was proposed to represent how the dual features of “ c ”, of the electrical and magnetic components of the wavefunction derived in paper 2 ([2]: p3-11), ultimately join in the context of an overall circle in the manner of an extra-atomic time-space manifold with a subatomic/elementary time-space manifold. This was explained in paper 5 ([5]: p9, fig8):

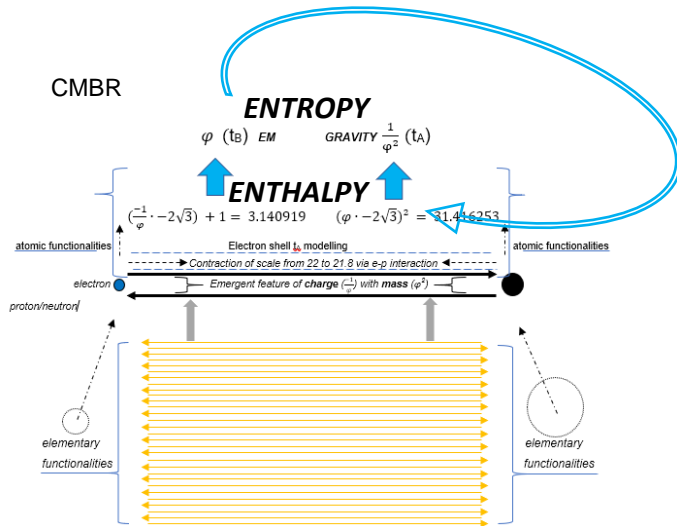

Paper 5, Figure 3: THE CMBR entropic/enthalpic event.

There the “12” factorial became a required inclusion as an integral process of “c” being a part of an overall link with space.

This “12” factorial was thence used in the formulation of the mass of the lightest particle, as derived in paper 25 ([25]: p51):

To address the TSET- e_1 mass value therefore, to note clearly here is that the idea of “e” is being considered as a “fundamental property”, and that $e_c = \frac{e}{c} = \text{fundamental property 2}$. In therefore using that same line of logic in having successfully derived the proton (and neutron) mass from charge on the TST level, and now applying the same logic to the TSET level, two things need to be factored:

- i. *The “12” factor, as presented.*
- ii. *The fact that a new charge level is being encountered as a new electron analogue (as TSET- e_1), and this would therefore invoke a new “c” factorial according to fundamental property 2.*
- iii. *$m = \frac{e}{c^2}$ ([2]: p16, eq15) still holds as $m = \frac{e}{c} \cdot \frac{1}{c} = \frac{e_c}{c}$*

Therefore, the equation for the mass of TSET- e_1 , the value of the mass gap m_{MG} , would be as follows:

$$m_{MG} = \frac{e_c}{c} \cdot \frac{1}{12} \cdot \frac{1}{c} = 1.5 \cdot 10^{-37} \text{ kg} \tag{10}$$

This would be the value for TSET- e_1 as confirmed by researchers from UCL, Universidade Federal do Rio de Janeiro, Institut d’Astrophysique de Paris and Universidade de Sao Paulo [26].

Such is an overall requirement. In that overall requirement context, the CMBR was derived from the dynamic elements of the time-space template (atom), the vacuum permittivity and permeability also derived, the charge and mass of the subatomic and elementary particles, and their field force carriers, together with a proposal for antimatter as the positron, as presented diagrammatically in papers 25 ([25]: p24, fig4) and 26 ([26]: p10, fig1):

Paper 25, Figure 4

Paper 25, Figure 4: time-space template (TST) showing the general functions from figure 16 paper 2 ([2]: p16, fig16), figure 6 paper 14 ([14]: p23, fig6), and figure 10, paper 23 ([23]: p24, fig10).

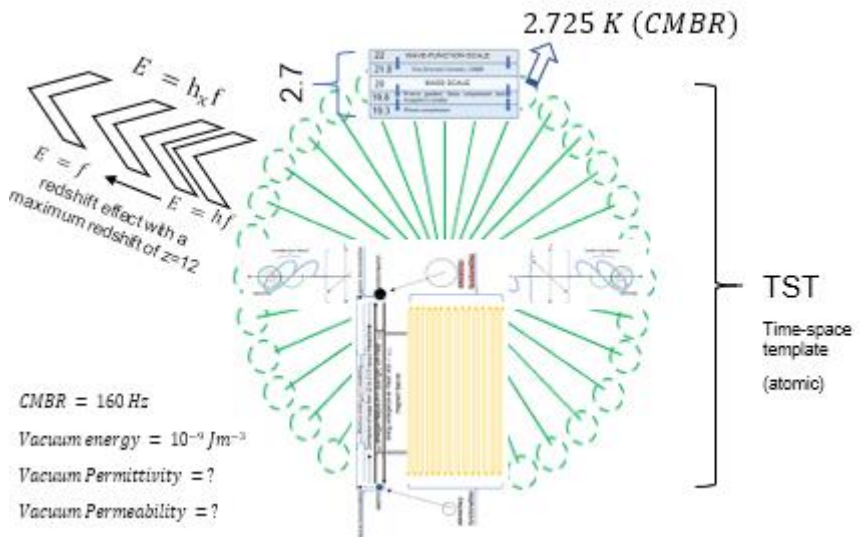

Paper 26, Figure 1

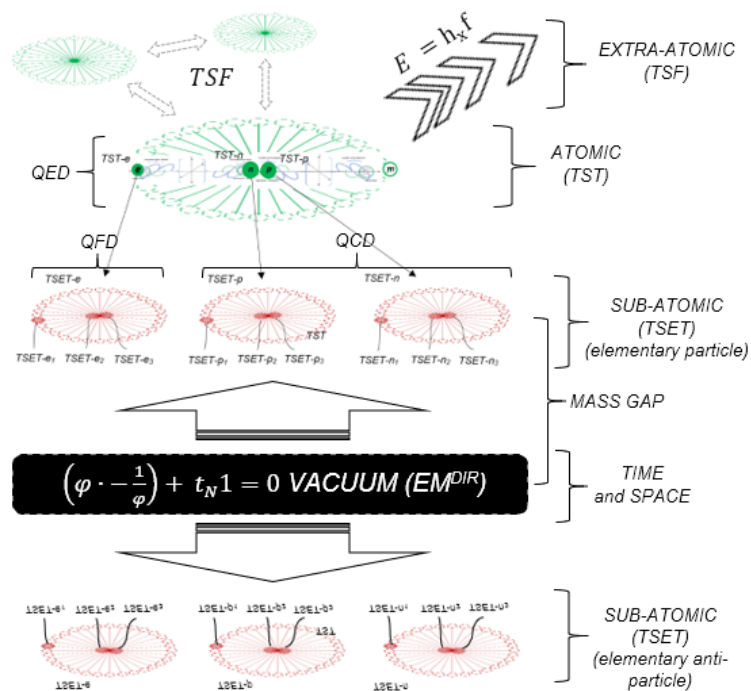

Fundamentally, *temporal calculus* as the time-equation is the fundamental key being used to explaining reality, with the time-points representing a vast time-space circuitry of energy, time as energy.

The time-space circuit is therefore the code for energy, as a wave, if the vacuum is exactly that, namely just a vacuum.

On the atomic level the value for energy was derived as $E = hf$, as presented in paper 3 ([3]: p3, eq1). Yet the behavior of light extra-atomically was given a new formalism, simply because $E = hf$ was derived relevant to the atom, not free space per se. As presented in paper 13 ([13]: p9-13), the code being employed is that this time-space circuit (*TSC*) represents energy on the broadest macroscopic level as $E = h_x f$ where $h_x = 1$, not h as Planck's constant specific for the microscopic atomic reference. This then proposed the scale of light propagating through space from a microscopic point location, say *SOL*, upon reaching the macroscopic $E = f$ level, as the distance of *SOL* to the Oort cloud, that greater perimeter of this reality, as per the following equations from paper 13 ([13]: p11, eq6-8):

Here with equation 5, E is still the energy of light, yet “ h ” is no longer fixed, yet variable as h_x from the standard value of $h = 6.626 \cdot 10^{-34} \text{ Cm}^{-2}\text{s}^2$ to a value of “1”, as per beyond then atom and this as light through space. The question now therefore is, “how far does light have to travel to have “ h ” become a value of “1”? We need simply apply the concept of the propagation of light according to a spherical wavefront, of $4\pi r^2$ (as per fig1) with the aim of finding a factor of that spherical wavelength that matches the Planck constant, h , as an inverse relationship, to incur $h_x = 1$, as per the following equation:

$$4\pi r^2 = \frac{1}{h} \quad (6)$$

And thus given $h = 6.626 \cdot 10^{-34} \text{ Cm}^{-2}\text{s}^2$:

$$r = 1.1 \cdot 10^{16} \text{ m} \quad (7)$$

Given an astronomical unit is $1.495\,978\,707 \times 10^{11} \text{ m}$, then:

$$r = 73,500 \text{ au} \quad (8)$$

The basic reason for that proposal was that the time-equation held the concept of time “now” (t_N) as the standard value of “1” regarding the time-equation, and therefore the idea of time and energy in its most basic sense, namely time as the rate of change of the time-equation in the “now” paradigm equating to the value of 1.

In short, from the microscopic scale of the atom, it was proposed that light extra-atomically seeks the macroscopic $E = f$ level as light propagates through space. The challenge there was to explain the

redshift of light in already presenting the case that “ f ” would in theory (thence far) “not” change in value from $E = hf$ to $E = f$, suggesting light propagates in space using a fixed wavelength, the signature itself of the atom it came from as an electron jump, as a consistency.

The general evidence for this consistency was presented as the CMBR, as the baseline value of energy release from an atom, as the vacuum energy. This was derived in paper 14 ([14]: p22-25) thence in paper 25 ([25]: p31, eq2-6), together with the vacuum permittivity ([23]: p30, eq5) and permeability ([23]: p30, eq7).

Quite simply, the constant CMBR value sets the stage for the consistency of frequency of light as it extends spherically in space from its source radiant atom. Thus, the energy of light as it propagates through space with a frequency matching its radiant atom is the variable, ranging from an extremely low microscopic value of $E = hf$, to an exceptionally large macroscopic value of $E = f$.

As presented, that suggestion may sound counterintuitive, as though light would gain energy as it travels through space, as a spherical wave-front, and would also suggest the Oort cloud level would represent a massive amount of energy as an overall spherical construct, like a harbor of energy, yet it is simply due to the fact of the wave-front of light advancing through space registering with more time-points, more time-space circuits, and thus energy, as a spherical wavefront.

In line with this idea nonetheless is a constant vacuum energy, calculated in the context of the Oort cloud distance as per the following, paper 14, chapter 6.2.2 ZERO-POINT ENERGY AND THE LAMB SHIFT EFFECT ([14]: p22-24):

According to contemporary physics, zero-point energy (ZPE) is considered to be the lowest possible energy that a quantum mechanical system may have. In the case here, the zero-point energy of space, that energy of space, would represent the value of E^2 as per the equation $E^2 = (-1)(d)$, as a process of energy being released to space, absorbed by space, space as that negative energy platform. Current estimates present that value to be of the order of 10^{-9} Jm^{-3} . According to the fact that these papers have successfully derived the equations for EM and gravity, the fine structure constant, the CMBR, Rydberg constant and equation, and the maximum redshift effect value, it should be possible to derive the value for the zero-point energy of space as the cosmological constant, a value derived in the context of the observed mechanism and associated data of the stars.

Therefore, in carrying the context of all previous equations in this series of papers [1-13] and thus in the context of the energy of light measured in joules and in the context of space being 3-d (distance cubed) then the value of the absorption of energy of space can be considered for the purpose of calculating the vacuum energy of space a “+1” value, and thus we have an amended equation for space as:

$$E^2 = d \tag{6}$$

Thus, given the context here of light as a wavefunction would have to default to the idea of time-now as “space”, **as it only can** (as proposed in papers 1-2 [1-2]), then **upon this level of principle definition** the idea of time and distance would be of a direct proportionality, as those units presented in paper 2 ([2]: 3-12) regarding the wavefunction, and thus:

$$E = \sqrt{d} \tag{7}$$

This value of energy now needs to be re-integrated to the atomic level, namely the relationship of this general energy level to the particle reference, and so the focus now becomes on this theory’s own standard model of particles and associated quantum mechanics (phi-quantum wave-function), as per paper 4 [4]. Paper 2, Golden Ratio Axioms of Time and Space, ([2]: p3-17) initially presented the feature of the atom in relation to energy and light (photon) which was then incorporated into the description of what was termed the Phi-Quantum Wave-Function Error Gradient ([4]: p16), the condition of time needing to define/trace “π” as the unfolding of the wave-function of light, as summarised in figure 6.

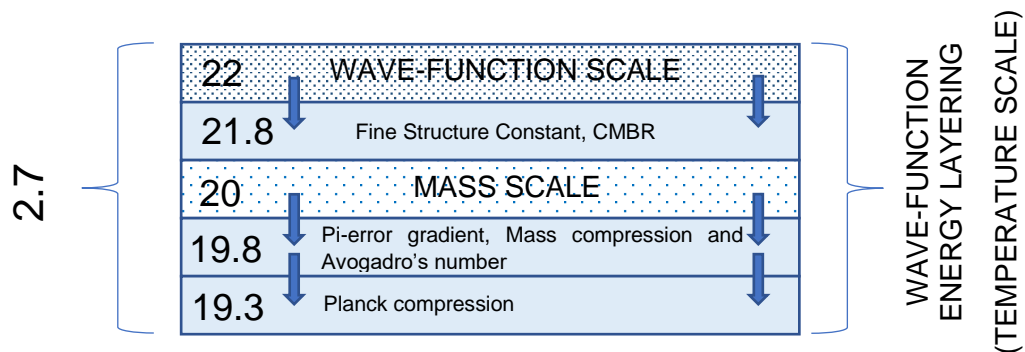

Paper 14, Figure 6

The idea of the pi error gradient was presented to calculate the value for Avogadro’s number relevant to the mass of a neutron, as in paper 4 ([4]: p16). Yet there is another feature to the phi-quantum wave-function as it becomes expressed extra-atomically, namely two key perturbation factors in regard to the mass scale, namely a $\frac{21.8}{20}$ perturbation and a $\frac{19.8}{20}$ perturbation, together representing a general pi error gradient perturbation as V_A , as per equation:

$$V_A = \frac{21.8}{20} \times \frac{19.8}{20} = 1.079 \tag{8}$$

Another feature to consider is that the compression that occurs regarding mass on this phi-quantum wave-function level is of the order of $\frac{0.2}{19.8}$, or in other words “0.2” (20 –

19.8) is lost to space for every phi-quantum wave-function atomic reference 19.8 length result. And this would happen “per” the maximum distance of space in total factored with V_A . This is useful in calculating the effect of negative energy (space), the “vacuum energy of space”, on the atomic reference, a case of relating this value to the overall maximum theorised distance of light propagating in space. As per paper 13 ([13]: p11), the distance of Oort region to the sun is $\sim 1.1 \times 10^{16}m$. Thus, the factor level for distance regarding E^2 for space would be:

$$\frac{0.2}{19.8} \times \frac{V_A}{1.1 \times 10^{16}} \quad (8)$$

Now, incorporating this in with equation 7, the following value for energy per metric volume of space (in Jm^{-3}) is arrived at thus:

$$\sim 10^{-9} Jm^{-3} \quad (9)$$

This value of energy would represent a basic background level of energy that is absorbed **from** atomic matter, from the fundamental process of $E = hf$, from the atom, a value consistent with the estimated value of the vacuum energy of space [33].

To explain the Lamb shift is such, as it would be the natural effect of $E = f$ on anything that exists in the system “within” the atom, that which would be responsible for the vacuum energy of space itself to address the idea itself of being that complete $E^2 = (-1)(d)$ construct, a natural background effect on the atom. What “frequency” would such energy be released from the atom at? Here, on the atomic level, in the context of $t_N = 1$, as the spatial reference, as defined by the time-algorithm, $t_N = \frac{1}{f}$ and thus $d = \frac{1}{f}$, frequency would represent:

$$\sim 10^9 Hz \quad (10)$$

This value is consistent with the measured value of the Lamb shift effect of $\sim 1GHz$.

This represents an idea of energy for space, more precisely per the volume of space. One thing needs to be made clear though, namely the Oort cloud is the proposed limit of this spatial volume of energy, beyond which energy and thus mass cannot exist, according to the mathematics of *temporal calculus*.

So, the proposal is that this Oort Cloud level represents a *macroscopic* elementary particle level, as though beyond that level is no energy, the void.

Another basic issue to note is that “c” is how time measures space. And so therefore to measure space from the ultimate macroscopic level, from the Oort Cloud level of $E = f$, the *volume* of that space needs to be calculated and then factored *in* toward a microscopic level by a value of “c” to that inner

volume level, as what would be a measure of a “c”-factored level *within* the most ultimate *macroscopic* level.

This idea was presented in paper 25 ([25]: p50-51) regarding the *microscopic* level in the manner of calculating the mass of the lightest elementary particle in calculating what exists as mass *below* the structure of a subatomic mass, using a factor of “c” and “12” for the mass of the proton, stepping *below* that.

Here though the process of the macroscopic scale is different to the microscopic scale, as it can only be, as they are two very different things; the thinking is to use a basic scaling of “c” with the value of energy in terms of *volume*, and not mass (mass, as was used on the microscopic scale), namely the volume of the Solar System to the Oort cloud, specifically as $\frac{4}{3}\pi r_o^3$ where r_o is the distance of *SOL* to the Oort cloud, derived to be $1.1 \cdot 10^{16} m$ (73,500 *au*), as per equation 1:

$$\frac{4}{3}\pi r_o^3 = \frac{4 \cdot \pi \cdot (1.1 \cdot 10^{16})^3}{3} = 5.58 \cdot 10^{48} m^3 \quad (1)$$

This value is then proposed to be factored *back* a value of “c”, taken within itself, as “c” is the standard of measurement between time-points measuring space.

So, the calculation here aims to derive what the next manifold would be from the overall ultimate manifold of $E = f$, from that ultimate macroscopic manifold of $E = f$, as follows:

$$\frac{5.58 \cdot 10^{48}}{c} = 1.86 \cdot 10^{40} \quad (2)$$

The value of “r” for this value, this new value for r, say r_H , then equates to the following:

$$\frac{4}{3}\pi r_H^3 = 1.86 \cdot 10^{40} \quad (3)$$

$$r_H = 1.643 \cdot 10^{13} m \quad (4)$$

$$r_H = 110 au \quad (5)$$

This value would represent the basic time-space manifold *within* the macroscopic $E = f$ manifold.

Therefore, if the $E = f$ manifold represents the process of mass disintegrating to a macroscopic sub-light level, to a macroscopic elementary particle level, as a particle zone in time-space, then this new manifold of distance r_H from *SOL* would represent the basic **subatomic** level, a **plasma** level, as per the following diagram.

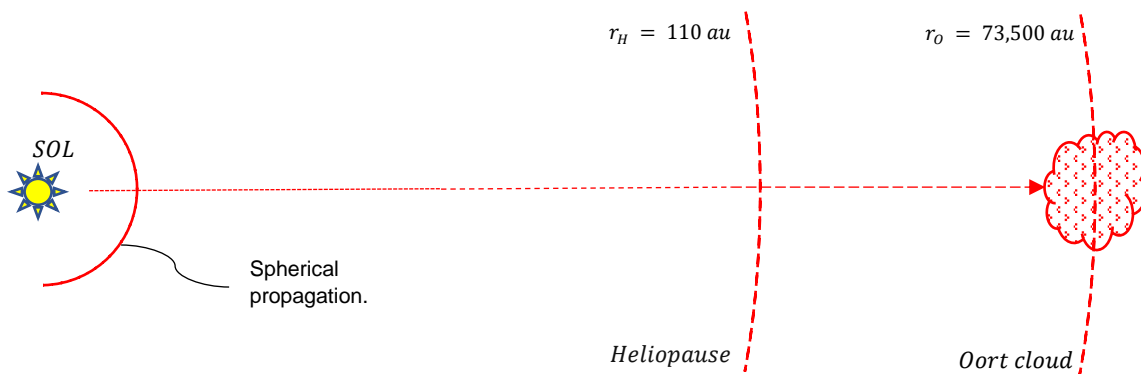

Figure 1: a universal scale from a source of light as the Sun outwards in a spherical wavefront of light a distance of $r_O = 73,500 \text{ au}$, tracked back a time-scale measurement of “c” to the Heliopause as $r_H = 110 \text{ au}$.

Astrophysics knows r_H as the Heliopause [35].

Once again, r_H would represent the basic scaling from the macroscopic $E = f$ level to a universal level of “c” within that zone, to the next most basic level, and here this is proposed to be the macroscopic **subatomic** level, a level of quantum stagnation, where in all appearance the plasma-styled solar wind would appear to measure equally with any *apparent* interstellar wind, leading to a type of static plasma sphere. Thus notably, at and beyond this Heliopause would be a marked increase in plasma particle activity. To what point though?

There is still the issue of factoring the value of “12” on the Oort Cloud level, that required ultimate macroscopic $E = f$ level, as presented in paper 13 ([13]: p11-12) to fulfil the general entropy-enthalpy equation for energy, as was appropriated on the microscopic level in paper 25([25]: p50-51).

The thinking here with this Oort cloud macroscopic manifold and associated Heliopause manifold is that the value of “12” would be *factored “into”* “c” by a certain mechanism **inverse** to what was proposed on the microscopic level, namely as a process of *enhancing* the Heliopause by a factor of 12 regarding *volume*. Note that this process would be an *inverse* application to the process used on the elementary particle level, for here is a new process, a *macroscopic* process, **not** a *microscopic* process, and thus the process of application of the “12” factorial would be *inverse* to how it was applied on the microscopic scale, despite still using “c” as a measurement standard between time-points in space as was used on the microscopic scale.

The process here therefore is taking equation 3 of the Heliopause and factoring it out to the Oort Cloud level by a factor of 12, as follows, equation 6:

$$\frac{4}{3}\pi r_H^3 \cdot 12 = 2.23 \cdot 10^{41} \quad (6)$$

The new value here for r_H , say, r_B , is therefore as follows:

$$\frac{4}{3}\pi r_B^3 = 2.23 \cdot 10^{41} \quad (7)$$

$$r_B = 3.75 \cdot 10^{13} \text{ m} \quad (8)$$

$$r_B = 250 \text{ au} \quad (9)$$

Astrophysics has proposed a manifold meeting a similar description as the Bow Shock ($\sim 230 \text{ au}$) [36]. This can be demonstrated in the following diagram:

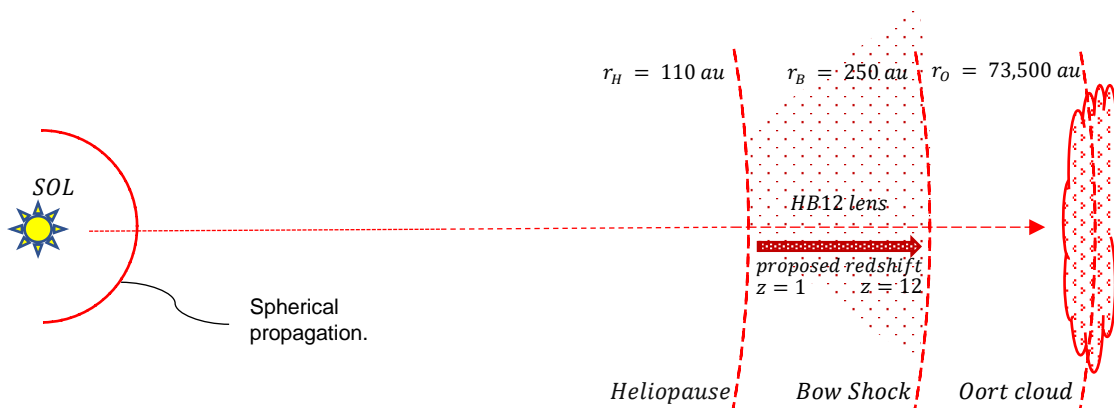

Figure 2: a universal scale from a source of light as the Sun outwards in a spherical wavefront of light a distance of $r_O = 73,500 \text{ au}$, tracked back a time-scale measurement of “c” to the Heliopause as $r_H = 110 \text{ au}$, while then factored by “12” upon the r_H level to arrive at r_B , the proposed Bow Shock manifold.

The thinking of this region is that it represents, in theory, a general layer where the CMBR *bleeds down* as the $z = 1 > z = 12$ redshift process, from the Heliopause to the Bow Shock, noting that “c” is being accompanied here with “12” as a measure of distance between time-points in space, here as a factor of “12”, yet not only this, yet doing this while light and associated plasma behaves like a type of pressure “shock” front to the space beyond which (towards the Oort cloud) where matter in theory would disintegrate, and light lose its integrity.

Of course, once again, this is proposed to be a different process to what happens on the *microscopic* (subatomic to elementary particle) level (as presented in paper 25 ([25]: p50-51)); on the *microscopic* subatomic level, although light is factored from the mass of the proton into the elementary particle level, so too is “12”, as “12” represents that required process of atomic interface (subatomic particle) to space (elementary particle), as presented in paper 5 ([5]: p9 fig8). Here on the macroscopic scale though of $E = f$, the 12 factorial is being factored *into* the structure of “c” itself *inversely* to the microscopic scale.

Thus, the proposal is that light annexes the “12” factorial from the Heliopause to the Bow Shock, like a quantum pressure differential, a type of universal lens for the solar system, say the *HB12 lens*.

As it shall be highlighted in the following paper (Temporal Mechanics (C): Time-Space Manifolds), this feature works well with explaining the redshift of light and associated lensing phenomena delivered by this *HB12* lens for plasma particles, resulting in the visual effect of the stars.

The Voyager 1 and 2 spacecraft missions are intending to confirm and study the *termination shock*, and *heliopause* [37]. Currently as of 18th January 2021, Voyager 1 is ~ 151 *au* from the Sun, and Voyager 2 126 *au* from the Sun, meaning they have yet to reach the theorised *Bow Shock*. Here the proposal is that the Voyager missions will be unable to record anything beyond the Bow Shock owing to the breakdown of the general plasma field state of time-space there, and will undoubtedly experience system-performance issues in this *HB12* region leading to the Bow Shock.

Image 1: By Interstellar Probe, Jet Propulsion Laboratory, NASA - <http://interstellar.jpl.nasa.gov/interstellar/probe/introduction/scale.html>, Public Domain, <https://commons.wikimedia.org/w/index.php?curid=3531907>

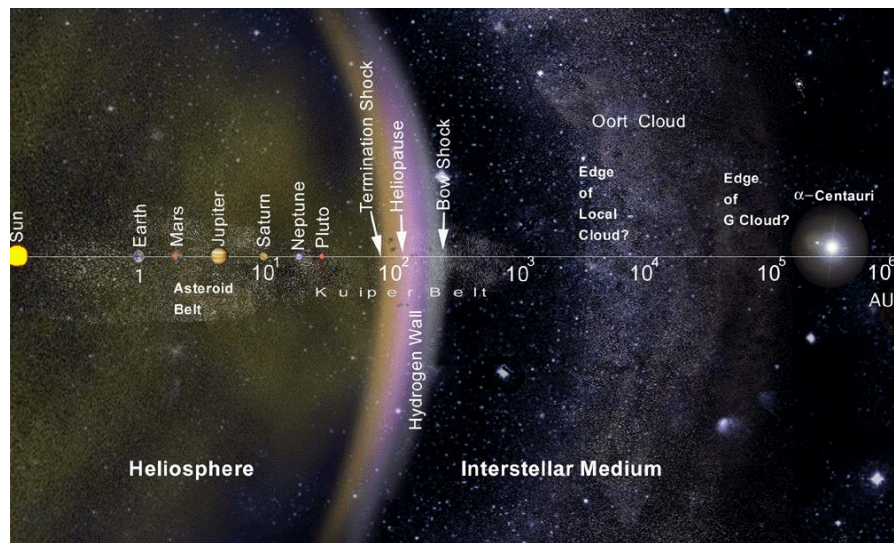

In short, the tough question the next paper shall address is, “what lensing effect does the *HB12* zone play with the phenomena of light both within the shell/cavity of that lens structure (solar system) and intrinsic to that lens structure”?

Clearly given the type of structure the *HB12* is, as a medium of varying light and particle densities, there is going to be a host of visual effects in play, not to mention holography, reflection, and magnification, a magnified fractal holography of light (given the time-equation is a golden ratio equation of a sequence of events in time), all to be discussed in the next paper.

One issue though to now present central to this proposal is that given the CMBR as the vacuum energy is being promoted as the time-space *constant (TSA)* for the overall reality plane as a type of axis, what though indeed determines the overall shape of this reality, for instance the solar system *plane* of energy and mass? The feature that needs to be examined here is how matter and energy most fundamentally form in this overall proposed arena, and here the case to be presented is an explanation of particle “pair production”, of the most basic elementary particles as the electron and positron, matter and antimatter, and the role antimatter plays with that CMBR plane.

5. CMBR Manifold particle and energy generation and dynamics

Contemporary physics understands antimatter formation through the theoretic idea of particle “*pair production*” via the Higgs mechanism [38].

According to Temporal Mechanics, “pair production” is essentially the idea of an EM^{DIR} (EM Destructive Interference Resonance) field generating mass (both matter and antimatter), as presented in paper 30 ([30]: p13-14).

To note is that classical particle “pair production” in using the photon model for light requires sending the photon, high energy, into a particle, yet with Temporal Mechanics the process is more easily achieved with a wave model through executing EM^{DIR} , essentially yielding the same result particle “pair production”, of course at lower energies, a technical issue explained in paper 30 ([30]: p13).

Although through the papers of Temporal Mechanics the EM^{DIR} process has been proposed to produce matter, it was highlighted that EM^{DIR} also creates *antimatter*, as per paper 25 figure 15 ([25]: p48, fig15) where of course the EM^{DIR} process leads to the formation of **all** particles, including the antiparticle, and thus most basically an electron and its antimatter equivalent, the positron, as per the steps of mass formation explained through papers 23 to 25 [23-25], initially from the electron, then to the proton and neutron, thence deriving the lightest neutrino ([25]: p51, eq10).

Essentially, the EM^{DIR} process is a process of particle “*pair production*” from the annihilation of the quantum of light (explained here as a destructive interference resonance and not photon annihilation). As it therefore seems, particle “pair production” as “Destructive Interference Resonance (DIR)” almost qualifies that there is this fundamental balance in reality of particle-antiparticle formation, explained in paper 25 ([25]: p48, fig15) as a type of **chirality**. Yet why the general result of matter over antimatter?

Temporal Mechanics derives that antimatter is an *entropic* event, meaning it doesn’t last very long, compared to matter, matter which forms in an *enthalpic* manner, associated to the *MQS* ([30]: p18-20) and associated *ABE* ([27]: p12-14) process, and therefore antimatter giving itself to the process of *MQS* formation, which is a noted fact, namely that positronic decay following a particle “pair production” process is associated to the formation of a *MQS*, as presented in paper 30 ([30]: p19), a *MQS* which is also associated to the generation of the CMBR, and therefore the feature of antimatter closely confirming the initial idea itself presented by Dirac, namely that space has associated to it an extra kick in the form of antiparticles providing kinetic energy to mass thence gravity, as explained in paper 7 ([7]: p2-3), here though more specifically granted to the CMBR via the *MQS*.

Thus, mass is proposed to form as a process of particle “pair production”, as an EM^{DIR} phenomena, of destructive interference resonance of two EM wavefunctions, a *destructive interference of time-point wavefunctions that negate each other to produce mass in the form of an electron and positron*, as particle “pair production”.

The issue is why an electron and positron would most basically be formed, the key question here being why an *electron* would be formed, *and why a positron would accompany the formation of an electron, and why then the life of the positron would be short-lived.*

It should be noted that the subatomic and elementary particles were derived **from** the electron, as per paper 23 ([23]: p21-23), the electron being that entity in the “cloud”, the *MQS*, of uncertain location, yet fundamental nonetheless to the wavefunction from which it was derived. In other words, the electron is the closest relative to the PQWF, the golden ratio wavefunction (phi-quantum wavefunction ([2]: p3-11)). So logically when two PQWF undergo EM^{DIR} , as a creation of mass, the primary particle formed would be an electron, as per a mechanism of the addition of energy, of enthalpy, the addition of energy of the two PQWF’s undergoing EM^{DIR} . Yet not only this, but this electron would also be accompanied by its entropic counterpart, the positron, in upholding the required *chirality* of the golden ratio time-equation, despite the positron annihilating almost immediately.

Quite simply, when a wavefunction cancels itself out, at its core it is a type of inert concept of energy, and thus must feature an equal weighting of enthalpy (as the electron forming) and entropy (as the positron forming). Yet the paradox here is that the time-equation is entropic, and so the life of the positron in being entropic (as energy release) is exactly that, namely it almost immediately self-annihilates.

The positron was therefore considered as the most likely *natural* sole antimatter entity. Owing to its entropic self-annihilation, this antimatter self-annihilation was proposed to provide an extra kick of energy for space, an idea that was first proposed by Dirac as the Dirac sea, to explain how when mass attracts each other their respective kinetic energy rises. This was presented in paper 7 ([7]: p2-3).

The question then is what governs where particle “pair production” happens.

On an overall scale, it was proposed to be based on the fundamental time-space principles in play, the time-space principles as presented initially in paper 24 ([24]: p23, fig5), thence the elementary particle principles ([25]: p38, p40), and even more fundamentally as based on the 5 principles of simplicity ([30]: p12-13), all acting together to result in the overall play of particles and their field-force wave carriers, to result in the shape of reality; in general, there are microscopic and macroscopic particle and field structures interacting with one another regarding EM and G based on the constant dynamic that exists between particles and their wave field carriers.

One thing to note is that with the production and existence of mass, there was proposed to exist an overall plane of activity of mass formation, as presented in the case of the time-space pulse (TSP) ([23]: p27-28). The implication here is that in this “plane” of mass activity would be an extra “kick” of vacuum energy care of the positron annihilation, or in other words, in the mass-plane of activity would exist an **enhanced** CMBR value. Such is the issue found with the “Axis of Evil”, namely that the plane of the solar system falls in line with the intensity of the space plane of the CMBR reading.

There is one added feature though to time-equation regarding particle “pair production”, and that involves *Euler’s equation*, which was noted to detail the weak nuclear force, as presented in paper 15 (15]: p11, eq6), as per $e^{i\pi} + 1_{t_N} = 0_{t_A}$. According to the time-equation, if t_B were to be plugged in with a value of φ and $-\frac{1}{\varphi}$ as a pair production, the resultant equation comes to “0”, as per the following equation, equation 10:

$$\varphi \cdot \frac{-1}{\varphi} + 1 = 0 \quad (10)$$

Such then was proposed to represent an overall time-equation condition with space, as a type of particle-antiparticle unity. Physics knows this as the singular particle pair, as hypothesised by *Ettore Majorana* in 1937 [39]. In the case here, Euler's equation in applied to *temporal calculus* prescribes, as a process of the radioactive decay of particles, spontaneous particle pairing *annihilation*, namely that this singular hypothesised particle would feature in a process of the weak force of natural particle radioactive decay, moreover that such a particle would result in a null time-equation event, a *spontaneous* phenomenon, yet hypothetical nonetheless when the case would call for it.

The end result of all this is that the entire system is proposed to be powered by time-points resolving their location in space with one another, limited by the interaction of the time-points in space as "c", as that metric that explains the link between time-points in space, how space can be measured as 3-dimensions, noting that what keeps everything dynamic as the arrow of time is described/prescribed by the time-space circuit (*TSC*) and associated time-space constants (*TSA*) of "c" and "A" respectively.

6. EM^{DIR} Antimatter Production and Propulsion

There is a way to demonstrate the particle "pair production" effect.

The basic proposal is to construct an EM^{DIR} field and to demonstrate there is a particle "pair production" in play by measuring two key issues:

- Positive charges repel, and therefore positrons would resist a positive charged field.
- Positrons annihilate rapidly in the non-vacuum medium through particle interactions.

The proposal is therefore that there can be constructed an EM-DIR (EM^{DIR}) Antimatter Thruster as an apparatus demonstrating this Temporal Mechanics theory central to the idea of a newly termed electromagnetic destructive interference resonance (EM^{DIR}) field executing particle "pair production", and thus the creation of an electron and a positron.

As per all the preceding experiments (EX-1 > EX-6) [7][12][17][19][22], the EM^{DIR} field is proposed to be created in an EM^{DIR} resonance chamber. In utilising this field, electron and positron production can be demonstrated by having the positrons in the EM^{DIR} resonance chamber repel a positively charged plate in the EM^{DIR} resonance chamber; thrust here would be generated in the EM^{DIR} resonance chamber by the repulsion of the positively charged plate away from the short-lived positrons, creating a singular component of thrust as the positrons quickly annihilate.

As a simple proposal, the EM^{DIR} Antimatter Thruster would comprise of a resonance chamber (1.) that contains the EM^{DIR} field, an internal aerial (2.) providing for the signature destructive interference resonance (the EM^{DIR} field) powered by the RF source (5.), a positively charged EM source located at the distal end of the resonance chamber (3.) or located anywhere else on the resonance chamber (4.) that repels the generated positrons, a RF (radio frequency) power-source (5.) applied to the aerial (2.) within the resonance chamber (1.) to generate the EM^{DIR} field, a positive charge generator (6.) to supply the

positive charged EM plates (3.)(4.), and an overall containing bulkhead structure to harness the thrust (7.), all as per figure 3:

Figure 3: proposed basic EM^{DIR} Antimatter Thruster design.

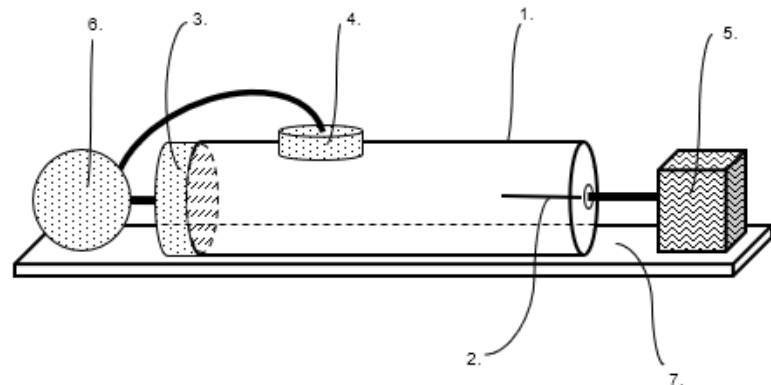

In further describing this process, the resonance chamber (1.) would typically be cylinder designed such that the length and width of the chamber represents any factor of the input RF wavelength of the incoming RF field plus $\frac{1}{2}$ the RF wavelength (out of phase), the point being to effect maximum destructive interference resonance. At the distal end of the resonance chamber (1.) would be placed the positively charged plate structure (3.) to repel the generated albeit short-lived positrons in the resonance chamber, noting the positive charged plate can be configured anywhere on the EM^{DIR} chamber structure (4.). This positively charged structure (3.) would ideally attach to the same general bulkhead without discharging itself to the wall of the EM^{DIR} chamber (6.) therefore providing a particular zone of thrust for the entire bulkhead EM^{DIR} Antimatter Thruster based on that locality of positive charge on the chamber, a locality of charge which opposes the positrons own positive charge.

Once again, the proposal here is different to the standard theory of generating particle “pair production”, entirely the opposite approach to CERN’s process. Here, high energy light is not sent into an atomic nucleus. Instead, EM wavefunctions are brought into *destructive interference resonance (DIR)* to effect particle “pair production”. The problem here though, as already noted with experiments 1-6, is that doing such produces a **large** amount of energy in a very short period of time, not fully understood at the time of those experiments, yet now better understood and accommodated for as per the particle-antiparticle generation effect of the EM^{DIR} field.

The first and second experiments with this EM^{DIR} field, paper 7 ([7]: p6-16), are a good example of what happens there [40], not something to expect after only a few seconds of EM^{DIR} activation using highly inert materials, namely that amount of energy release. So after much theory and associated research, those results were deliberately designed to be toned down, building sequentially with theory a way to contain those energies and what could be going on there, electric or magnetic, how that could relate with a specific aerial design, and so on, now here though arriving at this new proposal, given how consistently through the testing process the apparatus if given the chance would break down owing to excessive energy production.

7. Conclusion

The interesting and complicated feature of Temporal Mechanics is that to explain reality *in theory*, as a *theory*, one must *start* in being *entirely theoretical*, one must *begin* that process as a concept of *pure theory*. Not only that, but one must also finish with all the theory matching with all the known **physical data** in the same manner that pure theoretic proposal began with, as what a theory should be, **complete** as a *pure theory*. Explaining reality, sure, yet as a "theory"; theory is not reality, for theory is a way to explain reality based on our perceptive constraints, at best.

Conversely, one observation with relativity theory is that it is, seems to be, asking mass-inertia-momentum to tell the story of reality. Such is not *pure theory* though, yet the philosophy of *wait and see what happens with physical objects in space*. A theory of *reality* basing itself on mass-inertia-momentum will never properly *best achieve* explaining reality as a *pure theory*, as relativity theory highlights and those associated mathematical formalisms and associated problems found, especially with cosmology such as the "Axis of Evil" and "Horizon" problems, problems that Temporal Mechanics proposes are solvable by using a theory with a greater focus on the dimension of time, namely that at c time does not pass.

Temporal Mechanics has designed *temporal calculus* on the human temporal perceptive ability, and in doing so has developed an algorithm presenting the case of time-points forming time-space circuits. Such a process has thence derived all phenomena known associated to the atom, together with deriving the vacuum energy, vacuum permittivity, and vacuum permeability, while also deriving the known cosmographic limit as the Oort cloud and CMBR limit as the Bow Shock. The question now is what phenomena of light is proposed to exist between the Heliopause and Bow Shock, that *HB12 lens*, and how is that observed from within, from our reference on Earth, as though in view of a giant spherical holographic fractal plasma screen, to be presented in the next paper outlining the time-space manifolds.

Conflicts of Interest

The author declares no conflicts of interest; this has been an entirely self-funded independent project.

References

1. Jarvis S. H. (2017), Gravity's Emergence from Electrodynamics, DOI: [10.13140/RG.2.2.35132.28804/1](https://doi.org/10.13140/RG.2.2.35132.28804/1), <https://vixra.org/abs/1704.0169>
2. Jarvis S. H. (2017), Golden Ratio Axioms of Time and Space, DOI: [10.13140/RG.2.2.30099.12327/1](https://doi.org/10.13140/RG.2.2.30099.12327/1), <http://vixra.org/abs/1706.0488>
3. Jarvis S. H. (2017), The Emergence of Consciousness from Chaos, DOI: [10.13140/RG.2.2.23388.23683/1](https://doi.org/10.13140/RG.2.2.23388.23683/1), <http://vixra.org/abs/1707.0044>
4. Jarvis S. H. (2017), Phi-Quantum Wave-Function Crystal Dynamics, DOI: [10.13140/RG.2.2.10045.10726/3](https://doi.org/10.13140/RG.2.2.10045.10726/3), <http://vixra.org/abs/1707.0352>

5. Jarvis S. H. (2017), Time as Energy, DOI: [10.13140/RG.2.2.23466.88009/3](https://doi.org/10.13140/RG.2.2.23466.88009/3),
<http://vixra.org/abs/1711.0419>
6. Jarvis S. H. (2018), The Relativity of Time, DOI: [10.13140/RG.2.2.13400.55044/3](https://doi.org/10.13140/RG.2.2.13400.55044/3),
<http://vixra.org/abs/1801.0083>
7. Jarvis S. H. (2019), Golden Ratio Entropic Gravity: Gravitational Singularity Field Testing, DOI:
[10.13140/RG.2.2.35399.14246/1](https://doi.org/10.13140/RG.2.2.35399.14246/1), <http://vixra.org/abs/1904.0485>
8. Jarvis S. H. (2019), The Golden Ratio Time Algorithm, DOI: [10.13140/RG.2.2.35399.14246/2](https://doi.org/10.13140/RG.2.2.35399.14246/2),
<http://vixra.org/abs/1905.0081>
9. Jarvis S. H. (2019), The Physics Chimera, DOI: [10.13140/RG.2.2.28499.02084/1](https://doi.org/10.13140/RG.2.2.28499.02084/1),
<http://vixra.org/abs/1906.0127>
10. Jarvis S. H. (2019), The Conception of Time, DOI: [10.13140/RG.2.2.10258.71363/1](https://doi.org/10.13140/RG.2.2.10258.71363/1),
<http://vixra.org/abs/1906.0441>
11. Jarvis S. H. (2019), Space, and the propagation of Light, DOI:
[10.13140/RG.2.2.15833.67689/1](https://doi.org/10.13140/RG.2.2.15833.67689/1), <http://vixra.org/abs/1908.0388>
12. Jarvis S. H. (2019), Space, and the Nature of Gravity, DOI: [10.13140/RG.2.2.17320.93443](https://doi.org/10.13140/RG.2.2.17320.93443),
<http://vixra.org/abs/1909.0656>
13. Jarvis S. H. (2019), Space, and the Redshift Effect, DOI: [10.13140/RG.2.2.14287.43683/1](https://doi.org/10.13140/RG.2.2.14287.43683/1),
<http://vixra.org/abs/1911.0064>
14. Jarvis S. H. (2019), Solving The Cosmological Constant Problem, DOI:
[10.13140/RG.2.2.25730.63686/2](https://doi.org/10.13140/RG.2.2.25730.63686/2), <http://vixra.org/abs/1912.0451>
15. Jarvis S. H. (2020), Hybrid Time Theory: “Euler’s Formula” and the “Phi-Algorithm”, DOI:
[10.13140/RG.2.2.13078.91205/2](https://doi.org/10.13140/RG.2.2.13078.91205/2), <http://vixra.org/abs/2001.0233>
16. Jarvis S. H. (2020), The Hybrid Time Clock as a Function of Gravity,
DOI: [10.13140/RG.2.2.27053.64487/1](https://doi.org/10.13140/RG.2.2.27053.64487/1), <http://vixra.org/abs/2001.0401>
17. Jarvis S. H. (2020), Hybrid Time Theory: Cosmology and Quantum Gravity (I),
DOI: [10.13140/RG.2.2.20045.79847/1](https://doi.org/10.13140/RG.2.2.20045.79847/1), <http://vixra.org/abs/2003.0659>
18. Jarvis S. H. (2020), Scientific Principles of Space, Time, and Perception,
DOI: [10.13140/RG.2.2.16207.84648/1](https://doi.org/10.13140/RG.2.2.16207.84648/1), <http://vixra.org/abs/2004.0260>
19. Jarvis S. H. (2020), Hybrid Time Theory: Cosmology and Quantum Gravity (II),
DOI: [10.13140/RG.2.2.23972.22405](https://doi.org/10.13140/RG.2.2.23972.22405), <http://vixra.org/abs/2005.0053>
20. Jarvis S. H. (2020), Mathematical Principles of Time and Energy,
DOI: [10.13140/RG.2.2.34441.67683/3](https://doi.org/10.13140/RG.2.2.34441.67683/3), <http://vixra.org/abs/2005.0179>
21. Jarvis S. H. (2020), Dimensional Mechanics of Time and Space,
DOI: [10.13140/RG.2.2.21001.88169/1](https://doi.org/10.13140/RG.2.2.21001.88169/1), <http://vixra.org/abs/2005.0286>
22. Jarvis S. H. (2020), Dimensional Thermodynamics, DOI [10.13140/RG.2.2.29715.71202/2](https://doi.org/10.13140/RG.2.2.29715.71202/2),
<http://vixra.org/abs/2006.0194>
23. Jarvis S. H. (2020), Time-Space Wave-Mechanics, DOI [10.13140/RG.2.2.10565.68320/3](https://doi.org/10.13140/RG.2.2.10565.68320/3),
<http://vixra.org/abs/2007.0223>
24. Jarvis S. H. (2020), Temporal Calculus (The Calculus of Time-points in Space),
DOI: [10.13140/RG.2.2.15362.09929/3](https://doi.org/10.13140/RG.2.2.15362.09929/3), <http://vixra.org/abs/2008.0111>

25. Jarvis S. H. (2020), Temporal Calculus: solving the “Yang-Mills Existence and Mass Gap” problem., DOI: [10.13140/RG.2.2.33774.43843/2](https://doi.org/10.13140/RG.2.2.33774.43843/2), <http://vixra.org/abs/2008.0226?ref=11562969>
26. Jarvis S. H. (2020), Temporal Calculus: Time Scaling Space, DOI: [10.13140/RG.2.2.28539.75043/2](https://doi.org/10.13140/RG.2.2.28539.75043/2), <https://vixra.org/abs/2009.0091>
27. Jarvis S. H. (2020), Temporal Calculus: Resolving Elementary Particle Formation and Confinement, DOI: [10.13140/RG.2.2.20191.07844](https://doi.org/10.13140/RG.2.2.20191.07844), <https://vixra.org/abs/2009.0177>
28. Jarvis S. H. (2020), Temporal Calculus: Resolving Einstein’s Theory of Relativity (Special and General), DOI: [10.13140/RG.2.2.12474.21447/1](https://doi.org/10.13140/RG.2.2.12474.21447/1), <https://vixra.org/abs/2010.0017>
29. Jarvis S. H. (2020), Time and Non-Locality: Resolving Bell’s Theorem, DOI: [10.13140/RG.2.2.12651.98086](https://doi.org/10.13140/RG.2.2.12651.98086) (researchgate.net), <https://vixra.org/abs/2011.0002>
30. Jarvis S. H. (2020), Non-Local Time-Point Theory: Magnetic Quantum Shell (MQS) Modelling, DOI: [10.13140/RG.2.2.11032.83206/2](https://doi.org/10.13140/RG.2.2.11032.83206/2), <https://vixra.org/abs/2012.0040>
31. Jarvis S. H. (2021), Temporal Mechanics (A): Time-Space Circuits, DOI: [10.13140/RG.2.2.28879.10407](https://doi.org/10.13140/RG.2.2.28879.10407), <https://vixra.org/abs/2101.0022>
32. "The Energy of Empty Space That Isn't Zero". www.edge.org. 2006-05-07. Retrieved 2018-08-05.
33. Hans Christian Von Bayer, The Fermi Solution: Essays on Science, Courier Dover Publications (2001), [ISBN 0-486-41707-7](https://www.doverpublications.com/9780486417077), page 79
34. Carrigan, Richard A.; Trower, W. Peter (1983). Magnetic Monopoles. doi:10.1007/978-1-4615-7370-8. [ISBN 978-1-4615-7372-2](https://www.doverpublications.com/9781461573722).
35. NASA's Voyager 1 Spacecraft Nearing Edge of the Solar System". Space.Com. 13 December 2010. Retrieved 24th January 2021.
36. Nemiroff, R.; Bonnell, J., eds. (24 June 2002). "The Sun's Heliosphere & Heliopause". Astronomy Picture of the Day. NASA. Retrieved 8 March 2016.
37. <https://voyager.jpl.nasa.gov/>, page accessed 24th January 2021.
38. Bernardi, G.; Carena, M.; Junk, T. (2007). "Higgs bosons: Theory and searches" (PDF). Review: Hypothetical particles and Concepts. Particle Data Group.
39. Majorana, Ettore; Maiani, Luciano (2006). "A symmetric theory of electrons and positrons". In Bassani, Giuseppe Franco (ed.). Ettore Majorana Scientific Papers. pp. 201–33. doi:10.1007/978-3-540-48095-2_10. [ISBN 978-3-540-48091-4](https://www.doverpublications.com/9783540480914). Translated from: Majorana, Ettore (1937). "Teoria simmetrica dell'elettrone e del positrone". Il Nuovo Cimento (in Italian). **14** (4): 171–184. Bibcode:1937NCim...14..171M. doi:10.1007/bf02961314. S2CID 18973190
40. <https://www.youtube.com/watch?v=KbQxy8kIS-8>, page accessed 24th January 2021.