

Bendable Light Communication

Bendable light beams have significant applications in [optical manipulation](#), [optical imaging](#), [routing](#), [micromachining](#) and [nonlinear optics](#). [26]

Karimi's team has successfully built and operated the first-ever quantum simulator designed specifically for simulating cyclic (ringed-shaped) systems. [25]

A new Tel Aviv University study explores the generation and propagation of excitons in 2D materials within an unprecedented small time frame and at an extraordinarily high spatial resolution. [24]

An international team of researchers led out of Macquarie University has demonstrated a new approach for converting ordinary laser light into genuine quantum light. [23]

Beyond the beauty of this phenomenon, which connects heating processes to topology through an elegant quantization law, the results reported in this work designate heating measurements as a powerful and universal probe for exotic states of matter. [22]

"We studied two systems: a Bose-Einstein condensate with 100,000 atoms confined in a cavity and an optomechanical cavity that confines light between two mirrors," Gabriel Teixeira Landi, a professor at the University of São Paulo's Physics Institute (IF-USP), told. [21]

Search engine entropy is thus important not only for the efficiency of search engines and those using them to find relevant information as well as to the success of the companies and other bodies running such systems, but also to those who run websites hoping to be found and visited following a search. [20]

"We've experimentally confirmed the connection between information in the classical case and the quantum case," Murch said, "and we're seeing this new effect of information loss." [19]

It's well-known that when a quantum system is continuously measured, it freezes, i.e., it stops changing, which is due to a phenomenon called the quantum Zeno effect. [18]

Physicists have extended one of the most prominent fluctuation theorems of classical stochastic thermodynamics, the Jarzynski equality, to quantum field theory. [17]

In 1993, physicist Lucien Hardy proposed an experiment showing that there is a small probability (around 6-9%) of observing a particle and its antiparticle interacting with each other without annihilating—something that is impossible in classical physics. [16]

Scientists at the University of Geneva (UNIGE), Switzerland, recently reengineered their data processing, demonstrating that 16 million atoms were entangled in a one-centimetre crystal. [15]

The fact that it is possible to retrieve this lost information reveals new insight into the fundamental nature of quantum measurements, mainly by supporting the idea that quantum measurements contain both quantum and classical components. [14]

Researchers blur the line between classical and quantum physics by connecting chaos and entanglement. [13]

Yale University scientists have reached a milestone in their efforts to extend the durability and dependability of quantum information. [12]

Using lasers to make data storage faster than ever. [11]

Some three-dimensional materials can exhibit exotic properties that only exist in "lower" dimensions. For example, in one-dimensional chains of atoms that emerge within a bulk sample, electrons can separate into three distinct entities, each carrying information about just one aspect of the electron's identity—spin, charge, or orbit. The spinon, the entity that carries information about electron spin, has been known to control magnetism in certain insulating materials whose electron spins can point in any direction and easily flip direction. Now, a new study just published in Science reveals that spinons are also present in a metallic material in which the orbital movement of electrons around the atomic nucleus is the driving force behind the material's strong magnetism. [10]

Currently studying entanglement in condensed matter systems is of great interest. This interest stems from the fact that some behaviors of such systems can only be explained with the aid of entanglement. [9]

Researchers from the Norwegian University of Science and Technology (NTNU) and the University of Cambridge in the UK have demonstrated that it is possible to directly generate an electric current in a magnetic material by rotating its magnetization. [8]

This paper explains the magnetic effect of the electric current from the observed effects of the accelerating electrons, causing naturally the experienced changes of the electric field potential along the electric wire. The accelerating electrons explain not only the Maxwell Equations and the Special Relativity, but the Heisenberg Uncertainty Relation, the wave particle duality and the electron's spin also, building the bridge between the Classical and Quantum Theories.

The changing acceleration of the electrons explains the created negative electric field of the magnetic induction, the changing relativistic mass and the Gravitational Force, giving a Unified Theory of the physical forces. Taking into account the Planck Distribution Law of the electromagnetic oscillators also, we can explain the electron/proton mass rate and the Weak and Strong Interactions.

Contents

Preface	5
Free-space data-carrying bendable light communications.....	5
In the blink of an eye: Team uses quantum of light to create new quantum simulator	11
New imaging technology captures movement of quantum particles with unprecedented resolution	12
A polariton filter turns ordinary laser light into quantum light.....	13
Observation of quantized heating in quantum matter	14
Experiments detect entropy production in mesoscopic quantum systems	15
Information loss and disorder.....	16
Entropy and search engines.....	17
Researchers find quantum 'Maxwell's demon' may give up information to extract work..	18
Maxwell's demon in the quantum Zeno regime	20
Physicists extend stochastic thermodynamics deeper into quantum territory	21
Generalized Hardy's paradox shows an even stronger conflict between quantum and classical physics	23
A single photon reveals quantum entanglement of 16 million atoms	23
Physicists retrieve 'lost' information from quantum measurements.....	25
Researchers blur the line between classical and quantum physics by connecting chaos and entanglement.....	26
New device lengthens the life of quantum information.....	28
Using lasers to make data storage faster than ever	29

Shining light on magnets.....	30
Ultrafast laser-control of magnetism	30
Novel scientific frontiers	30
Scientists find surprising magnetic excitations in a metallic compound	31
Entanglement of Spin-1/2 Heisenberg Antiferromagnetic Quantum Spin Chains.....	32
New electron spin secrets revealed: Discovery of a novel link between magnetism and electricity.....	33
Simple Experiment.....	34
Uniformly accelerated electrons of the steady current	35
Magnetic effect of the decreasing U electric potential.....	36
The work done on the charge and the Hamilton Principle	38
The Magnetic Vector Potential	38
The Constant Force of the Magnetic Vector Potential	39
Electromagnetic four-potential	39
Magnetic induction	39
Lorentz transformation of the Special Relativity.....	40
Heisenberg Uncertainty Relation.....	41
Wave – Particle Duality	41
Atomic model	41
Fermions' spin.....	42
Fine structure constant.....	42
Planck Distribution Law	43
Electromagnetic inertia and Gravitational attraction	43
Conclusions	44
References	44

Author: George Rajna

Preface

Surprisingly nobody found strange that by theory the electrons are moving with a constant velocity in the stationary electric current, although there is an accelerating force $\underline{F} = q \underline{E}$, imposed by the \underline{E} electric field along the wire as a result of the \underline{U} potential difference. The accelerated electrons are creating a charge density distribution and maintaining the potential change along the wire. This charge distribution also creates a radial electrostatic field around the wire decreasing along the wire. The moving external electrons in this electrostatic field are experiencing a changing electrostatic field causing exactly the magnetic effect, repelling when moving against the direction of the current and attracting when moving in the direction of the current. This way the \underline{A} magnetic potential is based on the real charge distribution of the electrons caused by their acceleration, maintaining the \underline{E} electric field and the \underline{A} magnetic potential at the same time.

The mysterious property of the matter that the electric potential difference is self maintained by the accelerating electrons in the electric current gives a clear explanation to the basic sentence of the relativity that is the velocity of the light is the maximum velocity of the electromagnetic matter. If the charge could move faster than the electromagnetic field, this self maintaining electromagnetic property of the electric current would be failed.

More importantly the accelerating electrons can explain the magnetic induction also. The changing acceleration of the electrons will create a $-\underline{E}$ electric field by changing the charge distribution, increasing acceleration lowering the charge density and decreasing acceleration causing an increasing charge density.

Since the magnetic induction creates a negative electric field as a result of the changing acceleration, it works as a relativistic changing electromagnetic mass. If the mass is electromagnetic, then the gravitation is also electromagnetic effect. The same charges would attract each other if they are moving parallel by the magnetic effect.

Free-space data-carrying bendable light communications

Bendable light beams have significant applications in [optical manipulation](#), [optical imaging](#), [routing](#), [micromachining](#) and [nonlinear optics](#). Researchers have long explored curved light beams in place of traditional [Gaussian beams](#) for line-of-sight light communications. In a recent study now published on *Scientific Reports*, Long Zhu and a team of researchers in Optical and Electronic information, in China, proposed and developed free-space, data-carrying bendable light communication systems between arbitrary targets for potential multifunctionality. The researchers employed a [32-ary](#) quadrature amplitude modulation (32-QAM) based discrete multitone (DMT) signal to demonstrate free-space bendable light intensity modulated direct detection (IM-DD) communication in the presence of

three curved light paths. They characterized (tested) multiple functions of free-space bendable light communication to reveal that they allowed optical communications to be more flexible, robust and multifunctional. The work will open a new direction to explore special light beams enabled, advanced free-space light communications.

Bendable light beams are a new class of electromagnetic waves associated with a localized intensity maximum that can propagate along a curved trajectory. Researchers have previously studied and reported generic classes of bendable light beams that travel along elliptical and parabolic trajectories. Airy beams (appear to curve as they travel) are a type of non-diffracting beams that maintain its wavefront during transmission, much like Bessel beams (which only exist in theory, ideally) for optical communication free of obstructions. Airy beams possess properties of self-acceleration, non-diffraction and self-healing to propagate along a parabolic trajectory. Aside from airy beams, bendable light beams can reconstruct their wavefront to propagate continuously along the preset trajectory. To explore advantages of bendable light beams for diverse applications, researchers must bend the light along arbitrary trajectories; which can be achieved using the caustic method. The desired trajectory can be achieved with an optical light caustic to implement in real space and in Fourier space.

Physicists had previously used airy beams for free-space information transfer without exploring additional functionalities of bendable light beams. In the present work, Zhu et al. therefore studied bendable light beams for free-space optical communication. The optical path is traditionally a straight line that connects the transmitter and receiver, however, obstructions between them develop as communication failure. The use of curved light beams during free-space optical communication therefore allow scientists to easily navigate around obstructions using appropriate trajectories. Since bendable light beams are non-diffracting, they can construct their wavefront and continue to propagate along preset trajectories. As a result, scientists can design specific trajectories to send information to multiple users while avoiding unwanted users to build more flexible and robust communication systems.

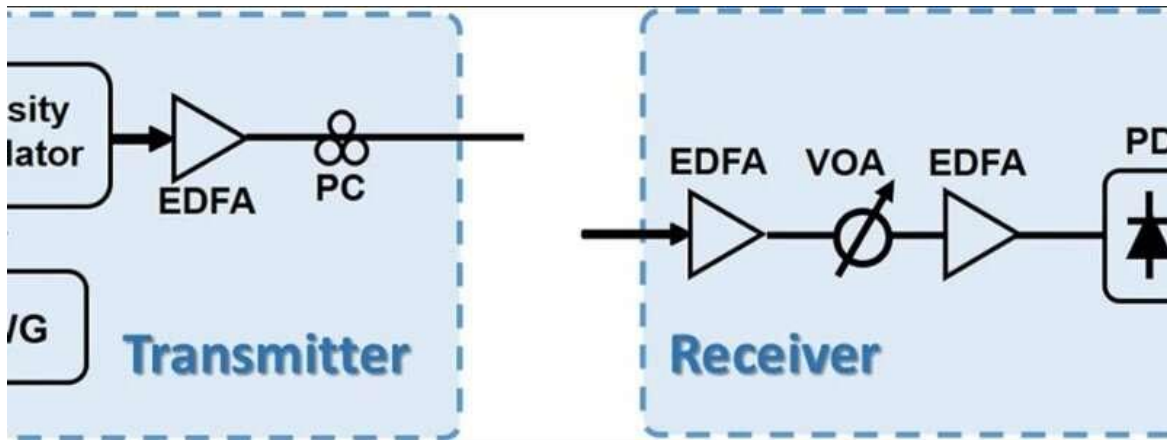

The implementation details of the transmitter and receiver in the experimental configuration. AWG: arbitrary waveform generator; EDFA: erbium-doped fiber amplifier; PC: polarization controller; VOA: variable optical attenuator; PD: photo detector. Credit: Scientific Reports, doi: 10.1038/s41598-019-51496-z

Zhu et al. used phase only spatial light modulation to realize bendable light beams along arbitrary trajectories, including self-broken trajectories. They successfully demonstrated free-space bendable light intensity modulated direct detection (IM-DD) communication systems using three different curved light paths. The research team then categorized the transmission performance within four different conditions:

Communication bypasses obstructions

[Self-healing](#) communication

Self-broken trajectory communication

Movable, multi-receiver communication

The researchers first designed a specific phase pattern for spatial light control using an optical light caustic method to build arbitrarily curved light paths for increased flexibility within the communication system. In contrast to traditional Gaussian beams, the bendable light generated by Zhu et al. bypassed existing obstructions—as expected. The self-healing property of the curved beam made the communication system more robust. They then constructed a self-broken trajectory curved light beam to increase the security of the communication system for the resulting curved light information to be delivered to multiple users along the path of light. The bendable-light, free-space communication system was multifunctional, flexible and robust.

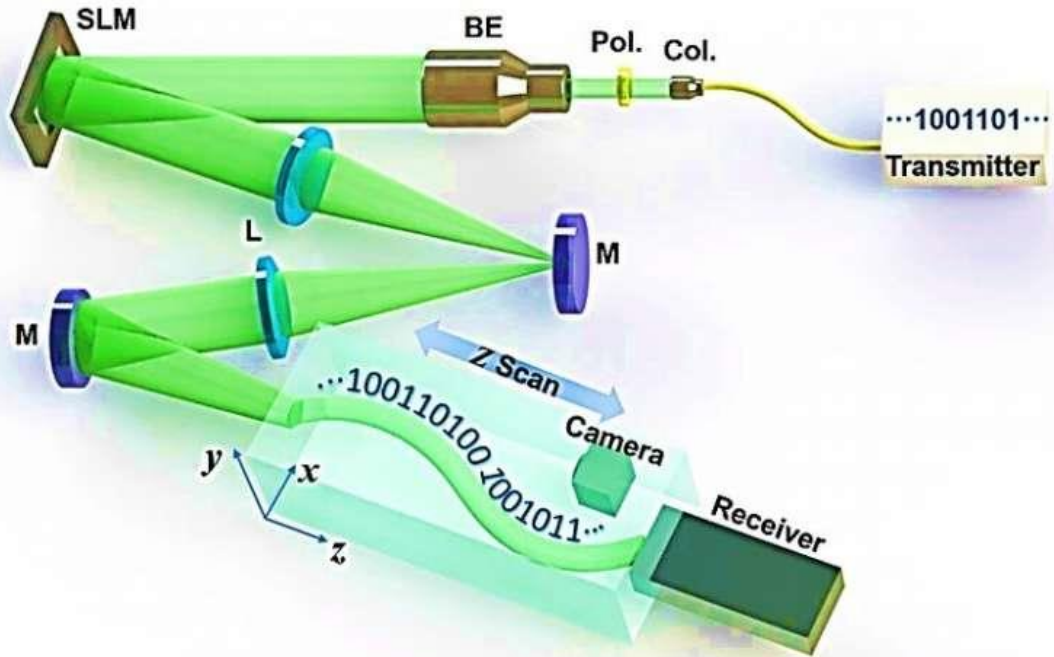

Experimental configuration of free-space bendable light communications. Col.: collimator; Pol.: polarizer; BE: beam expander; SLM: spatial light modulator; M: mirror; L: lens. Credit: Scientific Reports, doi: 10.1038/s41598-019-51496-z

As proof-of-concept, Zhu et al. used a 39.06 Gbit/s, 32-QAM DMT signal transmission at 1550 nm sent to the collimator to generate a free-space Gaussian beam with a two- μm beam diameter and numerical aperture of 0.24. The research team generated the data-carrying bendable light immediately after light polarization alignment using a spatial light modulator (SLM) loaded with the desired phase pattern via the optical light caustic method. The scientists employed a two-lens 4-f imaging system to record the full propagating trajectory and placed a camera to record the dynamics of the propagating bendable curved light moving along a motorized linear translation stage to couple into the receiver for signal detection.

Zhu et al. successfully generated three bendable light beams with different curved trajectories. They first achieved curved light beams along parabolic trajectories and S-shaped curved light beams and observed the measured intensity distributions to be in good agreement with the pre-designed trajectories. The team measured the bit error rate (BER) performance relative to the received optical signal-to-noise ratio (OSNR) for the three bendable light beams. They showed multiple functionalities of free-space bendable light communication.

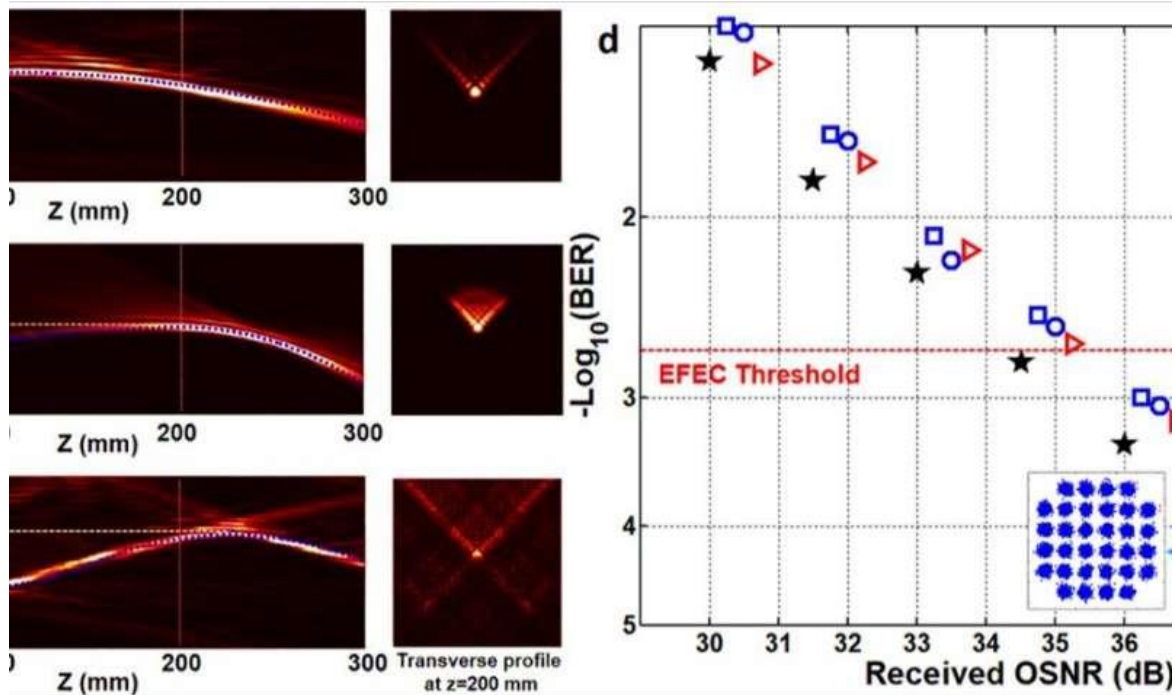

Experimental results of free-space bendable light communications along arbitrary trajectories. (a–c), Measured intensity distribution of three different bendable light beams at x-z plane (the blue dashed line is the preset trajectory) and corresponding transverse intensity profiles at $z = 200$ mm. (d), Measured bit-error rate (BER) performance of the three different data-carrying bendable light beams. Insets show constellations of 32-QAM DMT signals. B-to-B: back to back. BP1-BP3 correspond to a-c. EFEC: enhanced forward error correction. Credit: Scientific Reports, doi: 10.1038/s41598-019-51496-z

To achieve this, they first set obstructions along the line of sight between the transmitter and receiver and used a Gaussian beam for comparison in the experiments. Zhu et al. set one obstruction (Ob1) and measured BER performance of the S-shaped light beam followed by two obstructions (Ob1 and Ob2), to measure the BER curve of the S-shaped light beam (curve BP-Ob-2). The researchers then showed the self-healing property of free-space bendable light communications using an obstruction of 0.8-mm diameter to block the curved path of an S-shaped bendable beam. After propagation, the light reconstructed its wavefront to reach a receiver 300 mm away as self-healing, data-carrying bendable light. Upon measurement, the performance of the reconstructed light appeared similar to the non-blocked curve. When the team generated a curved light beam with a self-broken trajectory, the main lobe of the curved light appeared to be missing and recovered towards completion of communication. While they could not detect information at the broken part, the scientists successfully received the information at the end of the bendable light beam.

The research team then tested communication performance of the bendable light beam for additional users. Due to its self-healing property, the curved light could deliver information to multiple users along the curved light path trajectory, unlike traditional free-space light

communications. The team set three receivers along the light path and measured their BER performance to demonstrate almost similar transmission performance among the three receivers.

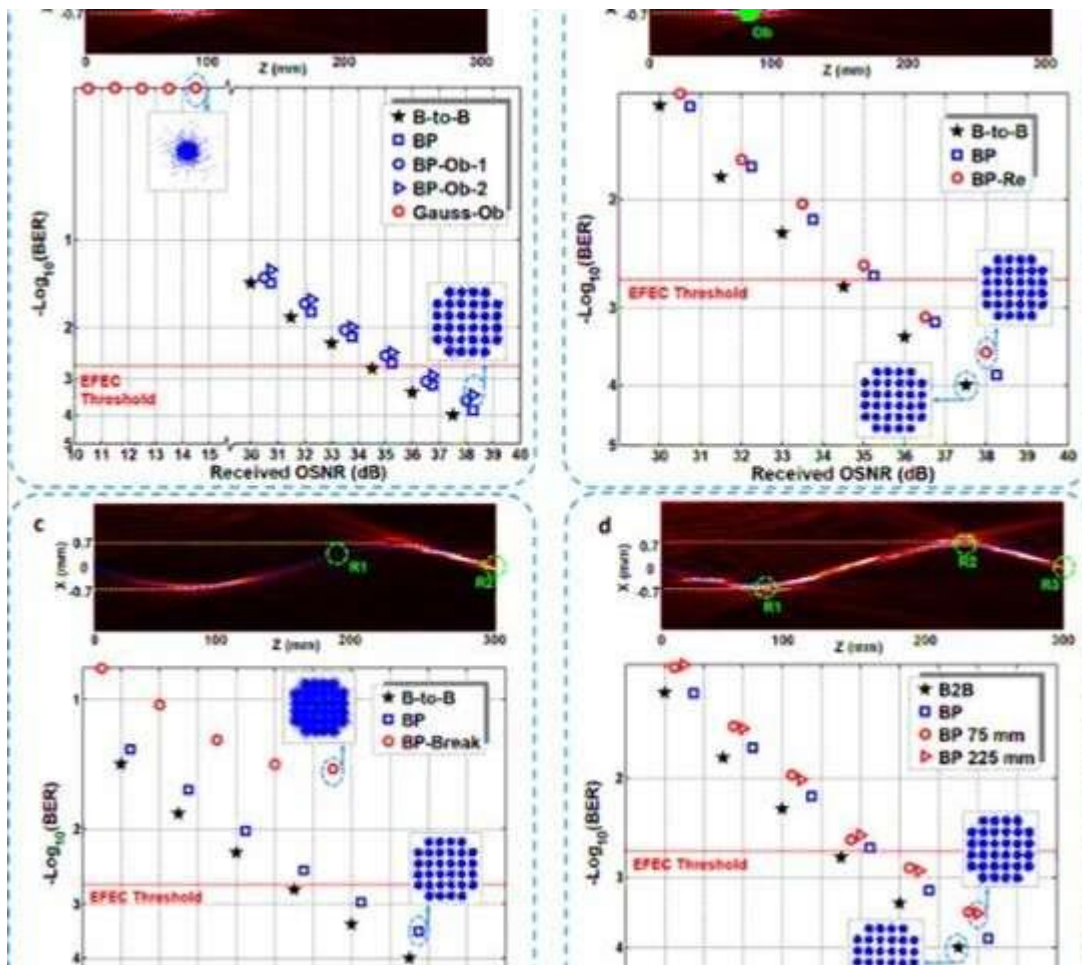

Experimental results of free-space bendable light communications for different functionalities. (a) Measured intensity distribution and BER performance of the bendable light communication under obstruction condition. (b) Measured intensity distribution and BER performance of the bendable light communication under self-healing condition. (c) Measured intensity distribution and BER performance of the self-broken bendable light communication. (d) Measured intensity distribution and BER performance of the bendable light communication for movable multiple users. Credit: Scientific Reports, doi: 10.1038/s41598-019-51496-z

In this way, Long Zhu and colleagues successfully demonstrated free-space, data-carrying bendable light communications and categorized multiple functionalities. The observed results showed that bendable light could deliver dynamic, flexible and robust free-space optical communications. The scientists expect the scheme to be scalable for propagation distance and bending offset. The work will open a new door to explore similar light beams and facilitate extensive free-space light communication systems with advanced versatility. [26]

In the blink of an eye: Team uses quantum of light to create new quantum simulator

Imagine being stuck inside a maze and wanting to find your way out. How would you proceed? The answer is trial and error. This is how traditional computers with classical algorithms operate to find the solution to a complex problem. Now consider this: What if, by magic, you were able to clone yourself into multiple versions so that you were able to go through all the various paths at the same time? You'd find the exit almost instantly.

Turns out we're not talking about magic—we're talking atomic and subatomic particles. An electron, for instance, can be in multiple places at once. This is a fundamental principle of nature known in quantum mechanics as the superposition principle.

Now, imagine if we take advantage of this principle and apply it to our classical simulators and computers. Imagine how dramatically more efficient we'd be at information processing!

This is the principle behind quantum computers and [quantum simulators](#). In essence, quantum computers use the [subatomic particles'](#) ability to exist in more than one place at once.

Quantum simulators are not just good for efficiency in processing times, but they are the "natural" choice to simulate simple and [complex systems](#) in nature. This is a direct consequence of the fact that nature is ultimately governed by the laws of [quantum mechanics](#).

Quantum simulators provide us with an excellent opportunity to simulate fundamental aspects of nature and understand their hidden dynamics without even looking into the complexities arising from the various particles and their interactions. This is precisely the motive behind the research of Professor Ebrahim Karimi and his team.

Karimi's team simulates periodic and closed structures in nature, such as ring-shaped molecules and crystalline lattices, by invoking the quantum mechanical properties of light. The results can help us understand the dynamics involved in such systems as well as open the possibility for developing efficient photonic-based quantum computers.

Karimi's team has successfully built and operated the first-ever quantum simulator designed specifically for simulating cyclic (ringed-shaped) systems. A quantum simulator simulates a quantum system. The team used the quantum of light (photon) to simulate the quantum motion of electrons inside rings made of different number of atoms. The experiment results revealed that the physics of ring-shaped systems are fundamentally different from those of line-shaped ones.

In doing so, the team established a powerful experimental technique to simulate a wide class of atomic systems and opened a new window to explore many opportunities resulting from its work.

"We anticipate that, within a short period of time, our research will have a very large impact in various disciplines, ranging from medicine to computer science, from [organic chemistry](#) and biology to [materials science](#) and fundamental physics," says Dr. Farshad Nejdassattari, one of Karimi's postdoctoral fellows, who was part of the project.

In a quantum simulator, a quantum particle that can be easily controlled and is physically well understood (in our case a particle of light, a photon) is allowed to propagate inside a system designed to be similar to that which is being simulated.

Some interesting discoveries from this experiment includes finding specific ways to distribute the particle on the ring such that the distribution never changes as the particle propagates, and also finding cases whereby the particle first spreads itself on the ring and then re-emerges at the location where it was initially placed. This has never been seen experimentally in any quantum simulator.

With quantum simulation techniques becoming more mature and complex, synthesizing new materials, chemicals and drug development will be greatly simplified. The [quantum simulator](#) will help provide all the information one needs in the blink of an eye. [25]

New imaging technology captures movement of quantum particles with unprecedented resolution

Excitons—electrically neutral quasiparticles—have extraordinary properties. They exist only in semiconducting and insulating materials and can be easily accessed in two-dimensional (2D) materials just a few atoms thick, such as carbon and molybdenite. When these 2D materials are combined, they exhibit quantum properties that neither material possesses on its own.

A new Tel Aviv University study explores the generation and propagation of excitons in 2D materials within an unprecedented small time frame and at an extraordinarily high spatial resolution. The research was led by Prof. Haim Suchowski and Dr. Michael Mrejen of TAU's Raymond & Beverly Sackler Faculty of Exact Sciences and published in *Science Advances* on February 1.

Quantum mechanics is a fundamental theory in physics that describes nature at the smallest scales of energy. "Our new imaging technology captures the movement of excitons in a short time frame and at nanometer scale," Dr. Mrejen says. "This tool can be extremely useful for peeking into a material's response at the very first moments [light](#) has affected it."

"Such materials can be used to significantly slow down light to manipulate it or even store it, which are highly sought-after capabilities for communications and for photonics-based quantum computers," Prof. Suchowski explains. "From the instrument capability point of view, this tour de force opens up new opportunities to visualize and manipulate the ultrafast response of many other material systems in other spectrum regimes, such as the mid-infrared range in which many molecules are found to vibrate."

The scientists developed a unique spatiotemporal imaging technique at the femtosecond-nanometric scale and observed exciton-polariton dynamics in tungsten diselenide, a [semiconductor material](#), at room temperature.

The exciton-polariton is a quantum creature spawned by the coupling of light and matter. Due to the specific material studied, the speed of propagation measured was about 1% of the speed of light. At this time scale, light manages to travel only several hundred nanometers.

"We knew we had a unique characterization tool and that these 2D materials were good candidates to explore interesting behavior at the ultrafast-ultraslow intersection," Dr. Mrejen says. "I should add that the material, tungsten diselenide, is extremely interesting from an applications point of view. It sustains such light-matter coupled states in very confined dimensions, down to single atom thickness, at room temperature and in the visible spectral range."

The researchers are now exploring ways of controlling the velocity of semiconductor waves by, for example, combining multiple 2D materials in stacks. [24]

A polariton filter turns ordinary laser light into quantum light

An international team of researchers led out of Macquarie University has demonstrated a new approach for converting ordinary laser light into genuine quantum light.

Their approach uses nanometre-thick films made of [gallium arsenide](#), which is a [semiconductor material](#) widely used in solar cells. They sandwich the thin films between two mirrors to manipulate the incoming photons.

The photons interact with electron-hole pairs in the semiconductor, forming new chimeric particles called polaritons that carry properties from both the photons and the [electron-hole pairs](#). The polaritons decay after a few picoseconds, and the photons they release exhibit distinct [quantum](#) signatures.

The teams' research was published overnight in the journal *Nature Materials*.

While these quantum signatures are weak at the moment, the work opens up a new avenue for producing [single photons](#) on demand.

"The ability to produce single photons on demand is hugely important for future applications in quantum communication and optical quantum information processing," says Associate Professor Thomas Volz from the Department of Physics and Astronomy and the senior author on the paper. "Think unbreakable encryption, super-fast computers, more efficient computer chips or even optical transistors with minimal power consumption."

Currently single-[photon](#) emitters are typically created by materials engineering—where the material itself is assembled in such a way that the 'quantum' behaviour is built in.

But this standard approach faces serious limitations at smaller and smaller scales because producing identical single-photon emitters by pure materials engineering is extremely challenging.

"This means our approach could be much more amenable for massively scaling up, once we're able to increase the strength of the quantum signatures we're producing. We might be able to make identical quantum emitters from semiconductors by photon nanostructure engineering, rather than by direct materials engineering," says Dr. Guillermo Munoz Matutano, also from Macquarie and lead author of the paper.

"While real-world applications are still a fair bit away, our paper describes a major milestone that the polariton community in particular has been waiting on for the last ten to fifteen years. The regime in which polaritons interact so strongly that they can imprint quantum signatures on photons has not been accessed to date and opens up a whole new playground for researchers in the field," says Thomas. [23]

Observation of quantized heating in quantum matter

Shaking a physical system typically heats it up, in the sense that the system continuously absorbs energy. When considering a circular shaking pattern, the amount of energy that is absorbed can potentially depend on the orientation of the circular drive (clockwise/anti-clockwise), a general phenomenon known as circular dichroism.

In 2017, Nathan Goldman (ULB, Brussels), Peter Zoller (IQOQI, Innsbruck) and coworkers predicted that circular dichroism can be quantized in quantum systems (heating is then constrained by strict integers) forming a "topological state." According to this theoretical prediction, the quantization of energy absorption upon circular driving can be directly related to topology, a fundamental mathematical concept that characterizes these intriguing states of matter.

Writing in *Nature Physics*, the experimental group of Klaus Sengstock and Christof Weitenberg (Hamburg), in collaboration with the team of Nathan Goldman, reports on the first observation of quantized circular dichroism. Following the theoretical proposal of Goldman, Zoller et al., the experimentalists realized a topological state using an ultracold atomic gas subjected to laser light, and studied its heating properties upon circular shaking of the gas. By finely monitoring the heating rates of their system, for a wide range of driving frequencies, they were able to validate the quantization law predicted by Goldman, Zoller et al. in 2017, in agreement with the underlying topological state realized in the laboratory.

Beyond the beauty of this phenomenon, which connects heating processes to topology through an elegant quantization law, the results reported in this work designate heating measurements as a powerful and universal probe for exotic states of matter. [22]

Experiments detect entropy production in mesoscopic quantum systems

The production of entropy, which means increasing the degree of disorder in a system, is an inexorable tendency in the macroscopic world owing to the second law of thermodynamics. This makes the processes described by classical physics irreversible and, by extension, imposes a direction on the flow of time. However, the tendency does not necessarily apply in the microscopic world, which is governed by quantum mechanics. The laws of quantum physics are reversible in time, so in the microscopic world, there is no preferential direction to the flow of phenomena.

One of the most important aims of contemporary scientific research is knowing exactly where the transition occurs from the [quantum](#) world to the classical world and why it occurs—in other words, finding out what makes the production of entropy predominate. This aim explains the current interest in studying mesoscopic systems, which are not as small as [individual atoms](#) but nevertheless display well-defined quantum behavior.

A new experimental study by researchers from Brazil and elsewhere offers an important contribution to this field. An article about it has recently been published in *Physical Review Letters*.

"We studied two systems: a Bose-Einstein condensate with 100,000 atoms confined in a cavity and an optomechanical cavity that confines light between two mirrors," Gabriel Teixeira Landi, a professor at the University of São Paulo's Physics Institute (IF-USP), told.

Landi was one of the scientists responsible for developing a theoretical model correlating the production of entropy with measurable quantities for both experiments. The research is supported by São Paulo Research Foundation—FAPESP. The Bose-Einstein condensate was studied at the Swiss Federal Institute of Technology (ETH Zurich), and the cavity optomechanics device was studied at the University of Vienna in Austria.

Often called the "fifth state of matter" (the other four being solids, liquids, gases and plasma), Bose-Einstein condensates are obtained when a group of atoms is cooled almost to absolute zero. Under these conditions, the particles no longer have the free energy to move relative to each other, and some of them enter the same quantum states, becoming indistinguishable from one another. The atoms then obey so-called Bose-Einstein statistics, which usually apply to identical particles. In a Bose-Einstein condensate, the entire group of atoms behaves as a single particle.

An optomechanical cavity is basically a light trap. In this particular case, one of the mirrors consisted of a nanometric membrane capable of vibrating mechanically. Thus, the experiment involved interactions between light and mechanical vibration. In both systems, there were two reservoirs, one hot and the other cold, so that heat could flow from one to the other.

"Both situations displayed signatures of something irreversible and therefore demonstrated an increase in entropy. Furthermore, they exhibited irreversibility as a consequence of quantum effects," Landi said. "The experiments permitted classical effects to be clearly distinguished from quantum fluctuations."

The main difficulty in this line of research is that entropy production cannot be measured directly. In the experiments in question, therefore, the scientists had to construct a theoretical relationship between entropy production and other phenomena that signal irreversibility and are directly measurable. In both cases, they chose to measure the photons leaking from the cavities, having deliberately used semitransparent mirrors to allow some light to escape.

They measured the average number of photons inside the cavities and the mechanical variations in the case of the vibrating mirror.

"Quantum fluctuations contributed to an increase in irreversibility in both experiments," Landi said. "This was a counterintuitive discovery. It's not necessarily something that can be generalized. It happened in these two cases, but it may not be valid in others. I see these two experiments as an initial effort to rethink entropy on this kind of platform. They open the door to further experimentation with a smaller number of rubidium atoms or even smaller optomechanical cavities, for example."

Information loss and disorder

In a recent theoretical study, Landi showed how classical fluctuations (vibrations of atoms and molecules, producing thermal energy) and quantum fluctuations could occur simultaneously, without necessarily contributing to the same results. That [study](#) was a forerunner of the two new experiments.

"Both the condensate and the light-confining cavity were mesoscopic phenomena. However, unlike other mesoscopic phenomena, they had perfectly preserved quantum properties thanks to shielding from the environment. They, therefore, provided controlled situations in which entropy production competition between classical and quantum phenomena could be very clearly observed," Landi said.

"Entropy can be interpreted in various ways. If we think in terms of information, an increase in entropy means a loss of information. From the standpoint of thermodynamics, entropy measures the degree of disorder. The greater the [entropy](#), the greater the disorder in the system. By combining these two views, we can obtain a more comprehensive understanding of the phenomenon."

Both the Bose-Einstein condensate and the optomechanical cavity are examples of so-called "quantum simulation platforms." These platforms enable scientists to circumvent a major obstacle to the advancement of knowledge because there are important systems in nature for which descriptive models exist but for which predictions cannot be made owing to calculation difficulties. The most famous example is high-temperature superconductivity. No one

understands how certain materials can behave as superconductors at the boiling point of liquid nitrogen (approximately -196°C).

The new platforms provide quantum devices that can simulate these systems. However, they do so in a controlled manner, eliminate all complicating factors, and focus only on the simplest phenomena of interest. "This idea of quantum simulation has caught on significantly in recent years. Simulations range from important molecules in medicine to key structures in cosmology," Landi said. [21]

Entropy and search engines

Entropy, a term loosely referring to the disorder of a physical system and infamously associated with the Second Law of Thermodynamics, wherein we know that it ultimately increases in any closed system, might be used to gauge something altogether different in the digital world – search engine optimisation.

S. Lakshmi of the Department of Electronics and Communication Engineering, at RVS College of Engineering, in Dindigul, B. Sathiyabhama of the Department of Computer Science Engineering, at Sona College of Technology, in Salem, and K. Batri of the Department of Electronics and Communication Engineering, at the PSNA College of Engineering and Technology, also in Dindigul, India, have attempted to analyse and measure the uncertainty associated with the relevant document selection in web-[search](#) engines.

Search engine entropy is thus important not only for the efficiency of search engines and those using them to find relevant information as well as to the success of the companies and other bodies running such systems, but also to those who run websites hoping to be found and visited following a search. Search engine optimization (SEO) encompasses a multitude of strategies a website owner might employ in their efforts to ensure that their website reaches a higher position in the [search engine results](#) pages (SERPs).

The team explains how they are using entropy to add a metric to the number of index terms and their frequency, and how this influences the relevance calculation carried out by [search engine](#) algorithms. "The variation in term frequency either in processed web documents or in users' queries influences the relevance calculation," the team explains. "This," they suggest, "leads to an uncertainty associated with the document selection and its relevance calculation." As such, a measure of [entropy](#) can be made by varying the documents' term frequency or user's query term frequency to reveal how SEO might be carried out. The team has successfully tested their entropic approach to SEO against two of the most well-known search engines, Bing and Google. [20]

Researchers find quantum 'Maxwell's demon' may give up information to extract work

Thermodynamics is one of the most human of scientific enterprises, according to Kater Murch, associate professor of physics in Arts & Sciences at Washington University in St. Louis.

"It has to do with our fascination of fire and our laziness," he said. "How can we get fire"—or heat—"to do work for us?"

Now, Murch and colleagues have taken that most human enterprise down to the intangible quantum scale—that of ultra low temperatures and microscopic systems—and discovered that, as in the macroscopic world, it is possible to use information to extract work.

There is a catch, though: Some information may be lost in the process.

"We've experimentally confirmed the connection between information in the classical case and the quantum case," Murch said, "and we're seeing this new effect of information loss."

The results were published in the July 20 issue of *Physical Review Letters*.

The international team included Eric Lutz of the University of Stuttgart; J. J. Alonzo of the University of Erlangen-Nuremberg; Alessandro Romito of Lancaster University; and Mahdi Naghiloo, a Washington University graduate research assistant in physics.

Credit: Washington University in St. Louis

That we can get energy from information on a macroscopic scale was most famously illustrated in a thought experiment known as Maxwell's Demon. The "demon" presides over a box filled with molecules. The box is divided in half by a wall with a door. If the demon knows the speed and direction of all of the molecules, it can open the door when a fast-moving molecule is moving from the left half of the box to the right side, allowing it to pass. It can do the same for slow particles moving in the opposite direction, opening the door when a slow-moving molecule is approaching from the right, headed left.

After a while, all of the quickly-moving molecules are on the right side of the box. Faster motion corresponds to higher temperature. In this way, the demon has created a temperature imbalance, where one side of the box is hotter. That temperature imbalance can be turned into work—to push on a piston as in a steam engine, for instance. At first the [thought experiment](#) seemed to show that it was possible create a temperature difference without doing any work, and since temperature differences allow you to extract work, one could build a perpetual motion machine—a violation of the second law of thermodynamics.

"Eventually, scientists realized that there's something about the information that the demon has about the molecules," Murch said. "It has a physical quality like heat and work and energy."

His team wanted to know if it would be possible to use information to extract work in this way on a quantum scale, too, but not by sorting fast and slow molecules. If a particle is in an excited state, they could extract work by moving it to a ground state. (If it was in a ground state, they wouldn't do anything and wouldn't expend any work).

But they wanted to know what would happen if the quantum particles were in an excited state and a ground state at the same time, analogous to being fast and slow at the same time. In quantum physics, this is known as a superposition.

"Can you get work from information about a superposition of energy states?" Murch asked. "That's what we wanted to find out."

There's a problem, though. On a quantum scale, getting information about particles can be a bit ... tricky.

"Every time you measure the system, it changes that system," Murch said. And if they measured the particle to find out exactly what state it was in, it would revert to one of two states: excited, or ground.

This effect is called quantum backaction. To get around it, when looking at the system, researchers (who were the "demons") didn't take a long, hard look at their particle. Instead, they took what was called a "weak observation." It still influenced the state of the superposition, but not enough to move it all the way to an excited state or a ground state; it was still in a superposition of energy states. This observation was enough, though, to allow the researchers track with fairly high accuracy, exactly what superposition the particle was in—and this is important, because the way the work is extracted from the particle depends on what superposition state it is in.

To get information, even using the weak observation method, the researchers still had to take a peek at the particle, which meant they needed light. So they sent some photons in, and observed the photons that came back.

"But the demon misses some photons," Murch said. "It only gets about half. The other half are lost." But—and this is the key—even though the researchers didn't see the other half of the photons, those photons still interacted with the system, which means they still had an effect on it. The researchers had no way of knowing what that effect was.

They took a weak measurement and got some information, but because of quantum backaction, they might end up knowing less than they did before the measurement. On the balance, that's negative information.

And that's weird.

"Do the rules of thermodynamics for a macroscopic, classical world still apply when we talk about quantum superposition?" Murch asked. "We found that yes, they hold, except there's this weird thing. The information can be negative."

"I think this research highlights how difficult it is to build a quantum computer," Murch said.

"For a normal computer, it just gets hot and we need to cool it. In the [quantum](#) computer you are always at risk of losing [information](#)." [19]

Maxwell's demon in the quantum Zeno regime

In the original Maxwell's demon thought experiment, a demon makes continuous measurements on a system of hot and cold reservoirs, building up a thermal gradient that can later be used to perform work. As the demon's measurements do not consume energy, it appears that the demon violates the second law of thermodynamics, although this paradox can be resolved by considering that the demon uses information to perform its sorting tasks.

It's well-known that when a quantum system is continuously measured, it freezes, i.e., it stops changing, which is due to a phenomenon called the quantum Zeno effect. This leads to the question: what might happen when Maxwell's demon enters the quantum Zeno regime? Will the demon's continuous measurements cause the quantum system to freeze and prevent work extraction, or will the demon still be able to influence the system's dynamics?

In a paper published in the *New Journal of Physics*, physicists Georg Engelhardt and Gernot Schaller at the Technical University of Berlin have theoretically implemented Maxwell's demon in a single-electron transistor in order to investigate the actions of the demon in the quantum Zeno regime.

In their model, the single-electron transistor consists of two electron reservoirs coupled by a quantum dot, with a demon making continuous measurements on the system. The researchers demonstrated that, as predicted by the quantum Zeno effect, the demon's continuous measurements block the flow of current between the two reservoirs. As a result, the demon cannot extract work.

However, the researchers also investigated what happens when the demon's measurements are not quite continuous. They found that there is an optimal measurement rate at which the measurements do not cause the system to freeze, but where a chemical gradient builds up between the two reservoirs and work can be extracted.

"The key significance of our findings is that it is necessary to investigate the transient short-time dynamics of thermoelectric devices, in order to find the optimal performance," Engelhardt told *Phys.org*. "This could be important for improving nanoscale technological devices."

The physicists explain that this intermediate regime lies between the quantum regime in which genuine quantum effects occur and the classical regime. What's especially attractive about this regime is that, due to the demon's measurements, the total energy of the system decreases so that no external energy needs to be invested to make the demon work.

"Due to the applied non-Markovian method, we have been able to find a working mode of the demon, at which—besides the build-up of the chemical gradient—it also gains work due the measurement," Engelhardt explained.

Going forward, it may be possible to extract work from the chemical gradient and use it, for example, to charge a battery. The researchers plan to address this possibility and others in the future.

"In our future research, we aim to investigate potential applications," Engelhardt said. "Feedback processes are important, for example, in many biological processes. We hope to identify and analyze quantum transport processes from a feedback viewpoint.

"Furthermore, we are interested in [feedback control](#) of topological band structures. As topological effects strongly rely on coherent dynamics, measurements seem to be an obstacle for feedback control. However, for an appropriate weak measurement, which only partly destroys the coherent [quantum](#) state, a feedback manipulation might be reasonable." [18]

Physicists extend stochastic thermodynamics deeper into quantum territory

Physicists have extended one of the most prominent fluctuation theorems of classical stochastic thermodynamics, the Jarzynski equality, to quantum field theory. As quantum field theory is considered to be the most fundamental theory in physics, the results allow the knowledge of stochastic thermodynamics to be applied, for the first time, across the full range of energy and length scales.

The physicists, Anthony Bartolotta, a graduate student at Caltech, and Sebastian Deffner, Physics Professor at the University of Maryland Baltimore County, have written a paper on the Jarzynski equality for [quantum](#) field theories that will be published in an upcoming issue of *Physical Review X*.

The work address one of the biggest challenges in fundamental physics, which is to determine how the laws of classical thermodynamics can be extended to the [quantum scale](#). Understanding work and heat flow at the level of subatomic particles would benefit a wide range of areas, from designing nanoscale materials to understanding the evolution of the early universe.

As Bartolotta and Deffner explain in their paper, in contrast to the large leaps made in the "microscopic theories" of classical and quantum mechanics during the past century, the development of thermodynamics has been rather stagnant over that time.

Although thermodynamics was originally developed to describe the relation between energy and work, the [theory](#) traditionally applies only to systems that change infinitely slowly. In 1997, physicist Christopher Jarzynski at the University of Maryland College Park introduced a way to extend thermodynamics to systems in which heat and energy transfer processes occur at any rate. The fluctuation theorems, the most prominent of which is now called the Jarzynski equality, have made it possible to understand the thermodynamics of a wider range of smaller, yet still classical, systems.

"Thermodynamics is a phenomenological theory to describe the average behavior of heat and work," Deffner told *Phys.org*. "Originally designed to improve big, stinky heat engines, it was not capable of describing small systems and systems that operate far from equilibrium. The Jarzynski equality dramatically broadened the scope of thermodynamics and laid the groundwork for stochastic thermodynamics, which is a new and very active branch of research."

Stochastic thermodynamics deals with classical thermodynamic concepts such as work, heat, and entropy, but on the level of fluctuating trajectories of atoms and molecules. This more detailed picture is particularly important for understanding thermodynamics in small-scale systems, which is also the realm of various emerging applications.

It wasn't for another decade, however, until the Jarzynski equality and other fluctuation theorems were extended to the quantum scale, at least up to a point. In 2007, researchers determined how quantum effects modify the usual interpretation of work. However, many questions still remain and overall, the area of quantum stochastic thermodynamics is still incomplete. Against this backdrop, the results of the new study represent a significant advance.

"Now, in 2018 we have taken the next big step forward," Deffner said. "We have generalized stochastic thermodynamics to quantum field theories (QFT). In a certain sense we have extended stochastic thermodynamics to its ultimate range of validity, since QFT is designed to be the most [fundamental theory](#) in physics."

One of the keys to the achievement was to develop a completely novel graph theoretic approach, which allowed the researchers to classify and combine the Feynman diagrams used to describe particle behavior in a new way. More specifically, the approach makes it possible to precisely calculate infinite sums of all the possible permutations (or arrangements) of disconnected subdiagrams describing the particle trajectories.

"The quantity we were interested in, the work, is different than the quantities usually calculated by particle theorists and thus required a different approach," Bartolotta said.

The physicists expect that the results will allow other scientists to apply the fluctuation theorems to a wide variety of problems at the forefront of physics, such as in particle physics, cosmology, and condensed matter physics. This includes studying things like quantum engines, the thermodynamic properties of graphene, and the quark gluon plasma produced in heavy ion colliders—some of the most extreme conditions found in nature.

In the future, the physicists plan to generalize their approach to a wider variety of quantum field theories, which will open up even further possibilities. [17]

Generalized Hardy's paradox shows an even stronger conflict between quantum and classical physics

In 1993, physicist Lucien Hardy proposed an experiment showing that there is a small probability (around 6-9%) of observing a particle and its antiparticle interacting with each other without annihilating—something that is impossible in classical physics. The way to explain this result is to require quantum theory to be nonlocal: that is, to allow for the existence of long-range quantum correlations, such as entanglement, so that particles can influence each other across long distances.

So far, Hardy's paradox has been experimentally demonstrated with two [particles](#), and a few special cases with more than two particles have been proposed but not experimentally demonstrated. Now in a new paper published in *Physical Review Letters*, physicists have presented a generalized Hardy's paradox that extends to any number of particles. Further, they show that any version of Hardy's paradox that involves three or more particles conflicts with local (classical) theory even more strongly than any of the previous versions of the paradox do. To illustrate, the physicists proposed an experiment with three particles in which the probability of observing the paradoxical event reaches an estimated 25%.

"In this paper, we show a family of generalized Hardy's paradox to the most degree, in that by adjusting certain parameters they not only include previously known extensions as special cases, but also give sharper conflicts between quantum and classical theories in general," coauthor Jing-Ling Chen at Nankai University and the National University of Singapore told *Phys.org*. "What's more, based on the paradoxes, we are able to write down novel Bell's inequalities, which enable us to detect more quantum entangled states." [16]

A single photon reveals quantum entanglement of 16 million atoms

Quantum theory predicts that a vast number of atoms can be entangled and intertwined by a very strong quantum relationship, even in a macroscopic structure. Until now, however, experimental evidence has been mostly lacking, although recent advances have shown the entanglement of 2,900 atoms. Scientists at the University of Geneva (UNIGE), Switzerland, recently reengineered their data processing, demonstrating that 16 million atoms were entangled in a one-centimetre crystal. They have published their results in *Nature Communications*.

The laws of quantum physics allow immediately detecting when emitted signals are intercepted by a third party. This property is crucial for data protection, especially in the encryption industry, which can now guarantee that customers will be aware of any interception of their messages. These signals also need to be able to travel long distances using special relay devices known as quantum repeaters—crystals enriched with rare earth atoms and cooled to 270 degrees below zero (barely three degrees above absolute zero), whose atoms are entangled and unified by a very strong quantum relationship. When a photon penetrates this small crystal block, entanglement is created between the billions of atoms it traverses. This is explicitly predicted by the theory, and it is exactly what happens as the crystal re-emits a single photon without reading the information it has received.

It is relatively easy to entangle two particles: Splitting a photon, for example, generates two entangled photons that have identical properties and behaviours. Florian Fröwis, a researcher in the applied physics group in UNIGE's science faculty, says, "But it's impossible to directly observe the process of entanglement between several million atoms since the mass of data you need to collect and analyse is so huge."

As a result, Fröwis and his colleagues chose a more indirect route, pondering what measurements could be undertaken and which would be the most suitable ones. They examined the characteristics of light re-emitted by the crystal, as well as analysing its statistical properties and the probabilities following two major avenues—that the light is re-emitted in a single direction rather than radiating uniformly from the crystal, and that it is made up of a single photon. In this way, the researchers succeeded in showing the entanglement of 16 million atoms when previous observations had a ceiling of a few thousand. In a parallel work, scientists at University of Calgary, Canada, demonstrated entanglement between many large groups of atoms. "We haven't altered the laws of physics," says Mikael Afzelius, a member of Professor Nicolas Gisin's applied physics group. "What has changed is how we handle the flow of data."

Particle entanglement is a prerequisite for the quantum revolution that is on the horizon, which will also affect the volumes of data circulating on future networks, together with the power and operating mode of quantum computers. Everything, in fact, depends on the relationship between two particles at the quantum level—a relationship that is much stronger than the simple correlations proposed by the laws of traditional physics.

Although the concept of entanglement can be hard to grasp, it can be illustrated using a pair of socks. Imagine a physicist who always wears two socks of different colours. When you spot a red sock on his right ankle, you also immediately learn that the left sock is not red. There is a correlation, in other words, between the two socks. In quantum physics, an infinitely stronger and more mysterious correlation emerges—entanglement.

Now, imagine there are two physicists in their own laboratories, with a great distance separating the two. Each scientist has a photon. If these two photons are in an entangled state, the physicists will see non-local quantum correlations, which conventional physics is unable to explain. They will find that the polarisation of the photons is always opposite (as with the socks

in the above example), and that the photon has no intrinsic polarisation. The polarisation measured for each photon is, therefore, entirely random and fundamentally indeterminate before being measured. This is an unsystematic phenomenon that occurs simultaneously in two locations that are far apart—and this is exactly the mystery of quantum correlations. [15]

Physicists retrieve 'lost' information from quantum measurements

Typically when scientists make a measurement, they know exactly what kind of measurement they're making, and their purpose is to obtain a measurement outcome. But in an "unrecorded measurement," both the type of measurement and the measurement outcome are unknown.

Despite the fact that scientists do not know this information, experiments clearly show that unrecorded measurements unavoidably disturb the state of the system being measured for quantum (but not classical) systems. In classical systems, unrecorded measurements have no effect.

Although the information in unrecorded measurements appears to be completely lost, in a paper published recently in EPL, Michael Revzen and Ady Mann, both Professors Emeriti at the Technion-Israel Institute of Technology, have described a protocol that can retrieve some of the lost information.

The fact that it is possible to retrieve this lost information reveals new insight into the fundamental nature of quantum measurements, mainly by supporting the idea that quantum measurements contain both quantum and classical components.

Previously, analysis of quantum measurement theory has suggested that, while a quantum measurement starts out purely quantum, it becomes somewhat classical when the quantum state of the system being measured is reduced to a "classical-like" probability distribution. At this point, it is possible to predict the probability of the result of a quantum measurement.

As the physicists explain in the new paper, this step when a quantum state is reduced to a classical-like distribution is the traceable part of an unrecorded measurement—or in other words, it is the "lost" information that the new protocol retrieves. So the retrieval of the lost information provides evidence of the quantum-to-classical transition in a quantum measurement.

"We have demonstrated that analysis of quantum measurement is facilitated by viewing it as being made of two parts," Revzen told Phys.org. "The first, a pure quantum one, pertains to the non-commutativity of measurements' bases. The second relates to classical-like probabilities.

"This partitioning circumvents the ever-present polemic surrounding the whole issue of measurements and allowed us, on the basis of the accepted wisdom pertaining to classical measurements, to suggest and demonstrate that the non-commutative measurement basis may be retrieved by measuring an unrecorded measurement."

As the physicists explain, the key to retrieving the lost information is to use quantum entanglement to entangle the system being measured by an unrecorded measurement with a second system. Since the two systems are entangled, the unrecorded measurement affects both systems. Then a control measurement made on the entangled system can extract some of the lost information. The scientists explain that the essential role of entanglement in retrieving the lost information affirms the intimate connection between entanglement and measurements, as well as the uncertainty principle, which limits the precision with which certain measurements can be made. The scientists also note that the entire concept of retrieval has connections to quantum cryptography.

"Posing the problem of retrieval of unrecorded measurement is, we believe, new," Mann said. "The whole issue, however, is closely related to the problem of the combatting eavesdropper in quantum cryptography which aims, in effect, at detection of the existence of 'unrecorded measurement' (our aim is their identification).

The issue of eavesdropper detection has been under active study for some time."

The scientists are continuing to build on the new results by showing that some of the lost information can never be retrieved, and that in other cases, it's impossible to determine whether certain information can be retrieved.

"At present, we are trying to find a comprehensive proof that the retrieval of the measurement basis is indeed the maximal possible retrieval, as well as to pin down the precise meaning of the ubiquitous 'undetermined' case," Revzen said. "This is, within our general study of quantum measurement, arguably the most obscure subject of the foundation of quantum mechanics."
[14]

Researchers blur the line between classical and quantum physics by connecting chaos and entanglement

Using a small quantum system consisting of three superconducting qubits, researchers at UC Santa Barbara and Google have uncovered a link between aspects of classical and quantum physics thought to be unrelated: classical chaos and quantum entanglement. Their findings suggest that it would be possible to use controllable quantum systems to investigate certain fundamental aspects of nature.

"It's kind of surprising because chaos is this totally classical concept—there's no idea of chaos in a quantum system," Charles Neill, a researcher in the UCSB Department of Physics and lead author of a paper that appears in *Nature Physics*. "Similarly, there's no concept of entanglement within classical systems. And yet it turns out that chaos and entanglement are really very strongly and clearly related."

Initiated in the 15th century, classical physics generally examines and describes systems larger than atoms and molecules. It consists of hundreds of years' worth of study including Newton's

laws of motion, electrodynamics, relativity, thermodynamics as well as chaos theory—the field that studies the behavior of highly sensitive and unpredictable systems. One classic example of chaos theory is the weather, in which a relatively small change in one part of the system is enough to foil predictions—and vacation plans—anywhere on the globe.

At smaller size and length scales in nature, however, such as those involving atoms and photons and their behaviors, classical physics falls short. In the early 20th century quantum physics emerged, with its seemingly counterintuitive and sometimes controversial science, including the notions of superposition (the theory that a particle can be located in several places at once) and entanglement (particles that are deeply linked behave as such despite physical distance from one another).

And so began the continuing search for connections between the two fields.

All systems are fundamentally quantum systems, according Neill, but the means of describing in a quantum sense the chaotic behavior of, say, air molecules in an evacuated room, remains limited.

Imagine taking a balloon full of air molecules, somehow tagging them so you could see them and then releasing them into a room with no air molecules, noted co-author and UCSB/Google researcher Pedram Roushan. One possible outcome is that the air molecules remain clumped together in a little cloud following the same trajectory around the room. And yet, he continued, as we can probably intuit, the molecules will more likely take off in a variety of velocities and directions, bouncing off walls and interacting with each other, resting after the room is sufficiently saturated with them.

"The underlying physics is chaos, essentially," he said. The molecules coming to rest—at least on the macroscopic level—is the result of thermalization, or of reaching equilibrium after they have achieved uniform saturation within the system. But in the infinitesimal world of quantum physics, there is still little to describe that behavior. The mathematics of quantum mechanics, Roushan said, do not allow for the chaos described by Newtonian laws of motion.

To investigate, the researchers devised an experiment using three quantum bits, the basic computational units of the quantum computer. Unlike classical computer bits, which utilize a binary system of two possible states (e.g., zero/one), a qubit can also use a superposition of both states (zero and one) as a single state.

Additionally, multiple qubits can entangle, or link so closely that their measurements will automatically correlate. By manipulating these qubits with electronic pulses, Neill caused them to interact, rotate and evolve in the quantum analog of a highly sensitive classical system.

The result is a map of entanglement entropy of a qubit that, over time, comes to strongly resemble that of classical dynamics—the regions of entanglement in the quantum map resemble the regions of chaos on the classical map. The islands of low entanglement in the quantum map are located in the places of low chaos on the classical map.

"There's a very clear connection between entanglement and chaos in these two pictures," said Neill. "And, it turns out that thermalization is the thing that connects chaos and entanglement. It turns out that they are actually the driving forces behind thermalization.

"What we realize is that in almost any quantum system, including on quantum computers, if you just let it evolve and you start to study what happens as a function of time, it's going to thermalize," added Neill, referring to the quantum-level equilibration. "And this really ties together the intuition between classical thermalization and chaos and how it occurs in quantum systems that entangle."

The study's findings have fundamental implications for quantum computing. At the level of three qubits, the computation is relatively simple, said Roushan, but as researchers push to build increasingly sophisticated and powerful quantum computers that incorporate more qubits to study highly complex problems that are beyond the ability of classical computing—such as those in the realms of machine learning, artificial intelligence, fluid dynamics or chemistry—a quantum processor optimized for such calculations will be a very powerful tool.

"It means we can study things that are completely impossible to study right now, once we get to bigger systems," said Neill. [13]

New device lengthens the life of quantum information

Yale University scientists have reached a milestone in their efforts to extend the durability and dependability of quantum information.

For the first time, researchers at Yale have crossed the "break even" point in preserving a bit of quantum information for longer than the lifetime of its constituent parts. They have created a novel system to encode, spot errors, decode, and correct errors in a quantum bit, also known as a "qubit." The development of such a robust method of Quantum Error Correction (QEC) has been one of the biggest remaining hurdles in quantum computation.

The findings were published online July 20 in the journal Nature.

"This is the first error correction to actually detect and correct naturally occurring errors," said Robert Schoelkopf, Sterling Professor of Applied Physics and Physics at Yale, director of the Yale Quantum Institute, and principal investigator of the study. "It is just the beginning of using QEC for real computing. Now we need to combine QEC with actual computations."

Error correction for quantum data bits is exceptionally difficult because of the nature of the quantum state. Unlike the "classical" state of either zero or one, the quantum state can be a zero, a one, or a superposition of both zero and one. Furthermore, the quantum state is so fragile that the act of observing it will cause a qubit to revert back to a classical state.

Co-lead author Andrei Petrenko, who is a Yale graduate student, added: "In our experiment we show that we can protect an actual superposition and the QEC doesn't learn whether the qubit is a zero or a one, but can still compensate for the errors."

The team accomplished it, in part, by finding a less complicated way to encode and correct the information. The Yale researchers devised a microwave cavity in which they created an even number of photons in a quantum state that stores the qubit. Rather than disturbing the photons by measuring them—or even counting them—the researchers simply determined whether there were an odd or even number of photons. The process relied on a kind of symmetry, via a technique the team developed previously.

"If a photon is lost, there will now be an odd number," said co-lead author Nissim Ofek, a Yale postdoctoral associate. "We can measure the parity, and thus detect error events without perturbing or learning what the encoded quantum bit's value actually is."

The cavity developed by Yale is able to prolong the life of a quantum bit more than three times longer than typical superconducting qubits today. It builds upon more than a decade of development in circuit QED architecture.

Schoelkopf and his frequent Yale collaborators, Michel Devoret and Steve Girvin, have made a series of quantum superconducting breakthroughs in recent years, directed at creating electronic devices that are the quantum version of the integrated circuit. Devoret, Yale's F.W.

Beinecke Professor of Physics, and Girvin, Yale's Eugene Higgins Professor of Physics and Applied Physics, are co-authors of the Nature paper. [12]

Using lasers to make data storage faster than ever

As we use more and more data every year, where will we have room to store it all? Our rapidly increasing demand for web apps, file sharing and social networking, among other services, relies on information storage in the "cloud" – always-on Internet-connected remote servers that store, manage and process data. This in turn has led to a pressing need for faster, smaller and more energy-efficient devices to perform those cloud tasks.

Two of the three key elements of cloud computing, microchips and communications connections, are getting ever faster, smaller and more efficient. My research activity has implications for the third: data storage on hard drives.

Computers process data, at its most fundamental level, in ones and zeroes. Hard disks store information by changing the local magnetization in a small region of the disk: its direction up or down corresponds to a "1" or "0" value in binary machine language.

The smaller the area of a disk needed to store a piece of information, the more information can be stored in a given space. A way to store information in a particularly tiny area is by taking advantage of the fact that individual electrons possess magnetization, which is called their spin. The research field of spin electronics, or "spintronics," works on developing the ability to control the direction of electrons' spins in a faster and more energy efficient way.

Shining light on magnets

I work to control electrons' spins using extremely short laser pulses – one quadrillionth of a second in duration, or one "femtosecond." Beyond just enabling smaller storage, lasers allow dramatically faster storage and retrieval of data. The speed comparison between today's technology and femtosecond spintronics is like comparing the fastest bullet train on Earth to the speed of light.

In addition, if the all-optical method is used to store information in materials that are transparent to light, little or no heating occurs – a huge benefit given the economic and environmental costs presented by the need for massive data-center cooling systems.

Ultrafast laser-control of magnetism

A decade ago, studies first demonstrated that laser pulses could control electron spins to write data and could monitor the spins to read stored data. Doing this involved measuring tiny oscillations in the electrons' magnetization. After those early investigations, researchers believed – wrongly, as it turned out – that lasers could not affect or detect fluctuations smaller than the wavelength of the lasers' own light. If this were true, it would not be possible to control magnets on a scale as short as one nanometer (one millionth of a millimeter) in as little time as a femtosecond.

Very recently an international team of researchers of which I am a member has provided an experimental demonstration that such a limitation does not actually exist. We were able to affect magnets on as small as one nanometer in length, as quickly as every 45 femtoseconds. That's one ten-millionth the size, and more than 20,000 times as fast as today's hard drives operate.

This suggests that future devices may be able to work with processing speeds as fast as 22 THz – 1,000 times faster than today's GHz clock speeds in commercial computers. And devices could be far smaller, too.

Novel scientific frontiers

In addition to the practical effects on modern computing, the scientific importance of this research is significant. Conventional theories and experiments about magnetism assume that materials are in what is called "equilibrium," a condition in which the quantities defining a system (temperature, pressure, magnetization) are either constant or changing only very slowly.

However, sending in a femtosecond laser pulse disrupts a magnet's equilibrium. This lets us study magnetic materials in real time when they are not at rest, opening new frontiers for fundamental research. Already, we have seen exotic phenomena such as loss or even reversal of magnetization. These defy our current understanding of magnetism because they are impossible in equilibrium states. Other phenomena are likely to be discovered with further research.

Innovative science begins with a vision: a scientist is a dreamer who is able to imagine phenomena not observed yet. The scientific community involved in the research area of ultrafast magnetism is working on a big leap forward. It would be a development that doesn't mean just faster laptops but always-on, connected computing that is significantly faster, smaller and cheaper than today's systems. In addition, the storage mechanisms won't generate as much heat, requiring far less cooling of data centers – which is a significant cost both financially and environmentally. Achieving those new capabilities requires us to push the frontier of fundamental knowledge even farther, and paves the way to technologies we cannot yet imagine. [11]

Scientists find surprising magnetic excitations in a metallic compound

Some three-dimensional materials can exhibit exotic properties that only exist in "lower" dimensions. For example, in one-dimensional chains of atoms that emerge within a bulk sample, electrons can separate into three distinct entities, each carrying information about just one aspect of the electron's identity—spin, charge, or orbit. The spinon, the entity that carries information about electron spin, has been known to control magnetism in certain insulating materials whose electron spins can point in any direction and easily flip direction. Now, a new study just published in *Science* reveals that spinons are also present in a metallic material in which the orbital movement of electrons around the atomic nucleus is the driving force behind the material's strong magnetism.

"In this bulk metallic compound, we unexpectedly found one-dimensional magnetic excitations that are typical of insulating materials whose main source of magnetism is the spin of its electrons," said physicist Igor Zaliznyak, who led the research at the U.S. Department of Energy's (DOE) Brookhaven National Laboratory. "Our new understanding of how spinons contribute to the magnetism of an orbital-dominated system could potentially lead to the development of technologies that make use of orbital magnetism—for example, quantum computing components such as magnetic data processing and storage devices."

The experimental team included Brookhaven Lab and Stony Brook University physicists Meigan Aronson and William Gannon (both now at Texas A&M University) and Liusuo Wu (now at DOE's Oak Ridge National Laboratory), all of whom pioneered the study of the metallic compound made of ytterbium, platinum, and lead (Yb₂Pt₂Pb) nearly 10 years ago. The team used magnetic neutron scattering, a technique in which a beam of neutrons is directed at a magnetic material to probe its microscopic magnetism on an atomic scale. In this technique, the magnetic moments of the neutrons interact with the magnetic moments of the material, causing the neutrons to scatter. Measuring the intensity of these scattered neutrons as a function of the momentum and energy transferred to the material produces a spectrum that reveals the dispersion and magnitude of magnetic excitations in the material.

At low energies (up to 2 milli electron volts) and low temperatures (below 100 Kelvin, or minus 279 degrees Fahrenheit), the experiments revealed a broad continuum of magnetic excitations moving in one direction. The experimental team compared these measurements with theoretical predictions of what should be observed for spinons, as calculated by theoretical physicists Alexei Tselik of Brookhaven Lab and Jean-Sebastian Caux and Michael Brockmann of the University of Amsterdam. The dispersion of magnetic excitations obtained experimentally and theoretically was in close agreement, despite the magnetic moments of the Yb atoms being four times larger than what would be expected from a spin-dominated system.

"Our measurements provide direct evidence that this compound contains isolated chains where spinons are at work. But the large size of the magnetic moments makes it clear that orbital motion, not spin, is the dominant mechanism for magnetism," said Zaliznyak.

The paper in *Science* contains details of how the scientists characterized the direction of the magnetic fluctuations and developed a model to describe the compound's behavior. They used their model to compute an approximate magnetic excitation spectrum that was compared with their experimental observations, confirming that spinons are involved in the magnetic dynamics in Yb₂Pt₂Pb.

The scientists also came up with an explanation for how the magnetic excitations occur in Yb atoms: Instead of the electronic magnetic moments flipping directions as they would in a spin-based system, electrons hop between overlapping orbitals on adjacent Yb atoms. Both mechanisms—flipping and hopping—change the total energy of the system and lead to similar magnetic fluctuations along the chains of atoms.

"There is strong coupling between spin and orbital motion. The orbital alignment is rigidly determined by electric fields generated by nearby Pb and Pt atoms. Although the Yb atoms cannot flip their magnetic moments, they can exchange their electrons via orbital overlap," Zaliznyak said.

During these orbital exchanges, the electrons are stripped of their orbital "identity," allowing electron charges to move independently of the electron orbital motion around the Yb atom's nucleus—a phenomenon that Zaliznyak and his team call charge-orbital separation.

Scientists have already demonstrated the other two mechanisms of the three-part electron identity "splitting"—namely, spin-charge separation and spin-orbital separation. "This research completes the triad of electron fractionalization phenomena," Zaliznyak said. [10]

Entanglement of Spin-1/2 Heisenberg Antiferromagnetic Quantum Spin Chains

Currently studying entanglement in condensed matter systems is of great interest. This interest stems from the fact that some behaviors of such systems can only be explained with the aid of entanglement. The magnetic susceptibility at low temperatures, quantum phase transitions,

chemical reactions are examples where the entanglement is key ingredient for a complete understanding of the system. Furthermore, in order to produce a quantum processor, the entanglement of study condensed matter systems becomes essential. In condensed matter, said magnetic materials are of particular interest. Among these we will study the ferromagnetism which are described by Heisenberg model. We use the Hilbert-Schmidt norm for measuring the distance between quantum states. The choice of this norm was due mainly to its application simplicity and strong geometric appeal. The question of whether this norm satisfies the conditions desirable for a good measure of entanglement was discussed in 1999 by C. Witte and M. Trucks. They showed that the norm of Hilbert-Schmidt is not increasing under completely positive trace-preserving maps making use of the Lindblad theorem. M. Ozawa argued that this norm does not satisfy this condition by using an example of a completely positive map which can enlarge the Hilbert Schmidt norm between two states. However this does not prove the fact that the entanglement measure based on the Hilbert-Schmidt norm is not entangled monotone. This problem has come up in several contexts in recent years. Superselection structure of dynamical semigroups, entropy production of a quantum channel, condensed matter theory and quantum information are some examples. Several authors have been devoted to this issue in recent years and other work on this matter is in progress by the author and collaborators. The study of entanglement in Heisenberg chains is of great interest in physics and has been done for several years. [9]

New electron spin secrets revealed: Discovery of a novel link between magnetism and electricity

The findings reveal a novel link between magnetism and electricity, and may have applications in electronics.

The electric current generation demonstrated by the researchers is called charge pumping. Charge pumping provides a source of very high frequency alternating electric currents, and its magnitude and external magnetic field dependency can be used to detect magnetic information.

The findings may, therefore, offer new and exciting ways of transferring and manipulating data in electronic devices based on spintronics, a technology that uses electron spin as the foundation for information storage and manipulation.

The research findings are published as an Advance Online Publication (AOP) on Nature Nanotechnology's website on 10 November 2014.

Spintronics has already been exploited in magnetic mass data storage since the discovery of the giant magnetoresistance (GMR) effect in 1988. For their contribution to physics, the discoverers of GMR were awarded the Nobel Prize in 2007.

The basis of spintronics is the storage of information in the magnetic configuration of ferromagnets and the read-out via spin-dependent transport mechanisms.

"Much of the progress in spintronics has resulted from exploiting the coupling between the electron spin and its orbital motion, but our understanding of these interactions is still immature. We need to know more so that we can fully explore and exploit these forces," says Arne Brataas, professor at NTNU and the corresponding author for the paper.

An electron has a spin, a seemingly internal rotation, in addition to an electric charge. The spin can be up or down, representing clockwise and counterclockwise rotations.

Pure spin currents are charge currents in opposite directions for the two spin components in the material.

It has been known for some time that rotating the magnetization in a magnetic material can generate pure spin currents in adjacent conductors.

However, pure spin currents cannot be conventionally detected by a voltmeter because of the cancellation of the associated charge flow in the same direction.

A secondary spin-charge conversion element is then necessary, such as another ferromagnet or a strong spin-orbit interaction, which causes a spin Hall effect.

Brataas and his collaborators have demonstrated that in a small class of ferromagnetic materials, the spin-charge conversion occurs in the materials themselves.

The spin currents created in the materials are thus directly converted to charge currents via the spin-orbit interaction.

In other words, the ferromagnets function intrinsically as generators of alternating currents driven by the rotating magnetization.

"The phenomenon is a result of a direct link between electricity and magnetism. It allows for the possibility of new nano-scale detection techniques of magnetic information and for the generation of very high-frequency alternating currents," Brataas says. [8]

Simple Experiment

Everybody can repeat my physics teacher's - Nándor Toth - middle school experiment, placing aluminum folios in form V upside down on the electric wire with static electric current, and seeing them open up measuring the electric potential created by the charge distribution, caused by the acceleration of the electrons.

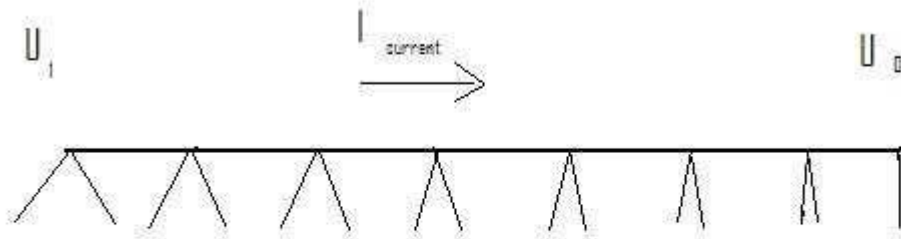

Figure 1.) Aluminium foils shows the charge distribution on the electric wire

He wanted to show us that the potential decreasing linearly along the wire and told us that in the beginning of the wire it is lowering harder, but after that the change is quite linear.

You will see that the foils will draw a parabolic curve showing the charge distribution along the wire, since the way of the accelerated electrons in the wire is proportional with the square of time. The free external charges are moving along the wire, will experience this charge distribution caused electrostatic force and repelled if moving against the direction of the electric current and attracted in the same direction – the magnetic effect of the electric current.

Uniformly accelerated electrons of the steady current

In the steady current $I = dq/dt$, the q electric charge crossing the electric wire at any place in the same time is constant. This does not require that the electrons should move with a constant v velocity and does not exclude the possibility that under the constant electric force created by the $E = -dU/dx$ potential changes the electrons could accelerating.

If the electrons accelerating under the influence of the electric force, then they would arrive to the $x = \frac{1}{2} at^2$ in the wire. The $dx/dt = at$, means that every second the accelerating q charge will take a linearly growing length of the wire. For simplicity if $a=2$ then the electrons would found in the wire at $x = 1, 4, 9, 16, 25 \dots$, which means that the dx between them should be 3, 5, 7, 9 ..., linearly increasing the volume containing the same q electric charge. It means that the density of the electric charge decreasing linearly and as the consequence of this the U field is decreasing linearly as expected: $-dU/dx = E = \text{const.}$

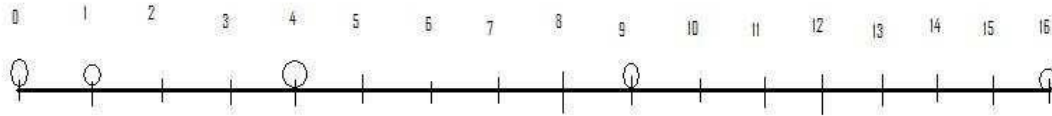

Figure 2.) The accelerating electrons created charge distribution on the electric wire

This picture remembers the Galileo's Slope of the accelerating ball, showed us by the same teacher in the middle school, some lectures before. I want to thank him for his enthusiastic and impressive lectures, giving me the associating idea between the Galileo's Slope and the accelerating charges of the electric current.

We can conclude that the electrons are accelerated by the electric \mathbf{U} potential, and with this accelerated motion they are maintaining the linear potential decreasing of the \mathbf{U} potential along they movement. Important to mention, that the linearly decreasing charge density measured in the referential frame of the moving electrons. Along the wire in its referential frame the charge density lowering parabolic, since the charges takes way proportional with the square of time.

The decreasing \mathbf{U} potential is measurable, simply by measuring it at any place along the wire. One of the simple visualizations is the aluminum foils placed on the wire opening differently depending on the local charge density. The static electricity is changing by parabolic potential giving the equipotential lines for the external moving electrons in the surrounding of the wire.

Magnetic effect of the decreasing \mathbf{U} electric potential

One \mathbf{q} electric charge moving parallel along the wire outside of it with velocity v would experience a changing \mathbf{U} electric potential along the wire. If it experiencing an emerging potential, it will repel the charge, in case of decreasing \mathbf{U} potential it will move closer to the

wire. This radial electric field will move the external electric charge on the parabolic curve, on the equipotential line of the accelerated charges of the electric current. This is exactly the magnetic effect of the electric current. A constant force, perpendicular to the direction of the movement of the matter will change its direction to a parabolic curve.

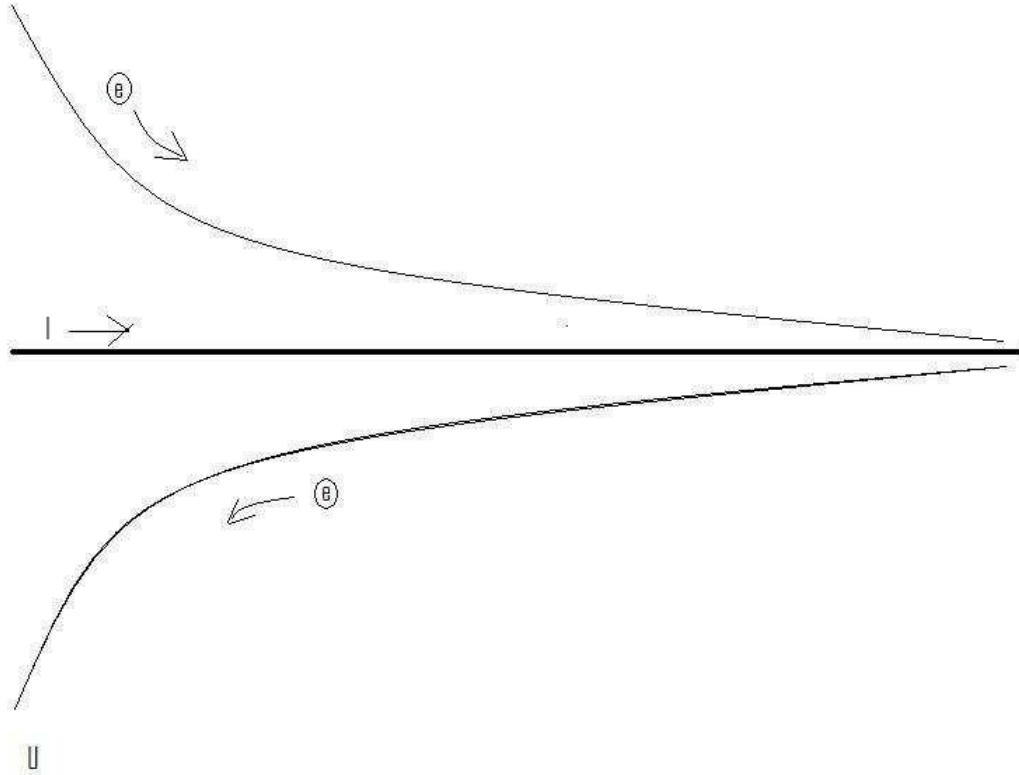

Figure 3.) Concentric parabolic equipotential surfaces around the electric wire causes the magnetic effect on the external moving charges

Considering that the magnetic effect is $\mathbf{F} = q \mathbf{v} \times \mathbf{B}$, where the \mathbf{B} is concentric circle around the electric wire, it is an equipotential circle of the accelerating electrons caused charge distribution. Moving on this circle there is no electric and magnetic effect for the external charges, since $\mathbf{v} \times \mathbf{B} = \mathbf{0}$. Moving in the direction of the current the electric charges crosses the biggest potential change, while in any other direction – depending on the angle between the current and velocity of the external charge there is a modest electric potential difference, giving exactly the same force as the $\mathbf{v} \times \mathbf{B}$ magnetic force.

Getting the magnetic force from the $\mathbf{F} = d\mathbf{p}/dt$ equation we will understand the magnetic field velocity dependency. Finding the appropriate trajectory of the moving charges we need simply get it from the equipotential lines on the equipotential surfaces, caused by the accelerating charges of the electric current. We can prove that the velocity dependent force causes to move the charges on the equipotential surfaces, since the force due to the potential difference according to the velocity angle – changing only the direction, but not the value of the charge's velocity.

The work done on the charge and the Hamilton Principle

One basic feature of magnetism is that, in the vicinity of a magnetic field, a moving charge will experience a force. Interestingly, the force on the charged particle is always perpendicular to the direction it is moving. Thus magnetic forces cause charged particles to change their direction of motion, but they do not change the speed of the particle. This property is used in high-energy particle accelerators to focus beams of particles which eventually collide with targets to produce new particles. Another way to understand this is to realize that if the force is perpendicular to the motion, then no work is done. Hence magnetic forces do no work on charged particles and cannot increase their kinetic energy. If a charged particle moves through a constant magnetic field, its speed stays the same, but its direction is constantly changing. [2]

In electrostatics, the work done to move a charge from any point on the equipotential surface to any other point on the equipotential surface is zero since they are at the same potential. Furthermore, equipotential surfaces are always perpendicular to the net electric field lines passing through it. [3]

Consequently the work done on the moving charges is zero in both cases, proving that they are equal forces, that is they are the same force.

The accelerating charges self-maintaining potential equivalent with the Hamilton Principle and the Euler-Lagrange equation. [4]

The Magnetic Vector Potential

Also the $\underline{\mathbf{A}}$ magnetic vector potential gives the radial parabolic electric potential change of the charge distribution due to the acceleration of electric charges in the electric current.

Necessary to mention that the $\underline{\mathbf{A}}$ magnetic vector potential is proportional with $\underline{\mathbf{a}}$, the acceleration of the charges in the electric current although this is not the only parameter.

The $\underline{\mathbf{A}}$ magnetic vector potential is proportional with $I=dQ/dt$ electric current, which is proportional with the strength of the charge distribution along the wire. Although it is proportional also with the U potential difference $I=U/R$, but the R resistivity depends also on the cross-sectional area, that is bigger area gives stronger I and $\underline{\mathbf{A}}$. [7] This means that the bigger potential differences with smaller cross-section can give the same I current and $\underline{\mathbf{A}}$ vector potential, explaining the gauge transformation.

Since the magnetic field B is defined as the curl of $\underline{\mathbf{A}}$, and the curl of a gradient is identically zero, then any arbitrary function which can be expressed as the gradient of a scalar function may be added to A without changing the value of B obtained from it. That is, A' can be freely substituted for A where

$$\vec{A}' = \vec{A} + \nabla\phi$$

Such transformations are called gauge transformations, and there have been a number of "gauges" that have been used to advantage in specific types of calculations in electromagnetic theory. [5]

Since the potential difference and the vector potential both are in the direction of the electric current, this gauge transformation could explain the self-maintaining electric potential of the accelerating electrons in the electric current. Also this is the source of the special and general relativity.

The Constant Force of the Magnetic Vector Potential

Moving on the parabolic equipotential line gives the same result as the constant force of gravitation moves on a parabolic line with a constant velocity moving body.

Electromagnetic four-potential

The electromagnetic four-potential defined as:

$$A^\alpha = (\phi/c, \mathbf{A}) \quad \text{SI units} \quad A^\alpha = (\phi, \mathbf{A}) \quad \text{cgs units}$$

in which ϕ is the electric potential, and \mathbf{A} is the magnetic vector potential. [6] This is appropriate with the four-dimensional space-time vector (T, \mathbf{R}) and in stationary current gives that the potential difference is constant in the time dimension and vector potential (and its curl, the magnetic field) is constant in the space dimensions.

Magnetic induction

Increasing the electric current I causes increasing magnetic field \mathbf{B} by increasing the acceleration of the electrons in the wire. Since $I=at$, if the acceleration of electrons is growing, then the charge density dQ/dl will decrease in time, creating a $-\mathbf{E}$ electric field. Since the resistance of the wire is constant, only increasing U electric potential could cause an increasing electric current $I=U/R=dQ/dt$. The charge density in the static current changes linearly in the time coordinates. Changing its value in time will cause a static electric force, negative to the accelerating force change. This explains the relativistic changing mass of the charge in time also.

Necessary to mention that decreasing electric current will decrease the acceleration of the electrons, causing increased charge density and \mathbf{E} positive field.

The electric field is a result of the geometric change of the \mathbf{U} potential and the timely change of the \mathbf{A} magnetic potential:

$$\mathbf{E} = -d\mathbf{A}/dt - dU/dr$$

$$\mathbf{B} = \nabla \times \mathbf{A}, \quad \mathbf{E} = -\nabla\phi - \frac{\partial \mathbf{A}}{\partial t},$$

The acceleration of the electric charges proportional with the A magnetic vector potential in the electric current and also their time dependence are proportional as well. Since the A vector potential is appears in the equation, the proportional \mathbf{a} acceleration will satisfy the same equation.

Since increasing acceleration of charges in the increasing electric current the result of increasing potential difference, creating a decreasing potential difference, the electric and magnetic vector potential are changes by the next wave - function equations:

$$\frac{1}{c^2} \frac{\partial^2 \varphi}{\partial t^2} - \nabla^2 \varphi = \frac{\rho}{\epsilon_0}$$

$$\nabla^2 \mathbf{A} - \frac{1}{c^2} \frac{\partial^2 \mathbf{A}}{\partial t^2} = -\mu_0 \mathbf{J}$$

The simple experiment with periodical changing \mathbf{U} potential and \mathbf{I} electric current will move the aluminium folios with a moving wave along the wire.

The Lorentz gauge says exactly that the accelerating charges are self maintain their accelerator fields and the divergence (source) of the A vector potential is the timely change of the electric potential.

$$\nabla \cdot \vec{A} + \frac{1}{c^2} \frac{\partial \varphi}{\partial t} = 0.$$

Or

$$\vec{E} = -\nabla \varphi - \frac{\partial \vec{A}}{\partial t}.$$

The timely change of the A vector potential, which is the proportionally changing acceleration of the charges will produce the negative electric field.

Lorentz transformation of the Special Relativity

In the referential frame of the accelerating electrons the charge density lowering linearly because of the linearly growing way they takes every next time period. From the referential frame of the wire there is a parabolic charge density lowering.

The difference between these two referential frames, namely the referential frame of the wire and the referential frame of the moving electrons gives the relativistic effect. Important to say that the moving electrons presenting the time coordinate, since the electrons are taking linearly increasing way every next time period, and the wire presenting the geometric coordinate.

The Lorentz transformations are based on moving light sources of the Michelson - Morley experiment giving a practical method to transform time and geometric coordinates without explaining the source of this mystery.

The real mystery is that the accelerating charges are maintaining the accelerating force with their charge distribution locally. The resolution of this mystery that the charges are simply the results of the diffraction patterns, that is the charges and the electric field are two sides of the same thing. Otherwise the charges could exceed the velocity of the electromagnetic field.

The increasing mass of the electric charges the result of the increasing inductive electric force acting against the accelerating force. The decreasing mass of the decreasing acceleration is the result of the inductive electric force acting against the decreasing force. This is the relativistic mass change explanation, especially importantly explaining the mass reduction in case of velocity decrease.

Heisenberg Uncertainty Relation

In the atomic scale the Heisenberg uncertainty relation gives the same result, since the moving electron in the atom accelerating in the electric field of the proton, causing a charge distribution on Δx position difference and with a Δp momentum difference such a way that they product is about the half Planck reduced constant. For the proton this Δx much less in the nucleon, than in the orbit of the electron in the atom, the Δp is much higher because of the greater proton mass.

This means that the electron and proton are not point like particles, but has a real charge distribution.

Wave – Particle Duality

The accelerating electrons explains the wave – particle duality of the electrons and photons, since the elementary charges are distributed on Δx position with Δp impulse and creating a wave packet of the electron. The photon gives the electromagnetic particle of the mediating force of the electrons electromagnetic field with the same distribution of wavelengths.

Atomic model

The constantly accelerating electron in the Hydrogen atom is moving on the equipotential line of the proton and it's kinetic and potential energy will be constant. Its energy will change only when it is changing its way to another equipotential line with another value of potential energy or getting free with enough kinetic energy. This means that the Rutherford-Bohr atomic model is right and only the changing acceleration of the electric charge causes radiation, not the steady

acceleration. The steady acceleration of the charges only creates a centric parabolic steady electric field around the charge, the magnetic field. This gives the magnetic moment of the atoms, summing up the proton and electron magnetic moments caused by their circular motions and spins.

Fermions' spin

The moving charges are accelerating, since only this way can self maintain the electric field causing their acceleration. The electric charge is not point like! This constant acceleration possible if there is a rotating movement changing the direction of the velocity. This way it can accelerate forever without increasing the absolute value of the velocity in the dimension of the time and not reaching the velocity of the light.

The Heisenberg uncertainty relation says that the minimum uncertainty is the value of the spin: $1/2 \hbar = dx dp$ or $1/2 \hbar = dt dE$, that is the value of the basic energy status, consequently related to the m_0 inertial mass of the fermions.

The photon's 1 spin value and the electric charges 1/2 spin gives us the idea, that the electric charge and the electromagnetic wave two sides of the same thing, $1/2 - (-1/2) = 1$.

Fine structure constant

The Planck constant was first described as the proportionality constant between the energy E of a photon and the frequency ν of its associated electromagnetic wave. This relation between the energy and frequency is called the Planck relation or the Planck–Einstein equation:

$$E = h\nu .$$

Since the frequency ν , wavelength λ , and speed of light c are related by $\lambda\nu = c$, the Planck relation can also be expressed as

$$E = \frac{hc}{\lambda} .$$

Since this is the source of the Planck constant, the e electric charge countable from the Fine structure constant. This also related to the Heisenberg uncertainty relation, saying that the mass of the proton should be bigger than the electron mass because of the difference between their wavelengths, since $E = mc^2$.

The expression of the fine-structure constant becomes the abbreviated

$$\alpha = \frac{e^2}{\hbar c}$$

This is a dimensionless constant expression, $1/137$ commonly appearing in physics literature.

This means that the electric charge is a result of the electromagnetic waves diffractions, consequently the proton – electron mass ratio is the result of the equal intensity of the corresponding electromagnetic frequencies in the Planck distribution law.

Planck Distribution Law

The Planck distribution law explains the different frequencies of the proton and electron, giving equal intensity to different lambda wavelengths! The weak interaction transforms an electric charge in the diffraction pattern from one side to the other side, causing an electric dipole momentum change, which violates the CP and time reversal symmetry.

The Planck distribution law is temperature dependent and it should be true locally and globally. I think that Einstein's energy-matter equivalence means some kind of existence of electromagnetic oscillations enabled by the temperature, creating the different matter formulas, atoms, molecules, crystals, dark matter and energy.

One way dividing the proton to three parts is, dividing his oscillation by the three direction of the space. We can order $1/3 e$ charge to each coordinates and $2/3 e$ charge to one plane oscillation, because the charge is scalar. In this way the proton has two $+2/3 e$ plane oscillation and one linear oscillation with $-1/3 e$ charge. The colors of quarks are coming from the three directions of coordinates and the proton is colorless. [1]

Electromagnetic inertia and Gravitational attraction

Since the magnetic induction creates a negative electric field as a result of the changing acceleration, it works as an electromagnetic changing mass.

It looks clear that the growing acceleration results the relativistic growing mass - limited also with the velocity of the electromagnetic wave.

The negatively changing acceleration causes a positive electric field, working as a decreasing mass.

Since $E = hv$ and $E = mc^2$, $m = hv/c^2$ that is the m depends only on the ν frequency. It means that the mass of the proton and electron are electromagnetic and the result of the electromagnetic induction, caused by the changing acceleration of the spinning and moving charge! It could be that the m_0 inertial mass is the result of the spin, since this is the only accelerating motion of the electric charge. Since the accelerating motion has different frequency for the electron in the atom and the proton, they masses are different, also as the wavelengths on both sides of the diffraction pattern, giving equal intensity of radiation.

If the mass is electromagnetic, then the gravitation is also electromagnetic effect caused by the magnetic effect between the same charges, they would attract each other if they are moving parallel by the magnetic effect.

The Planck distribution law explains the different frequencies of the proton and electron, giving equal intensity to different lambda wavelengths. Also since the particles are diffraction patterns they have some closeness to each other – can be seen as the measured effect of the force of the gravitation, since the magnetic effect depends on this closeness. This way the mass and the magnetic attraction depend equally on the wavelength of the electromagnetic waves.

Conclusions

The generation and modulation of high-frequency currents are central wireless communication devices such as mobile phones, WLAN modules for personal computers, Bluetooth devices and future vehicle radars. [8]

Needless to say that the accelerating electrons of the steady stationary current are a simple demystification of the magnetic field, by creating a decreasing charge distribution along the wire, maintaining the decreasing U potential and creating the \underline{A} vector potential experienced by the electrons moving by \underline{v} velocity relative to the wire. This way it is easier to understand also the time dependent changes of the electric current and the electromagnetic waves as the resulting fields moving by c velocity.

There is a very important law of the nature behind the self maintaining \underline{E} accelerating force by the accelerated electrons. The accelerated electrons created electromagnetic fields are so natural that they occur as electromagnetic waves traveling with velocity c. It shows that the electric charges are the result of the electromagnetic waves diffraction.

One of the most important conclusions is that the electric charges are moving in an accelerated way and even if their velocity is constant, they have an intrinsic acceleration anyway, the so called spin, since they need at least an intrinsic acceleration to make possible their movement. The bridge between the classical and quantum theory is based on this intrinsic acceleration of the spin, explaining also the Heisenberg Uncertainty Principle. The particle – wave duality of the electric charges and the photon makes certain that they are both sides of the same thing. Basing the gravitational force on the magnetic force and the Planck Distribution Law of the electromagnetic waves caused diffraction gives us the basis to build a Unified Theory of the physical interactions.

References

[1] 3 Dimensional String Theory

Author: George Rajna

Publisher: academia.edu

http://www.academia.edu/3834454/3_Dimensional_String_Theory

[2] Magnetic forces on moving charges

http://theory.uwinnipeg.ca/mod_tech/node93.html

[3] Equipotential surface

http://en.wikipedia.org/wiki/Equipotential_surface

[4] Hamilton Principle

http://en.wikipedia.org/wiki/Hamilton%27s_principle

[5] Magnetic Vector Potential <http://hyperphysics.phy->

[astr.gsu.edu/hbase/magnetic/magvec.html](http://hyperphysics.phy-astr.gsu.edu/hbase/magnetic/magvec.html)

[6] Electromagnetic four-potential

http://en.wikipedia.org/wiki/Electromagnetic_four-potential

[7] http://en.wikipedia.org/wiki/Electrical_resistivity_and_conductivity

[8] New electron spin secrets revealed: Discovery of a novel link between

magnetism and electricity <http://phys.org/news/2014-11-electron->

[secrets-revealed-discovery-link.html](http://phys.org/news/2014-11-electron-secrets-revealed-discovery-link.html) [9] Entanglement of Spin-12

Heisenberg Antiferromagnetic Quantum Spin Chains

<http://arxiv.org/pdf/1605.04373v1.pdf>

[10] Scientists find surprising magnetic excitations in a metallic compound

<http://phys.org/news/2016-06-scientists-magnetic-metallic-compound.html>

[11] Using lasers to make data storage faster than ever <http://phys.org/news/2016->

[06-lasers-storage-faster.html](http://phys.org/news/2016-06-lasers-storage-faster.html) [12] New device lengthens the life of quantum information

<http://phys.org/news/2016-07-yale-developed-device-lengthens-life-quantum.html>

[13] Researchers blur the line between classical and quantum physics by connecting chaos and

entanglement <http://phys.org/news/2016-07-blur-line-classical-quantum-physics.html> [14]

Physicists retrieve 'lost' information from quantum measurements

<http://phys.org/news/2016-09-physicists-lost-quantum.html>

[15] A single photon reveals quantum entanglement of 16 million atoms

<https://phys.org/news/2017-10-photon-reveals-quantum-entanglement-million.html>

[16] Generalized Hardy's paradox shows an even stronger conflict between quantum and classical physics

<https://phys.org/news/2018-02-hardy-paradox-stronger-conflict-quantum.html>

[17] Physicists extend stochastic thermodynamics deeper into quantum territory

<https://phys.org/news/2018-02-physicists-stochastic-thermodynamics-deeper-quantum.html>

[18] Maxwell's demon in the quantum Zeno regime

<https://phys.org/news/2018-03-maxwell-demon-quantum-zeno-regime.html>

[19] Researchers find quantum 'Maxwell's demon' may give up information to extract work

<https://phys.org/news/2018-07-quantum-maxwell-demon.html>

[20] Entropy and search engines

<https://phys.org/news/2018-10-entropy.html>

[21] Experiments detect entropy production in mesoscopic quantum systems

<https://phys.org/news/2019-01-entropy-production-mesoscopic-quantum.html>

[22] Observation of quantized heating in quantum matter

<https://phys.org/news/2019-02-quantized-quantum.html>

[23] A polariton filter turns ordinary laser light into quantum light

<https://phys.org/news/2019-02-polariton-filter-ordinary-laser-quantum.html>

[24] New imaging technology captures movement of quantum particles with unprecedented resolution

<https://phys.org/news/2019-02-imaging-technology-captures-movement-quantum.html>

[25] In the blink of an eye: Team uses quantum of light to create new quantum simulator

<https://phys.org/news/2019-02-eye-team-quantum-simulator.html>

[26] Free-space data-carrying bendable light communications

<https://phys.org/news/2019-10-free-space-data-carrying-bendable.html>

