

Dynamic Aspirin Molecular Vibrations

Aspirin is not only an important drug, but also an interesting physics model system in which molecular vibrations and electrons are coupled in a particular way. [55]

In a new method, materials scientists Boliang Jia and colleagues at the departments of mechanical engineering and robotics presented a printable biocompatible superlens placed directly on objects of interest to observe subdiffraction-limited features (resolution beyond the diffraction limit). [54]

Physicists have also devised photonic topological insulators, synthetic materials that impart light waves with distinct topological features, allowing light (rather than electric currents) to flow via topological surface states. [53]

"This research highlights the cutting-edge research being done at WVU, and we are very excited to see their work appear in the very high-profile journal Nature Communications." [52]

By constructing a hybrid device made from two different types of qubit—the fundamental computing element of quantum computers—they have created a device that can be quickly initialized and read out, and that simultaneously maintains high control fidelity. [51]

Researchers have demonstrated that an amoeba—a single-celled organism consisting mostly of gelatinous protoplasm—has unique computing abilities that may one day offer a competitive alternative to the methods used by conventional computers. [50]

For the first time, researchers have used tiny gears made of germanium to generate a vortex of twisted light that turns around its axis of travel much like a corkscrew. [49]

Physical systems with discrete energy levels are ubiquitous in nature and form fundamental building blocks of quantum technology. [48]

In a similar vein, scientists are working to create twisting helical electromagnetic waves whose curvature allows more accurate imaging of the magnetic properties of different materials at the atomic level and could possibly lead to the development of future devices. [47]

In a recent study, materials scientists Guojin Liang and his coworkers at the Department of Materials Science and Engineering, City University of Hong Kong, have developed a

self-healing, electroluminescent (EL) device that can repair or heal itself after damage. [46]

A team of researchers based at The University of Manchester have found a low cost method for producing graphene printed electronics, which significantly speeds up and reduces the cost of conductive graphene inks. [45]

Graphene-based computer components that can deal in terahertz “could be used, not in a normal Macintosh or PC, but perhaps in very advanced computers with high processing rates,” Ozaki says. This 2-D material could also be used to make extremely high-speed nanodevices, he adds. [44]

Printed electronics use standard printing techniques to manufacture electronic devices on different substrates like glass, plastic films, and paper. [43]

*A tiny laser comprising an array of nanoscale semiconductor cylinders (see image) has been made by an all-A*STAR team. [42]*

A new instrument lets researchers use multiple laser beams and a microscope to trap and move cells and then analyze them in real-time with a sensitive analysis technique known as Raman spectroscopy. [41]

All systems are go for launch in November of NASA's Global Ecosystem Dynamics Investigation (GEDI) mission, which will use high-resolution laser ranging to study Earth's forests and topography from the International Space Station (ISS). [40]

Scientists from the Max Born Institute for Nonlinear Optics and Short Pulse Spectroscopy (MBI) in Berlin combined state-of-the-art experiments and numerical simulations to test a fundamental assumption underlying strong-field physics. [39]

Femtosecond lasers are capable of processing any solid material with high quality and high precision using their ultrafast and ultra-intense characteristics. [38]

To create the flying microlaser, the researchers launched laser light into a water-filled hollow core fiber to optically trap the microparticle. Like the materials used to make traditional lasers, the microparticle incorporates a gain medium. [37]

Lasers that emit ultrashort pulses of light are critical components of technologies, including communications and industrial processing, and have been central to fundamental Nobel Prize-winning research in physics. [36]

A newly developed laser technology has enabled physicists in the Laboratory for Attosecond Physics (jointly run by LMU Munich and the Max Planck Institute of Quantum

Optics) to generate attosecond bursts of high-energy photons of unprecedented intensity. [35]

The unique platform, which is referred to as a 4-D microscope, combines the sensitivity and high time-resolution of phase imaging with the specificity and high spatial resolution of fluorescence microscopy. [34]

The experiment relied on a soliton frequency comb generated in a chip-based optical microresonator made from silicon nitride. [33]

This scientific achievement toward more precise control and monitoring of light is highly interesting for miniaturizing optical devices for sensing and signal processing. [32]

It may seem like such optical behavior would require bending the rules of physics, but in fact, scientists at MIT, Harvard University, and elsewhere have now demonstrated that photons can indeed be made to interact - an accomplishment that could open a path toward using photons in quantum computing, if not in light sabers. [31]

Optical highways for light are at the heart of modern communications. But when it comes to guiding individual blips of light called photons, reliable transit is far less common. [30]

Theoretical physicists propose to use negative interference to control heat flow in quantum devices. [29]

Particle physicists are studying ways to harness the power of the quantum realm to further their research. [28]

A collaboration between the lab of Judy Cha, the Carol and Douglas Melamed Assistant Professor of Mechanical Engineering & Materials Science, and IBM's Watson Research Center could help make a potentially revolutionary technology more viable for manufacturing. [27]

A fundamental barrier to scaling quantum computing machines is "qubit interference." In new research published in Science Advances, engineers and physicists from [HYPERLINK "https://www.rigetti.com/"](https://www.rigetti.com/) Rigetti Computing describe a breakthrough that can expand the size of practical quantum processors by reducing interference. [26]

The search and manipulation of novel properties emerging from the quantum nature of matter could lead to next-generation electronics and quantum computers. [25]

A research team from the Department of Energy's Lawrence Berkeley National Laboratory (Berkeley Lab) has found the first evidence that a shaking motion in the

structure of an atomically thin (2-D) material possesses a naturally occurring circular rotation. [24]

Topological effects, such as those found in crystals whose surfaces conduct electricity while their bulk does not, have been an exciting topic of physics research in recent years and were the subject of the 2016 Nobel Prize in physics. [23]

A new technique developed by MIT researchers reveals the inner details of photonic crystals, synthetic materials whose exotic optical properties are the subject of widespread research. [22]

In experiments at SLAC, intense laser light (red) shining through a magnesium oxide crystal excited the outermost "valence" electrons of oxygen atoms deep inside it. [21]

LCLS works like an extraordinary strobe light: Its ultrabright X-rays take snapshots of materials with atomic resolution and capture motions as fast as a few femtoseconds, or millionths of a billionth of a second. For comparison, one femtosecond is to a second what seven minutes is to the age of the universe. [20]

A 'nonlinear' effect that seemingly turns materials transparent is seen for the first time in X-rays at SLAC's LCLS. [19]

Leiden physicists have manipulated light with large artificial atoms, so-called quantum dots. Before, this has only been accomplished with actual atoms. It is an important step toward light-based quantum technology. [18]

In a tiny quantum prison, electrons behave quite differently as compared to their counterparts in free space. They can only occupy discrete energy levels, much like the electrons in an atom - for this reason, such electron prisons are often called "artificial atoms". [17]

When two atoms are placed in a small chamber enclosed by mirrors, they can simultaneously absorb a single photon. [16]

Optical quantum technologies are based on the interactions of atoms and photons at the single-particle level, and so require sources of single photons that are highly indistinguishable – that is, as identical as possible. Current single-photon sources using semiconductor quantum dots inserted into photonic structures produce photons that are ultrabright but have limited indistinguishability due to charge noise, which results in a fluctuating electric field. [14]

A method to produce significant amounts of semiconducting nanoparticles for light-emitting displays, sensors, solar panels and biomedical applications has gained momentum with a demonstration by researchers at the Department of Energy's Oak Ridge National Laboratory. [13]

A source of single photons that meets three important criteria for use in quantum-information systems has been unveiled in China by an international team of physicists. Based on a quantum dot, the device is an efficient source of photons that emerge as solo particles that are indistinguishable from each other. The researchers are now trying to use the source to create a quantum computer based on "boson sampling". [11]

With the help of a semiconductor quantum dot, physicists at the University of Basel have developed a new type of light source that emits single photons. For the first time, the researchers have managed to create a stream of identical photons. [10]

Optical photons would be ideal carriers to transfer quantum information over large distances. Researchers envisage a network where information is processed in certain nodes and transferred between them via photons. [9]

While physicists are continually looking for ways to unify the theory of relativity, which describes large-scale phenomena, with quantum theory, which describes small-scale phenomena, computer scientists are searching for technologies to build the quantum computer using Quantum Information.

In August 2013, the achievement of "fully deterministic" quantum teleportation, using a hybrid technique, was reported. On 29 May 2014, scientists announced a reliable way of transferring data by quantum teleportation. Quantum teleportation of data had been done before but with highly unreliable methods.

The accelerating electrons explain not only the Maxwell Equations and the Special Relativity, but the Heisenberg Uncertainty Relation, the Wave-Particle Duality and the electron's spin also, building the Bridge between the Classical and Quantum Theories.

The Planck Distribution Law of the electromagnetic oscillators explains the electron/proton mass rate and the Weak and Strong Interactions by the diffraction patterns. The Weak Interaction changes the diffraction patterns by moving the electric charge from one side to the other side of the diffraction pattern, which violates the CP and Time reversal symmetry.

The diffraction patterns and the locality of the self-maintaining electromagnetic potential explains also the Quantum Entanglement, giving it as a natural part of the Relativistic Quantum Theory and making possible to build the Quantum Computer with the help of Quantum Information.

Contents

Preface	9
Dynamic aspirin – molecular vibrations drive electrons over large distances	9

Biophotonics: In situ printing liquid superlenses to image butterfly wings and nanobiostructures.....	10
Scientists realize a three-dimensional 'topological' medium for electromagnetic waves	15
Reimagining information processing.....	16
Hybrid qubits solve key hurdle to quantum computing	17
Amoeba finds approximate solutions to NP-hard problem in linear time	18
How it works	19
Twisting light to enable high-capacity data transmission.....	20
Using strain to improve light emission.....	21
Precision optical simulations	21
Electronically programmable photonic molecule	22
Scientists use magnetic defects to achieve electromagnetic wave breakthrough	26
Self-healing electroluminescent (EL) devices.....	27
Scientists develop a new method to revolutionize graphene printed electronics.....	31
Here's how graphene could make future electronics superfast.....	32
Crunch time	33
Laser sintering optimized for printed electronics	34
An ultracompact laser has been made using nanoscale semiconductor columns.....	35
Researchers optically trap, move and analyze living cells with laser/microscope combo ...	36
Combining trapping and spectroscopy.....	36
Fast acquisition.....	37
Near-infrared laser systems for monitoring forest dynamics from space pass final tests....	37
Laser-driven electron recollision remembers molecular orbital structure.....	39
Femtosecond laser fabrication—realizing dynamics control of electrons.....	40
Researchers create microlaser that flies along hollow optical fiber.....	41
Making a laser fly.....	41
Precision temperature sensing.....	42
New ultrafast measurement technique shows how lasers start from chaos	42
Attoseconds break into atomic interior.....	43
Super-resolution microscopy in both space and time.....	45
Optical distance measurement at record-high speed	47
Researchers turn light upside down.....	49
New form of light: Newly observed optical state could enable quantum computing with photons.....	50
Biggering and biggering.....	51

Memorable encounters.....	51
New hole-punched crystal clears a path for quantum light.....	52
Interference as a new method for cooling quantum devices	53
Learning to speak quantum.....	54
Quantum computers	54
Quantum sensors	56
Researchers developing phase-change memory devices for more powerful computing.....	56
New controls scale quantum chips	57
Controlling quantum interactions in a single material	58
Scientists discover chiral phonons in a 2-D semiconductor crystal.....	59
New exotic phenomena seen in photonic crystals.....	62
Photonic crystals reveal their internal characteristics with new method.....	64
New tabletop technique probes outermost electrons of atoms deep inside solids	65
A New Way to Look at Atoms in Solids	66
Steering Electrons to Generate Light	66
X-ray laser glimpses how electrons dance with atomic nuclei in materials.....	67
Turning Heat into Electricity and Vice Versa.....	68
Controlling Materials by Stimulating Charged Waves.....	68
A Bright Future for Studies of the Electron-Phonon Dance	69
A 'nonlinear' effect that seemingly turns materials transparent is seen for the first time in X-rays at SLAC's LCLS	69
A Milestone in Understanding How Light Interacts with Matter	70
A Most Puzzling Result.....	70
Researchers use quantum dots to manipulate light.....	71
Quantum dots	71
Quantum cryptography	72
'Artificial atom' created in graphene	72
Building Artificial Atoms	72
Cutting edge is not enough.....	72
Two atoms in an optical cavity can absorb one photon.....	73
One for two?	73
Quantum switch	74
Quantum processor for single photons	74
The path to perfection: Quantum dots in electrically-controlled cavities yield bright, nearly identical photons	76

Team demonstrates large-scale technique to produce quantum dots	80
Superfast light source made from artificial atom.....	81
Quantum speed up	82
Increasing the light-matter interaction	82
Single-photon source is efficient and indistinguishable	82
Exciting dots	83
Quantum sandwich.....	83
Semiconductor quantum dots as ideal single-photon source.....	84
Noise in the semiconductor	84
How to Win at Bridge Using Quantum Physics.....	85
Quantum Information.....	85
Heralded Qubit Transfer.....	85
Quantum Teleportation	86
Quantum Computing	87
Quantum Entanglement	87
The Bridge	87
Accelerating charges	87
Relativistic effect.....	88
Heisenberg Uncertainty Relation	88
Wave – Particle Duality	88
Atomic model.....	88
The Relativistic Bridge	88
The weak interaction	89
The General Weak Interaction.....	90
Fermions and Bosons	91
Van Der Waals force	91
Electromagnetic inertia and mass.....	91
Electromagnetic Induction	91
Relativistic change of mass	91
The frequency dependence of mass.....	91
Electron – Proton mass rate	91
Gravity from the point of view of quantum physics	92
The Gravitational force	92
The Higgs boson	92

Higgs mechanism and Quantum Gravity	93
What is the Spin?.....	93
The Graviton	94
Conclusions	94
References	95

Author: George Rajna

Preface

While physicists are continually looking for ways to unify the theory of relativity, which describes large-scale phenomena, with quantum theory, which describes small-scale phenomena, computer scientists are searching for technologies to build the quantum computer.

Australian engineers detect in real-time the quantum spin properties of a pair of atoms inside a silicon chip, and disclose new method to perform quantum logic operations between two atoms. [5]

Quantum entanglement is a physical phenomenon that occurs when pairs or groups of particles are generated or interact in ways such that the quantum state of each particle cannot be described independently – instead, a quantum state may be given for the system as a whole. [4]

I think that we have a simple bridge between the classical and quantum mechanics by understanding the Heisenberg Uncertainty Relations. It makes clear that the particles are not point like but have a dx and dp uncertainty.

Dynamic aspirin – molecular vibrations drive electrons over large distances

Aspirin is not only an important drug, but also an interesting physics model system in which molecular vibrations and electrons are coupled in a particular way. For the first time, X-ray experiments in the ultrashort time domain make electron motions visible in real time. They demonstrate that very small atomic displacements shift electrons over much larger distances within the aspirin molecules.

Aspirin pills (Figure 1a) consist of many small crystallites in which molecules of acetylsalicylic acid form a regular spatial arrangement (Figure 1b). The molecules couple to each other via comparably weak interactions and generate electric fields which exert a force on the electrons of every molecule. Upon excitation of molecular vibrations, the distribution of electrons in space and, thus, the chemical properties should change. While this scenario has been a subject of theoretical work, there has been no experimental demonstration and understanding of the molecular dynamics so far.

Scientists of the Max Born Institute in Berlin, Germany, have now gained the first direct observation of electron motion during a coupled vibration of the aspirin molecules. In a recent issue of the journal *Structural Dynamics*, they report results of an X-ray experiment in the ultrashort time domain. An ultrashort optical pump pulse induces vibrations of the aspirin molecules with a vibrational period of approximately one picosecond. An ultrashort hard X-ray pulse, which is delayed relative to the pump pulse, is diffracted from the excited powder of crystallites to map the momentary spatial arrangement of electrons via an X-ray diffraction pattern.

The animation in Figure 1c shows the rotational [motion](#) of the methyl (CH₃) group of an aspirin molecule which arises upon vibrational excitation. In the animation, the atomic displacements are artificially enlarged to make them visible. The methyl rotation is connected with a spatial shift of electrons over the entire aspirin molecule (yellow clouds, so-called isosurface of constant electron density). The periodic electron motions occur in time with the vibrational motions of the atoms and the distances traveled by the electrons are typically 10000 times larger than the atom displacements in the methyl rotation. This behavior demonstrates the hybrid character of the methyl rotation which is comprised of both atomic and electron motions on totally different length scales. The hybrid character originates from the electric interaction between the aspirin molecules and the dynamic minimization of electrostatic energy in the crystallite.

These new results emphasize the central role of hybrid modes for the stabilization of the crystal structure, in agreement with theoretical calculations. In the case of [aspirin](#), this property favors the so-called form 1 of the crystal structure compared to other molecular arrangements. The strong modulation of the electron distribution by vibrations is relevant for numerous crystal structures in which electric interactions prevail. Vibrational excitations of ferroelectric materials should allow for an ultrafast switching of the macroscopic electric polarization and, thus, lead to new electronic devices for extremely high frequencies. [55]

Biophotonics: In situ printing liquid superlenses to image butterfly wings and nanobiostructures

Nanostructures and natural patterns have long fascinated researchers in [bioinspired materials engineering](#). Biological samples can be [imaged and observed at the nanoscale](#) using sophisticated analytical tools in materials science, including scanning electron microscopy (SEM) and transmission electron microscopy (TEM). While imaging methods contribute to the understanding of structures by revealing material properties for biomimetic materials synthesis, they have often done so with the loss of photonic properties inherent to the materials.

In a new method, materials scientists Boliang Jia and colleagues at the departments of mechanical engineering and robotics presented a printable biocompatible [superlens](#) placed directly on objects of interest to observe [subdiffraction-limited](#) features (resolution beyond the diffraction limit). They then viewed the natural features using an [optical microscope](#) to demonstrate nanoscale imaging of [butterfly wings](#) in color. The study allowed super-resolution imaging and a larger field of view (FOV) compared to the previous [dielectric microsphere-based](#) optical systems of super-resolution microscopy.

The new approach created a fast and flexible path to observe the direct colors of biological features at the nanoscale in the visible range. The results are now published in *Microsystems and Nanoengineering*, where the work allowed optical measurements at the subdiffraction-limited scale. A superlens is based on an optical material with a negative index of refraction (optical metamaterials) that could experimentally reverse nearly all known optical phenomena. Technically, a thin negative-index film can function as a 'superlens' to provide image detail with a resolution beyond the diffraction limit to which all positive-index lenses are subjected to.

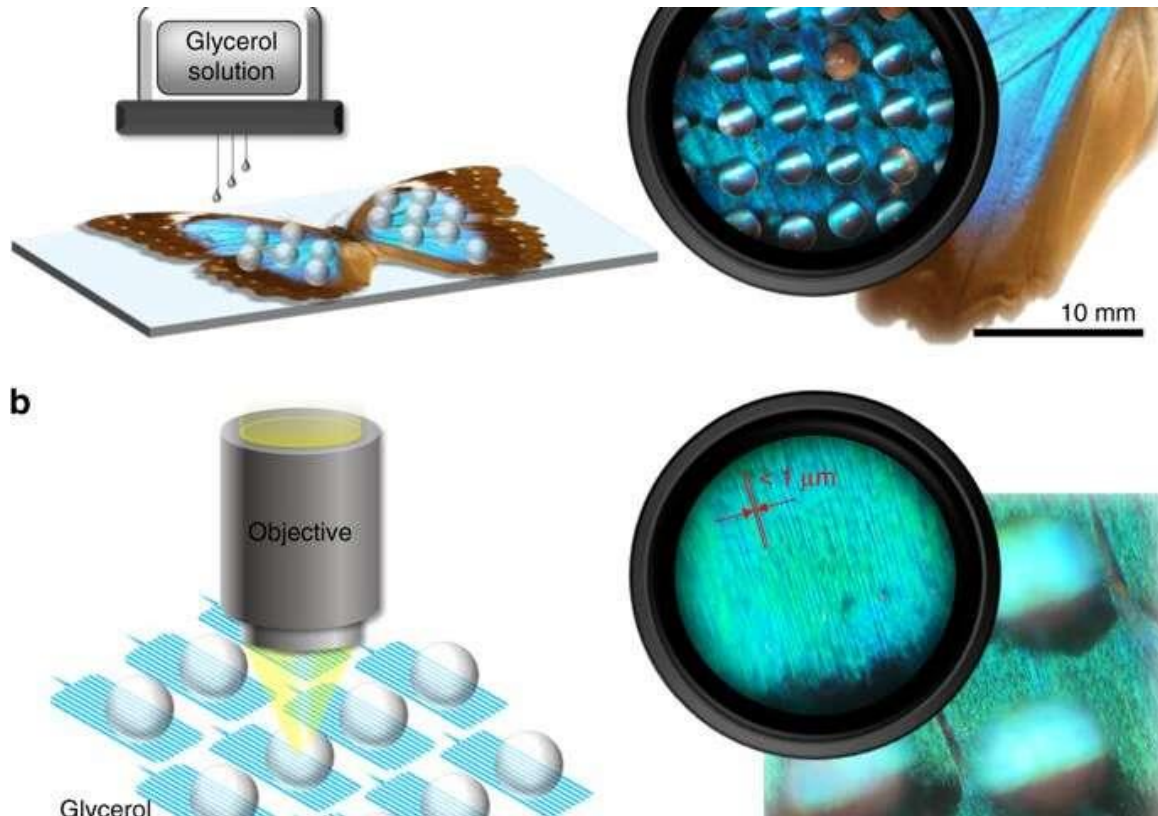

In situ printing glycerol superlenses for nanoscale imaging of butterfly wings. a) Illustration of the printing process and a microscopic view of the formed superlens array on the wing scales. b) Conceptual image of the direct nanoscale [...more](#)

In the study, Jia et al. devised a method to print glycerol (transparent liquid) on to butterfly wings and observe nanoscale wing structures hitherto unobserved via conventional optical microscopes. The work will pave the way for advanced liquid superlenses coupled with fast and flexible methods in optics. The results will assist nanostructural inspection via biophotonics in biological and non-biological samples.

The butterfly wings of *Morpho cypris* were first observed via high-resolution SEM in 1942, which led to the discovery of detailed structures below the diffraction limit using sophisticated tools. Since then, *Morpho* butterflies have been a subject of interest in bioinspired materials research due to their iridescent color and distinct photonic properties. For decades, the properties of light interference resulting from their brilliant nanostructures have attracted great interest

in [nanophotonics](#) and [biomimetic materials](#) research. However, direct optical observations of the subdiffraction-limited structure of the wings at the nanoscale yet remain to be reported.

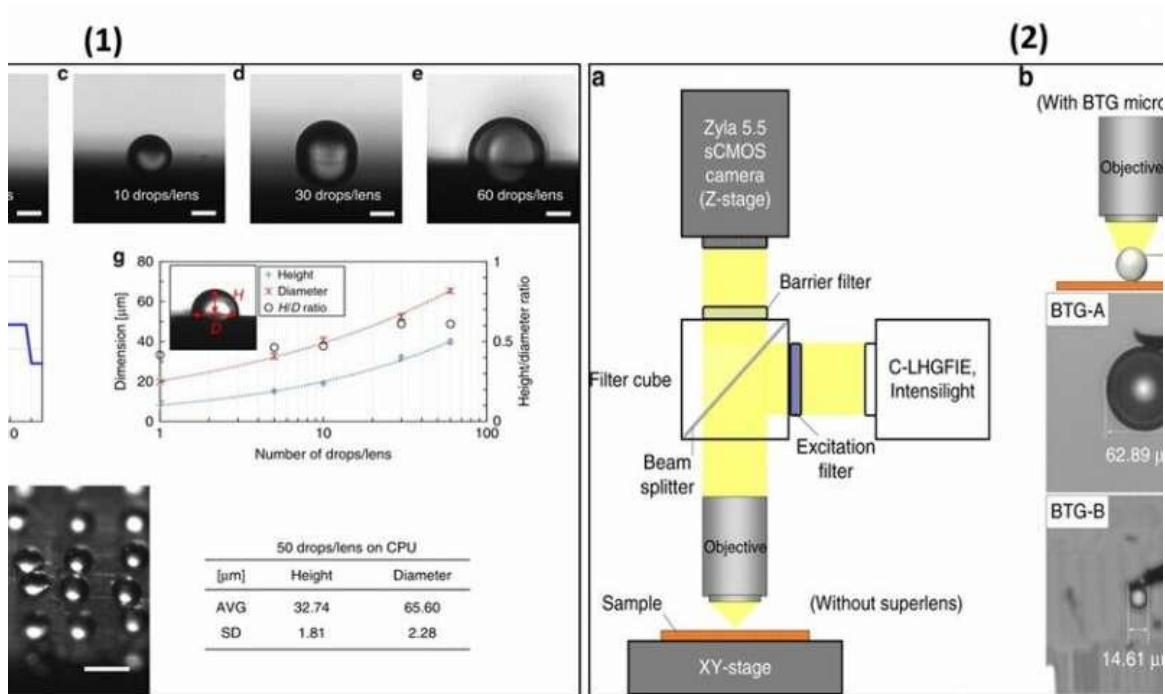

(1) Characterization of printed glycerol superlenses with different numbers of drops/lens. a–e) Lateral images of glycerol lenses with 1, 5, 10, 30, and 60 drops/lens on a clean silicon wafer. f) The jetting waveform used in the experiment. ...[more](#)

High-refractive-index [microspheres in aqueous media](#) have attracted great interest in recent years for observing liquid-immersed biological samples such as biological cells in vivo. Yet, the method is not favorable for samples with high-refractive index in dry conditions. In the present work, Jia et al. presented an in situ printed biocompatible glycerol superlens (SL) with higher resolution and larger FOV than [barium titanate glass \(BTG\) microspheres](#) under dry conditions. The scientists chose [glycerol](#) since it is a transparent liquid with a relatively high refractive index that is capable of printable droplet formation across a wide size range.

As an important feature, glycerol contains strong inter-molecular interactions and is therefore highly resistant to evaporation. Although microdroplets of water typically evaporate almost instantly, by comparison, glycerol printed as droplets with a volume of 50 percent could exist at least for a day on substrates without significant size changes. Jia et al. therefore directly printed glycerol superlenses on a Morpho butterfly wing using an ink-jet printing machine. Thereafter, they characterized the glycerol images using a central processing unit (CPU)-integrated circuit (IC). The scientists observed nanobiostructures ranging from 50 nm to 200 nm in scale. In the work, the scientists adjusted the viscosity of the glycerol solution via dilution tests with MilliQ water to select an optimal concentration of 50 volume percent (50 vol%) for printing.

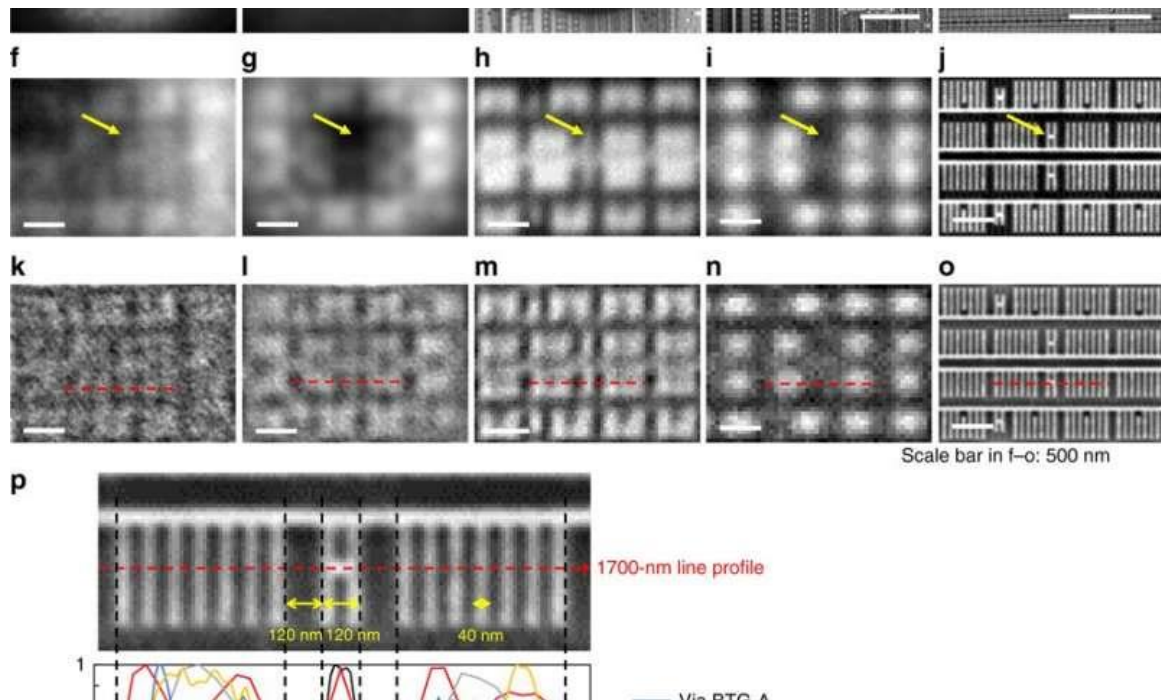

Experimentally acquired images at location-I on the CPU sample. a–d) Optical images taken via BTG-A (a), BTG-B (b), Gly-I (c), and without a superlens (d). The objective used was 100× (NA 0.90). The estimated fields-of-view (FOVs) in a, b, ...[more](#)

In optics, [solid immersion lenses](#) (SILs) can enhance optical resolution by increasing the effective numerical aperture (NA) of the imaging medium. The droplet lens is considered a liquid version of SILs with a [flawless surface](#). The scientists first characterized the printed glycerol superlenses in the study using a different number of drops per lens on a clean silicon wafer before administration on butterfly wings. They selected the ideal number of drops per lens after a few trials; the resulting diameters of the glycerol lenses were comparable to BTG microspheres. Thereafter, they compared configurations of the experimental setup for the BTG microspheres and the glycerol superlens. The work showed that large BTG microspheres provided a large FOV, while a higher resolution was obtained with smaller BTG microspheres.

When the scientists compared the images obtained with glycerol superlenses and those obtained using BTG, the results significantly improved in uniformity for images obtained using glycerol superlenses, alongside sharper nanoscale features. This implied that printed glycerol superlenses offered superior resolution capacity compared to BTG microspheres of equal and smaller sizes in air.

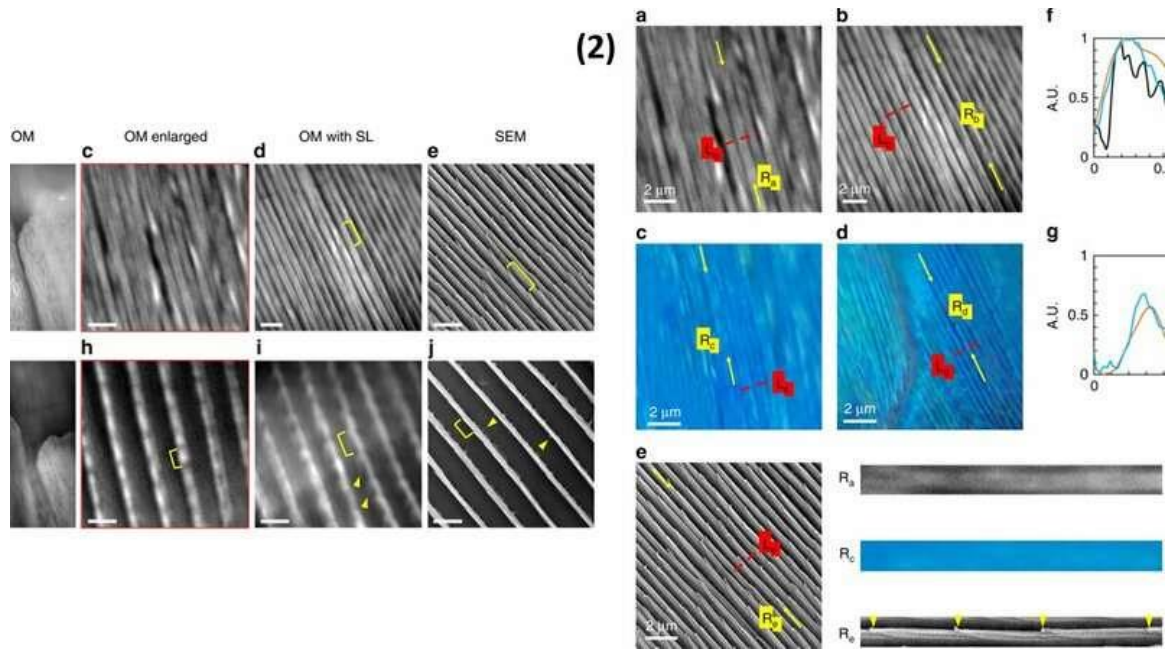

(1) Comparison of images of the *M. m. menelaus* ventral wing scales. Color images a and f were taken from the eyepiece using an iPhone 7 Plus camera. Grayscale images b–d and g–i were taken with an Andor Zyla5.5 sCMOS camera. Images e and j ...[more](#)

In their work, Jia et al. observed two types of butterflies: *Morpho Menelaus* and *Agrias beatifica beata*. The scientists printed 60 glycerol drops (or lenses) on the butterfly samples to obtain spherical lenses approximating 95 μm in diameter. They observed the wing-scale features via an upright microscope system. The scientists were able to capture the ventral wing scales of the butterflies, where the *Morpho* species displayed two types of wing scales; ground and cover scales.

In comparison to SEM, glycerol superlenses were unable to resolve complete structures entirely, but they showed the existence of substructures between the ridges of butterfly wings. For example, Jia et al. showed that in situ [glycerol](#) superlenses could extend the limit for nanoscale structures in biological samples to approximate 200 nm in width. Additional experiments showed the ability to color-image subdiffraction-limited nanobiostructures using the superlenses.

The new method offers a cost-effective, fast and high-resolution imaging technique to visualize subdiffraction-limited nanobiostructures in situ. The work paves the way for [water-immiscible liquids with high refractive indices](#) to print liquid superlenses for water-immersion-based imaging applications. Biocompatible liquids such as silicone oil can be explored as superlenses underwater via low cost ink-jet printing next. Materials scientists continue to work toward engineering advanced liquid superlenses in nanobiophotonics. The scheme introduced by Jia et al. provides a fast and easy-to-implement strategy to observe nanobiostructures in biological and nonbiological samples. [54]

Scientists realize a three-dimensional 'topological' medium for electromagnetic waves

Topological insulators are exotic states of matter that physicists have been intensely studying for the past decade. Their most intriguing feature is that they can be rigorously distinguished from all other materials using a mathematical concept known as "topology." This mathematical property grants topological insulators the ability to transport electric signals without dissipation, via special quantum states called "topological surface states."

However, topological insulators need not only be realized with electrons. Physicists have also devised photonic topological insulators, synthetic materials that impart light waves with distinct topological features, allowing light (rather than electric currents) to flow via topological surface states. Unlike electronic topological insulators, photonic topological insulators can operate easily at room temperature, among other advantages. As a result, photonic topological insulators could have applications in future optical devices, such as high-power lasers and optical diodes.

A team of researchers from Nanyang Technological University (NTU), Singapore, and Zhejiang University, China, has announced the development of the world's first three-dimensional (3-D) photonic topological insulator. In a paper to be published in an upcoming issue of *Nature*, the team reports that a specially-designed 3-D array of resonators can act as a topological insulator for microwaves. They have observed unambiguous evidence for the signature topological surface states, in the form of microwaves that flow effortlessly along 2-D sheets embedded within the 3-D volume of their sample.

"Previous researchers were able to make two-dimensional photonic topological insulators. But in spite of many theoretical proposals over the years, nobody had been able to realize a 3-D version," says Associate Professor Baile Zhang of NTU, who co-supervised the project. He notes that 3-D topological insulators have important capabilities, including the ability to channel topological surface states along all possible spatial directions. In one of their experiments, the researchers showed that microwaves can be guided efficiently along a 2-D surface containing zigzag-like folds.

The team constructed the 3-D photonic topological insulator out of a stack of thin plastic sheets embedded with metal antennas acting as tiny electromagnetic resonators. The key breakthrough was made when they realized how to tailor the resonators to interact with electromagnetic waves in a very specific way, granting the waves the desired topological characteristics.

"Since the sheets are made using well-established technology for printing circuit boards, this design is cheap and simple to implement," explains Professor Hongsheng Chen of Zhejiang University, another co-supervisor of the project. "By comparison, other proposals previously published in the scientific literature involved using non-standard ceramic or magnetic materials, which are very difficult to work with if you want to make a real device."

Dr. Yihao Yang, a postdoctoral researcher at NTU who was the lead author on the paper, said that the team was able to build a compelling scientific case by constructing detailed maps of how electromagnetic waves travel within the photonic topological insulator. "By carefully inserting an electromagnetic field probe into the sample, we measured the field distributions throughout the

sample. This allowed us to reconstruct the 'dispersion relations' that serve as the physical signatures of topological insulators," he said.

Associate Professor Yidong Chong, another member of the NTU team, observed that this work is the first realization of a synthetic 3-D topological insulator not based on the flow of electric current. "This is an example of the universality of physics," he said. "A phenomenon arising in one setting, like quantum materials, can be reproduced in another setting, in this case an artificial medium for electromagnetic waves. The key ingredient is that they obey the same equations and theoretical concepts." He suggests that the 3-D photonic topological insulator may provide an interesting setting for studying fundamental physics, as the topological surface states are governed by the same equations as massless 2-D electrons obeying Einstein's theory of relativity.

The current 3-D photonic topological [insulator](#) is limited to electromagnetic waves, at relatively low frequencies. "If we can scale it to optical frequencies, that is to say waves of visible light, there could be applications for creating optical computer chips, lasers, and all sorts of interesting optical devices," says NTU's Professor Zhang. [53]

Reimagining information processing

Because technology is a part of our everyday lives, it may be difficult to imagine what the future of technology will look like, let alone what it has the potential of accomplishing.

West Virginia University physicists Cheng Cen, Lian Li, Yanjun Ma, Ming Yang and Chenhui Yan are looking beyond the limits of classical computing used in our everyday devices and are working toward making quantum device applications widely accessible.

In a study published in *Nature Communications*, the researchers proved that superconductivity, which has a wide range of technological applications including being an integral component of [quantum computing](#), can be manipulated by a weak, continuous ultraviolet light. This discovery has broad fundamental and applicational impacts, such as those in the development of quantum computation.

"This is why this is particularly significant," said Cen, an associate professor in the Department of Physics and Astronomy. "We can control the superconducting state by using just a flashlight, instead of using a high energy laser or extreme conditions of pressure and temperature."

The technology we are accustomed to today operates by storing information as binary zero and one and are limited to solving only one problem at a time. However, quantum computers perform differently to manipulate and store information by using a quantum bit, which has the ability to solve complex problems.

"The whole current fleet of devices was built by using a classic bit," Cen said. "Now the question is, 'How do we move forward?'"

According to Cen, a regular transistor can almost be as small as a [single molecule](#) and is used in [modern technology](#) to process information, but it cannot support a [quantum](#) bit. However, the superconducting material can.

Quantum computers have the potential to provide breakthroughs in materials and drug discovery, the optimization of complex systems and artificial intelligence.

"In the future, if we can understand these phenomena, we can very possibly use this light modulated superconductor commercially for devices," Cen said.

By using a single atomic layer film of iron selenide grown by Chenhui Yan, a postdoctoral associate of Li, the Robert L. Carrol Professor of Physics, the researchers could also switch its properties from a normal state to a superconducting state very quickly and reversibly by applying a voltage pulse. "Most remarkably, this effect is also nonvolatile, meaning that the light-induced superconducting state remains even after the UV light is turned off," Li said.

This research was funded by the National Science Foundation and the Department of Energy.

"Drs. Cen, Li and Ma are an integral part of the Department of Physics and Astronomy's development of a world-class condensed matter physics research program here at WVU," said Earl Scime, chair of the Department of Physics and Astronomy. "This research highlights the cutting-edge research being done at WVU, and we are very excited to see their work appear in the very high-profile journal *Nature Communications*." [52]

Hybrid qubits solve key hurdle to quantum computing

Spin-based quantum computers have the potential to tackle difficult mathematical problems that cannot be solved using ordinary computers, but many problems remain in making these machines scalable. Now, an international group of researchers led by the RIKEN Center for Emergent Matter Science have crafted a new architecture for quantum computing. By constructing a hybrid device made from two different types of qubit—the fundamental computing element of quantum computers—they have created a device that can be quickly initialized and read out, and that simultaneously maintains high control fidelity.

In an era where conventional computers appear to be reaching a limit, quantum computers—which do calculations using quantum phenomena—have been touted as potential replacements, and they can tackle problems in a very different and potentially much more rapid way. However, it has proven difficult to scale them up to the size required for performing real-world calculations.

In 1998, Daniel Loss, one of the authors of the current study, came up with a proposal, along with David DiVincenzo of IBM, to build a quantum computer by using the spins of electrons embedded in a quantum dot—a small particle that behaves like an atom, but that can be manipulated, so that they are sometimes called "artificial atoms." In the time since then, Loss and his team have endeavored to build practical devices.

There are a number of barriers to developing practical devices in terms of speed. First, the device must be able to be initialized quickly. Initialization is the process of putting a qubit into a certain state, and if that cannot be done rapidly it slows down the device. Second, it must maintain coherence for a time long enough to make a measurement. Coherence refers to the entanglement between two quantum states, and ultimately this is used to make the measurement, so if qubits

become decoherent due to environmental noise, for example, the device becomes worthless. And finally, the ultimate state of the qubit must be able to be quickly read out.

While a number of methods have been proposed for building a quantum [computer](#), the one proposed by Loss and DiVincenzo remains one of the most practically feasible, as it is based on semiconductors, for which a large industry already exists.

For the current study, published in *Nature Communications*, the team combined two types of qubits on a single device. The first, a type of single-spin qubit called a Loss-DiVincenzo qubit, has very high control fidelity—meaning that it is in a clear state, making it ideal for calculations, and has a long decoherence time, so that it will stay in a given state for a relatively long time before losing its signal to the environment.

Unfortunately, the downside to these qubits is that they cannot be quickly initialized into a state or read out. The second type, called a singlet-triplet qubit, is quickly initialized and read out, but it quickly becomes decoherent. For the study, the scientists combined the two types with a type of quantum gate known as a controlled phase gate, which allowed spin states to be entangled between the qubits in a time fast enough to maintain the coherence, allowing the state of the single-spin qubit to be read out by the fast singlet-triplet [qubit](#) measurement.

According to Akito Noiri of CEMS, the lead author of the study, "With this study we have demonstrated that different types of quantum dots can be combined on a single [device](#) to overcome their respective limitations. This offers important insights that can contribute to the scalability of quantum computers." [51]

Amoeba finds approximate solutions to NP-hard problem in linear time

Researchers have demonstrated that an amoeba—a single-celled organism consisting mostly of gelatinous protoplasm—has unique computing abilities that may one day offer a competitive alternative to the methods used by conventional computers.

The researchers, led by Masashi Aono at Keio University, assigned an amoeba to solve the Traveling Salesman Problem (TSP). The TSP is an [optimization problem](#) in which the goal is to find the shortest route between several cities, so that each city is visited exactly once, and the start and end points are the same.

The problem is NP-hard, meaning that as the number of cities increases, the time needed for a computer to solve it grows exponentially. The complexity is due to the large number of possible solutions. For example, for four cities, there are only three possible routes. But for eight cities, the number of possible routes increases to 2520.

In the new study, the researchers found that an amoeba can find reasonable (nearly optimal) solutions to the TSP in an amount of time that grows only linearly as the number of cities increases from four to eight. Although conventional computers can also find approximate solutions in linear time, the amoeba's approach is completely different than traditional algorithms. As the scientists explain, the amoeba explores the solution space by continuously redistributing the gel in its

amorphous body at a constant rate, as well as by processing optical feedback in parallel instead of serially.

Although a conventional computer can still solve the TSP much faster than an amoeba, especially for small problem sizes, the new results are intriguing and may lead to the development of novel analogue computers that derive approximate solutions of computationally complex problems of much larger sizes in linear time.

How it works

The particular type of amoeba that the scientists used was a plasmodium or "true slime mold," which weighs about 12 mg and consumes oat flakes. This amoeba continually deforms its amorphous body by repeatedly supplying and withdrawing gel at a velocity of about 1 mm/second to create pseudopod-like appendages.

In their experiments, the researchers placed the amoeba in the center of a stellate chip, which is a round plate with 64 [narrow channels](#) projecting outwards, and then placed the chip on top of an agar plate. The amoeba is confined within the chip, but can still move into the 64 channels.

In order to maximize its nutrient absorption, the amoeba tries to expand inside the chip to come in contact with as much agar as possible. However, the amoeba does not like light. Since each channel can be selectively illuminated by light, it's possible to force the amoeba to retreat from the illuminated channels.

In order to model the TSP, each channel in the stellate chip represents an ordered city in the salesman's route. For example, in the case with four cities labeled A-D, if the amoeba occupies channels A4, B2, C1, and D3, then the corresponding solution to the TSP is C, B, D, A, C.

In order to guide the amoeba toward an optimal or nearly optimal solution, the key lies in controlling the light. To do this, the researchers use a [neural network model](#) in which every six seconds the system updates which channels are illuminated. The model incorporates information about the distance between each pair of cities, as well as feedback from the amoeba's current position in the channels.

The model ensures that the amoeba finds a valid solution to the TSP in a few ways. For example, once the amoeba has occupied a certain fraction of a particular channel, say A3, then channels A1, A2, and all other "A" channels are illuminated in order to prohibit city A from being visited twice. Also, B3, C3, D3, and all other "3" channels are illuminated to prohibit simultaneous visits to multiple cities.

The model accounts for the distances between cities by making it easier to illuminate channels that represent cities with longer distances than with shorter distances. For instance, say the amoeba occupies channel B2, and has begun to encroach into channels C3 and D3 in equal amounts, and the distance between cities B and C is 100 while the distance between cities B and D is 50. The longer distance between B and C eventually causes the system to illuminate channel C3, causing the amoeba to retreat from that [channel](#) but allowing it to continue moving into D3.

Overall, modeling the TSP with an amoeba harnesses the amoeba's natural tendency to seek out a stable equilibrium. As channels representing shorter routes are less likely to be illuminated, the

amoeba may spread out in those channels and continue to explore other non-illuminated channels in order to maximize its surface area on the agar plate.

The researchers also developed a computer simulation called AmoebaTSP that mimics some of the main features of how the amoeba addresses the problem, including the continuous movement of gel as it is supplied at a constant rate and withdrawn from various channels.

"In our stellate chip for solving the n -city TSP, the total area of the body of the amoeba becomes n when the amoeba finally finds an approximate solution," Aono told *Phys.org*. "There seems to be a 'law' that the amoeba supplies its gelatinous resource to expand in the non-illuminated channels at a constant rate, say, x . This law would be kept even when some resources bounce back from illuminated channels. Then the time required to expand the body area n to represent the solution becomes n/x . This mechanism would be the origin of the linear time, and it was reproduced by our computer simulation model.

"But still, the mechanism by which how the amoeba maintains the quality of the approximate solution, that is, the short route length, remains a mystery. It seems that spatially and temporally correlated movements of the branched parts of the amoeba located at distant channels are the key. Each of these branches is oscillating its volume with some temporal 'memory' on illuminated experiences. Groups of the branches perform synchronization and desynchronization for sharing information even though they are spatially distant."

In the future, the researchers plan to further improve the amoeba's computing abilities.

"We will investigate further how these complex spatiotemporal oscillatory dynamics enhance the computational performance in finding higher-quality solutions in shorter time," said coauthor Song-Ju Kim at Keio University. "If it could be clarified, the knowledge will contribute to create novel analogue computers that exploit the spatiotemporal dynamics of electric current in its circuit.

"Of course, running some other algorithms on traditional digital computers for linear time, we can derive approximate solutions to TSP. On the other hand, when running our simulation models (AmoebaTSP or its developed versions) on the traditional computers as we did in this study, the analogue and parallel spatiotemporal dynamics require nonlinear time for simulating them as digital and serial processes. So we are trying to obtain much higher-quality solutions than those derived from the traditional ones by running our models on the analogue computers for linear time or shorter."

The researchers also expect that, by fabricating a larger chip, the amoeba will be able to solve TSP problems with hundreds of cities, although this would require tens of thousands of channels. [50]

Twisting light to enable high-capacity data transmission

For the first time, researchers have used tiny gears made of germanium to generate a vortex of twisted light that turns around its axis of travel much like a corkscrew. Because germanium is compatible with the silicon used to make computer chips, the new light source could be used to boost the amount of data that can be transmitted with chip-based optical computing and communication.

The researchers, from the University of Southampton in the U.K., and University of Tokyo, Toyohashi University of Technology and Hitachi Ltd., all in Japan, describe the new [light](#)-emitting gears in The Optical Society (OSA) journal *Optics Express*. With a radius of one micron or less, 250,000 of the gears could be packed into just one square millimeter of a computer chip.

There is a great deal of interest in generating light that is twisted, or has orbital angular momentum, because of its advantages for communications and computing. Today, light is used to carry information by varying the number of photons emitted or switching between light's two polarization states. With twisted light, each twist can represent a different value or letter, allowing the encoding of a great deal more information using less light.

"Our new microgears hold the potential for a laser that can be integrated on a [silicon substrate](#)—the last component needed to create an integrated optical circuit on a computer," said the paper's first author Abdelrahman Al-Attili, from the University of Southampton. "These tiny optical-based circuits use twisted light to transmit large amounts of data."

Using strain to improve light emission

It has been impossible to make a usable miniaturized light source on [silicon](#), the material commonly used to make [computer chips](#) and associated components, because the material's properties led to poor light-generating efficiency. Although germanium has similar limitations, applying strain by stretching it can improve its light emission efficiency.

"Previously, the strain that could be applied to germanium was not large enough to efficiently create light without degrading the material," said Al-Attili. "Our new microgear design helps overcome this challenge."

The new design features microgears that are freestanding at the edges so that they can be stretched by an oxide film deposited over the structures. This allows tensile strain to be applied without breaking the germanium's crystal structure. The gears stand on a silicon pedestal that connects it to the top of the silicon substrate and allows heat to dissipate during operation.

To demonstrate their new design, the researchers used [electron beam lithography](#) to fabricate the very fine physical features that form the gears' teeth. They then illuminated the gears with a standard green laser that did not emit twisted light. After the microgear absorbed the green light it generates its own photons that are circulated around the edges forming twisted light that is reflected vertically out of the gear by the periodic teeth.

Precision optical simulations

The researchers tested and tweaked their design using computer simulations that model the way light propagates in the gears over nanoseconds or even shorter time periods. By comparing the prototype's light emission with computer simulation results, they were able to confirm that the gears generated twisted light.

"We can precisely design our device to control the number of rotations per propagation wavelength and the wavelength of the emitted light," said Al-Attili.

The researchers are now working to further improve the efficiency of light emission from the germanium microgears. If successful, this technology would make it possible to integrate thousands of lasers onto a silicon chip for transmitting information.

"Silicon fabrication technologies that were developed to make electronic devices can now be applied to make various optical devices," said Al-Attili. "Our microgears are just one example of how these capabilities can be used to make nano- and microscale devices." [49]

Electronically programmable photonic molecule

Physical systems with discrete energy levels are ubiquitous in nature and form fundamental building blocks of quantum technology. Artificial [atom-like and molecule-like](#) systems were [previously demonstrated](#) to regulate light for coherent and dynamic control of the frequency, amplitude and the phase of photons. In a recent study, Mian Zhang and colleagues engineered a photonic molecule with two distinct energy levels, using coupled lithium niobate micro-ring resonators that could be controlled via external microwave excitation. The frequency and phase of light could be precisely operated by programmed microwave signals using canonical two-level systems to include [Autler-Townes splitting](#), [Stark shift](#), Rabi oscillation and [Ramsey interference](#) phenomena in the study. Through such coherent control, the scientists showed on-demand optical storage and retrieval by reconfiguring the photonic molecule into a [bright-dark mode pair](#). The dynamic control of light in a programmable and scalable electro-optic system will open doors for applications in [microwave-signal processing](#), quantum [photonic gates](#) in the frequency domain and to explore concepts in [optical computing](#) as well as in [topological physics](#).

The results are now published on *Nature Photonics*, where Zhang et al. overcame the existing performance trade-off, to realize a programmable photonic two-level [system](#) that can be controlled dynamically via gigahertz [microwave signals](#). To accomplish this, the scientists created a microwave addressable photonic molecule using a pair of integrated lithium niobate micro-ring resonators patterned close to each other (radius 80 μm). The combined effects of low optical loss, efficient co-integration of optical waveguides and microwave electrodes allowed the simultaneous realization of a large electrical bandwidth (> 30 GHz), strong modulation efficiency and long photon lifetime (~ 2 ns).

A photonic analogue of a two-level system can typically facilitate the investigation of [complex physical phenomena](#) in materials, electronics and optics. Such systems convey important functions, including unique on-demand photon storage and retrieval, coherent [optical frequency shift](#) and optical [quantum information](#) processing at room temperature. For dynamic [control](#) of photonic two-level systems, [electro-optic methods](#) are ideally suited due to their fast response, programmability and possibility for large-scale integration.

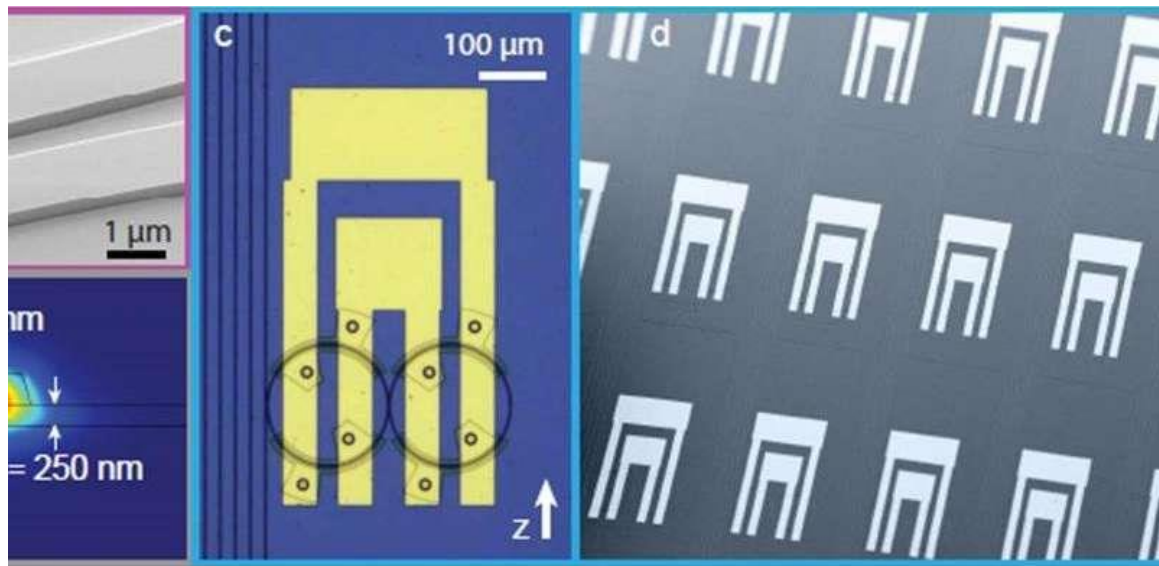

Device and experimental setup detail. a) Scanning electron microscope (SEM) image of the gap between the coupled microring resonators. b) Cross-section of the optical mode profile in the ring resonator. c) Microring image of the full device ...[more](#)

For electro-optic control of a two-level system, the photon lifetime of each energy state must be longer than the time required for the system to be driven from one state to the other. Conventional [integrated photonic platforms](#) have not met the requirements of a simultaneously long photon life-time and fast modulation so far. [Electrically active photonic platforms](#) (based on silicon, graphene and other polymers), allow fast electro-optic modulation at gigahertz frequencies but suffer from shorter photon lifetimes. However, pure electrical tuning is still highly desirable, as narrowband microwave signals offer much better control with minimal noise and scalability.

In their work, Zhang et al. showed that optical transmission of the photonic molecule measured using a telecom-wavelength laser, supported a pair of well-defined optical energy levels. The evanescent coupling of light from one resonator to another was enabled through a 500 nm gap between the micro-ring resonators to form the two well-resolved optical energy levels. The scientists explored the analogy between an atomic and photonic two-level system to demonstrate control of the photonic molecule.

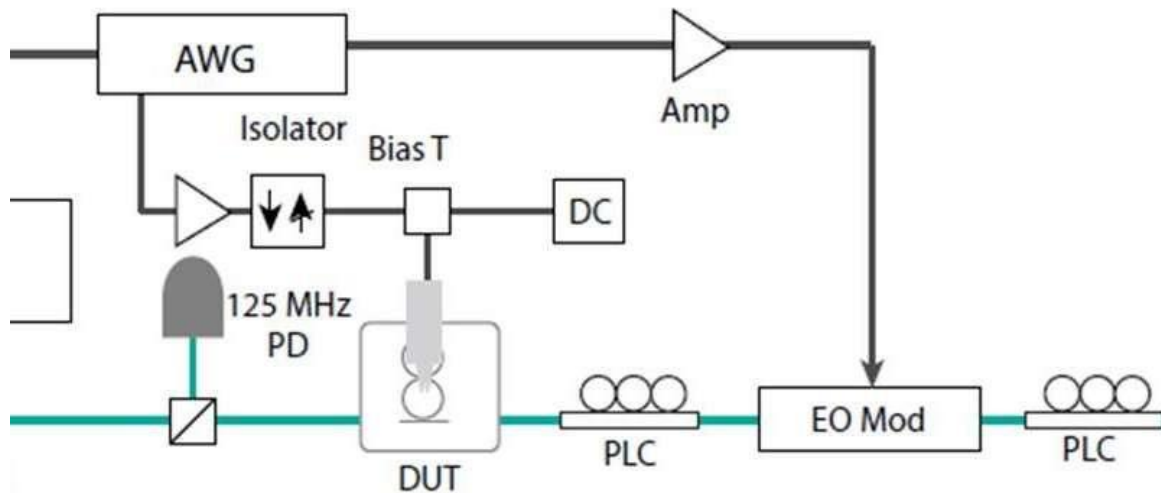

Extended experimental setup. The device is optically pumped by a tunable telecom laser centered around 1630 nm. The light is sent through an external electro-optic modulator and polarization controllers (PLC) before coupling into the chip ...[more](#)

In the experiments, light from the tunable telecom wavelength laser was launched into the lithium niobate waveguides and collected from them via a pair of lensed optical fibres. The scientists used an arbitrary waveform generator to operate microwave control signals before sending them to electrical amplifiers. The efficient overlap between microwaves and optical fields observed in the system enabled higher tuning/modulation efficiency than those [previously observed](#) with bulk electro-optic systems. Such coherent microwave-to-optical conversion can link electronic quantum processes and memories via low-loss optical telecommunication, for applications in future quantum information networks.

Zhang et al. next used a continuous-wave coherent microwave field to control a photonic two-level system. In this system, the number of photons that could populate each of the two levels was not limited to one. The splitting frequency of the system was precisely controlled up to several gigahertz by controlling the amplitude of the microwave signals. The effect was used to control the effective coupling strength between the energy levels of the photonic molecule. Coherent spectral dynamics in the photonic molecule were investigated for a variety of microwave strengths applied to the photonic two-level system. The scientists also described the controlled amplitude and phase of the system using Rabi oscillation and Ramsey interference, while using Bloch spheres/geometric representations of the photonic two-level energy system to represent the phenomena.

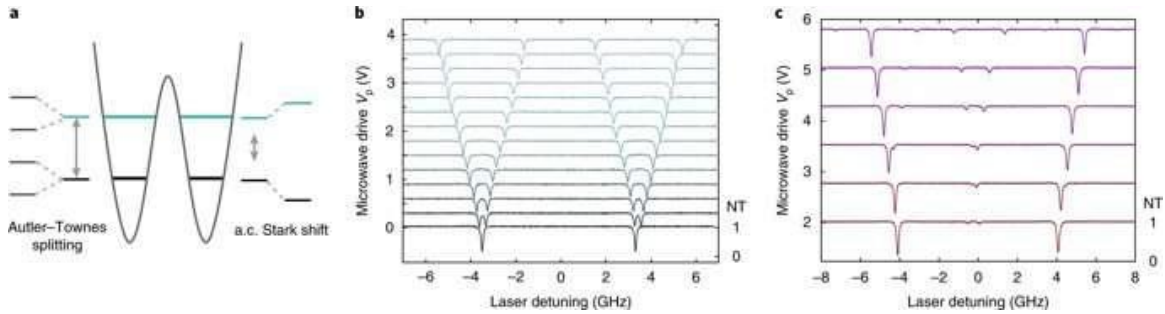

Microwave dressed photonic waveguides. a) When the applied microwave frequency is tuned to match the mode separation, dissipative coupling leads the two photonic levels to split into four levels. This effect is analogous to Autler–Townes ...[more](#)

The work allowed controlled writing and reading of light into a resonator, from an external waveguide to achieve on-demand photon storage and retrieval, a critical task for optical signal processing. To facilitate this experimentally, Zhang et al. applied a large DC bias voltage (15 V) to reconfigure the double-ring system into a pair of bright and dark modes. In the setup, the mode localized in the first ring provided access to the optical waveguides and became optically bright (bright mode). The other mode was localized in the second ring that was geometrically decoupled from the input optical waveguide to become optically dark. Accordingly, the scientists demonstrated coherent and dynamic control of a two-level photonic molecule with [microwave](#) fields and on-demand photon storage/retrieval through meticulous experiments in the study. The work opens a path to a new form of control on photons. The results are an initial step with potentially immediate applications in signal processing and quantum [photonics](#).

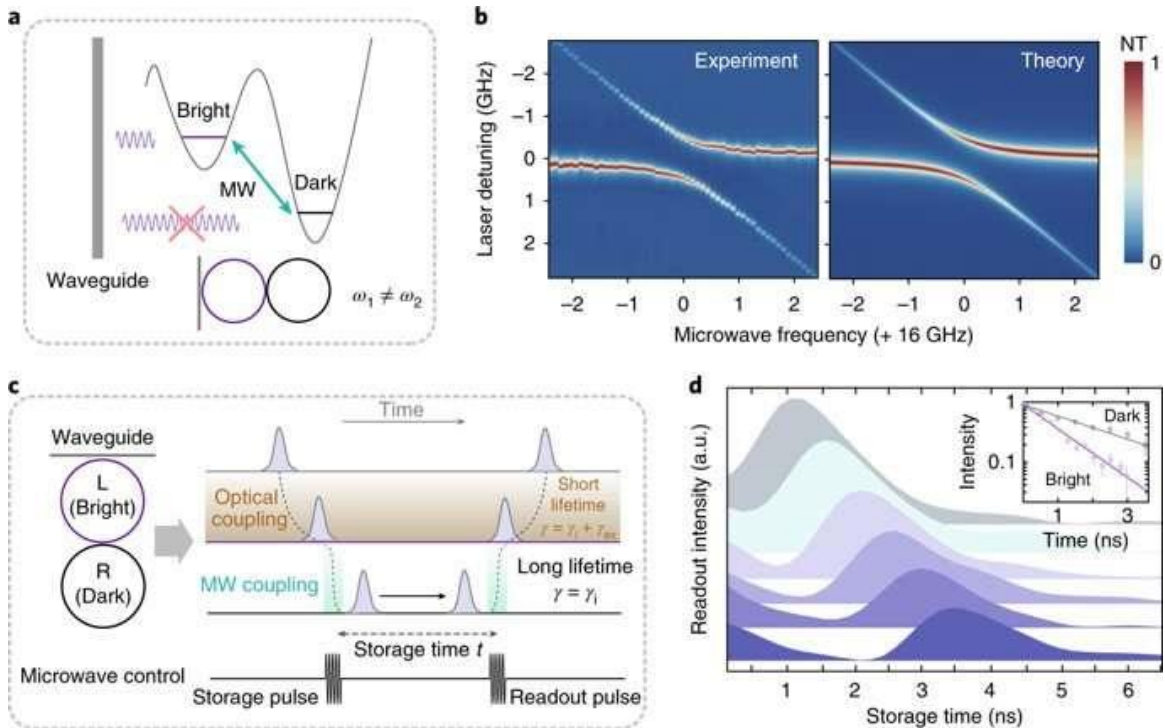

On-demand storage and retrieval of light using a photonic dark mode. a) The photonic molecule is programmed to result in localized bright and dark modes. As a result, the bright mode can be accessed from the optical waveguide, while the ...[more](#)

The design parameters of the coupled resonators provide space to investigate the dynamic control of two-level and multi-level photonic systems, leading to a new class of photonic technologies. The scientists envision that these findings will lead to advances in topological photonics, advanced [photonic](#) computation concepts and on-chip frequency-based optical quantum systems in the near future. [48]

Scientists use magnetic defects to achieve electromagnetic wave breakthrough

Surfers spend much of their time watching long waves come onto the shoreline as they attempt to catch one right as it begins to curve and break.

In a similar vein, scientists are working to create twisting helical electromagnetic waves whose curvature allows more accurate imaging of the magnetic properties of different materials at the atomic level and could possibly lead to the development of future devices.

When scientists use electron beams to look at samples of materials, they have the ability to modify many different aspects of the electromagnetic waves that make up the beam. They can make the amplitude of the waves bigger or smaller, or make the waves faster or slower. However, until now there has been no easy way to transform a plane wave—like the long rolling waves out at sea—into a helical wave, like the ones that crash on shore.

In a new study from the U.S. Department of Energy's (DOE) Argonne National Laboratory, scientists have created small regions of magnetic defects made from nanoscale magnetic islands assembled into a grid. The plane waves interact with these defects, thereby generating helical waves.

"We're looking for waves with a kind of perfect curl, and in order to generate the curl we need to give them something to crash into, which in our case are [magnetic monopoles](#)," said Argonne materials scientist Charudatta (C.D.) Phatak.

The reason scientists are so interested in helical waves is that they have a property called [orbital angular momentum](#). Knowing the orbital angular momentum of an electron beam allows scientists to investigate the magnetic behavior of materials at an atomic level by determining an atomic property called the magnetic moment.

"If we can see the magnetic moments of the material, we can build a description of the total magnetic properties of the material, and how the material will manifest its electronic and magnetic properties," Phatak said.

In this way, the refigured [electron beam](#) could be useful for studying materials in which spin and magnetization play a crucial role, potentially paving the way towards new forms of electronic devices.

Having access to the information encoded by orbital angular momentum will also allow scientists to better understand the nuances of chiral [materials](#), which have a kind of left- or right-handedness that determines their properties.

The grid of defects can be inserted into any [transmission electron microscope](#) to provide a direct way of imaging the sample. "People usually don't think about modifying the beam profile itself in this way," Phatak said.

In the next phase of the experiment, Phatak explained that the researchers may seek to replace the grids of magnetic islands with solenoids, or coils of wire that can act as electromagnets. Using solenoids would allow the creation of more precisely tuned magnetic defects. "Right now, because of the arrangement of the magnetic grid, we can only create defects with a cumulative magnetization of two or four, but solenoids would allow us to have a much broader range of magnetization states," Phatak said.

A paper based on the study, "Direct evidence of topological defects in electron waves due to nanoscale localized magnetic charge," appeared in the October 22 online issue of *Nano Letters*. [47]

Self-healing electroluminescent (EL) devices

In a recent study, materials scientists Guojin Liang and his coworkers at the Department of Materials Science and Engineering, City University of Hong Kong, have developed a self-healing, electroluminescent (EL) device that can repair or heal itself after damage. Inspired by the self-healing capacity of biological systems, the novel process paves the way for a range of new electronic applications. While EL devices are typically used in digital displays, backlights for control panels and wearable electronics, they are prone to damage. The fragility can restrict device working life, sustainability and reliability for long-term electronic applications.

The first self-healing EL [device](#) developed in the study was constructed by using a modified self-annealing polyacrylic acid hydrogel for electrodes, coupled to self-healing polyurethane as a phosphor host for electric insulation. The scientists demonstrated that the physiochemical properties of device restoration could be maintained even after experiencing catastrophic damage. Such EL systems will have new and exciting next-generation applications as healing [hydrogels](#) and dielectric polymers in wearable devices. The work is now published on *Light: Science & Applications*.

The luminescent performance of self-healing EL devices were recovered with high healing efficacy in the study. The concept could be transferred to inter-device healing to realize a conceptual LEGO-like assembly process in light-emitting devices. Through the design and engineering process of self-healing EL devices, the scientists aimed to revive their performance while expanding their lifetime, even after the material was cut in half. Liang et al. expect such self-healing EL devices developed using ionically conductive healing hydrogels and dielectric polymers to serve as a model system for [electroluminescent](#) applications.

Electroluminescent (EL) devices have applications in versatile systems and disciplines including soft robotics, as [artificial skin actuators](#); in [flexible electronics](#), [wearable electronics](#), digital [displays](#) and as [sensors](#). Advances in materials science have led to exquisitely designed and

developed multi-functional EL devices using transparent, conductive materials that integrate biologically inspired soft robotics and optimized device configurations. Examples include:

Stretchable robots with [cephalopod-inspired camouflage](#).

Silver nanowires for [transparent electrodes](#) in self-deformable EL actuators.

Extremely stretchable EL devices engineered with [ionically conductive hydrogels](#), and wearable fabrics and sensors for optical communication.

Although mechanical engineering processes have developed robust devices with robust materials, for device configurations that minimize strain, if strain exceeds the withstanding limit, degradation of device performance cannot be avoided. The maintenance and replacement of such faulty components in integrated, multi-functional electronic systems is either intractable or costly, and remains a primary concern. Developing an effective strategy can significantly extend the lifetime of EL devices.

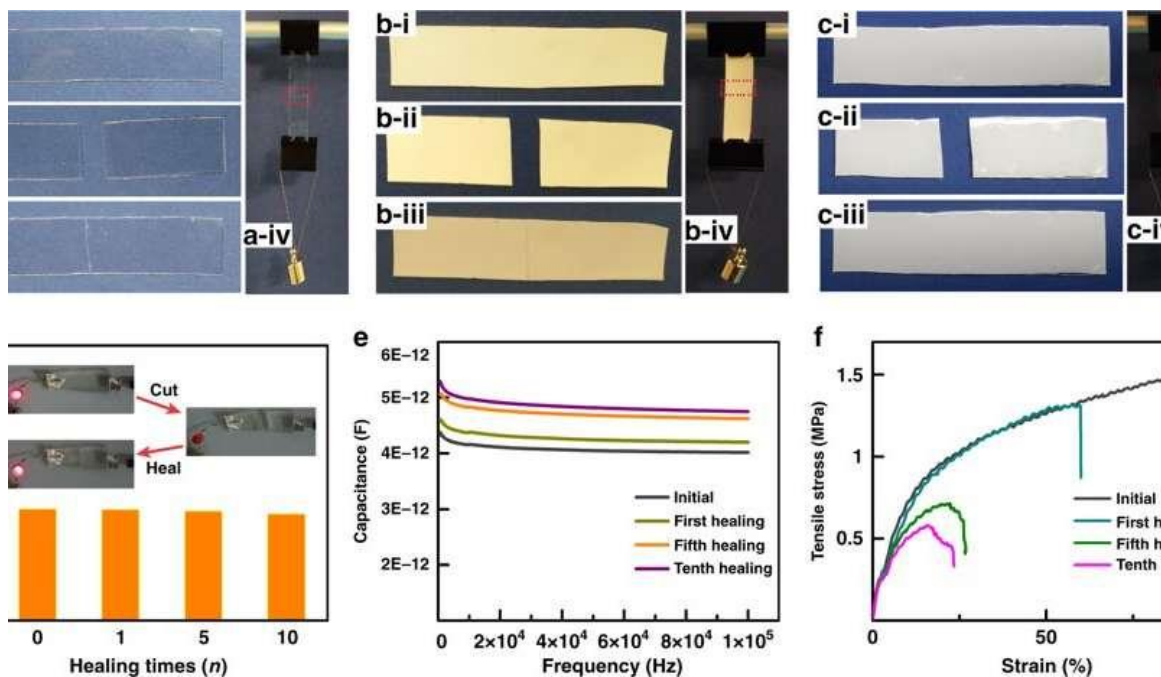

Characterizing the EL device. a–c) Images of the self-healing processes of the EL component layers and the device (PAA layer—**a**, PU composite layer—**b**, and EL device—**c**). In these processes, i) shows the initial states, ii) shows the cut ...[more](#)

In the study, self-healing materials were designed and developed with intrinsic or extrinsic healing features, similar to previous experiments. The present features allow [autonomous damage repair](#), even under external stimuli such as pH, light, [electric](#) or [magnetic](#) fields after extensive damage. Healing properties exist at the level of the material, but improvements to enhance device lifetime and reliability are [ongoing](#). A majority of previous self-healing performances were also only applicable at the level of a [single constituent layer](#) in a multilayered EL device, where the remaining layers were manually repaired via small patches.

To address existing limitations, Liang et al. adopted modified self-healing polyacrylic acid (PAA) hydrogels containing sodium chloride (NaCl) as an ionic electrode. Then they included self-healing polyurethane (PU)-containing zinc sulfide (ZnS) particles as a phosphor composite layer to demonstrate the first innately optimized self-healing EL device in the study. Alongside fracture damage healing, inter-device healing was also restored for the first time to allow LEGO-like assembly at the level of the EL device. The study simplified complex and costly processes of repair and replacement in integrated electronic systems.

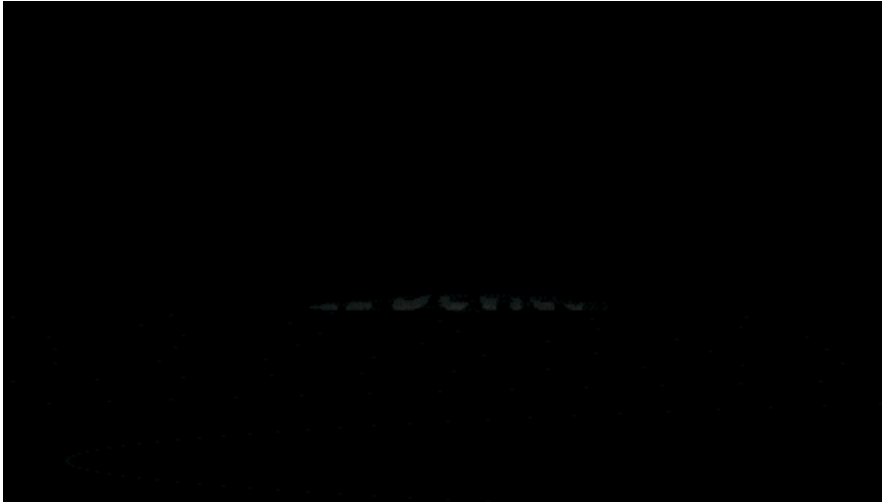

Self-healing EL device. The scientists demonstrate the self-healing EL device through the initial working state and after the cut, healing and revived working state. Credit: Light: Science & Applications, doi: <https://doi.org/10.1038/s41377-018-0096-8>.

The polymer-based hydrogels (PAA layer and PU composite layer) were developed at the molecular level to obtain the desired physicochemical character. A [hydrogel](#) was engineered to simultaneously realize the desired traits of visible-light transparency, ionic conductivity and self-healing. The PAA hydrogel contained uniformly distributed NaCl (4M) to achieve 96.5 percent average transmittance for transparency in the range of visible light and a high ionic conductivity of 2.1 S/m. The carboxyl groups on the PAA backbone transferred self-healing capability to the hydrogel via hydrogen bonding.

The electrically insulating, light-emitting and self-healing phosphor composite layer contained PU modified with carboxyl groups to bind phosphor particles (ZnS). The scientists used boron-nitride (BN) nanosheets to increase dielectric permittivity and enhance luminescence of the composite layer. The final EL device comprised a three-layered configuration. The materials were assessed using scanning electron microscopy (SEM) after fabrication and after the damage/healing response. The physicochemical character of the multi-layered material was restored after damage.

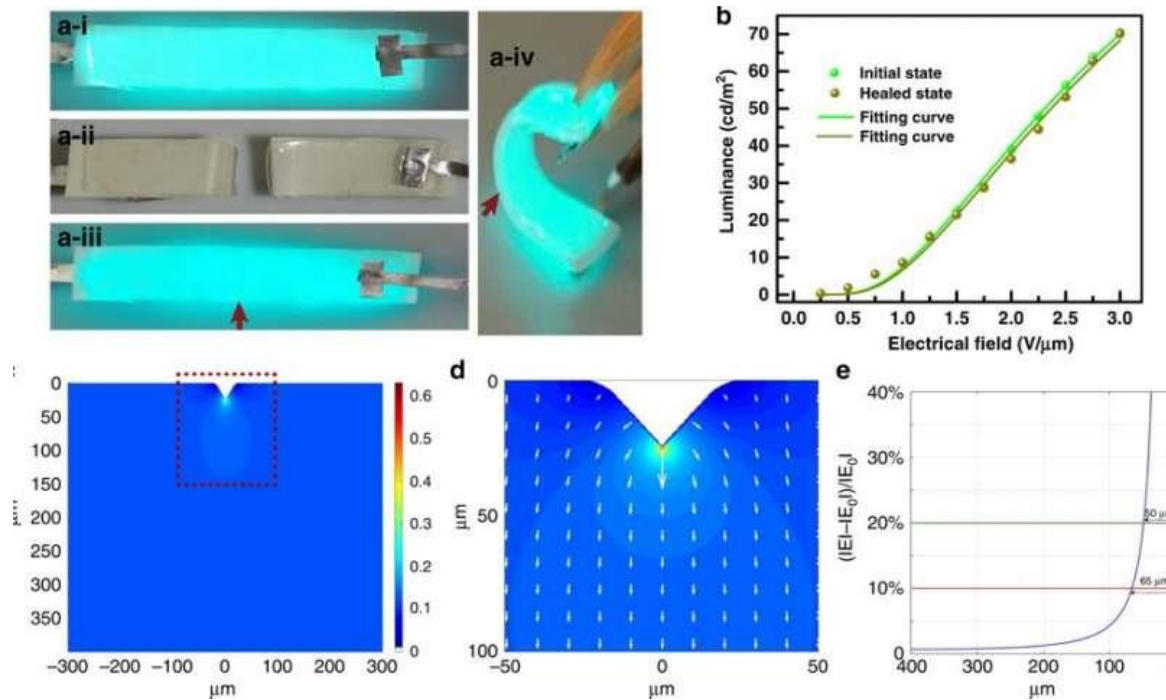

Characterizing the initial healing response: light-emitting performance of the self-healed EL device after cutting-healing process. a Demonstration of cutting-healing process of the healable EL device. a-i-a-iii exhibits the initial working ...[more](#)

The EL device contained the composite phosphor layer (composed of PU/ZnS/BN) sandwiched by two symmetric (PAA-NaCl based) transparent ionic conductors. The morphology of each layer/component was characterized using field-emission SEM and optical images. Restoration of mechanical strength after healing each layer was evaluated by hanging a weight. Ionic conductivities that were measured with electrochemical impedance spectroscopy (EIS) showed full restoration compared to the initial value, even after 10 cutting-healing cycles.

As proof of working principle, the scientists also observed the revival of a light emitting diode (LED) circuit after cut-healing cycles of the conducting material. Capacitance of the dielectric layer remained almost constant after different healing cycles, indicating that the light emission intensity and distributed voltage remained almost constant after healing. Mechanical properties of the healed EL device indicated restoration of both tensile strength and Young's modulus at the device breaking point, even after 10 cutting-healing cycles.

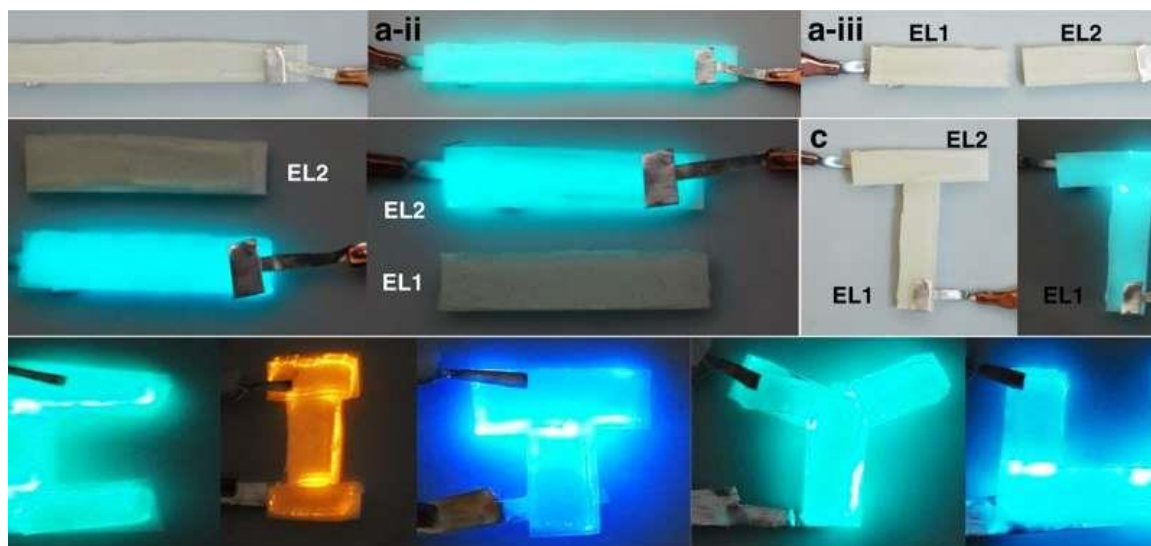

LEGO assembly process of self-healing EL devices. a) A complete EL device was cut into two individual EL units. a-i) indicates the initial resting state, a-ii) the working state, and a-iii) the cut state. b) The as-obtained two EL units in [...more](#)

The scientists also demonstrated the initial working state, cutting state and healed state (work after healing) guided by the rational design for both materials and the device. Successful revival of the light-emitting performance of the EL device indicated restoration of physicochemical and mechanical properties in each functional layer. The [experimental data](#) fit well with the equation derived in the study for both initial working state and the healed state.

Based on the outstanding healing capacity of the EL devices, the scientists assembled a few EL units into one integrated EL system to build a LEGO assembly of light-emitting devices. To accomplish this in the lab, the EL device was cut in half to create EL1 and EL2, and both units worked without any visible degradation in luminescence. During the LEGO assembly process, the scientists implemented two EL units to form a T-shaped light-emitting letter, with visible functionality on healing. Additionally, the scientists assembled the materials to form words with colorful light emissions using ZnS phosphor particles doped with different elements.

The study was a first to report the arbitrary LEGO-like assembly of EL devices, where all functional layers could be healed. The novel design can be applied to develop ionically conductive, healing hydrogels as transparent electrodes and [healing](#) dielectric polymers with insulating phosphor layers. Such materials will have advanced applications to build the next generation of wearable, deformable and [self-healing](#) electronics. [46]

Scientists develop a new method to revolutionize graphene printed electronics

A team of researchers based at The University of Manchester have found a low cost method for producing graphene printed electronics, which significantly speeds up and reduces the cost of conductive graphene inks.

Printed electronics offer a breakthrough in the penetration of information technology into everyday life. The possibility of printing [electronic circuits](#) will further promote the spread of Internet of Things (IoT) [applications](#).

The development of printed conductive inks for electronic applications has grown rapidly, widening applications in transistors, sensors, antennas RFID tags and wearable electronics.

Current conductive inks traditionally use metal nanoparticles for their high electrical conductivity. However, these [materials](#) can be expensive or easily oxidised, making them far from ideal for low cost IoT applications.

The team have found that using a material called dihydrolevoglucosenone known as Cyrene is not only non-toxic but is environmentally- friendly and sustainable but can also provide higher concentrations and conductivity of [graphene](#) ink.

Professor Zhiurn Hu said: "This work demonstrates that printed graphene technology can be low cost, sustainable, and environmentally friendly for ubiquitous wireless connectivity in IoT era as well as provide RF energy harvesting for low power electronics".

Professor Sir Kostya Novoselov said: "Graphene is swiftly moving from research to application domain. Development of production methods relevant to the end-user in terms of their flexibility, cost and compatibility with existing technologies are extremely important. This work will ensure that implementation of graphene into day-to-day products and technologies will be even faster".

Kewen Pan, the lead author on the paper said: "This perhaps is a significant step towards commercialisation of printed graphene technology. I believe it would be an evolution in printed electronics industry because the material is such low cost, stable and environmental friendly".

The National Physical Laboratory (NPL), who were involved in measurements for this work, have partnered with the National Graphene Institute at The University of Manchester to provide a materials characterisation service to provide the missing link for the industrialisation of graphene and 2-D materials. They have also published a joint NPL and NGI a good practice guide which aims to tackle the ambiguity surrounding how to measure graphene's characteristics.

Professor Ling Hao said: "Materials characterisation is crucial to be able to ensure performance reproducibility and scale up for commercial applications of graphene and 2-D materials. The results of this collaboration between the University and NPL is mutually beneficial, as well as providing measurement training for Ph.D. students in a metrology institute environment."

Graphene has the potential to create the next generation of electronics currently limited to science fiction: faster transistors, semiconductors, bendable phones and flexible wearable electronics. [45]

Here's how graphene could make future electronics superfast

Graphene just added another badge to its supermaterial sash.

New experiments show that this single layer of carbon atoms [can transform electronic signals](#) at gigahertz frequencies into higher-frequency terahertz signals — which can shuttle up to 1,000 times as much information per second.

Electromagnetic waves in the terahertz range are [notoriously difficult to create](#), and conventional silicon-based electronics have trouble handling such high-frequency signals (*SN: 3/28/09, p. 24*). But graphene-based devices could. These future electronics would work much faster than today's devices, researchers report online September 10 in *Nature*.

Crunch time

Graphene takes incoming gigahertz waves (black) and transforms them into waves in the terahertz range that have three, five and seven times the original frequency (red, green and blue, respectively).

Graphene's effect on electronic frequency

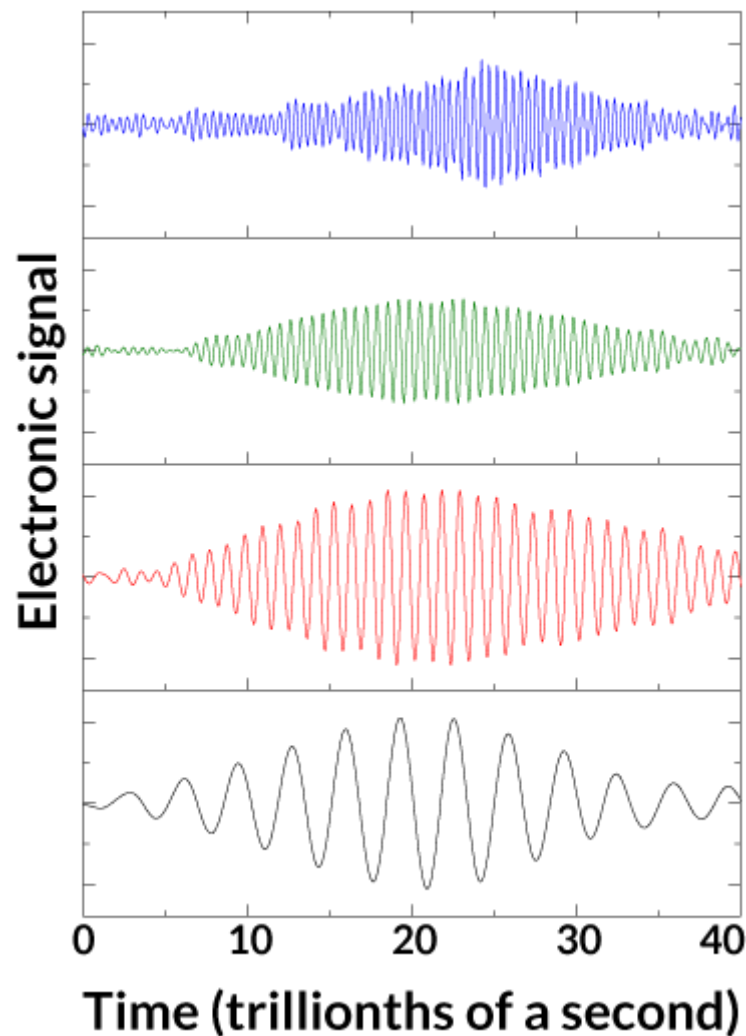

Physicist Dmitry Turchinovich of the University of Duisburg-Essen in Germany and colleagues tested graphene's terahertz-producing prowess by injecting a sheet of this atom-thick material with 300-gigahertz radiation. When these electromagnetic waves hit the graphene, electrons in the material rapidly heated and cooled off, releasing electromagnetic waves with frequencies up to seven times as high as the incoming radiation. "This is yet another amazing result for graphene," says Orad Reshef, a physicist at the University of Ottawa not involved in the work. The 2-D material has been hailed as a supermaterial for its extraordinary abilities, such as [conducting electric current](#) with no resistance (*SN*: 3/31/18, p. 13).

The graphene converted more than a thousandth, a ten-thousandth and a hundred-thousandth of the original 300-gigahertz signal into waves at 0.9, 1.5 and 2.1 terahertz, respectively. That conversion rate may seem small, but it's remarkably high for a lone layer of atoms, says Tsuneyuki Ozaki, a physicist at the National Institute of Scientific Research in Quebec City not involved in the work.

Graphene-based computer components that can deal in terahertz "could be used, not in a normal Macintosh or PC, but perhaps in very advanced computers with high processing rates," Ozaki says. This 2-D material could also be used to make extremely high-speed nanodevices, he adds. [44]

Laser sintering optimized for printed electronics

Printed electronics use standard printing techniques to manufacture electronic devices on different substrates like glass, plastic films, and paper. Interest in this area is growing because of the potential to create cheaper circuits more efficiently than conventional methods. A new study by researchers at Soonchunhyang University in South Korea, published in *AIP Advances*, provides insights into the processing of copper nanoparticle ink with green laser light.

Kye-Si Kwon and his colleagues previously worked with silver nanoparticle ink, but they turned to [copper](#) (derived from [copper oxide](#)) as a possible low-cost alternative. Metallic inks composed of [nanoparticles](#) hold an advantage over bulk metals because of their lower melting points. Although the melting point of copper is about 1,083 degrees Celsius in bulk, according to Kwon, [copper nanoparticles](#) can be brought to their melting point at just 150 to 500 C—through a process called sintering. Then, they can be merged and bound together.

Kwon's group concentrates on photonic approaches for heating nanoparticles by the absorption of light. "A laser beam can be focused on a very small area, down to the micrometer level," explained Kwon and doctorate student Md. Khalilur Rahman. Heat from the laser serves two main purposes: converting copper oxide into copper and promoting the conjoining of copper particles through melting.

A green laser was selected for these tasks because its light (in the 500- to 800-nanometer wavelength absorption rate range) was deemed best suited to the application. Kwon was also curious because, to his knowledge, the use of green lasers in this role has not been reported elsewhere.

In their experiment, his group used commercially available copper oxide nanoparticle ink, which was spin-coated onto glass at two speeds to obtain two thicknesses. Then, they prebaked the material to dry out most of the solvent prior to sintering. This is necessary to reduce the copper oxide film thickness and to prevent air bubble explosions that might occur from the solvent suddenly boiling during irradiation. After a series of tests, Kwon's team concluded that the prebaking temperature should be slightly lower than 200 degrees C.

The researchers also investigated the optimal settings of laser power and scanning speed during sintering to enhance the conductivity of the copper circuits. They discovered that the best sintered results were produced when the laser power ranged from 0.3 to 0.5 watts. They also found that to reach the desired conductivity, the [laser](#) scanning speed should not be faster than 100 millimeters per second, or slower than 10 mm/s.

Additionally, Kwon and his group investigated the thickness of the film—before and after sintering—and its impact on conductivity. Kwon and his group concluded that sintering reduces thickness by as much as 74 percent.

In future experiments, Kwon's team will examine the substrate effects on [sintering](#). Taken together, these studies can provide answers to some of the uncertainties hindering [printed electronics](#). [43]

An ultracompact laser has been made using nanoscale semiconductor columns

A tiny laser comprising an array of nanoscale semiconductor cylinders (see image) has been made by an all-A*STAR team. This is the first time that lasing has been achieved in non-metallic nanostructures, and it promises to lead to miniature lasers usable in a wide range of optoelectronic devices.

Microscale lasers are widely used in devices such as CD and DVD players. Now, optical engineers are developing nanoscale lasers—so small that they cannot be seen by the human eye.

A promising method is to use arrays of [tiny structures](#) made from semiconductors with a high refractive index. Such structures act as tiny antennas, resonating at specific wavelengths. However, it has been challenging to use them to construct a cavity—the heart of a laser, where light bounces around while being amplified.

Now, Arseniy Kuznetsov, Son Tung Ha, Ramón Paniagua-Domínguez, and their colleagues at the A*STAR Institute of Materials Research and Engineering have overcome this problem by exploiting a highly unusual type of standing wave that remains in one spot despite coexisting with a continuous spectrum of radiating waves that can transport energy away. First predicted by quantum mechanics, this wave was demonstrated experimentally in optics about a decade ago.

There was an element of serendipity in the invention. "We initially planned to create a laser just based on the diffractive resonances in the array," recalls Kuznetsov. "But after fabricating samples

and testing them, we discovered this strong enhancement at a different wavelength from expected. When we went back and did further simulations and analysis, we realized that we had created these special waves."

The demonstration is the culmination of five years of research by the team. It was a race against time, since other groups were also working on developing active nanoantennas, Kuznetsov notes. "Until now, lasing hasn't been realized in nanoantenna structures," he says. "So it's a big step for the dielectric nanoantenna community."

Their laser also has advantages over other kinds of miniature lasers. Firstly, the direction of its narrow, well-defined beam can be easily controlled—this maneuverability is often needed in device applications. Also, because the nanocylinders are quite sparsely distributed, the [laser](#) is highly transparent, which is beneficial for multilayer devices that contain other optical components.

The team is now working to develop lasers that can be excited electrically, rather than by light as in the present study, which would be a major advance toward realizing commercial nanolasers. [42]

Researchers optically trap, move and analyze living cells with laser/microscope combo

A new instrument lets researchers use multiple laser beams and a microscope to trap and move cells and then analyze them in real-time with a sensitive analysis technique known as Raman spectroscopy. The instrument could allow scientists to learn more about how infections take hold or the formation of antibiotic-resistant bacterial biofilms.

"Many techniques in biology measure a large number of cells at once, or require added labels or invasive techniques to look at the single cell level," said research team leader Ioan Notingher from the University of Nottingham in the U.K. "Our technique is non-invasive—meaning that it doesn't disturb or destroy the biological sample—and requires no labelling, which is more desirable for studying individual cells."

In The Optical Society (OSA) journal *Optics Express*, the researchers demonstrated their new instrument by using the optical traps—which use light to hold and move small objects—to form a connection between multiple [human immune cells](#) and then measure the changes in the cell interactions over time with Raman spectroscopy. This experiment could be a starting point for investigating how these immune cells communicate in the body.

"The instrument we created is quite robust, sensitive and widely applicable to many possible types of experiments on cells," said Notingher. In addition to biological investigations, the instrument could also be used to study polymers, nanomaterials and various chemical processes. It could also be combined with other microscopy techniques to obtain even more information.

Combining trapping and spectroscopy

Raman spectroscopy uses the interaction between [laser](#) light and a sample such as DNA or protein to obtain information about the sample's chemical composition. Traditionally, Raman spectroscopy uses one focused laser beam to obtain measurements from a point on a sample. Using a setup

where the emitted light passes through a small pinhole, or aperture, can help increase the quality of these measurements by removing unwanted stray light.

To use optical trapping and Raman spectroscopy simultaneously at many sample points requires many focused laser spots. Although this has been previously achieved with an optical component known as a liquid-crystal spatial light modulator (LCSLM), that approach requires the use of pinholes matched to each sampling point.

The researchers built a more flexible instrument by combining an LCSLM with a digital micro-mirror device (DMD) to create reflective virtual pinholes that were customized for each sampling point and could be rapidly controlled with a computer. DMDs are used in many modern digital projectors and are made of hundreds of thousands of tilting microscopic mirrors.

"The multi-point optical trapping and Raman spectroscopy can be controlled interactively and in real-time using the software developed by Miles Padgett's group at the University of Glasgow," said the paper's first author Faris Sinjab. "This software allows completely automated experiments, which could be useful for carrying out complex or large systematically repeated experiments."

Fast acquisition

After demonstrating that the performance of the Raman instrument is comparable to a single-beam Raman microscope, the researchers used it to move multiple polystyrene particles around with the optical traps while simultaneously acquiring Raman spectra at 40 spectra per second. "This type of experiment would not previously have been possible because spectra could not be acquired from such rapidly changing locations," said Sinjab.

Next, the researchers showed they could control the power in each laser beam and avoid damaging trapped cells with the laser. Finally, to demonstrate the capability of the instrument for cell biology applications, they brought multiple live T cells into contact with a dendritic cell to initiate the formation of immunological synapse junctions where these [immune cells](#) met. Measuring Raman spectra at multiple points over time revealed molecular differences among the junctions formed.

The researchers are now working to further automate portions of the Raman [spectroscopy](#) so that non-expert users could carry out experiments. They are also exploring how to miniaturize the [instrument](#) by incorporating a custom microscope and spectrometer with a more compact high-power laser. [41]

Near-infrared laser systems for monitoring forest dynamics from space pass final tests

All systems are go for launch in November of NASA's Global Ecosystem Dynamics Investigation (GEDI) mission, which will use high-resolution laser ranging to study Earth's forests and topography from the International Space Station (ISS).

The scientific mission seeks to answer questions about how much deforestation has contributed to atmospheric carbon dioxide concentrations and how much carbon forests would absorb in the future. It is led by a research group at the University of Maryland, which is working in collaboration

with a team at the National Aeronautics and Space Administration that is designing the laser for GEDI.

During The Optical Society's Frontiers in Optics + Laser Science APS/DLS conference being held 16-20 Sept., 2018, in Washington, D.C., NASA Goddard Space Flight Center laser engineer Paul Stysley and colleagues Barry Coyle, Erich Frese and Furqan Chiragh will present their work designing and building the laser systems for the GEDI mission. They will describe the extensive testing that the systems were required to pass for both transport and subsequent operation in low-Earth orbit.

The presentation will be part of the "Novel Devices Manufacturing and Testing" session, to be held at 10:30 a.m. on Monday, 17 September in the Jefferson West ballroom of the Washington Hilton hotel.

"We wanted to design a laser that could enable LIDAR-based remote sensing for Earth science and planetary exploration missions," said Stysley.

The team designed a laser system that "is comparatively simple, has appropriate margin on performance specifications, and is well understood," he added. "This, in turn, allows it to be efficient and adaptable to different missions, as well as robust in a space flight environment."

Using light detection and ranging (LIDAR) technology, researchers shoot laser energy pulses at the Earth's surface and precisely record their return timing. This data produces a 3-D image in the form of vertical observation or a full-waveform that shows the world's forest canopy and the topography of the ground beneath it.

This is possible because the transmitted laser light pulses are reflected by the ground, trees, vegetation or clouds, and then collected by GEDI's receiver. The returning photons are directed toward detectors, which convert the brightness of the light to an electronic voltage that's recorded as a function of time in 1-nanosecond intervals. Time can be converted to range (distance) by multiplying it by the speed of light, and then the full waveform can be calculated by the recorded voltage as a function of range.

The laser system allows full-waveform data to be collected, which will provide the ground elevation and vegetation canopy height measurements on a global level. "The canopy and 3-D waveform data products are based on ones that have already been provided by NASA's Land, Vegetation, and Ice Sensor facility on airborne LIDAR missions," Stysley said. "The GEDI lasers were internally designed, fabricated, assembled and tested by the Laser and Electro-optics branch at NASA-Goddard."

"Our design is easily adaptable for follow-on vegetation LIDAR missions or for planetary missions that need an efficient laser altimeter," Stysley said.

When designing the laser system, Stysley said the NASA group had to ensure it would be able to survive the extreme heat and vibrations of being blasted into space on a rocket, as well as endure the harsh environment of space once installed on the Japanese Experiment Module-Exposed Facility outside the ISS.

The group put the lasers through thermal vacuum testing for near-space flight simulation to ensure that the lasers can function and survive in space, as well as vibrational qualification testing of the lasers' final assembly.

Stysley and his colleagues were somewhat surprised by how much you can learn about a laser as it undergoes space-flight environmental testing.

"No matter how well you know a laser design, it's important to appropriately test it at the environmental requirements levied on you by a mission and to have enough performance margin on your design to be able to compensate for any minor 'surprises' that come up during testing," said Stysley. "Subtle changes in things like temperature profile can expose new things about how your [laser](#) behaves in relatively unusual situations and, often, resources—money, time, and technical relief—will be needed to meet requirements."

The GEDI [mission](#), scheduled to launch in November, will operate on ISS for up to two years. [40]

Laser-driven electron recollision remembers molecular orbital structure

Scientists from the Max Born Institute for Nonlinear Optics and Short Pulse Spectroscopy (MBI) in Berlin combined state-of-the-art experiments and numerical simulations to test a fundamental assumption underlying strong-field physics. Their results refine our understanding of strong-field processes such as high harmonic generation (HHG) and laser-induced electron diffraction (LIED).

Scientists from the Max Born Institute for Nonlinear Optics and Short Pulse Spectroscopy (MBI) in Berlin combined state-of-the-art experiments and [numerical simulations](#) to test a fundamental assumption underlying strong-field physics. Their results refine our understanding of strong-field processes such as high harmonic generation (HHG) and laser-induced electron diffraction (LIED).

Strong [infrared laser pulses](#) can extract an electron from a molecule (ionization), accelerate it away into free space, then turn it around (propagation), and finally collide it with the molecule (recollision). This is the widely used three-step model of strong-field physics. In the recollision step, the electron may, for example, recombine with the parent ion, giving rise to high harmonic generation, or scatter elastically, giving rise to laser-induced electron diffraction.

One of the commonly used assumptions underlying attosecond [physics](#) is that, in the propagation step, the initial structure of the ionized electron is "washed out", thus losing the information on the originating orbital. So far, this assumption was not experimentally verified in molecular systems.

A combined experimental and theoretical study at the Max Born Institute Berlin investigated the strong-field driven electron recollision dynamics in the 1,3-trans-butadiene molecule. In this molecule, the interaction with the strong laser field leads mainly to the ionization of two outermost electrons exhibiting quite different densities. The state-of-the-art experiments and simulations then allowed the scientists to measure and calculate the high-angle rescattering probability for each electron separately. These probabilities turned out to be quite different both in the measurements and in the simulations. These observations clearly demonstrate that the returning electrons do retain structural information on their initial molecular orbital.

The study is published in *Science Advances*. [39]

Femtosecond laser fabrication—realizing dynamics control of electrons

Femtosecond lasers are capable of processing any solid material with high quality and high precision using their ultrafast and ultra-intense characteristics. With the continuous development of laser technology, ultrafast laser manufacturing could become one of the primary methods employed in high-end manufacturing in the future.

Recently, researchers have realized a new method of electron dynamics control for ultrafast laser micro/nano fabrication. For the first time, the localized transient electron dynamics can be actively controlled to manipulate material properties, which greatly enhances the efficiency, quality, uniformity and precision of laser fabrication.

This research was conducted by the group of Professor Lan Jiang from Beijing Institute of Technology, in cooperation with Professor Tian-Hong Cui from the University of Minnesota, and Professor Yongfeng Lu from the University of Nebraska–Lincoln. Their research results were recently reviewed in *Light: Science and Applications*.

Over the past decade, the research group has devoted their efforts to studying novel methods of manufacturing based on electron dynamics control. They used the temporally/spatially-shaped ultrafast laser to control localized transient electron dynamics (e.g., density, temperature, and distribution); furthermore, they modified the localized transient material properties and adjusted material phase change; eventually, they implemented the novel fabrication method.

They established a multiscale model of ultrafast laser materials interactions and predicted that the temporally/spatially-shaped ultrafast pulses can control the laser material interaction processes. Furthermore, on the basis of the theoretical predictions, they experimentally verified the validity of the electron dynamics control method. In addition, they proposed and implemented a multiscale measurement system for observing femtosecond laser ablation dynamics from femtosecond scale to second scale, which provided experimental evidences for the proposed mechanism.

Using this method, they greatly improved fabrication efficiency, quality, repeatability and precision, and extended the fabrication limits of laser manufacturing. The new method has resolved some critical manufacturing challenges and already been applied to a series of major Chinese national projects. This novel method realizes the active control of localized transient electron dynamics in the laser fabrication process for the first time. Furthermore, it opens wide possibilities for the control of fabrication on the electron level, which may provide revolutionary contributions to high-end manufacturing, material properties manipulation, and chemical reactions control. [38]

Researchers create microlaser that flies along hollow optical fiber

For the first time, researchers have optically trapped and propelled a particle-based laser for centimeters inside an optical fiber. The new flying microlaser enables highly sensitive temperature measurements along the length of the fiber and could offer a novel way to precisely deliver light to remote and inaccessible locations.

"The flying microlaser could potentially be used to deliver light inside the body," said Richard Zeltner of the Max Planck Institute for the Science of Light, Germany. "By inserting a fiber into the skin, a microlaser emitting at a suitable wavelength could deliver precisely positioned light for use with light-activated drugs. The concept could also be applied in optofluidic lab-on-a-chip devices to provide a light source for various bioanalysis techniques or for on-chip [temperature](#) measurements with high spatial resolution." In The Optical Society (OSA) journal *Optics Letters*, researchers led by Philip St.J. Russell reported that the flying microlaser can perform position-resolved temperature sensing with a spatial resolution on the order of millimeters. This demonstration showed the flying microlaser's usefulness for distributed sensing, an approach that performs real-time continuous sensing along an optical fiber.

The flying microlaser is based on a whispering gallery mode resonator, a small particle that confines and enhances certain wavelengths of light. The name comes from the fact that the light waves travel around the curved inner surface of these particles in the same way that the acoustic waves travel around curved surfaces such as the whispering gallery in St. Paul's Cathedral, allowing whispers to be clearly heard from the other side of the gallery.

"This is the first demonstration of distributed sensing using a whispering gallery mode resonator," said Zeltner. "This unique approach to sensing potentially opens many new possibilities for distributed measurements and assessing physical properties remotely with [high spatial resolution](#). For example, it could be useful for temperature sensing in harsh environments."

Making a laser fly

A critical component for creating the flying microlaser was a special type of fiber known as hollow-core photonic crystal fiber. As the name implies, this fiber features a central core that is hollow rather than solid glass like traditional optical fibers. The hollow core is surrounded by a glass microstructure that confines light inside the fiber.

"For quite some time, our research group has been developing the technology necessary to optically trap particles inside hollow-core photonic crystal fibers," said Shangran Xie, a member of the research team. "In this new work, we were able to apply this technology not just to trap a particle but also to induce it to act as a laser that can be used for sensing over long distances in a fiber."

To create the flying microlaser, the researchers launched laser light into a water-filled hollow core fiber to optically trap the microparticle. Like the materials used to make traditional lasers, the microparticle incorporates a gain medium. The researchers excited this gain medium using a second laser beam, causing the microparticle to emit [light](#), or lase. The particle position along the fiber is controlled using optical forces generated by the trapping laser or by introducing a flow of water inside the core.

Precision temperature sensing

To test the new system's ability to sense temperature changes, the researchers propelled the lasing microparticle along two regions of the fiber heated to 22 degrees Celsius above room temperature. By measuring shifts in the lasing wavelengths emitted from the microparticle, they could precisely detect changes in temperature as the [microlaser](#) moved through the fiber. The sensor detected temperature changes of just under 3 degrees Celsius and provided a spatial resolution of a few millimeters.

"The spatial resolution of this distributed sensor is ultimately limited by the size of the particle," said Zeltner. "This means that, potentially, we could achieve [spatial resolution](#) as small as several micrometers over very long measurement ranges, which is a huge advantage of our system compared with other types of distributed temperature sensors."

Using a technique called laser Doppler velocimetry, the researchers determined that the particle moved at a speed of 250 microns per second during the experiment. They say that using a fiber filled with air rather than water could increase the propulsion speed to centimeters or even meters per second.

Although the microparticles used in the experiment tend to lose their ability to lase after about a minute due to photobleaching, the researchers say that microparticles with different gain materials could solve this problem. They are also exploring whether multiple microlasers could be manipulated inside the fiber simultaneously and are working on improvements of the particle position detection scheme.

"With the increasing commercialization of hollow-core photonic crystal fibers, all the technology we need to turn this system into a practical sensor is already available," said Zeltner. [37]

New ultrafast measurement technique shows how lasers start from chaos

Lasers that emit ultrashort pulses of light are critical components of technologies, including communications and industrial processing, and have been central to fundamental Nobel Prize-winning research in physics. Although first invented in the 1960s, the exact mechanism whereby lasers actually produce such bright flashes of light has remained elusive. It has not been previously possible to look inside a laser as it is first turned on to see how the laser pulses build up from noise. However, research recently published online in *Nature Photonics* has demonstrated for the first time how laser pulses emerge out of nowhere from noise and then display complex collapse and oscillation dynamics before eventually settling down to stable regular operation.

"The reason why understanding these lasers has been so difficult is because the pulses they produce are typically of picosecond duration or shorter. Following the complex build-up dynamics of such short pulses for the hundreds, sometimes thousands of bursts before the laser actually stabilizes has been beyond the capability of optical measurement techniques," says Professor Goëry Genty, who supervised the research in the Laboratory of Photonics at Tampere University of Technology (TUT).

This research was performed in collaboration between the FEMTO-ST Institute in France (CNRS and the University of Bourgogne-Franche-Comté) and the Laboratory of Photonics at TUT. The particular scientific advance that led to the novel findings is the real-time measurement of the laser temporal intensity with sub-picosecond resolution, as well as its optical spectrum with sub-nanometer resolution. By recording both these temporal and spectral properties simultaneously, an advanced computational algorithm can retrieve the complete characteristics of the underlying electromagnetic field.

Aside from providing new insights into how pulsed lasers operate, the research results have important interdisciplinary applications.

"The results provide a very convenient laboratory example of what is known as a "dissipative soliton system" which is a central concept in nonlinear science and also relevant to studies in other fields, such as biology, medicine and possibly even social sciences," says Professor John. M. Dudley, who led the research at the University of Bourgogne-Franche-Comté.

While reconstructing the evolution of the electromagnetic field, the team observed a wide range of interaction scenarios between dissipative soliton structures emerging from noise.

"The approach we have implemented can operate at low input power levels and high speeds. The results provide a completely new window on previously unseen interactions between emerging dissipative solitons in form of collisions, merging or collapse", Genty says.

The researchers believe that their results will allow improved design and performance of ultrafast pulsed lasers.

"This is a truly fascinating area of research where studies motivated by questions in fundamental science have the potential to have real practical impact in future photonic technology," concludes Dudley. [36]

Attoseconds break into atomic interior

A newly developed laser technology has enabled physicists in the Laboratory for Attosecond Physics (jointly run by LMU Munich and the Max Planck Institute of Quantum Optics) to generate attosecond bursts of high-energy photons of unprecedented intensity. This has made it possible to observe the interaction of multiple photons in a single such pulse with electrons in the inner orbital shell of an atom.

In order to observe the ultrafast electron motion in the inner shells of atoms with short light pulses, the pulses must not only be ultrashort, but very bright, and the photons delivered must have sufficiently high energy. This combination of properties has been sought in laboratories around the world for the past 15 years. Physicists at the Laboratory for Attosecond Physics (LAP), a joint venture between the Ludwig-Maximilians-Universität Munich (LMU) and the Max Planck Institute of Quantum Optics (MPQ), have now succeeded in meeting the conditions necessary to achieve this goal. In their latest experiments, they have been able to observe the non-linear interaction of an

attosecond pulse with electrons in one of the inner orbital shells around the atomic nucleus. In this context, the term 'non-linear' indicates that the interaction involves more than one photon (in this particular case two are involved). This breakthrough was made possible by the development of a novel source of attosecond pulses. One attosecond lasts for exactly one billionth of a billionth of a second.

The door for observing the ultrafast motion of electrons deep inside atoms has been opened. Physicists in the Laboratory for Attosecond Physics (LAP) at the LMU Munich have developed a technology that allows them to generate intense attosecond pulses. These pulses can be used to follow the motion of electrons within the inner shells of atoms in real time by freezing this motion at attosecond shutter speeds.

The experimental procedure used to film electrons in motion makes use of the 'pump-probe' approach. Electrons within a target atom are first excited by a photon contained within the pump pulse, which is then followed after a short delay by a second photon in a probe pulse. The latter essentially reveals the effect of the pump photon. In order to implement this procedure, the photons must be so tightly packed that a single atom within the target can be hit by two photons in succession. Moreover, if these photons are to have a chance of reaching the inner electron shells, they must have energies in the upper end of the extreme ultraviolet (XUV) spectrum. No research group has previously succeeded in generating attosecond pulses with the required photon density in this spectral region.

The technology that has now made this feat possible is based on the upscaling of conventional sources of attosecond pulses. A team led by Prof. Laszlo Veisz has developed a novel high-power laser capable of emitting bursts of infrared light – each consisting of only a few oscillation cycles – which contain 100 times as many photons per pulse as in conventional systems. These pulses, in turn, allow the generation of isolated attosecond pulses of XUV light containing 100 times more photons as in conventional attosecond sources.

In a first series of experiments, the high-energy attosecond pulses were focused on a stream of xenon gas. Photons that happen to interact with an inner shell of a xenon atom eject electrons from that shell and ionize the atom. By using what is known as an ion microscope to detect these ions, the scientists were able, for the first time, to observe the interaction of two photons confined in an attosecond pulse with electrons in the inner orbital shells of an atom. In previous attosecond experiments, it has only been possible to observe the interaction of inner shell electrons with a single XUV photon.

"Experiments in which it is possible to have inner shell electrons interacting with two XUV attosecond pulses are often referred to as the Holy Grail of attosecond physics. With two XUV pulses, we would be able to 'film' the electron motion in the inner atomic shells without perturbing their dynamics," says Dr. Boris Bergues, the leader of the new study. This represents a significant advance on attosecond experiments involving excitation with a single attosecond XUV photon. In those experiments, the resulting state was 'photographed' with a longer infrared pulse, which itself had a significant influence on the ensuing electron motion.

"The electron dynamics in the inner shells of atoms are of particular interest, because they result from a complex interplay between many electrons that interact with each other," as Bergues

explains. "The detailed dynamics resulting from these interactions raise many questions, which we can now address experimentally using our new attosecond source."

In the next step, the physicists plan an experiment in which they will time resolve the interaction by splitting the high-intensity attosecond pulse into separate pump and probe pulses.

The successful application of non-linear optics in the attosecond domain to probe the behaviour of electrons in the inner orbital shells of atoms opens the door to a new understanding of the complex multibody dynamics of subatomic particles. The ability to film the motion of electrons deep in the interior of atoms promises to reveal much about a mysterious realm that has remained hidden.

[35]

Super-resolution microscopy in both space and time

Super-resolution microscopy is a technique that can "see" beyond the diffraction of light, providing unprecedented views of cells and their interior structures and organelles. The technique has garnered increasing interest recently, especially since its developers won the Nobel Prize in Chemistry in 2014.

But super-resolution microscopy comes with a big limitation: it only offers spatial resolution. That might suffice for static samples, like solid materials or fixed cells, but when it comes to biology, things become more complicated. Living cells are highly dynamic and depend on a complex set of biological processes that occur across sub-second timescales, constantly changing. So if we are to visualize and understand how living cells function in health and disease, we need a high time (or "temporal") resolution as well.

A team led by Professor Theo Lasser, the head of the Laboratory of Biomedical Optics (LOB) at EPFL has now made strides to address the issue by developing a technique that can perform both 3-D super-resolution microscopy and fast 3-D phase imaging in a single instrument. Phase imaging is a technique that translates the changes in the phase of light caused by cells and their organelles into refractive index maps of the cells themselves.

The unique platform, which is referred as a 4-D microscope, combines the sensitivity and high time-resolution of phase imaging with the specificity and high spatial resolution of fluorescence microscopy. The researchers developed a novel algorithm that can recover the phase information from a stack of bright-field images taken by a classical microscope.



PRISM: microscopy add-on to perform simultaneous 3D imaging of 8 planes. Credit: Vytautas Navikas

"With this algorithm, we present a new way to achieve 3-D quantitative phase microscopy using a conventional bright-field microscope," says Adrien Descloux, one of the lead authors of the paper. "This allows direct visualization and analysis of subcellular structures in living cells without labeling."

To achieve fast 3-D imaging, the scientists custom-designed an image-splitting prism, which allows the simultaneous recording of a stack of eight z-displaced images. This means that the microscope can perform high-speed 3-D phase imaging across a volume of $2.5\mu\text{m} \times 50\mu\text{m} \times 50\mu\text{m}$. The microscope's speed is basically limited by the speed of its camera; for this demonstration, the team was able to image intracellular dynamics at up to 200 Hz. "With the prism as an add-on, you can turn a classical microscope into an ultra-fast 3-D imager," says Kristin Grussmayer, another one of the paper's lead authors.

The prism is also suited for 3-D fluorescence imaging, which the scientists tested using super-resolution optical fluctuation imaging (SOFI). This method exploits the blinking of fluorescent dyes to improve 3-D resolution through correlation analysis of the signal. Using this, the researchers performed 3-D super-resolution imaging of stained structures in the cells, and combined it with 3-D

label-free phase imaging. The two techniques complemented each other very well, revealing fascinating images of the inner architecture, cytoskeleton, and organelles also in living cells across different time points.

"We are thrilled by these results and the possibilities offered by this technique," says Professor Hilal Lashuel, whose lab at EPFL teamed up with Professor Lasser's in using the new technique to study the mechanisms by which protein aggregation contributes to the development and progression of neurodegenerative diseases, such as Parkinson's and Alzheimer's. "The technical advances enabled high-resolution visualization of the formation of pathological alpha synuclein aggregates in hippocampal neurons."

The team has named the new microscopy platform PRISM, for Phase Retrieval Instrument with Super-resolution Microscopy. "We offer PRISM as a new microscopy tool and anticipate that it will be rapidly used in the life science community to expand the scope for 3-D high-speed imaging for biological investigations," says Theo Lasser. "We hope that it will become a regular workhorse for neuroscience and biology." [34]

Optical distance measurement at record-high speed

Microresonator-based optical frequency combs enable highly-precise optical distance ranging at a rate of 100 million measurements per second – publication in *Science*: Scientists of Karlsruhe Institute of Technology (KIT) and École polytechnique fédérale de Lausanne (EPFL) have demonstrated the fastest distance measurement so far. The researchers demonstrated on-the-fly sampling of a gun bullet profile with micrometer accuracy. The experiment relied on a soliton frequency comb generated in a chip-based optical microresonator made from silicon nitride. Potential applications comprise real-time 3-D cameras based on highly precise and compact LIDAR systems.

For decades, distance metrology by means of lasers, also known as LIDAR (laser-based light detection and ranging), has been an established method. Today, optical distance measurement methods are being applied in a wide variety of emerging applications, such as navigation of autonomous objects, e.g. drones or satellites, or process control in smart factories. These applications are associated with very stringent requirements regarding measurement speed and accuracy, as well as size of the optical distance measurement systems. A team of researchers headed by Professor Christian Koos at KIT's Institute of Photonics and Quantum Electronics (IPQ) together with the team of Professor Tobias Kippenberg at École polytechnique fédérale de Lausanne (EPFL) has started to address this challenge in a joint activity, aiming at a concept for ultra-fast and highly precise LIDAR system that shall fit into a matchbox one day. The basics of this concept have now been published in the scientific journal *Science*. To demonstrate the viability of their approach, the scientists used a gun bullet flying at a speed of 150 m/s. "We managed to sample the surface structure of the projectile on-the-fly, achieving micrometer accuracy", Professor Koos comments, "To this end, we recorded 100 million distance values per second, corresponding to the fastest distance measurement so far demonstrated."

This demonstration was enabled by a new type of chip-scale light source developed at EPFL, generating optical [frequency combs](#). The combs are generated in optical microresonators, tiny circular structures, which are fed by continuous-wave light from a laser source. Mediated by nonlinear optical processes, the laser light is converted into stable optical pulses – dissipative Kerr solitons – forming regular a pulse train that features a broadband optical spectrum. The concept crucially relies on high-quality silicon nitride microresonators with ultra-low losses, which were produced at EPFL's Centre of MicroNanotechnology (CMi). "We have developed low-loss optical resonators, in which extremely high optical intensities can be generated – a prerequisite for soliton frequency combs," says Professor Tobias Kippenberg of EPFL, "These so-called Kerr frequency combs have rapidly found their way into new applications over the previous years. "

In their demonstrations, the researchers combined findings from different areas. "In the past years, we have extensively studied methods for ultra-fast communications using chip-scale frequency comb sources," Christian Koos of KIT explains. "We now transfer these results to another research area – optical distance measurements." In 2017, the two teams already published a joint article in Nature, reporting on the potential of chip-scale soliton comb sources in optical telecommunications. In principle, [optical frequency combs](#) consist of light with a multitude of precisely defined wavelengths – the optical spectrum then resembles the teeth of a comb. If the structure of such a comb is known, the inference pattern resulting from superposition of a second frequency comb can be used to determine the distance traveled by the light. The more broadband the frequency combs, the higher is the measurement accuracy. In their experiments, the researchers used two optical microchips to generate a pair of nearly identical frequency combs.

The scientists consider their experiment to be a first demonstration of the measurement technique. Although the demonstrated combination of precision and speed in the ranging experiment is an important milestone in itself, the researchers aim at carrying the work further and at eliminating the remaining obstacles towards technical application. For instance, the range of the method is still limited to typical distances of less than 1 m. Moreover, today's standard processors do not permit real-time evaluation of the large amount of data generated by the measurement. Future activities will focus on a compact design, enabling highly precise ranging while fitting into the volume of a matchbox. The silicon-nitride microresonators are already commercially available by EPFL's spinoff LiGENTEC SA that has specialized on fabrication of silicon nitride-based photonic integrated circuits (PIC).

The envisaged sensors might serve a wide variety of applications, e.g., for high-throughput in-line control of high-precision mechanical parts in digital factories, replacing state-of-the-art inspection of a small subset of samples by laborious distance metrology. Moreover, the LIDAR concept might pave the path towards high-performance 3-D cameras in microchip format, which may find widespread applications in autonomous navigation. [33]

Researchers turn light upside down

Researchers from CIC nanoGUNE (San Sebastian, Spain) and collaborators have reported in *Science* the development of a so-called hyperbolic metasurface on which light propagates with completely reshaped wavefronts. This scientific achievement toward more precise control and monitoring of light is highly interesting for miniaturizing optical devices for sensing and signal processing.

Optical waves propagating away from a point source typically exhibit circular (convex) wavefronts. "Like waves on a water surface when a stone is dropped," says Peining Li, EU Marie Skłodowska-Curie fellow at nanoGUNE and first author of the paper. The reason for this circular propagation is that the medium through which [light](#) travels is typically homogeneous and isotropic, i.e., uniform in all directions.

Scientists had theoretically predicted that specifically structured surfaces can turn the wavefronts of light upside-down when it propagates along them. "On such surfaces, called hyperbolic metasurfaces, the waves emitted from a point source propagate only in certain directions, and with open (concave) wavefronts," explains Javier Alfaro, Ph.D. student at nanoGUNE and co-author of the paper. These unusual waves are called hyperbolic surface polaritons. Because they propagate only in certain directions, and with wavelengths that are much smaller than that of light in free space or standard waveguides, they could help to miniaturize [optical devices](#) for sensing and [signal processing](#).

Now, the researchers have developed such a metasurface for [infrared light](#). It is based on boron nitride, a graphene-like 2-D material, which was selected because of its ability to manipulate infrared light on extremely small length scales. This has applications in miniaturized chemical sensors or for heat management in nanoscale optoelectronic devices. The researchers directly observed the concave wavefronts with a special optical microscope.

Hyperbolic metasurfaces are challenging to fabricate, because an extremely precise structuring on the nanometer scale is required. Irene Dolado, Ph.D. student at nanoGUNE, and Saül Vélez, former postdoctoral researcher at nanoGUNE (now at ETH Zürich) mastered this challenge using electron beam lithography and etching of thin flakes of high-quality [boron nitride](#) provided by Kansas State University. "After several optimization steps, we achieved the required precision and obtained grating structures with gap sizes as small as 25 nm," Dolado says. "The same fabrication methods can also be applied to other materials, which could pave the way to realize artificial metasurface structures with custom-made optical properties," adds Saül Vélez.

To see how the waves propagate along the metasurface, the researchers used a state-of-the-art infrared nanoimaging technique that was pioneered by the nanoptics group at nanoGUNE. They first placed an infrared gold nanorod onto the metasurface. "It plays the role of a stone dropped into water," says Peining Li. The nanorod concentrates incident infrared light into a tiny spot, which launches waves that then propagate along the metasurface. With the help of a so-called scattering-type scanning near-field microscope (s-SNOM) the researchers imaged the waves. "It was amazing to see the images. They indeed showed the concave curvature of the wavefronts that were

propagating away from the gold nanorod, exactly as predicted by theory," says Rainer Hillenbrand, Ikerbasque Professor at nanoGUNE, who led the work.

The results promise nanostructured 2-D materials to become a novel platform for hyperbolic metasurface devices and circuits, and further demonstrate how near-field microscopy can be applied to unveil exotic optical phenomena in anisotropic materials and for verifying new [metasurface](#) design principles. [32]

New form of light: Newly observed optical state could enable quantum computing with photons

Try a quick experiment: Take two flashlights into a dark room and shine them so that their light beams cross. Notice anything peculiar? The rather anticlimactic answer is, probably not. That's because the individual photons that make up light do not interact. Instead, they simply pass each other by, like indifferent spirits in the night.

But what if [light particles](#) could be made to interact, attracting and repelling each other like atoms in ordinary matter? One tantalizing, albeit sci-fi possibility: [light sabers](#) - beams of light that can pull and push on each other, making for dazzling, epic confrontations. Or, in a more likely scenario, two beams of light could meet and merge into one single, luminous stream.

It may seem like such optical behavior would require bending the rules of physics, but in fact, scientists at MIT, Harvard University, and elsewhere have now demonstrated that photons can indeed be made to interact - an accomplishment that could open a path toward using photons in quantum computing, if not in light sabers.

In a paper published today in the journal *Science*, the team, led by Vladan Vuletic, the Lester Wolfe Professor of Physics at MIT, and Professor Mikhail Lukin from Harvard University, reports that it has observed groups of three photons interacting and, in effect, sticking together to form a completely new kind of photonic matter.

In controlled experiments, the researchers found that when they shone a very weak laser beam through a dense cloud of ultracold rubidium atoms, rather than exiting the cloud as single, randomly spaced photons, the photons bound together in pairs or triplets, suggesting some kind of interaction - in this case, attraction - taking place among them.

While photons normally have no mass and travel at 300,000 kilometers per second (the speed of light), the researchers found that the bound photons actually acquired a fraction of an electron's mass. These newly weighed-down light particles were also relatively sluggish, traveling about 100,000 times slower than normal noninteracting photons.

Vuletic says the results demonstrate that photons can indeed attract, or entangle each other. If they can be made to interact in other ways, photons may be harnessed to perform extremely fast, incredibly complex quantum computations.

"The interaction of individual photons has been a very long dream for decades," Vuletic says.

Vuletic's co-authors include Qi-Yung Liang, Sergio Cantu, and Travis Nicholson from MIT, Lukin and Aditya Venkatramani of Harvard, Michael Gullans and Alexey Gorshkov of the University of Maryland, Jeff Thompson from Princeton University, and Cheng Ching of the University of Chicago.

Biggering and biggering

Vuletic and Lukin lead the MIT-Harvard Center for Ultracold Atoms, and together they have been looking for ways, both theoretical and experimental, to encourage interactions between photons. In 2013, the effort paid off, as the team observed pairs of photons interacting and binding together for the first time, creating an entirely new state of matter.

In their new work, the researchers wondered whether interactions could take place between not only two photons, but more.

"For example, you can combine oxygen molecules to form O₂ and O₃ (ozone), but not O₄, and for some molecules you can't form even a three-particle molecule," Vuletic says. "So it was an open question: Can you add more photons to a molecule to make bigger and bigger things?"

To find out, the team used the same experimental approach they used to observe two-photon interactions. The process begins with cooling a cloud of rubidium atoms to ultracold temperatures, just a millionth of a degree above absolute zero. Cooling the atoms slows them to a near standstill. Through this cloud of immobilized atoms, the researchers then shine a very weak laser beam - so weak, in fact, that only a handful of photons travel through the cloud at any one time.

The researchers then measure the photons as they come out the other side of the atom cloud. In the new experiment, they found that the photons streamed out as pairs and triplets, rather than exiting the cloud at random intervals, as single photons having nothing to do with each other.

In addition to tracking the number and rate of photons, the team measured the phase of photons, before and after traveling through the atom cloud. A photon's phase indicates its frequency of oscillation.

"The phase tells you how strongly they're interacting, and the larger the phase, the stronger they are bound together," Venkatramani explains. The team observed that as three-photon particles exited the atom cloud simultaneously, their phase was shifted compared to what it was when the photons didn't interact at all, and was three times larger than the phase shift of two-photon molecules. "This means these photons are not just each of them independently interacting, but they're all together interacting strongly."

Memorable encounters

The researchers then developed a hypothesis to explain what might have caused the photons to interact in the first place. Their model, based on physical principles, puts forth the following scenario: As a single photon moves through the cloud of rubidium atoms, it briefly lands on a nearby atom before skipping to another atom, like a bee flitting between flowers, until it reaches the other end.

If another photon is simultaneously traveling through the cloud, it can also spend some time on a rubidium atom, forming a polariton - a hybrid that is part photon, part atom. Then two polaritons can interact with each other via their atomic component. At the edge of the cloud,

the [atoms](#) remain where they are, while the photons exit, still bound together. The researchers found that this same phenomenon can occur with three photons, forming an even stronger bond than the interactions between two photons.

"What was interesting was that these triplets formed at all," Vuletic says. "It was also not known whether they would be equally, less, or more strongly bound compared with [photon](#) pairs."

The entire interaction within the atom cloud occurs over a millionth of a second. And it is this interaction that triggers photons to remain bound together, even after they've left the cloud.

"What's neat about this is, when photons go through the medium, anything that happens in the medium, they 'remember' when they get out," Cantu says.

This means that photons that have interacted with each other, in this case through an attraction between them, can be thought of as strongly correlated, or entangled - a key property for any [quantum computing](#) bit.

"Photons can travel very fast over long distances, and people have been using light to transmit information, such as in optical fibers," Vuletic says. "If photons can influence one another, then if you can entangle these photons, and we've done that, you can use them to distribute quantum information in an interesting and useful way."

Going forward, the team will look for ways to coerce other interactions such as repulsion, where photons may scatter off each other like billiard balls.

"It's completely novel in the sense that we don't even know sometimes qualitatively what to expect," Vuletic says. "With repulsion of photons, can they be such that they form a regular pattern, like a crystal of light? Or will something else happen? It's very uncharted territory." [31]

New hole-punched crystal clears a path for quantum light

Optical highways for light are at the heart of modern communications. But when it comes to guiding individual blips of light called photons, reliable transit is far less common. Now, a collaboration of researchers from the Joint Quantum Institute (JQI), led by JQI Fellows Mohammad Hafezi and Edo Waks, has created a photonic chip that both generates single photons, and steers them around. The device, described in the Feb. 9 issue of *Science*, features a way for the quantum light to seamlessly move, unaffected by certain obstacles.

"This design incorporates well-known ideas that protect the flow of current in certain electrical devices," says Hafezi. "Here, we create an analogous environment for photons, one that protects the integrity of quantum light, even in the presence of certain defects."

The chip starts with a [photonic crystal](#), which is an established, versatile technology used to create roadways for light. They are made by punching holes through a sheet of semiconductor. For photons, the repeated hole pattern looks very much like a real crystal made from a grid of atoms. Researchers use different hole patterns to change the way that light bends and bounces through the crystal. For instance, they can modify the hole sizes and separations to make restricted lanes of travel that allow certain light colors to pass, while prohibiting others.

Sometimes, even in these carefully fabricated devices, there are flaws that alter the light's intended route, causing it to detour into an unexpected direction. But rather than ridding their chips of every flaw, the JQI team mitigates this issue by rethinking the crystal's hole shapes and crystal pattern. In the new chip, they etch out thousands of triangular holes in an array that resembles a bee's honeycomb. Along the center of the device they shift the spacing of the holes, which opens a different kind of travel lane for the light. Previously, these researchers predicted that photons moving along that line of shifted holes should be impervious to certain defects because of the overall crystal structure, or topology. Whether the lane is a switchback road or a straight shot, the light's path from origin to destination should be assured, regardless of the details of the road.

The light comes from small flecks of semiconductor—dubbed quantum emitters—embedded into the photonic crystal. Researchers can use lasers to prod this material into releasing [single photons](#). Each emitter can gain energy by absorbing laser photons and lose energy by later spitting out those photons, one at a time. Photons coming from the two most energetic states of a single emitter are different colors and rotate in opposite directions. For this experiment, the team uses photons from an emitter found near the chip's center.

The team tested the capabilities of the chip by first changing a quantum emitter from its lowest energy state to one of its two higher energy states. Upon relaxing back down, the emitter pops out a photon into the nearby travel lane. They continued this process many times, using photons from the two higher energy states. They saw that photons emitted from the two states preferred to travel in opposite directions, which was evidence of the underlying crystal topology.

To confirm that the design could indeed offer protected lanes of traffic for single photons, the team created a 60 degree turn in the hole pattern. In typical photonic crystals, without built-in protective features, such a kink would likely cause some of the light to reflect backwards or scatter elsewhere. In this new chip, topology protected the photons and allowed them to continue on their way unhindered.

"On the internet, information moves around in packets of light containing many photons, and losing a few doesn't hurt you too much", says co-author Sabyasachi Barik, a graduate student at JQI. "In quantum information processing, we need to protect each individual [photon](#) and make sure it doesn't get lost along the way. Our work can alleviate some forms of loss, even when the device is not completely perfect."

The design is flexible, and could allow researchers to systematically assemble pathways for single photons, says Waks. "Such a modular approach may lead to new types of optical devices and enable tailored interactions between quantum [light](#) emitters or other kinds of matter." [30]

Interference as a new method for cooling quantum devices

Theoretical physicists propose to use negative interference to control heat flow in quantum devices. Their study has been published in *Physical Review Letters*.

Quantum computer parts are sensitive and need to be cooled to very low temperatures. Their size makes them particularly susceptible to temperature increases from the thermal noise in the surrounding environment and that caused by other components nearby. Dr Shabir Barzanjeh, a

postdoc at the Institute of Science and Technology Austria (IST Austria), together with Dr André Xuereb from the University of Malta and Matteo Aquilina from the National Aerospace Centre in Malta has proposed a novel method to keep quantum devices cool. Their theoretical approach relies on quantum interference.

Normally, if a hotter object is placed next to a cooler one, the heat can only flow from the hotter object to the cooler one. Therefore, cooling an object that is already cooler than its surroundings requires energy. A new method for cooling down the elements of quantum devices such as qubits, the tiny building blocks of quantum computers, was now theoretically proven to work by a group of physicists.

"Essentially, the device we are proposing works like a fridge. But here, we are using a quantum mechanical principle to realize it," explains Shabir Barzanjeh, the lead author of the study and postdoc in the research group of Professor Johannes Fink. In their paper, they studied how thermal noise flows through [quantum devices](#) and they devised a method that can prevent the heat flow to warm up the sensitive quantum [device](#). They used a heat sink connected to both devices, showing that it is possible to control its [heat flow](#) such that it cancels the [heat](#) coming from the warm object directly to the cool one via special [quantum](#) interference.

"So far, researchers have focused on controlling the signal, but here, we study the noise. This is quite different, because a signal is coherent, and the noise isn't." Concerning the practical implementation of the mechanism that adds the phase shift to the [thermal noise](#), Shabir Barzanjeh has some ideas, including a mechanical object that vibrates, or radiation pressure to control the oscillation. "Now it is the time for experimentalists to verify the theory," he says. [29]

Learning to speak quantum

In a 1981 lecture, the famed physicist Richard Feynman wondered if a computer could ever simulate the entire universe. The difficulty with this task is that, on the smallest scales, the universe operates under strange rules: Particles can be here and there at the same time; objects separated by immense distances can influence each other instantaneously; the simple act of observing can change the outcome of reality.

"Nature isn't classical, dammit," Feynman told his audience, "and if you want to make a simulation of nature, you'd better make it quantum mechanical."

Quantum computers

Feynman was imagining a quantum computer, a computer with bits that acted like the particles of the quantum world. Today, nearly 40 years later, such computers are starting to become a reality, and they pose a unique opportunity for particle physicists.

"The systems that we deal with in particle physics are intrinsically quantum mechanical systems," says Panagiotis Spentzouris, head of Fermilab's Scientific Computing Division. "Classical computers cannot simulate large entangled quantum systems. You have plenty of problems that we would like

to be able to solve accurately without making approximations that we hope we will be able to do on the quantum computer.”

Quantum computers allow for a more realistic representation of quantum processes. They take advantage of a phenomenon known as superposition, in which a particle such as an electron exists in a probabilistic state spread across multiple locations at once.

Unlike a classical computer bit, which can be either on or off, a quantum bit—or qubit—can be on, off, or a superposition of both on and off, allowing for computations to be performed simultaneously instead of sequentially.

This not only speeds up computations; it makes currently impossible ones possible. A problem that could effectively trap a normal computer in an infinite loop, testing possibility after possibility, could be solved almost instantaneously by a quantum computer. This processing speed could be key for particle physicists, who wade through enormous amounts of data generated by detectors.

In the first demonstration of this potential, a team at CalTech recently used a type of quantum computer called a quantum annealer to “rediscover” the Higgs boson, the particle that, according to the Standard Model of particle physics, gives mass to every other fundamental particle.

Scientists originally discovered the Higgs boson in 2012 using particle detectors at the Large Hadron Collider at CERN research center in Europe. They created Higgs bosons by converting the energy of particle collisions temporarily into matter. Those temporary Higgs bosons quickly decayed, converting their energy into other, more common particles, which the detectors were able to measure.

Scientists identified the mass of the Higgs boson by adding up the masses of those less massive particles, the decay products. But to do so, they needed to pick out which of those particles came from the decay of Higgs bosons, and which ones came from something else. To a detector, a Higgs boson decay can look remarkably similar to other, much more common decays.

LHC scientists trained a machine learning algorithm to find the Higgs signal against the decay background—the needle in the haystack. This training process required a huge amount of simulated data.

Physicist Maria Spiropulu, who was on the team that discovered the Higgs the first time around, wanted to see if she could improve the process with quantum computing. The group she leads at CalTech used a quantum computer from a company called D-Wave to train a similar machine learning algorithm. They found that the quantum computer trained the machine learning algorithm on a significantly smaller amount of data than the classical method required. In theory, this would give the algorithm a head start, like giving someone looking for the needle in the haystack expert training in spotting the glint of metal before turning their eyes to the hay.

“The machine cannot learn easily,” Spiropulu says. “It needs huge, huge data. In the quantum annealer, we have a hint that it can learn with small data, and if you learn with small data you can use it as initial conditions later.”

Some scientists say it may take a decade or more to get to the point of using quantum computers regularly in particle physics, but until then they will continue to make advances to enhance their research.

Quantum sensors

Quantum mechanics is also disrupting another technology used in particle physics: the sensor, the part of a particle detector that picks up the energy from a particle interaction.

In the quantum world, energy is discrete. The noun quantum means “a specific amount” and is used in physics to mean “the smallest quantity of energy.” Classical sensors generally do not make precise enough measurements to pick up individual quanta of energy, but a new type of quantum sensor can.

“A quantum sensor is one that is able to sense these individual packets of energy as they arrive,” says Aaron Chou, a scientist at Fermilab. “A non-quantum sensor would not be able to resolve the individual arrivals of each of these little packets of energy, but would instead measure a total flow of the stuff.”

Chou is taking advantage of these quantum sensors to probe the nature of dark matter. Using technology originally developed for quantum computers, Chou and his team are building ultrasensitive detectors for a type of theorized dark matter particle known as an axion.

“We’re taking one of the qubit designs that was previously created for quantum computing and we’re trying to use those to sense the presence of photons that came from the dark matter,” Chou says.

For Spiropulu, these applications of quantum computers represent an elegant feedback system in the progression of technology and scientific application. Basic research in physics led to the initial transistors that fed the computer science revolution, which is now on the edge of transforming basic research in physics.

“You want to disrupt computing, which was initially a physics advance,” Spiropulu says. “Now we are using physics configurations and physics systems themselves to assist computer science to solve any problem, including physics problems.” [28]

Researchers developing phase-change memory devices for more powerful computing

A collaboration between the lab of Judy Cha, the Carol and Douglas Melamed Assistant Professor of Mechanical Engineering & Materials Science, and IBM's Watson Research Center could help make a potentially revolutionary technology more viable for manufacturing.

Phase-change memory (PCM) devices have in recent years emerged as a game-changing alternative to computer random-access memory. Using heat to transform the states of material from amorphous to crystalline, PCM chips are fast, use much less power and have the potential to scale down to smaller chips – allowing the trajectory for smaller, more powerful computing to continue.

However, manufacturing PCM devices on a large scale with consistent quality and long endurance has been a challenge.

"Everybody's trying to figure that out, and we want to understand the [phase change](#) behavior precisely," said Yujun Xie, a PhD candidate in Cha's lab and lead author of the study. "That's one of the biggest challenges for [phase-change memory](#)."

The work of the Yale-IBM research team could help clear this hurdle. Using in situ transmission electron microscopy (TEM) at the Yale Institute for Nanoscience and Quantum Engineering (YINQE), they observed the device's phase change and how it "self-heals" voids - that is, empty spaces left by the depletion of [materials](#) caused by chemical segregation. These kinds of nanoscale voids have caused problems for previous PCM devices. Their results on self-healing of voids are published in *Advanced Materials*.

The standard PCM device has what's known as a mushroom structure, while the Yale-IBM team used a confined PCM structure with a metallic lining to make it more robust. "The metallic liner protects the material and reduces the resistance drift of the PCM, improving the whole performance," Xie said.

By observing the phase-change process through TEM, the researchers saw how the PCM device's self-healing properties come from a combination of the device's structure and the metallic lining, which allow it to control the phase-change of the material.

Wanki Kim, an IBM researcher who worked on the project, said the next step is possibly to develop a bipolar operation to switch the direction of voltage, which can control the chemical segregation. In normal operation mode, the direction of voltage bias is always the same. This next step could prolong the [device](#) lifetime even further. [27]

New controls scale quantum chips

A fundamental barrier to scaling quantum computing machines is "qubit interference." In new research published in *Science Advances*, engineers and physicists from [Rigetti Computing](#) describe a breakthrough that can expand the size of practical quantum processors by reducing interference.

Matt Reagor, lead author of the paper, says, "We've developed a technique that enables us to reduce interference between qubits as we add more and more qubits to a chip, thus retaining the ability to perform logical operations that are independent of the state of a (large) quantum register."

To explain the concept, the Rigetti team employs [wine glasses](#) as an analogy to qubits:

Clink a wine glass, and you will hear it ring at its resonant [frequency](#) (usually around 400 Hz). Likewise, soundwaves at that frequency will cause the same glass to vibrate. Different shapes or amounts of liquid in a glass will produce different clinks, i.e. different resonance frequencies. A

clinked wine glass will cause identical, nearby glasses to vibrate. Glasses that are different shapes are "off-resonant glasses," meaning they will not vibrate much at all.

So, what's the relation between glasses and qubits?

Reagor explains that each physical qubit on a superconducting quantum processor stores energy in the form of an oscillating electric current. "Think of each qubit as a wine glass," he says. "The logical state of a qubit (e.g. "0" or "1") is encoded by the state of its corresponding electric currents. In our analogy, this is equivalent to whether or not a wine glass is vibrating."

A highly successful class of entangling gates for superconducting qubits operates by tuning two or more qubits into resonance with each other. At this tuning point, the "wine glasses" pick up on one another's "vibrations."

This effect can be strong enough to produce significant, conditional vibration changes that can be leveraged as conditional logic. Imagine pouring or siphoning off wine from one of the glasses to make this tuning happen. With qubits, there are tunable circuit elements that fulfill the same purpose.

"As we scale up quantum processors, there are more and more wine glasses to manage when executing a specific conditional logic gate," says Reagor. "Imagine lining up a handful of identical glasses with increasing amounts of wine. Now we want to tune one glass into resonance with another, without disturbing any of the other glasses. To do that, you could try to equalize the wine levels of the glasses. But that transfer needs to be instantaneous to not shake the rest of the glasses along the way. Let's say one glass has a resonance at one frequency (call it 400 Hz) while another, nearby glass has a different one (e.g. 380 Hz). Now, we make use of a somewhat subtle musical effect. We are actually going to fill and deplete one of the glasses repeatedly."

He continues: "We repeat that filling operation at the difference frequency between the glasses (here, 20 times per second, or 20 Hz). By doing so, we create a beat-note for this glass that is exactly resonant with the other. Physicists sometimes call this a parametric process. Our beat-note is "pure"—it does not have frequency content that interferes with the other glasses. That's what we have demonstrated in our recent work, where we navigated a complex eight-qubit processor with parametric two-qubit gates."

Reagor concludes: "While this analogy may sound somewhat fanciful, its mapping onto our specific technology, from a mathematical standpoint, is surprisingly accurate." [26]

Controlling quantum interactions in a single material

The search and manipulation of novel properties emerging from the quantum nature of matter could lead to next-generation electronics and quantum computers. But finding or designing materials that can host such quantum interactions is a difficult task.

"Harmonizing multiple quantum mechanical properties, which often do not coexist together, and trying to do it by design is a highly complex challenge," said Northwestern University's James Rondinelli.

But Rondinelli and an international team of theoretical and computational researchers have done just that. Not only have they demonstrated that multiple quantum interactions can coexist in a single material, the team also discovered how an electric field can be used to control these interactions to tune the material's properties.

This breakthrough could enable ultrafast, low-power electronics and quantum computers that operate incredibly faster than current models in the areas of data acquisition, processing, and exchange.

Supported by the US Army Research Office, National Science Foundation of China, German Research Foundation, and China's National Science Fund for Distinguished Young Scholars, the research was published online today in the journal *Nature Communications*. James Rondinelli, the Morris E. Fine Junior Professor in Materials and Manufacturing in Northwestern's McCormick School of Engineering, and Cesare Franchini, professor of quantum materials modeling at the University of Vienna, are the paper's co-corresponding authors. Jiangang He, a postdoctoral fellow at Northwestern, and Franchini served as the paper's co-first authors.

Quantum mechanical interactions govern the capability of and speed with which electrons can move through a material. This determines whether a material is a conductor or insulator. It also controls whether or not the material exhibits ferroelectricity, or shows an electrical polarization.

"The possibility of accessing multiple order phases, which rely on different quantum-mechanical interactions in the same material, is a challenging fundamental issue and imperative for delivering on the promises that quantum information sciences can offer," Franchini said.

Using computational simulations performed at the Vienna Scientific Cluster, the team discovered coexisting quantum-mechanical interactions in the compound silver-bismuth-oxide. Bismuth, a post-transition metal, enables the spin of the electron to interact with its own motion—a feature that has no analogy in classical physics. It also does not exhibit inversion symmetry, suggesting that ferroelectricity should exist when the material is an electrical insulator. By applying an electric field to the material, researchers were able to control whether the electron spins were coupled in pairs (exhibiting Weyl-fermions) or separated (exhibiting Rashba-splitting) as well as whether the system is electrically conductive or not.

"This is the first real case of a topological quantum transition from a ferroelectric insulator to a non-ferroelectric semi-metal," Franchini said. "This is like awakening a different kind of quantum interactions that are quietly sleeping in the same house without knowing each other." [25]

Scientists discover chiral phonons in a 2-D semiconductor crystal

A research team from the Department of Energy's Lawrence Berkeley National Laboratory (Berkeley Lab) has found the first evidence that a shaking motion in the structure of an atomically thin (2-D) material possesses a naturally occurring circular rotation.

This rotation could become the building block for a new form of information technology, and for the design of molecular-scale rotors to drive microscopic motors and machines.

The monolayer material, tungsten diselenide (WSe₂), is already well-known for its unusual ability to sustain special electronic properties that are far more fleeting in other [materials](#).

It is considered a promising candidate for a sought-after form of data storage known as valleytronics, for example, in which the momentum and wavelike motion of electrons in a material can be sorted into opposite "valleys" in a material's electronic structure, with each of these valleys representing the ones and zeroes in conventional binary data.

Modern electronics typically rely on manipulations of the charge of electrons to carry and store information, though as electronics are increasingly miniaturized they are more subject to problems associated with heat buildup and electric leaks.

The latest study, published online this week in the journal *Science*, provides a possible path to overcome these issues. It reports that some of the material's phonons, a term describing collective vibrations in atomic crystals, are naturally rotating in a certain direction.

This property is known as chirality – similar to a person's handedness where the left and right hand are a mirror image of each other but not identical. Controlling the direction of this rotation would provide a stable mechanism to carry and store information.

"Phonons in solids are usually regarded as the collective linear motion of atoms," said Xiang Zhang, the corresponding author of the study and senior scientist of the Materials Science Division at Lawrence Berkeley National Laboratory and professor at UC Berkeley. "Our experiment discovered a new type of so-called chiral phonons where atoms move in circles in an atomic monolayer crystal of [tungsten diselenide](#)."



This diagram maps out atomic motion in separate phonon modes. At left ("LO" represents a longitudinal optical mode), selenium atoms exhibit a clockwise rotation while tungsten atoms stand still. At right ("LA" represents a longitudinal ...[more](#)

Hanyu Zhu, the lead author of the study and a postdoctoral researcher at Zhang's group, said, "One of the biggest advantage of chiral [phonon](#) is that the rotation is locked with the particle's momentum and not easily disturbed."

In the phonon mode studied, the selenium atoms appear to collectively rotate in a clockwise direction, while the tungsten atoms showed no motion. Researchers prepared a "sandwich" with four sheets of centimeter-sized monolayer WSe₂ samples placed between thin sapphire crystals. They synced ultrafast lasers to record the time-dependent motions.

The two laser sources converged on a spot on the samples measuring just 70 millionths of a meter in diameter. One of the lasers was precisely switched between two different tuning modes to sense the difference of left and right chiral phonon activity.

A so-called pump laser produced visible, red-light pulses that excited the samples, and a probe laser produced mid-infrared pulses that followed the first pump pulse within one trillionth of a second. About one mid-infrared photon in every 100 million is absorbed by WSe₂ and converted to a chiral phonon.

The researchers then captured the high-energy luminescence from the sample, a signature of this rare absorption event. Through this technique, known as transient infrared spectroscopy, researchers not only confirmed the existence of a chiral phonon but also accurately obtained its rotational frequency.

So far, the process only produces a small number of chiral phonons. A next step in the research will be to generate larger numbers of rotating phonons, and to learn whether vigorous agitations in the crystal can be used to flip the spin of electrons or to significantly alter the valley properties of the material. Spin is an inherent property of an electron that can be thought of as its compass needle – if it could be flipped to point either north or south it could be used to convey information in a new form of electronics called spintronics.

"The potential phonon-based control of electrons and spins for device applications is very exciting and within reach," Zhu said. "We already proved that phonons are capable of switching the electronic valley. In addition, this work allows the possibility of using the rotating atoms as little magnets to guide the spin orientation."

The chiral properties found in the study likely exist across a wide range of 2-D materials based on a similar patterning in their atomic structure, Zhu also noted, adding that the study could guide theoretical investigations of electron-phonon interactions and the design of materials to enhance phonon-based effects.

"The same principle works in all 2-D periodic structures with three-fold symmetry and inversion asymmetry" Zhu said. "The same principle covers a huge family of natural materials, and there are almost infinite possibilities for creating rotors at the molecular scale." [24]

New exotic phenomena seen in photonic crystals

Topological effects, such as those found in crystals whose surfaces conduct electricity while their bulk does not, have been an exciting topic of physics research in recent years and were the subject of the 2016 Nobel Prize in physics. Now, a team of researchers at MIT and elsewhere has found novel topological phenomena in a different class of systems—open systems, where energy or material can enter or be emitted, as opposed to closed systems with no such exchange with the outside.

This could open up some new realms of basic physics research, the team says, and might ultimately lead to new kinds of lasers and other technologies.

The results are being reported this week in the journal *Science*, in a paper by recent MIT graduate Hengyun "Harry" Zhou, MIT visiting scholar Chao Peng (a professor at Peking University), MIT graduate student Yoseob Yoon, recent MIT graduates Bo Zhen and Chia Wei Hsu, MIT Professor Marin Soljačić, the Francis Wright Davis Professor of Physics John Joannopoulos, the Haslam and Dewey Professor of Chemistry Keith Nelson, and the Lawrence C. and Sarah W. Biedenharn Career Development Assistant Professor Liang Fu.

In most research in the field of topological physical effects, Soljačić says, so-called "open" systems—in physics terms, these are known as non-Hermitian systems—were not studied much in experimental work. The complexities involved in measuring or analyzing phenomena in which energy or matter can be added or lost through radiation generally make these systems more difficult to study and analyze in a controlled fashion.

But in this work, the team used a method that made these open systems accessible, and "we found interesting topological properties in these non-Hermitian systems," Zhou says. In particular, they found two specific kinds of effects that are distinctive topological signatures of non-Hermitian systems. One of these is a kind of band feature they refer to as a bulk Fermi arc, and the other is an unusual kind of changing polarization, or orientation of light waves, emitted by the photonic crystal used for the study.

Photonic crystals are materials in which billions of very precisely shaped and oriented tiny holes are made, causing light to interact in unusual ways with the material. Such crystals have been actively studied for the exotic interactions they induce between light and matter, which hold the potential for new kinds of light-based computing systems or light-emitting devices. But while much of this research has been done using closed, Hermitian systems, most of the potential real-world applications involve open systems, so the new observations made by this team could open up whole new areas of research, the researchers say.

Fermi arcs, one of the unique phenomena the team found, defy the common intuition that energy contours are necessarily closed curves. They have been observed before in closed systems, but in those systems they always form on the two-dimensional surfaces of a three-dimensional system. In the new work, for the first time, the researchers found a Fermi arc that resides in the bulk of a system. This bulk Fermi arc connects two points in the emission directions, which are known as exceptional points—another characteristic of open topological systems.

The other phenomenon they observed consists of a field of light in which the polarization changes according to the emission direction, gradually forming a half-twist as one follows the direction along a loop and returns back to the starting point. "As you go around this crystal, the polarization of the light actually flips," Zhou says.

This half-twist is analogous to a Möbius strip, he explains, in which a strip of paper is twisted a half-turn before connecting it to its other end, creating a band that has only one side. This Möbius-like twist in light polarization, Zhen says, could in theory lead to new ways of increasing the amount of data that could be sent through fiber-optic links.

The new work is "mostly of scientific interest, rather than technological," Soljačić says. Zhen adds that "now we have this very interesting technique to probe the properties of non-Hermitian systems." But there is also a possibility that the work may ultimately lead to new devices, including new kinds of lasers or light-emitting devices, they say.

The new findings were made possible by [earlier research](#) by many of the same team members, in which they found a way to use light scattered from a photonic crystal to produce direct images that reveal the energy contours of the material, rather than having to calculate those contours indirectly.

"We had a hunch" that such half-twist behavior was possible and could be "quite interesting," Soljačić says, but actually finding it required "quite a bit of searching to figure out, how do we make it happen?"

"Perhaps the most ingenious aspect of this work is that the authors use the fact that their system must necessarily lose photons, which is usually an obstacle and annoyance, to access new topological physics," says Mikael Rechtsman, an assistant professor of physics at Pennsylvania State University who was not involved in this work. "Without the loss ... this would have required highly complex 3-D fabrication methods that likely would not have been possible." In other words, he says, the technique they developed "gave them access to 2-D physics that would have been conventionally thought impossible." [23]

Photonic crystals reveal their internal characteristics with new method

A new technique developed by MIT researchers reveals the inner details of photonic crystals, synthetic materials whose exotic optical properties are the subject of widespread research.

Photonic crystals are generally made by drilling millions of closely spaced, minuscule holes in a slab of transparent material, using variations of microchip-fabrication methods. Depending on the exact orientation, size, and spacing of these holes, these materials can exhibit a variety of peculiar optical properties, including "superlensing," which allows for magnification that pushes beyond the normal theoretical limits, and "negative refraction," in which light is bent in a direction opposite to its path through normal transparent materials.

But to understand exactly how light of various colors and from various directions moves through photonic crystals requires extremely complex calculations. Researchers often use highly simplified approaches; for example they may only calculate the behavior of light along a single direction or for a single color.

Instead, the new technique makes the full range of information directly visible. Researchers can use a straightforward laboratory setup to display the information—a pattern of so-called "iso-frequency contours"—in a graphical form that can be simply photographed and examined, in many cases eliminating the need for calculations. The method is described this week in the journal *Science Advances*, in a paper by MIT postdoc Bo Zhen, recent Wellesley College graduate and MIT affiliate Emma Regan, MIT professors of physics Marin Soljacic and John Joannopoulos, and four others.

The discovery of this new technique, Zhen explains, came about by looking closely at a phenomenon that the researchers had noticed and even made use of for years, but whose origins they hadn't previously understood. Patterns of scattered light seemed to fan out from samples of photonic materials when the samples were illuminated by laser light. The scattering was surprising, since the underlying crystalline structure was fabricated to be almost perfect in these materials.

"When we would try to do a lasing measurement, we would always see this pattern," Zhen says. "We saw this shape, but we didn't know what was happening." But it did help them to get their experimental setup properly aligned, because the scattered light pattern would appear as soon as the laser beam was properly lined up with the crystal. Upon careful analysis, they realized the

scattering patterns were generated by tiny defects in the crystal—holes that were not perfectly round in shape or that were slightly tapered from one end to the other.

"There is fabrication disorder even in the best samples that can be made," Regan says. "People think that the scattering would be very weak, because the sample is nearly perfect," but it turns out that at certain angles and frequencies, the light scatters very strongly; as much as 50 percent of the incoming light can be scattered. By illuminating the sample in turn with a sequence of different colors, it is possible to build up a full display of the relative paths light beams take, all across the visible spectrum. The scattered light produces a direct view of the iso-frequency contours—a sort of topographic map of the way light beams of different colors bend as they pass through the photonic crystal.

"This is a very beautiful, very direct way to observe the iso-frequency contours," Soljacic says. "You just shine light at the sample, with the right direction and frequency," and what comes out is a direct image of the needed information, he says.

The finding could potentially be useful for a number of different applications, the team says. For example, it could lead to a way of making large, transparent display screens, where most light would pass straight through as if through a window, but light of specific frequencies would be scattered to produce a clear image on the screen. Or, the method could be used to make private displays that would only be visible to the person directly in front of the screen.

Because it relies on imperfections in the fabrication of the crystal, this method could also be used as a quality-control measure for manufacturing of such materials; the images provide an indication of not only the total amount of imperfections, but also their specific nature—that is, whether the dominant disorder in the sample comes from noncircular holes or etches that aren't straight—so that the process can be tuned and improved.

The team also included researchers at MIT Research Laboratory of Electronics, including Yuichi Igarashi (now at NEC Corporation in Japan), Ido Kaminer, Chia Wei Hsu (now at Yale University), and Yichen Shen. The work was supported by the Army Research Office through the Institute for Soldier Nanotechnologies at MIT, and by the U.S. Department of Energy through S3TEC, an Energy Frontier Center. [22]

New tabletop technique probes outermost electrons of atoms deep inside solids

It may be unwise to judge a book by its cover, but you can tell a lot about a material from the outermost electrons in its atoms.

"These outermost electrons, known as valence electrons, are the most important players in forming chemical bonds and actually define almost every property of a solid – electrical, thermal, conductive," said Shambhu Ghimire, an associate staff scientist at the Department of Energy's SLAC National Accelerator Laboratory.

Now Ghimire and two colleagues at the Stanford PULSE Institute have invented a new way to probe the valence electrons of atoms deep inside a crystalline solid.

In a report today in *Nature Physics*, they describe using laser light to excite some of the valence electrons, steer them around inside the crystal and bounce them off other atoms. This produces high-energy bursts of light that are invisible to our eyes, but carry clues to the material's atomic structure and function.

"This will change the world of imaging the inside of crystalline solids," Ghimire said, "much as scanning tunneling microscopy, or STM, changed the atomic-scale imaging of surfaces."

A New Way to Look at Atoms in Solids

Invented in the early 1980s, STM was a revolutionary method that allowed scientists to make the first images of individual atoms and their bonds. It was honored with the 1986 Nobel Prize in physics.

But STM senses valence electrons from only the top two or three layers of atoms in a material. A flow of those electrons into the instrument's tip creates a current that allows it to measure the distance between the tip and the surface, tracing the bumps where atoms poke up and the valleys between them. This creates an image of the atoms and yields information about the bonds that hold them together.

Now the new technique will give scientists the same level of access to the valence electrons deep inside the solid.

The experiments, carried out in a SLAC laser lab by PULSE postdoctoral researcher Yong Sing You, involved crystals of magnesium oxide or magnesia, a common mineral used to make cement, preserve library books and clean up contaminated soil, among a host of other things.

These crystals also have the ability to shift incoming laser light to much shorter wavelengths and higher energies – much as pressing down on a guitar string produces a higher note – through a process called high harmonic generation, or HHG.

Steering Electrons to Generate Light

In this case, the scientists carefully adjusted the incoming infrared laser beam so it would excite valence electrons in the crystal's oxygen atoms. Those electrons oscillated, like vibrating guitar strings, and generated light of much shorter wavelengths – in the extreme ultraviolet range – through HHG.

But when they adjusted the polarization of the laser beam to steer the excited electrons along different trajectories within the crystal, they discovered that HHG only took place when an electron hit a neighboring atom, and was most efficient when it hit the atom dead center. Further, the wavelength of the harmonically generated light coming out – which was 13 to 21 times shorter than the light that went in – revealed the density of the neighboring atom's valence electrons, the size of the atom and even whether it was an atom of oxygen or magnesium.

"It's difficult to home in on the valence electrons with current methods of measuring electron charge density, which typically use X-ray or electron diffraction," said study co-author David Reis,

an associate professor at SLAC and Stanford and deputy director of PULSE. "So demonstrating that we can do that with atomic-scale sensitivity in a tabletop laser experiment is an important milestone."

Alan Fry, division director for laser science and technology at SLAC's Linac Coherent Light Source X-ray laser, was not involved in the experiment but offered kudos "to the team that developed this technique and who continue to do exciting and interesting research with it."

While this approach may be limited to materials that can generate light through HHG, he said, "it can still tell you a lot about the electronic structure inside those solids, and in principle could give us a better understanding of other materials that don't have same response. Understanding simple systems like this builds a foundation for understanding more complex systems." [21]

X-ray laser glimpses how electrons dance with atomic nuclei in materials

From hard to malleable, from transparent to opaque, from channeling electricity to blocking it: Materials come in all types. A number of their intriguing properties originate in the way a material's electrons "dance" with its lattice of atomic nuclei, which is also in constant motion due to vibrations known as phonons.

This coupling between electrons and phonons determines how efficiently solar cells convert sunlight into electricity. It also plays key roles in superconductors that transfer electricity without losses, topological insulators that conduct electricity only on their surfaces, materials that drastically change their electrical resistance when exposed to a magnetic field, and more.

At the Department of Energy's SLAC National Accelerator Laboratory, scientists can study these coupled motions in unprecedented detail with the world's most powerful X-ray laser, the Linac Coherent Light Source (LCLS). LCLS is a DOE Office of Science User Facility.

"It has been a long-standing goal to understand, initiate and control these unusual behaviors," says LCLS Director Mike Dunne. "With LCLS we are now able to see what happens in these materials and to model complex electron-phonon interactions. This ability is central to the lab's mission of developing new materials for next-generation electronics and energy solutions."

LCLS works like an extraordinary strobe light: Its ultrabright X-rays take snapshots of materials with atomic resolution and capture motions as fast as a few femtoseconds, or millionths of a billionth of a second. For comparison, one femtosecond is to a second what seven minutes is to the age of the universe.

Two recent studies made use of these capabilities to study electron-phonon interactions in lead telluride, a material that excels at converting heat into electricity, and chromium, which at low temperatures has peculiar properties similar to those of high-temperature superconductors.

Turning Heat into Electricity and Vice Versa

Lead telluride, a compound of the chemical elements lead and tellurium, is of interest because it is a good thermoelectric: It generates an electrical voltage when two opposite sides of the material have different temperatures.

"This property is used to power NASA space missions like the Mars rover Curiosity and to convert waste heat into electricity in high-end cars," says Mariano Trigo, a staff scientist at the Stanford PULSE Institute and the Stanford Institute for Materials and Energy Sciences (SIMES), both joint institutes of Stanford University and SLAC. "The effect also works in the opposite direction: An electrical voltage applied across the material creates a temperature difference, which can be exploited in thermoelectric cooling devices."

Mason Jiang, a recent graduate student at Stanford, PULSE and SIMES, says, "Lead telluride is exceptionally good at this. It has two important qualities: It's a bad thermal conductor, so it keeps heat from flowing from one side to the other, and it's also a good electrical conductor, so it can turn the temperature difference into an electric current. The coupling between lattice vibrations, caused by heat, and electron motions is therefore very important in this system. With our study at LCLS, we wanted to understand what's naturally going on in this material."

In their experiment, the researchers excited electrons in a lead telluride sample with a brief pulse of infrared laser light, and then used LCLS's X-rays to determine how this burst of energy stimulated lattice vibrations.

"Lead telluride sits at the precipice of a coupled electronic and structural transformation," says principal investigator David Reis from PULSE, SIMES and Stanford.

"It has a tendency to distort without fully transforming – an instability that is thought to play an important role in its thermoelectric behavior. With our method we can study the forces involved and literally watch them change in response to the infrared laser pulse."

The scientists found that the light pulse excites particular electronic states that are responsible for this instability through electron-phonon coupling. The excited electrons stabilize the material by weakening certain long-range forces that were previously associated with the material's low thermal conductivity.

"The light pulse actually walks the material back from the brink of instability, making it a worse thermoelectric," Reis says. "This implies that the reverse is also true – that stronger long-range forces lead to better thermoelectric behavior."

The researchers hope their results, published July 22 in Nature Communications, will help them find other thermoelectric materials that are more abundant and less toxic than lead telluride.

Controlling Materials by Stimulating Charged Waves

The second study looked at charge density waves – alternating areas of high and low electron density across the nuclear lattice – that occur in materials that abruptly change their behavior at a certain threshold. This includes transitions from insulator to conductor, normal conductor to superconductor, and from one magnetic state to another.

These waves don't actually travel through the material; they are stationary, like icy waves near the shoreline of a frozen lake.

"Charge density waves have been observed in a number of interesting materials, and establishing their connection to material properties is a very hot research topic," says Andrej Singer, a postdoctoral fellow in Oleg Shpyrko's lab at the University of California, San Diego. "We've now shown that there is a way to enhance charge density waves in crystals of chromium using laser light, and this method could potentially also be used to tweak the properties of other materials."

This could mean, for example, that scientists might be able to switch a material from a normal conductor to a superconductor with a single flash of light. Singer and his colleagues reported their results on July 25 in *Physical Review Letters*.

The research team used the chemical element chromium as a simple model system to study charge density waves, which form when the crystal is cooled to about minus 280 degrees Fahrenheit. They stimulated the chilled crystal with pulses of optical laser light and then used LCLS X-ray pulses to observe how this stimulation changed the amplitude, or height, of the charge density waves.

"We found that the amplitude increased by up to 30 percent immediately after the laser pulse," Singer says. "The amplitude then oscillated, becoming smaller and larger over a period of 450 femtoseconds, and it kept going when we kept hitting the sample with laser pulses. LCLS provides unique opportunities to study such process because it allows us to take ultrafast movies of the related structural changes in the lattice."

Based on their results, the researchers suggested a mechanism for the amplitude enhancement: The light pulse interrupts the electron-phonon interactions in the material, causing the lattice to vibrate. Shortly after the pulse, these interactions form again, which boosts the amplitude of the vibrations, like a pendulum that swings farther out when it receives an extra push.

A Bright Future for Studies of the Electron-Phonon Dance

Studies like these have a high priority in solid-state physics and materials science because they could pave the way for new materials and provide new ways to control material properties.

With its 120 ultrabright X-ray pulses per second, LCLS reveals the electron-phonon dance with unprecedented detail. More breakthroughs in the field are on the horizon with LCLS-II – a next-generation X-ray laser under construction at SLAC that will fire up to a million X-ray flashes per second and will be 10,000 times brighter than LCLS.

"LCLS-II will drastically increase our chances of capturing these processes," Dunne says. "Since it will also reveal subtle electron-phonon signals with much higher resolution, we'll be able to study these interactions in much greater detail than we can now." [20]

A 'nonlinear' effect that seemingly turns materials transparent is seen for the first time in X-rays at SLAC's LCLS

Imagine getting a medical X-ray that comes out blank – as if your bones had vanished. That's what happened when scientists cranked up the intensity of the world's first X-ray laser, at the

Department of Energy's SLAC National Accelerator Laboratory, to get a better look at a sample they were studying: The X-rays seemed to go right through it as if it were not there.

This result was so weird that the leader of the experiment, SLAC Professor Joachim Stöhr, devoted the next three years to developing a theory that explains why it happened. Now his team has published a paper in Physical Review Letters describing the 2012 experiment for the first time.

What they saw was a so-called nonlinear effect where more than one photon, or particle of X-ray light, enters a sample at the same time, and they team up to cause unexpected things to happen.

"In this case, the X-rays wiggled electrons in the sample and made them emit a new beam of X-rays that was identical to the one that went in," said Stöhr, who is an investigator with the Stanford Institute for Materials and Energy Sciences at SLAC. "It continued along the same path and hit a detector. So from the outside, it looked like a single beam went straight through and the sample was completely transparent."

This effect, called "stimulated scattering," had never been seen in X-rays before. In fact, it took an extremely intense beam from SLAC's Linac Coherent Light Source (LCLS), which is a billion times brighter than any X-ray source before it, to make this happen.

A Milestone in Understanding How Light Interacts with Matter

The observation is a milestone in the quest to understand how light interacts with matter, Stöhr said.

"What will we do with it? I think we're just starting to learn. This is a new phenomenon and I don't want to speculate," he said. "But it opens the door to controlling the electrons that are closest to the core of atoms – boosting them into higher orbitals, and driving them back down in a very controlled manner, and doing this over and over again."

Nonlinear optical effects are nothing new. They were discovered in the 1960s with the invention of the laser – the first source of light so bright that it could send more than one photon into a sample at a time, triggering responses that seemed all out of proportion to the amount of light energy going in. Scientists use these effects to shift laser light to much higher energies and focus optical microscopes on much smaller objects than anyone had thought possible.

The 2009 opening of LCLS as a DOE Office of Science User Facility introduced another fundamentally new tool, the X-ray free-electron laser, and scientists have spent a lot of time since then figuring out exactly what it can do. For instance, a SLAC-led team recently published the first report of nonlinear effects produced by its brilliant pulses.

"The X-ray laser is really a quantum leap, the equivalent of going from a light bulb to an optical laser," Stöhr said. "So it's not just that you have more X-rays. The interaction of the X-rays with the sample is very different, and there are effects you could never see at other types of X-ray light sources."

A Most Puzzling Result

Stöhr stumbled on this latest discovery by accident. Then director of LCLS, he was working with

Andreas Scherz, a SLAC staff scientist, who is now with the soon-to-open European XFEL in Hamburg, Germany, and Stanford graduate student Benny Wu to look at the fine structure of a common magnetic material used in data storage.

To enhance the contrast of their image, they tuned the LCLS beam to a wavelength that would resonate with cobalt atoms in the sample and amplify the signal in their detector. The initial results looked great. So they turned up the intensity of the laser beam in the hope of making the images even sharper.

That's when the speckled pattern they'd been seeing in their detector went blank, as if the sample had disappeared.

"We thought maybe we had missed the sample, so we checked the alignment and tried again," Stöhr said. "But it kept happening. We knew this was strange – that there was something here that needed to be understood."

Stöhr is an experimentalist, not a theorist, but he was determined to find answers. He and Scherz dove deeply into the scientific literature. Meanwhile Wu finished his PhD thesis, which described the experiment and its unexpected result, and went on to a job in industry. But the team held off on publishing their experimental results in a scientific journal until they could explain what happened. Stöhr and Scherz published their explanation last fall in *Physical Review Letters*.

"We are developing a whole new field of nonlinear X-ray science, and our study is just one building block in this field," Stöhr said. "We are basically opening Pandora's box, learning about all the different nonlinear effects, and eventually some of those will turn out to be more important than others." [19]

Researchers use quantum dots to manipulate light

Leiden physicists have manipulated light with large artificial atoms, so-called quantum dots. Before, this has only been accomplished with actual atoms. It is an important step toward light-based quantum technology. The study was published on August 30th in *Nature Communications*.

When you point a laser pointer at the screen during a presentation, an immense number of light particles races through the air at a billion kilometers per hour. They don't travel in a continuous flow, but in packages containing varying numbers of particles. Sometimes as many as four so-called photons pass by, and other times none at all. You won't notice this during your presentation, but for light-based quantum technology, it is crucial that scientists have control over the number of photons per package.

Quantum dots

In theory, you can manipulate photons with real individual atoms, but because of their small size, it is extremely hard to work with them. Now, Leiden physicists have discovered that the same principle goes for large artificial atoms—so-called quantum dots—that are much easier to handle. In fact, they managed to filter light beams with one photon per package out of a laser. "Another big advantage of quantum dots is that the system already works within nanoseconds," says first author

Henk Snijders. "With atomic systems, you need microseconds, so a thousand times longer. This way, we can manipulate photons much faster."

Quantum cryptography

The ultimate goal for the research group led by Prof. Dirk Bouwmeester is to entangle many photons using quantum dots. This is essential, for example, in techniques like quantum cryptography. Snijders: "This research shows that we are already able to manipulate individual photons with our system. And the beauty is that in principle, we don't need large experimental setups. We can just integrate our quantum dots in small microchips." [18]

'Artificial atom' created in graphene

In a tiny quantum prison, electrons behave quite differently as compared to their counterparts in free space. They can only occupy discrete energy levels, much like the electrons in an atom - for this reason, such electron prisons are often called "artificial atoms". Artificial atoms may also feature properties beyond those of conventional ones, with the potential for many applications for example in quantum computing. Such additional properties have now been shown for artificial atoms in the carbon material graphene. The results have been published in the journal Nano Letters, the project was a collaboration of scientists from TU Wien (Vienna, Austria), RWTH Aachen (Germany) and the University of Manchester (GB).

Building Artificial Atoms

"Artificial atoms open up new, exciting possibilities, because we can directly tune their properties", says Professor Joachim Burgdörfer (TU Wien, Vienna). In semiconductor materials such as gallium arsenide, trapping electrons in tiny confinements has already been shown to be possible. These structures are often referred to as "quantum dots". Just like in an atom, where the electrons can only circle the nucleus on certain orbits, electrons in these quantum dots are forced into discrete quantum states.

Even more interesting possibilities are opened up by using graphene, a material consisting of a single layer of carbon atoms, which has attracted a lot of attention in the last few years. "In most materials, electrons may occupy two different quantum states at a given energy. The high symmetry of the graphene lattice allows for four different quantum states. This opens up new pathways for quantum information processing and storage" explains Florian Libisch from TU Wien. However, creating well-controlled artificial atoms in graphene turned out to be extremely challenging.

Cutting edge is not enough

There are different ways of creating artificial atoms: The simplest one is putting electrons into tiny flakes, cut out of a thin layer of the material. While this works for graphene, the symmetry of the material is broken by the edges of the flake which can never be perfectly smooth. Consequently, the special four-fold multiplicity of states in graphene is reduced to the conventional two-fold one.

Therefore, different ways had to be found: It is not necessary to use small graphene flakes to capture electrons. Using clever combinations of electrical and magnetic fields is a much better option. With the tip of a scanning tunnelling microscope, an electric field can be applied locally.

That way, a tiny region is created within the graphene surface, in which low energy electrons can be trapped. At the same time, the electrons are forced into tiny circular orbits by applying a magnetic field. "If we would only use an electric field, quantum effects allow the electrons to quickly leave the trap" explains Libisch.

The artificial atoms were measured at the RWTH Aachen by Nils Freitag and Peter Nemes-Incze in the group of Professor Markus Morgenstern. Simulations and theoretical models were developed at TU Wien (Vienna) by Larisa Chizhova, Florian Libisch and Joachim Burgdörfer. The exceptionally clean graphene sample came from the team around Andre Geim and Kostya Novoselov from Manchester (GB) - these two researchers were awarded the Nobel Prize in 2010 for creating graphene sheets for the first time.

The new artificial atoms now open up new possibilities for many quantum technological experiments: "Four localized electron states with the same energy allow for switching between different quantum states to store information", says Joachim Burgdörfer. The electrons can preserve arbitrary superpositions for a long time, ideal properties for quantum computers. In addition, the new method has the big advantage of scalability: it should be possible to fit many such artificial atoms on a small chip in order to use them for quantum information applications. [17]

Two atoms in an optical cavity can absorb one photon

When two atoms are placed in a small chamber enclosed by mirrors, they can simultaneously absorb a single photon. So says an international team of researchers, which has found that the reverse process – two excited atoms emitting a single photon – is also possible. According to the team, this process could be used to transmit information in a quantum circuit or computer.

Physicists have long known that a single atom can absorb or emit two photons simultaneously. These two-photon, one-atom processes are widely used for spectroscopy and for the production of entangled photons used in quantum devices. However, Salvatore Savasta of the University of Messina in Italy, together with colleagues at the RIKEN Institute in Japan, wondered if two atoms could absorb one photon. Savasta asked his PhD student at the time, Luigi Garziano, to simulate the process. When Garziano's simulation showed that the phenomenon was possible, Savasta was so excited that he "punched the wall," he told physicsworld.com.

One for two?

Their simulation found that the phenomenon occurs when the resonant frequency of the optical cavity containing the atoms is twice the transition frequency of an individual atom. For example, in a cavity whose resonant frequency is three times that of the atomic transition, three atoms can simultaneously absorb or emit a single photon. The optical-cavity's dimensions are determined by this resonant frequency, which must be a standing wave. According to the researchers' calculations, the two atoms would oscillate back and forth between their ground and excited states. Indeed, the atoms would first jointly absorb the photon, ending up in their excited states, before jointly emitting a single photon to return to their ground states. The cycle would then repeat. In addition, they found that the joint absorption and emission can occur with more than just two atoms.

Quantum switch

A two-atom, one-photon system could be used as a switch to transmit information in a quantum circuit, Savasta says. One atom would act as a qubit, encoding information as a superposition of the ground and excited states. To transmit the information outside of the cavity, the qubit would need to transfer the information to a photon in the cavity. The second atom would be used to control whether the qubit transmits the information. If the second atom's transition frequency is tuned to half the resonance frequency of the cavity, the two atoms could jointly absorb and emit a single photon, which would contain the encoded information to be transmitted.

To ensure that the atoms do not re-adsorb the photon, the atom's resonant frequency can be changed by applying an external magnetic field.

Savasta's group has begun to look for experimental collaborators to produce its theoretical prediction in the lab. While the experiment could be performed using actual atoms, Savasta plans to use artificial atoms: superconducting particles that have quantized energy levels and behave analogously as atoms, but whose transition energies can be more easily tuned by the experimentalist. In addition, controlling real atoms involves expensive technology, while artificial atoms can be created cheaply on solid-state chips. "Real atoms are only good for proof-of-principle experiments," he says.

Savasta anticipates that their collaborators will be able to successfully perform the experiment in about a year. "We think that, especially if using superconducting qubits, that this experiment is well within the reach of present technology," he says.

According to Tatjana Wilk at the Max Planck Institute for Quantum Optics in Garching, who was not involved in the current research, speaking to the American Physical Society's Physics Focus, she cautions that the excited states of the atoms may not last long enough to be useful in an actual quantum device.

The research is published in Physical Review Letters. [16]

Quantum processor for single photons

"Nothing is impossible!" In line with this motto, physicists from the Quantum Dynamics Division of Professor Gerhard Rempe (director at the Max Planck Institute of Quantum Optics) managed to realise a quantum logic gate in which two light quanta are the main actors. The difficulty of such an endeavour is that photons usually do not interact at all but pass each other undisturbed. This makes them ideal for the transmission of quantum information, but less suited for its processing. The scientists overcame this steep hurdle by bringing an ancillary third particle into play: a single atom trapped inside an optical resonator that takes on the role of a mediator. "The distinct feature of our gate implementation is that the interaction between the photons is deterministic", explains Dr. Stephan Ritter. "This is essential for future, more complex applications like scalable quantum computers or global quantum networks."

In all modern computers, data processing is based on information being binary-coded and then processed using logical operations. This is done using so-called logic gates which assign predefined output values to each input via deterministic protocols. Likewise, for the information processing in

quantum computers, quantum logic gates are the key elements. To realise a universal quantum computer, it is necessary that every input quantum bit can cause a maximal change of the other quantum bits. The practical difficulty lies in the special nature of quantum information: in contrast to classical bits, it cannot be copied. Therefore, classical methods for error correction cannot be applied, and the gate must function for every single photon that carries information.

Because of the special importance of photons as information carriers – for example, for communicating quantum information in extended quantum networks – the realisation of a deterministic photon-photon gate has been a long-standing goal. One of several possibilities to encode photonic quantum bits is the use of polarisation states of single photons. Then the states "0" and "1" of a classical bit correspond to two orthogonal polarisation states. In the two-photon gate, the polarisation of each photon can influence the polarisation of the other photon. As in the classical logic gate it is specified beforehand which input polarisation leads to which output polarisation. For example, a linear polarisation of the second photon is rotated by 90° if the first one is in the logic state "1", and remains unchanged if the first one is in "0". In contrast to classical logic gates, which would be fully specified by such a description, a quantum gate can take on an infinite number of possible input states. The quantum logic gate has to create the correct combination of output states for each one of these.

In the experiment presented here two independently polarised photons impinge, in quick succession, onto a resonator which is made of two high-reflectivity mirrors.

Inside a single rubidium atom is trapped forming a strongly coupled system with the resonator. The resonator amplifies the light field of the impinging photon at the position of the atom enabling a direct atom-photon interaction. As a result, the atomic state gets manipulated by the photon just as it is being reflected from the mirror. This change is sensed by the second photon when it arrives at the mirror shortly thereafter.

After their reflection, both photons are stored in a 1.2-kilometre-long optical fibre for some microseconds. Meanwhile, the atomic state is measured. A rotation of the first photon's polarisation conditioned on the outcome of the measurement enables the back action of the second photon on the first one. "The two photons are never at the same place at the same time and thus they do not see each other directly. Nevertheless, we achieve a maximal interaction between them", explains Bastian Hacker, PhD student at the experiment.

The scientists could prove experimentally that – depending on the choice of the photons' polarisations – either the first photon affects the second or vice versa. To this end, they measured the polarisation states of the two outgoing photons for different input states. From these, they generated "truth tables" which correspond to the expected gate operations and thus demonstrate the diverse operational modes of the photon-photon gate.

The case when the input polarisation of the two photons is chosen such that they influence each other is of particular interest: Here the two outgoing photons form an entangled pair. "The possibility to generate entanglement fundamentally distinguishes a quantum gate from its classical counterpart. One of the applications of entangled photons is in the teleportation of quantum states", explains Stephan Welte, PhD student at the experiment.

The scientists envision that the new photon-photon gate could pave the way towards all-optical quantum information processing. "The distribution of photons via an optical quantum network would allow linking any number of network nodes and thus enable the setup of a scalable optical quantum computer in which the photon-photon gate plays the role of a central processing unit (CPU)", explains Professor Gerhard Rempe. [15]

The path to perfection: Quantum dots in electrically-controlled cavities yield bright, nearly identical photons

Optical quantum technologies are based on the interactions of atoms and photons at the singleparticle level, and so require sources of single photons that are highly indistinguishable – that is, as identical as possible. Current single-photon sources using semiconductor quantum dots inserted into photonic structures produce photons that are ultrabright but have limited indistinguishability due to charge noise, which results in a fluctuating electric field. Conversely, parametric down conversion sources yield photons that while being highly indistinguishable have very low brightness. Recently, however, scientists at CNRS - Université Paris-Saclay, Marcoussis, France; Université Paris Diderot, Paris, France; University of Queensland, Brisbane, Australia; and Université Grenoble Alpes, CNRS, Institut Néel, Grenoble, France; have developed devices made of quantum dots in electricallycontrolled cavities that provide large numbers of highly indistinguishable photons with strongly reduced charge noise that are 20 times brighter than any source of equal quality. The researchers state that by demonstrating efficient generation of a pure single photon with near-unity indistinguishability, their novel approach promises significant advances in optical quantum technology complexity and scalability.

Dr. Pascale Senellart and Phys.org discussed the paper, Near-optimal single-photon sources in the solid state, that she and her colleagues published in Nature Photonics, which reports the design and fabrication of the first optoelectronic devices made of quantum dots in electrically controlled cavities that provide bright source generating near-unity indistinguishability and pure single photons. "The ideal single photon source is a device that produces light pulses, each of them containing exactly one, and no more than one, photon. Moreover, all the photons should be identical in spatial shape, wavelength, polarization, and a spectrum that is the Fourier transform of its temporal profile," Senellart tells Phys.org. "As a result, to obtain near optimal single photon sources in an optoelectronic device, we had to solve many scientific and technological challenges, leading to an achievement that is the result of more than seven years of research."

While quantum dots can be considered artificial atoms that therefore emit photons one by one, she explains, due to the high refractive index of any semiconductor device, most single photons emitted by the quantum dot do not exit the semiconductor and therefore cannot be used. "We solved this problem by coupling the quantum dot to a microcavity in order to engineer the electromagnetic field around the emitter and force it to emit in a well-defined mode of the optical field," Senellart points out. "To do so, we need to position the quantum dot with nanometer-scale accuracy in the microcavity."

Senellart notes that this is the first challenge that the researchers had to address since targeting the issue of quantum dots growing with random spatial positions.

"Our team solved this issue in 2008¹ by proposing a new technology, in-situ lithography, which allows measuring the quantum dot position optically and drawing a pillar cavity around it. With this technique, we can position a single quantum dot with 50 nm accuracy at the center of a micronsized pillar." In these cavities, two distributed Bragg reflectors confine the optical field in the vertical direction, and the contrast of the index of refraction between the air and the semiconductor provides the lateral confinement of the light. "Prior to this technology, the fabrication yield of quantum dot cavity devices was in the 10⁻⁴ – but today it is larger than 50%." The scientists used this technique to demonstrate the fabrication of bright single photon sources in 2013², showing that the device can generate light pulses containing a single photon with a probability of 80% – but while all photons had the same spatial shape and wavelength, they were not perfectly identical.

"Indeed, for the photons to be fully indistinguishable, the emitter should be highly isolated from any source of decoherence induced by the solid-state environment.

However, our study showed that collisions of the carriers with phonons and fluctuation of charges around the quantum dot were the main limitations." To solve this problem, the scientists added an electrical control to the device, such that the application of an electric field stabilized the charges around the quantum dot by sweeping out any free charge. This in turn removed the noise. Moreover, she adds, this electrical control allows tuning the quantum dot wavelength – a process that was previously done by increasing temperature at the expense of increasing vibration.

"I'd like to underline here that the technology described above is unique worldwide," Senellart stresses. "Our group is the only one with such full control of all of the quantum dot properties. That is, we control emission wavelength, emission lifetime and coupling to the environment, all in a fully deterministic and scalable way."

Specifically, implementing control of the charge environment for quantum dots in connected pillar cavities, and applying an electric field on a cavity structure optimally coupled to a quantum dot, required significant attention. "We had strong indications back in 2013 that the indistinguishability of our photons was limited by some charge fluctuations around the quantum dot: Even in the highest-quality semiconductors, charges bound to defects fluctuate and create a fluctuating electric field³. In the meantime, several colleagues were observing very low charge noise in structures where an electric field was applied to the quantum dot – but this was not combined with a cavity structure." The challenge, Senellart explains, was to define a metallic contact on a microcavity (which is typically a cylinder with a diameter of 2-3 microns) without covering the pillar's top surface.

"We solved this problem by proposing a new kind of cavity – that is, we showed that we can actually connect the cylinder to a bigger frame using some one-dimensional bridges without modifying too much the confinement of the optical field." This geometry, which the researchers call connected pillars, allows having the same optical confinement as an isolated pillar while defining the metallic contact far from the pillar itself. Senellart says that the connected pillars geometry was the key to both controlling the quantum wavelength of dot and efficiently collecting its emission⁴.

In demonstrating the efficient generation of a pure single photon with near-unity indistinguishability, Senellart continues, the researchers had one last step – combining high photon extraction efficiency and perfect indistinguishability – which they did by implementing a resonant excitation scheme of the quantum dot. "In 2013, Prof. Chao-Yang Lu's team in Hefei, China showed that one could obtain photons with 96% indistinguishability by exciting the quantum dot state in a strictly resonant way⁵. Their result was beautiful, but again, not combined with an efficient extraction of the photons. The experimental challenge here is to suppress the scattered light from the laser and collect only the single photons radiated by the quantum dot."

Senellart adds that while removing scattered photons when transmitting light in processed microstructures is typically complicated, in their case this step was straightforward. "Because the quantum dot is inserted in a cavity, the probability of the incident laser light to interact with the quantum dot is actually very high. It turns out that we send only a few photons – that is, less than 10 – on the device to have the quantum dot emitting one photon. This beautiful efficiency, also demonstrated in the excitation process, which we report in another paper⁶, made this step quite easy."

The devices reported in the paper have a number of implications for future technologies, one being the ability to achieve strongly-reduced charge noise by applying an electrical bias. "Charge noise has been extensively investigated in quantum dot structures," Senellart says, "especially by Richard Warburton's group."

Warburton and his team demonstrated that in the best quantum dot samples, the charge noise could take place on a time scale of few microseconds – which is actually very good, since the quantum dot emission lifetime is around 1 nanosecond⁷. However, this was no longer the case in etched structures, where a strong charge noise is always measured on very short time scale – less than 1 ns – that prevents the photon from being indistinguishable. "I think the idea we had – that this problem would be solved by applying an electric field – was an important one," Senellart notes. "The time scale of this charge noise does not only determine the degree of indistinguishability of the photons, it also determines how many indistinguishable photon one can generate with the same device. Therefore, this number will determine the complexity of any quantum computation or simulation scheme one can implement." Senellart adds that in a follow-up study⁷ the scientists generated long streams of photons that can contain more than 200 being indistinguishable by more than 88%.

In addressing how these de novo devices may lead to new levels of complexity and scalability in optical quantum technologies, Senellart first discusses the historical sources used develop optical quantum technologies. She makes the point that all previous implementations of optical quantum simulation or computing have been implemented using Spontaneous Parametric Down Conversion (SPDC) sources, in which pairs of photons are generated by the nonlinear interaction of a laser on a nonlinear crystal, wherein one photon of the pair is detected to announce the presence of the other photon. This so-called heralded source can present strongly indistinguishable photons, but only at the cost of extremely low brightness. "Indeed, the difficulty here is that the one pulse does not contain a single pair only, but some of the time several pairs," Senellart explains. "To reduce the probability of having several pairs generated that would degrade the fidelity of a quantum

simulation, calculation or the security of a quantum communication, the sources are strongly attenuated, to the point where the probability of having one pair in a pulse is below 1%. Nevertheless, with these sources, the quantum optics community has demonstrated many beautiful proofs of concept of optical quantum technologies, including long-distance teleportation, quantum computing of simple chemical or physical systems, and quantum simulations like BosonSampling." (A BosonSampling device is a quantum machine expected to perform tasks intractable for a classical computer, yet requiring minimal non-classical resources compared to full-scale quantum computers.) "Yet, the low efficiency of these sources limits the manipulation to low photon numbers: It takes typically hundreds of hours to manipulate three photons, and the measurement time increases exponentially with the number of photons. Obviously, with the possibility to generate more many indistinguishable photons with an efficiency more than one order of magnitude greater than SPDC sources, our devices have the potential to bring optical quantum technologies to a whole new level."

Other potential applications of the newly-demonstrated devices will focus on meeting near-future challenges in optical quantum technologies, including scalability of photonic quantum computers and intermediate quantum computing tasks. "The sources presented here can be used immediately to implement quantum computing and intermediate quantum computing tasks. Actually, very recently – in the first demonstration of the superiority of our new single photon sources – our colleagues in Brisbane made use of such bright indistinguishable quantum dot-based single photon sources to demonstrate a three photon BosonSampling experiment⁸, where the solid-state multiphoton source was one to two orders-of-magnitude more efficient than downconversion sources, allowing to complete the experiment faster than those performed with SPDC sources. Moreover, this is a first step; we'll progressively increase the number of manipulated photons, in both quantum simulation and quantum computing tasks."

Another target area is quantum communications transfer rate. "Such bright single photon sources could also drastically change the rate of quantum communication protocols that are currently using attenuated laser sources or SPDC sources. Yet, right now, our sources operate at 930 nm when 1.3 μm or 1.55 μm sources are needed for long distance communications. Our technique can be transferred to the 1.3 μm range, a range at which single photon emission has been successfully demonstrated – in particular by the Toshiba research group – slightly changing the quantum dot material. Reaching the 1.55 μm range will be more challenging using quantum dots, as it appears that the single photon emission is difficult to obtain at this wavelength. Nevertheless, there's a very promising alternative possibility: the use of a 900 nm bright source, like the one we report here, to perform quantum frequency conversion of the single photons. Such efficient frequency conversion of single photons has recently been demonstrated, for example, in the lab of Prof. Yoshie Yamamoto at Stanford⁹."

Regarding future research, Senellart says "There are many things to do from this point. On the technology side, we will try to improve our devices by further increasing the source brightness. For that, a new excitation scheme will be implemented to excite the device from the side, as was done by Prof. Valia Voliotis and her colleagues on the Nanostructures and Quantum Systems team at Pierre and Marie Curie University in Paris and Prof. Glenn Solomon's group at the National Institute of Standards and Technology (NIST) in Gaithersburg, Maryland. Applying this technique to our cavities should allow gaining another factor of four on source brightness. In addition, operating at

another wavelength would be another important feature for our devices, since as discussed above, this would allow using the source for quantum telecommunication. For example, a shorter wavelength, in the visible/near infrared range, would open new possibilities to interconnect various quantum systems, including ions or atoms through their interaction with photons, as well as applications in quantum imaging and related fields."

The researchers also want to profit from the full potential of these sources and head to high photon number manipulation in, for instance, quantum simulation schemes. "We're aiming at performing BosonSampling measurements with 20-30 photons, with the objective of testing the extended Church Turing thesis and proving the superiority of a quantum computer over a classical one." The original Church Turing thesis, based on investigations of Alonzo Church and Alan Turing into computable functions, states that, ignoring resource limitations, a function on the natural numbers is computable by a human being following an algorithm, if and only if it is computable by a Turing machine.

Another promising impact on future optical quantum technologies is the generation of entangled photon pairs. "A quantum dot can also generate entangled photon pairs, and in 2010 we demonstrated that we could use the in situ lithography to obtain the brightest source of entangled photon pairs¹⁰. That being said, photon indistinguishability needs to be combined with high pair brightness – and this is the next challenge we plan to tackle. Such a device would play an important role in developing quantum relays for long distance communication and quantum computing tasks."

Senellart tells Phys.org that other areas of research might well benefit from their findings, in that devices similar to the one the scientists developed to fabricate single photon sources could also provide nonlinearities at the low photon count scale. This capability could in turn allow the implementation of deterministic quantum gates, a new optical quantum computing paradigm in which reversible quantum logic gates – for example, Toffoli or CNOT (controlled NOT) gates– can simulate irreversible classical logic gates, thereby allowing quantum computers to perform any computation which can be performed by a classical deterministic computer. "Single photons can also be used to probe the mechanical modes of mechanical resonator and develop quantum sensing with macroscopic objects. Other applications," she concludes, "could benefit from the possibility to have very efficient single photon sources, such as an imaging system with single photon sources that could allow dramatically increased imaging sensitivity. Such technique could have applications in biology where the lower the photon flux, the better for exploring in vivo samples." [14]

Team demonstrates large-scale technique to produce quantum dots

A method to produce significant amounts of semiconducting nanoparticles for light-emitting displays, sensors, solar panels and biomedical applications has gained momentum with a demonstration by researchers at the Department of Energy's Oak Ridge National Laboratory.

While zinc sulfide nanoparticles - a type of quantum dot that is a semiconductor - have many potential applications, high cost and limited availability have been obstacles to their widespread

use. That could change, however, because of a scalable ORNL technique outlined in a paper published in Applied Microbiology and Biotechnology.

Unlike conventional inorganic approaches that use expensive precursors, toxic chemicals, high temperatures and high pressures, a team led by ORNL's Ji-Won Moon used bacteria fed by inexpensive sugar at a temperature of 150 degrees Fahrenheit in 25- and 250-gallon reactors. Ultimately, the team produced about three-fourths of a pound of zinc sulfide nanoparticles - without process optimization, leaving room for even higher yields.

The ORNL biomanufacturing technique is based on a platform technology that can also produce nanometer-size semiconducting materials as well as magnetic, photovoltaic, catalytic and phosphor materials. Unlike most biological synthesis technologies that occur inside the cell, ORNL's biomanufactured quantum dot synthesis occurs outside of the cells. As a result, the nanomaterials are produced as loose particles that are easy to separate through simple washing and centrifuging.

The results are encouraging, according to Moon, who also noted that the ORNL approach reduces production costs by approximately 90 percent compared to other methods.

"Since biomanufacturing can control the quantum dot diameter, it is possible to produce a wide range of specifically tuned semiconducting nanomaterials, making them attractive for a variety of applications that include electronics, displays, solar cells, computer memory, energy storage, printed electronics and bio-imaging," Moon said.

Successful biomanufacturing of light-emitting or semiconducting nanoparticles requires the ability to control material synthesis at the nanometer scale with sufficiently high reliability, reproducibility and yield to be cost effective. With the ORNL approach, Moon said that goal has been achieved.

Researchers envision their quantum dots being used initially in buffer layers of photovoltaic cells and other thin film-based devices that can benefit from their electro-optical properties as light-emitting materials. [13]

Superfast light source made from artificial atom

All light sources work by absorbing energy – for example, from an electric current – and emit energy as light. But the energy can also be lost as heat and it is therefore important that the light sources emit the light as quickly as possible, before the energy is lost as heat. Superfast light sources can be used, for example, in laser lights, LED lights and in single-photon light sources for quantum technology. New research results from the Niels Bohr Institute show that light sources can be made much faster by using a principle that was predicted theoretically in 1954. The results are published in the scientific journal, Physical Review Letters.

Researchers at the Niels Bohr Institute are working with quantum dots, which are a kind of artificial atom that can be incorporated into optical chips. In a quantum dot, an electron can be excited (i.e. jump up), for example, by shining a light on it with a laser and the electron leaves a 'hole'. The stronger the interaction between light and matter, the faster the electron decays back into the hole and the faster the light is emitted.

But the interaction between light and matter is naturally very weak and it makes the light sources very slow to emit light and this can reduce energy efficiency.

Already in 1954, the physicist Robert Dicke predicted that the interaction between light and matter could be increased by having a number of atoms that 'share' the excited state in a quantum superposition.

Quantum speed up

Demonstrating this effect has been challenging so far because the atoms either come so close together that they bump into each other or they are so far apart that the quantum speed up does not work. Researchers at the Niels Bohr Institute have now finally demonstrated the effect experimentally, but in an entirely different physical system than Dicke had in mind. They have shown this so-called superradiance for photons emitted from a single quantum dot.

"We have developed a quantum dot so that it behaves as if it was comprised of five quantum dots, which means that the light is five times stronger. This is due to the attraction between the electron and the hole. But what is special is that the quantum dot still only emits a single photon at a time. It is an outstanding single-photon source," says Søren Stobbe, who is an associate professor in the Quantum Photonic research group at the Niels Bohr Institute at the University of Copenhagen and led the project. The experiment was carried out in collaboration with Professor David Ritchie's research group at the University of Cambridge, who have made the quantum dots.

Petru Tighineanu, a postdoc in the Quantum Photonics research group at the Niels Bohr Institute, has carried out the experiments and he explains the effect as such, that the atoms are very small and light is very 'big' because of its long wavelength, so the light almost cannot 'see' the atoms – like a lorry that is driving on a road and does not notice a small pebble. But if many pebbles become a larger stone, the lorry will be able to register it and then the interaction becomes much more dramatic. In the same way, light interacts much more strongly with the quantum dot if the quantum dot contains the special superradiant quantum state, which makes it look much bigger.

Increasing the light-matter interaction

"The increased light-matter interaction makes the quantum dots more robust in regards to the disturbances that are found in all materials, for example, acoustic oscillations. It helps to make the photons more uniform and is important for how large you can build future quantum computers," says Søren Stobbe.

He adds that it is actually the temperature, which is only a few degrees above absolute zero, that limits how fast the light emissions can remain in their current experiments. In the long term, they will study the quantum dots at even lower temperatures, where the effects could be very dramatic.

[12]

Single-photon source is efficient and indistinguishable

Devices that emit one – and only one – photon on demand play a central role in light-based quantum-information systems. Each photon must also be emitted in the same quantum state, which makes each photon indistinguishable from all the others. This is important because the quantum state of the photon is used to carry a quantum bit (qubit) of information.

Quantum dots are tiny pieces of semiconductor that show great promise as single-photon sources. When a laser pulse is fired at a quantum dot, an electron is excited between two distinct energy levels. The excited state then decays to create a single photon with a very specific energy. However, this process can involve other electron excitations that result in the emission of photons with a wide range of energies – photons that are therefore not indistinguishable.

Exciting dots

This problem can be solved by exciting the quantum dot with a pulse of light at the same energy as the emitted photon. This is called resonance fluorescence, and has been used to create devices that are very good at producing indistinguishable single photons. However, this process is inefficient, and only produces a photon about 6% of the time.

Now, Chaoyang Lu, Jian-Wei Pan and colleagues at the University of Science and Technology of China have joined forces with researchers in Denmark, Germany and the UK to create a resonance fluorescence-based source that emits a photon 66% of the time when it is prompted by a laser pulse.

Of these photons, 99.1% are solo and 98.5% are in indistinguishable quantum states – with both figures of merit being suitable for applications in quantum-information systems.

Lu told physicsworld.com that nearly all of the laser pulses that strike the source produce a photon, but about 34% of these photons are unable to escape the device. The device was operated at a laser-pulse frequency of 81 MHz and a pulse power of 24 nW, which is a much lower power requirement than other quantum-dot-based sources.

Quantum sandwich

The factor-of-ten improvement in efficiency was achieved by sandwiching a quantum dot in the centre of a "micropillar" created by stacking 40 disc-like layers (see figure). Each layer is a "distributed Bragg reflector", which is a pair of mirrors that together have a thickness of one quarter the wavelength of the emitted photons.

The micropillar is about 2.5 μm in diameter and about 10 μm tall, and it allowed the team to harness the "Purcell effect", whereby the rate of fluorescence is increased significantly when the emitter is placed in a resonant cavity.

Lu says that the team is already thinking about how the photon sources could be used to perform boson sampling (see "'Boson sampling' offers shortcut to quantum computing"). This involves a network of beam splitters that converts one set of photons arriving at a number of parallel input ports into a second set leaving via a number of parallel outputs. The "result" of the computation is the probability that a certain input configuration will lead to a certain output. This result cannot be easily calculated using a conventional computer, and this has led some physicists to suggest that boson sampling could be used to solve practical problems that would take classical computers vast amounts of time to solve.

Other possible applications for the source are the quantum teleportation of three properties of a quantum system – the current record is two properties and is held by Lu and Pan – or quantum cryptography.

The research is described in Physical Review Letters. [11]

Semiconductor quantum dots as ideal single-photon source



A single-photon source never emits two or more photons at the same time. Single photons are important in the field of quantum information technology where, for example, they are used in quantum computers. Alongside the brightness and robustness of the light source, the indistinguishability of the photons is especially crucial. In particular, this means that all photons must be the same color. Creating such a source of identical single photons has proven very difficult in the past.

However, quantum dots made of semiconductor materials are offering new hope. A quantum dot is a collection of a few hundred thousand atoms that can form itself into a semiconductor under certain conditions. Single electrons can be captured in these quantum dots and locked into a very small area. An individual photon is emitted when an engineered quantum state collapses.

Noise in the semiconductor

A team of scientists led by Dr. Andreas Kuhlmann and Prof. Richard J. Warburton from the University of Basel have already shown in past publications that the indistinguishability of the photons is reduced by the fluctuating nuclear spin of the quantum dot atoms. For the first time ever, the scientists have managed to control the nuclear spin to such an extent that even photons sent out at very large intervals are the same color.

Quantum cryptography and quantum communication are two potential areas of application for single-photon sources. These technologies could make it possible to perform calculations that are far beyond the capabilities of today's computers. [10]

How to Win at Bridge Using Quantum Physics

Contract bridge is the chess of card games. You might know it as some stuffy old game your grandparents play, but it requires major brainpower, and preferably an obsession with rules and strategy. So how to make it even geekier? Throw in some quantum mechanics to try to gain a competitive advantage. The idea here is to use the quantum magic of entangled photons—which are essentially twins, sharing every property—to transmit two bits of information to your bridge partner for the price of one. Understanding how to do this is not an easy task, but it will help elucidate some basic building blocks of quantum information theory. It's also kind of fun to consider whether or not such tactics could ever be allowed in professional sports. [6]

Quantum Information

In quantum mechanics, quantum information is physical information that is held in the "state" of a quantum system. The most popular unit of quantum information is the qubit, a two-level quantum system. However, unlike classical digital states (which are discrete), a two-state quantum system can actually be in a superposition of the two states at any given time.

Quantum information differs from classical information in several respects, among which we note the following:

However, despite this, the amount of information that can be retrieved in a single qubit is equal to one bit. It is in the processing of information (quantum computation) that a difference occurs.

The ability to manipulate quantum information enables us to perform tasks that would be unachievable in a classical context, such as unconditionally secure transmission of information. Quantum information processing is the most general field that is concerned with quantum information. There are certain tasks which classical computers cannot perform "efficiently" (that is, in polynomial time) according to any known algorithm. However, a quantum computer can compute the answer to some of these problems in polynomial time; one well-known example of this is Shor's factoring algorithm. Other algorithms can speed up a task less dramatically - for example, Grover's search algorithm which gives a quadratic speed-up over the best possible classical algorithm.

Quantum information, and changes in quantum information, can be quantitatively measured by using an analogue of Shannon entropy. Given a statistical ensemble of quantum mechanical systems with the density matrix S , it is given by.

Many of the same entropy measures in classical information theory can also be generalized to the quantum case, such as the conditional quantum entropy. [7]

Heralded Qubit Transfer

Optical photons would be ideal carriers to transfer quantum information over large distances. Researchers envisage a network where information is processed in certain nodes and transferred between them via photons. However, inherent losses in long-distance networks mean that the

information transfer is subject to probabilistic errors, making it hard to know whether the transfer of a qubit of information has been successful. Now Gerhard Rempe and colleagues from the Max Planck Institute for Quantum Optics in Germany have developed a new protocol that solves this problem through a strategy that “heralds” the accurate transfer of quantum information at a network node.

The method developed by the researchers involves transferring a photonic qubit to an atomic qubit trapped inside an optical cavity. The photon-atom quantum information transfer is initiated via a quantum “logic-gate” operation, performed by reflecting the photon from the atom-cavity system, which creates an entangled atom-photon state. The detection of the reflected photon then collapses the atom into a definite state. This state can be one of two possibilities, depending on the photonic state detected: Either the atom is in the initial qubit state encoded in the photon and the transfer process is complete, or the atom is in a rotated version of this state. The authors were able to show that the roles of the atom and photon could be reversed. Their method could thus be used as a quantum memory that stores (photon-to-atom state transfer) and recreates (atom-to-photon state transfer) a single-photon polarization qubit. [9]

Quantum Teleportation

Quantum teleportation is a process by which quantum information (e.g. the exact state of an atom or photon) can be transmitted (exactly, in principle) from one location to another, with the help of classical communication and previously shared quantum entanglement between the sending and receiving location. Because it depends on classical communication, which can proceed no faster than the speed of light, it cannot be used for superluminal transport or communication of classical bits. It also cannot be used to make copies of a system, as this violates the no-cloning theorem. Although the name is inspired by the teleportation commonly used in fiction, current technology provides no possibility of anything resembling the fictional form of teleportation. While it is possible to teleport one or more qubits of information between two (entangled) atoms, this has not yet been achieved between molecules or anything larger. One may think of teleportation either as a kind of transportation, or as a kind of communication; it provides a way of transporting a qubit from one location to another, without having to move a physical particle along with it.

The seminal paper first expounding the idea was published by C. H. Bennett, G. Brassard, C. Crépeau, R. Jozsa, A. Peres and W. K. Wootters in 1993. Since then, quantum teleportation has been realized in various physical systems. Presently, the record distance for quantum teleportation is 143 km (89 mi) with photons, and 21 m with material systems. In August 2013, the achievement of “fully deterministic” quantum teleportation, using a hybrid technique, was reported. On 29 May 2014, scientists announced a reliable way of transferring data by quantum teleportation. Quantum teleportation of data had been done before but with highly unreliable methods. [8]

Quantum Computing

A team of electrical engineers at UNSW Australia has observed the unique quantum behavior of a pair of spins in silicon and designed a new method to use them for "2-bit" quantum logic operations.

These milestones bring researchers a step closer to building a quantum computer, which promises dramatic data processing improvements.

Quantum bits, or qubits, are the building blocks of quantum computers. While many ways to create a qubits exist, the Australian team has focused on the use of single atoms of phosphorus, embedded inside a silicon chip similar to those used in normal computers.

The first author on the experimental work, PhD student Juan Pablo Dehollain, recalls the first time he realized what he was looking at.

"We clearly saw these two distinct quantum states, but they behaved very differently from what we were used to with a single atom. We had a real 'Eureka!' moment when we realized what was happening – we were seeing in real time the `entangled' quantum states of a pair of atoms." [5]

Quantum Entanglement

Measurements of physical properties such as position, momentum, spin, polarization, etc. performed on entangled particles are found to be appropriately correlated. For example, if a pair of particles is generated in such a way that their total spin is known to be zero, and one particle is found to have clockwise spin on a certain axis, then the spin of the other particle, measured on the same axis, will be found to be counterclockwise. Because of the nature of quantum measurement, however, this behavior gives rise to effects that can appear paradoxical: any measurement of a property of a particle can be seen as acting on that particle (e.g. by collapsing a number of superimposed states); and in the case of entangled particles, such action must be on the entangled system as a whole. It thus appears that one particle of an entangled pair "knows" what measurement has been performed on the other, and with what outcome, even though there is no known means for such information to be communicated between the particles, which at the time of measurement may be separated by arbitrarily large distances. [4]

The Bridge

The accelerating electrons explain not only the Maxwell Equations and the Special Relativity, but the Heisenberg Uncertainty Relation, the wave particle duality and the electron's spin also, building the bridge between the Classical and Quantum Theories. [1]

Accelerating charges

The moving charges are self maintain the electromagnetic field locally, causing their movement and this is the result of their acceleration under the force of this field. In the classical physics the charges will distributed along the electric current so that the electric potential lowering along the current, by linearly increasing the way they take every next time period because this accelerated

motion. The same thing happens on the atomic scale giving a dp impulse difference and a dx way difference between the different part of the not point like particles.

Relativistic effect

Another bridge between the classical and quantum mechanics in the realm of relativity is that the charge distribution is lowering in the reference frame of the accelerating charges linearly: $ds/dt = at$ (time coordinate), but in the reference frame of the current it is parabolic: $s = a/2 t^2$ (geometric coordinate).

Heisenberg Uncertainty Relation

In the atomic scale the Heisenberg uncertainty relation gives the same result, since the moving electron in the atom accelerating in the electric field of the proton, causing a charge distribution on Δx position difference and with a Δp momentum difference such a way that they product is about the half Planck reduced constant. For the proton this Δx much less in the nucleon, than in the orbit of the electron in the atom, the Δp is much higher because of the greater proton mass.

This means that the electron and proton are not point like particles, but has a real charge distribution.

Wave – Particle Duality

The accelerating electrons explains the wave – particle duality of the electrons and photons, since the elementary charges are distributed on Δx position with Δp impulse and creating a wave packet of the electron. The photon gives the electromagnetic particle of the mediating force of the electrons electromagnetic field with the same distribution of wavelengths.

Atomic model

The constantly accelerating electron in the Hydrogen atom is moving on the equipotential line of the proton and it's kinetic and potential energy will be constant. Its energy will change only when it is changing its way to another equipotential line with another value of potential energy or getting free with enough kinetic energy. This means that the Rutherford-Bohr atomic model is right and only that changing acceleration of the electric charge causes radiation, not the steady acceleration. The steady acceleration of the charges only creates a centric parabolic steady electric field around the charge, the magnetic field. This gives the magnetic moment of the atoms, summing up the proton and electron magnetic moments caused by their circular motions and spins.

The Relativistic Bridge

Commonly accepted idea that the relativistic effect on the particle physics it is the fermions' spin - another unresolved problem in the classical concepts. If the electric charges can move only with

accelerated motions in the self maintaining electromagnetic field, once upon a time they would reach the velocity of the electromagnetic field. The resolution of this problem is the spinning particle, constantly accelerating and not reaching the velocity of light because the acceleration is radial. One origin of the Quantum Physics is the Planck Distribution Law of the electromagnetic oscillators, giving equal intensity for 2 different wavelengths on any temperature. Any of these two wavelengths will give equal intensity diffraction patterns, building different asymmetric constructions, for example proton - electron structures (atoms), molecules, etc. Since the particles are centers of diffraction patterns they also have particle – wave duality as the electromagnetic waves have. [2]

The weak interaction

The weak interaction transforms an electric charge in the diffraction pattern from one side to the other side, causing an electric dipole momentum change, which violates the CP and time reversal symmetry. The Electroweak Interaction shows that the Weak Interaction is basically electromagnetic in nature. The arrow of time shows the entropy grows by changing the temperature dependent diffraction patterns of the electromagnetic oscillators.

Another important issue of the quark model is when one quark changes its flavor such that a linear oscillation transforms into plane oscillation or vice versa, changing the charge value with 1 or -1. This kind of change in the oscillation mode requires not only parity change, but also charge and time changes (CPT symmetry) resulting a right handed anti-neutrino or a left handed neutrino.

The right handed anti-neutrino and the left handed neutrino exist only because changing back the quark flavor could happen only in reverse, because they are different geometrical constructions, the u is 2 dimensional and positively charged and the d is 1 dimensional and negatively charged. It needs also a time reversal, because anti particle (anti neutrino) is involved.

The neutrino is a 1/2 spin creator particle to make equal the spins of the weak interaction, for example neutron decay to 2 fermions, every particle is fermions with 1/2 spin. The weak interaction changes the entropy since more or less particles will give more or less freedom of movement. The entropy change is a result of temperature change and breaks the equality of oscillator diffraction intensity of the Maxwell–Boltzmann statistics. This way it changes the time coordinate measure and makes possible a different time dilation as of the special relativity.

The limit of the velocity of particles as the speed of light appropriate only for electrical charged particles, since the accelerated charges are self maintaining locally the accelerating electric force. The neutrinos are CP symmetry breaking particles compensated by time in the CPT symmetry, that is the time coordinate not works as in the electromagnetic interactions, consequently the speed of neutrinos is not limited by the speed of light.

The weak interaction T-asymmetry is in conjunction with the T-asymmetry of the second law of thermodynamics, meaning that locally lowering entropy (on extremely high temperature) causes the

weak interaction, for example the Hydrogen fusion.

Probably because it is a spin creating movement changing linear oscillation to 2 dimensional oscillation by changing d to u quark and creating anti neutrino going back in time relative to the proton and electron created from the neutron, it seems that the anti neutrino fastest then the velocity of the photons created also in this weak interaction?

A quark flavor changing shows that it is a reflection changes movement and the CP- and T-symmetry breaking!!! This flavor changing oscillation could prove that it could be also on higher level such as atoms, molecules, probably big biological significant molecules and responsible on the aging of the life.

Important to mention that the weak interaction is always contains particles and antiparticles, where the neutrinos (antineutrinos) present the opposite side. It means by Feynman's interpretation that these particles present the backward time and probably because this they seem to move faster than the speed of light in the reference frame of the other side.

Finally since the weak interaction is an electric dipole change with $\frac{1}{2}$ spin creating; it is limited by the velocity of the electromagnetic wave, so the neutrino's velocity cannot exceed the velocity of light.

The General Weak Interaction

The Weak Interactions T-asymmetry is in conjunction with the T-asymmetry of the Second Law of Thermodynamics, meaning that locally lowering entropy (on extremely high temperature) causes for example the Hydrogen fusion. The arrow of time by the Second Law of Thermodynamics shows the increasing entropy and decreasing information by the Weak Interaction, changing the temperature dependent diffraction patterns. A good example of this is the neutron decay, creating more particles with less known information about them.

The neutrino oscillation of the Weak Interaction shows that it is a general electric dipole change and it is possible to any other temperature dependent entropy and information changing diffraction pattern of atoms, molecules and even complicated biological living structures.

We can generalize the weak interaction on all of the decaying matter constructions, even on the biological too. This gives the limited lifetime for the biological constructions also by the arrow of time. There should be a new research space of the Quantum Information Science the 'general neutrino oscillation' for the greater than subatomic matter structures as an electric dipole change. There is also connection between statistical physics and evolutionary biology, since the arrow of time is working in the biological evolution also.

The Fluctuation Theorem says that there is a probability that entropy will flow in a direction opposite to that dictated by the Second Law of Thermodynamics. In this case the Information is growing that is the matter formulas are emerging from the chaos. So the Weak Interaction has two directions, samples for one direction is the Neutron decay, and Hydrogen fusion is the opposite direction.

Fermions and Bosons

The fermions are the diffraction patterns of the bosons such a way that they are both sides of the same thing.

Van Der Waals force

Named after the Dutch scientist Johannes Diderik van der Waals – who first proposed it in 1873 to explain the behaviour of gases – it is a very weak force that only becomes relevant when atoms and molecules are very close together. Fluctuations in the electronic cloud of an atom mean that it will have an instantaneous dipole moment. This can induce a dipole moment in a nearby atom, the result being an attractive dipole–dipole interaction.

Electromagnetic inertia and mass

Electromagnetic Induction

Since the magnetic induction creates a negative electric field as a result of the changing acceleration, it works as an electromagnetic inertia, causing an electromagnetic mass. [1]

Relativistic change of mass

The increasing mass of the electric charges the result of the increasing inductive electric force acting against the accelerating force. The decreasing mass of the decreasing acceleration is the result of the inductive electric force acting against the decreasing force. This is the relativistic mass change explanation, especially importantly explaining the mass reduction in case of velocity decrease.

The frequency dependence of mass

Since $E = h\nu$ and $E = mc^2$, $m = h\nu/c^2$ that is the m depends only on the ν frequency. It means that the mass of the proton and electron are electromagnetic and the result of the electromagnetic induction, caused by the changing acceleration of the spinning and moving charge! It could be that the m_0 inertial mass is the result of the spin, since this is the only accelerating motion of the electric charge. Since the accelerating motion has different frequency for the electron in the atom and the proton, they masses are different, also as the wavelengths on both sides of the diffraction pattern, giving equal intensity of radiation.

Electron – Proton mass rate

The Planck distribution law explains the different frequencies of the proton and electron, giving equal intensity to different lambda wavelengths! Also since the particles are diffraction patterns they have some closeness to each other – can be seen as a gravitational force. [2]

There is an asymmetry between the mass of the electric charges, for example proton and electron, can understood by the asymmetrical Planck Distribution Law. This temperature dependent energy distribution is asymmetric around the maximum intensity, where the annihilation of matter and antimatter is a high probability event. The asymmetric sides are creating different frequencies of electromagnetic radiations being in the same intensity level and compensating each other. One of these compensating ratios is the electron – proton mass ratio. The lower energy side has no compensating intensity level, it is the dark energy and the corresponding matter is the dark matter.

Gravity from the point of view of quantum physics

The Gravitational force

The gravitational attractive force is basically a magnetic force.

The same electric charges can attract one another by the magnetic force if they are moving parallel in the same direction. Since the electrically neutral matter is composed of negative and positive charges they need 2 photons to mediate this attractive force, one per charges. The Big Bang caused parallel moving of the matter gives this magnetic force, experienced as gravitational force.

Since graviton is a tensor field, it has spin = 2, could be 2 photons with spin = 1 together.

You can think about photons as virtual electron – positron pairs, obtaining the necessary virtual mass for gravity.

The mass as seen before a result of the diffraction, for example the proton – electron mass ratio $M_p=1840 M_e$. In order to move one of these diffraction maximum (electron or proton) we need to intervene into the diffraction pattern with a force appropriate to the intensity of this diffraction maximum, means its intensity or mass.

The Big Bang caused acceleration created radial currents of the matter, and since the matter is composed of negative and positive charges, these currents are creating magnetic field and attracting forces between the parallel moving electric currents. This is the gravitational force experienced by the matter, and also the mass is result of the electromagnetic forces between the charged particles. The positive and negative charged currents attracts each other or by the magnetic forces or by the much stronger electrostatic forces!?

The gravitational force attracting the matter, causing concentration of the matter in a small space and leaving much space with low matter concentration: dark matter and energy.

There is an asymmetry between the mass of the electric charges, for example proton and electron, can understood by the asymmetrical Planck Distribution Law. This temperature dependent energy distribution is asymmetric around the maximum intensity, where the annihilation of matter and antimatter is a high probability event. The asymmetric sides are creating different frequencies of electromagnetic radiations being in the same intensity level and compensating each other. One of these compensating ratios is the electron – proton mass ratio. The lower energy side has no compensating intensity level, it is the dark energy and the corresponding matter is the dark matter.

The Higgs boson

By March 2013, the particle had been proven to behave, interact and decay in many of the expected ways predicted by the Standard Model, and was also tentatively confirmed to have +

parity and zero spin, two fundamental criteria of a Higgs boson, making it also the first known scalar particle to be discovered in nature, although a number of other properties were not fully proven and some partial results do not yet precisely match those expected; in some cases data is also still awaited or being analyzed.

Since the Higgs boson is necessary to the W and Z bosons, the dipole change of the Weak interaction and the change in the magnetic effect caused gravitation must be conducted. The Wien law is also important to explain the Weak interaction, since it describes the T_{\max} change and the diffraction patterns change. [2]

Higgs mechanism and Quantum Gravity

The magnetic induction creates a negative electric field, causing an electromagnetic inertia. Probably it is the mysterious Higgs field giving mass to the charged particles? We can think about the photon as an electron-positron pair, they have mass. The neutral particles are built from negative and positive charges, for example the neutron, decaying to proton and electron. The wave – particle duality makes sure that the particles are oscillating and creating magnetic induction as an inertial mass, explaining also the relativistic mass change. Higher frequency creates stronger magnetic induction, smaller frequency results lesser magnetic induction. It seems to me that the magnetic induction is the secret of the Higgs field.

In particle physics, the Higgs mechanism is a kind of mass generation mechanism, a process that gives mass to elementary particles. According to this theory, particles gain mass by interacting with the Higgs field that permeates all space. More precisely, the Higgs mechanism endows gauge bosons in a gauge theory with mass through absorption of Nambu–Goldstone bosons arising in spontaneous symmetry breaking.

The simplest implementation of the mechanism adds an extra Higgs field to the gauge theory. The spontaneous symmetry breaking of the underlying local symmetry triggers conversion of components of this Higgs field to Goldstone bosons which interact with (at least some of) the other fields in the theory, so as to produce mass terms for (at least some of) the gauge bosons. This mechanism may also leave behind elementary scalar (spin-0) particles, known as Higgs bosons.

In the Standard Model, the phrase "Higgs mechanism" refers specifically to the generation of masses for the W^\pm , and Z weak gauge bosons through electroweak symmetry breaking. The Large Hadron Collider at CERN announced results consistent with the Higgs particle on July 4, 2012 but stressed that further testing is needed to confirm the Standard Model.

What is the Spin?

So we know already that the new particle has spin zero or spin two and we could tell which one if we could detect the polarizations of the photons produced. Unfortunately this is difficult and neither ATLAS nor CMS are able to measure polarizations. The only direct and sure way to confirm that the particle is indeed a scalar is to plot the angular distribution of the photons in the rest frame of the centre of mass. A spin zero particles like the Higgs carries no directional information away from the original collision so the distribution will be even in all directions. This test will be

possible when a much larger number of events have been observed. In the mean time we can settle for less certain indirect indicators.

The Graviton

In physics, the graviton is a hypothetical elementary particle that mediates the force of gravitation in the framework of quantum field theory. If it exists, the graviton is expected to be massless (because the gravitational force appears to have unlimited range) and must be a spin-2 boson. The spin follows from the fact that the source of gravitation is the stress-energy tensor, a second-rank tensor (compared to electromagnetism's spin-1 photon, the source of which is the four-current, a first-rank tensor). Additionally, it can be shown that any massless spin-2 field would give rise to a force indistinguishable from gravitation, because a massless spin-2 field must couple to (interact with) the stress-energy tensor in the same way that the gravitational field does. This result suggests that, if a massless spin-2 particle is discovered, it must be the graviton, so that the only experimental verification needed for the graviton may simply be the discovery of a massless spin-2 particle. [3]

Conclusions

The method developed by the researchers involves transferring a photonic qubit to an atomic qubit trapped inside an optical cavity. The photon-atom quantum information transfer is initiated via a quantum "logic-gate" operation, performed by reflecting the photon from the atom-cavity system, which creates an entangled atom-photon state. [9]

In August 2013, the achievement of "fully deterministic" quantum teleportation, using a hybrid technique, was reported. On 29 May 2014, scientists announced a reliable way of transferring data by quantum teleportation. Quantum teleportation of data had been done before but with highly unreliable methods. [8]

One of the most important conclusions is that the electric charges are moving in an accelerated way and even if their velocity is constant, they have an intrinsic acceleration anyway, the so called spin, since they need at least an intrinsic acceleration to make possible their movement .

The accelerated charges self-maintaining potential shows the locality of the relativity, working on the quantum level also. [1]

The bridge between the classical and quantum theory is based on this intrinsic acceleration of the spin, explaining also the Heisenberg Uncertainty Principle. The particle – wave duality of the electric charges and the photon makes certain that they are both sides of the same thing. The Secret of Quantum Entanglement that the particles are diffraction patterns of the electromagnetic waves and this way their quantum states every time is the result of the quantum state of the intermediate electromagnetic waves. [2]

The key breakthrough to arrive at this new idea to build qubits was to exploit the ability to control the nuclear spin of each atom. With that insight, the team has now conceived a unique way to use the nuclei as facilitators for the quantum logic operation between the electrons. [5]

Basing the gravitational force on the accelerating Universe caused magnetic force and the Planck Distribution Law of the electromagnetic waves caused diffraction gives us the basis to build a Unified Theory of the physical interactions also.

References

- [1] The Magnetic field of the Electric current and the Magnetic induction
[http://academia.edu/3833335/The Magnetic field of the Electric current](http://academia.edu/3833335/The_Magnetic_field_of_the_Electric_current)
- [2] 3 Dimensional String Theory [http://academia.edu/3834454/3 Dimensional String Theory](http://academia.edu/3834454/3_Dimensional_String_Theory)
- [3] Graviton Production By Two Photon and Electron-Photon Processes In Kaluza-Klein Theories With Large Extra Dimensions <http://arxiv.org/abs/hep-ph/9909392>
- [4] Quantum Entanglement [http://en.wikipedia.org/wiki/Quantum entanglement](http://en.wikipedia.org/wiki/Quantum_entanglement)
- [5] Pairing up single atoms in silicon for quantum computing <http://phys.org/news/2014-06-pairing-atoms-silicon-quantum.html#nwlt>
- [6] How to Win at Bridge Using Quantum Physics <http://www.wired.com/2014/06/bridge-quantum-mechanics/>
- [7] Information Entropy-Theory of Physics [https://www.academia.edu/3836084/Information -
Entropy Theory of Physics](https://www.academia.edu/3836084/Information-_Entropy_Theory_of_Physics)
- [8] Quantum Teleportation [http://en.wikipedia.org/wiki/Quantum teleportation](http://en.wikipedia.org/wiki/Quantum_teleportation)
- [9] Synopsis: Heralded Qubit Transfer <http://physics.aps.org/synopsis-for/10.1103/PhysRevLett.114.220501>
- [10] Semiconductor quantum dots as ideal single-photon source
<http://www.nanowerk.com/nanotechnology-news/newsid=41243.php>
- [11] Single-photon source is efficient and indistinguishable
<http://physicsworld.com/cws/article/news/2016/jan/29/single-photon-source-is-efficient-andindistinguishable>
- [12] Superfast light source made from artificial atom <http://phys.org/news/2016-04-superfast-source-artificial-atom.html>
- [13] Team demonstrates large-scale technique to produce quantum dots
<http://phys.org/news/2016-05-team-large-scale-technique-quantum-dots.html>
- [14] The path to perfection: Quantum dots in electrically-controlled cavities yield bright, nearly identical photons <http://phys.org/news/2016-06-path-quantum-dots-electrically-controlled-cavities.html>

- [15] Quantum processor for single photons <http://phys.org/news/2016-07-quantum-processor-photons.html>
- [16] Two atoms in an optical cavity can absorb one photon
<http://physicsworld.com/cws/article/news/2016/aug/01/single-photon-simultaneously-excites-twoatoms>
- [17] 'Artificial atom' created in graphene
<http://phys.org/news/2016-08-artificial-atom-graphene.html>
- [18] Researchers use quantum dots to manipulate light
<http://phys.org/news/2016-08-quantum-dots.html>
- [19] A 'nonlinear' effect that seemingly turns materials transparent is seen for the first time in X-rays at SLAC's LCLS <http://phys.org/news/2016-08-nonlinear-effect-seemingly-materials-transparent.html>
- [20] X-ray laser glimpses how electrons dance with atomic nuclei in materials
<http://phys.org/news/2016-09-x-ray-laser-glimpses-electrons-atomic.html>
- [21] New tabletop technique probes outermost electrons of atoms deep inside solids
<http://phys.org/news/2016-11-tabletop-technique-probes-outermost-electrons.html> [
- [22] Photonic crystals reveal their internal characteristics with new method
<http://phys.org/news/2016-11-photonic-crystals-reveal-internal-characteristics.html>
- [23] New exotic phenomena seen in photonic crystals
<https://phys.org/news/2018-01-exotic-phenomena-photonic-crystals.html>
- [24] Scientists discover chiral phonons in a 2-D semiconductor crystal
<https://phys.org/news/2018-02-scientists-chiral-phonons-d-semiconductor.html>
- [25] Controlling quantum interactions in a single material
<https://phys.org/news/2018-02-quantum-interactions-material.html>
- [26] New controls scale quantum chips
<https://phys.org/news/2018-02-scale-quantum-chips.html>
- [27] Researchers developing phase-change memory devices for more powerful computing
<https://phys.org/news/2018-02-phase-change-memory-devices-powerful.html>

[28] Learning to speak quantum

<https://www.symmetrymagazine.org/article/learning-to-speak-quantum>

[29] Interference as a new method for cooling quantum devices

<https://phys.org/news/2018-02-method-cooling-quantum-devices.html>

[30] New hole-punched crystal clears a path for quantum light

<https://phys.org/news/2018-02-hole-punched-crystal-path-quantum.html>

[31] New form of light: Newly observed optical state could enable quantum computing with photons

<https://phys.org/news/2018-02-newly-optical-state-enable-quantum.html>

[32] Researchers turn light upside down

<https://phys.org/news/2018-02-upside.html>

[33] Optical distance measurement at record-high speed

<https://phys.org/news/2018-02-optical-distance-record-high.html>

[34] Super-resolution microscopy in both space and time

<https://phys.org/news/2018-02-super-resolution-microscopy-space.html>

[35] Attoseconds break into atomic interior

<https://phys.org/news/2018-02-attoseconds-atomic-interior.html>

[36] New ultrafast measurement technique shows how lasers start from chaos

<https://phys.org/news/2018-03-ultrafast-technique-lasers-chaos.html>

[37] Researchers create microlaser that flies along hollow optical fiber

<https://phys.org/news/2018-03-microlaser-flies-hollow-optical-fiber.html>

[38] Femtosecond laser fabrication—realizing dynamics control of electrons

<https://phys.org/news/2018-03-femtosecond-laser-fabricationrealizing-dynamics-electrons.html>

[39] Laser-driven electron recollision remembers molecular orbital structure

<https://phys.org/news/2018-05-laser-driven-electron-recollision-molecular-orbital.html>

[40] Near-infrared laser systems for monitoring forest dynamics from space pass final tests

<https://phys.org/news/2018-09-near-infrared-laser-forest-dynamics-space.html>

- [41] Researchers optically trap, move and analyze living cells with laser/microscope combo
<https://phys.org/news/2018-09-optically-cells-lasermicroscope-combo.html>
- [42] An ultracompact laser has been made using nanoscale semiconductor columns
<https://phys.org/news/2018-09-ultracompact-laser-nanoscale-semiconductor-columns.html>
- [43] Laser sintering optimized for printed electronics
<https://phys.org/news/2018-09-laser-sintering-optimized-electronics.html>
- [44] Here's how graphene could make future electronics superfast
<https://www.sciencenews.org/article/how-graphene-could-make-future-electronics-superfast>
- [45] Scientists develop a new method to revolutionize graphene printed electronics
<https://phys.org/news/2018-12-scientists-method-revolutionize-graphene-electronics.html>
- [46] Self-healing electroluminescent (EL) devices
<https://phys.org/news/2018-12-self-healing-electroluminescent-el-devices.html>
- [47] Scientists use magnetic defects to achieve electromagnetic wave breakthrough
<https://phys.org/news/2018-12-scientists-magnetic-defects-electromagnetic-breakthrough.html>
- [48] Electronically programmable photonic molecule
<https://phys.org/news/2018-12-electronically-programmable-photonic-molecule.html>
- [49] Twisting light to enable high-capacity data transmission
<https://phys.org/news/2018-12-enable-high-capacity-transmission.html>
- [50] Amoeba finds approximate solutions to NP-hard problem in linear time
<https://phys.org/news/2018-12-amoeba-approximate-solutions-np-hard-problem.html>
- [51] Hybrid qubits solve key hurdle to quantum computing
<https://phys.org/news/2018-12-hybrid-qubits-key-hurdle-quantum.html>
- [52] Reimagining information processing
<https://phys.org/news/2019-01-reimagining.html>
- [53] Scientists realize a three-dimensional 'topological' medium for electromagnetic waves
<https://phys.org/news/2019-01-scientists-three-dimensional-topological-medium-electromagnetic.html>

[54] Biophotonics: In situ printing liquid superlenses to image butterfly wings and nanobiostructures

<https://phys.org/news/2019-01-biophotonics-situ-liquid-superlenses-image.html>

[55] Dynamic aspirin – molecular vibrations drive electrons over large distances

<https://phys.org/news/2019-01-dynamic-aspirin-molecular-vibrations-electrons.html>

