

Absolute/Relative Motion and the Speed of Light, Electromagnetism, Inertia and Universal Speed Limit c - an Alternative Interpretation and Theoretical Framework

Henok Tadesse, Electrical Engineer, BSc.

Ethiopia, Debrezeit, P.O Box 412

Mobile: +251 910 751339; email entkidmt@yahoo.com or wchmar@gmail.com

01 August 2015

Abstract

According to Apparent Source Theory (AST), the center of the spherical wave fronts *moves* with the apparent source. The velocity of light emitted by a source in absolute motion is constant c relative to the apparent source. For absolutely co-moving source and observer, the position (distance and direction) of the source apparently changes relative to the observer; the effect of absolute motion is to apparently change the path length, and not the speed and wavelength, of light. Physically this means that the velocity (magnitude and direction) of light varies *relative to the (real) source*, due to absolute motion of the source. This implies different velocities of light in different directions *relative to the source* , transverse velocity components and bending light rays in lateral directions, and aberration of light for co-moving source and observer. Unconventionally, in some cases, this also means that the speed of light varies along its path. Light is both a local and non-local phenomenon. AST is a modified emission theory, a fusion between emission theory and absolute motion theory, with the real source replaced with an apparent source to account for absolute velocity of the source. In the Sagnac experiment, the source appears farther away than its physical distance when looking in the backward direction and closer in the forward direction. Physically this means that the velocity of light is $c + V$ in the backward direction and $c - V$ in the forward direction, *relative to the source* , hence a fringe shift. In the case of the Michelson-Morley experiment, an apparent change in the position of the light source relative to an observer does not create a fringe shift, for the same reason that an actual (physical) change of the source position doesn't create any significant fringe shift. This is unlike a hypothetical Sagnac ring interferometer (without beam splitter), which will form a fringe shift if the position of the source was changed physically, instead of rotating the apparatus. In moving source experiments, the velocity of light does not depend on the velocity of the source because the velocity of light is $c - V_{\text{abs}}$ in the forward direction and $c + V_{\text{abs}}$ in the backward direction, *relative to the source*; the velocity of light changes relative to the source in such a way that source velocity will not affect the velocity of light. The velocity of light depends on the observer absolute velocity and on mirror velocity. The reason why GPS works accurately in the ECI frame is discussed. The phase velocity of light is always constant c , independent of source or observer velocity. AST explains why absolute velocity does not affect characteristic wavelengths of atoms , why Doppler effect depends only on relative velocity, why Ives-Silwell experiments are not affected by Earth's absolute velocity and why transverse Doppler effect should not exist. Einstein's thought experiment ('chasing a beam of light') is interpreted as follows. For an observer moving away at (near) the speed of light from a light source that is at absolute rest, the *group* will be frozen but the *phases* will still go past the observer at the speed of light, with a wavelength of $\lambda' = e\lambda$, where e is Euler's constant . A new theory ' Exponential Law of Light ' is proposed to explain the Ives-Stilwell experiment, in which $\lambda' = \lambda e^{V/c}$ and $f' = f e^{-V/c}$. The Trouton-Noble Paradox is a glaring evidence disproving relativity and supporting absolute motion. Absolute velocity is defined to be relative to *the observer*, where 'observer ' is any massive object. It is proposed that the *absolute* velocity of an object is the resultant of its mass weighed velocities *relative* to all massive objects in the universe. The ether doesn't exist. The speed of light is the universal limit on all absolute and relative velocities of physical objects in the universe. This is not due to Special Relativity but due to non-linear law of electromagnetic radiation power and radiation reaction . As

the *absolute* velocity of a body approaches the speed of light, any further acceleration will result in or require increasingly infinite amounts of radiation power and radiation reaction. Mass (inertia) itself may be just radiation reaction. A neutral object/particle also radiates electromagnetic energy and develop radiation reaction during acceleration but, unlike radiation from charged particles, radiations of opposite charges cancel each other and just become *inaccessible*, not destroyed. The 'speed' of gravity is shown to be equal to the speed of light, from a new interpretation of observations according to AST. Gravity may be just a difference between electrostatic attraction and repulsion forces. For absolutely co-moving charge and observer, the position of the charge changes apparently, as seen by the observer, and physically resulting in bending lines of force, creating *transverse* component electric field and this is the cause of radiation during acceleration.

1. Introduction

The notions, theories, experiments and phenomena on the absolute or relative nature of motion, space, and the nature and speed of light, the phenomenon of electromagnetic radiation and the nature of static fields are numerous, puzzling, divergent and have been the source of centuries of confusions. The resolution of the many associated contradictions and puzzles has remained a daunting task to this date. Despite all successes and advance of modern physics, physics remains to be still vague even at its fundamental and elementary levels. Many 'elementary' problems remain unsolved. For example, what is the 'speed' of static fields? What is gravity? How is electromagnetic radiation created? The problem of the speed of light is still a puzzle. Electromagnetism remains to be (one of) the most puzzling area of physics.

The principle of relativity, first introduced by Galileo, is known to be one of the most cherished ideas in physics. The principle of relativity states that the laws of physics are the same in all inertial reference frames. It presumes that no experiment exists that can detect absolute motion.

The notion of absolute space/ absolute motion was also intuitive and existed since Newton, but its real meaning remained obscure. The absolute reference frame remained incomprehensible: relative to what is absolute motion determined?

The fundamental nature of light was another centuries old puzzle. Newton forwarded the Corpuscular theory of light. Huygens proposed the wave theory of light. The interference pattern in Young's double slit experiment proved the wave nature of light. The particle nature of light was discovered in the twentieth century, with the photoelectric effect and other quantum phenomena.

Naturally, scientists assumed that a medium of propagation for light wave, the ether, existed. So the speed of light would be equal to c relative to the ether. In fact Maxwell's equations were based on the ether. So the ether was thought as serving two purposes: as a medium of propagation for light and as an 'absolute reference frame'. The words ether and absolute space/ absolute motion were always used synonymously. This paper proposes a new interpretation of absolute motion and the non existence of the ether.

In 1868 Maxwell developed his equations which predicted that the speed of light is a constant c . Perhaps the most important confirmation of Maxwell's equations is its prediction of the speed of light, which was confirmed experimentally. Maxwell's equations are one of the greatest

discoveries in physics. However, they may still be the tip of the iceberg. They were originally formulated with the assumption of the ether. One problem, for example, is the lack of radiation reaction in the solution to Maxwell's equations, for uniformly accelerating charge. Therefore, Maxwell's equations may be incomplete. The light speed problem is seen as the interpretation of the constant c in Maxwell's equations. Maxwell equations are still not fully understood or may not be complete themselves.

In 1887 Michelson and Morley (MM) set out to experimentally detect the absolute velocity of the Earth relative to the ether. The failure of the MM experiment to detect the expected fringe shift was perceived as a crisis in classical physics and was the beginning of a century of puzzlement to come. Actually, the fringe shift in MM experiment was not null, but a small fringe shift was observed. Since the observed fringe shift was much smaller than expected, it was interpreted as null. The light speed puzzle was thus born: relative to what is the speed of light constant c ?

The notion of absolute motion was thus abandoned in favor of relativity, both due to conceptual problems and the failed MM experiment. The ether hypothesis was not compelling in the first place. Failure to comprehend and detect absolute motion thus became the argument against its validity.

To account for the null result of the MM experiment, Lorentz proposed the Lorentz contraction hypothesis in which motion through the ether would result in length contraction in the direction of motion. Lorentz's hypothesis was later disproved by the Kennedy-Thorndike experiment. The speed of light is variable relative to the observer in the Lorentz hypothesis. Einstein discarded the ether and formulated the Special Relativity Theory (SRT) in which lengths contract due to relative motion, not due to motion relative to the ether. Not only lengths contract but time is also dilated, so that the speed of light is constant in all inertial reference frames, for all observers. In SRT, lengths are contracted and time is dilated as a result of relative motion so that the speed of light will be the same for all inertial observers. Einstein clearly, explicitly announced the emptiness of space. SRT is derived from its two postulates: the principle of relativity and the absolute constancy of the speed of light. Both of its two postulates are perceived as firm foundations of the theory. Einstein's light speed thought experiment (chasing a beam of light) is particularly beautiful and compelling. SRT is the mainstream theory today, claimed to be one of the most experimentally tested theories in physics.

SRT predicts the outcome of some experiments with apparent accuracy, such as the Ives Stilwell experiment and the 'time dilation' for cosmic ray muons. These are 'impossible' for conventional theories. But SRT unambiguously fails on a number of other experiments, such as the Silvertooth experiment.

SRT is also counter intuitive and a source of many paradoxes, such as the Twin Paradox and the little known Trouton-Noble paradox. Even though SRT is accepted by the wider scientific community, many prominent scientists discarded it. A significant 'anti relativity' community exists today, arguing against the validity of SRT and proposing alternative theories.

The ether theory and emission theory existed along with SRT with their own minority proponents. Both have decisively failed to account for a number of experiments. For example,

emission theory is the most natural explanation for the MM null result. Prior to SRT, Einstein himself gave it a serious consideration before abandoning it due to its 'complications'. The scientist who pursued the emission hypothesis most aggressively was Waltz Ritz. However, emission theory was disproved by moving source experiments and the de Sitter experiment. Emission theory also was not compatible with Maxwell's equations [18], which proved to be correct by predicting the speed of light. The ether hypothesis agreed with moving source experiments and the Sagnac effect, but it failed to explain the MM null result. These theories are currently outside the mainstream science. The emission theory, particularly, has already been almost completely abandoned.

Numerous experiments related to the speed of light have been performed for decades and centuries. Several experiments were done before the advent of SRT, many more others were performed to confirm or disprove SRT. The one truth about all these experiments is that they have all defied any natural and logical explanation *within a single theoretical framework*. Despite all claims, there is no single theory of the speed of light to this date that can explain all or most of these experiments. No single model of the speed of light exists to this date that does not fail on a number of basic experiments.

Listed below are many of the experiments and observations related to the speed of light:

- conventional Michelson-Morley experiments, including the Miller experiments
- modern Michelson-Morley experiments
- the Kennedy-Thorndike experiment
- the Sagnac experiment and the Michelson-Gale experiment
- the Silvertooth experiment
- the Marinov experiment
- the Ronald de Witte's experiment
- A. Michelson and Q. Majorana moving mirror and moving source experiments
- the Roamer experiment
- de Sitter's binary star experiment
- the Venus planet radar range data anomaly (Bryan G. Wallace)
- terrestrial light speed measuring experiments, such as the A. Michelson rotating mirror exp't
- the Rosa and Dorsey experiment
- Bradely stellar aberration
- the Trouton-Noble experiment
- the Fizeau experiments
- the 'positron annihilation in flight' experiment
- 'time dilation' experiments: the Hafele-Keating, GPS and cosmic ray muon experiments
- the Ives-Stilwell experiment (transverse Doppler effect), and the fast ion beam experiment
- the Mossbauer rotor experiment
- relativistic 'mass increase' of the electron
- limiting light speed experiments
- bending of starlight near the sun
- Mercury perihelion advance
- Pioneer anomaly
- CMBR frequency anisotropy
- cosmological red shift and cosmological acceleration

The mainstream physics community considers many of these experiments as evidences of SRT, some experiments are ignored or considered 'invalid' simply b/c they are in disagreement with SRT, such as the Silvertooth experiment, and a few as anomalous.

Despite all claimed evidences, the fate of the principle of relativity still depends on whether someone will be able discover an experiment that can detect absolute motion or not. If a single experiment detects absolute motion, then relativity would be invalidated in its current form.

Several experiments have been performed throughout the last century that detected absolute motion. The null result of the Michelson-Morley experiment is the first evidence claimed to support SRT. Actually it is known that it was not a null result but a small fringe shift was observed. The Miller experiments are well known to have detected small, systematic fringe shifts.

Modern Michelson-Morley experiments, which use microwave and optical cavity resonators, look for frequency differences (beat frequency) rather than phase differences. Unlike conventional MM experiments, no absolute motion has been detected. This paper discloses a fundamental flaw in both the conventional and modern MM experiments.

The Sagnac and the Michelson-Gale experiments detected absolute motion as early as 1913 and 1925, respectively. These experiments have always been unnecessarily controversial because proponents of relativity argue that rotational motion is involved. A 'linear' Sagnac experiment has also been performed by Wang.

The Marinov (1976), Silvertooth (1986), Ronald de Witte(1992) experiments detected absolute translational velocity. Since no rotation is involved in these experiments, there can be no excuse for their rejection by the mainstream physics community.

The Silvertooth experiment (1986) was particularly mind blowing, as the direction (towards Leo) and velocity (378 Km/s) reported was subsequently confirmed by the NASA COBE satellite from CMBR frequency anisotropy measurement. The detected change in 'wavelength' was correlated with sidereal time. The detected change in 'wavelength' was correlated with sidereal time. The Silvertooth experiment has conclusively disproved SRT. The Silvertooth experiment was a deadly blow to relativity but the mainstream physics community managed to forget it.

Other experiments proving absolute motion were also performed by different physicists, such as the Marinov experiment and the experiment carried out by Ronald de Witte.

But there is also the Bryan G.Wallace's Venus planet radar range experiment which supports the emission (ballistic) theory.

SRT has also been shown to be logically flawed by so many authors, and was rejected by many scientists, including Ernest Rutherford, Nicolas Tesla, Lorentz and many others.

As its second postulate, SRT assumes that the speed of light is the same for all observers. However, there is no direct, non-controversial evidence for this postulate. We had to rely only on Einstein's (beautiful) thought experiment: 'chasing a beam of light'. For example, one possible

experiment could have been for an observer moving towards or away from a stationary light source and looking for a change in *wavelength* (implied by Einstein's light postulate?). But fast ion beam experiments have been performed and may be considered as a confirmation of change in wavelength with observer velocity.

On the other hand, the speed of light has been measured for centuries with increasing accuracy, from astronomical observations and terrestrial experiments, with such experiments as the Albert Michelson rotating mirror experiment. The fact that no significant variation has been found in different experiments apparently shows that the measured speed of light does not depend on the orientation of the measuring apparatus relative to the earth's orbital or absolute velocity. A related problem is the issue of one way and two way speed of light.

Thus the principle of relativity and the absolute notion both seem to have supporting evidences and the absolute notion has never been truly ruled out as often claimed in SRT. All the three well known theories/postulates of light namely, Einstein's light postulate, emission theory and the absolute space (ether) theory, seem to have their own supporting evidences.

One may wonder then why relativity theory persists as a mainstream theory, despite increasing pool of experimental and logical evidences against it. One reason is the apparent success of SRT to accurately predict the results of many experiments, such as the Ives-Stillwell experiment, the Hafele Keating experiment and the GPS corrections (both controversial), mass increase of relativistic electrons, cosmic ray muon 'time dilation' and universal limiting light speed experiments. It is absolutely impossible to explain these experiments conventionally.

One perplexing aspect of SRT is its prediction of mass increase with velocity and the universal speed limit, which is the speed of light. These has been confirmed by accelerating electrons and beta particles with very high voltages and the velocity of the particles has always been just less than the speed of light and also violated the predictions of classical physics. The limiting light speed has also been confirmed by time of flight method [14,15]. For a dissident of Einstein's relativity, this is a conundrum. This is because, if we assert that the speed of the particles has no relation to the speed of light, or if we assume that some of the particles could exceed the speed of light, why then do the velocities of *most* of these particles always build up near the speed of light? Even the superluminal neutrinos detected in 2011 is only an anomalous event, with neutrinos conforming to the light speed limit most of the time. Velocity dependent Coulomb's law is one appealing explanation but it fails because the speed of cosmic ray muons has also been proved to confirm the light speed limit by time of flight method[15]. Moreover, the energy of electrons accelerated to near light speed has been shown to continue to increase as the accelerating voltage is increased[14].

SRT's successes have been effectively used as cover for its failures. On the other hand, it was the null result of the Michelson-Morley experiment that invoked the 'length contraction', 'time dilation' speculations. Even though Einstein was said to be unaware of the MM experiment when he formulated SRT, the 'length contraction' or length and time transformations were already proposed before him by Lorentz -Fitzgerald, which was meant to explain the Michelson Morley null result. What Einstein did was to give a new interpretation, by eliminating the ether. So it can be said that the whole relativity theory (SRT, GR) was based on the MM experiment null result. Therefore, if the SRT explanation of MM experiment is falsified or if a more intuitive and

logical alternative explanation is found, then Einstein's theory of relativity should be invalidated, irrespective of any other experiments claimed to support it.

The Ives-Stilwell experiment may be more credible because Herbert Ives himself was a dissident of Einstein's relativity. Other evidences of relativity, such as GPS correction, muon 'time dilation', Hafele Keating experiment, however, are still controversial. For example, Van Flandern argued that relativity corrections are not actually used in GPS. Some authors also argue that circular logic is involved in the muon 'time dilation' experiment because the velocity of the particle is determined from its energy using the relativistic equation. Many of the experiments claimed as evidence of SRT are reported to have confirmed SRT to within such and such accuracy, 'to within 1%', one part in a billion etc., even in cases where the experiments are clearly controversial and grossly of low quality, and this is intended to suppress challenges against Einstein's relativity and to discourage alternative ideas.

The main reason for the persistence of SRT, however, is that no alternative theory exists that can explain all conventional and 'relativistic' experiments. For example, Silvertooth himself could not provide a clear theoretical explanation of his experiment and this became an excuse for the mainstream physics community to ignore an experimental fact. Many scientists and authors have proved the logical invalidity of SRT, but no competing, successful alternative theory has come out to this date. The challenge is not in pointing out the numerous logical flaws in SRT, but in finding an alternative competing explanation.

Therefore, we are in no shortage of experimental and logical evidences against relativity today. What is lacking is a theoretical framework that can explain the many experimental and observational facts that have accumulated for decades and centuries. For example, no theory exists today that can satisfactorily explain *all* of the following experiments: the Michelson-Morley experiment, the Sagnac effect, moving source experiments and moving mirror experiments, the Silvertooth experiment.

Naturally, I started by searching for a theory that can reconcile the MM experiment and the Sagnac effect. No theory of the speed of light is valid at least if it cannot explain both these experiments with the same treatment. All known existing theories (SRT, ether theory, emission theory) fail at least on one of these experiments. SRT proponents simply choose to ignore the Sagnac effect or they apply a different treatment to it.

After a considerable effort and puzzlement over years, I came across the seed of idea that can reconcile the MM experiment and Sagnac effect and developed it into the Apparent Source Theory (AST). AST can also explain moving source and moving mirror experiments, the Miller experiments, the Silvertooth experiment, the Marinov experiment, the Ronald de Witte experiment, the Bryan G.Wallace experiment, the Michelson rotating mirror light speed experiment, within a single theoretical framework. AST discloses the mystery behind the 'null' result of the MM experiment and why the Miller experiment detected a small fringe shift. It reveals the fallacy in modern and conventional Michelson-Morley experiments. It shows why the velocity of light is independent of source velocity and why it should depend on observer and mirror velocity. Apparent Source Theory (AST) is a model that can successfully explain many apparently contradicting experiments.

This paper builds on my previous paper [13] and attempts to develop a coherent theoretical

framework of existing theories and notions, experimental evidences and observations related to the speed of light. A new theoretical framework is proposed in which the notion of absolute space/ absolute motion, emission theory and Einstein's light postulate, are fused into a single theoretical framework, with features of each theory left out that do not fit into the new model. Ether theory and emission theory are wrong in their current form and no length contraction time dilation of SRT exists. All existing known notions and theories of motion and the speed of light (absolute / relative, emission theory, absolute (ether) notion, Einstein's light postulate) play a crucial role in the new theoretical framework. Some existing aspects of Special Relativity, relativistic mass increase and universal light speed limit, are adopted with a new interpretation and profound implications.

2. Absolutely co-moving source and observer

In this section we discuss experiments with co-moving source and observer.

2.1 Apparent Source Theory (AST)

The idea that reconciles the Sagnac effect and the Michelson-Morley experiment is as follows: *for co-moving light source and observer, the effect of absolute velocity is to create a change in path length, and not the speed, of light.*

Another way of describing this is:

for co-moving light source and observer, the effect of absolute velocity is to create an apparent change in the position (distance and direction) of the light source relative to the observer/detector.

This can be seen as a fusion of ether (or classical absolute space) theory and emission theory. It is helpful to see it as modified emission theory.

The key idea is that there is no ether. With the ether hypothesis, light was assumed to be *only* a local phenomenon. This is the blunder that led to a confusion of more than a century. Michelson and Morley conceived their experiment based on this mistake. They treated light as ordinary, material waves, such as the sound wave. The Michelson-Morley experiment was designed to detect something that never existed: the ether.

The null result of MM experiment should never have been a big surprise because the ether hypothesis itself was never anything more than a hypothesis. It never developed into the status of a theory. It could be invalidated conceptually, without any experiment. Any speculation should be subjected to a thorough conceptual test even before doing a physical experiment.

One simple argument against the ether would be as follows. The ether is assumed to have no interaction with matter. It exists and flows freely in material objects. Light was thought to be a wave of the ether, analogous to water waves being waves of water. In this case, therefore, light also should be able to pass through any physical object as light itself is just vibration of the ether.

So we would be able to see objects behind opaque walls. And this is absurd. Since the ether does not interact with matter, then how would light even interact with our eyes ? The ether was redundant. No one knows what the ether is made of.

Light is not only a local phenomenon. It is a dual phenomenon, both local and a non-local (action at a distance), simultaneously.

The ether and absolute motion were always (wrongly) perceived to be the same. This paper shows that the ether does not exist but absolute motion does. This is possible with a new interpretation of absolute motion.

Let us first consider a sound source and a receiver, co-moving with velocity V relative to the air.

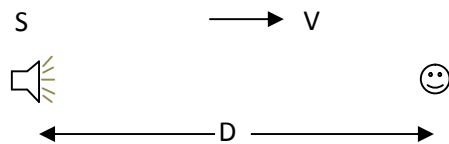

If the source and receiver are both at rest relative to air, i.e. $V = 0$, a sound pulse emitted by S will be received after a time delay of:

$$t_d = \frac{D}{c_s}$$

If the source and the receiver are co-moving relative to the air, we can analyze the experiment by assuming the source and the receiver to be at rest, with the air flowing to the left. Since the speed of sound relative to the air is c_s , the speed of sound relative to the receiver will be:

$$c_s - V$$

Now a sound pulse emitted by the source will be received by the receiver after a time delay of:

$$t_d = \frac{D}{c_s - V}$$

In this case, it takes longer for sound waves to catch up with the receiver. By noticing a change in t_d , the observer can know that he/she is moving relative to the air and can calculate his velocity relative to air from knowledge of D and t_d .

Now we consider light. Since the ether hypothesis was disproved by the null result of Michelson-Morley (MM) experiment, there is no medium for light transmission. Yet the existence of absolute motion has been confirmed by several other experiments, such as Sagnac, Silvertooth, Marinov, Ronald de Witte experiments. Even the historical MM experiment result was not null and a small, and systematic fringe shifts were detected in the Miller experiments. But modern

MM experiments are even more flawed than the conventional MM experiments and, fundamentally, they cannot detect any absolute motion. They compare frequencies and search for beat frequencies and not for changes in phase differences. All ether drift experiments disproved the ether but not absolute motion.

So the ether does not exist, but absolute motion does. How can we perceive absolute motion if no medium exists? We can understand absolute motion as follows.

Let us formulate a postulate:

For absolutely co-moving source and observer, it takes light emitted from the source a time delay t_d different from D/c to reach the observer. This means that the observer knows that he is in absolute motion by noticing a change (increase or decrease) in time delay t_d . If absolute motion is valid, which has been proved experimentally, then light emitted by source will take more or less time than D/c to reach the observer, for absolutely co-moving source and observer.

For sound wave, the speed of sound relative to the receiver will be different from c_s , for source and receiver co-moving relative to air, where c_s is the speed of sound relative to air. Consider the problem in the reference frame of the sound source and the receiver, with the air flowing past them. So the time delay is known to be due to a change in the speed of sound relative to the receiver. Since there is no medium for light, there is no medium flowing past the observer and the light source, so the speed of light relative to the observer cannot be different from c , for absolutely co-moving source and observer. To assume that the speed of light will vary relative to the observer, for absolutely co-moving source and observer, would be inconsistent with the fact that there is no medium for light transmission. Therefore, for co-moving source and observer, the speed of light is always equal to c relative to the observer. (Note, however, that the speed of light will *apparently* differ from c for co-moving source and observer, as will be seen later on. This apparent change in velocity of light occurs when we assume that light started from the source, which is wrong. Physically the light always starts from its source and not from empty space, but light behaves *as if* it started from an apparent position of the source and this is the correct model that successfully explains many experiments.)

The key question is:

But how can t_d be different from D/c if the speed of light is still equal to c relative to the observer, for absolutely co-moving source and observer ?

The solution to this puzzle is that, for time delay t_d to be different from D/c , the distance between the light source and the observer should *apparently* change from D .

Thus the effect of absolute motion for co-moving source and observer is to create an apparent change in position (distance and direction) of the light source relative to the observer.

Imagine a light source S and an observer O, both at (absolute) rest, i.e. $V_{\text{abs}} = 0$.

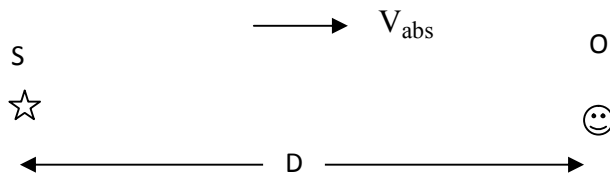

A light pulse emitted by S will be detected after a time delay of

$$t_d = \frac{D}{c}$$

Now suppose that the light source and the observer are absolutely co-moving to the right.

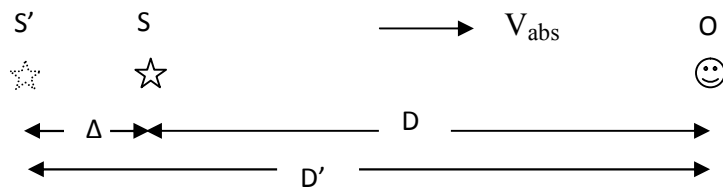

The new interpretation is that the position of the source S changes apparently to S', as seen by the observer. Once we make this interpretation, we can follow the classical (ether) way *just to make the calculations*, to determine the amount (Δ) by which the source position apparently changes. For example, when we say ' during the time that the source moves from S' to S, light moves from S' to O ', we are not saying this in the conventional sense.

During the time (t_d) that the source 'moves' from point S' to point S, the light pulse moves from point S' to point O, i.e. the time taken for the source to move from point S' to point S is equal to the time taken for the light pulse to move from point S' to point O.

$$\frac{\Delta}{V_{abs}} = \frac{D'}{c}$$

But

$$D + \Delta = D'$$

From the above two equations:

$$D' = D \frac{c}{c - V_{abs}}$$

and

$$\Delta = D \frac{V_{abs}}{c - V_{abs}}$$

The effect of absolute motion is thus to create an apparent change of position of source relative to the observer, in this case, by an amount:

$$\Delta = D \frac{V_{abs}}{c - V_{abs}}$$

A light pulse emitted by the source is detected at the observer after a time delay of:

$$t_d = \frac{D'}{c} = \frac{D \frac{c}{c - V_{abs}}}{c} = \frac{D}{c - V_{abs}}$$

To the observer, the source S appears farther away than it physically is.

For the observer, the center of the wave fronts is always at S' and moves with it. We can see this as a modified emission theory, as a fusion of emission theory and ether (absolute) theory.

In the same way, for absolute velocity directed to the left:

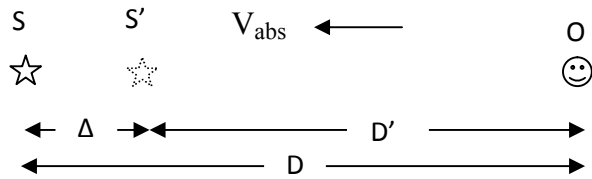

$$\frac{\Delta}{V_{abs}} = \frac{D'}{c}$$

But

$$D - \Delta = D'$$

From which

$$D' = D \frac{c}{c + V_{abs}}$$

and

$$\Delta = D \frac{V_{abs}}{c + V_{abs}}$$

$$t_d = \frac{D'}{c} = \frac{D}{c + V_{abs}}$$

In this case, it appears to the observer that the source is nearer than it actually is.

Now imagine a light source S and an observer O as shown below, with the relative position of S

and O orthogonal to the direction of their common absolute velocity.

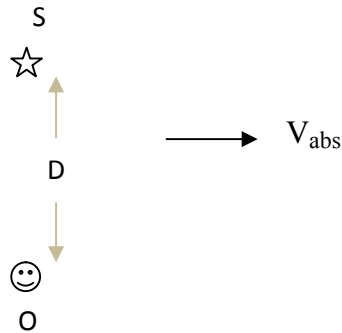

S and O are moving to the right with common absolute velocity V_{abs} .

If V_{abs} is zero, a light pulse emitted from S will be received by O after a time delay t_d

$$t_d = \frac{D}{c}$$

If V_{abs} is not zero, then the light source appears to have shifted to the left as seen by observer O.

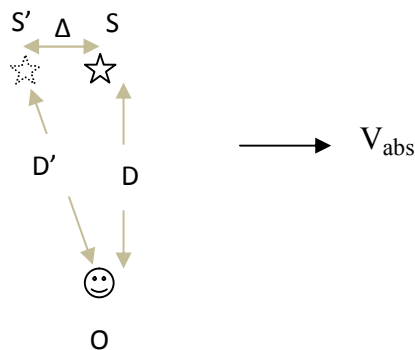

In this case also, the effect of absolute velocity is to create an apparent change in the *position* of the source relative to the observer.

In the same way as explained previously,

$$\frac{D'}{c} = \frac{\Delta}{V_{abs}}$$

i.e. during the time interval that the light pulse goes from S' to O, the source goes from S' to S.

But,

$$D^2 + \Delta^2 = D'^2$$

From the above two equations

$$D' = D \frac{c}{\sqrt{c^2 - V_{abs}^2}}$$

Therefore, the time delay t_d between emission and reception of the light pulse in this case will be

$$t_d = \frac{D'}{c} = \frac{D}{\sqrt{c^2 - V_{abs}^2}}$$

Now suppose that there are two ideally *coherent* light sources S1 and S2, as shown below.

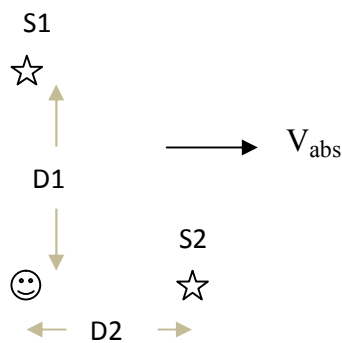

S1, S2 and observer O are co-moving absolutely to the right with absolute velocity V_{abs} .

If V_{abs} is zero the two time delays will be :

$$t_{d1} = \frac{D1}{c} \quad , \quad t_{d2} = \frac{D2}{c}$$

If V_{abs} is not zero, the positions of the sources will change apparently relative to the observer as shown below and hence the two time delays will be affected differently and hence fringe shift occurs as the whole system is rotated.

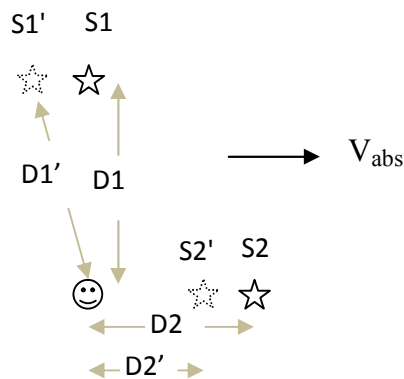

In this case, the two time delays will be different.

$$D1' = D1 \frac{c}{\sqrt{c^2 - V_{abs}^2}}$$

$$D2' = D2 \frac{c}{c + V_{abs}}$$

Therefore

$$t_{d1} = \frac{D1'}{c}$$

$$= \frac{D1}{\sqrt{c^2 - V_{abs}^2}}$$

and

$$t_{d2} = \frac{D2'}{c} = \frac{D2}{c + V_{abs}}$$

Hence, a fringe shift would occur as the absolute velocity is changed or as the whole apparatus is rotated.

So far we considered only the simplest ideal systems in which only a light source and an observer existed. However, real experiments involve mirrors, causing confusion, so we will analyze a system additionally consisting of mirrors in the next section.

Consider a light source S, an observer O and a mirror M, co-moving to the right with absolute velocity V_{abs} .

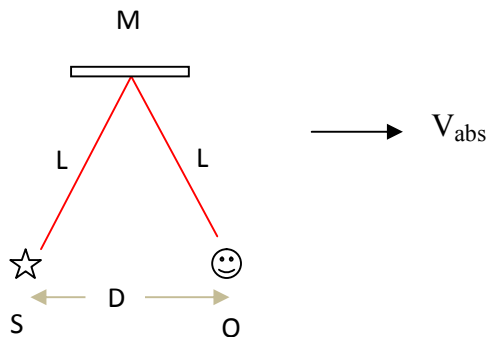

If V_{abs} is zero, then the time delay between emission and reception of a light pulse will be

$$t_d = \frac{2L}{c}$$

If V_{abs} is not zero, then, as discussed previously, the source S appears to have shifted away from

the observer O. The effect will be the same as physically shifting the source in a Galilean space and applying emission theory.

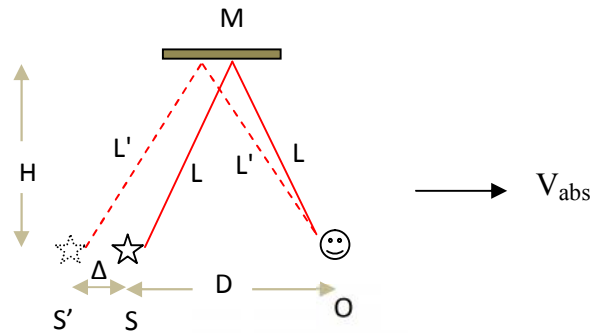

$$\Delta = D \frac{V_{abs}}{c - V_{abs}}$$

Hence the length of the light path from S' to O will be:

$$2L' = 2 \sqrt{\left(\frac{D + \Delta}{2}\right)^2 + H^2}$$

Therefore, the time delay will be

$$t_d = \frac{2L'}{c} = \frac{2}{c} \sqrt{\left(\frac{D + \Delta}{2}\right)^2 + H^2}$$

where D is the *direct* distance from observer to source. Note that, throughout this paper, we always take source observer *direct* distance to determine apparent position of the source. So the effect of absolute motion is just to create an apparent shift in the position of the light source relative to the observer. This avoids all the confusions that arise in systems consisting of mirrors. We would not say, for example, that the mirror will move to a different position while the light beam is in transit, etc., as in standard, classical theories, as in ether theory and SRT. Only the position of the light *source* is thought to shift apparently relative to the observer. As already said, we can think of this as actually/ physically shifting the source from position S to S' in Galilean space, with the same effect, *for that observer*. In other words, we replace the real source with the apparent source to account for the absolute velocity. Once we have done this, we assume Galilean space and simply use (modified) emission theory. Modified emission theory is one in which the group velocity is constant relative to the source, as in the conventional emission theory, whereas the phase velocity is constant c independent of source or observer velocity, assuming Galilean space. Constancy of phase velocity is explained in a later section.

What if the mirror is moving relative to the observer? Assume that the mirror is moving towards or away from the source and the observer with velocity V , with the source and observer at rest relative to each other, but with a common absolute velocity as shown in the figure. How is this experiment analyzed?

The procedure of analysis is:

1. Replace the real source with the apparent source (i.e. a source at the apparent position)
2. Apply (modified) emission theory (group velocity constant relative to source, constant phase velocity).

Let us consider a simpler case in which the distance D between source and observer is much less than the distance H to the mirror, so that we can assume that the source and observer are at the same point in space. From our analysis so far, the lesser the distance between co-moving source and observer, the lesser will be the apparent change of source position. *For all experiments in which the source and observer are close enough to each other that they can be assumed to be at the same point in space, absolute motion will have no effect on the experiment.* In this case, there will not be any significant apparent change of position of the source relative to the observer. The source and the observer can be considered to be at rest (according to the procedure mentioned above), with the mirror moving towards them with velocity V . A good example of such a case is the explanation for the anomalous radar range data of planet Venus as discovered by Bryan G.Wallace. The detail analysis of this experiment will be made later on.

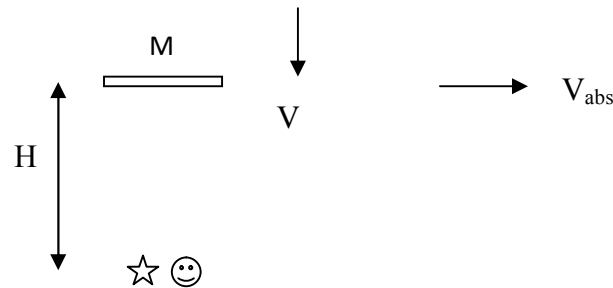

If the mirror is not moving, the round trip time of a light pulse emitted by the source will be:

$$t_d = \frac{2H}{c}$$

If the mirror is moving with velocity V , we apply emission (ballistic) theory after replacing the real source by the apparent source, the velocity of the reflected light will be $c + 2V$, relative to the observer.

The analysis of the round trip for the case of a moving mirror will be made in the section ahead which explains the Bryan G.Wallace experiment. In this experiment, the planet Venus acts as the mirror M .

With the interpretation (theory) presented so far, the Michelson- Morley and the Kennedy- Thorndike experiments can be explained. The secret behind the null results of these experiments is that only a single light source was used, with a single light beam split into two.

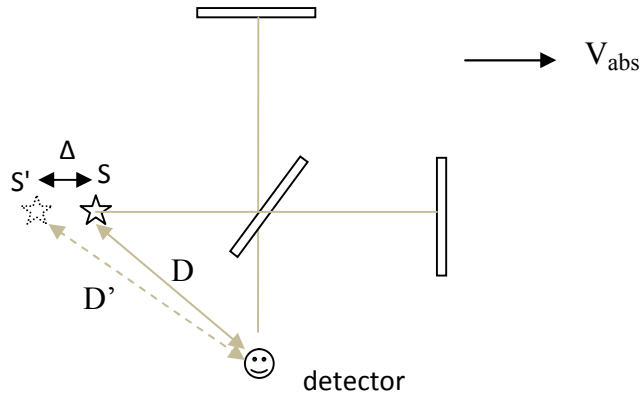

From the above diagram, we see that the effect of absolute velocity is just to create an apparent shift of the position of the light source relative to the detector, for absolute velocity V_{abs} directed to the right.

The best way to understand the effect of this apparent change of source position is to ask: *what is the effect of actually, physically shifting the source from position S to position S' , assuming Galilean space and emission theory?*

If we assume Galilean space and emission theory and shift the source from S to S' , obviously there will be no fringe shift because both the longitudinal and lateral beams will be affected in the same way.

Therefore, in the present case, the apparent shift of the source is common both to the forward and lateral beams and hence the path lengths of both beams are affected in the same way and hence no fringe shift will occur. The effect is the same as physically changing the source position (assuming Galilean space and emission theory), which will not create any fringe shift obviously.

Now let us consider the case of absolute velocity directed as shown below. For an absolute velocity V_{abs} directed downwards, the apparent position of the light source will be as shown.

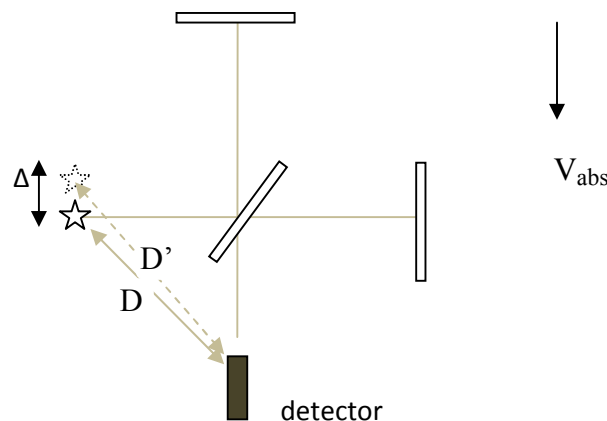

What is the effect of absolute velocity in this case? In the same way as above, we ask: what is the effect of actually, physically shifting the source from S to S', assuming Galilean space and/or emission theory? In this case there will be a small fringe shift because the two beams will be misaligned and will have different path lengths.

Note that there is no beam with slant path as in the conventional MMX analysis of SRT or ether theory. This is the distinction of the new theory.

Now we can see why there were NON-NUL results in many conventional MM experiments, such as the Miller experiments. There will be the same small fringe shift as if the light source was actually (physically) shifted to the apparent position. If the light source is physically shifted to the position shown, the path lengths of the two beams arriving at the observer (detector) should change slightly differently. The two beams will also be misaligned.

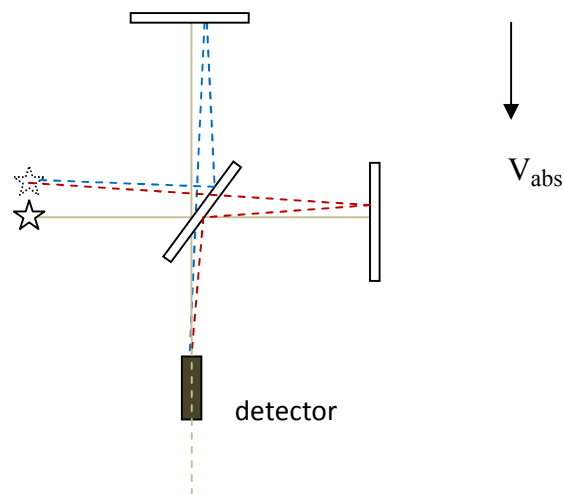

The blue and red dotted lines show the two beams. The drawing is not drawn to be accurate but only to illustrate the idea.

After reading the explanation of the Silvertooth and Marinov experiments, which will come ahead, it will become more clear why the Miller, Silvertooth and Marinov experiments showed different magnitudes and directions of Earth's absolute velocity.

Hypothetical Michelson-Morley experiment

To detect absolute motion with an MMX type experiment, thus, we need two ideally coherent light sources, as shown below. The single light source in the conventional MM apparatus is omitted and the two reflecting mirrors are replaced by two coherent light sources.

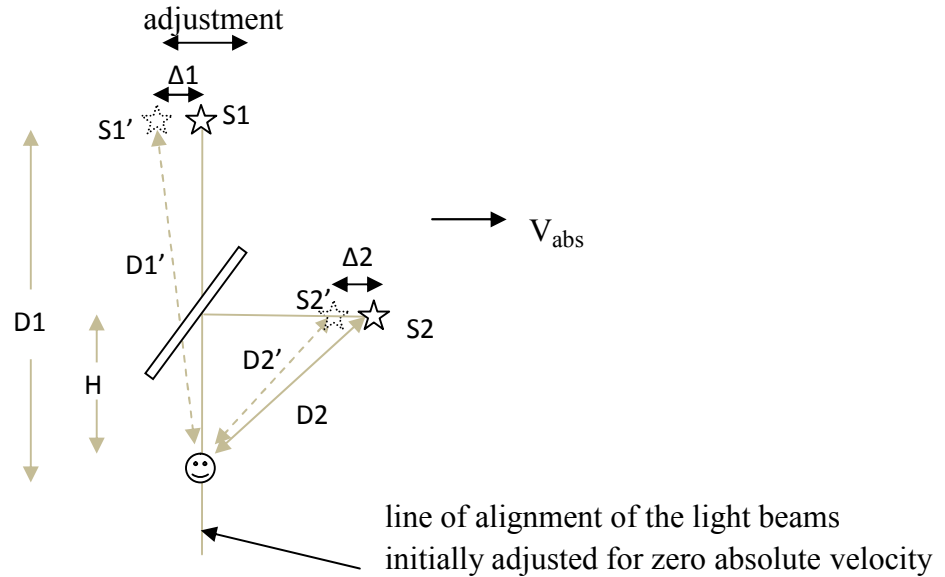

With zero absolute velocity, the two light beams arriving at the detector are adjusted to be aligned. Then, with non zero absolute velocity, the two beams will be misaligned and a fringe shift will occur. The position of the source S1 may be adjusted (towards the right) until the two light beams are aligned again. The amount of adjustment of position of S1 required to align the two beams again can be used to determine the absolute velocity.

Let the two light sources be at distances $D1$ and $D2$ from the detector . Note that $D1$ and $D2$ are the direct distances between the detector and the sources and does *not* involve any distances to the mirrors.

As discussed previously, therefore

$$t_{d1} = \frac{D1'}{c}$$

$$= \frac{D1}{\sqrt{c^2 - V_{abs}^2}}$$

and

t_{d2} can be determined after $D2'$ is determined from the following equations.

$$\frac{D2'}{c} = \frac{\Delta2}{V_{abs}} \quad \dots \dots \dots (1)$$

$$\overline{D2^2 - H^2} - \overline{D2'^2 - H^2} = \Delta 2 \dots\dots\dots (2)$$

A large fringe shift corresponding to the absolute velocity of the earth (about 390 Km/s) would be observed when rotating the apparatus.

One may ask: The modern MMX experiments which are based on optical resonators use two independent orthogonal laser light beams from two independent laser light sources; why then did the experiments fail to detect absolute motion? These experiments look for differences in the frequencies of the two orthogonal beams. As explained so far, the effect of absolute motion is to create a change in path length and hence a change in phase. The phases of the two beams change differently. A change in phase difference (and not a change in frequencies) occurs. The resonance frequency of the optical cavities do not change due to absolute motion; for a point inside the optical cavity, only the phase of the wave changes; the amplitude is not affected. Modern Michelson-Morley experiments will be discussed later on.

But there is a problem with the practicality of the above proposed experiment. The coherence time of even the best lasers available is in the order of milliseconds. It is not possible/practical to rotate the apparatus within one millisecond to detect the absolute motion of the earth. The above proposed experiment is only theoretical and is meant only to clarify the theory. But the good news is that a more practical and basically the same kind of experiment has already been carried out. This is the Ronald de Witte's experiment. He used two independent, Cesium stabilized 5 MHz sources with co-axial cables. He detected absolute motion by comparing the phases of the two independent signals and observed sidereal dependence.

Another hypothetical experiment which, unlike the Michelson-Morley experiment, is capable of detecting absolute velocity is shown below. A single light source is used.

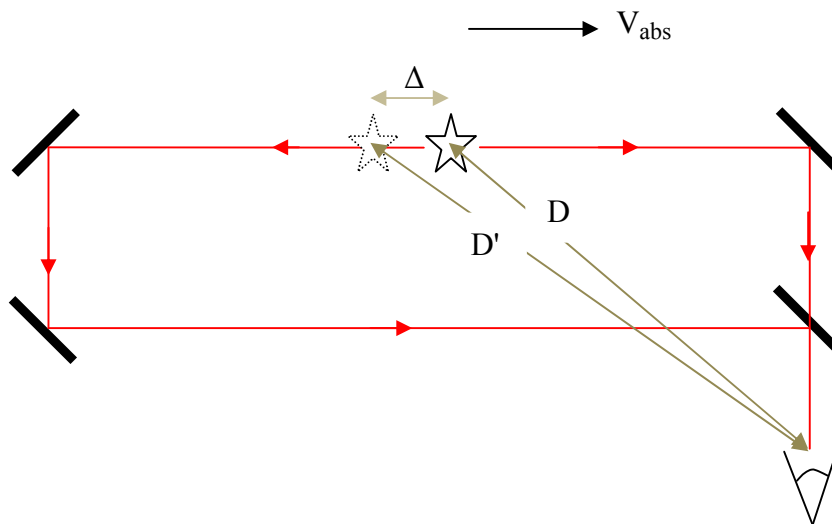

The source in this experiment should emit a photon in either direction with equal probability, so that the photon interferes with itself at the detector. This is why the experiment is called hypothetical. Real sources cannot emit a single photon in opposite directions. Theoretically an isolated atom can be used as the source, since it can emit equally in both directions. Real sources cannot be used since atoms in real sources cannot emit a photon in opposite directions. No beam splitter should be used to send a photon in opposite directions so that it interferes with itself at the detector, as in the Michelson-Morley experiment; the experiment will fail to detect absolute motion if a beam splitter is used.

As the apparatus is absolutely moved to the right, the path length of the right beam is lengthened and the path length of the left beam is shortened. A very large fringe shift will be observed ! For example, if distance D is about one meter, Δ is of the order of one millimeter, for absolute velocity 390 Km/s. One millimeter is about 1500 wavelengths, for $\lambda = 630$ nm.

Perhaps a possibly practical version of the above experiment is as follows.

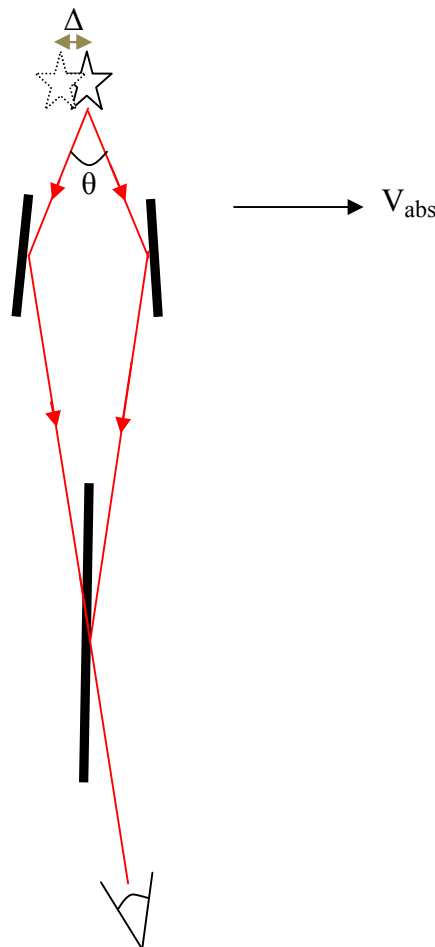

In the above experiment it is assumed that each photon has (nearly) equal probability of going to the right or to the left mirror. This is true for small angles θ , but the experiment becomes less

sensitive to absolute motion as angle θ becomes small.

2.2 Where does a light beam start? Apparent contradiction in the new theory

Even though we have seen so far that the new interpretation has succeeded in resolving the most challenging contradictions and paradoxes of the speed of light, an apparent contradiction has been identified.

Assume two observers O_A and O_B , both at absolute rest, at points A and B, respectively, with distance between them equal to D.

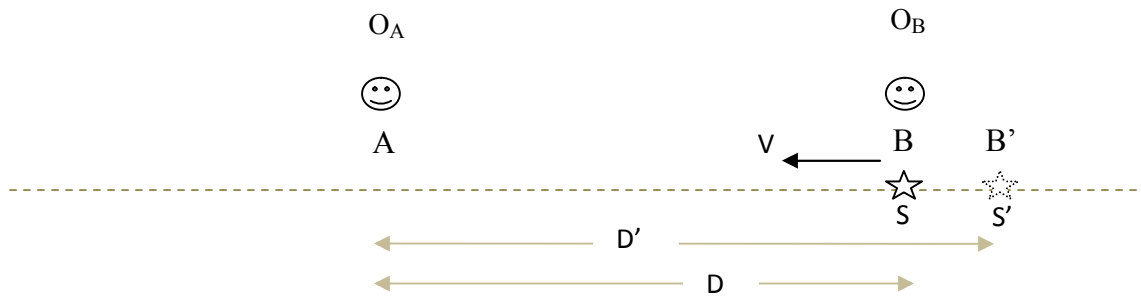

A light source S is moving towards observer O_A . Assume that the source emits a very short light pulse just at the moment it is passing through point B, as seen by observer O_B . The light pulse will be seen by observer O_A after a delay of time. A key idea in this paper is as follows:

For observer O_B , the light beam was emitted from its own position, from point B. For observer O_A , however, the light beam was emitted from the apparent source position, point B' , and not from point B. Obviously, this is counterintuitive at first sight. According to all conventional theories, the light beam starts from the same point in space, for all observers.

Observer O_B witnessed that the source emitted light from point B, from his own position. Who is right? Logically no other observer can be more sure than observer O_B regarding where the source was at the instant of emission, i.e. from which point the light pulse was emitted. This is because observer O_B was in the proximity of the source at the instant of emission.

The solution of this apparent paradox is as follows.

1. For a light source that is at absolute rest, light always starts from the source's physical position, for all moving or stationary observers.
2. For a source that is in absolute motion, however, the apparent point where a light beam started (the past position of the source) is determined by two factors
 - The absolute velocity of the source
 - The distance between the source and the observer *at the instant of emission*.

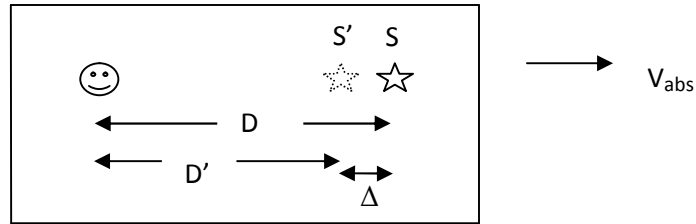

Imagine a light source and an observer in a closed room (Galileo's ship thought experiment). The light source emits a light pulse. The observer wants to know the point in space (in the lab's reference frame) where the light pulse started.

If the laboratory is at absolute rest, the light started from the point where the source physically is, i.e. from point S which is at a distance D from the observer. If the laboratory is in absolute motion, as shown, the light pulse started not from the current/instantaneous point where the source is now, in the lab's frame, but from a point in space S' that is at a distance D' from the observer.

From our previous discussions,

$$D' = D \frac{c}{c + V_{abs}}$$

and

$$\Delta = D - D' = D \frac{V_{abs}}{c + V_{abs}}$$

From the above formula, we see that the point where the light apparently started depends on two factors:

- Physical distance D between source and observer and
- Absolute velocity of the laboratory

This means that for $D = 0$, i.e. source and observer exactly at the same point in space (which is actually not possible, just assumed), the distance Δ between the real source position and the apparent source position will be zero, i.e. the light starts exactly from where the source is physically. For $D = 0$, light always starts from the source.

For a non-zero distance D, however, absolute velocity will have an effect on the apparent position where the light pulse started. As distance D becomes larger and larger, this will 'amplify' (multiply) more and more the effect of absolute velocity. This means that absolute velocity affects the amount of apparent change of position of the light source *through* distance D, because Δ is a *product* of D and $[V_{abs} / (c \pm V_{abs})]$.

Returning back to the case of observers O_A and O_B , for observer O_B the light source started (was emitted by the source) almost from point B, the point through which the source was passing

at the instant of emission. For observer O_A , however, the light started not from point B, but from point B'.

This is the distinctive idea which enabled the resolution of many paradoxes and contradictions between experiments. The *physical meaning* of this apparent change in position of the source will be presented later.

Another contradiction arose on the way to the new theory. Assume an absolutely co-moving system below.

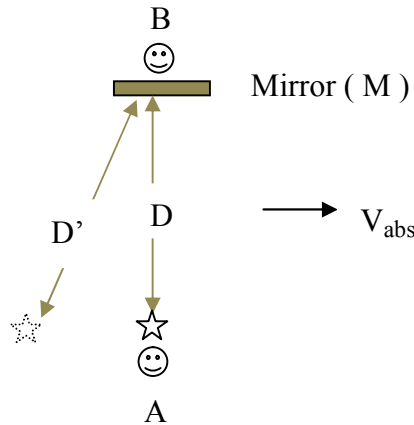

Suppose that a light pulse is emitted from the source towards the mirror M and reflected back to the source (to observer A). We assume that observer A is at the same point in space as the light source, hence, for observer A, the apparent position of the source will be almost the same as the real position of the source, because the effect of absolute velocity will be nullified because observer A is almost at the same point as the source, as discussed above. Hence, observer A will predict that the time delay between emission of the light pulse and its reception (after reflection from mirror) will be:

$$\tau = \frac{2D}{c}$$

From this, observer A predicts that the time interval between emission and reflection at the mirror to be:

$$\frac{\tau}{2} = \frac{D}{c}$$

Assume that A and B each have synchronized clocks. Observer B recorded the time instant when he/she detected the light pulse. Observer B detected light after a delay of

$$\tau = \frac{D'}{c}$$

and not D/c .

Assume that A and B also have a means to communicate instantaneously. Just after a time delay of D/c after emission of the light pulse, observer A calls observer B (through instantaneous

communication) and asks him/her if he/she has just detected the light pulse. Observer B says that the light pulse hasn't arrived yet, because $D' / c > D / c$. This is a paradox !

For observer B, the light started not from the real (physical) position of the source, but from the apparent position of the source and hence the light pulse has to travel a larger path length (D') before arriving at observer B's location.

But a question still arises: How can the light be reflected from the mirror 'before arriving at the mirror', as the time interval (D/c) calculated by observer A for the light pulse to *arrive* at the mirror is less than the time interval (D'/c) of *detection* calculated by observer B ?

This apparent paradox is resolved as follows in the current version of this paper, after a long time of puzzlement since the first version of this paper.

The light pulse *actually*, physically arrives at the mirror (at observer B position) after a delay of D'/c , not after D/c . But for observer A the light pulse always behaves *as if* the forward and backward times are both D/c . This means that for all measurements made at or sufficiently close to the source, absolute motion is 'invisible', i.e. has no observable effect. The effect of absolute motion can be observed only for measurements made at points far enough away from the source. This means that for *all* observations/ measurements made at point of observer A, the light behaves *as if* it took a time delay of D/c to the mirror and D/c back to observer A, so that the round trip time actually measured by observer A will be $2D/c$. This means that if the actual time from source to mirror is D'/c (which is greater than D/c), and if the actual round trip time is $2D/c$, then the actual time delay from mirror back to source should be $2D/c - D'/c$. In fact, this is the only way to determine the time from mirror back to the source, i.e. the back flight time can only be found as 'the round trip time minus the forward flight time'. It follows that the actual forward flight time is greater than the actual backward flight time. This is even more evident in the explanation of the Bryan G.Wallace Venus radar range experiment, to be discussed in a section ahead.

I was content with the above explanation until I found out a serious problem. Conventionally, observer A should always detect the reflected pulse later than observer B detects the light pulse.

This means that

$$\frac{D'}{c} < \frac{2D}{c}$$

But

$$D' = D \frac{c}{\sqrt{c^2 - V_{ab}^2}}$$

Therefore

$$\frac{D'}{c} < \frac{2D}{c} \Rightarrow \frac{D}{\sqrt{c^2 - V_{ab}^2}} < \frac{2D}{c} \Rightarrow V_{ab} < \frac{\sqrt{3}}{2} c$$

Therefore, the condition for observer B detecting the light pulse earlier than observer A detecting the reflected pulse is

$$V_{ab} < \frac{\sqrt{3}}{2} c$$

If

$$V_{ab} > \frac{\sqrt{3}}{2} c$$

then observer A detects the reflected pulse earlier than observer B detects any light pulse ! How can the light pulse reflect from the mirror before/without being detected by observer B ? ! This is either yet another mystery of the speed of light or . . . a deadly blow to the Apparent Source Theory (AST).

Additionally consider the following example, with $D \gg H$

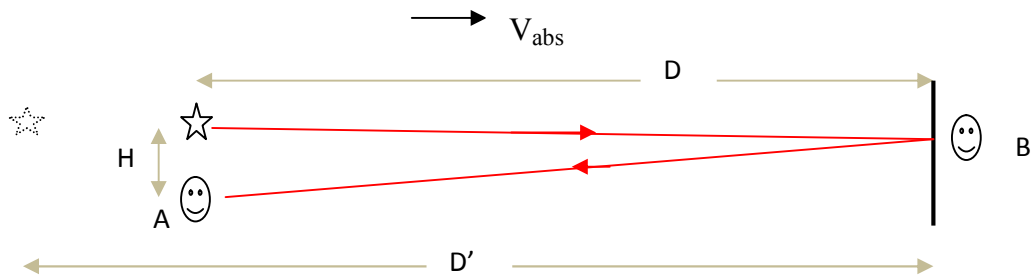

The condition for observer B to detect the light pulse earlier than observer A detects the reflected light is:

$$\frac{2D}{c} > \frac{D}{c - V_{abs}} \Rightarrow V_{abs} < \frac{c}{2}$$

The solution might be in quantum mechanics. Observer B will never detect the same photon that is detected by observer A. The assertion that light has different velocities in different directions fails to explain this. After all, this assertion is rooted in ether theory.

Proposed experiment to test Apparent Source Theory

Consider the following optical experiments. In the first case, a short light pulse is emitted by source S1 and detected by detector R2 which triggers source S2 to emit a short light pulse. Detector R1 detects the light pulse and triggers source S1 to emit another light pulse which will be detected by detector R2 and so on. This is a system of two transponders. A counter counts the number of round trips.

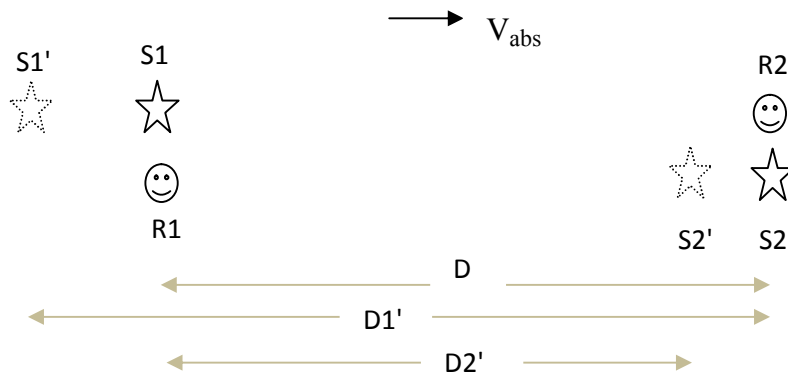

The apparent distance $D1'$ will be:

$$D1' = D \frac{c}{c - V_{abs}}$$

The apparent distance $D2'$ will be:

$$D2' = D \frac{c}{c + V_{abs}}$$

The round trip time will be:

$$\frac{D1' + D2'}{c} = \frac{D}{c - V_{abs}} + \frac{D}{c + V_{abs}} = \frac{2D}{c} \frac{1}{1 - \frac{V_{abs}^2}{c^2}}$$

For $D = 10 \text{ m}$, $V_{abs} = 390 \text{ Km/s}$, the round trip time will be 66.6667793334 ns .

Now consider a different system shown below, with the light source, the detector and the mirror co-moving absolutely .

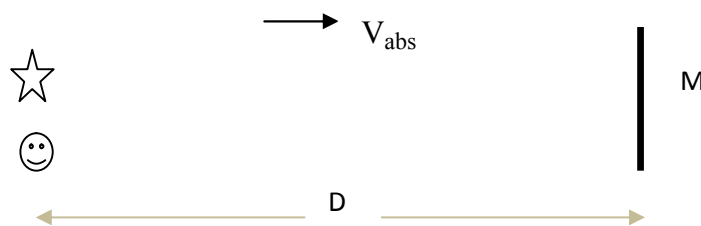

The light source emits a short light pulse towards the mirror. The reflected light is detected by the detector, which triggers the light source to emit another light pulse and so on. A counter counts the number of round trips.

The round trip time will be:

$$2T = \frac{2D}{c}$$

For $D = 10 \text{ m}$, the round trip time will be 66.666666667 ns .

The difference in the round trip times of the above two cases will be

$$\frac{2D}{c} \frac{1}{1 - \frac{V_{abs}^2}{c^2}} - \frac{2D}{c} \approx \frac{2D}{c} \frac{V_{abs}^2}{c^2}$$

Let us see the difference in the number of round trips counted between the two cases, in one day (24 hours). One day is 86400 seconds.

The number of round trips counted in 24 hours the first case is:

$$\frac{86400 \cdot 10^9}{66.6667793334} = 1295997809762$$

The number of round trips counted in 24 hours the second case is:

$$\frac{86400 \cdot 10^9}{66.6666666667} = 1295999999999$$

The difference in the number of round trips of light counted in the two cases, in 24 hours will be

$$1295999999999 - 1295997809762 = 2190237 \text{ counts}$$

In just 10 minutes the difference will be 15,210 counts !

Note that the propagation delay time in the circuits between detection and emission of the light pulses have to be accounted for, in a practical experiment. If the experiment takes long time, for example 24 hours, the axis of the apparatus should always be pointing towards constellation Leo.

2.5. The Sagnac effect

In this section we apply Apparent Source Theory to Sagnac effect. The analysis of (absolute) rotational motion is somewhat different from that of translational motion. In this case we will not take the direct source-observer distance to determine the apparent position of the light source, as in the analysis of absolute translational motion.

Consider a Sagnac device that is at absolute rest, i.e. not in absolute translation and rotation.

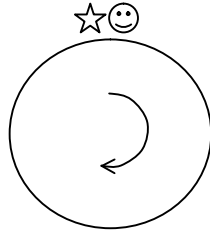

In this case the time delay for the forward and backward beams will be equal.

$$t_d = \frac{2\pi R}{c}$$

Assume now that the device is rotating clockwise with angular velocity ω . We will apply the previous analysis for absolute translational motion. First consider the detector as 'looking' in the forward direction. This will be considered equivalent to a translational motion with co-moving source and detector, with the detector behind the source.

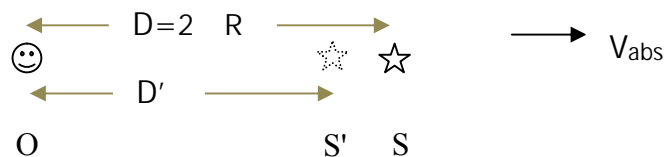

In this case, the source appears to have shifted by an amount Δ towards the observer (detector) O. From previous discussion,

$$D' = D \frac{c}{c + V_{abs}}$$

$$\Delta = D \frac{V_{abs}}{c + V_{abs}}$$

But $D = 2\pi R$, $V_{abs} = \omega R$

$$\Delta_{FW} = 2\pi R \frac{\omega R}{c + \omega R} = \frac{2\omega A}{c + \omega R}$$

where A is area of the circle

Next consider the detector as 'looking' in the backward direction.

This will be considered equivalent to a translational motion with co-moving source and detector, with the detector in front of the source.

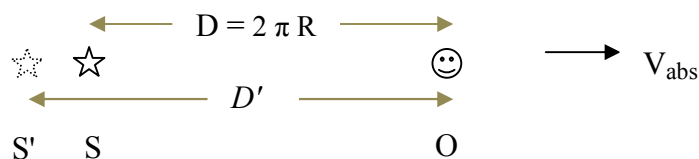

In this case, the source appears to have shifted by an amount Δ away from the detector. From previous discussions,

$$D' = D \frac{c}{c - V_{abs}}$$

$$\Delta = D \frac{V_{abs}}{c - V_{abs}}$$

but $D = 2R$, $V_{abs} = \omega R$

$$\Delta_{BW} = 2\pi R \frac{\omega R}{c - \omega R} = \frac{2\omega A}{c - \omega R}$$

The total path difference will be the sum of Δ_{FW} and Δ_{BW} .

$$\Delta = \Delta_{FW} + \Delta_{BW} = \frac{2\omega A}{c + \omega R} + \frac{2\omega A}{c - \omega R} = \frac{4\omega A c}{c^2 - (\omega R)^2}$$

This can be written as:

$$\Delta = \frac{\frac{4\omega A}{c}}{1 - \left(\frac{\omega R}{c}\right)^2} \approx \frac{4\omega A}{c}, \quad \text{for } \omega R \ll c$$

The new interpretation according to Apparent Source Theory is as follows. Relative to the detector, the position of the source appears to have shifted towards the detector by an amount $2A / (c + \omega R)$, when looking in the direction of rotation and the position of the source appears to have shifted away from the detector by an amount $2A / (c - \omega R)$, when looking in the opposite direction.

The above analysis is for a hypothetical Sagnac interferometer, in which a hypothetical light source emits a photon in opposite directions, so that it interferes with itself at the detector, without using a beam splitter. Unlike the Michelson Morley experiment, apparent shift of source position creates a fringe shift for the same reason that a physical change of source position will create a fringe shift: one of the light paths will be shortened and the other path will be lengthened.

The analysis of the hypothetical Sagnac interferometer is helpful in understanding the operation of the real Sagnac interferometer shown below. George Sagnac derived the formula for path difference of the two counter-propagating light beams by assuming the ether, and the prediction agreed with experiment.

The question is: if the ether doesn't exist, how can a formula based on ether hypothesis correctly predict the result of the Sagnac experiment? This has been one of the most challenging problems I faced even after the development of Apparent Source Theory (AST). AST can easily explain the hypothetical Sagnac interferometer, but I am yet to figure out how to apply it to the real Sagnac interferometer as the analysis can be complicated or difficult to figure out.

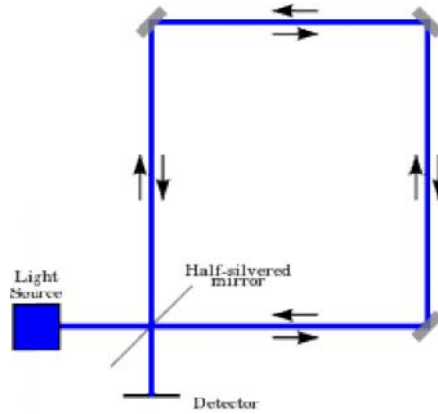

In this paper I do not attempt to derive the formula for the path difference by applying Apparent Source Theory.

But I guessed that, *for small velocities, say $\omega R = 10 \text{ m/s}$, the prediction of Apparent Source Theory is almost the same as that of ether theory, for the Sagnac experiment!*

For example, for a light source shining at ninety degrees towards a mirror, so that the light reflects back on itself, the incident and reflected ‘wavelengths’ are, respectively

$$\lambda_{INC} = \frac{c - V_{abs}}{f}, \quad \lambda_{REF} = \frac{1}{f} \cdot \frac{c(c - V_{abs})}{c - 2V_{abs}}$$

According to the ether theory, the wave length of the reflected light is

$$\lambda_{REF} = \frac{c + V_{abs}}{f}$$

The difference between the ‘wave length’ of reflected light predicted by Apparent Source Theory and that predicted by ether theory is (see ‘Silvertooth Experiment’, next section):

$$\lambda = \frac{1}{f} \cdot \frac{c(c - V_{abs})}{c - 2V_{abs}} - \frac{c + V_{abs}}{f} = \frac{1}{f} \cdot \frac{2V_{abs}^2}{c - 2V_{abs}}$$

If we consider the relative magnitude of this difference in ‘wavelength’ compared to the wavelength of reflected light according to AST:

$$\frac{\frac{1}{f} \cdot \frac{2V_{abs}^2}{c - 2V_{abs}}}{\frac{1}{f} \cdot \frac{c(c - V_{abs})}{c - 2V_{abs}}} = 2 \frac{V_{abs}^2}{c(c - V_{abs})} \approx \frac{2V_{abs}^2}{c^2}, \quad \text{for } V_{abs} \ll c$$

For small absolute velocities this is close to zero, meaning the predictions of AST and ether are nearly the same, in this case. Even though the change in ‘wave length’ does not have any direct

relevance to the Sagnac effect, the above analysis is meant to show that ether theory can be used for small velocities, in some cases, and this might also include the Sagnac effect.

At such small velocities, the light speed behaves as if the ether existed, in the case of Sagnac experiment. Hence, the Sagnac effect can be analyzed by assuming the ether, even though the ether doesn't exist. Application of the Apparent Source Theory to the real Sagnac interferometer is yet to be worked out. This is important for the analysis of a theoretical Sagnac interferometer with large velocities, say $\omega R = 0.1c$. The Sagnac formula may not correctly predict the fringe shift of the real Sagnac interferometer, at high velocities. Note that the Apparent Source Theory correctly explains the hypothetical Sagnac interferometer for any velocity.

No significant bending of light rays (see ‘ Physical meaning’ section) exists at small velocities

As another example consider the following.

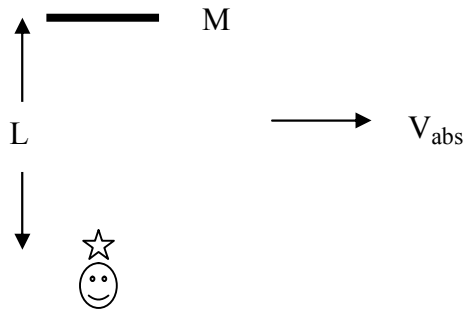

The source emits light towards the mirror at ninety degrees, the light reflects back to the observer. According to Apparent Source Theory, the total travel time of the light is

$$T = \frac{2L}{c}$$

According to ether theory

$$T = \frac{2L}{\sqrt{c^2 - V_{abs}^2}} = \frac{\frac{2L}{c}}{\sqrt{1 - \frac{V_{abs}^2}{c^2}}}$$

It can be shown that the two expressions are almost equal for small absolute velocities (for example, 10 m/s) but deviate from each other as absolute velocity becomes larger and larger.

The above examples are meant to demonstrate that, Sagnac’s experiment can be analyzed by the ether theory, even though the ether doesn’t exist. This shouldn’t be taken as implying that Michelson-Morley experiment can also be analyzed by using ether theory for small absolute velocities.

2.6. The Silvertooth experiment

In this section Apparent Source Theory (AST) will be applied to the Silvertooth experiment. The diagram below is taken from Silvertooth's paper of 1989 from the journal Electronics and Wireless World.

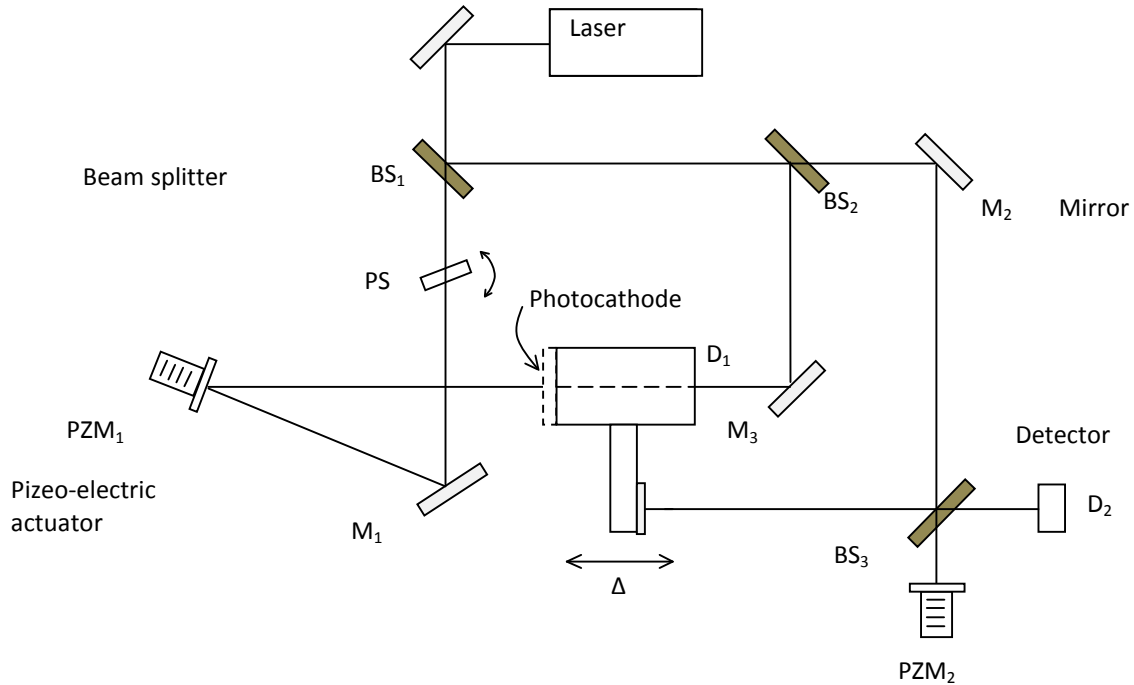

The Silvertooth experiment is the other crucial evidence of absolute motion.

In this section, the 'wavelength change effect' in Silvertooth experiment will be explained.

Imagine a light source S, an observer O and a mirror M, co-moving with absolute velocity V_{abs} to the right as shown below.

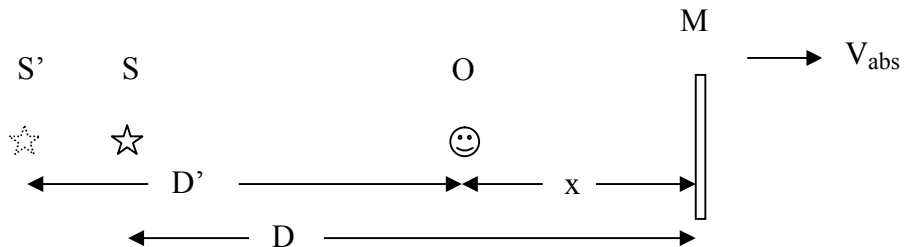

'Wavelength' and velocity of incident light

Light emitted by S at time $t = 0$ will be received by observer O after time delay t_d .

From the previous discussions:

$$D' = D \frac{c}{c - V_{abs}}$$

(note that D in this equation is not the one shown in the above figure)

Substituting $D - x$ in place of D

$$D' = (D - x) \frac{c}{c - V_{abs}}$$

Time delay will be

$$t_d = \frac{D'}{c} = \frac{D - x}{c - V_{abs}}$$

Assume that the source emits according to

$$\sin \omega t$$

The light wave will be received at the detector as

$$\begin{aligned} \sin \omega(t - t_d) &= \sin \omega \left(t - \frac{D}{c - V_{abs}} + \frac{x}{c - V_{abs}} \right) \\ &= \sin \left(\omega t - \frac{\omega D}{c - V_{abs}} + \frac{\omega x}{c - V_{abs}} \right) \end{aligned}$$

The above is a wave equation. If we take a 'snapshot' of the wave at an instant of time $t = \tau$, the above equation will be:

$$\sin \left(\omega \tau - \frac{\omega D}{c - V_{abs}} + \frac{\omega x}{c - V_{abs}} \right)$$

The two terms $\omega \tau$ and $\omega D / (c - V_{abs})$ represent constant phases. The 'wavelength' is determined from the third term:

$$\frac{\omega x}{c - V_{abs}}$$

If we have a function

$$\sin kx$$

then the wavelength can be shown to be

$$\frac{2\pi}{k}$$

In the same way, for the function

$$\sin \left(\frac{\omega x}{c - V_{abs}} \right)$$

$$k = \frac{\omega}{c - V_{abs}}$$

Hence the 'wave length' of the incident light will be

$$\lambda_{INC} = \frac{2\pi}{k} = \frac{2\pi}{\frac{\omega}{c - V_{abs}}} = (c - V_{abs}) \frac{2\pi}{\omega} = \frac{c - V_{abs}}{f}$$

Note that the 'wavelengths' predicted here are different in form from the 'wavelength' predicted by Silvertooth, in his paper, but the results obtained are nearly the same as will be shown shortly.

This shows an *apparent* change in wavelength and hence an apparent change of speed of light relative to the observer, for absolutely co-moving source and observer. However, to interpret this as an actual/real change in wavelength is wrong or inaccurate. Neither the wavelength nor the phase velocity has changed. To understand this rather confusing statement, the best way is to ask: assuming Galilean space, will an *actual*/physical change of the position of the source result in change of speed or wavelength observed by the observer, for co-moving source and observer? Obviously no. For the same reason, an *apparent* change in the position of the source should not result in change of wavelength and speed of light. This can be confirmed by measuring the wavelength with a spectroscope. The independence of wavelength and speed of light from Earth's absolute velocity has been confirmed because no variation of spectroscopic measurements of characteristic wavelengths emitted by atoms has ever been observed or reported. The Ives-Stilwell experiment confirms that absolute velocity of the Earth doesn't affect phase velocity and wavelength of light, because, if it did, large variations in 'transverse Doppler shift' would be observed in different experiments due to possible variations in orientation of the experimental apparatus, as the ion velocity in the Ives-Stilwell experiment ($\approx 1000\text{Km/s}$) is comparable to Earth's absolute velocity (390 Km/s).

The apparent wavelength pattern observed in the Silvertooth experiment arises due to Apparent Source Theory. This means that for every point, the apparent position of the light source is different. For material waves, such as the sound wave, the wave starts from the same point for all observers in the same reference frame. In AST, the apparent past position of the light source (the point where it was at the instant of emission) is different for different observers at different positions (distance and direction) even if they are in the same reference frame.

Wavelength and velocity of reflected light

Next we determine the wavelength of the reflected light.

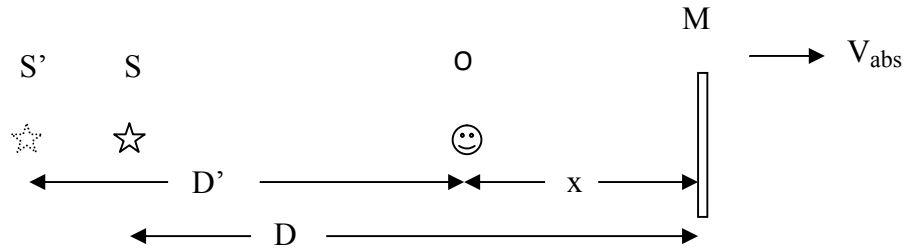

Time delay between emission and reception before reflection of light from mirror M, at point x, has been determined as follows (preceding section).

$$D' = (D - x) \frac{c}{c - V_{abs}}$$

Relative to an observer at point x, who is observing the reflected light, time delay between emission and reception of reflected light will be:

$$\begin{aligned} t_d &= \frac{D'}{c} + \frac{2x}{c} = \frac{D - x}{c - V_{abs}} + \frac{2x}{c} \\ &= \frac{D}{c - V_{abs}} - x \left(\frac{1}{c - V_{abs}} - \frac{2}{c} \right) \\ &= \frac{D}{c - V_{abs}} + x \frac{c - 2V_{abs}}{c(c - V_{abs})} \end{aligned}$$

If the source emits light according to

$$\sin \omega t$$

The reflected light wave will be received at point x as

$$\sin \omega(t - t_d) = \sin \omega \left(t - \frac{D}{c - V_{abs}} - x \frac{c - 2V_{abs}}{c(c - V_{abs})} \right)$$

The coefficient of x is:

$$k = \omega \frac{c - 2V_{abs}}{c(c - V_{abs})}$$

As before, the 'wavelength' of reflected light will be:

$$\lambda_{REF} = \frac{2\pi}{k} = \frac{2\pi}{\omega \frac{c - 2V_{abs}}{c(c - V_{abs})}}$$

$$= \frac{c(c - V_{abs})}{f(c - 2V_{abs})} = \frac{1}{f} \cdot \frac{c(c - V_{abs})}{c - 2V_{abs}}$$

Conventionally, one would expect the 'wave length' of the reflected light to be equal to $(c + V_{abs}) / f$, because the 'wavelength' of incident light is $(c - V_{abs}) / f$, such as in ether theory. However, it turned out in the above analysis that this is not the case. However, it can be shown that the actual difference between the two expressions is very small, as will be shown below.

The absolute velocity of the earth is known to be $V_{abs} = 390 \text{ Km/s}$

$$\begin{aligned} \lambda_{REF} &= \frac{1}{f} \cdot \frac{c(c - V_{abs})}{c - 2V_{abs}} \\ &= \frac{1}{f} \cdot \frac{300000(300000 - 390)}{300000 - 2 * 390} \\ &= \frac{1}{f} * 300,391 \text{ Km} \end{aligned}$$

According to classical (ether) theory

$$\begin{aligned} \lambda_{REF} &= \frac{1}{f} \cdot (c + V_{abs}) \\ &= \frac{1}{f} * (300,000 + 390) = \frac{1}{f} * 300,390 \text{ Km} \end{aligned}$$

The difference between the two apparent velocities is only 1 Km/s , which is only about 0.25% of 390 Km/s .

Note again that this is not the real wavelength which is equal to $\lambda = c / f$. It is only an apparent wavelength. The apparent incident and reflected wavelengths differ as observed by Silvertooth and as shown above. The real incident and reflected wavelengths, which can be measured by a spectroscope, are both : $\lambda = c / f$.

In the above analyses, we considered the simplest cases in which the source, the observer and the mirror are in line, with the light beam incident perpendicularly on a mirror and reflected back on itself. It is possible to extend the analysis to more general cases for a better clarification of the theory (AST). In the next section we will look at the application of AST to some of these cases. As the resulting solutions are more complicated (but straight forward) , we will only look at how to proceed.

Let us see at a case in which the source - observer relative position is perpendicular to the absolute velocity.



From previous discussions

$$t_d = \frac{D'}{c} = \frac{D}{\sqrt{c^2 - V_{abs}^2}}$$

If the source emits according to

$$\sin \omega t$$

then the light received will be

$$\sin \omega(t - t_d)$$

Next consider the following case, as in Doug Marett's replication of Silvertooth experiment [2]. An observer at point x will observe the incident light (light reflected from mirror M1, but before reflection from mirror M2) and the reflected light (light reflected from mirror M2).

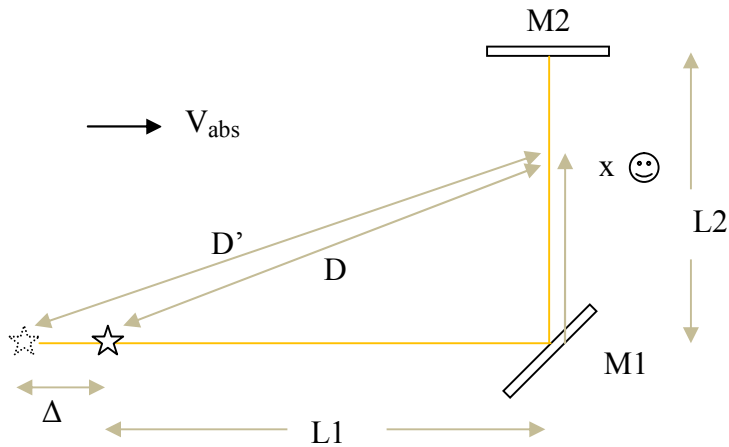

To analyze this problem, we first have to determine the apparent change (Δ) in position of the source as seen from point x , due to absolute motion.

The time delay of the incident light will be

$$t_d = \frac{\Delta + L1 + x}{c}$$

But

$$\frac{D'}{c} = \frac{\Delta}{V_{abs}}$$

The above equation means that the time it takes a *direct* light beam to reach the observer from the apparent source position S' to point x is equal to the time it takes for the source to move from position S' to position S. Note that we have assumed a direct light beam from point S' to point x to determine the apparent change in the position of the source (Δ) for an observer at point x, even though there is no direct light beam from the source to the observer in this case (i.e. the observer sees only light reflected from mirror M1 in this case)

Also

$$(\Delta + L1)^2 + x^2 = D'^2$$

and

$$L1^2 + x^2 = D^2$$

From the last three equations, the solution for Δ can be obtained as follows.

$$(\Delta + L1)^2 + x^2 = D'^2$$

$$(\Delta + L1)^2 = \frac{c^2 \Delta^2}{V_{abs}^2} - x^2$$

resulting in the quadratic equation

$$\Delta^2 \left(\frac{c^2}{V_{abs}^2} - 1 \right) - \Delta(2L1) - (L1^2 + x^2) = 0$$

The solution for Δ will be:

$$\Delta = \frac{2L1 + \sqrt{4L1^2 + 4 \left(\frac{c^2}{V_{abs}^2} - 1 \right) (L1^2 + x^2)}}{2 \left(\frac{c^2}{V_{abs}^2} - 1 \right)}$$

Now the time delay t_d can be obtained in terms of x from the previous equation:

$$t_d = \frac{(\Delta + L1 + x)}{c}$$

The solution for Δ shows that time delay varies with x in a more complex (non-linear) way. It can be seen that the time delay does not depend on x but on higher powers of x . This results in dependence of the apparent wavelength on x, along x , which is unconventional. This shows that what was measured by Silvertooth is not real wavelength, because real wavelength does not change along the path of light.

For the reflected light, the equation for time delay t_d will be :

$$t_d = \frac{\Delta + L1 + x + 2(L2 - x)}{c}$$

The equation for Δ obtained above should be substituted in the above equation to determine the time delay and hence the 'wave length ' of the reflected light.

Now that we have understood at a basic level the 'wavelength change' observed in the Silvertooth experiment, by applying the Apparent Source Theory, next we attempt to analyze the actual Silvertooth experiment.

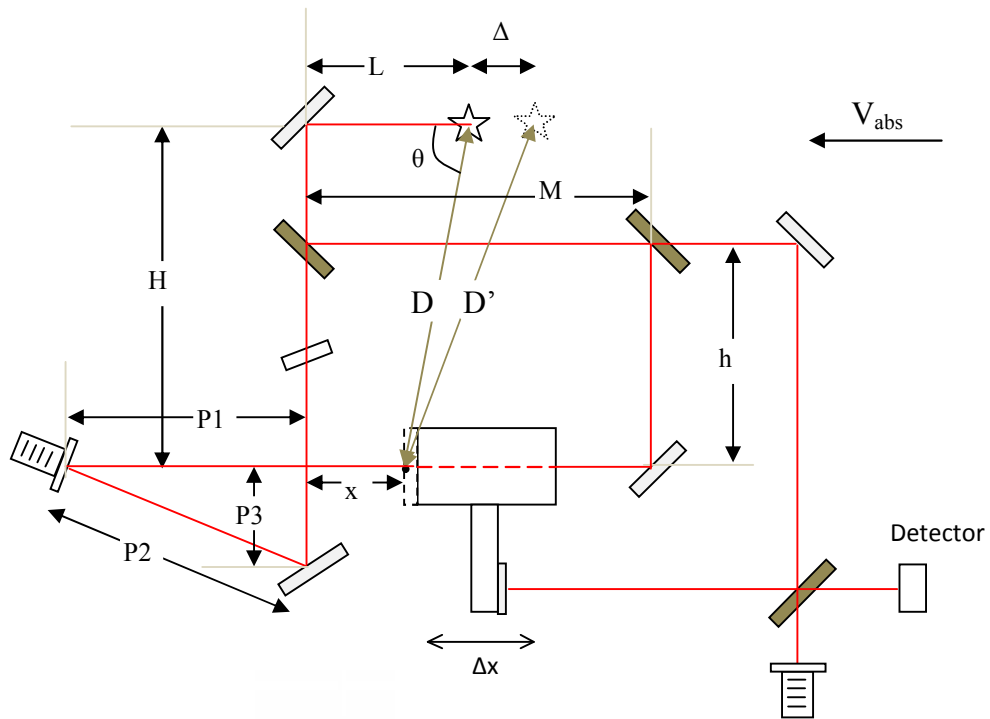

$$\frac{D'}{c} = \frac{\Delta}{V_{abs}} \dots \dots \dots (1)$$

$$\sqrt{D'^2 - H^2} - \sqrt{D^2 - H^2} = \Delta \dots \dots \dots (2)$$

$$L - \sqrt{D^2 - H^2} = x \dots \dots \dots (3)$$

From equation (3)

$$(L - x)^2 = D^2 - H^2 \Rightarrow D = \sqrt{(L - x)^2 + H^2}$$

From equation (1)

$$D' = \Delta \frac{c}{V_{abs}}$$

Substituting for D' in equation (2)

$$\sqrt{\Delta^2 \frac{c^2}{V_{abs}^2} - H^2} - \sqrt{D^2 - H^2} = \Delta$$

After some manipulations we get a quadratic equation in Δ :

$$\Delta^2 \frac{c^2}{V_{abs}^2} - 2\Delta(L-x) - (H^2 + (L-x)^2) = 0, \text{ for } V_{abs} \ll c$$

From which

$$\begin{aligned} \Delta &= \frac{V_{abs}^2}{c^2} (L-x) + \frac{V_{abs}^2}{c^2} \sqrt{(L-x)^2 + \frac{c^2}{V_{abs}^2} (H^2 + (L-x)^2)} \\ &= \frac{V_{abs}^2}{c^2} (L-x) + \frac{V_{abs}^2}{c^2} \sqrt{(L-x)^2 \left(1 + \frac{c^2}{V_{abs}^2}\right) + \frac{c^2}{V_{abs}^2} H^2} \\ &= \frac{V_{abs}^2}{c^2} (L-x) + \frac{V_{abs}}{c} \sqrt{(L-x)^2 + H^2}, \quad \text{for } V_{abs} \ll c \\ &= \frac{V_{abs}}{c} \sqrt{(L-x)^2 + H^2}, \quad \text{for } V_{abs} \ll c \end{aligned}$$

Δ is a non-linear function of x.

For a given value of x_0 , Δ can be approximated as a linear function for values of x close to x_0 .

$$\begin{aligned} \frac{d\Delta}{dx} &= \frac{V_{abs}}{c} \left(\frac{-(L-x)}{\sqrt{(L-x)^2 + H^2}} \right) \\ \frac{d\Delta}{dx} (\text{at } x = x_0) &= \frac{V_{abs}}{c} \left(\frac{-(L-x_0)}{\sqrt{(L-x_0)^2 + H^2}} \right) = -\frac{V_{abs}}{c} K_0 = -\frac{V_{abs}}{c} \cos \theta \end{aligned}$$

But

$$(\text{at } x = x_0) = 0 = \frac{V_{abs}}{c} \sqrt{(L-x_0)^2 + H^2}$$

Therefore

$$= \Delta_0 + \frac{d\Delta}{dx}x = \Delta_0 - K_0 \frac{V_{abs}}{c} x \quad (\text{at } x = x_0)$$

Now that Δ has been determined, the two light waves can be determined. There are two waves propagating across the detector D1, one from right to left, the other from left to right.

Assume that the laser emits according to

$$A \sin(\dots t)$$

The path length for the left to right wave will be:

$$pl_{LR} = \Delta + L + H + P3 + P2 + P1 + x$$

The time delay will be

$$\tau_{LR} = \frac{pl_{LR}}{c} = \frac{\Delta + L + H + P3 + P2 + P1 + x}{c}$$

Therefore, the left to right wave will be

$$\begin{aligned} A_{x1} \sin \omega(t - \tau_{LR}) &= A_{x1} \sin \omega \left(t - \frac{\Delta + L + H + P3 + P2 + P1 + x}{c} \right) \\ &= A_{x1} \sin \omega \left(t - \frac{\Delta_0 - K_0 \frac{V_{abs}}{c} x + L + H + P3 + P2 + P1 + x}{c} \right) \end{aligned}$$

At a given time $t = \tau$, the 'snap shot' picture of the wave will be

$$\begin{aligned} &= A_{x1} \sin \omega \left(\tau - \frac{\Delta_0 - K_0 \frac{V_{abs}}{c} x + L + H + P3 + P2 + P1 + x}{c} \right) \\ &= A_{x1} \sin \omega \left(\tau - \frac{\Delta_0 + L + H + P3 + P2 + P1}{c} - x \left(\frac{1}{c} - K_0 \frac{V_{abs}}{c^2} \right) \right) \end{aligned}$$

The coefficient of x is

$$\omega \left(\frac{1}{c} - K_0 \frac{V_{abs}}{c^2} \right)$$

Therefore, the 'wave length' of the left to right wave will be

$$\lambda_{LR} = \frac{2\pi}{\omega \left(\frac{1}{c} - K_0 \frac{V_{abs}}{c^2} \right)} = \frac{\lambda}{1 - K_0 \frac{V_{abs}}{c}}$$

Likewise the path length of the right to left wave will be

$$pl_{RL} = \Delta + L + (H - h) + M + h + (M - x)$$

Therefore, the right to left wave will be

$$\begin{aligned} A_{x2} \sin\omega(t - \tau_{RL}) &= A_{x2} \sin\omega\left(t - \frac{\Delta + L + (H - h) + M + h + (M - x)}{c}\right) \\ &= A_{x2} \sin\omega\left(t - \frac{L_0 - K_0 \frac{V_{abs}}{c} x + L + (H - h) + M + h + (M - x)}{c}\right) \end{aligned}$$

At a given time $t = \tau$, the 'snap shot' picture of the wave will be

$$\begin{aligned} &= A_{x2} \sin\omega\left(\tau - \frac{L_0 - K_0 \frac{V_{abs}}{c} x + L + (H - h) + M + h + (M - x)}{c}\right) \\ &= A_{x2} \sin\omega\left(\tau - \frac{L_0 + L + (H - h) + M + h + M}{c} + x\left(K_0 \frac{V_{abs}}{c^2} + \frac{1}{c}\right)\right) \end{aligned}$$

The coefficient of x is

$$\omega \left(K_0 \frac{V_{abs}}{c^2} + \frac{1}{c}\right)$$

Therefore, the 'wave length' of the right to left wave will be

$$\lambda_{RL} = \frac{2\pi}{\omega \left(K_0 \frac{V_{abs}}{c^2} + \frac{1}{c}\right)} = \frac{\lambda}{1 + K_0 \frac{V_{abs}}{c}}$$

According to Silvertooth, and classical formula

$$\lambda' = \frac{\lambda}{\left(1 \pm \frac{V_{abs}}{c}\right)}$$

There is a discrepancy between the formula based on the Apparent Source Theory (AST), which contains the factor K_0 , and the classical formula. Even though Silvertooth's theory is not clear and may not be correct, his experimental results closely agree with the classical formula and with the CMBR frequency anisotropy measurement. So it may seem that AST is not in agreement with Silvertooth's experiment. But there is also a possibility that K_0 is close to unity in the Silvertooth experiment. For example, if $L - x = 4H$, then $K_0 = 0.97$. ($K_0 \approx 1$, for $L - x \gg H$).

Unfortunately Silvertooth did not provide these dimensions in his papers. This is perhaps the most serious challenge facing AST.

But there are some problems in the above analysis. The laser source has been considered to be a point source, whose position has not been clearly specified. It might be correct to represent the laser source by a coherent point source. But how is the position of the point source representing the laser determined? Even though a photon from a laser is emitted from many atoms, the light acts as a single photon. Therefore, it is logical to represent the laser with a single point source. This is unlike non-coherent light sources. Assuming that Apparent Source Theory is correct, the laser beam would lose its coherence if the individual photon emitting atoms inside a laser acted as independent sources. If the laser can be represented as a single point source, the next logical question becomes: how is the position of that point source determined?

If we assume Apparent Source Theory to be correct, then from the result of the experiment, the laser in the Silvertooth experiment is to be represented as a point source placed at a position which will give the experimental result. This means that the laser should be represented by a point source placed farther to the right, for example at $L - x = 4H$.

The above hypothesis can be tested by the following (theoretical) experiment. The distance D of a point source representing a laser can be determined experimentally as follows.

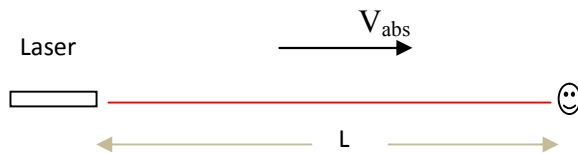

The laser has been represented as a single coherent point source, as shown below.

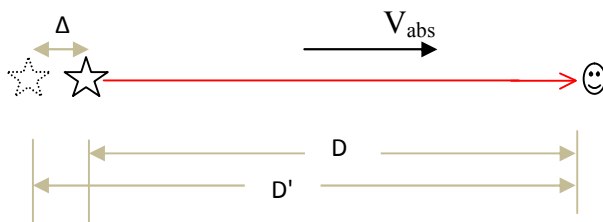

The problem is to determine the ‘physical’ distance D of a point source representing the laser, for some arbitrary distance L between the laser and an observer.

From our discussions so far:

$$= D \frac{c}{c - V_{abs}}$$

The experimental setup is initially at absolute rest. Then the phase of the laser is compared with the phase of a local coherent light source which has the same wavelength. This experiment is hypothetical because current technology lasers do not have the degree of coherence required for this experiment. (But, I think, a method might be devised to do this experiment even with real lasers ?). The whole experimental setup is then moved to the right with a known absolute velocity V_{abs} . The fringe shift is counted, from which Δ can be determined. Distance D can then be determined from the above equation and the hypothesis that the laser is represented by a point source placed at some position can also be confirmed.

This is just an attempt to explain the discrepancy between Apparent Source Theory and the Silvertooth experiment. Assuming Apparent Source Theory to be correct, I speculated that the laser should be represented by a point source farther to the right so as to explain the result of the Silvertooth experiment.

A Replication of the Silvertooth Experiment

Doug Marett performed a modified version of the Silvertooth experiment [2].

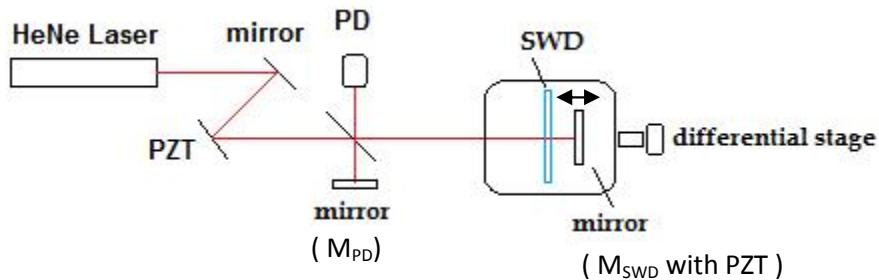

Doug Marett reported that he detected phase shift of the SWD voltage as the stage is moved, with the mirror M_{SWD} and the SWD detector co-moving with the stage. The M_{SWD} is also actuated with a triangle wave. How can movement of the stage create phase variation of the SWD voltage, with the mirror and the SWD sensor co-moving with the stage [20] ?

In all of the original Silvertooth experiments, two light beams pass through the SWD detector in opposite directions. As the stage is moved, the path of one beam is shortened, and the path of the opposite beam lengthened. In this case it is not difficult to figure out how the phase of the SWD voltage changes, as the stage is moved. In the Doug Marett's experiment, the standing wave is locked to the mirror and moves with it. So the position of the detector does not change relative to the standing wave. Since the paths of the two opposite beams always change equally as the stage is moved, there would be no change in phase relationship between the incident and reflected light beams. Then how does the phase change at the SWD occur?

Even if we assumed ether (as Silvertooth did), or any material wave such as a sound wave, Doug Marett's version of the experiment should not result in change in relative phases of the incident and reflected waves. Since the amplitude of the SWD at the surface of the mirror is always zero, the amplitude of the standing wave at the SWD detector should not vary as the stage is moved; the amplitude of the standing wave should change at the SWD only if its distance from M_{SWD} is changed. Only the distance of the SWD from the M_{SWD} matters. The distance from the laser or from the PZT is irrelevant when determining the phase relationship between the incident and the reflected light at the SWD. The SWD detector is always stationary relative to the SWD pattern, as the stage is moved. The standing wave is locked to the mirror.

The above argument, however, does not take into consideration the effect of the laser beam reflecting into the laser, hence forming a kind of resonant cavity.

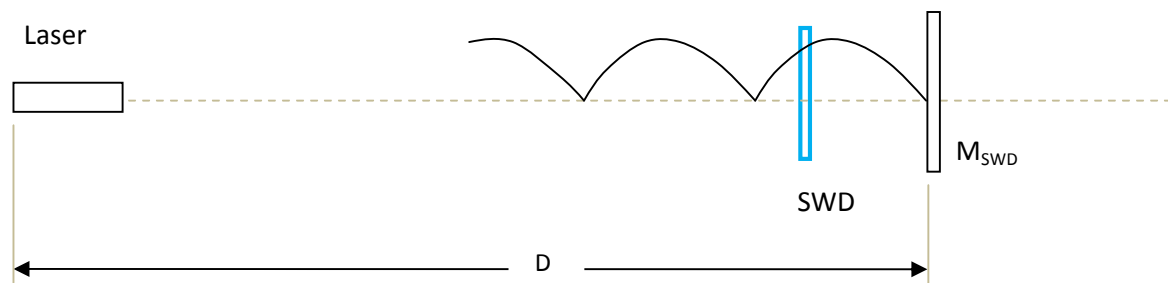

If we consider the whole optical system as a resonant cavity, then the distance D between the laser and the mirror becomes important. The standing wave will be maximum when D is an integral multiple of half wave lengths. If D is not equal to an integral multiple of half wave lengths, the resonant system will be detuned and the amplitude of the standing wave will decrease at all points between the laser and the mirror. However, the standing wave is always locked to the mirror. So, as the distance between the laser and the mirror is changed, the standing wave pattern does not shift relative to the detector, but its amplitude will change.

Now, how does dithering the mirror affect the voltage at the detector? If we consider the optical system as a resonator system, then a movement of the mirror will make the system to be closer to or farther from resonance condition. If the movement of the mirror makes the distance D closer to being an integral multiple of half wavelengths, the optical system will be closer to resonance and the amplitude of the standing wave will increase at all points. If the movement of the mirror makes the difference between distance D and an integral multiple of half wavelengths larger and larger, the optical system will be detuned and the standing wave will be suppressed at all points. This is why the same movement of the mirror results an increase in the SWD voltage for some values of D and a decrease in the SWD voltage for other values of D .

The effect of absolute motion creates an apparent difference in wave lengths of the incident and reflected lights.

2.7 Modern Michelson-Morley experiments

We will look at the experiment performed by Muller et al [19].

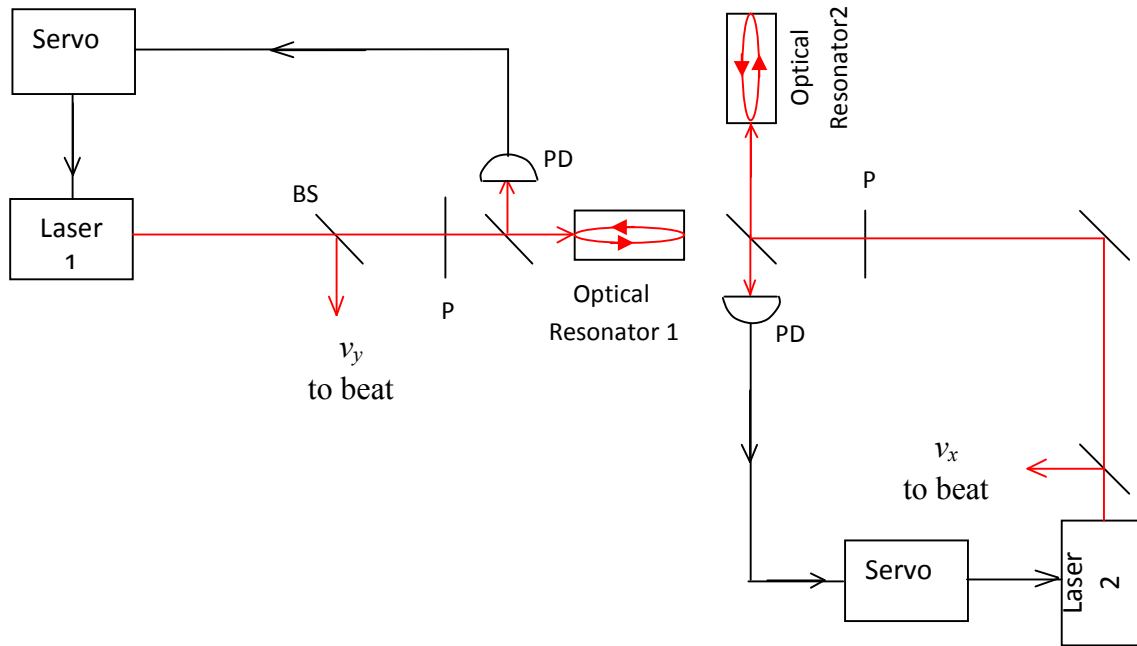

Let us consider one of the two optical resonator systems.

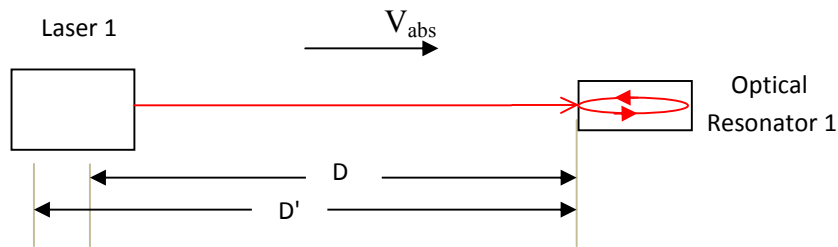

The laser has been represented as a single coherent point source, as shown below.

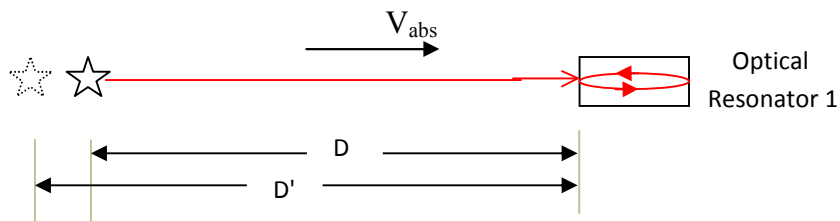

Let us just assume that the point source is at distance D from the optical cavity.

According to Apparent Source Theory, the effect of absolute motion for co-moving source and observer is to create an apparent change in the position of the source as seen by the observer. Therefore, to an observer at the inlet of the optical resonator, for example, the source appears to be farther than its actual position for the absolute velocity shown in the above diagram. For all observers at all points along the path of light and at all points inside the optical resonator, the effect of absolute motion is simply to create an apparent change in the position of the source; the source appears farther than it actually (physically) is.

The procedure of analysis, as discussed already, is:

1. Replace the real source with an apparent source
2. Solve the problem by assuming Galilean space and (modified) emission theory.

All we need is to answer is: what is the effect of apparent change of source position, which is equivalent to physical/real change of source position ?

Obviously, the apparent or physical position of the source inside the laser does not have any significant effect on the resonance frequency of the resonator.

The Muller et al experiment was conceived by assuming that absolute motion would change the resonance frequency of the resonator. This means that, if the laser frequency is constant, the resonator would be slightly detuned due to changes in absolute velocity(by rotating the apparatus), which would result in decreasing of the amplitude of the wave at all points inside the cavity resonator. But changing the distance between the laser and the optical cavity does not affect the resonance frequency/wavelength of the cavity.

2.8. The Marinov Coupled Shutters Experiment

In this section the Marinov experiment is explained by the Apparent Source Theory.

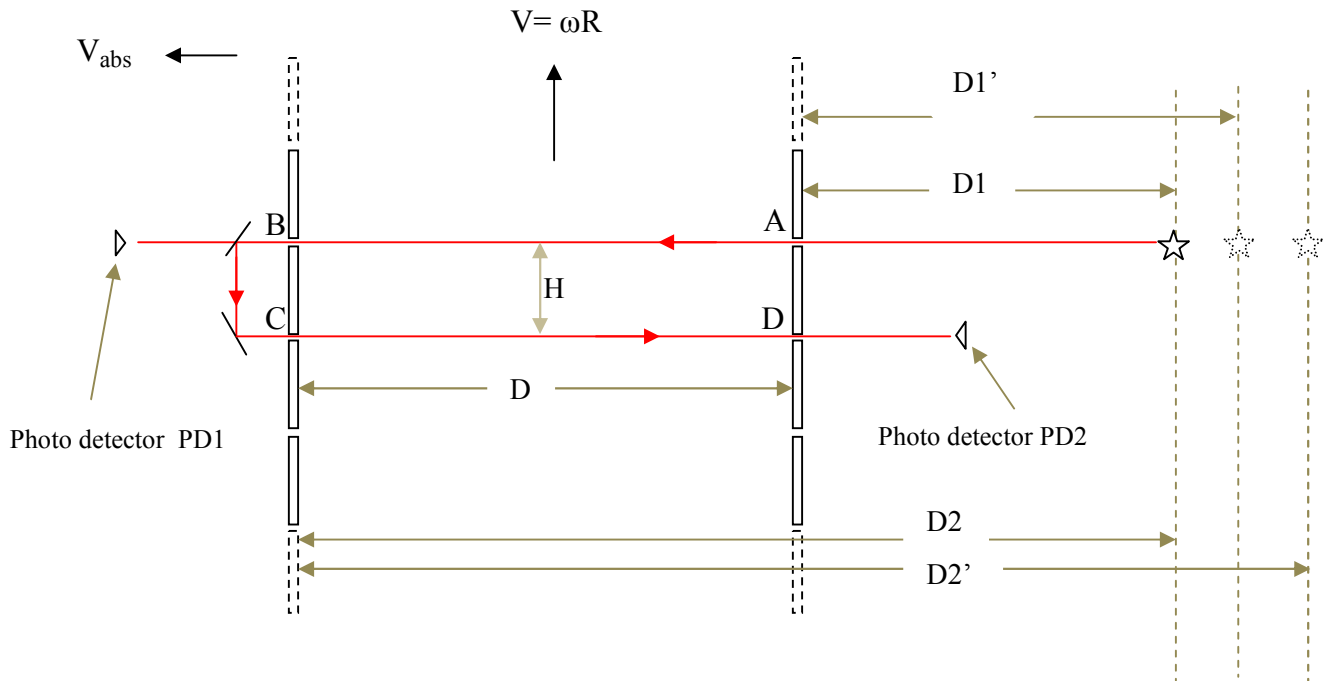

We assume a linearly translating long apparatus for simplicity.

Two photo detectors, PD1 and PD2 are placed as shown. Assume that four other photo detectors (not shown in the figure above) are placed at the four holes, at points A, B, C and D, just at the outlets/inlets of the holes. Assume that the light source emits a very short light pulse at time $t=0$. First we determine the time interval between detection of the light pulse at points B and A.

$$D1' = D1 \frac{c}{c - V_{abs}}$$

and

$$D2' = D2 \frac{c}{c - V_{abs}}$$

The time delay for light detection at point A will be

$$T_A = \frac{D1'}{c} = \frac{D1 \frac{c}{c - V_{abs}}}{c} = \frac{D1}{c - V_{abs}}$$

The time delay for light detection at point B will be:

$$T_B = \frac{D2'}{c} = \frac{D2 \frac{c}{c - V_{abs}}}{c} = \frac{D2}{c - V_{abs}}$$

The time taken by light to move from A to B:

$$\begin{aligned} T_{AB} &= T_B - T_A = \frac{D2}{c - V_{abs}} - \frac{D1}{c - V_{abs}} \\ &= \frac{D2 - D1}{c - V_{abs}} = \frac{D}{c - V_{abs}} \end{aligned}$$

The velocity of light propagation between the holes is :

$$\frac{D}{T_{AB}} = c - V_{abs}$$

As the absolute velocity changes in direction and magnitude, the time of flight between A and B varies.

Now let us determine the round trip time. We make some assumptions to simplify the problem. The separation distance (H) between the holes is nearly zero. Therefore,

$$T_B \approx T_C$$

From the assumption that $H \approx 0$, also follows that the photo detectors at points A and D are also almost at the same point and hence the same apparent distance ($D1'$) of the source for both photo detectors.

The round trip time will be:

$$T_{AB} + T_{CD} = (T_B - T_A) + (T_D - T_C)$$

Let us first determine, T_D , the time of detection of the pulse at point D.

$$T_D = \frac{D1' + 2D}{c}$$

But

$$D1' = D1 \frac{c}{c - V_{abs}}$$

Therefore,

$$T_D = \frac{D1' + 2D}{c} = \frac{D1'}{c} + \frac{2D}{c} = \frac{D1}{c - V_{abs}} + \frac{2D}{c}$$

Now we can determine the time interval between detection of the pulse at point C and at point D.

$$T_{CD} = T_D - T_C = T_D - T_B = \left(\frac{D1}{c - V_{abs}} + \frac{2D}{c} \right) - \frac{D2}{c - V_{abs}}$$

$$= \frac{D1 - D2}{c - V_{abs}} + \frac{2D}{c}$$

$$= \frac{2D}{c} - \frac{(D2 - D1)}{c - V_{abs}}$$

But,

$$D = D2 - D1$$

Therefore,

$$T_{CD} = \frac{2D}{c} - \frac{D}{c - V_{abs}} = \frac{D}{c} \frac{c - 2V_{abs}}{c - V_{abs}}$$

$$= \frac{D}{c \frac{c - V_{abs}}{c - 2V_{abs}}}$$

From the above equation, the velocity of light propagation between points C and D is:

$$c \frac{c - V_{abs}}{c - 2V_{abs}}$$

This is distinct from the conventional formula

$$c + V_{abs}$$

which is the velocity of light propagation between points C and D according to the ether theory.

But the difference between the above two expressions is very small. If we substitute $V_{abs} = 390$ Km/s (absolute velocity of solar system) and $c = 300,000$ Km/s into the former equation:

$$300,000 \frac{(300,000 - 390)}{(300,000 - 780)} = 300,391.0166 \quad 300,391 \text{ Km/s}$$

From the latter equation:

$$c + V_{abs} = 300,000 + 390 = 300,390 \text{ Km/s}$$

The difference between the two results is only 1 Km/s which is less than 0.25 % of the earth's (solar system's) absolute velocity.

Note that photo detectors PD1 and PD2 are assumed to be just at the holes B and D, respectively.

From the dependence of these time delays on absolute velocity, the variation of intensity of the light detected by the photo detectors with orientation of the apparatus, i.e. with absolute velocity, can be determined. The round trip time between the holes is independent of absolute velocity.

$$\text{Round trip time} = T_{AB} + T_{CD} = \frac{D}{c - V_{abs}} + \frac{D}{c \frac{c - V_{abs}}{c - 2V_{abs}}} = \frac{2D}{c}$$

Therefore PD2 current will not vary with absolute velocity, where as PD1 current will vary with absolute velocity.

2.9. ‘Anomalous’ radar range data from Venus planet as discovered by Bryan G. Wallace

One of the observations that seem to be in contradiction with Einstein’s light postulate is the discovery by Bryan G. Wallace that analysis of radar range data of planet Venus did not conform to the principle of constancy of the speed of light.

The analysis of Bryan G. Wallace’s experiment belongs to this section of co-moving source and observer because the source (RF transmitter) and the observer (RF receiver) are co-moving as both are bound to the Earth. The planet Venus acts as a mirror moving relative to the Earth. The effect of Earth’s absolute velocity is negligible in creating an apparent change of position of the RF transmitter as ‘seen’ by the RF receiver because they are located at nearly the same location and because the distance to Venus is much greater than the distance between the transmitter and the receiver, which may be not more than a few tens of meters.

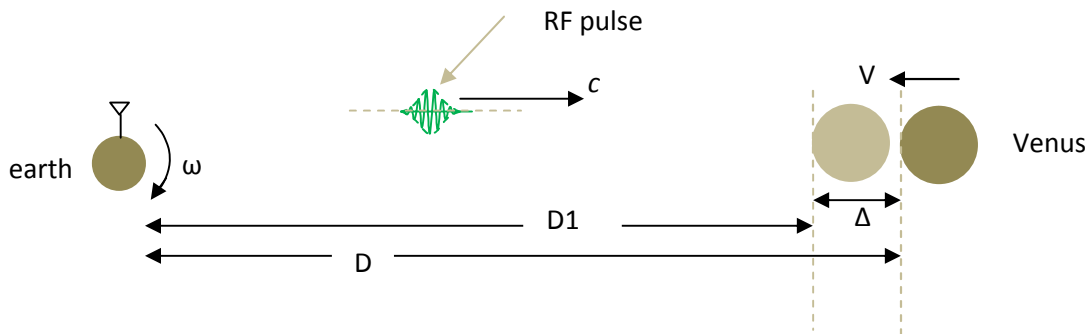

According to Special Relativity and ether theories, the center of the spherical wave fronts of the transmitted RF pulse remains at the point in space where the source was at the instant of emission. According to Apparent Source Theory, the center of the spherical wave fronts moves with the apparent source. As stated above, there is no significant difference between the real and the apparent positions of the source (the transmitter / antenna).

Remember the procedure of analysis:

1. Replace the real source with the apparent source (in this case almost the same as the real source)
2. Then analyze the problem by assuming and applying emission theory and/or Galilean space.

In the this case, the velocity of the RF pulse reflected from Venus relative to an observer on

Earth is $c+2V$, according to emission theory, where V is the earth Venus relative velocity. Suppose that at the instant of the reflecting of the RF pulse from Venus surface, the distance between the Earth and Venus is D and the Earth – Venus relative velocity is V .

The round trip time can be determined if we know the velocity of the RF pulse in the earth's reference frame (which can be considered to be at rest, according to emission theory and Galilean relativity). The velocity of the transmitted RF pulse is obviously equal to c relative to the transmitter. The velocity of the reflected pulse will be $c + 2V$, relative to the Earth (reflection from a moving mirror).

Therefore, the total round trip time is determined as:

$$t_1 = \frac{D}{c} \quad , \quad t_2 = \frac{D}{c + 2V} \quad \text{and} \quad t_1 + t_2 = t$$

$$t = t_1 + t_2 = \frac{D}{c} + \frac{D}{c + 2V} = \frac{2D(c + V)}{c(c + 2V)}$$

$$\Rightarrow D = \frac{tc}{2} \frac{c + 2V}{c + V}$$

where t_1 is the forward flight time, t_2 is the backward flight time and t is the round trip time of the RF pulse.

The distance D_1 at the instant of reception of the pulse on earth will be:

$$D_1 = D - \Delta = D - t_2V$$

$$= D - \frac{D}{c + 2V} V$$

$$= D \frac{c + V}{c + 2V}$$

$$= \frac{tc}{2}$$

In the case of Einstein's light postulate this would be:

$$D_1 = \frac{tc}{2} - \frac{tV}{2}$$

An important distinction here is that the absolute velocity of the solar system doesn't have any effect on this result and hasn't appeared in the above analysis, as explained in a previous section 'Apparent Contradiction'. To be clear, suppose that a detector and a clock were placed on Venus and another synchronized clock on Earth. If the time of detection of the radar pulse was recorded

on Venus, it would be D'/c and not D/c , unlike our assumption in the above analysis, where D' is the apparent distance of the transmitter on Earth as seen by a detector on Venus (not shown in the above figure); as already discussed D' depends on D and absolute velocity V_{abs} of the solar system and the orientation of the Earth -Venus line relative to the solar system absolute velocity.

However, the peculiar nature of the speed of light is that it behaves as if this time is D/c , from the perspective of an observer on Earth.

According to the procedure already given, the observer on Earth

1. replaces the real transmitter position with an apparent transmitter position (which in this case is almost the same as the real transmitter position, because the observer is nearly at the same position as the transmitter (considering the large distance between Earth and Venus)
2. assumes Galilean space and emission theory to analyze the experiment.

Since in Galilean space (or emission theory) the forward and back flight times will be D/c and $D/(c+2V)$ respectively, according to emission theory, where V is Earth - Venus relative velocity, the absolute velocity of the solar does not enter in the analysis of the experiment.

Repetition of the Bryan G.Wallace experiment using a lunar laser ranging

Suppose that a laser pulse is emitted towards a mirror placed on the Moon and reflected back to the Earth and detected. The time elapsed between emission and detection is determined from Earth-Moon distance.

$$T = \frac{2D}{c}$$

In this case $T = 2 * 300,000 / 300,000 = 2$ seconds

Now assume that the mirror on the moon is moving. This can be done by putting the mirror at the tip of a rotating rod, as in A. Michelson moving mirror experiment. Suppose that the velocity of the mirror is 100 m/s towards the Earth. Assume Earth-Moon distance to be 300,000Km, and speed of light 300,000 Km/s.

The laser light pulse will move at the speed of light c relative to the Earth before reflection from the mirror. After reflection, however, the pulse will move with velocity $c+2V$, where V is the mirror velocity, relative to the Earth.

Now

$$T = \frac{D}{c} + \frac{D}{c + 2V} = D \frac{2c + 2V}{c(c + 2V)}$$

$$T = 1.999999333334 \text{ seconds}$$

The time difference between the above two time delays will be:

$$2.0 \text{ s} - 1.999999333334 \text{ s} = 666 \text{ nano second}$$

Detection of this difference will validate AST and disprove Special Relativity.

2.10. Acceleration

One may ask what will happen if co-moving source and observer accelerate.

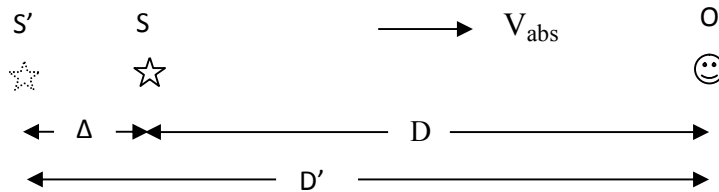

Suppose that the co-moving source and observer are in continuous constant acceleration and a light pulse is emitted while the source and observer are in acceleration. The problem is to find the time elapsed between emission and detection of the pulse. In this case the apparent change of the position of the source relative to the observer is determined as follows.

During the time interval t that the light pulse is emitted from S' and detected at O, the source will move from S' to S.

For constant acceleration motion

$$= V_{abs0}t + \frac{1}{2}at^2$$

where V_{abs0} is the initial absolute velocity, at the instant of light emission.

Solving the above quadratic equation for t

$$t = \frac{-V_{abs0} + \sqrt{V_{abs0}^2 + 2a\Delta}}{a}$$

This time t is the same as the time required for light pulse to move from S' to O, which is:

$$t = \frac{D'}{c} = \frac{D + \Delta}{c}$$

Therefore

$$\frac{-V_{abs0} + \sqrt{V_{abs0}^2 + 2a\Delta}}{a} = \frac{D + \Delta}{c}$$

The above is a quadratic function of Δ . Once Δ is determined, the time elapsed between emission and detection of the light pulse is determined as:

$$t = \frac{D'}{c} = \frac{D + \Delta}{c}$$

The apparent change of position (Δ) of the source can also be determined.

In the above analysis we haven't considered the fact that the apparent source S' is moving relative to the observer at the instant of emission. Hence, since the speed of light is c relative to the apparent source, we should use $c \pm V'$ in the above equations, where V' is the velocity of the apparent source relative to the observer. V' can be determined as follows.

$$D' = D \frac{c}{c - V_{abs}} \Rightarrow \frac{dD'}{dV_{abs0}} = D \frac{c}{(c - V_{abs0})^2} \Rightarrow \frac{dD'}{dt} = \frac{dV_{abs0}}{dt} D \frac{c}{(c - V_{abs0})^2}$$

$$\Rightarrow \frac{dD'}{dt} = V' = aD \frac{c}{(c - V_{abs0})^2}$$

3. Source and observer in absolute and relative motion.

Why/how the velocity of light is independent of the velocity of the source.

In all our discussions so far, we have been considering the special case of (absolutely) co-moving source and observer. Hence, the source and the observer had equal (common) absolute velocities and there would be no relative motion between them.

In this section, we seek a way to formulate a general interpretation of absolute motion, which can be applied to the general case of source and observer having independent, arbitrary absolute velocities, differing in magnitude and/or direction, and hence also moving *relative* to each other. This problem involves a 'mixture' of absolute and relative velocities.

We already have at our hand the interpretation of the special case of co-moving source and observer. How can we go from this specific interpretation to a general interpretation?

After a considerable effort, a general formulation of the new theory was discovered.

Source in absolute motion and observer at absolute rest

Let us first consider the simple case in which only the source is in absolute motion, with the observer at absolute rest. The effect of absolute motion of a light source is to create an apparent change in the *past* position of the light source as seen by the observer at absolute rest.

Assume an observer that is at absolute rest and an absolutely moving source. The source was at distance D from the observer, *at the moment of emission*.

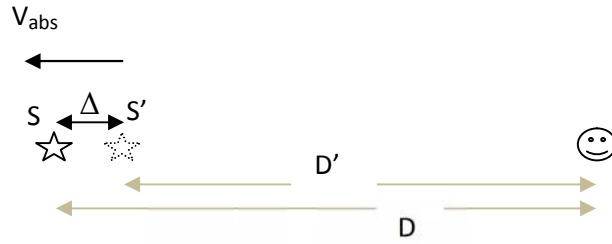

$$\frac{D'}{c} = \frac{\Delta}{V_{abs}} = \frac{D - D'}{V_{abs}}$$

$$\Rightarrow D' = D \frac{c}{c + V_{abs}}$$

$$\frac{dD'}{dt} = V' = \frac{dD}{dt} \frac{c}{c + V_{abs}} = V_{abs} \frac{c}{c + V_{abs}}$$

where V' is the velocity of the apparent source.

$$V' = V_{abs} \frac{c}{c + V_{abs}}$$

for a light source absolutely moving away from an observer that is at absolute rest and

$$V' = V_{abs} \frac{c}{c - V_{abs}}$$

for a light source absolutely moving towards an observer that is at absolute rest.

Remember that the light pulse starts from S' , not from S , for the observer.

The above equations show the relationship between the velocity (V_{abs}) of the real source and the velocity (V') of the apparent source.

From the above derivation, a new theory of light speed is:

The (group) velocity of light is c relative to the apparent source.

The group velocity of light relative to an observer will be

$$c_0 = c + V' = c + V_{abs} \frac{c}{c - V_{abs}} = \frac{c^2}{c - V_{abs}}$$

relative to an observer that is at absolute rest, in the case of a light source moving with an absolute velocity V towards the observer. For a light source moving away with V_{abs} from an

observer who is at absolute rest

$$c_0 = c - V' = c - V_{abs} \frac{c}{c + V_{abs}} = \frac{c^2}{c + V_{abs}}$$

Many experiments and observations did not detect any dependence of the speed of light on the speed of its source. These include: the Albert Michelson moving mirror experiment, the Q. Majorana moving mirror and moving source experiments, experiments using sun light and star light (Tolman, Miller,), experiments using elementary particles (such as positron in annihilation in flight) moving with speeds comparable to the speed of light as sources of radiation. There is also the de Sitter's binary star argument.

Now we can see why no dependence of the velocity of light on the velocity of its source was ever detected. For a light source moving away from an observer that is at absolute rest, the time delay between emission and detection of a light pulse will be:

$$\tau = \frac{D'}{c - V'} = \frac{D \frac{c}{c + V_{abs}}}{c - \frac{V_{abs}c}{c + V_{abs}}} = \frac{D}{c}$$

Although the source is moving away from the observer, it still takes the same amount of time for the light to be observed compared to the case of the source at rest relative to the observer.

The increase / decrease of the speed of light relative to the observer is compensated for exactly by the increase / decrease of the apparent distance where the light pulse was emitted, so that the time of flight is always independent of source velocity and will be equal to D / c .

Both source and observer in absolute and relative motion



From previous analyses

$$D' = D \frac{c}{c - V_{absS}} \Rightarrow \frac{dD'}{dt} = V' = \frac{dD}{dt} \frac{c}{c - V_{absS}} = V \frac{c}{c - V_{absS}}$$

where V is the source observer relative velocity.

But

$$V = V_{absS} - V_{absO} \quad , \quad \text{for } V_{absS} > V_{absO}$$

The time delay τ between emission and observation of light is:

$$\tau = \frac{D'}{c + V'}$$

(the plus sign is because the source and observer are approaching each other)

Substituting the previous values for D' , V' and V ,
i.e.

$$D' = D \frac{c}{c - V_{absS}} \quad , \quad V' = V \frac{c}{c - V_{absS}} \quad , \quad V = V_{absS} - V_{absO}$$

we get

$$\tau = \frac{D}{c - V_{absO}}$$

We see that the (absolute) velocity of the source V_{absS} does not appear in the above equation.

We can determine the velocity (c_0) of light relative to an observer as follows.

$$\begin{aligned} c_0 = c + V' &= c + V \frac{c}{c - V_{absS}} = c + (V_{absS} - V_{absO}) \frac{c}{c - V_{absS}} \\ &= c \frac{c - V_{absO}}{c - V_{absS}} \end{aligned}$$

We see that this result is distinct from $(c - V_{absO})$, which is the velocity of light relative to the observer in ether theory, where V_{absO} is the velocity of the observer relative to the ether.

The general formula will be

$$c_0 = c \frac{c \pm V_{absO}}{c \pm V_{absS}}$$

Let us consider a case in which the observer's absolute velocity is directed towards the source and the source and observer are receding away from each other.

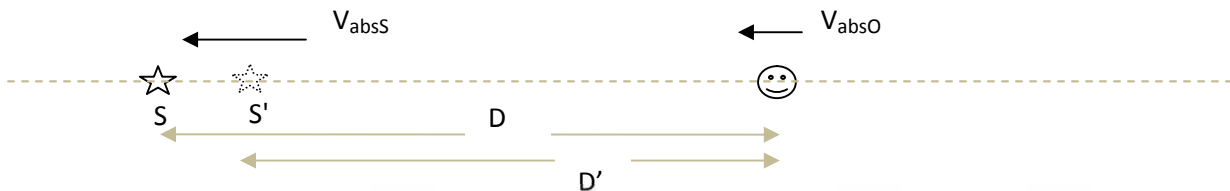

In this case

$$D' = D \frac{c}{c + V_{absS}} \Rightarrow \frac{dD'}{dt} = V' = \frac{dD}{dt} \frac{c}{c + V_{absS}} = V \frac{c}{c + V_{absS}}$$

where V is the source observer relative velocity.

But

$$V = V_{absS} - V_{absO} , \quad \text{for } V_{absS} > V_{absO}$$

The time delay τ between emission and observation of light is:

$$\tau = \frac{D'}{c - V'}$$

(the minus sign is because the source and observer are receding away from each other)

Substituting the previous values for D' , V' and V ,

i.e.

$$D' = D \frac{c}{c + V_{absS}} , \quad V' = V \frac{c}{c + V_{absS}} , \quad V = V_{absS} - V_{absO}$$

we get

$$\tau = \frac{D}{c + V_{absO}}$$

The above analysis can be applied to any combination of magnitude and direction of source and observer absolute velocities, with the source and observer moving *directly* (radially) towards each other or receding directly away from each other, with no transverse component of their relative velocity.

In general,

$$\tau = \frac{D}{c \pm V_{absO}}$$

We see that the (absolute) velocity of the source, V_{absS} , does not appear in the above equation.

From the above equation we see that the velocity of light as determined experimentally (D/τ) is

$$\frac{D}{\tau} = c \pm V_{absO}$$

The measured speed of light is independent of the absolute velocity of the source V_{absS} , which is in agreement with experiments and observations. The velocity of light, however, depends on the absolute velocity of the observer V_{absO} .

Transverse relative motion between source and observer

In the preceding section, the source observer relative velocity was assumed to have no transverse component. The following figure shows both radial and transverse relative velocity components.

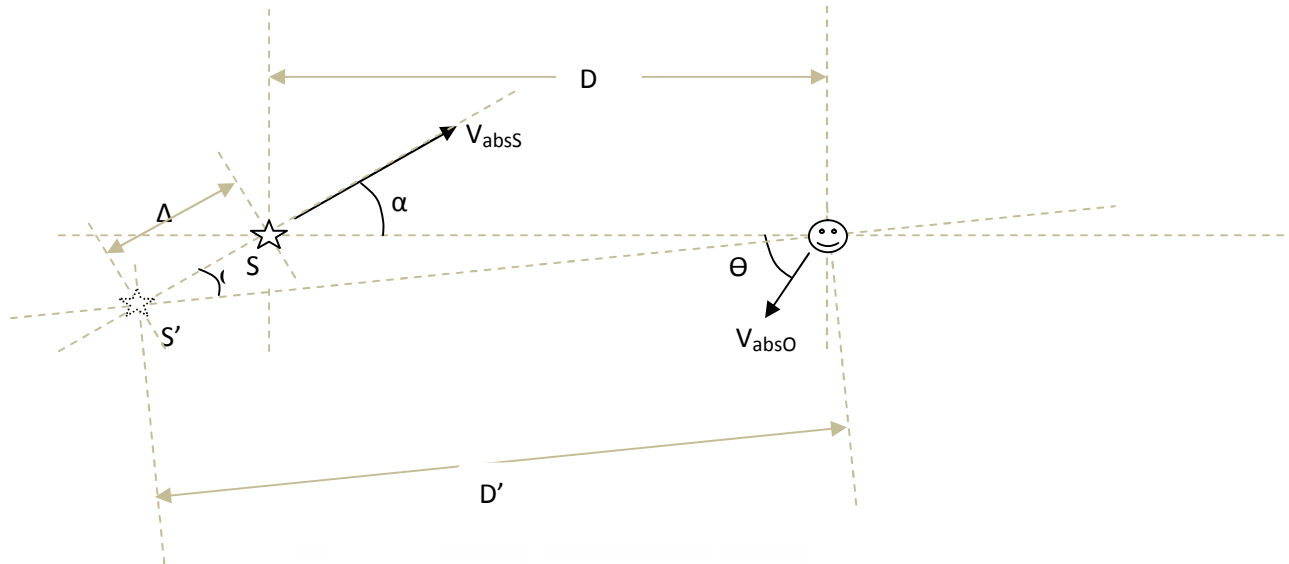

$$(\Delta \cos\alpha + D)^2 + (\Delta \sin\alpha)^2 = D'^2 \quad \dots\dots\dots (1)$$

$$\frac{\Delta}{V_{absS}} = \frac{D'}{c} \quad \dots\dots\dots (2)$$

$$V = V_{absS}\cos\alpha + V_{absO}\cos\theta \quad \dots\dots\dots (3)$$

where \$V\$ is the source observer relative velocity.

Determine \$D'\$ and \$\Delta\$ from the first two equations. From the equation for the expression of \$D'\$ in terms of \$D\$, determine the expression for \$V'\$ in terms of \$V\$ (by differentiating both sides). \$V\$ will have radial and transverse components. Then determine the time delay between emission and observation as:

$$\tau = \frac{D'}{c + V'_r}$$

, where \$V'_r\$ is the radial velocity component of the apparent source.

Stellar aberration

In reality, the phenomenon of stellar aberration, as observed from the earth, involves the absolute and relative velocities of both the star and the earth. We are certain that the earth is in absolute motion (390 Km/s), but the stars are also most probably in absolute motion.

In this section, however, we analyze the phenomenon of stellar aberration by assuming two simple cases:

- star in absolute motion and observer at absolute rest
- star at absolute rest and observer in absolute motion

Star at absolute rest and observer in absolute motion

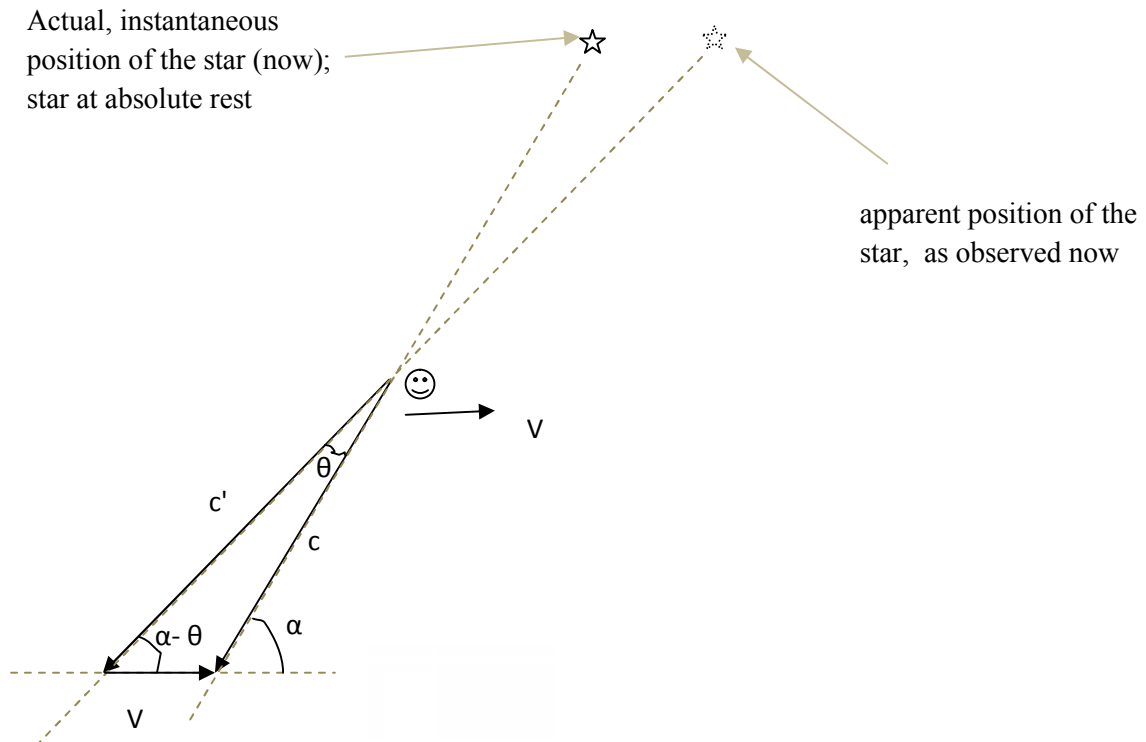

$$c' = c - V \quad (\text{vector sum})$$

$$\frac{\sin \theta}{V} = \frac{\sin(180 - \alpha)}{c'} = \frac{\sin(\alpha - \theta)}{c} \quad \text{and } \sin \theta \approx \theta \quad (\text{for small angle } \theta)$$

$$\frac{\sin \theta}{V} \approx \frac{\theta}{V} \approx \frac{\sin \alpha}{c} \quad \Rightarrow$$

$$\theta = \frac{V}{c} \sin \alpha$$

This is the kind of aberration known as Bradley aberration. In this case, aberration is due to the difference between the actual (instantaneous) and apparent position of the star, caused by the motion of the observer. In this case star light aberration is an apparent change of *current* (instantaneous) position of the star. This is only an illusion, like a man running in rain with rain drops appearing to fall in slant path.

Note that, however, in the aberration observed by Bradley the star itself is not necessarily at absolute rest. The effect of absolute/relative motion of the observer is ‘superimposed’ on the effect of absolute motion of the star. Quantitative treatment of this should not be difficult based on the discussions made so far.

Note that the change of position of the star due to observer’s motion is only an illusion. It doesn’t mean that the light rays are coming from direction of the apparent star position. The light rays still come from the real source position. This interpretation will be applied to the discussion of the speed of gravity, in the last section of this paper.

Star in absolute motion and observer at absolute rest

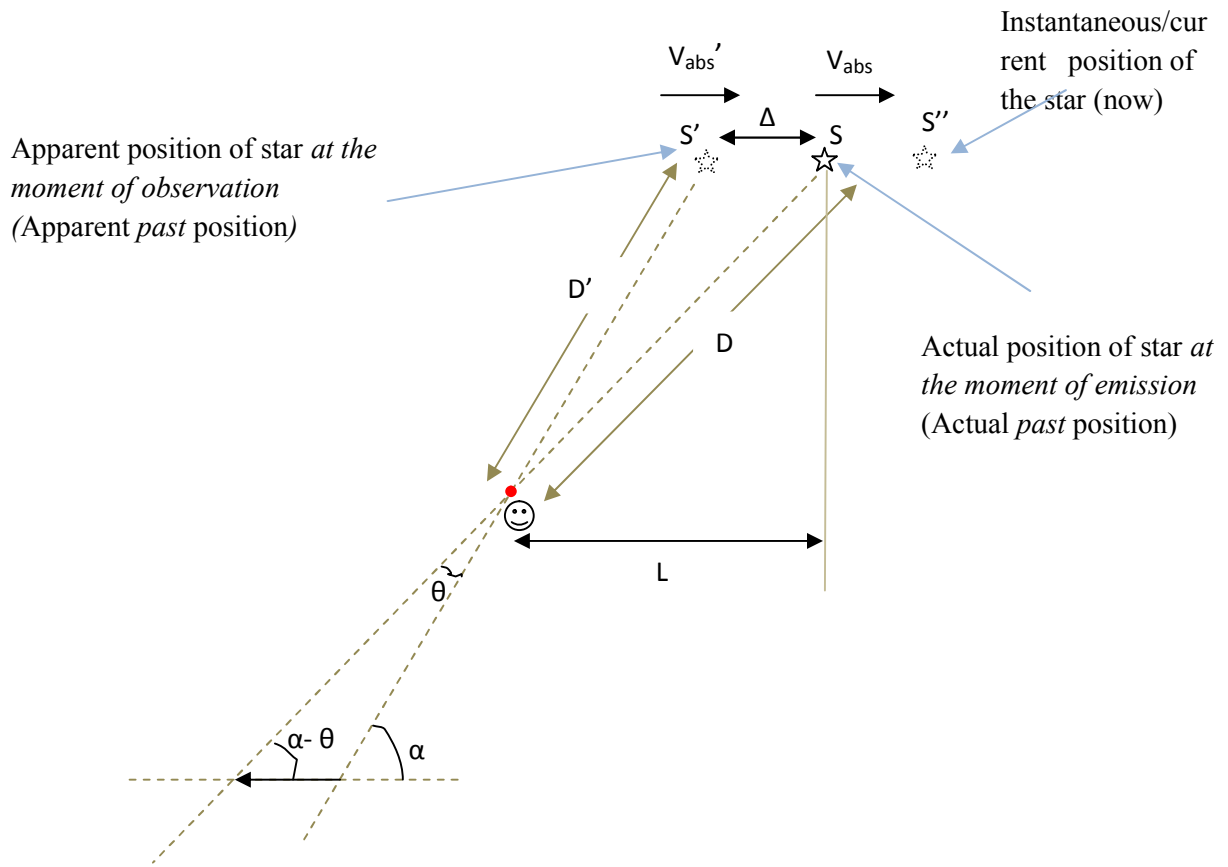

$$\frac{D'}{c} = \frac{\Delta}{V_{abs}} \dots \dots \dots (1)$$

$$D'^2 - (L - \Delta)^2 = D^2 - L^2 \dots \dots \dots (2)$$

From the above two equations, D' and Δ can be determined (it is a lengthy formula), and then the angle of aberration θ can be determined. Note that angle θ is due to a difference in the actual past position of the star and its apparent past position, as seen at the time of observation. Unlike conventional explanations, the current (instantaneous) position of the star has no role in the explanation of stellar aberration.

For better clarification, suppose that the star is one light year away from the observer. Actually, physically the star emits light from position S . The observer sees the light after one year. At the time of observation, i.e. one year after emission, it appears to the observer that the star emitted light from position S' *one year ago*, and not from position S . The current (instantaneous) position S'' of the star will have no relevance. For the case of an absolutely moving star, light aberration is an apparent change of the *past* position of the star. Although the star *actually* emitted light from position S one year ago, it appears to the observer, at the time of observation (i.e. after one year), that the star emitted light one year ago from position S' , and not from position S .

(In the case of absolutely moving observer and star at absolute rest (preceding section), light aberration is an apparent change of *current* (instantaneous) position of the star) .

This kind of star light aberration is due to the star's absolute motion. Therefore, even if an observer is at absolute rest, the observed position of stars may not be their actual *past* position. Theoretically, it is possible to know if a star is in absolute motion or not, and its absolute velocity. If the position of the star appears to change as the (stationary) observer changes his/her distance from the star, then the star is known to be in absolute motion. If the star is at absolute rest, then its position will not change apparently as the observer distance changes.

I have made some important refinements to the previous versions in this paper. One of these is that even though absolute motion of the star creates an apparent change in its past position (direction and distance), this will not be accompanied by a corresponding change in the time it takes light to reach the earth from the star, i.e. the time of flight will be the same if the star is in absolute motion or at absolute rest. We have already shown in a previous section that the time taken for light to reach an observer is independent of the velocity of the source. In summary, the effect of absolute motion of the star is to create an apparent change in direction (and distance), i.e. aberration, and not a change in time.

The Global Positioning System

The Global Positioning System (GPS) is a physical system which provides an opportunity to observe the real behavior of the speed of light. However, the reality is that the GPS only added another problem to the already confusing light speed puzzle. The Silvertooth, Marinov and CMBR experiments already confirmed our absolute motion through space. But the GPS appears to hold correct (only?) in the ECI (Earth-Centered Inertial) frame, as if there was an ether entrained by the Earth and moving with it, but not rotating with it. However, the GPS was meant to be a practically useful system and was not meant to be an experiment to test the speed of light. In the GPS, Einstein's light postulate is applied.

Why is Earth's absolute velocity of about 390 Km/s (apparently) not detected by the GPS? Or has any one investigated into this ? Since the notion of absolute motion has been abandoned due to null results of Michelson-Morley experiments, perhaps there has been no motivation for this. I made some search for a paper that analyzes the GPS system with the assumption of absolute (non-entrained) ether, to see the magnitude and pattern of error introduced in position measurement, but I couldn't find any. Since Apparent Source Theory and ether theory can give similar results in some experiments, such an analyses or experiments would have been helpful. I think of the possibility that the error in position measurement by a GPS receiver due to Earth's absolute motion may have been somehow masked by the way the GPS works.

Let us see how Apparent Source Theory applies to GPS.

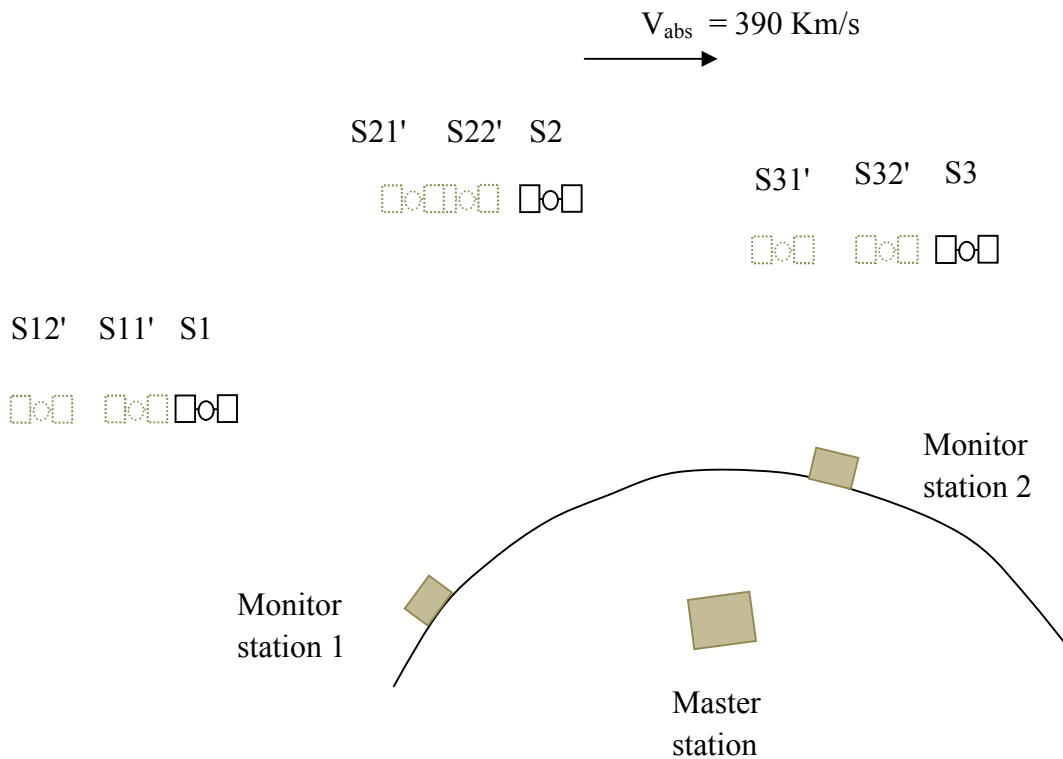

The control stations monitor the satellites from the signals they transmit and send the information to the master station, where the orbit and clock performance of each satellite is computed. These data are then uploaded to each satellite.

According to Apparent Source Theory, the monitoring stations measure the apparent position and not the real /physical position of each satellite. Note that the apparent position of each satellite is different as seen from each monitoring station.

The effect is that the actual/physical and apparent orbit of each satellite will be different. This may not have been a problem. The problem is even more complicated because the same apparent orbit does not apply for GPS receivers at different locations on Earth. Further complication comes from the fact that the ground stations transmitting data to satellites appear to be at their apparent positions (not shown in the figure) from the perspective of each Satellite. The transmission of data from the monitoring stations to the master station is also affected by Earth's absolute motion.

I am not going to make a quantitative analysis in this paper. But an important question is : how does all this show up in position measurement by a GPS receiver ? Suppose that a GPS receiver is fixed at some location on Earth. Will there be any periodic variation in the measured position of the GPS receiver, due to combined effect of Earth's absolute motion (390 Km/s) and Earth's diurnal rotation ? I think that this has not been observed because the Satellite orbit data is updated every few hours or because the effect may be very small.

Let us consider a simple example below, the observers and sources co-moving absolutely.

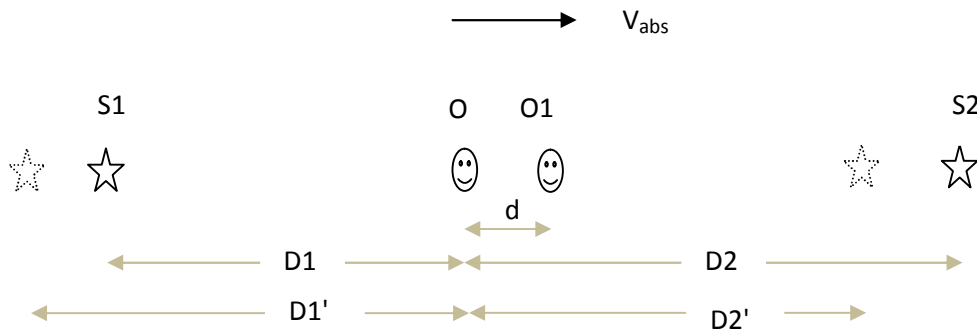

S1 and S2 are satellites, O represents control and monitoring station, O1 represents a GPS receiver. We assume that all clocks are perfectly synchronized, there is no relative motion between the satellites, the control and monitoring station and the GPS receiver, for simplicity. Our aim is to find the order of magnitude of error in position measurements caused by Earth's absolute motion (390 Km/s).

The control and monitoring station measures the distances of the satellites to be $D1'$ and $D2'$, not $D1$ and $D2$, which are the physical positions of the satellites, according to AST. Note that we

assumed that the control and monitoring station measures the distance of the satellites from the signals they transmit.

$$D1' = D1 \frac{c}{c - V_{abs}}$$

$$D2' = D2 \frac{c}{c + V_{abs}}$$

The travel times of signals from the satellites to the control and monitoring station are:

$$t_{d1} = \frac{D1'}{c} = \frac{D1}{c - V_{abs}}$$

$$t_{d2} = \frac{D2'}{c} = \frac{D2}{c + V_{abs}}$$

A GPS receiver just at the control and monitoring station measures the difference in time of arrival of the signals from the two satellites to be:

$$t_0 = t_{d1} - t_{d2} = \frac{D1}{c - V_{abs}} - \frac{D2}{c + V_{abs}}$$

Let $D1 = D2 = D$, for simplicity

$$t_0 = t_{d1} - t_{d2} = \frac{D}{c - V_{abs}} - \frac{D}{c + V_{abs}} = 2D \frac{V_{abs}}{c^2 - V_{abs}^2}$$

But for a GPS receiver at distance d from the control and monitoring station, the time delays of the signals of the two satellites will be:

$$t_{d1} = \frac{D + d}{c - V_{abs}}$$

$$t_{d2} = \frac{D - d}{c + V_{abs}}$$

The difference in arrival times of the satellite signals at position O1, according to Apparent Source theory, will be

$$t_1 = t_{d1} - t_{d2} = \frac{D + d}{c - V_{abs}} - \frac{D - d}{c + V_{abs}} = 2D \frac{V_{abs}}{c^2 - V_{abs}^2} + 2d \frac{c}{c^2 - V_{abs}^2}$$

But the GPS receiver determines its position as follows, by assuming that the satellites are at distance $(D1' + d)$ and $(D2' - d)$, where $\Delta t'$ is the difference in time of arrival of the two signals.

$$t_1' = \frac{D1' + d}{c} - \frac{D2' - d}{c} = 2D \frac{V_{abs}}{c^2 - V_{abs}^2} + \frac{2d}{c}$$

If the GPS receiver used the equation based on AST,

$$\begin{aligned} \Delta t_1 &= 2D \frac{V_{abs}}{c^2 - V_{abs}^2} + 2d \frac{c}{c^2 - V_{abs}^2} \\ \Rightarrow d &= \left(\Delta t_1 - 2D \frac{V_{abs}}{c^2 - V_{abs}^2} \right) \frac{c^2 - V_{abs}^2}{2c} \end{aligned}$$

The GPS receiver actually uses the equation,

$$\begin{aligned} \Delta t_1' &= 2D \frac{V_{abs}}{c^2 - V_{abs}^2} + \frac{2d}{c} \\ \Rightarrow d &= \left(\Delta t_1' - 2D \frac{V_{abs}}{c^2 - V_{abs}^2} \right) \frac{c}{2} \end{aligned}$$

The discrepancy (ε_d) between the distance d of the GPS receiver from the control and monitoring station, by using the above two equations can be estimated.

$$\varepsilon_d = \left(\Delta t_1 - 2D \frac{V_{abs}}{c^2 - V_{abs}^2} \right) \left(\frac{c}{2} - \frac{c^2 - V_{abs}^2}{2c} \right) = \left(\Delta t_1 - 2D \frac{V_{abs}}{c^2 - V_{abs}^2} \right) \frac{V_{abs}^2}{2c}$$

Assume the measured difference in arrival times (Δt_1 or $\Delta t_1'$) of the two satellite signals to be 10ms, $V_{abs} = 390$ Km/s, $D \approx 20000$ Km, $c = 300000$ Km/s.

$$\varepsilon_d \approx 10\text{ms} \frac{390^2}{600000} = 0.002535 \text{ Km} \approx 2.5 \text{ m}$$

We see that absolute motion of the Solar System affects GPS position measurement but the effect is very small: it is almost 'invisible' in GPS measurements. That may be why the ECI frame appears to apply accurately to GPS and that is why the speed of light appears to be constant in the ECI frame. Note that the value of ε_d does not mean error in position measurement of actual GPS; it is meant to show that current GPS performance might be achieved even with the Earth in absolute motion (390 Km/s). Note also that we have only shown that the *difference* between arrival times, not the absolute times, of satellite signals at the GPS receiver is almost not sensitive to Earth's absolute motion in space.

Application of Apparent Source Theory to GPS can improve its accuracy.

4. Moving mirror and moving observer experiments

4.1. Q. Majorana and Albert Michelson moving mirror experiments

Even though the Bryan G. Wallace experiment is also a case of moving mirror, only group velocity is relevant in its analysis, since it is a time-of-flight experiment. It was readily understood using the AST theory.

The Albert Michelson and Q. Majorana moving mirror experiments, however, used interference method, so their analysis will also involve phase velocity.

From analysis of Bryan G. Wallace experiment, we concluded that a moving mirror will alter the *group* velocity of light. But the *phase* velocity is always constant, irrespective of source, observer or mirror velocity.

1. In absolute space, the group velocity of light is independent of source absolute velocity, but depends on observer absolute velocity. In Galilean space the group velocity varies with both source, observer (relative) velocity. For a light source that is at absolute rest, the group velocity of light varies with observer velocity, whereas the phase velocity is constant c independent of observer velocity. For a light source that is in absolute motion and an observer that is at absolute rest, both the group velocity and phase velocity are independent of source velocity.

2. The group velocity of light depends on mirror relative velocity

In principle, to account for the Earth's absolute velocity, we first replace the actual light source with an apparent source, as seen from the detector's position. We then analyze the experiment by assuming Galilean space and (modified) emission theory. Modified emission theory is one in which the phase velocity is constant c independent of source observer relative velocity, whereas the group velocity depends both on the source and observer velocity, in a conventional way, in Galilean space. To simplify the discussion, however, we ignore the absolute velocity of the Earth and just assume Galilean space and modified emission theory.

4.2. Albert Michelson moving mirror experiment

The A. Michelson moving mirror experiment was done to investigate the effect of mirror velocity on the velocity of light, by looking for a fringe shift due to a possible difference in the velocities, and arrival times, of the two light beams.

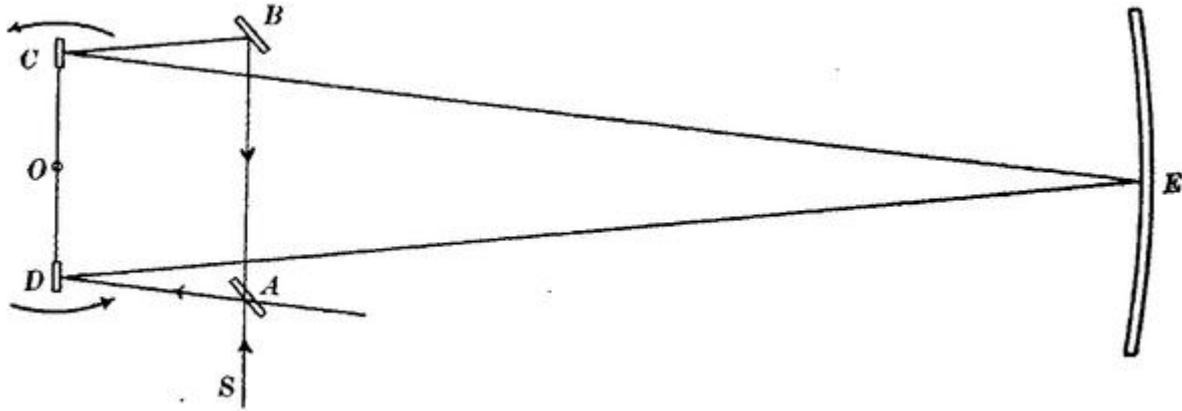

Assuming Galilean space, for simplicity of discussion, the group velocity of the two light beams will be different because group velocity depends on mirror velocity, according to AST. We have already concluded that the group velocity will depend on the mirror velocity. In this case it may seem that, given sufficiently large mirror velocity, the faster beam will arrive earlier than the slower beam in such a way that they may not even overlap in time to create an interference pattern. This is not the case however.

My work on quantum mechanics [9,10] has helped me to understand this experiment better. As we know, the interference pattern is due to self interference of a photon. A photon is emitted from the source and will take only one of the two paths, and never both paths simultaneously. Yet an interference pattern is observed. This is a well known phenomenon of quantum mechanics. A new interpretation has been provided in the paper [9,10].

Therefore, the difference in group velocities of the two light beams will have no effect on the interference pattern. If the photon takes the path of faster velocity (path ADECBA) it will only arrive slightly earlier than if it took the other path and this will have no effect on the interference pattern. My previous paper [9,10] provides a very intuitive way of understanding quantum phenomena. But the *phase* velocity of the two light beams is always constant c and hence equal, so the velocity of the mirrors will not affect the phase velocity. The amount of fringe displacement measured in the experiment agrees with this explanation. The fringe shift is only due to a slight difference in path length of the two beams, caused by velocity of the mirrors and finite transit time of light. Michelson only disproved the conventional emission theory in which both phase velocity and group velocity depend on source and mirror velocity. He did not make the distinction that phase velocity is constant while group velocity varies with mirror velocity. Normally, he would also think that a photon takes both paths simultaneously, as in classical waves. By default, Michelson wrongly interpreted the result of the experiment that the group velocity also is not affected by the mirror velocity, which is also the mainstream thought today. The quantum interpretation applies also to the Michelson-Morley experiment: *the photon takes only one of the two possible paths to the detector: the path of one or the other mirror, not both.*

4.3. Q.Majorana moving mirror experiment

According to conventional emission theory, the wavelength of light does not change with source,

observer or mirror velocity; it is 'rigid'. The Q. Majorana experiment tested this hypothesis and disproved it. The emission theory was a straight forward explanation for the Michelson-Morley experiment.

As already stated, the group velocity of light depends on the mirror velocity according to the ballistic hypothesis. The phase velocity is always constant c independent of source, observer or mirror velocity. Hence, for the phase velocity to be constant, the wavelength should change and this was what was proved by this experiment.

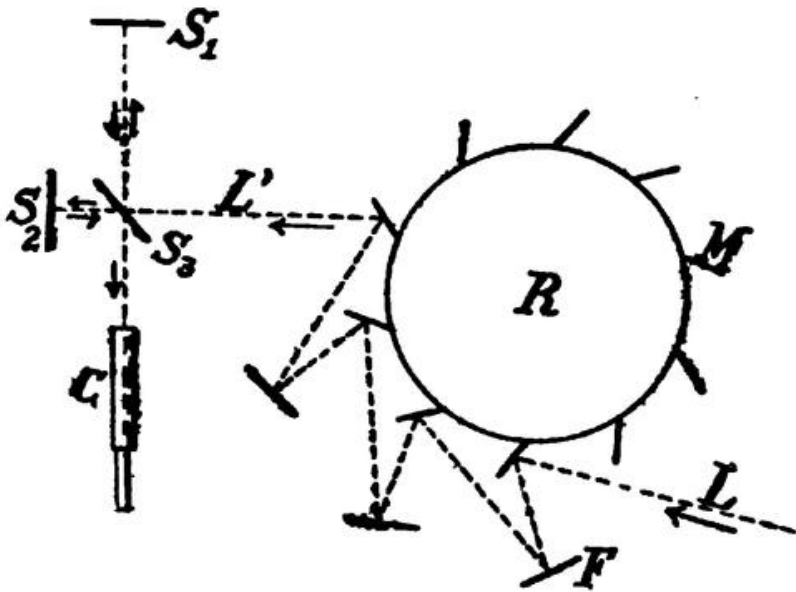

Q. Majorana also did not make the distinction on phase velocity and group velocity, as proposed in this paper, i.e. constant phase velocity and variable group velocity.

4.4. Ole Roamer's observation

Roamer observed that the eclipse time of Jupiter's moon Io is 22 minutes longer when the Earth was moving away from Jupiter than when it was moving towards Jupiter. From this observation, the speed of light was determined, for the first time. Before that time the order of the speed of light was unknown, and was even thought to be infinite.

The Roamer experiment is one of the decisive experiments that led me to the conclusion that the (group) velocity of light is variable, for a moving observer, and to abandon Einstein's light postulate as it is. We have already established that the group velocity of light is independent of source absolute velocity, but varies with observer absolute velocity. Group velocity also varies with the velocity of mirror. One objection to this theory is that the Albert Michelson moving mirror experiment, which apparently confirmed that the velocity of light does not depend on the velocity of mirror. But what was measured in the Michelson moving mirror experiment was a fringe shift. The Michelson experiment only confirmed that the *phase* velocity of light is

independent of mirror velocity. The *group* velocity of light varies with mirror velocity and with observer velocity. Both group velocity and phase velocity are independent of source velocity. We have already discussed the explanation of the A. Michelson moving mirror experiment.

Absolute velocity of the Solar System, which is about 378 Km/s according to the Silvertooth experiment, does not have significant effect on the analysis of Roamer's experiment. The effect of absolute velocity of the Sun (the Solar System) is to create an apparent change in the past position of the Sun, relative to the observer on Earth. It appears to the observer on Earth as if the Sun emitted light from a different position. Obviously, changing (actually or apparently) the position of the Sun relative to the Earth is not basically important in the discussion of Ole Roamer's observation; it does not affect the time it takes light reflected from the surface of Io to reach the Earth. Basically this time delay depends only on the velocities of the Earth and Io relative to the Sun. Absolute velocity of the Solar System is not significantly 'visible' in Roamer's experiment. But it is possible to account for Solar System's absolute velocity by replacing the real Sun with an apparent Sun, for an observer on the Earth, if a more complete and accurate analysis is desired.

Therefore, we can analyze this experiment by assuming Galilean space and hence only relative velocities.

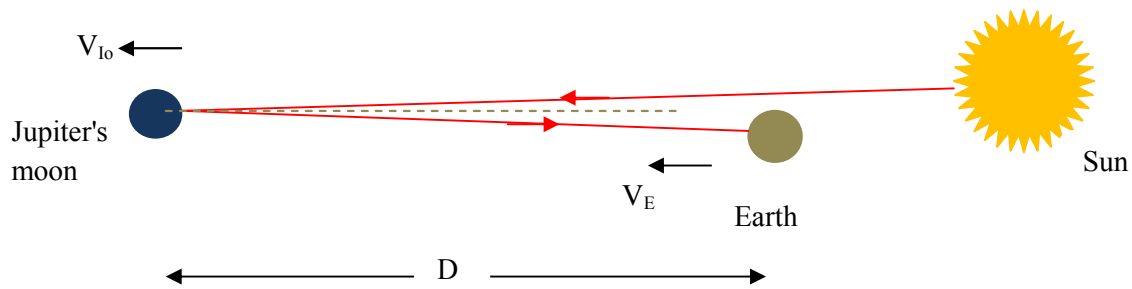

Since we have assumed Galilean space for simplicity, we can consider the sun to be at rest. Io acts as a moving mirror.

Let the velocity of Jupiter's moon be V_{Io} relative to the Sun and the velocity of the Earth to be V_E relative to the sun. For simplicity, assume that the Sun, the Earth and Io are nearly along the same line and that the Earth and Io are moving only along this line.

A light ray emanating from the Sun will be reflected from the surface of Io towards the Earth. At first assume that the Earth is at rest relative to the Sun, i.e. $V_E = 0$.

The group velocity of light reflected from Io , relative to the Earth (relative to the Sun) will be,

$$c - 2V_{Io}$$

for Io moving away from the Sun and

$$c + 2V_{IO}$$

for Io moving towards the Sun.

Now if the Earth is also moving relative to the Sun, the group velocity of light reflected from Io, relative to the Earth will be:

$$c \pm 2V_{IO} \pm V_E$$

Once the light bounces off the surface of Io, it will have a group velocity of $c \pm 2V_{IO}$, relative to the Sun, depending on whether Io was moving towards or away from the Sun at the instant of light reflection. Now, if the Earth is moving towards Io, the (group) velocity of light will be

$$c \pm 2V_{IO} + V_E$$

relative to the Earth. If the Earth is moving away from Io, the group velocity of light will be

$$c \pm 2V_{IO} - V_E$$

relative to the Earth.

If the distance between the Earth and Io was D , at the moment of light bouncing off the surface of Io, then the light will reach the Earth after a time delay of :

$$\tau = \frac{D}{(c \pm 2V_{IO} + V_E)}$$

after the instant of reflection, if the Earth is moving towards Io.

The time delay will be

$$\tau = \frac{D}{(c \pm 2V_{IO} - V_E)}$$

if the Earth is moving away from Io.

5. Light speed measurement experiments: A. Michelson rotating mirror experiment

The speed of light has been measured with increasing accuracy by Ole Romer, Bradely, Fizeau, Foucault and Albert Michelson, from observation of astronomical phenomena and by terrestrial experiments. Modern experiments use optical cavity resonators, microwave interferometer and laser methods. The currently accepted value is 2.99792458×10^8 m/s.

Apparently, no variation in the speed of light has ever been detected with different orientations of the measuring apparatus relative to the orbital velocity of the earth.

Let us consider the Albert Michelson rotating mirror experiment.

As discussed so far, the source apparently shifts relative to the observer due to absolute velocity of the Earth (about 390 Km/s). We will see that this apparent shift of the position of the source

relative to the observer does not affect the result of the experiment. The time taken by the light beam to move from the rotating mirror to the distant mirror and back to the rotating mirror, as 'seen' by the observer, is not affected by the absolute velocity of the Earth. What is affected by absolute velocity of the Earth is the total time taken for the light beam to go from the source to the observer. One may think of this as actually, physically changing the distance between the source and the observer (change distance of source from rotating mirror), which will not change the result of the experiment, obviously: the measured speed of light.

The same applies to optical cavity resonators and microwave and laser interferometer methods. The change in path length of the wave from source to detector due to absolute motion does not affect the result of such experiments. The *apparent* change of the position of the microwave source does not affect the frequency of a resonant cavity, just as *actually* changing the position of the source does not, in principle, affect the experiment. The frequency and the wavelength of light emitted by a source is not affected by an apparent or actual change of the position of the source.

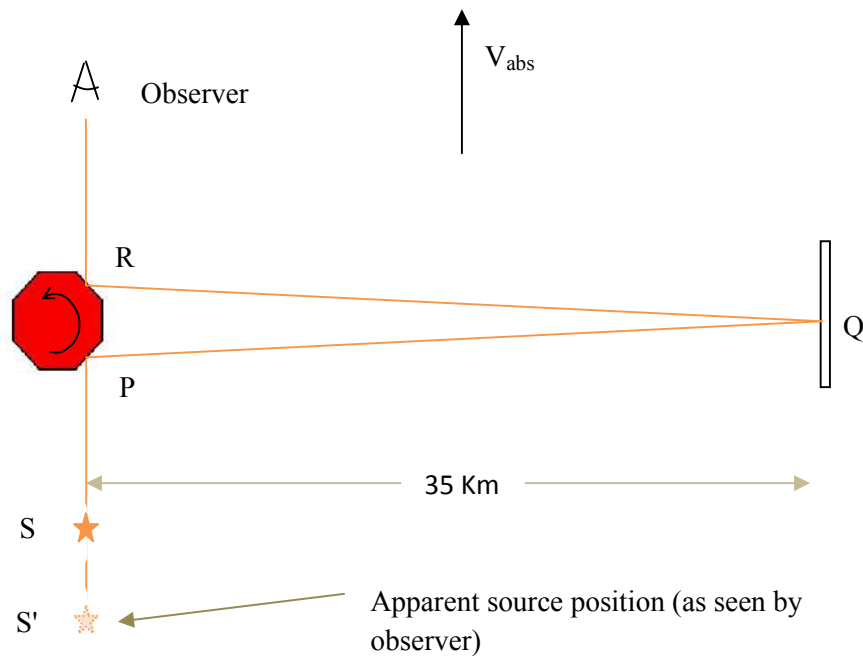

To clarify this interpretation, assume that sensors are put at points P, Q and R. Points P and R are points in space where the light is reflected from the rotating mirror, point Q is point on the distant mirror where the light is reflected. If a short light pulse is emitted by the source at time $t = 0$, then the light will be detected at points P, Q, and R, at times t_P , t_Q and t_R , respectively.

The distinction in the AST theory is as follows. The time it takes light pulse to go from the rotating mirror to the distant mirror (from point P to point Q), $t_Q - t_P$, and the time for the pulse to go from the distant mirror back to the rotating mirror (from point Q to point R), $t_R - t_Q$, will *actually* vary with the absolute velocity, as actually recorded by the sensors. The distinction in the AST theory is that this variation is not relevant to the observer, to predict the result of his experiment. The observer simply accounts for the absolute velocity by replacing the real source

with the apparent source and analyze the experiment by assuming Galilean space and (modified) emission (ballistic) theory. Shifting the source from position S to position S' would not obviously affect the time from the rotating mirror to the distant mirror and the time from the distant mirror back to the rotating mirror, and the round trip time, from the perspective of the observer. Note that the observer is not actually measuring these times. He makes observations and measurements only at his own position.

But this difference is not important for the observer. The observer simply replaces the real source with the apparent source and analyze the experiment as if the whole system is at absolute rest or as if space is Galilean. Obviously, even real (physical) change of the light source does not affect the forward and backward flight times of the light pulse (assume absolute rest or Galilean space, for simplicity). Thus, for the observer, the forward and backward flight times are unaffected by absolute motion, as compared with a system (the source, the mirrors, the observer) at absolute rest.

Even though the two times are different, they are affected by absolute motion in such a way that their sum (the round trip time) is unaffected and will be the same as compared with a similar system that is at absolute rest or in Galilean space.

A different method was used by Rosa and Dorsey to measure the speed of light in 1907 .They measured vacuum permittivity ϵ_0 and vacuum permeability μ_0 from which the speed of light can be computed from the equation $c^2 = 1 / \epsilon_0 \mu_0$. The result obtained was within 0.00005 % of the currently accepted value. This is an important experiment that shows that vacuum permittivity and vacuum permeability, and hence the vacuum *phase* velocity of light relative to any observer, are not affected by absolute motion. This can be another experimental evidence confirming Einstein's light postulate (for phase velocity).

6. Constant phase velocity and variable group velocity of light

Constant *phase* velocity of light

Einstein's beautiful thought experiment, 'chasing a beam of light', is very compelling and is in fact the main argument for Special Relativity. If the ether doesn't exist, as confirmed by the Michelson-Morley experiment, then Einstein is right in asserting that the velocity of light is independent of observer velocity. By 'velocity of light', we mean phase velocity and not group velocity. However, Einstein never made this distinction and this led him to the wrong theory of Special Relativity, length contraction, time-dilation speculations. Emission theory was also shown to be wrong conceptually and by experiments. One of the conceptual arguments against conventional emission theory is that it implies 'frozen' light[18], which is untenable. The above considerations are compelling to postulate the constancy of *phase* velocity of light, independent of source or observer relative or absolute velocities, even though no direct experimental evidence exists.

In an attempt to understand Einstein's light postulate, I developed a theory [6] in which the wave gets compressed or expanded as a result of source observer relative motion, the wavelength depending on source observer relative velocity. This is unlike all conventional knowledge. To my knowledge, no one ever considered such a possibility, i.e. changing of wavelength with observer velocity. According to ether theory, emission theory and Special Relativity ? , the wavelength of light does not depend on observer velocity. However, the expression of that

theory[6] was not correct. The problem with that expression was discovered when I considered an accelerating observer. This implied a weird phenomena in which, for example, the phases will be 'frozen' for a large enough acceleration, for an observer accelerating towards a light source. Therefore, the wavelength of light varies with observer velocity but a different formula for the Doppler effect of light is proposed here.

The Exponential Law of Light theory [8] is considered to be the correct expression for the compression and expansion of the light wave resulting from source observer relative motion.

According to the theory of Exponential Law of Light, the expression for the Doppler wavelength and frequency shift is:

$$\lambda' = \lambda e^{v/c}$$

, for source and observer receding away from each other

$$f' = f e^{-v/c}$$

, for source and observer receding away from each other

Thus,

$$\lambda' f' = \lambda e^{v/c} f e^{-v/c} = \lambda f = c$$

We see that the (phase) velocity of light is independent of source observer relative velocity.

Intuitively, this can be understood from the next figure.

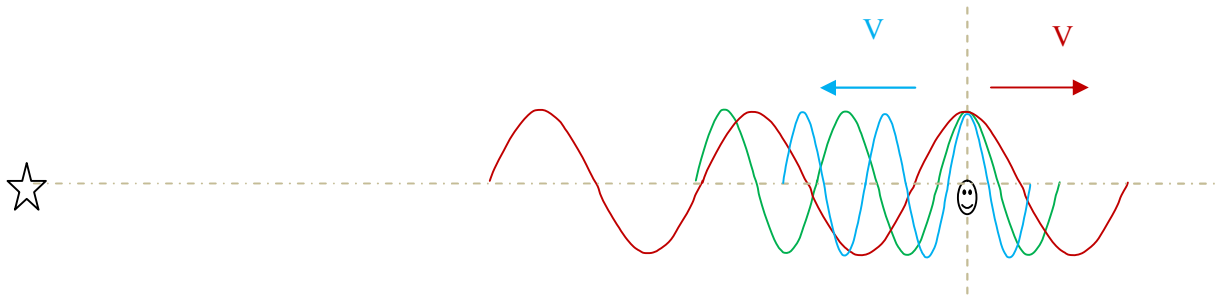

The green wave represents the wave for source and observer at rest relative to each other. The red and blue waves are for the cases of the observer moving away from the source and towards the source, respectively. Suppose that the observer is initially at rest relative to the source. He will observe the green wave. Now imagine that the observer accelerates instantaneously to velocity V towards the source. The wave observed by the observer will change instantaneously to the blue wave. The observer continues to observe the peak point (crest) of the wave but with shorter wavelength. The phase seen by the observer will be continuous (i.e. it will not jump to a different phase) but the wavelength will change discontinuously, if the acceleration to V occurs instantaneously. If the observer accelerates instantaneously from rest to velocity V away from the source, the observer will instantaneously start to see the red wave, but starts from the same

instantaneous phase as the green wave, i.e. peak point. This means that if the observer was just seeing the peak of the green wave when he instantaneously accelerated from rest to velocity V away from the source, he will start and continue from the peak of the red wave. This may be seen as compression/expansion of the wave *towards / away from the observer*. In my previous paper [6] the compression/expansion was towards/away from the source and this created undesirable effects.

Obviously, this is different from classical, conventional thinking. For sound waves, source only source velocity creates change in wavelength. Observer velocity doesn't change the wavelength of sound, but only the frequency. In the case of light, both the frequency and wavelength of light change [6] due to source observer relative velocity, and the Doppler effect is governed by the Exponential Law of Light [8].

Constant phase velocity and variable group velocity of light

Now that we have interpreted Einstein's thought experiment to mean that *phase* velocity is always constant c , we are freed from the confusion that group velocity also should be constant. By postulating that phase velocity is always constant c , we conform to Maxwell's equations. So there is no reason to assume that group velocity should also be constant always. Group velocity is independent of source velocity, but depends on observer and mirror velocity. With this theory we can think intuitively, clearly and explain many experiments and observations.

By making the distinction that the *phase* velocity, and not the group velocity, is constant, a century old puzzle has been solved. Special Relativity resulted from failure to make this distinction.

It is wrong and unnecessary to speculate that velocity of light is constant relative to all observers, without making this distinction. Therefore, there is no reason to think that the *group* velocity of light also is constant relative to any observer.

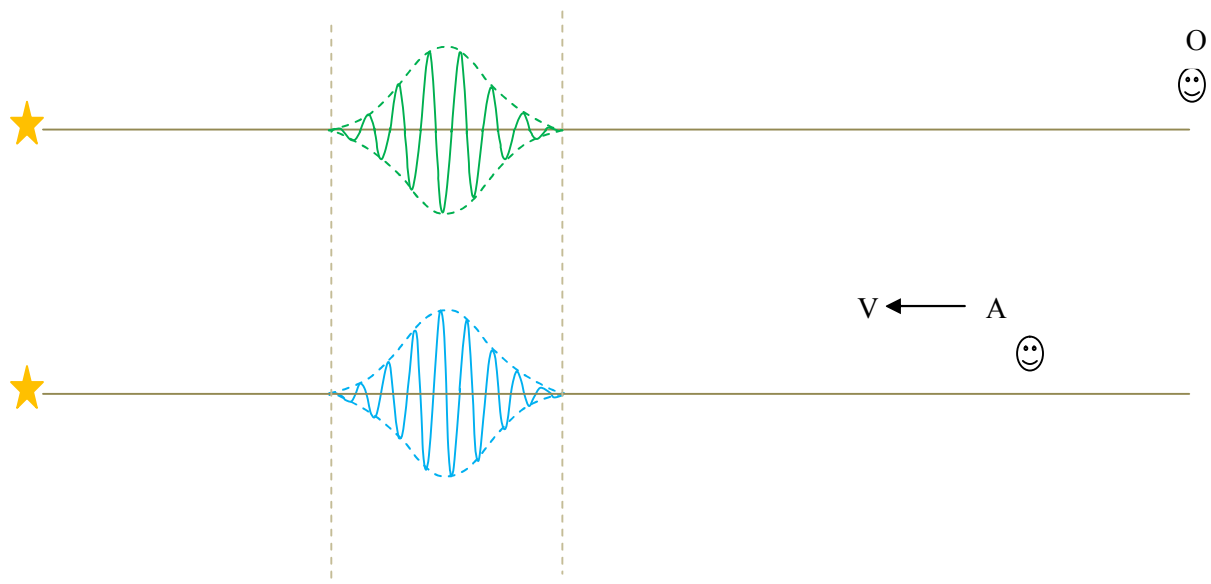

Consider two observers. Observer O is at rest relative to the light source and observer A is moving towards the light source.

Observer A who is moving towards the light source should logically detect the light pulse earlier than the stationary observer O. However, observer A should observe a spatially compressed (smaller wavelength) form of the wave observed by stationary observer O, so that the phase velocity is always constant c relative to observer A.

Even though the (sinusoidal) waves are compressed, the envelop or the group will not be compressed.

Note the slight compression of the blue sinusoidal waves as compared to the green sinusoidal waves, but that the two envelopes have the same width, in the figure above.

One implication here is that there is no conservation of the number of wave cycles in an envelope.

For the stationary observer O, the phases are at rest relative to the envelope. However, for moving observer A, the phases are moving relative to the envelope.

One experimental evidence for the variable group velocity of light (varying with observer's absolute velocity) is Ole Roamer's observation that the eclipse time of Jupiters moon I_0 is longer when the earth is moving away from Jupiter than when it is moving towards Jupiter, by about 22 minutes. This can be seen as the effect of absolute motion of the observer.

A new interpretation of Einstein's light speed thought experiment

Imagine a light source that is at rest and an observer moving away from the source at or near the speed of light, as Einstein imagined in his thought experiment. Assume that the observer was at the source position but just moving away at the speed of light at an instant of time $t=0$. Assume that the source emits a light pulse at this same instant of time, $t=0$.

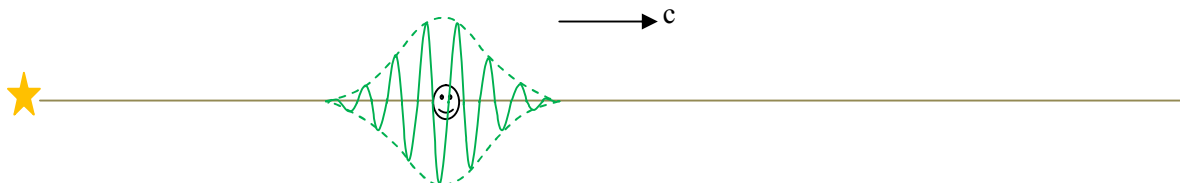

According to the 'constant phase velocity variable group velocity' theory, the phases always go past the observer at the speed of light, but the envelop will be at rest ('frozen') relative to the observer. Einstein (and no one else, I far as I know) never imagined such a possibility.

7. Doppler effect

We have already discussed that the phase velocity of light is always constant c irrespective of source and observer relative or absolute velocity. Now we postulate the following:

Doppler effect of light depends only on source observer relative velocity and not on the absolute velocities of the source or the observer.

The above postulate shows that only source observer relative velocity is relevant to Doppler effect. Source and observer absolute velocities are irrelevant in Doppler effect of light.

The disentanglement of absolute velocity from Doppler effect is one of the biggest challenges I faced during the development of this theoretical framework.

How Doppler effect is not affected by absolute velocity is described later on under 'Physical Meaning'. For now we just apply the above postulate. Even though absolute velocity is not relevant to Doppler effect, I have chosen to make the discussion as different combinations of source and observer absolute velocities, even if only relative velocity is relevant, to show and clarify other effects such as aberration at the same time, for a more complete understanding.

Longitudinal Doppler effect

In this case we consider a light source and an observer directly approaching each other or receding away from each other, with radial velocity component only

Source at absolute rest, observer in absolute motion



According to the Exponential Law of Light:

$$\lambda_r = \lambda_0 e^{v/c} \quad \text{and} \quad f_r = f_0 e^{-v/c}$$

where λ_0 and λ_r are emitted and received wavelengths, respectively. and f_0 and f_r are emitted and received frequencies, respectively.

V is positive for source and observer receding away from each other.

A light pulse emitted by the source is detected by the observer after a time delay of:

$$\tau = \frac{D}{c - V}$$

where D is the distance between source and observer at the instant of emission. This shows that the group velocity of light varies with observer velocity, as already discussed.

Observer at absolute rest and source in absolute motion



The equations for Doppler effect are the same as above but we see 'aberration' in this case, i.e. the apparent past position (position of source at the instart of emission) of source is different from the actual past position.

$$\lambda_r = \lambda_0 e^{V/c} \quad \text{and} \quad f_r = f_0 e^{-V/c}$$

Even though the past position of the light source is apparently changed, this does not affect the time delay between emission and detection of light, which is:

$$\tau = \frac{D}{c}$$

where D is the distance between source and observer at the instant of emission. This shows that the speed of light does not depend on the velocity of the source.

Transverse Doppler effect

It will be shown that transverse Doppler shift does not exist.

We know that in Doppler effect of sound waves, there is no change in frequency or wavelength of sound emitted at the point of closest approach, in the transverse (ninety degree) direction, for moving source and stationary observer.

Next we see the approach in the determination of Doppler shift of light.

Source is in absolute motion and observer is at absolute rest.

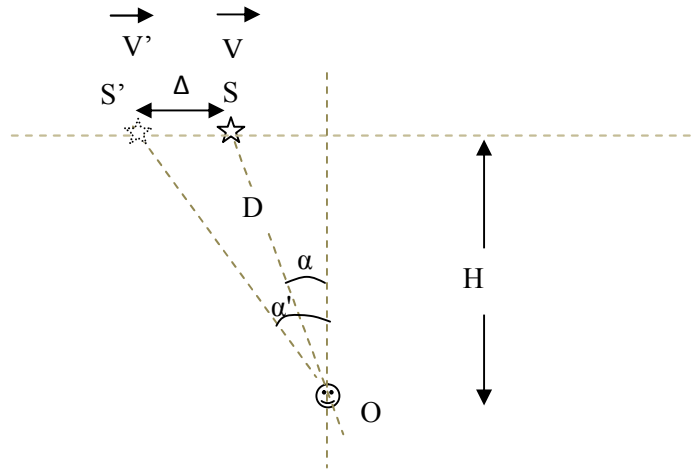

As we postulated already, Doppler effect depends only on source observer relative velocity and not on any source or observer absolute velocity.

However, there will be aberration, as shown. Note that S is the actual past position of the source, where as S' is its apparent past position. Even though the light apparently started from point S' (at the instant of emission), the time it takes light to reach the observer is still D / c . The effect of source absolute velocity is just to create aberration, i.e. apparent change in the past position of the source in this case. Note that this is different from Bradley aberration which depends only on relative velocity.

Regarding Doppler effect, there will be no Doppler effect of light emitted at the nearest approach point (i.e.at the ninety degree position). There is no transverse Doppler effect. Then what about the Ives – Stilwell experiment? The red shift in the Ives – Stilwell experiment is not due to transverse Doppler effect, but due to law governing the longitudinal Doppler effect of light: Exponential Law of Light [9], in which longitudinal Doppler effect is asymmetric.

Next we see specific cases based on the above general conclusion.

Light received at the moment of closest approach

Source at absolute rest and observer in absolute motion

Again, Doppler effect depends only on source observer relative velocity and not on any source or observer absolute velocity.

From the figure below (parallel wave fronts, for simplicity) we see that transverse motion of the observer will have no effect on the phase velocity and hence on the wavelength and frequency of light seen by the observer. The phases will always go at c past the observer. No transverse Doppler effect (TDE). Only radial / longitudinal velocity component will have the expansion or compression effect on the wave to keep phase velocity constant.

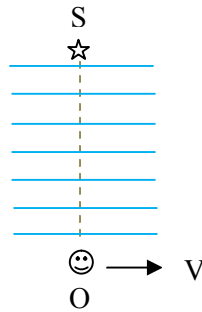

Sound received at the moment of closest approach will not be Doppler shifted also, for a stationary source and moving receiver.

Source in absolute motion and observer at absolute rest

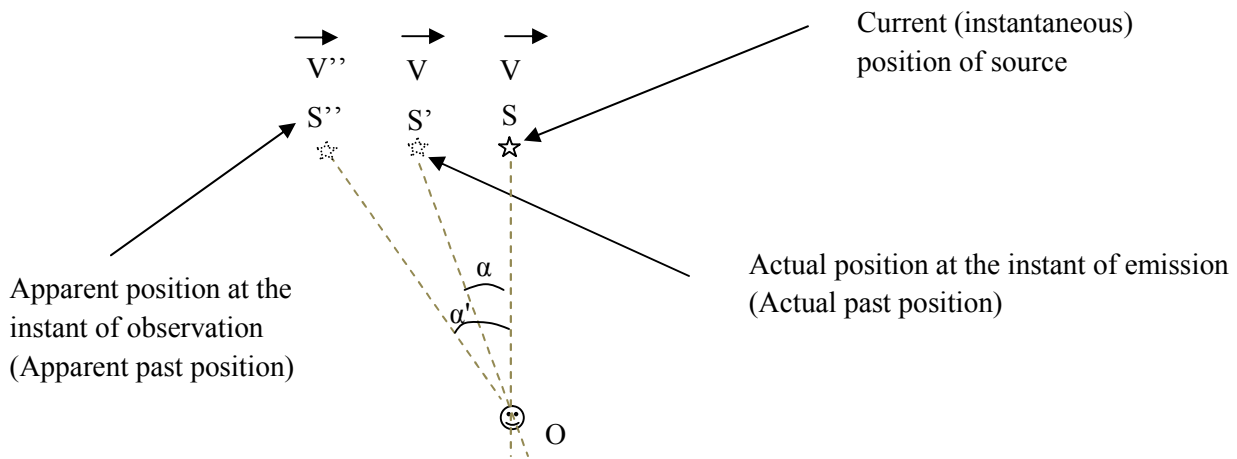

The source position now (at the moment of observation) is at S, moving with velocity V. But the source was at position S' at the moment of emission, moving with velocity V also, assuming uniform motion. The apparent position of the source at the moment of observation (i.e. apparent past position) is at S'' as seen by the observer. i.e. it appears to the observer as if the source emitted the light from position S'', not from S'.

The above figure shows aberration effect.

The Doppler shift is determined by the radial/ longitudinal component of the velocity V' , i.e. the velocity of S' towards observer O, NOT the velocity (V'') of S'' towards O. Remember that V'' is different from V. This is because Doppler effect is not affected by absolute motion and S'' is only an apparent position caused by absolute velocity of the source. The Doppler effect is caused

by the velocity of the source at the actual past position of the source. Therefore, light received at the moment of closest approach is blue shifted. We will not call this transverse Doppler effect because the same happens for sound wave also, i.e. sound received at the moment of closest approach will also be 'blue' shifted.

In this case, light received at the moment of closest approach is Doppler shifted as follows:

$$\lambda_r = \lambda_0 e^{-v \sin \alpha / c} \quad \text{and} \quad f_r = f_0 e^{v \sin \alpha / c}$$

But it can be shown that

$$\sin \alpha = \frac{V}{c}$$

Substituting in the above equation gives

$$\lambda_r = \lambda_0 e^{-k} \quad \text{and} \quad f_r = f_0 e^k$$

where

$$k = \frac{V^2}{c^2}$$

Light emitted at the moment of closest approach

Source at absolute rest and observer in absolute motion

Light emitted at the instant of closest approach will be received after a delay of time. If the observer continues to move in the same direction, he /she will see, obviously, a red shifted light, as shown below.

Only the radial velocity component of the observer's velocity will result in a Doppler shift. Again we would not call this transverse Doppler effect because the same holds for sound also.

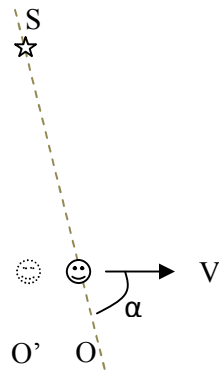

The Doppler shift will be as follows:

$$\lambda_r = \lambda_0 e^{v \cos \alpha / c} \quad \text{and} \quad f_r = f_0 e^{-v \cos \alpha / c}$$

But it can be shown that

$$\cos\alpha = \frac{V}{c}$$

Therefore

$$\lambda_r = \lambda_0 e^k \quad \text{and} \quad f_r = f_0 e^{-k}$$

where

$$k = \frac{V^2}{c^2}$$

Source in absolute motion and observer at absolute rest

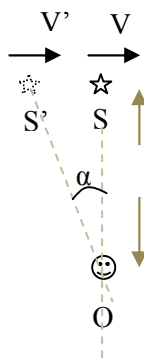

We know that there will be no Doppler effect for sound emitted at the moment of closest approach, for moving source and stationary observer.

The source emitted light from point S. The observer receives the light after a time delay, $\tau = D/c$. At the moment of observation, it appears to the observer that the light *was* emitted from point S', and not from point S. This is aberration.

However, there will be only an aberration effect and no (transverse) Doppler shift.

In all cases, transverse Doppler effect does not exist.

Transverse Doppler effect exists only if the frequency of the source changes in the rest frame of the source due to absolute motion of the source. In a later section, it is proposed that mass of objects increases with absolute velocity. In this case, the mass of the electrons and the energy level of atoms of a light source may be affected due to the absolute velocity of the source and somehow affect the frequency of light in the rest frame of the source, but the expression will be different from that of Special Relativity, if mass increase with velocity actually exists. But the assertion of mass increase with velocity is not mere speculation and is based on a new interpretation of experimental facts. Otherwise, transverse Doppler as expressed by SRT does not exist.

8. Exponential Law of Light - the mystery behind Ives-Stilwell experiment

In Special Relativity, transverse Doppler effect arises because of *multiplication* of the classical Doppler shift formula by the gamma (γ) factor.

However, the Ives-Stilwell experiment can be explained by a very compelling alternative theory- Exponential Law of Light [8]. The observed red shift results from *asymmetrical* longitudinal Doppler shift, unlike the classical formula which predicts symmetrical longitudinal Doppler shift.

Although I previously proposed this theory[8] from a different line of reasoning, which I have abandoned now, the ease with which it explains the Ives-Stilwell experiment makes it very compelling and I have still adopted it in this paper.

The mysterious term governing Doppler effect of light is proposed as:

$$e^{V/c}$$

where V is the source - observer relative velocity.

Therefore, the formula for *longitudinal* Doppler shift would be:

$$\lambda' = \lambda e^{V/c} \quad \text{and} \quad f' = f e^{-V/c}$$

V is positive for receding source and observer

Now, in the Ives-Stilwell experiment, the wavelength of the light emitted from the ion in the forward direction would be:

$$\lambda'_{F} = \lambda e^{V/c}$$

The wavelength of light emitted in the backward direction would be:

$$\lambda'_{B} = \lambda e^{-V/c}$$

The average wavelength:

$$\Lambda = \frac{1}{2} (\lambda'_{F} + \lambda'_{B}) = \lambda (e^{V/c} + e^{-V/c})$$

$$\Delta = \Lambda - \lambda = (e^{V/c} + e^{-V/c} - 1) \lambda \approx \frac{1}{2} \left(\frac{V}{c}\right)^2 \lambda = \frac{1}{2} \frac{V^2}{c^2} \lambda \quad (\text{using Taylor's expansion})$$

This is the same formula predicted by Special Relativity and confirmed by the Ives-Stilwell

experiment.

The Exponential Law of Light also governs the phenomenon of apparent change of position of light source relative to observer (Apparent Source Theory), which is a result of absolute motion of source.

The formula for apparent position of light source relative to observer would be, for absolutely co-moving source and observer:

$$D' = D e^{V_{abs}/c}$$

V_{abs} is positive for source behind observer, as seen in the direction of absolute velocity.

Many formulas used in this paper so far containing terms like $c \pm V$, $c^2 \pm V^2$ are fundamentally wrong but can be used for $V \ll c$ with insignificant error. As the value of V approaches c , however, these formulas give errors of many orders of magnitude. They should be replaced with exponential formulas.

The formula $D' = D e^{V_{abs}/c}$ applies to the special case in which the source-observer common absolute velocity vector is parallel to the line connecting the source and the observer.

The general case is proposed as follows:

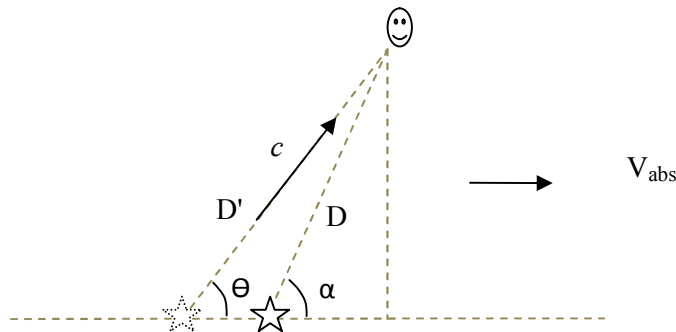

The general formula is proposed as follows:

$$D' = D e^{(V_{abs}/c)\cos\theta}$$

where θ is the angle between the absolute velocity vector V_{abs} and the light speed vector c .

$$\cos\theta = \frac{\sqrt{D'^2 - D^2 \sin^2\alpha}}{D'}$$

For an observer in front of the source, for absolutely co-moving source and observer, the angle

$$\Theta = 0$$

$$\cos\theta = 1 \Rightarrow D' = De^{v_{abs}/c}$$

For an observer behind the source, for absolutely co-moving source and observer, the angle $\Theta = 180$

$$\cos\theta = -1 \Rightarrow D' = De^{-v_{abs}/c}$$

If the absolute velocity is perpendicular to the line connecting the source and observer, as shown below:

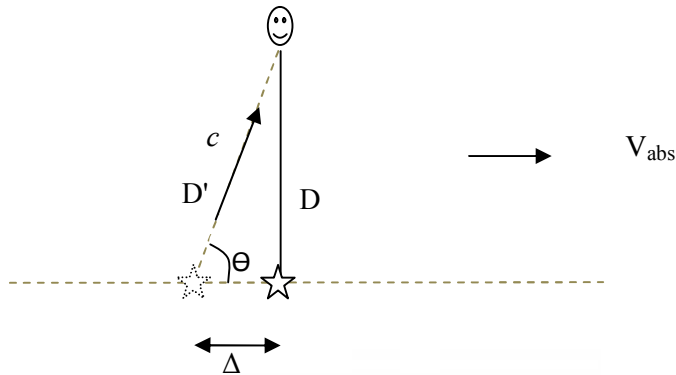

$$\cos\theta = \frac{\Delta}{D'} = \frac{\sqrt{D^2 - D'^2}}{D'}$$

which will be substituted in the general formula:

$$D' = De^{(v_{abs}/c)\cos\theta}$$

Modern Ives-Stilwell experiment: fast ion beam experiment

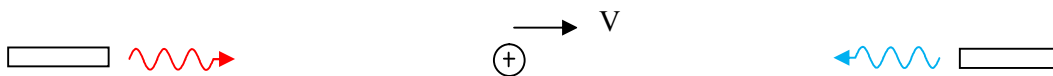

The frequencies of the two laser beams as seen by the ion will be:

$$f_{01} = f_R e^{-v/c}$$

$$f_{02} = f_B e^{v/c}$$

From which follows:

$$f_{01}f_{02} = f_R f_B \Rightarrow \frac{f_{01}f_{02}}{f_R f_B} = 1$$

where f_{01} and f_{02} are the two transition frequencies, in the rest frame of the ion. The above result is consistent with experiments.

Effect of Earth's absolute motion on the Ives-Stilwell experiments

Since the effect of apparent change in position of the light source is only to create a change in path length of light, the effect of Earth's absolute motion is just to create a change in time delay of the photons, i.e. a change in time interval between emission and reception of a photon. Hence Earth's absolute motion does not change the Doppler effect, hence the frequency of detected photons. This is what was confirmed by the fast ion beam experiment. Only the phase of the photons will be affected by Earth's absolute motion and this has no effect on the result of the experiment.

9. Physical meaning

So far we have developed a model of the speed of light to successfully predict and explain the outcome of experiments of the speed of light and absolute/ relative motion. But the physical meaning of these models has been one of the greatest challenges in the development of this theoretical framework. We have already discussed an apparent paradox associated with Apparent Source Theory (AST). In AST, we have been replacing the real source with an apparent source and then assumed Galilean space and emission theory to *consistently* explain many experiments, such as the conventional and modern Michelson-Morley experiments, the Sagnac and Michelson-Gale experiments, moving source and moving mirror experiments, the Silvertooth and Marinov experiments, the Ronald de Witte experiment, the Bryan G. Wallace experiment, stellar aberration, Doppler effect , Einstein's thought experiment: chasing a beam of light, the Ives-Stillwell experiment. No existing theory of light can consistently explain even two of these experiments: the Michelson-Morley experiment and Sagnac effect. Different theories have been proposed within a single theoretical framework: Apparent Source Theory, constant phase velocity and variable group velocity of light, Exponential Law of Light, and the dependence of Doppler effect only on relative velocity and not on absolute velocity.

Despite the success of this theoretical framework, understanding the physical meanings and the relationships of the theories posed a great challenge.

The puzzles were:

1. What is the physical meaning of replacing the real source with an apparent source ?
2. How can Doppler effect be disentangled from absolute velocity? Why does Earth's absolute velocity not affect characteristic wavelengths of atoms ? Why was Ives-Stilwell experiment not

affected by Earth's absolute velocity? No such effect of Earth's absolute motion has ever been observed.

3. Why transverse Doppler effect should not exist

4. AST states that, for absolutely co-moving source and observer, only the path length, and not the velocity of light, varies. But we know that Silvertooth detected a change in 'wavelength'. Even if we may interpret that as an apparent change of wavelength, what does that mean?

However, we have to be cautious that we should clearly understand the physical meaning or we will be misled. We should use the physical meaning to get some intuitive understanding only and apply AST as described so far. It will be misleading to interpret the physical meaning conventionally. One example is the 'change' in wavelength detected in the Silvertooth experiment. The 'change' in wavelength is only apparent. The accurate description is that wavelength and speed of light will not be affected by absolute motion, for co-moving source and observer. Therefore, to solve problems, we just apply AST as described so far, by strictly adhering to the procedure:

1. Replace the real source with the apparent source
2. Solve the problem by assuming (modified) emission theory and/or Galilean space.

We must understand the physical meaning of the AST to help us to understand the theory intuitively. For example, the experiment proposed in the next section is based on the bending of light rays, which is just a physical meaning. This intuitive understanding helped us to understand what is happening physically and hence to set up an appropriate experiment (putting a slit between source and observer).

Imagine a light source and an observer absolutely co-moving, as shown below.

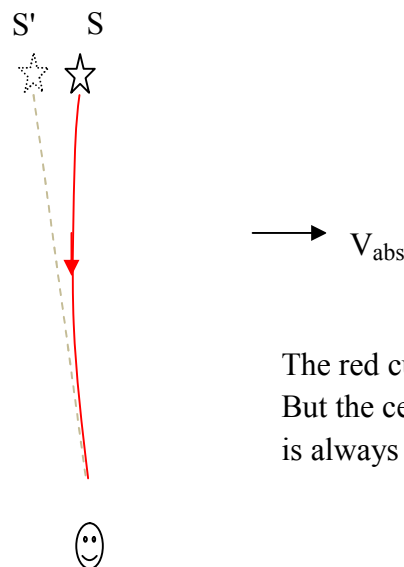

The red curve shows the path of the *group*.
But the center of the spherical wave fronts
is always at the (real) source S.

We see that the apparent change in position of the source is due to the curving of the light rays, as shown above. *The curve is determined by applying the Apparent Source Theory (AST) at every point.* Even though the source is physically, actually at position S relative to the observer, it appears to the observer that it is at position S' and this is due to the curving of the light ray which is a result of absolute motion.

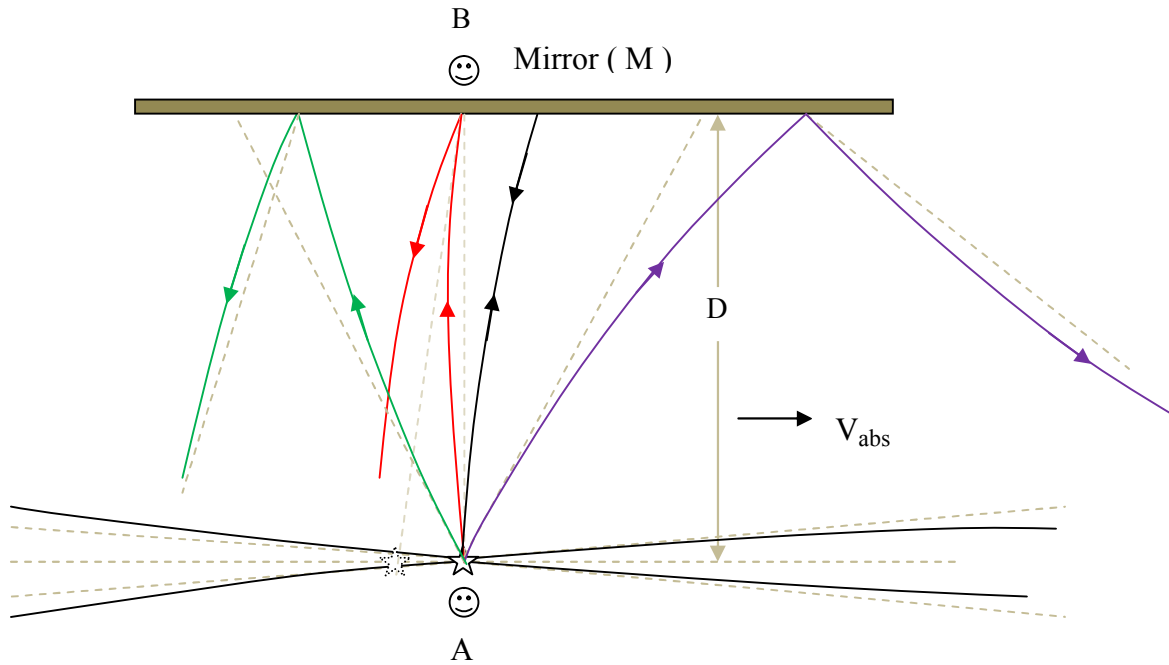

The apparent contradiction described previously in the section:

' Where does a light beam start? Apparent contradiction in the new theory '

is resolved as shown in the above figure. The red light ray is detected by observer B, and the black light ray is the ray going from the source to the mirror and reflected back and detected by observer A. Observers A and B will not see the same light ray. Physically, actually the light ray that will go from the source to the mirror and reflected back to the observer is curved (black ray) and will not be the same ray detected by observer B, who will observe the red ray, and the time of flight of the black ray from the source to the mirror is greater than the time of flight from the mirror back to observer A so that the round trip time of the black ray is $2D/c$. *Apparently,* however, it appears to observer O that the black ray goes straight to observer B and reflected back on itself. This is because the line connecting observers A and B is tangent to both the incident and reflected black rays at the point of observer A or just at the source. This is only to show what is happening physically and the curving of the black rays is not important if observer A wants to calculate the round trip time of the light. But the curving is real, physical and it means that if there is an obstacle along the line connecting the two observers, say near the midpoint, light will still get to the mirror and reflected back to the observer A because the black

ray doesn't actually, physically go along the line connecting the two observers. From the diagram, we also see that the angle of incidence is different from the angle of reflection for the light rays.

An interesting question is: how are the (curved) light rays constructed? For the incident rays, theoretically *at every point*, we apply the AST as described so far to calculate and locate the apparent source position as seen *from that point* and put a line of infinitesimal length at that point, with such a slope that it will pass through the apparent source position when projected, i.e. the infinitesimal line is part of the apparent straight light ray coming from the apparent source. We do this to every point. Then a pattern of the flow of the light rays will emerge. For reflected rays, again *for every point*, we apply AST to calculate and locate the position of the apparent source as seen from that point. Then we easily draw the apparent straight light ray that will come to that point from the apparent source after reflection from the mirror, with angle of incidence equal to the angle of reflection, as usual. Then we put an infinitesimal length of line at that point which is part of the apparent straight light ray coming from the apparent source after reflection from the mirror. After doing this for every point a pattern emerges for reflected rays.

Note again that this is just to show what is happening physically so that we will have an intuitive understanding. We don't need to draw curved light rays to analyze and predict the results of experiments.

In the above discussion, it has been shown that the light rays from a light source in absolute motion will be bent in the lateral directions (i.e. in directions other than forward and backward directions). In the forward and backward directions, obviously, the light rays will not be bent, but the speed of light will be $c - V$ and $c + V$ *relative to the source*, respectively.

For better clarification and to make sure that there are no misunderstandings, let us consider two cases for the following system,. In the first case the system moves to the right with absolute velocity V_{abs} (a), and with absolute velocity V_{abs} upwards in the second case. The question is: will there be bending of the light rays? The mirror is inclined at 45° .

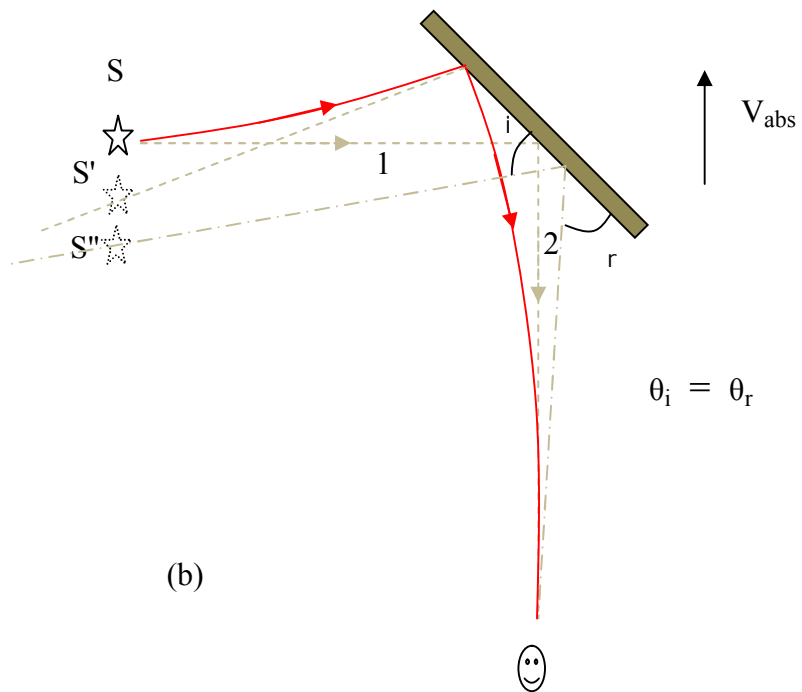
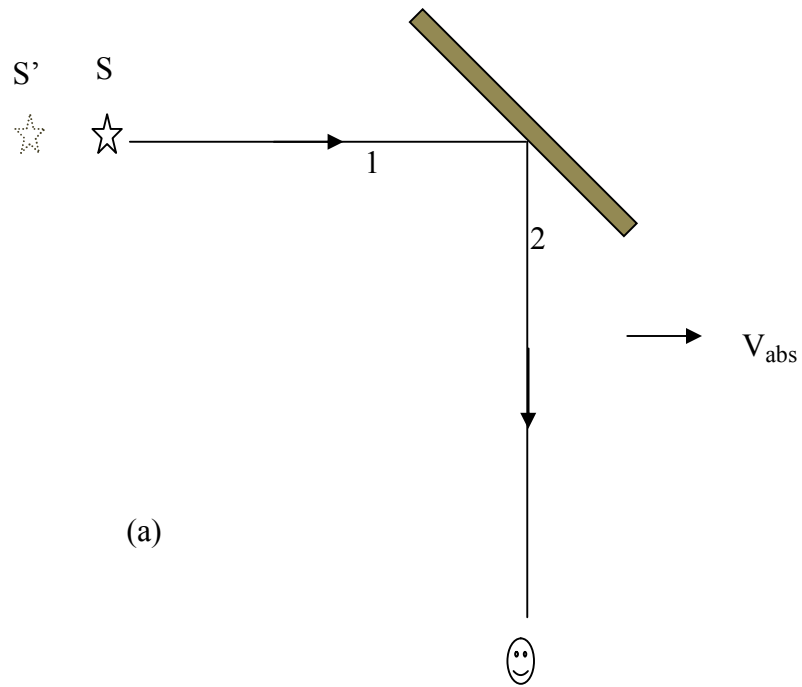

The answer is that there will not be any bending of both the incident ray 1 and the reflected ray 2 when the system is moving to the right (a). For absolute velocity V_{abs} directed upwards (b) there

will be bending of both rays, 1 and 2, as shown by the bent light rays in red. S' is the apparent source as seen from a point the incident curved ray is reflecting from the mirror. S'' is the apparent source as seen from the location of the observer. Note that theoretically the apparent source position has to be determined for every point in which case there will be infinite apparent sources. We considered just two apparent sources for simplicity of the discussion. The drawing is not meant to be accurate but only for a qualitative explanation. Note that the reflected curved ray in (b) is tangent with the broken line at the observer, as shown in the diagram.

For an absolutely moving source, group velocity of light is constant relative to the apparent source, not relative to the real source. The group velocity of light varies in magnitude and direction relative to the (real) source. Phase velocity is always constant, independent of any source or observer absolute or relative motions.

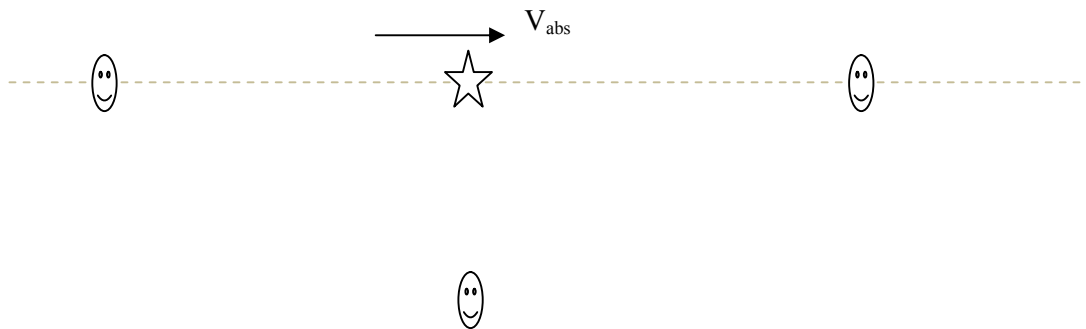

Consider absolutely co-moving source and observers (see above figure).

The phase velocity is always constant c for all three observers, irrespective of the magnitude of absolute velocity. The phases will always move at c past the observers. For the front observer, the group velocity is $c - V_{abs}$. For the rear observer, the group velocity is $c + V_{abs}$. For the side observer, the group velocity is $(c^2 - V_{ab}^2)^{1/2}$. For the side observer, the light ray arrives from the direction of apparent source and not from the direction of the real source. Note that these velocities are obtained by dividing the source observer physical distance by the time delay between emission and detection of light. For the front and rear observers it can be shown that the group velocity of light determined in this way is also the local group velocity, i.e. small local distance near the observer divided by the time elapsed for light to travel that distance. For the side observer, the local group velocity is yet to be computed to check if it is the same as the average group velocity $(c^2 - V_{ab}^2)^{1/2}$ determined by dividing the source observer distance by the time elapsed between emission and detection.

The next diagram shows what happens physically to the light rays from a source in absolute motion.

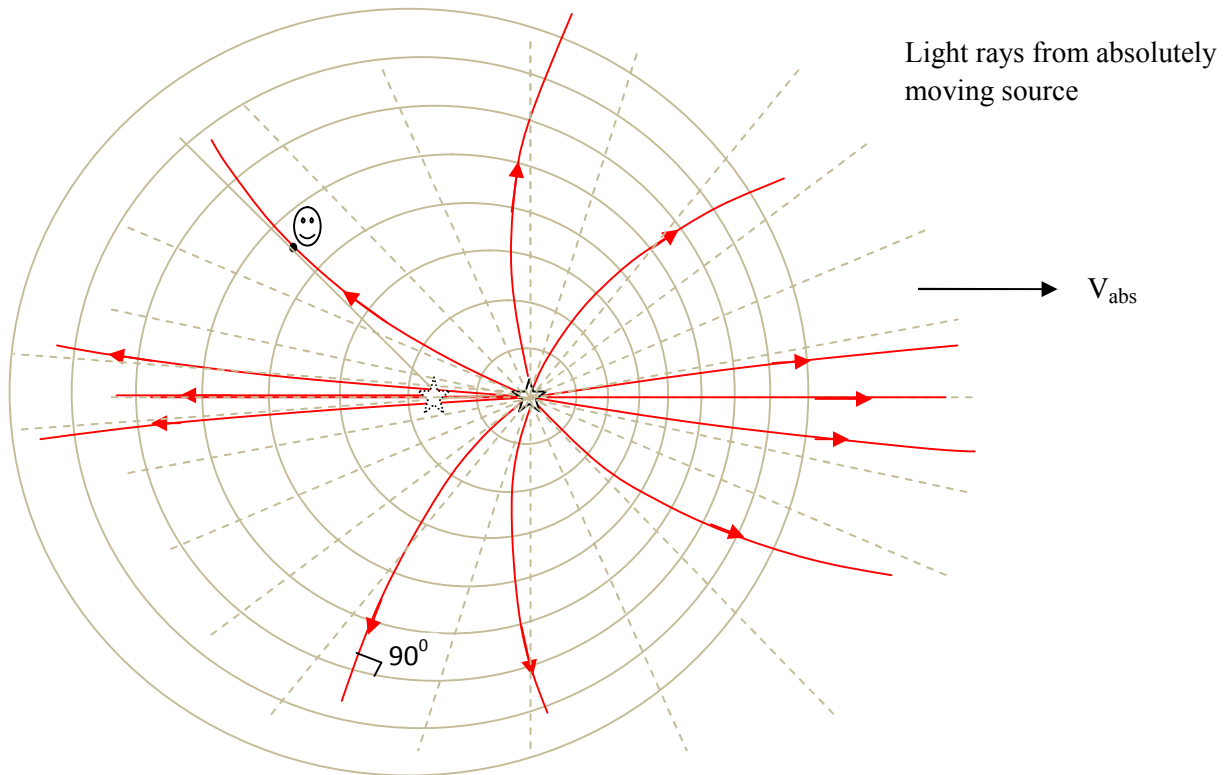

* note that the above diagram is not drawn accurately. The light rays should always make 90° with the wave fronts.

In lateral directions the bending of light rays is large. As we approach the forward and backward directions, the bending of the light rays becomes less and less. In the forward and backward directions (with respect of direction of absolute velocity), the light rays are straight and there is no bending, but different phase and group velocities. Note that the drawing is not meant to be accurate, but only to serve as a qualitative illustration.

The group velocity of light is constant relative to the apparent source. Physically, this means that the effect of absolute motion of a light source is to create a change in the (group) velocity (magnitude and direction) of light relative to the real source.

Let us consider only the forward and backward light rays from a source in absolute motion, for simplicity.

Relative to the real source, the group velocity of light will be $c - V_{abs}$ and $c + V_{abs}$, for the forward light beam and for the backward light beam, respectively.

This is just a modified emission theory because, for a given absolute velocity, the speed of light in a given direction is constant *relative to the source*. The effect of absolute motion of the source is just to create a change in the group velocity (*magnitude and direction*) of light ***relative to the***

source. In the forward and backward directions, only the magnitudes vary and the direction of the light rays are radial. In all other directions, both the magnitude and direction of the group velocity of light vary with absolute velocity of the source. The direction of the light rays are not purely radial and will have transverse components in the lateral directions because the light rays are curved.

According to conventional emission theory, the speed of light is the same c relative to the source and directed radially in every direction relative to the source. In Apparent Source Theory (AST) the group velocity of light from a source that is in absolute motion is not the same in every direction relative to the source and the light rays are curved in the lateral directions (in directions different from the forward and backward directions). Just as conventional emission theory predicts a null fringe shift for the Michelson Morley experiment, so does the AST because, for a given absolute velocity, and in a given direction relative to the source, the velocity of light is 'constant' *relative to the source*. Note that by 'constant' we mean, for example, $c + V_{abs}$.

We can easily explain the Sagnac effect by the physical meaning of AST. Since the source has absolute velocity ($V_{abs} = \omega R$), the speed of the forward beam is $c - V_{abs}$ RELATIVE TO THE SOURCE and the speed of the backward beam is $c + V_{abs}$ RELATIVE TO THE SOURCE, hence a fringe shift. This is true for the hypothetical Sagnac interferometer discussed earlier. I haven't yet figured out the application of Apparent Source Theory to the real Sagnac interferometer.

Proposed experiment to detect absolute motion and to test Apparent Source Theory

According to Apparent Source Theory (AST), the light rays from an absolutely moving source will be bent in the lateral directions. Therefore, detection of bending light rays means detection of absolute motion and also confirmation of AST.

Consider a light source and an observer absolutely co-moving, as shown below.

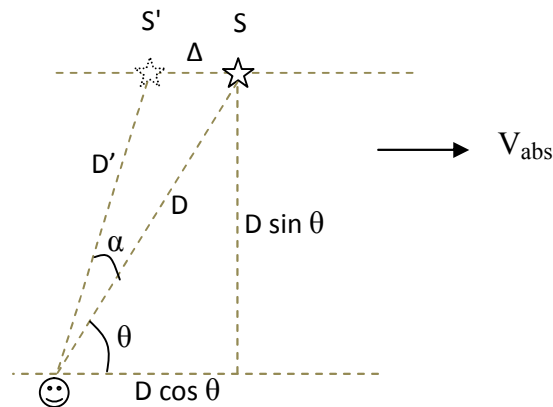

We want to get the relationship between θ and Δ .

$$\Delta = D \cos \theta - \sqrt{D'^2 - D^2 \sin^2 \theta} \dots \dots \dots (1)$$

$$\frac{D'}{c} = \frac{\Delta}{V_{abs}} \dots \dots \dots (2)$$

From (1) and (2)

$$D'^2 \left(1 - \frac{V_{abs}^2}{c^2} \right) + \frac{2DV_{abs}}{c} \cos \theta D' - D^2 = 0$$

which is a quadratic equation of D' .

$$\Rightarrow D' \approx D - \frac{DV_{abs}}{c} \cos \theta, \text{ for } \frac{V_{abs}^2}{c^2} \approx 0$$

From (2),

$$\Delta = \frac{V_{abs}}{c} D' \Rightarrow \Delta = \frac{V_{abs}}{c} \left(D - \frac{DV_{abs}}{c} \cos \theta \right) \dots \dots \dots (3)$$

But

$$\frac{\sin \alpha}{\Delta} = \frac{\sin \theta}{D'} \dots \dots \dots (4)$$

$$\Rightarrow \sin \alpha = \frac{V_{abs}}{c} \sin \theta$$

α will be maximum when $\theta = 90^\circ$

$$\sin \alpha_{max} = \frac{V_{abs}}{c} \Rightarrow \alpha_{max} = \sin^{-1} \frac{V_{abs}}{c}$$

From (3)

$$\Delta_{max} = \frac{V_{abs}}{c} D \text{ (for } \theta = 90^\circ)$$

We have shown that the maximum apparent change in the position of the light source (Δ_{max} and α_{max}), hence the maximum bending of the light rays, occurs when the absolute velocity of the co-moving source and observer is orthogonal to the line connecting the source and observer. Hence there will be maximum sensitivity with this orientation, as shown below.

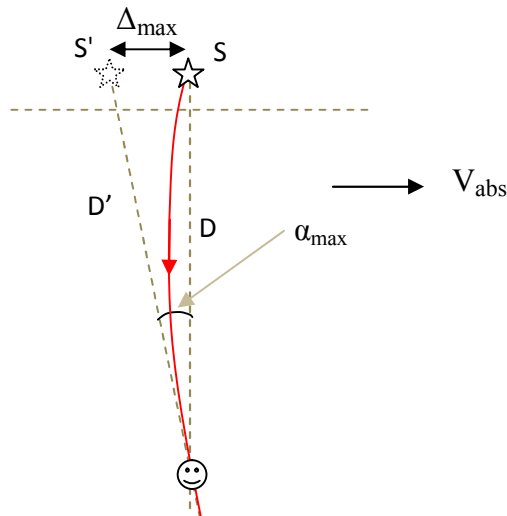

Now that we have determined the orientation of the source and observer relative to the absolute velocity vector for maximum apparent change of position of the light source, and this can be used for maximum sensitivity to detect absolute velocity of the light source.

Assume that the source S is isotropic, i.e. it radiates equally in all directions. In this case, the intensity of light at the observer will not be affected significantly by absolute velocity, the only effect being light rays coming at an angle, which is very small for $V_{\text{abs}} \ll c$, and this will not practically affect the light intensity as compared to when absolute velocity is zero with straight light rays coming from the source. The effect of absolute velocity is to cause a change direction from which light arrives at the observer.

Let us see the experimental setup to detect absolute velocity with an isotropic light source.

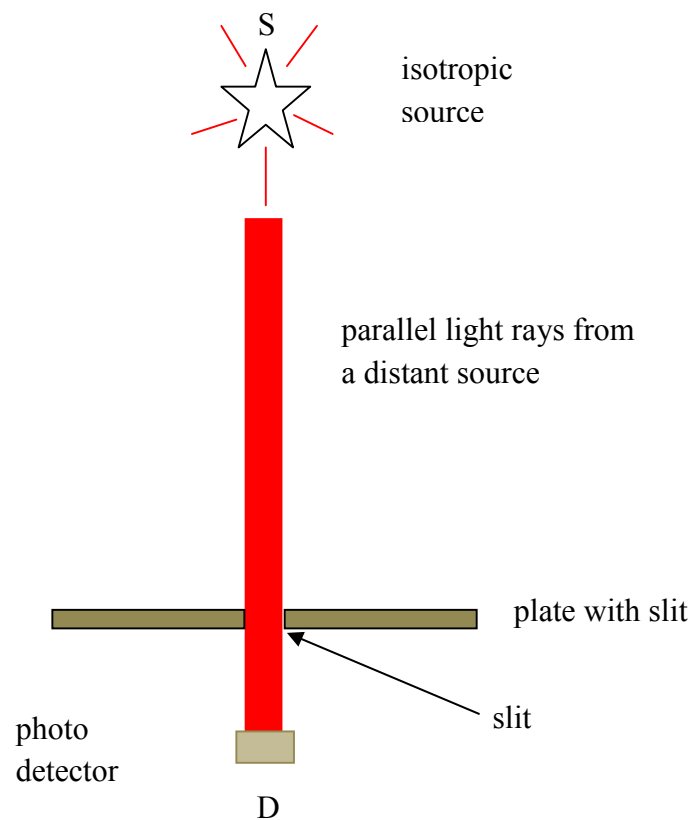

If the whole apparatus is at absolute rest, or if the line connecting the source and the photo detector (line SD) is oriented parallel to the absolute velocity vector, there will be no bending of the light ray.

But when the line SD is orthogonal to the absolute velocity vector, the light ray will be bent and the angle of arrival α of the light ray will be different from zero as shown in the next diagram.

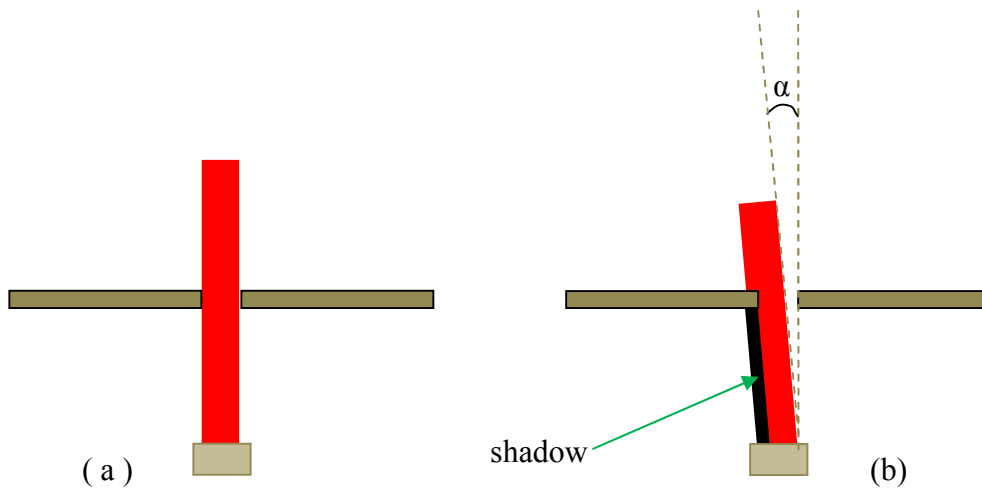

We can see that when the light is bent due to absolute motion, part of the light rays is blocked by the plate, creating a shadow and hence a decrease in intensity (quantity of light per unit area) of light falling on the photo detector. By measuring the voltage output of the photo detector, it is possible to observe variation of light intensity with variation in absolute velocity and with variation in orientation of line SD relative to the absolute velocity.

An approximate analysis is as follows.

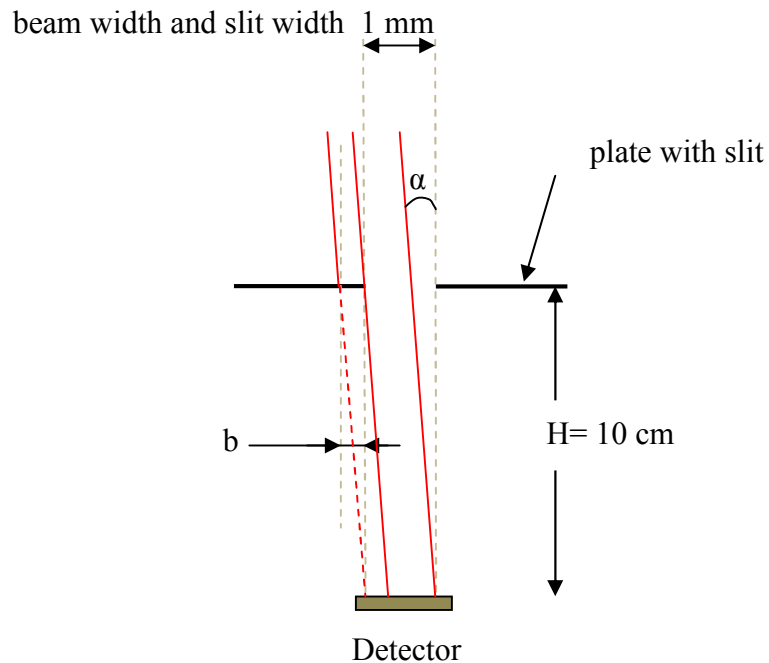

Suppose that the slit is circular.

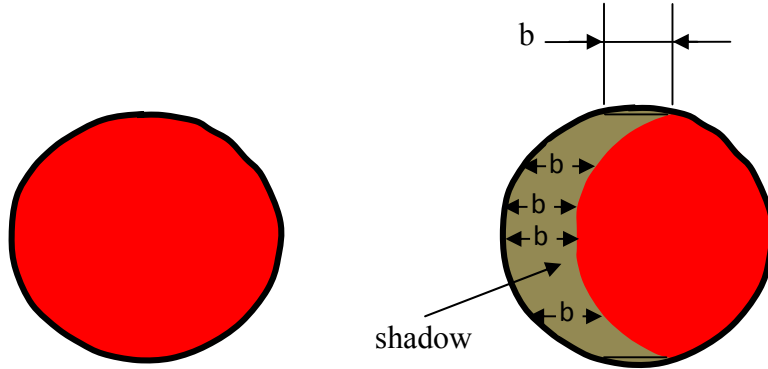

The left diagram shows a bright circular spot on the photo detector which will occur when there is no bending of the light ray. The right diagram shows what the spot of the light ray on the photo detector looks like, with a shadow due to bending of the light ray. Note that the size of the shadow has been exaggerated, which is actually only about 16.56% of the total area of the circle for an absolute velocity of 390 Km/s of the Earth.

$$\frac{b}{H} = \sin\alpha = \frac{V_{abs}}{c}$$

$$b = H \frac{V_{abs}}{c}$$

If we take Earth's absolute velocity, $V_{abs} = 390 \text{ Km/s}$, $c = 300,000 \text{ Km/s}$

$$b = 100 * 390/300,000 \text{ mm} = 0.13 \text{ mm}$$

Area of the shaded (shadowed) area is:

$$dA_{sh} = b dh \Rightarrow A_{sh} \approx 2 \int_0^r b dh = 2br$$

where r is the radius of the slit.

$$A_{sh} = 2 * 0.13 * 0.5 = 0.13 \text{ mm}^2$$

This is the area of the shadowed part.

The total area A of the circle is :

$$A = \frac{\pi D^2}{4} = \frac{\pi(1)^2}{4} = 0.785 \text{ mm}^2$$

Since we assumed an isotropic source, the intensity of the light falling is uniform, then we can calculate the percentage of change in intensity due to bending of the laser beam.

$$\frac{A_{sh}}{A} * 100\% = \frac{0.13}{0.785} 100\% = 16.56\%$$

This is a big change !

To measure absolute velocities, the instrument has to be calibrated first. It would be easier and more accurate to use this method than to try to determine analytically the change in intensity for a given absolute velocity and for a given orientation of line SD relative to the absolute velocity.

The calibration is done by recording the voltage output of the photo detector for different angles of the arriving light ray, by changing the position of the source physically relative to the slit and the photo detector, as shown in the next diagram. Then, when measuring absolute velocity, the angle α of the light ray corresponding to the voltage output of the photo detector is read from the calibration table. Once the angle α is obtained, the absolute velocity is determined from the formula:

$$\sin\alpha = \frac{V_{abs}}{c}$$

Remember that this formula applies for line SD orthogonal with the absolute velocity vector.

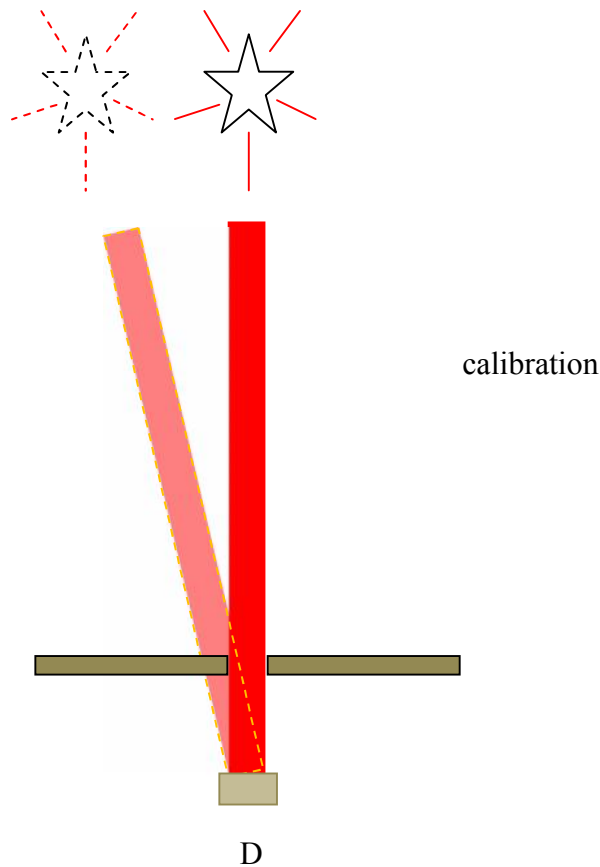

But there is problem with this method of calibration. For calibration, the apparatus needs to be at absolute rest so that the light rays from the source are radial and straight. Since the Earth is in absolute motion (390 Km/s), this method (calibration) is not practical.

There is another feasible method. The line SD (source-observer line) is oriented to be parallel (or anti parallel) with the Earth's absolute velocity. The assembly consisting the plate and the light detector is then rotated to different angles, with a resolution of a few arcseconds. At each angular position, the intensity of light detected by the detector is recorded in a calibration table, corresponding to each angular position. During calibration, the line SD is always parallel with Earth's absolute velocity. Once the calibration is completed, the plate and detector assembly is returned to its initial angular position and fixed in that position. The line SD is then oriented to be in the plane orthogonal to Earth's absolute velocity. The light intensity measured by the light sensor (detector D) is then noted and the corresponding angle α read from the calibration table, from which Earth's absolute velocity can be determined. The calibration method requires a rotation stage with resolution of about 2 arcseconds.

The other method is analytical method. This has practical limitations.

The procedure of measuring absolute velocity is as follows:

1. First align the source detector line (SD) to be orthogonal to the absolute velocity vector. This means that the line SD should be on a plane orthogonal to the absolute velocity vector. How can we find this plane ? We use trial and error method. Rotation of the line SD in this plane will result in constant voltage output of the photo detector because the angle α will be constant in this plane; the bending of the light ray is constant. Rotation of the line SD in all other planes will result in variation of angle α , which will result in variation/ fluctuation of voltage of the photo sensor, as line SD is rotated in that plane. Another method is as follows. First the laser and the photo detector are nominally aligned for optimum light intensity falling on the photo detector. Then the orientation of the rod (line SD) in space is varied. As the orientation of the rod is changed in space, the amount of light falling on the photo detector varies, due to bending of the light rays by different extents depending on the orientation of the rod relative to the direction of the absolute velocity.. The reading of the photo detector is recorded for all directions (orientations). The direction in which the photo detector detects maximum amount of light is parallel or anti-parallel to Earth's absolute velocity vector.

2. Once the line SD is orthogonal to the absolute velocity vector, read the voltage output of the photo detector and try to determine the angle α analytically, from which absolute velocity is determined.

With this experiment, it is possible to determine the direction and magnitude of Earth's absolute velocity, hence confirm the validity of absolute motion.

In the experimental set up explained above, we assumed an isotropic source. Next we consider a practical case of non-isotropic source. By using a highly directional light beam, a laser beam, with the experimental set up described above, the sensitivity of the apparatus to absolute velocity can be significantly increased.

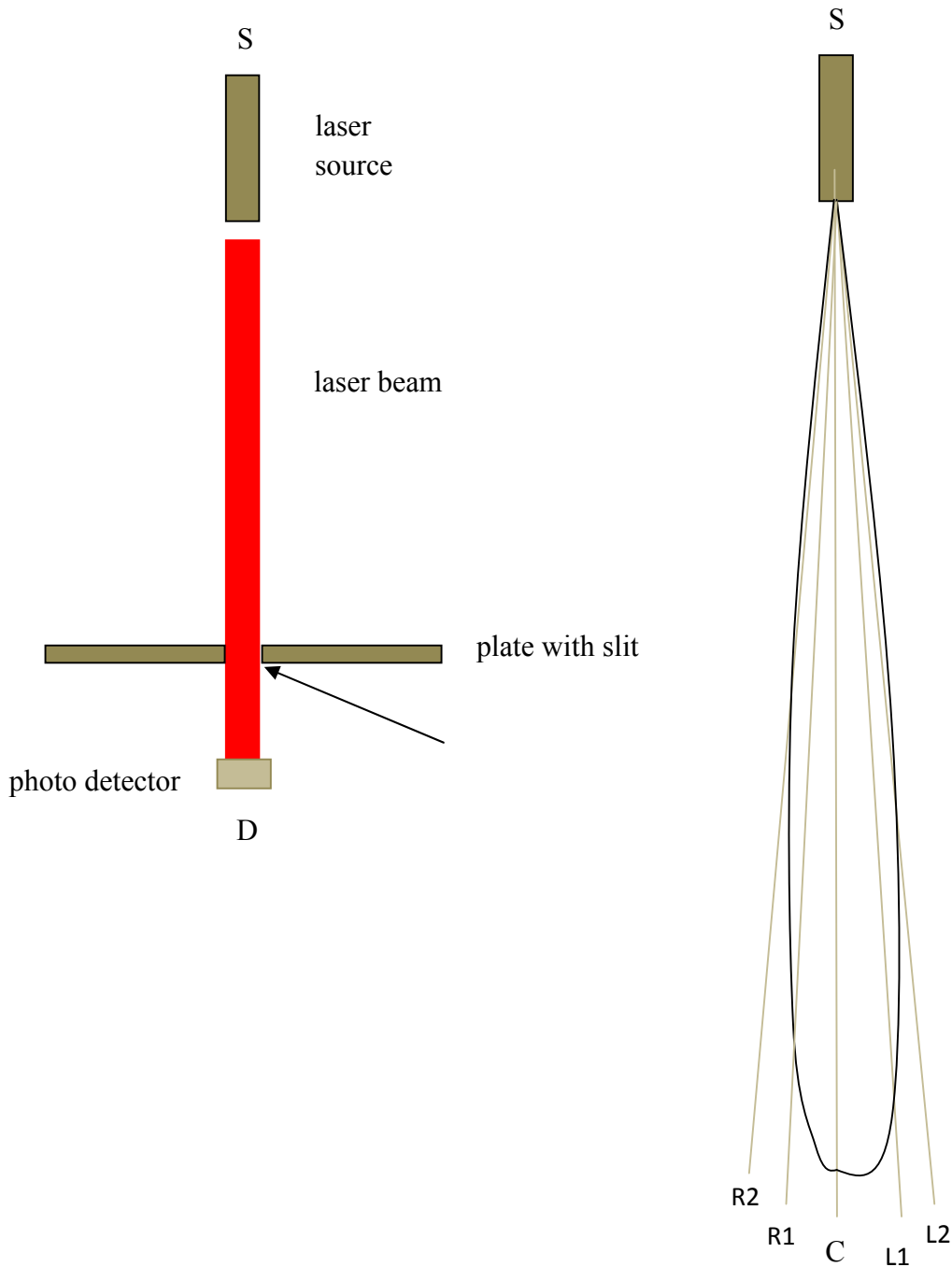

At first assume that there is no plate between the laser source and the photo detector. If the apparatus is at absolute rest and if the laser beam is aligned to the photo detector for maximum light intensity falling on the photo detector. The light ray going to the photo detector in this case will be ray C. Next assume that the apparatus is moving with absolute velocity to the right, without changing the alignment of the laser beam. In this case it will be light ray R1 that will go to the detector and not light ray C, even if we didn't change the alignment of the laser.

The curved light ray (red curved line) is designated as R1' . R1 is tangent to R1' at the source.

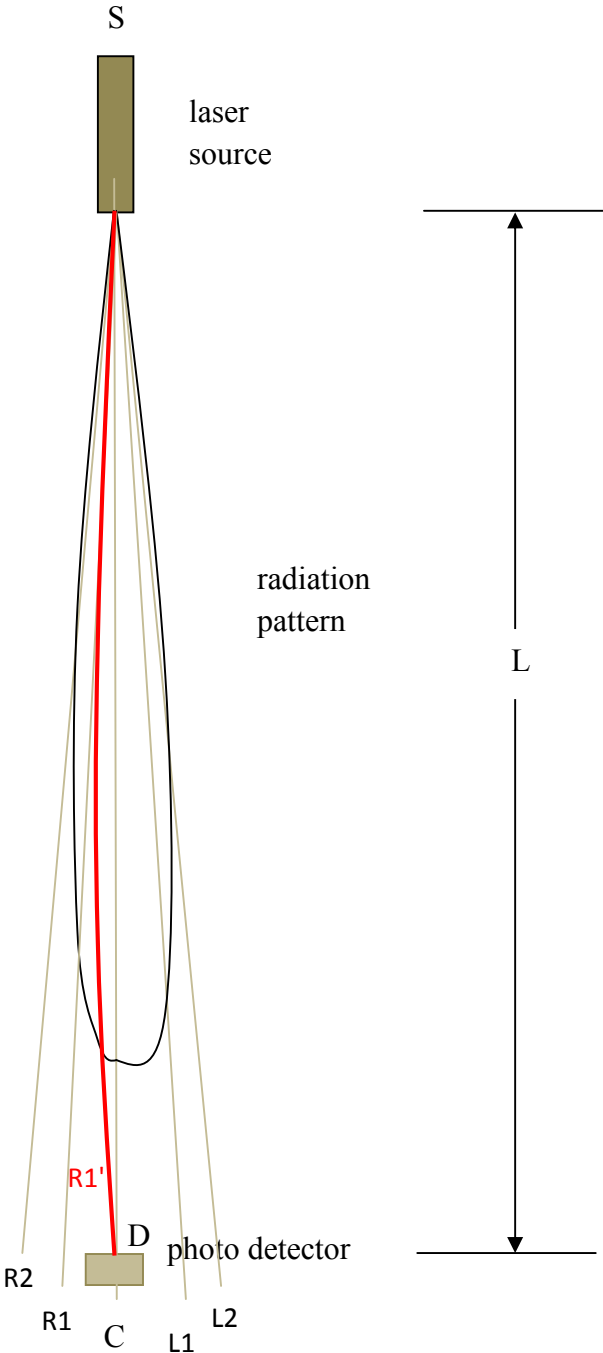

In this case, since the intensity of ray R1 (R1') is less than intensity of ray C, then we detect a change in intensity at the detector due to absolute velocity.
 If we place a plate with slit between the laser source and the detector, as before, the sensitivity of the device will increase further.

Unlike the previous case of an isotropic source, the calibration in this case is feasible. To do the calibration, we first align the source detector line SD with the absolute velocity of the Earth, since we want to measure the Earth's absolute velocity. We do this because, if the line SD is aligned to be parallel with the Earth's absolute velocity, light ray from the source to the detector will not be bent and will always be straight. We have already explained how to find the direction of Earth's absolute velocity. The direction of Earth's absolute velocity is easily found by rotating the line SD (the apparatus) in different planes until we get a steady voltage at the output of the photo detector. The photo detector output voltage will be constant only when the device is rotated in a plane perpendicular to Earth's absolute velocity. Once we have found the direction of Earth's absolute velocity, we align the apparatus (line SD) to be parallel with the Earth's absolute velocity. We start by aligning ray C, which has maximum intensity, with the slit and the photo detector and record the voltage of the photo detector. Then we rotate the laser source to different degrees, with the line SD always parallel to Earth's absolute velocity, and record the voltage of the photo detector for each angle. For a resolution of 3 Km / s , we need an angular resolution of 2 arcseconds in rotating the laser source. Once we have completed the calibration table, we are ready to measure the Earth's absolute velocity. For this, we align the source detector line SD to be orthogonal to the absolute velocity. We then measure the voltage of the photo detector. From the calibration table, we read the angle α corresponding to that voltage and determine Earth's absolute velocity from:

$$\sin\alpha = \frac{V_{abs}}{c}$$

Practically, however, we are interested in Earth's absolute velocity, which is much less than the speed of light, and the required directionality of the laser beam is too high to be practical. Even a beam width of one degree will require very large distance L between source and detector. The use of the slit is therefore necessary.

A more feasible calibration method is to rotate the plate and photo detector assembly, as explained already.

I conceived this experiment several months ago after I fully understood the physical meaning of Apparent Source Theory (AST), which is bending of light rays and variable velocity of light relative to the source. It took me quite a long time to figure out the physical meaning of AST. I long thought about the possibility of bending of light rays as a physical meaning to the theory but was unable to understand it clearly and completely, so I was in doubt about its reality (bending of light rays). I had a hard time to figure it out clearly because the physical meaning of AST is quite hard to understand. On top of that, bending of light rays seemed to be an extraordinary claim. Even with such a vague understanding, I decided to do the above experiment. However, I was unable to acquire the components needed for the experiment in time and just continued to develop the theory.

In the mean time, I came across a paper [17] on the internet in which the author claimed to have observed bending of a laser beam due to Earth's absolute motion. This created a big motivation for me because I was then sure that bending of light rays is real. The very fact that bending of light rays is proved to be real enabled me to think more clearly to advance the theory and its physical meaning. Before long, I was able to fully understand the physical meaning. Once I understood the physical meaning, I decided to do the experiment. This is a very easy,

cheap yet vital experiment. However, unfortunately, again I had difficulty to the components needed to do this experiment. It is not easy to make foreign purchases from my area. At last I decided just to publish the experiment as a proposal. At the same time I am trying to get the components and will hopefully do this experiment in the near future, with an accuracy just enough to confirm the Apparent Source Theory. A laser pointer and a photo detector would suffice.

10. Absolute velocity is mass weighed resultant velocity of an object relative to all massive objects in the universe.

The problem of moving charges; the Trouton-Noble paradox

Now we consider the long standing problem of moving charges. We consider this problem at this point of this paper because of its profound implications to the understanding of absolute motion. In the discussions so far, we applied the new model or interpretation of absolute motion and the speed of light (AST), without being concerned by what absolute motion fundamentally is, i.e. the 'relative to what' puzzle.

One of the experiments being cited as evidence of Special Relativity is the Trouton-Noble experiment.

However, a little thought reveals that the theory of relativity faces an insurmountable problem to explain the Trouton-Noble experiment, whether torque (rotation) is observed or not. This is a well known problem: the Trouton-Noble paradox.

Contrary to the Trouton-Noble experiment, there is another experiment [11] in which the authors claimed to have detected a torque. Even in the Trouton-Noble experiment, the result was not null but much less than the expected. This is similar to the Michelson-Morley result that was interpreted as null when actually a small fringe was detected.

Assume that the Trouton-Noble experiment is sensitive enough to detect any possible absolute velocity. If no torque develops on the charge system, as apparently confirmed in the original experiment, then this is a real problem for relativity, not a supporting evidence. The problem is that, how can an observer moving relative to the Earth predict or explain a zero torque? This is a problem because, a torque should develop in a reference frame moving relative to the Earth, according to the classical laws of magnetism, because the charges are moving in that reference frame. Will there be torque (rotation) or not? ! Since rotation is a phenomena on which all observers agree, there is no chance at all for the proponents of relativity in this case. This paradox is even harder than the Twin Paradox of Special Relativity.

It is strange how the mainstream scientific community has tolerated this paradox.

The consideration of the problem of moving charges led me to a deeper investigation of the meaning of absolute motion.

The solution to this century old problem may lie within quantum mechanics: *the observer effect*.

Imagine a charge moving with a velocity V relative to an observer. From classical physics, the observer will experience the magnetic field of the moving charge. If the charge is moving relative to another observer with a different velocity U , then that observer also will measure a different magnitude of magnetic field. An observer in the reference frame of the moving charge

will not detect any magnetic field. So far there seems to be no problem .

A problem stands out when we consider the Trouton- Noble (T-N) experiment. Consider the Trouton-Noble experimental apparatus in different reference frames. In the reference frame in which the charges (the capacitor) is at rest, zero torque is predicted. The torque predicted is different for all different frames. So an observer moving relative to the Earth, for example an observer in the Sun's reference frame, will predict a non-zero torque. There are only two possibilities: either there will be a torque or not. The capacitor will turn or not. All observers agree on the rotation or non-rotation of the capacitor. Now, will the capacitor turn or not? Which observer will 'decide' on the observable quantity: rotation ? This paradox is a deadly blow to the theory of relativity.

Pursuing the above reasoning, I came across a possible solution to the problem. The above paradox leads us to the inescapable conclusion that *the observer affects the result of an experiment*. This seems to be no new assertion, but is a new application of quantum mechanics in solving the problems of absolute/relative motion and the speed of light.

The observable quantity in the Trouton-Noble experiment, which is rotation (angular velocity or angular acceleration), is the resultant effect of all observers. All observers contribute to the torque developed in the device. It is intuitive to assume that not all observers have equal influence on the torque. I propose that the fundamental characteristic of an 'observer' that is important is the mass of the observer. In this sense any massive body is an 'observer'. The more massive an observer (an object) is the more influence it will have on the Trouton-Noble experiment. This means that if the Trouton-Noble device has different velocities relative to two objects, for example the Sun and a space craft, it is the velocity of the T-N device relative to the sun that almost completely determines the torque. The velocity of the T-N device relative to the space craft has negligible effect on the torque.

Trouton and Noble did not observe the expected rotation of the capacitor. This result is very difficult to explain because, even if the T-N device is at rest relative to the Earth, it is in motion relative to the Sun (30 Km/s) which is much more massive than the Earth, and relative to billions of stars in the universe (390 Km/s).

Therefore, it is not clear why absolute motion was detected with the Silvertooth, the Marinov , the Ronald de Witte and the Miller experiments, but was not detected by the Trouton-Noble experiment. Perhaps the T-N experiment was not sensitive enough or was flawed. But another experiment [11] was reported in which the authors claimed detection of torque. In that experiment, the capacitor was not shielded, unlike the other T-N experiments.

Even if I have asserted that the fundamental quantity defining an observer is its mass, much remains to be clarified regarding such a hypothesis. *How* does the mass of an object physically affect an experiment, i.e. with what mechanism? Does shielding the capacitor prevent the charges from being 'observed' by celestial objects in the universe ? e.t.c.

Absolute motion as motion relative to by massive cosmic objects.

Absolute motion has been detected by many experiments, such as the Miller, Silvertooth, Marinov, Ronald de Witte experiments. The failure of conventional and modern Michelson-Morley experiments to detect the (expected) fringe shift is due to a serious flaw of the experiments. Those experiments were designed to detect the ether, and were successful in disproving the ether hypothesis. However, they were flawed to detect absolute motion. Absolute motion and motion relative to the ether were always (wrongly) perceived to be the same.

Now the question is: if the ether does not exist, relative to what is absolute motion defined? I propose that *absolute velocity of a body is the vector sum of the mass weighed velocities of the body relative to all matter (massive objects) in the universe.*

Imagine a hypothetical universe in which only three bodies exist, A, B and C, for simplicity.

A and B are massive celestial objects (see next figure), with relative velocity V_{BA} . O is an object whose absolute velocity is to be determined, with Michelson-Morley device attached to it, with velocity V_{OA} relative to A and with velocity V_{OB} relative to B.

The determination of absolute velocity of body O is proposed as follows.

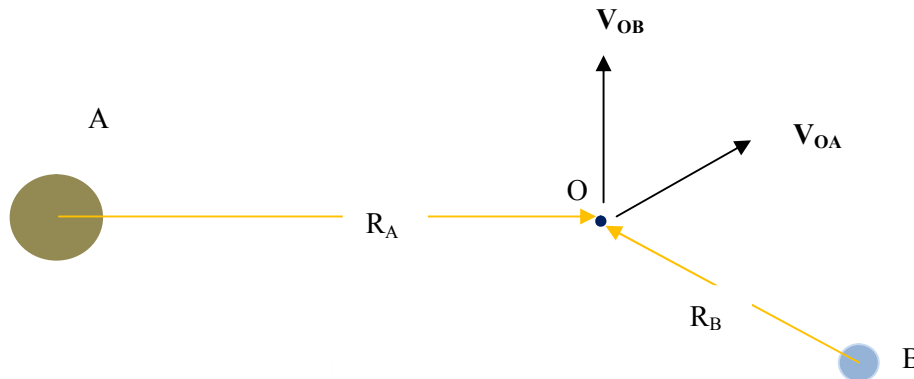

$$V_{abs} = \frac{M_A}{M_T} V_{OA} + \frac{M_B}{M_T} V_{OB} \quad (\text{vector sum})$$

where M_T is the total mass in the universe.

$$M_T = M_A + M_B + M_O$$

The more massive an object the more influence it has in determining the absolute velocity of another body .

Therefore, the absolute velocity (378 Km/s) of the Earth as detected in the Silvertooth

experiment is theoretically the resultant sum of weighed velocities of the Earth relative to all celestial bodies (all matter) in the universe.

The implication of this hypothesis is that distance from the massive objects is irrelevant in the determination of absolute velocity. For example, Galilean space is usually approximated by a region of space far enough away from all matter in the universe. In the above formula, however, distance of object O from celestial bodies A and B, does not appear to have any effect on absolute velocity.

This theory may solve the centuries old perplexing paradox: Relative to what is the absolute velocity of a body determined?

The proposed answer: Relative to all matter (cosmic massive objects) in the universe.

Galilean space

From our discussion so far, Galilean space doesn't exist physically. We have used Galilean space only as a mathematical abstraction in solving problems of absolute motion. The procedure to solve a problem of the speed of light, with a source and observer in absolute motion is:

1. Replace the (real) source with an apparent source to account for absolute motion
2. Solve the problem by assuming Galilean space and by applying modified emission theory for group velocity. The phase velocity is always c independent of source and observer velocities.

In Galilean space, the group velocity of light is constant relative to the source, i.e. varies with source, observer and mirror velocity; the phase velocity is always constant c .

Galilean space exists only as a mathematical abstraction.

11. Absolute motion and electromagnetism, the speed of light

The problem of whether electrostatic force is instantaneous or is propagated at the speed of light is a long standing one. According to Coulomb's law, electrostatic fields are instantaneous; there is no aberration of the field from a moving charge. According to Special Relativity (SRT) and Quantum Electrodynamics (QED) electrostatic force propagates at the speed of light.

A new theory of electrostatic fields is proposed as follows. Consider absolutely co-moving charges Q and an observer O .

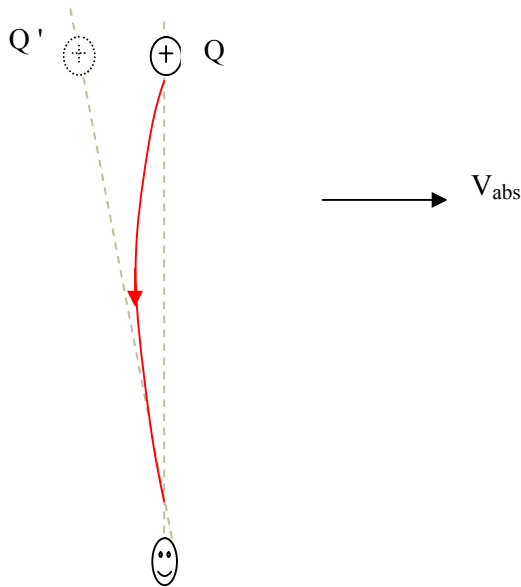

For absolutely co-moving charge and observer, with the absolute velocity vector orthogonal to the line connecting the charge and the observer, the line of force will be bent, creating an apparent change of position of the charge, as shown above.

But what is the speed of propagation of electrostatic fields?

Consider a charge Q and an observer O both at absolute rest. In this case, the lines of force go straight from the charge to the observer.

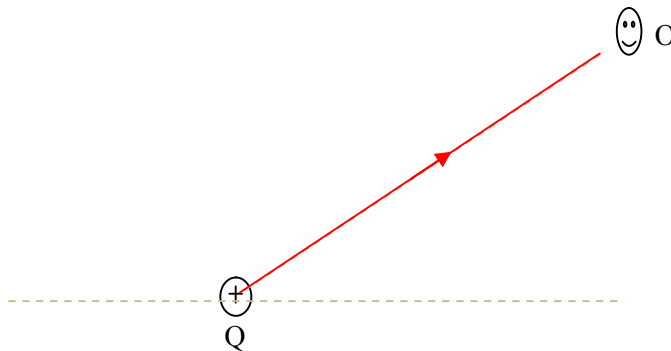

Now assume that the charge Q suddenly accelerates forward, as shown.

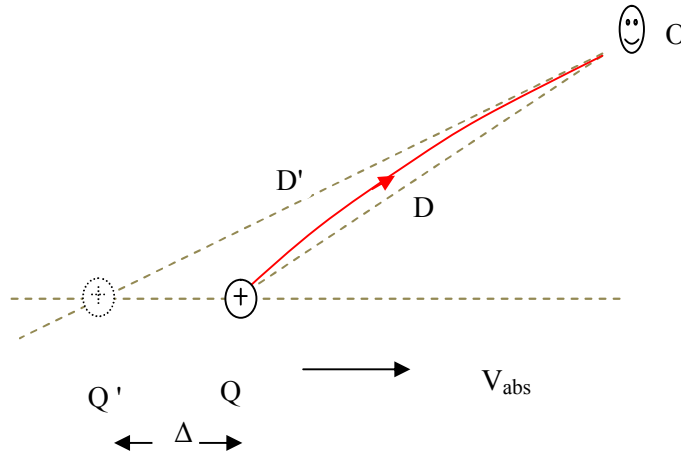

The question is: will the observer detect the change in state of motion of the charge with a delay of the speed of light or instantaneously?

It is proposed in this paper that the observer detects a change in state of motion or a change in position of the charge instantaneously, but the light ray will be bent, creating an apparent change in the position of the charge, creating an *apparent* light speed propagation at the same time.

The apparent change in position of a light source depends on the speed of light. In this case, it is *as if* the electrostatic field is 'propagated' at the speed of light. But there is no propagation.

$$\frac{D'}{c} = \frac{\Delta}{V_{abs}} = \frac{|\mathbf{D}' - \mathbf{D}|}{c}$$

where **D** and **D'** are written in bold denote vector quantities.

The above notation *seems* to mean that during the time that the field 'propagates' from position Q' to observer O, the charge moves from position Q' to position Q. This is only apparent, however. There is no propagation of static fields. It is as if the field is rigidly carried by the charge. This is what was experimentally discovered by Calcaterra et al [4].

To summarize the above: static field is (nearly) instantaneous, but the lines of force are bent due to absolute velocity. The lines of force are straight only if the charge is at absolute rest.

The next figure shows the electric lines of force of a charge in absolute motion.

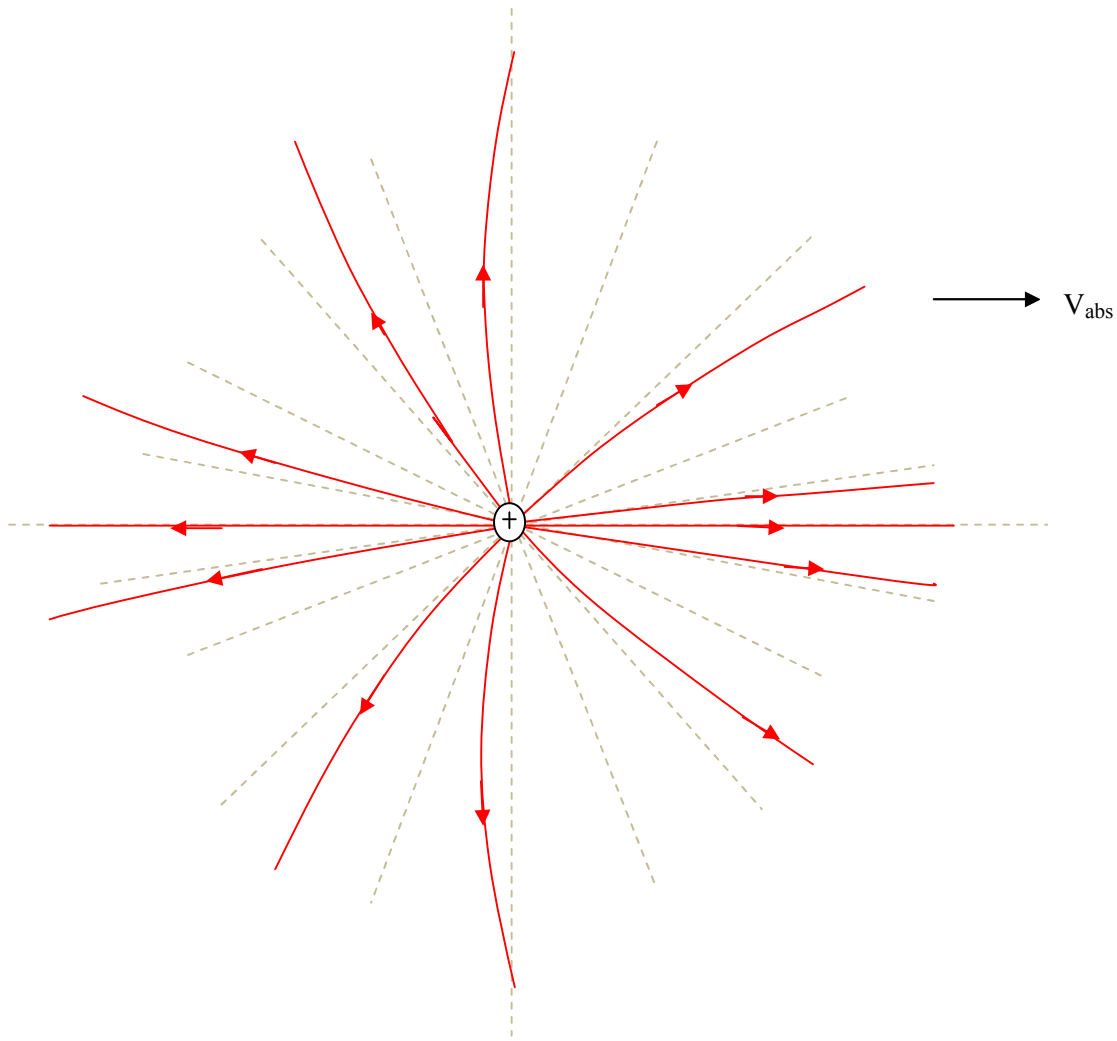

From the above figure, we see that bending of the lines of force is maximum in lateral directions, at or near the ninety degrees (orthogonal) directions. In the forward and backward directions (0° and 180°), there is no bending of the light rays. In directions close to these directions, for example 2° or 178° , there is a very slight bending only. In these directions, the lines of force or the equi-potential lines will get compressed or expanded, respectively. The bending light rays move rigidly with the charge. Change in absolute velocity of the charges changes the bending of the light rays.

Coulomb's law and Biot-Savart's law

One of the findings in this paper is that the absolute velocity of a source has physical consequences: bending, expansion or compression of light rays, of lines of force. By 'source' we mean a light source, a source of static electric field (charge), a source of magnetic field (a moving charge, a current carrying conductor or a permanent magnet), or a source of gravitational field. The motion of an observer is never equivalent to the motion of the source,

except with regard to Doppler effect of light, which depends only on the relative velocity of source and observer.

If a charge is at absolute rest, the lines of force emanating from the charge are purely radial and straight. The motion of the observer relative to the charge doesn't change anything and Coulomb's and Newton's laws apply as they are. When the *source* is in absolute motion, however the light rays or the lines of force will be bent in the lateral directions, creating aberration, even for co-moving source and observer.

Electromagnetic radiation

Another long standing problem is the problem of electromagnetic radiation. Conventionally, it is said that electromagnetic radiation is produced by accelerating charges. But the physical process involved is not known clearly.

This paper reveals the mystery of electromagnetic radiation.

Consider an accelerating or oscillating charge. Let us see what an observer *in the reference frame of the charge* observes.

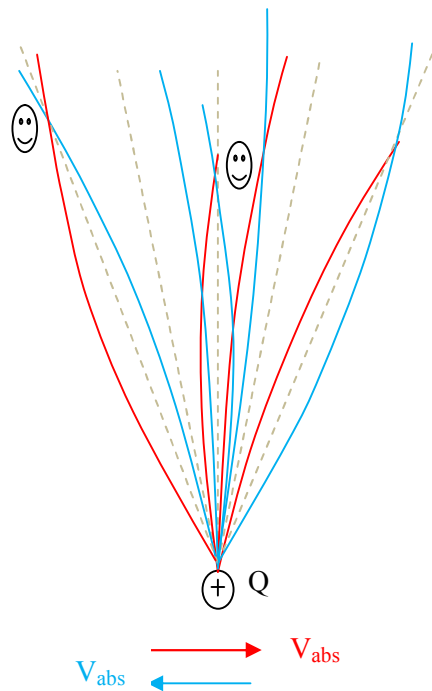

Since the lines of force are bending relative to the charge due to absolute motion, the lines of force will have *transverse* component. As the charge oscillates left and right, the observer in the reference frame of the charge observes that there is a time varying *transverse* component of the electric field, changing directions and magnitudes as the charge accelerates to the right and to the left. The time varying transverse component of the electric field causes electromagnetic

radiation. We can see that maximum radiation occurs in the lateral directions, with no radiation in the longitudinal directions. This means that *change in absolute motion* is the cause of electromagnetic radiation.

12. Non linear law of electromagnetic radiation power and radiation reaction - Universal speed limit c

In my previous paper [13], with the theories

' Apparent Source Theory '

' Constant Phase Velocity and Variable Group Velocity of Light ' and

' Exponential Law of Light '

, I was able to explain many conventional light speed experiments and the Ives-Stilwell experiment.

Despite the success of the above theories, however, there were a category of experiments which remained very tough to explain. These were the muon 'time dilation', the limiting light speed experiments and the 'mass increase' of relativistic electrons. The speed of electrons and beta particles accelerated with a very high voltage have been measured even by time of flight method and were always found to be just less than the speed of light. If Special Relativity is wrong (as confirmed by the much compelling alternative theories listed above), then how is it that SRT is still successful to explain these experiments. This was very challenging.

After a considerable bewilderment, I came to realize that there is some profound mystery of nature yet to be discovered.

Before long, I came across a paper [1] on the internet in which I found a crucial hint on the missing link. In this paper, the author (Musa D. Abdullahi) proposes an alternative explanation to the Bertozzi's experiment. In the Bertozzi's experiment [14], an electron is accelerated with a high voltage and its kinetic energy is measured using calorimetry. It is found out that, as the accelerating voltage is increased further in the range required for relativistic speeds of the electron, the measured heat energy continues to increase, despite the fact that the speed of the electrons is always just under the speed of light, which was confirmed by time of flight method. What sparked my thought are a few statements made by the author in his papers [1] and in an e-mail exchange we had regarding his paper on the Bertozzi's experiment.

' . . . Special relativity . . . gives radiation power $R = \gamma^4 R_p$, where γ is . . . The factor γ^4 means that the radiation power increases explosively as the speed v approaches that of light c . . . '

' . . . Radiation reaction force R_f is missing in classical and relativistic electrodynamics and it makes all the difference. . . '

' So it is not the energy of the electrons which continues to increase but the emitted radiation. This emitted radiation has a heating effect as may be detected by calorimetry.'

' It is as if the electron, under acceleration by an electric field, encounters a kind of 'frictional force' opposing motion, which prevents it from going beyond the speed of light. '

The above statements brought to my attention ' radiation reaction ' and the gamma (γ) term of Special Relativity to consider them as a possible explanation of limiting light speed and relativistic mass increase experiments. So I interpreted these ideas for a new alternative interpretation: 'relativistic' mass increase and light speed as the limiting (maximum possible) *absolute and relative velocity* in the universe. This mean that no absolute or relative velocity equal to greater than the speed of light is possible in the universe.

Now, what is the explanation for the impossibility to accelerate electrons or beta particles to or beyond the speed of light ? As the *absolute* velocity of the (charged) particles approaches the speed of light, any further increase in absolute velocity will increasingly cause or require radiation of infinite amounts of electromagnetic energy, and infinite amount of radiation reaction, so that it would be impossible for these particles to attain the speed of light. In other words, it gets extremely difficult to accelerate and, to a somewhat lesser extent, to decelerate, an electron which is moving with an absolute velocity close to the speed of light. It becomes harder and harder to change (to increase or to decrease) the absolute velocity of an electron which has already attained an absolute velocity close to the speed of light. Near the speed of light, it requires practically infinite amount of energy to *change* the *absolute velocity* of the electron.

So far we have been talking about charged particles, which can radiate electromagnetic energy when accelerated.

In this paper we just adopt the gamma (γ) factor of Special Relativity,

$$\gamma = \frac{1}{\sqrt{1 - \frac{V^2}{c^2}}}$$

So the formula for radiated power should contain the gamma term, so that radiated power becomes infinity at the speed of light.

The formula for radiated power from a charged particle is, according to Special Relativity[1]:

$$R_p = \frac{q^2 a^2}{6\pi\epsilon_0 c^3} \gamma^4 \quad (\text{Lienard formula})$$

The radiated power becomes infinity at the speed of light. We will use this relationship in an argument about universal absolute velocity limit as the speed of light. Note that light speed limit applies only to physical objects, objects with mass, according to this paper.

One long standing problem is that of radiation reaction. The radiation reaction is given by[1]:

$$F_{rad} = \frac{q^2}{6\pi\epsilon_0 c^3} \frac{da}{dt} \quad (\text{Abraham – Lorentz formula})$$

We know that radiation is caused by acceleration. But the above formula implies that there will be no radiation reaction for constant acceleration because the rate of change of acceleration will be zero in this case. The above formula doesn't reflect our hypothesis that radiation reaction will be infinite near the speed of light, i.e. there is no gamma term in the above formula. If this hypothesis is correct, then this implies that Maxwell's equations and their solution should be reconsidered.

Special Relativity also has problems with radiation reaction[1].

Muon 'time-dilation'

Relativistic muons are known to live longer than muons at rest. The standard explanation is 'time dilation' of Special Relativity. But this 'explanation' is counter intuitive.

The new explanation proposed in this paper is that radiation reaction increases towards infinity due to the gamma factor, at 'relativistic' speeds. Disintegration of the muon into its component parts requires acceleration of the constituent parts, which in turn results in radiation. But this relation between acceleration and radiated power is not linear. For a muon moving with *absolute* velocity near the speed of light, even a very small acceleration requires tremendous amount of radiated power, and hence tremendous radiation reaction, as compared to non-relativistic muons. Thus relativistic muons live longer than muons at rest because of mass increase, not because of 'time dilation'. In the preceding section mass has been explained as radiation reaction.

Mass increase of relativistic electrons

The experimentally established increase in mass of relativistic electrons, as compared to non-relativistic electrons, is just an increase of radiation reaction of the electron as its absolute velocity approaches the speed of light. Therefore, this is just an increase in inertia or mass of an electron.

13. Mass (inertia) may be nothing but radiation reaction !

Consider a charge being accelerated by an external force. We know that the charge will radiate electromagnetic energy. From Newton's law we know that a force is required to accelerate an object with mass. As a massive object is pushed, by the principle of action and reaction, there will be a reaction force.

Consider an electron accelerated by an electric field. Conventionally, the electric field has to supply two kinds of energies:

1. kinetic energy to the electron (because electron has mass)
2. energy radiated by the electron

This is conventional knowledge.

The new theory proposed here is that inertia is nothing but radiation reaction. Thus, as an electron is pushed, it will radiate and a back reaction arises. Inertia arises from radiation reaction.

All energy imparted to the electron will be radiated.

The electron radiates not only during acceleration, but also during deceleration. The force needed to stop a moving electron is again radiation reaction. Note that this may not mean that the law of energy conservation is violated, but that we may have to change how we think about it.

Mass (inertia)

Mass increase of relativistic electrons has already been explained above. As the absolute velocity of the electron approaches the speed of light, it requires nearly infinite amount of radiated power to impart any further acceleration to it. This means that there will be practically infinite radiation reaction. This may be nothing but (practically) infinite mass (inertia) of the electron, as proposed above.

What about neutral objects ? Does the limiting speed of light apply only to charged particles or is it *universal*, i.e. does the limiting light speed apply to all physical objects ? The problem with neutral particles or objects here is that there is no experimental evidence in the laboratory.

But one can make a logical speculation that if charged particles can never attain or exceed the speed of light, which is now an experimentally established fact, so should neutral particles, since neutral particles are composed of charged particles anyway. This assertion is reasonable if we think about the consequence of a charged particle moving at the speed of light: *infinite* energy. To assume that the light speed limit doesn't apply to neutral objects when it applies to charged particles of which they are composed makes complications. Thus we conclude that neutral particles also can't attain the speed of light. So the speed of light is a universal *absolute* velocity limit.

The above argument encourages us to make a radical speculation. What if inertia (mass) itself is nothing but radiation reaction ?! I mean that a massive object resists any change in its state of motion because of radiation reaction. i.e. the inertia of an object is due to radiation reaction. One appealing feature of this idea is that both inertia and radiation reaction are reaction forces opposing acceleration. The long standing difficulty in understanding radiation reaction might also be a hint that there is some profound mystery.

The immediate objection to this assertion is that neutral objects cannot radiate even if accelerated because they carry no net charge.

Despite this problem, I persisted to pursue this hypothesis that inertia may be just radiation reaction because this is a very compelling idea with profound implications, if proved to be correct.

I came across a solution to the above stated problem that neutral objects do not radiate. I found

the possible solution to be in quantum mechanics.

The electrons, protons and all charged elementary particles in a macroscopic object all radiate if that object is accelerated. The individual charged particles behave in the same way as when they are free/isolated. An electron bound in a macroscopic object and a free electron are governed by the same law: an accelerated electron radiates. If the free electron and the neutral object containing the bound electron have equal accelerations, then the two electrons will have equal radiated power and equal radiation reaction. An electron bound in a neutral object does not stop to radiate simply because there are positively charged particles in that object that will also radiate.

However, the radiated power of the bound electrons will never be accessible because it is cancelled by the power radiated from the positive bound charges. However, 'canceled' doesn't mean that the energy disappears, which would violate the principle of energy conservation. The radiated energies of negatively and positively charged particles inside a neutral object simply become *inaccessible*. Whether the radiated power is accessible (as for a free accelerated electron) or inaccessible (as for an electron bound in a neutral accelerated object), there will always be radiation reaction and that may be the same thing as what has been known as 'inertia' for centuries.

The following argument shows that this may not be an extraordinary claim .

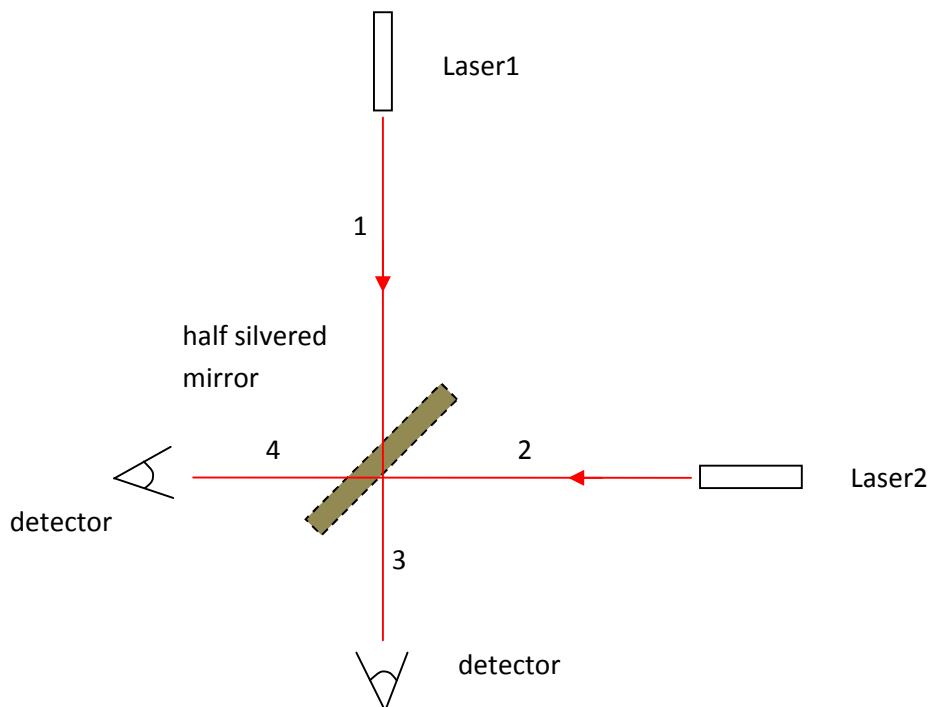

Consider the lasers to be ideal : their coherence time is infinite , and both have exactly the same frequencies and intensities, the arm lengths are exactly equal.

First the phases of the two lasers are adjusted so that the two light beams interfere with complete destructive interference at the detectors. Detectors placed on paths 1 and 2 (not shown) will detect light, but a detector placed anywhere along paths 3 and 4 will not detect any light. Now, the puzzle is: where does the energy go? Detectors placed on paths 3 and 4 will detect light only if one of the two lasers is switched off.

The above argument shows that photons may be emitted yet not accessible. A photon does not 'mix' with other photons. Two photons may simultaneously act on the same particle, but the two photons will not be 'lost' due to 'mixing' with other photons. Similar argument applies to the radiation from bound charged particles of a neutral object. Since everyday accelerations of macroscopic objects is of very low frequency, the cancelling of two photons will be even more complete.

Therefore, a neutral object reacts to any acceleration because of the same phenomenon that a free electron reacts to any acceleration: radiation reaction.

Therefore, universal light speed limit will also apply to neutral particles and objects. The radiation reaction of an electron inside a neutral macroscopic object moving at absolute velocity close to the speed of light is the same as the radiation reaction of a free electron moving at the same absolute velocity. This means that if the free or the bound electrons are accelerated while moving with absolute velocities close to the speed of light, both the free electron and the object containing the bound electron having equal absolute velocity and accelerations, the radiated power and the radiation reaction on the two electrons is also equal.

14. Other evidences related to relativity

14.1. Mossbauer rotor experiment

Another experiment cited as evidence for relativity is the Mossbauer rotor experiment performed by Kundig.

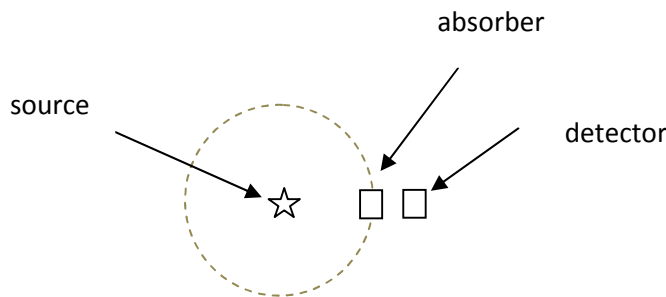

The observed change in resonance in this experiment, if any, may be due to a change in mass caused by absolute velocity, which may also have effect at the atomic level, changing energy levels in atoms.

14.2. 'Time-dilation'

'Time-dilation' is the most challenging aspect of SRT to find an alternative explanation or to refute because SRT claims to predict it. The difficulty is not in disproving SRT, 'time-dilation' cannot logically be a reciprocal phenomenon as required by SRT itself. 'Time-dilation' is known to be only an illusion having nothing to do with the physical world. The Twin-Paradox exposes this. The challenge is to find an alternative explanation of the experiments.

This paper has disproved Special Relativity (SRT) by proposing a very compelling interpretation and explanation of the experiments on which SRT is based, such as the Michelson-Morley experiment. What makes challenging relativity an apparently insurmountable task is the many claims that SRT is confirmed 'with an accuracy of 1% , one part in a billion' etc. How can a wrong theory be confirmed to such a level? Actually, such claims are more about 'time dilation'.

Kinematic and gravitational 'time-dilation' are claimed to have been confirmed by the Hafele-Keating, GPS correction, muon 'time-dilation' experiments. It is even harder to find an alternative explanation when the credibility of these experiments is controversial. Hafele and Keating, for example, are said to have manipulated the raw data to fit with the predictions of relativity. GPS clock rate correction is also disputed. The velocity of muons are calculated from their energy by using relativistic formula, and this is circular logic. The difficulty will be two fold as these effects cannot be explained classically.

In this paper there is no 'time-dilation' as claimed in Special Relativity. However, some aspects of Special Relativity have been adopted and given new interpretation in this paper. These are the increase in mass with absolute velocity and the universal speed limit. Therefore, this should have implications at the atomic level. For example, what is the implication of this on the energy levels in an atom ? Therefore, absolute velocity may affect the frequency of radiations from atoms. If there is any observed change in the rate of atomic clocks, as claimed in, for example the Hafele Keating experiment, it is due to the absolute velocity of the atom, resulting in change of mass of the electrons and energy levels.

14.3. A hypothetical clock

According to the theoretical framework in this paper, there is no kinematic and gravitational time dilation of atomic clocks, as claimed in SRT. However, I will describe a hypothetical clock whose rate will depend on its absolute velocity, just to clarify the new theory.

Consider a clock working on the following principle, in absolute space. Two pulsed light sources S1 and S2, separated by distance D and two detectors located at the two sources so that the two light sources and the two detectors form a transponder system, all co-moving absolutely.

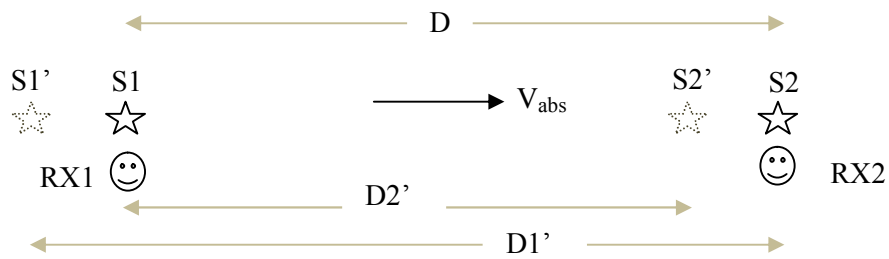

The operation of the clock is as follows: S1 emits a light pulse, then the detector RX2 detects the pulse, S2 transponds with another light pulse without delay, the detector RX1 detects the light pulse and S1 transponds without delay and so on. An electronic pulse counter can count the number of transmissions and hence a clock.

The round trip time depends on absolute velocity as shown below:

$$\frac{D2'}{c} + \frac{D1'}{c} = D \frac{c}{c + V_{abs}} \frac{1}{c} + D \frac{c}{c - V_{abs}} \frac{1}{c}$$

$$= D \frac{2c}{c^2 - V_{abs}^2}$$

It can be shown in a similar way that for absolute velocity directed perpendicular to the line connecting the two transponders.

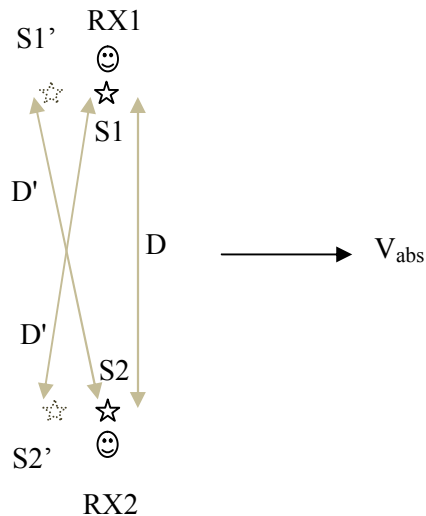

$$\text{Round trip time} = \frac{2D'}{c} = \frac{2D}{\sqrt{c^2 - V_{abs}^2}}$$

We see that the round trip time and hence the clock rate is affected by absolute velocity. The higher the absolute velocity, the slower the clock. Only the rate of the clock slows down ; there is no 'time dilation'.

Note that the hypothetical clock is made from transponder system. To make the distinction clear, let us consider another kind of clock, which is made of a pulsed light source, a light detector (receiver) and a mirror.

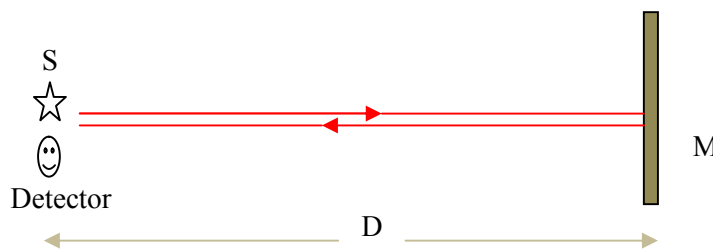

The pulsed light source S and the light detector are very close to each other, so they can be assumed to be at the same point in space. The clock operates as follows. The source S emits a short light pulse, which is reflected from the mirror M back to the detector. Upon detecting the reflected light pulse, the detector actuates the source to emit a light pulse again, which is reflected back to the detector and so on. The rate of such clock is independent of absolute velocity because the round trip time is always equal to $2D/c$.

These examples are only about kinematic 'time-dilation'.

What about real atomic clocks? Electronic clocks? The hypothetical clock is made of a transponder system. How can slowing down of atomic clocks be explained? . We have clearly seen that our hypothetical clock, that uses time of flight method, is affected by absolute motion.

In the above discussion I just tried to show that it is possible to build a clock whose rate is affected by absolute motion. But I can't figure out how an atomic clock slows down due to absolute or relative motion (kinematic time dilation). The Hafele-Keating experiment and GPS correction are controversial and many authors, such as A.G Kelly, consider these as a fraud.

Conclusion: Within the new theoretical framework proposed in this paper, there is no prediction or explanation for gravitational and kinematic 'time dilation' of atomic clocks , as claimed in Special Relativity. But the effect of change in mass with absolute velocity, as proposed in this paper, may have to be considered at the atomic level. This paper doesn't predict or explain gravitational 'time-dilation'.

14.4. Star light bending near the sun

The bending of star light near the sun is currently considered to be due to the mass of the sun, according to General Relativity. An alternative explanation [7] has been proposed for the bending of light near massive objects. It is proposed that the effect is not due to the mass of the sun, but due to its size.

It may be tempting to speculate that vacuum permittivity and permeability is affected by massive objects, in their vicinity, to explain the bending of star light near the Sun. I propose that vacuum permittivity and permeability, hence the speed of light, is not affected by massive objects and is constant throughout the universe.

I propose that the Rosa and Dorsey experiment (1907) be repeated at different distances from the Earth to see if there is any effect on vacuum permittivity and permeability.

14.5. Fizeau experiment

The problem of the speed of light in *vacuum* has been a great puzzle during the last century, let alone the speed of light in material *media*. Logically the vacuum speed of light should be understood before trying to understand the speed of light in material media. That is why this paper is concerned with the behavior of the speed of light in vacuum.

An alternative explanation for the Fizeau experiment has been proposed by Renshaw [16], showing how Doppler effect creates an apparent partial dragging of light by the moving water. Renshaw has derived Fresnel's formula without assuming the ether. Even though Renshaw has proposed a very useful method to explain the Fizeau experiment, his approach also has fundamental problems, according to this paper. For example, he assumes that only frequency, and not wavelength, changes for source observer relative motion. The assertion that both frequency and wavelength change for source observer relative motion has been proposed in this and my previous papers, for the first time. He doesn't also make the kind of distinction revealed in this paper between phase velocity and group velocity of light, just as all other classical approaches. Renshaw's approach may be used to derive the Fresnel formula, within the theoretical framework proposed in this paper. However, I will not attempt to do that in the current version of this paper. The most important thing about Renshaw's analysis is that alternative explanations exist to the Fizeau experiment, without resorting to Special Relativity or ether theory.

15. Gravity; perihelion advance

15.1. Evidence that the speed of gravity is not infinite and is equal to the speed of light.

Tom Van Flandern argued that [5] planetary orbits would be unstable if the speed of gravity is finite, and he set a lower limit of $2 \times 10^{10} c$ on the speed of gravity. In this paper, however, finite speed of gravity is proposed because it may explain Mercury perihelion advance. It will also be shown that the speed of gravity need not be infinite (as argued by Van Flandern) and that it is possible to explain stable planetary orbits and observations during solar eclipse by using finite speed of gravity and it will be shown that the 'speed' of gravity is in fact equal to the speed of light.

In this section we apply the Apparent Source Theory to gravity to explain gravitational phenomena. It is found that observations show light speed 'propagation' of gravity, not instantaneous propagation. Even though we show that the 'speed' of gravity is equal to the speed of light, actually there is no propagation, but there is aberration of gravity. Just like electrostatic fields, gravity behaves both as if it is instantaneous and as if it propagates with light speed.

Let us assume that the sun-planet system (the bary-center) to be at absolute rest, with the planet revolving the Sun.

The usual fallacy is to think of the sun and the planet to be on opposite sides of a single bary-center, which would imply unstable orbit for finite speed of gravity because of a non central force component. This fallacy is rooted in a hidden assumption of the ether. This hidden assumption of the ether is the source of most confusions surrounding absolute/relative motion and the speed of light. Even Einstein did not actually escape from the ether trap as he implicitly assumed the ether in Special Relativity.

In the next figure, two bary-centers, O_S and O_P , are shown. O_S is the bary-center for the Sun and the *apparent* Jupiter, and O_P is the bary-center for Jupiter and the *apparent* Sun. We see that the real Sun and the real Jupiter are never on opposite sides of a single bary-center.

The above explanation is not ultimately accurate, though. With a little thought we can see that *the orbits* of the Sun and Jupiter revolve around a single common bary-center (right figure). Therefore, it is not the Sun and the Jupiter themselves, but the *centers* of their respective *orbits*, that should be thought as revolving around the common bary-center. O_S and O_P (shown in the figure) are just the instantaneous bary-centers. The figure on the right shows a more accurate representation. The red dashed circle is the locus of the Sun-apparent Jupiter bary-center, and the green dashed circle is the locus of Jupiter-apparent Sun bary-center. These two bary-centers themselves revolve around the bary-center of the system. Note that the orbits shown are the 'instantaneous orbits'. Since the two bary-centers are continuously changing, the planet and the Sun will stay in the orbit shown in the figure only for a moment, i.e. the planet and the Sun move in continuously changing orbits.

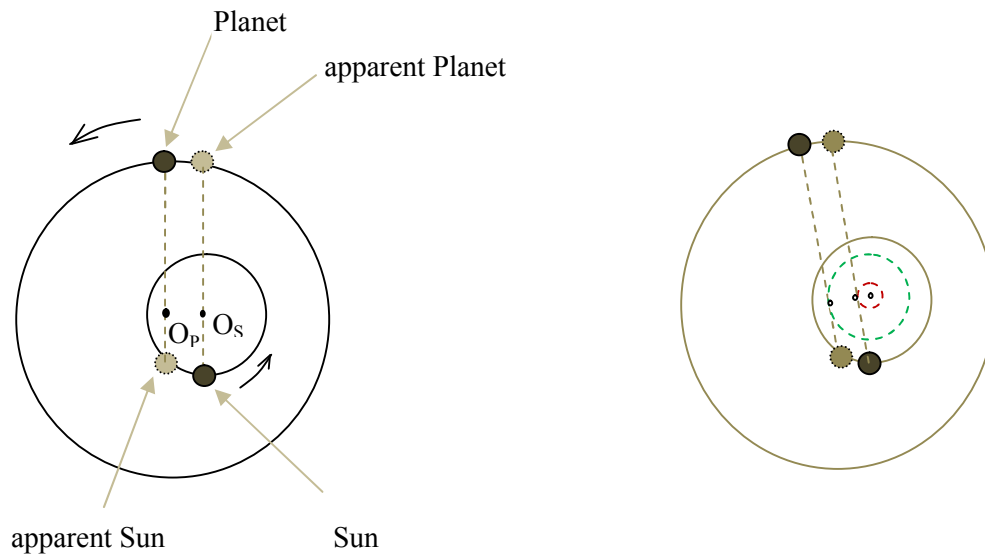

With this scheme, the orbits would be 'complex' but stable, even if we assume a finite speed of gravity. Such a 'complex' orbit may account for the perihelion advance of Mercury and 'elliptic' orbits. We know that Newton's law doesn't predict perihelion advance for one sun - one planet system (Sun-Mercury system). So according to Apparent Source Theory (AST), then there can never be circular orbits in absolute space. There can't be perihelion advance in Galilean space. Pure circular and pure elliptic orbits are possible only in Galilean space. The observed perihelion advance of Mercury may be evidence for absolute motion (and for Apparent Source Theory).

This theory is a fusion of ether theory and emission theory, for gravity.

The explanation provided so far applies to absolute space. In Galilean space, emission theory can simply explain stability of orbits, again without requiring infinite speed of gravity. But Galilean space is only an abstraction that is useful in solving problems of absolute motion and does not exist in reality.

Evidence that the 'speed' of gravity is equal to the speed of light.

The following are quotes taken from Tom Van Flandern's paper [5]

“ ... The earth accelerates towards a point 20 arc seconds in front of the visible sun ... In other words, the acceleration now is towards the true, instantaneous direction of the Sun now, ...”

“ ... Why do total eclipses of the Sun by the Moon reach maximum eclipse 40 seconds before the Sun and Moon's gravitational forces align ? ... “

The new interpretation of absolute motion proposed in this paper turns these observations into evidences showing that gravity 'propagates' at the speed of light. Note that, as explained already, there is only apparent propagation. The effect is as if there was gravity propagation at the speed

of light, but there is no actual propagation in static fields.

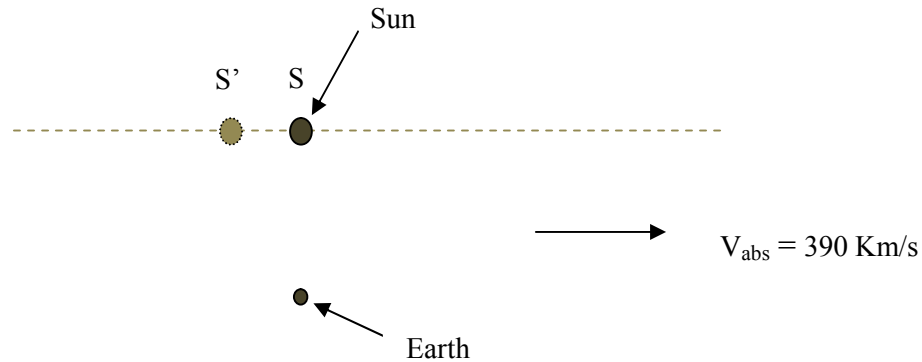

Assume that the Sun and the Earth are co-moving absolutely as shown above, with no relative motion between them. The amount of apparent change of the Sun's position is determined by the absolute velocity (390 km/s), the Earth-Sun distance and the speed of light. The light rays are coming from the direction of the apparent Sun (S').

The angular position of the true, instantaneous position S of the Sun relative to its apparent position S' is determined as follows.

$$\frac{390 \text{ Km}}{2\pi * 300,000 \text{ Km}} * 360 \text{ } 3600 \text{ arcseconds} = 268 \text{ arcseconds}$$

Assume now that we measure the direction of Sun's gravity at the same time and it also pointed towards the apparent Sun (S'). What do we conclude? We conclude that the speed of gravity is equal to the speed of light. If the 'speed' of gravity was infinite, the Sun's gravity would be towards S.

In the above argument, we assumed that the Earth is not moving relative to the Sun. Now we consider the Earth's motion relative to the Sun (30 km/s).

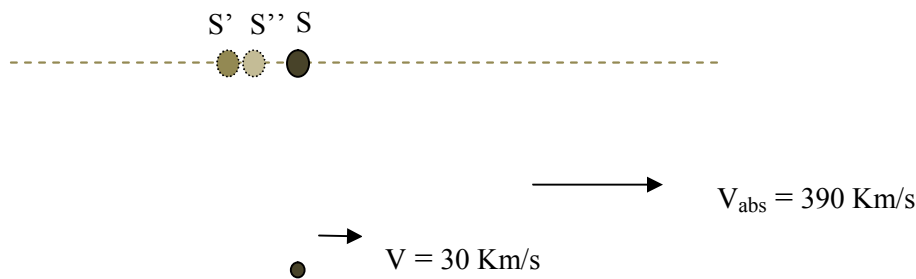

The sun will now appear to be at position S'' (20 arcseconds ahead of S'), due to earth's *relative*

motion. However, this does not mean that the light rays are coming from the direction of S''; it is only an illusion. The light rays still come from the direction S'. It appears to a person running in the rain as if the rain droplets are falling at an angle. We know that this is only an illusion. This is Bradley aberration.

The mistake in Van Flandern's argument is that he considered point S' to be the true, instantaneous position of the Sun. Such mistake is committed in all arguments based on the principle of relativity, which denies the absolute motion of the solar system in space (390 Km/s). The true instantaneous position of the Sun is at S, 268 arcseconds ahead of S'. We consider this also to be the instantaneous, true position of the sun because the Earth and the Sun have common absolute velocity. Such an interpretation is distinct from the ether or classical absolute space theory. This is an application of the fusion of the ether and emission theories to gravitation.

“ The earth accelerates towards a point 20 arc seconds in front of the visible sun ... In other words, the acceleration now is towards the true, instantaneous direction of the Sun now, ...”

This observation shows that gravity is also directed towards S', showing that the speed of gravity is equal to the speed of light. One may ask : why does gravity also not act towards S'' then ? i.e. why does Bradley aberration not apply to gravity? We have already said that even for light, Bradley aberration is only an illusion caused by relative motion and not real. Bradley aberration is caused by variation of light velocity due to observer source relative motion. In the case of gravity, nothing is propagating and the effect of absolute motion is to create curving lines of force, hence creating aberration.

Thus, if the 'speed' of gravity was different from the speed of light, the Earth would accelerate towards a point different from ' a point 20 arc seconds in front of the visible sun '. This would be 248 arc seconds (i.e. 268 minus 20) behind the visible sun, assuming the Earth's relative velocity and the Solar System's absolute velocity lie in the same plane, for simplicity.

Does a Gravitational Field Continuously Regenerate, or is it “ Frozen” ? (Tom Van Flandern [5])

A confusion may arise when talking about the speed of gravitational and electrostatic fields, because there is no propagation. There are problems with this view, however, as argued by Tom Van Flandern.

“ It seems impossible to conceive of a static field with literally no moving parts as capable to transferring momentm. ...”

“ The propagation speed of the entities carrying momentum give rise to aberration ...”

“ So are gravitational fields for a rigid, stationary source frozen, or continuously regenerated ? Causality seems to require the latter. If such fields are frozen, then what is the mechanism for updating them as the source moves, even linearly ? ...”

The word 'frozen' is not an appropriate word for fields. A more appropriate word is instantaneous 'propagation'.

Changes in the state of *absolute* motion is felt instantaneously at a distant point, but the lines of gravitational force will be bent, creating aberration *as if* the change propagated at the speed of light.

15.2. Electrostatic theory of gravity

The new interpretation of observations and experiments on gravity presented in the last section led me to the striking conclusion that the speed of gravity is equal to the speed of light.

Even after discovering that the speed of gravity is equal to the speed of light, the implication of this didn't happen to me immediately. At a certain moment such a striking 'coincidence' took my attention.

How can the speed of gravity be equal to the speed of light? Aren't gravity and light fundamentally different phenomena ? Isn't gravity a mysterious phenomenon? Can this be mere 'coincidence' ?

I had never considered the possibility that gravity may be an electrostatic or electromagnetic force. Once this view came to my attention, it didn't take me long before coming across a very compelling idea:

Gravity may be due to difference in permittivity for attractive and repulsive forces.

This means that the force of attraction between opposite charges is slightly greater than the force of repulsion between similar charges.

Coulomb's law:

$$F = \epsilon_{att} \frac{Q1 \cdot Q2}{r^2}$$
$$F = \epsilon_{rep} \frac{Q1 \cdot Q2}{r^2}$$

where ϵ_{att} is the permittivity for opposite charges and ϵ_{rep} is for similar charges.

I wondered if anyone else has already made such a proposal and searched the web, and found a paper [12] proposing the same idea, even claiming to have confirmed this hypothesis experimentally. I learned that this idea was also proposed by Michael Faraday.

16. Conclusion

The real nature of the speed of light has remained a mystery ever since the historical Michelson-Morley experiment and Maxwell's discovery of the speed of light. There are numerous and divergent empirical evidences that have accumulated for centuries, defying any natural, intuitive, logical explanation, within a single theoretical framework. All known theories of the speed of light, including Special Relativity, emission theory and ether theory, failed on a number of experiments. Physicists have failed to create a model of the speed of light that can consistently predict or explain the outcome of experiments, let alone understand the fundamental nature of light. There is no theory of light so far that can consistently explain even three of the experiments: the Michelson- Morley experiment, Sagnac effect and Silvertooth experiment. The model of the speed of light proposed in this paper successfully explains many experiments that have remained mutually contradicting and controversial for decades. A few theories and interpretations have been proposed as a single theoretical framework. 1. The *group* velocity of

light is constant relative to the apparent source. The effect of absolute motion of a light source is to create an apparent change of its past position relative to an observer. Physically this means that the group velocity of light varies *relative* to the real source, due to absolute motion and also means bending of light rays in lateral directions. 2. The *phase* velocity of light is always constant c , whereas the group velocity is independent of source velocity but depends on observer and mirror velocity. This model disentangles absolute velocity from Doppler effect 3. The exponential Law of Doppler effect of light. 4. Absolute velocity of an object is the resultant of its mass weighed velocities relative to all massive objects in the universe. 5. Mass (inertia) may be nothing but radiation reaction. 6. The speed of light is the universal speed limit in the universe. The Apparent Source Theory (AST) fully explains conventional and modern Michelson-Morley experiments, the Sagnac experiments, moving source and moving mirror experiments, the Silvertooth, the Marinov, the Ronald de Witte, the Bryan G Wallace experiments. The procedure to apply AST is : 1. Replace the (real) source with an apparent source 2. Solve the problem by assuming (modified) emission theory and Galilean space. AST also enabled us to give a new interpretation to observations of direction of Sun's gravity on Earth, during solar eclipses. The 'speed' of gravity has been shown to be equal to the speed of light. This fact, together with a very simple, compelling theory that gravity may be just a difference of electrostatic attraction and repulsion forces, led to the conclusion that gravity must be just a form of electromagnetic phenomenon. Constant phase velocity and variable group velocity of light provides a compelling interpretation of Einstein's thought experiment: chasing a beam of light. The Exponential Law of light correctly explains the Ives-Stilwell experiment. The mystery of electromagnetic radiation has been revealed. Relativistic mass increase of charged particles and muon 'time dilation' are well established phenomenon and have been explained based on radiation reaction. The equivalence of inertia with radiation reaction has been proposed. Universal light speed limit for absolute and relative velocities has been explained by radiation reaction. A successful theoretical framework (at least partly) of the speed of light has been presented in this paper. This enables understanding of the nature of light at a more fundamental level and other phenomenon. This entails reconsideration of Maxwell's equations and their solutions. Maxwell's equations do not predict radiation reaction correctly and do not predict universal speed limit. A number of anomalous observations still exist in physics. Some of these are observations showing galaxies that seem to be receding at superluminal speeds, the Pioneer anomaly, cosmological red shift and cosmological acceleration. But if the assertion that no physical object can attain or exceed the speed of light is true, observation of apparent super-luminal galaxies shows that red-shift may not be due to Doppler effect.

Thanks to God and His Mother, Our Lady Saint Virgin Mary.

References

1. An alternative electrodynamics to the theory of Special Relativity, Musa D. Abdullahi
2. A replication of the Silvertooth experiment, Doug Marett
3. The Theory of Relativity- a mistake build on a wrong precondition, by ...
4. Measuring Propagation Speed of Coulomb's Field, A. Calcaterra, et al
5. The Speed of Gravity – What the experiments say, Tom Van flandern
6. A Novel Solution to the Century Old Light Speed Paradox; Divorce of the Light Postulate from Special Relativity; Relativity of Electromagnetic Waves, Henok Tadesse, Vixra
7. Modified Huygens' Principle; Non-Linear (Spiral) Propagation of Electromagnetic Waves, by Henok Tadesse, Vixra
8. Exponential Law of Light – A Mystery”, Henok Tadesse, Vixra
9. Unlocking the Mystery of Interference Patterns in Electron and Photon Double-Slit Experiments and the Puzzle of ‘Waves Without Medium’, Henok Tadesse, Vixra
10. Explanation of Quantum Phenomena with a New Model of Photon and Electron Emission, Propagation and Absorption, Henok Tadesse, Vixra
11. Replication of the Trouton-Noble Experiment, Patrick Cornille *et al*
12. Experimental Difference Between Magnetic Attraction and Repulsion leading to the notion of Gravitation as an Electromagnetic Attractive Force, Jaroslav J. Kopernicky
13. Apparent Shift of Past Position of Light Source due to Absolute Motion; Absolute Space as Defined by Cosmic Massive Objects; Constant Phase Velocity and Variable Group Velocity of Light, Henok Tadesse, Vixra
14. Tests of relativistic energy and momentum, Wikipedia
15. The Mean Life Time and Speed of Cosmic Ray Muons, Prashanth S. Venkataram , MIT
16. Frensel, Fizeau, Hoek, Michelson-Morley, Michelson-Gale and Sagnac in Aetherless Galilean Space, Renshaw Curtis E. , 1996
17. Ether Detection Experiment with a Laser, by Bent Kargaard, Wielsen, 2009, NPA
18. Chasing a Beam of Light: Einstein's Most Famous Thought Experiment, John D. Norton
19. Modern Michelson-Morley experiment using cryogenic optical resonators, Muller et al
20. Help on Standing Waves, related to the Silvertooth experiment, Scienceforums.net, topic started by Henok Tadesse : <http://www.scienceforums.net/topic/90992-help-on-standing-waves-related-to-the-silvertooth-experiment/>

Bibliography

1. A Novel Solution to the Century Old Light Speed Paradox; Divorce of the Light Postulate from Special Relativity; Relativity of Electromagnetic Waves, Vixra, Henok Tadesse
2. Apparent Shift of Position of Light Source Relative to Observer due to Rotation and Acceleration, Vixra, Henok Tadesse
3. Absolute Motion is Intrinsic, Vixra, Henok Tadesse
(The above three papers were published/posted on the Vixra e-preprint server previously by this author. Although these papers did not present a complete theory and they contain some mistakes, they are the pathways to the new theory proposed in this paper.)
4. A Dissident View of Relativity, William H. Cantrell
5. Some Emission Theories of Light, Wikisource
6. The Theory of Relativity - a mistake build on wrong precondition-
7. There isn't Any Experimental Evidence to Support Relativity, Xinwei Huang

8. Physics 139 Relativity Notes 1999, G.E.SMOOT
9. Chasing a Beam of Light: Einstein's Most Famous Thought Experiment, John D. Norton
10. Ritz, Einstein and the Emission Hypothesis, Alberto A.Martinez
11. The Michelson-Morley Experiment, Michael Fowler U.Va.Physics 9/15/08
12. The Einstein Myths- Of Space, Time and Ether, Eugene F.Mallove, Sc.D
13. History of the Speed of Light (c), Jennifer Deaton and Tina Patrik
14. Lesson 25: Speed of Light
15. The Speed of Light: Historical Perspective and Experimental Findings, Trent Scarborough and Ben Williamson
16. How is the Speed of Light Measured ? Philip Gibbs 1997
17. Speed of Light-Wikipedia
18. Re- Analysis of the Marinov Light-Speed Anisotropy Experiment, Reginald T.Cahill
19. New Measurement of the Earth's Absolute Velocity with the Help of "Coupled Shutters" Experiment, Stephan Marinov
20. Experimental Detection of the Ether, Ernest Wilbur Silvertooth
21. A Replication of the Silvertooth Experiment, Doug Marett (2012)
22. Motion through the ether, E.W. Silvertooth
23. The Sagnac Effect and Uniform Motion, A.Kelly
24. Stellar Aberration and the Postulates on the Velocity of Light, Domina Eberle Spencer and Uma Y.Shama
25. The Michelson Gale Experiment and its Effect on the Postulates on the Velocity of Light, Parry Moon, Domina Eberle Spencer and Euclid Eberle Moon
26. On the Second Postulate of the Special Theory of Relativity, Wikisource (Q. Majorana)
27. Frensel, Fizeau, Hoek, Michelson-Morley, Michelson-Gale and Sagnac in Aetherless Galilean Space, Renshaw Curtis E. , 1996
28. Fizeau Experiment-Wikipedia
29. Can an Undulating Stream of Particles travel rectilinearly
30. Aberration of Light-Wikipedia
31. Doppler Shift for Sound and Light, Stevie Smith , 1957
32. Relativity of Light, JMJ (from relativityoflight.com)
33. The Michelson Gale Experiment, DougMarett (2010)
34. The Harvard Tower Experiment was frauded,Quantoken , Jan 27 2005
35. Is there a dynamic ether? A new reality for 21st century physics, Lew Price
36. Measuring Propagation Speed of Coulomb's Field,
A. Calcaterra, R.de Sangro, G.Finocchiaro, P.Patteri, M.Piccolo, G.Pizzela
37. Anti-Relativity: So Many Nobel Prize Winners Disagree
38. Einsteins Special Relativity has no Real World Evidence
39. Principles of Emission Theory, A.A.Cyrenika
40. Effect of Reflection From a Moving Mirror on the Velocity of Light, A.A. Michelson
41. The Development of Our Views On the Composition and Essence of Radiation
42. Modern Michelson Morley experiment using cryogenic optical resonators,
Holger, Muller, Sven Herrmann, Claus Braxmaier, Stephan Schiller, Achim Peters Feb 2008
43. Emission Theory-Wikipedia
44. Possible Experiments to test Einstein's Special Relativity Theory, Victor Otto de Hann
45. The Real Einstein, Roberto A.Monti
46. The Speed of Gravity – What the experiments say
47. Lumineferous Ether –Wikipedia
48. Sagnac effect – Wikipedia
49. The Feynman Lectures on Physics, www.feynmanlectures.caltech.edu
50. Aberration and the Speed of Gravity, S. Carlip
51. The Speed of Gravity- Why Einstein was wrong,Michaelsuede, My 14 2010

52. Experimental Demonstration of the Constancy of Velocity of Light Emitted by a Moving Source, Quirino Majorana (from Wikisource)
53. Radar Testing of the Relative Velocity of Light in Space, Bryan G.Wallace
54. A New Interpretation of the Hafele-Keating Experiment, Domina Eberle Spencer, Uma Y.Shama
55. Conducting a crucial experiment of the constancy of the speed of light using GPS, by Ruyong Wang, Ronald R. Hatch
56. The Ives-Stilwell Experiment, A.A. Faraj
57. The Relativistic Doppler Effect, Michael Richmond
58. NASA's astonishing evidence that c is not constant; The Pioneer Anomaly, E.D. Greaves
59. Radar Testing of the Relative Velocity of Light in Space, Bryan G.Wallace
60. Experiment on the Constancy of Velocity of Electromagnetic Radiation, Peter Beckman and Peter Mandics
61. Fundamental Physics: High precision tests of Special and General Relativity
62. Illuminating relativity :experimenting with the stars
63. The Michelson-Gale experiment, DougMarett (2010)
64. Moving magnet and conductor problem- Wikipedia
65. The Development of Our Views on the Composition and Essence of Radiation
66. Tests of Special Relativity- Wikipedia
67. Rethinking Relativity, Tom Bethel
68. The Sagnac Effect: Does it Contradict Relativity ? DougMarett , 2012
69. Relativity 4 Engineers
70. The Sagnac Effect and Uniform Motion, A.G. Kelly
71. Stellar Aberration and Einstein's Relativity, Paul Marmet
72. Where did the aether go ? Brendan D. Murphy
73. Is the Aether Entrained by the Motion of Celestial Bodies ? What do the Experiments Tell Us ? Joseph Levy
74. Bradley, Sagnac & Entrainment, John-Erik Persson
75. Einstein – His Life and the Universe, Walter Issacson
76. An Astronomical Test for the Second Postulate of the Special Theory of Relativity, Juan J. Schulz Poquet
77. Measurement of the Speed of Gravity, Yin Zhu
78. Speed of Gravity-Wikipedia
79. Correspondence. Light and Gravity Aberration –Ether-Wind Detection, Persson (from Galilean Electrodynamics)
80. The Speed of Gravity- Why Einstein was Wrong, Michael Suede
81. What is the Speed of Gravity, Ethan (August 25/2010)
82. What is the experimental basis of Special Relativity? Tom Roberts and Siegmur Schleif
83. Possible Experiments to Test Einstein's Special Relativity Theory, Victor-Otto de Hann
84. The Rotating Interferometer, Response to Robert Driscoll
85. Some more details on the Michelson-Morley experiment
86. The Surprising Results of the Michelson-Morley experiment, Michael Richmond
87. Galilean invariance-Wikipedia
88. Galileo's Ship-Wikipedia
89. Sagnac effect- Wikipedia
90. Tests of General Relativity-Wikipedia
91. Evidence of Warped Spacetime, Nick Strobel
92. Special Relativity-Wikipedia
93. On the Establishment of aUniversal Time, Parry Moon and Domina Ebrle Spencer
94. On Seeing the Superluminals, Cynthia Kolb Whitney
95. Questioning Einstein, Tom Bethell (from Einstein Plus Two, by Petr Beckmann)
96. Trouton-Noble experiment-Wikipedia

97. Challenging dominant Physics Paradigms, by Juan Miguel Campanario and Brian Martin
98. Theory and Experimental Tests: The Nature of Space and Time (*from* Conspiracy of Light)
99. Doppler and Special Relativity, Han Erim
100. Relativistic Doppler effect- Wikipedia
101. What the Global Positioning System Tells Us about Relativity, Tom Van Flandern
102. Critique of Special Relativity (PRP-1), George A. Adriaenssens
103. Did the Hafele-Keating Experiment Prove Einstein Wrong?
V. Booblehead productions
104. Ives-Stilwell Experiment Fundamentally Flawed, Joseph A. Rybczyk
105. Why are orbits elliptical? Why isn't the sun at the center of the orbits? Is there a mathematical or gravitational answer or is it just a random placement after formation?
106. Theory of Relativity: A Critical Analysis, Robert A. Monte
107. Einstein's Relativity has no real world evidence, Werner Heisenberg
108. The Radiation Continuum Model of Light and the Galilean Invariance of Maxwell's Equations, Renshaw, 1996 *
109. Einstein's Investigations of Galilean Covariant Electrodynamics Prior to 1905, John D. Norton
110. Kündig's experiment on the transverse Doppler shift re-analyzed, A L Kholmetskii *et al*
111. A Mössbauer experiment in a rotating system on the second-order Doppler shift: confirmation of the corrected result by Kündig, Alexander L Kholmetskii *et al*
112. Experimental Basis for Special Relativity in the Photon Sector, Daniel Y. Gezari
113. Modern Michelson-Morley experiment using cryogenic optical resonators, Holger Muller *et al*
114. Trouton-Noble experiment, Wikipedia
115. Alternatives to Relativistic Mass, www.alternativephysics.org

* Interestingly, the theory of 'The Radiation Continuum Model of Light and ...' proposed by Renshaw has some similarity with the 'Relativity of Electromagnetic Fields and Waves' theory which I proposed one year before I even saw/read the 'The Radiation Continuum ...' theory. The 'contraction' / 'expansion' of electromagnetic fields and waves I proposed has some similarity with the 'elasticity' in the 'Radiation Continuum Model of Light'. Independent proposal of somewhat similar ideas by two authors might show the plausibility of the idea.