

Apparent shift of position of light source due to absolute motion; Absolute space as defined by massive cosmic objects; Locally constant phase velocity and locally variable group velocity of light; Relativity of electromagnetic fields and waves.

The absolute space-free space continuum. Speed of light increases with distance from cosmic massive objects and is infinite in free space.

A new Michelson-Morley experiment using two independent coherent light sources.

Distinction between the new interpretation of absolute space and the ether theory.

The Silvertooth and Marinov experiments.

Henok Tadesse, Electrical Engineer, BSc.

Ethiopia, Debrezeit, P.O Box 412

Tel: +251 910 751339 email entkidmt@yahoo.com or wchmar@gmail.com

23 June 2014 G.C (16/11/2006 Ethiopian Calendar)

Abstract

In this paper a new interpretation and theory of absolute motion and the speed of light is proposed. There are numerous and divergent experimental and observational evidences related to the speed of light that have accumulated for centuries, but defied a natural and logical explanation by any known single theory of light. The conventional and modern Michelson-Morley and the Kennedy-Thorndike experiments, the Trouton-Noble experiment, the Sagnac and Michelson-Gale experiments, de Sitter's binary star argument, moving mirror and moving source experiments, the positron annihilation in flight experiment, bending of starlight near the sun, the Hafele-Keating, 'time dilation' experiments, the GPS correction, astronomical and terrestrial speed of light measuring experiments, stellar aberration, the Ives-Stilwell, the Fizeau experiments, relativistic 'mass increase' of the electron. The Pioneer anomaly, the Silvertooth and the Marinov experiments, Venus planet radar range data anomaly (Bryan G. Wallace) and Ronald de Witte's experiment are some of the relatively recent anomalies adding to the list. The emission and ether theories are logical and intuitive but decisively fail on a number of experiments. The Special Relativity Theory (SRT) apparently agrees better with experiments and observations, but is illogical, counterintuitive. SRT utterly fails to explain the Sagnac effect and, particularly, the Silvertooth and Marinov experiments. The Michelson-Morley experiment (MMX) can be explained otherwise easily, naturally by the emission theory. The ether theory is the most straightforward theory to explain the Sagnac effect. Einstein's thought experiment (light postulate) is also attractive in the interpretation of Maxwell's equations. This paper presents a new theory which fuses emission theory, absolute space theory and Einstein's light postulate into a single theoretical framework. 1. A new interpretation of absolute motion : the effect of absolute motion is to create a change in path length, and not the speed, of light (for co-moving source and observer). The velocity of light is c relative to the *apparent* source, and not relative to the source. The center of the wave fronts neither stays at the point in space where the source was at the instant of emission (as in SRT and ether theories), nor move with the source as in emission theories. The center of the wave fronts moves with the *apparent* source. The ether doesn't exist. Relative to a detector on a rotating Sagnac device, the source appears farther away when 'looking' in the backward direction than when 'looking' in the forward direction. 2. Massive cosmic objects define or 'fix' the space in their vicinity, with their influence diminishing with distance. The absolute velocity of a body is the vector sum of all its absolute velocities; it is proportional to the 'inverse squared distance' weighed velocity of the body *relative* to all cosmic massive objects in the universe. In free space (region of space far from cosmic massive objects) there will be no absolute motion and hence no apparent shift of light source (no 'aberration'); it follows that the phase and group velocity of light is infinite in free space. There will be no 'free' space endowed with characteristics permittivity and permeability. The speed of light increases with distance from cosmic massive objects. 3. The phase velocity of light is *locally*

constant, in accordance with Maxwell's equations, whereas the group velocity of light is locally variable. The apparent *phase* velocity c' of light relative to a source at rest increases or decreases by the same amount of the velocity (V) of the observer, so that the phase velocity of light relative to the observer is always equal to c : $c' + V = c$ (vector sum). This is also interpreted to account for the 'relativistic mass increase' of the electron. A new result of Einstein's thought experiment is proposed: for an observer moving at the speed of light away from a light source that is at absolute rest, the phases will still move past the observer at the local speed of light whereas the group will be frozen. This paper discloses the mystery behind the failure of many experiments to detect any dependence of the velocity of light on the velocity of the source. Fundamental flaws in conventional and modern Michelson-Morley experiments is disclosed. A new type of Michelson-Morley experiment capable of detecting absolute motion is proposed.

Introduction

The notions, theories, experiments and phenomena on the nature of space, motion and the nature and speed of light and the process of radiation are numerous, divergent and have been the source of centuries of confusions. The resolution of the many associated contradictions and paradoxes has remained a truly daunting task.

The problem in physics today is not only the puzzling and extremely subtle behavior of light, but also the lack of recognition to the problem. The scientific community assumes that these problems had been settled one hundred years ago.

The principle of relativity, first introduced by Galileo, is known to be one of the most cherished ideas in physics. The idea of absolute space and absolute motion existed since Newton, but with cloudy idea of its meaning.

Einstein was the first scientist to clearly and explicitly deny the validity of absolute motion, in a revolutionary way. Einstein's denial was clear, explicit and revolutionary. He clearly stated the emptiness of space.

The Special Relativity theory (SRT) is the main theory that is claimed to have resolved and settled these paradoxes, during the last century. The beauty of Einstein's relativity theory can be considered to be the main factor for the wide acceptance of the theory by the scientific community. The SRT presumes fundamentally that there is no experiment that can detect absolute motion[4]. From this assumption follows, beautifully, the relativity of space and time. The idea is that if no physical experiment exists that can detect absolute motion, then absolute motion, absolute space and absolute time do not exist. Such a view was revolutionary and it apparently got rid of the absolute notion. Einstein's famous and beautiful light speed thought experiment ('chasing a beam of light') was another of Einstein's thought experiments that made the scientific community fall in love with SRT. The logical consistency and experimental foundation of the light postulate has been crucial for SRT and it is always taken as an assurance of the correctness of SRT. The SRT was apparently able to solve many problems of classical physics.

The Michelson-Morley (and the Kennedy-Thorndike) kind experiments are the only experiments that may be claimed as evidence for the constancy of the speed of light for all observers. The constancy of the speed of light *for any observer* has no other *direct* experimental evidence to date. Not a single physical experiment has been done in a whole century to directly test this crucial assumption to rule out all other possible explanations and confusions. We had to rely only on Einstein's light speed thought experiment. For example, one possible experiment could have been for an observer moving towards a stationary light source and looking for a change in wavelength implied in Einstein's light postulate.

On the other hand, the speed of light has been measured for centuries with increasing accuracy, from astronomical observations and terrestrial experiments, with such experiments as the Albert Michelson rotating mirror experiment and modern experiments using laser beams and cavity resonators. The fact that no significant variation has been found in different experiments shows that the measured speed of light does not depend on the orientation of the measuring apparatus relative to the earth's orbital or absolute velocity.

The ether and emission theories were the other two theories competing with SRT. The ether (or classical absolute space) theory was ruled out decisively by the MMX null result. However, it was supported by the Sagnac effect.

Emission theory was the most straight forward theory to explain the MMX null result, but it failed to explain the Sagnac effect. Many experiments showed that the speed of light is independent of the velocity of source or mirror, such as the Albert Michelson moving mirror experiment (1913) and the Q.Majorana experiments and many others. Modern experiments using elementary particles as moving sources of radiation, such as the 'positron in annihilation in flight' experiment, use elementary particles moving at speeds comparable to the speed of light detected no dependence of the speed of light on the speed of the source. The de Sitter's argument of binary stars is considered to be the last blow on emission theories, although this argument was criticized after many years by Fox.

An evidence claimed to clearly support emission theory was the one reported by Bryan G. Wallace, from observation of radar range data of the planet Venus.

There is also the Universal Time light postulate proposed by Moon and Spencer, which implies instantaneous distance and velocity information transmission, or 'rigid' attachment of the wave to its source.

SRT cannot explain *both* the MMX and the Sagnac effect in the same way. It treats the two experiments differently. The Sagnac effect may be assumed to be explained by Galilean relativity. No 'length contraction time dilation' has been introduced into its explanation with SRT so far. The usual argument is that it is not relativistic because the peripheral speed is low and that SRT applies only to inertial systems. But SRT requires 'length contraction time dilation' to explain the MMX. A linear Sagnac experiment would decide between relativity and absolute motion.

The light speed problem is seen as the interpretation of the constant c in Maxwell's equations. The constant c is interpreted differently in each theory/postulate of light. Einstein's light postulate (light speed thought experiment) is an attractive interpretation of Maxwell's equations, better than the emission and ether theories.

In the lack of any better theory, thus, Einstein's relativity theory was accepted as a true theory of nature during the last century. However, despite its superficial beauty, Einstein's relativity theory seems to be a marriage between correct ideas and fundamentally wrong assumptions and interpretations. It is based on a logically sound idea of empty space (non-existence of the ether) and constancy of light speed, which was apparently confirmed by the MMX null result. The fundamental mistake of SRT is that it presumes that there is no physical experiment that can detect absolute motion. This means that if an experiment is discovered that can detect absolute motion, then SRT will be invalidated, despite all experimental evidences.

A mind blowing evidence of absolute motion of the earth was disclosed by Silvertooth in his experiment of 1986. Silvertooth's experiment revealed an absolute velocity of 378 Km/s at a time when an upper bound of about 2.5 cm/s was set on a possible anisotropy of light speed, with a series of conventional and

modern Michelson-Morley type experiments ! The absolute velocity detected in Silvertooth's experiment varied from about zero to a maximum of 378 Km/s , correlated with sidereal time and consistently pointing to the constellation Leo. Silvertooth's experiment would be ignored by the scientific community as usual. The astonishment came later on when precise measurement of CMBR spectrum anisotropy by NASA COBE satellite showed a velocity of 390 Km/s of the solar system relative to the CMBR, in the same direction of constellation Leo, in striking agreement with Silvertooth's experiment. However, the analysis and explanation given by Silvertooth himself was based on the ether theory and was not clear. Other experiments pointing to absolute motion were also performed by different physicists, such as the earlier Marinov experiment and the later experiment carried out by Ronald DeWitte.

Thus, in the presence of so many contradicting experimental evidences and phenomena, and related notions and theories of space, time, motion and speed of light, and the phenomenon of radiation, the unifying idea behind all these has remained a mystery to date. The principle of relativity and the absolute notion both seem to have supporting evidences and the absolute notion has never been truly ruled out as often claimed in SRT. All the three well known theories/postulates of light namely, Einstein's light postulate, emission theories and the absolute space (ether), seem to have supporting evidences.

This paper is an attempt to develop a coherent theoretical framework that may unify all or most of the theories, experimental evidences and observations related to the speed of light. A new theoretical framework is proposed in which absolute space/ absolute motion theory, emission theory and Einstein's light postulate, are fused into a single model, with features of each theory that do not fit into the new model left out. Argument on the non-existence of the ether is also proposed.

A new interpretation of absolute motion and explanation of the Silvertooth experiment is presented. Then a new theory 'Relativity of EM fields/waves' is proposed. We discuss the phenomena of stellar aberration and the transverse Doppler effect. A new Michelson-Morley type experiment using two coherent light sources will be proposed.

Discussion

A new interpretation of absolute motion

The notion of absolute space and the ether hypothesis existed for centuries. The two concepts have always been wrongly referred to be the same. In this paper a new interpretation of absolute space and its distinction from the ether or classical absolute space theory will be proposed.

The emission and ether theories may explain the Michelson-Morley, the Kennedy-Thorndike and the Trouton-Noble experiments. The observed anisotropy of light speed also agrees with emission theory. The ether theory fails on these experiments.

The ether theory may explain the Sagnac, the Michelson-Gale, the Silvertooth, the Marinov, moving source and moving mirror experiments (Albert Michelson, Q.Majorana, positron annihilation in flight, ...), de Sitter's binary star experiments. Emission theory fails on these experiments.

Stellar aberration may be explained by either emission or ether theory.

We see that many of the experiments on the speed of light can be explained intuitively, naturally, logically either by the emission or the ether theory. This is the hint to the resolution of the paradoxes and contradictions related to the speed of light:

a fusion of the emission and the ether theories.

Such a theory, which is a fusion of emission theory and ether theory, may also explain other ‘exotic’ experiments and effects such as the Ives-Stilwell experiment, ‘GPS correction’, ‘time dilation’, relativistic ‘mass increase’ of the electron, ... , or pave the way for their understanding, or make them non-existent or invalid. Such a theory would render special relativity unnecessary.

The fusion of ether and emission theories is presented as follows:

The effect of absolute motion (of the Michelson-Morley and Sagnac interferometers) is to create a change in path length, and not the speed, of light. The effect of absolute motion of the Michelson-Morley and the Sagnac interferometers is to create an apparent change of position (distance and direction) of the light source, as seen by the detector/observer. The center of the wave fronts moves with the apparent source, and not with the source. The velocity of light is c relative to the apparent source.

Consider the Michelson-Morley (MM) apparatus.

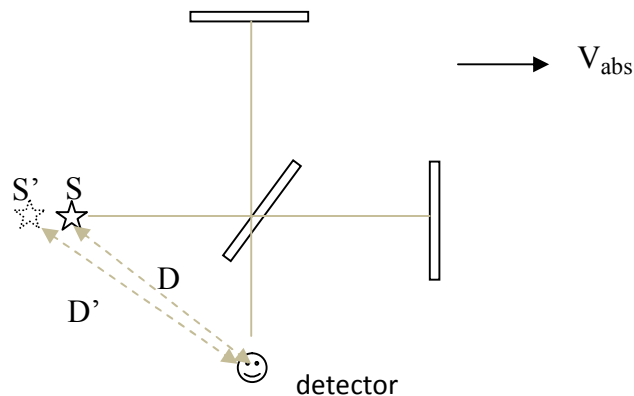

As seen in the figure above, the source has shifted apparently from its real position S to an apparent position S', due to absolute motion of the device. The effect of apparent change of position of the source can be understood as follows. Actually (physically) shifting the source position to position S' would not, obviously, result in a fringe shift. The same holds for apparent change of source position: no fringe shift would occur. This is because the forward and lateral beams are affected identically by the change of source position from S to S'.

The same kind of interpretation can explain the fringe shift of a rotating Sagnac device. If we ‘unwind’ the Sagnac interferometer, we can see how the fringe shift arises.

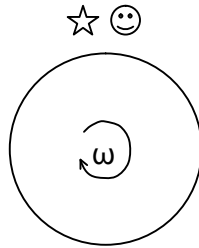

Relative to the detector, the source appears farther than it actually is ($D' > 2\pi R$) when 'looking' in the backward direction, as shown below,

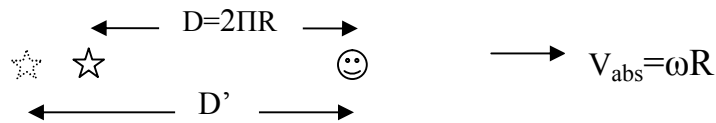

and the source appears to be nearer than it actually is ($D' < 2\pi R$) when 'looking' in the forward direction (direction of motion), as shown below.

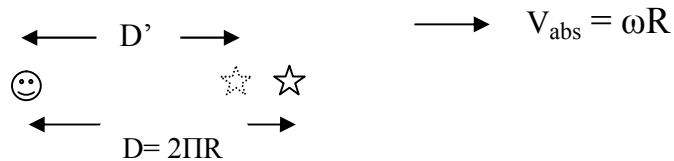

Since the path lengths of the forward and backward light beams will be different due to rotation, there will be a fringe shift.

This interpretation is the central theme of this paper and will be applied throughout this paper. It has been discovered by this author that this interpretation of the MM and Sagnac experiments is a special case of a more general interpretation. In the MM and Sagnac experiments, the source and the observer/detector are co-moving and hence they will always have equal absolute velocities /speeds, and no relative motion between them. The general case is for the source and the observer to have independent/ different absolute velocities, and hence with relative motion between them.

In the next section an elementary analysis for co-moving source and observer will be presented based on the new interpretation, followed by the application to the analysis of MM, Sagnac, Silvertooth, ... experiments.

(Absolutely) Co-moving source and observer

Imagine a light source S and an observer O co-moving in space to the right.

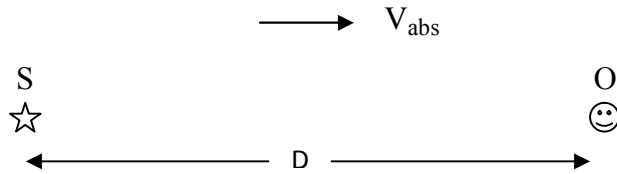

We will assume that the light source and the observer are moving absolutely, with absolute velocity V_{abs} to the right, and then give the new interpretation of absolute motion.

If V_{abs} is zero, i.e if the light source and the observer are at absolute rest, then a light pulse emitted from S will be received by the observer O after a time delay of:

$$t_d = D/c$$

If V_{abs} is not zero, however, the time delay will be determined as follows:

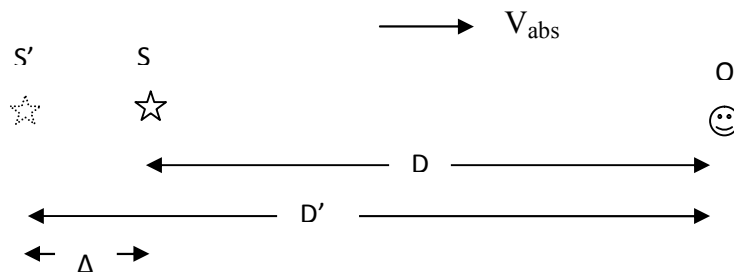

The observer receives a light pulse emitted not from a point in space where the source is at that instant of time but from a point S' in space where the source was some time ago.

During the time (t_d) that the source moves from point S' to point S, the light pulse moves from point S' to point O, i.e the time taken for the source to move from point S' to point S is equal to the time taken for the light pulse to move from point S' to point O.

$$\Delta / V_{abs} = D' / c$$

But

$$D + \Delta = D'$$

From the above two equations:

$$D' = D * (c / (c - V_{abs}))$$

and

$$\Delta = D * (V_{abs} / (c - V_{abs}))$$

The above analysis is based on classical absolute space or ether theory.

The light beam is thought as starting from an absolute point in space: 'a point in space'. The center of the wave fronts is thought to be or to remain at that 'point in space' where the source was at the instant of emission. Special Relativity and the ether (or classical absolute space) theory are based on such assumption. This assumption, however, has been disproved by the Michelson-Morley experiment (MMX) null result.

The new interpretation is presented as follows.

To the observer, the light source appears to have shifted by an amount Δ backwards away from the observer, but the center of the wave fronts is always at the apparent source position, for a constant absolute velocity V_{abs} .

There is no 'point in space' to be the center of the wave fronts. Space is empty and there is no medium (ether). The center of the wave fronts is always at the (apparent) source. This is the new interpretation.

The same analysis can be done if the source and the observer were co-moving absolutely to the left.

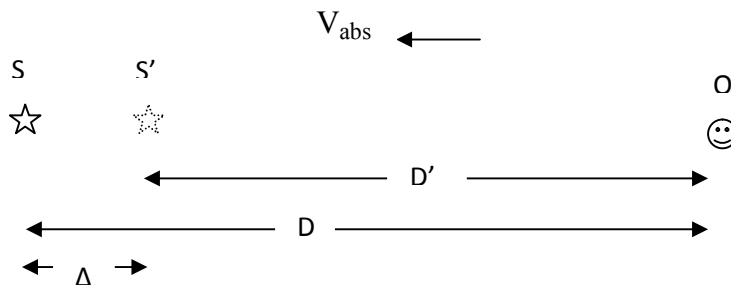

In this case, the source appears to have shifted by an amount Δ towards the observer.

$$D' = D (c / (c + V_{abs}))$$

$$\Delta = D (V_{abs} / (c + V_{abs}))$$

Imagine two light sources S1 and S2 co-moving with the observer O to the right, with absolute velocity V_{abs} .

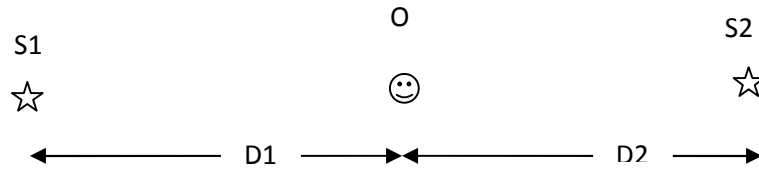

S1 and S2 are at distances $D1$ and $D2$ from O, respectively.

Assume that initially V_{abs} is zero (i.e. absolute rest). Then light pulses emitted from S1 and S2 arrive at O after delays:

$$t_{d1} = D1 / c$$

$$t_{d2} = D2 / c$$

If V_{abs} is not zero, then S1 appears to have shifted backwards away from O, whereas S2 appears to have shifted towards O.

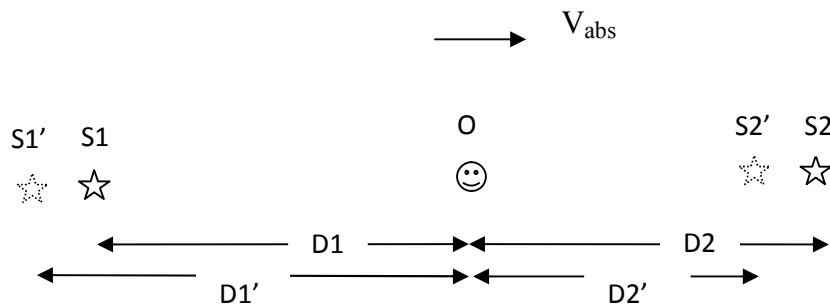

Hence if observer O used an interferometer, he would detect a fringe shift as the absolute velocity increased from zero to V_{abs} .

So according to the new theory any problem of absolute motion of source and observer is solved by replacing the real source with an apparent source and then assume that absolute velocity is zero.

The distinction of this theory will be clearer if we consider the case for sound or water waves, or the ether. Assume that the sound source and the receiver are on a common platform moving with velocity V relative to air, as shown below. We can analyze the problem as if the source and the receiver are at rest relative to the air, but replace the real source by an apparent source, as we did for a light source, as shown below.

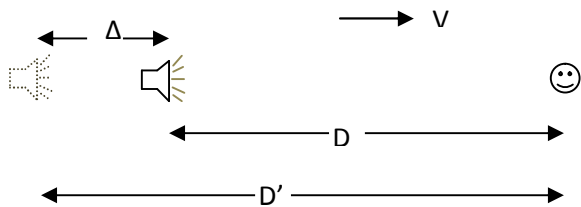

Unlike light, the velocity of sound waves relative to the observer is $c_s \pm V$, where V is the velocity of the receiver relative to air, c_s is the velocity of sound relative to air. In this case it will be $c - V$ because the receiver is moving in the same direction as the sound wave. The time it takes sound to travel distance D' is equal to the time it takes the source to travel distance Δ .

Therefore,

$$D' / c_s = (D' - D) / V$$

D' will be:

$$D' = [(c_s - V) / (c_s - 2V)] \cdot D$$

So we get a different formula for sound.

Now imagine a light source S and an observer O as shown below, with the relative position of S and O orthogonal to the direction of their common absolute velocity.

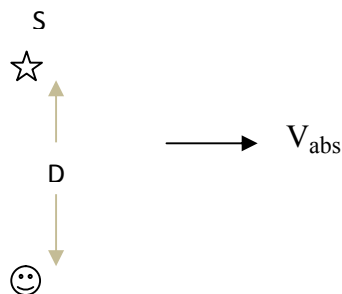

S and O are moving to the right with absolute velocity V_{abs} .

If V_{abs} is zero, a light pulse emitted from S will be received by O after a time delay t_d

$$t_d = D/c$$

If V_{abs} is not zero, then the light source appears to have shifted to the left as seen by observer O .

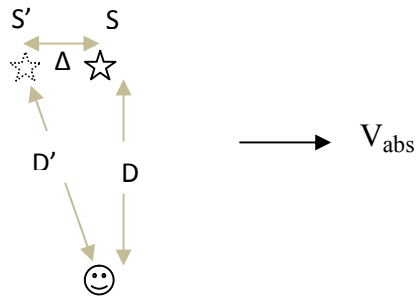

In the same way as explained previously,

$$D' / c = \Delta / V_{abs}$$

But,

$$D^2 + \Delta^2 = D'^2$$

From the above two equations

$$D' = D * (c / (c^2 - V_{abs}^2)^{1/2})$$

Therefore, the time delay t_d between emission and reception of the light pulse in this case will be

$$t_d = D' / c = (D / (c^2 - V_{abs}^2)^{1/2})$$

Now suppose that there are two light sources S1 and S2, as shown below.

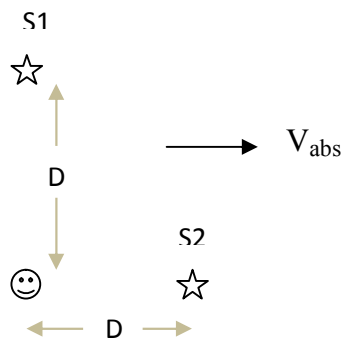

S1, S2 and observer O are co-moving absolutely to the right with absolute velocity V_{abs} .

If V_{abs} is zero the two time delays will be equal.

$$t_{d1} = t_{d2} = D / c$$

If V_{abs} is not zero, the positions of the sources will change apparently relative to the observer as shown below and hence the two time delays will be affected differently and hence a fringe shift will occur.

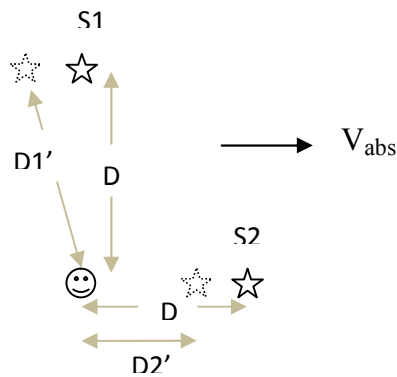

In this case, the two time delays will be different..

$$D1' = D * (c / (c^2 - V_{abs}^2)^{1/2})$$

$$D2' = D * (c / (c + V_{abs}))$$

Therefore

$$t_{d1} = D1' / c$$

$$= D / (c^2 - V_{abs}^2)^{1/2}$$

and

$$t_{d2} = D2' / C = D / (C + V_{abs})$$

Hence, a fringe shift would occur as the absolute velocity is increased.

So far we considered only the simplest ideal systems in which only a light source and an observer existed. However, real experiments involve mirrors, so we will analyze a system additionally consisting of mirrors in the next section.

Consider a light source S, an observer O and a mirror M, co-moving to the right with absolute velocity V_{abs} .

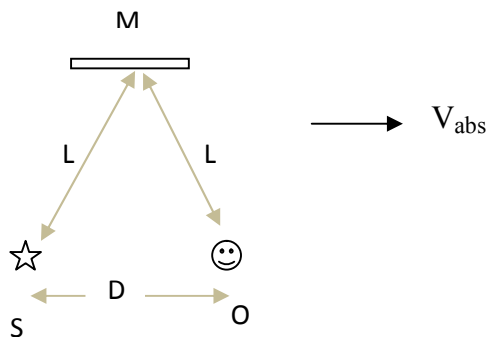

If V_{abs} is zero, then the time delay between emission and reception of a light pulse will be

$$t_d = 2L / C$$

If V_{abs} is not zero, then, as discussed previously, the source S appears to have shifted away from the observer O .

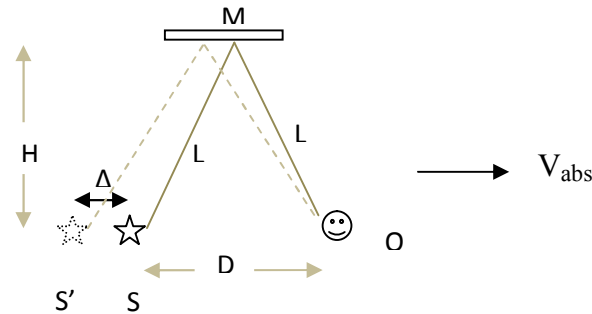

$$\Delta = D * (V_{abs} / (c - V_{abs}))$$

Hence the length of the light path from S' to O will be:

$$2 * (((D + \Delta)/2)^2 + H^2)^{1/2}$$

Therefore, the time delay will be

$$t_d = (1/c) * 2 * (((D + \Delta)/2)^2 + H^2)^{1/2}$$

where D is the *direct* distance from observer to source.

So the effect of absolute motion is just to create an apparent shift in the position of the light source relative to the observer.

This avoids all the confusions that arise in systems consisting of mirrors. We would not say, for example, that the mirror will move to a different position while the light beam is in transit, etc. Only the position of the light source is thought to shift apparently relative to the observer.

What if the mirror is moving? Assume that the mirror is moving towards or away from the source and the observer with velocity V , with the source and observer at rest relative to each other, but with a common absolute velocity as shown in the figure. How is this experiment analyzed?

The procedure of analysis is:

1. Replace the real source with the apparent source (i.e a source at the apparent position)
2. Analyze the experiment as if the source and the observer are both at absolute rest, with the mirror in motion.

Let us consider a simpler case in which the distance D between source and observer is much less than the distance H to the mirror, so that we can assume that the source and position are at the same point in space. From our analysis so far the less the distance between co-moving source and observer, the less will be the apparent change of source position. In this case, there will not be any significant apparent change of position of the source. The source and the observer are at absolute rest (according to the procedure mentioned above), with the mirror moving towards

them with velocity V . A good example of such a case is the explanation for ‘ the anomalous radar range data of planet Venus as discovered by Bryan G.Wallace’. The detail analysis of this experiment will be made in the section ahead.

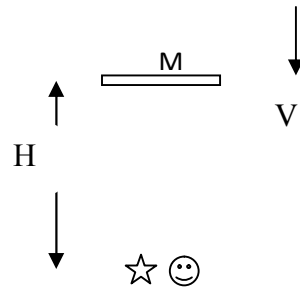

If the mirror is not moving, the round trip time of a light pulse emitted by the source will be:

$$T_d = 2H/c$$

The analysis of the round trip for the case of a moving mirror will be made in the section ahead which explains the Bryan G.Wallace experiment. In this experiment, the planet Venus acts as the mirror M.

With the interpretation(theory) presented so far, the Michelson- Morley and the Kennedy- Thorndike experiments can be explained. The secret behind the null results of these experiments is that only a single light source was used, with a single light beam split into two.

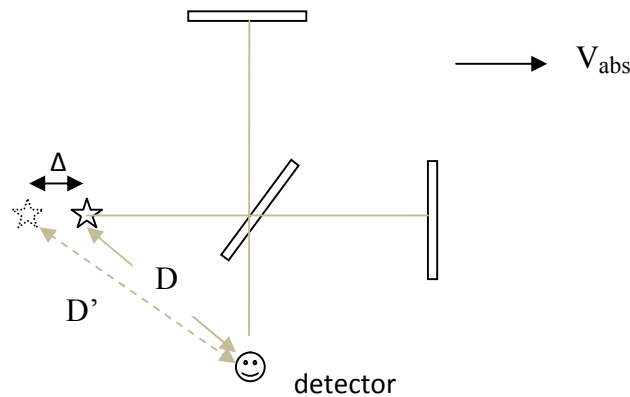

From the above diagram, we see that the effect of absolute velocity is just to create an apparent shift of the position of the light source, for absolute velocity V_{abs} directed to the right. Therefore, the apparent shift of the source is common both to the forward and lateral beams and hence the path lengths of both beams are affected in the same way and hence no fringe shift will occur.

For an absolute velocity V_{abs} directed downwards, the apparent position of the light source will be as shown below.

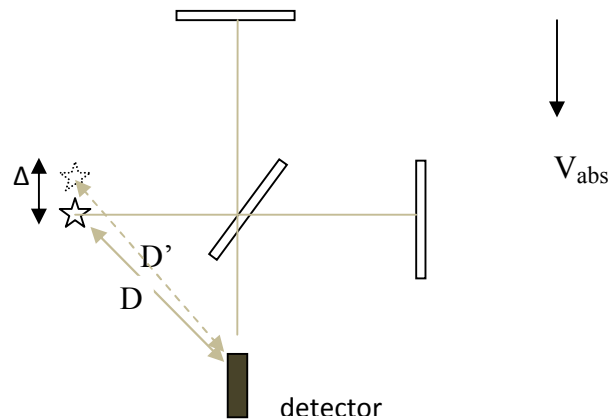

Note that there is no beam with slant path as in the conventional MMX analysis of SRT or ether theory. This is the distinction of the new theory.

Now we can see why there were NON-NUL results in many conventional MM experiments, such as the Miller experiment. There will be the same fringe shift as if the light source was actually (physically) shifted to the apparent position. If the light source is physically shifted to the position shown, the length of the path of the two beams arriving at the observer (detector) should change differently.

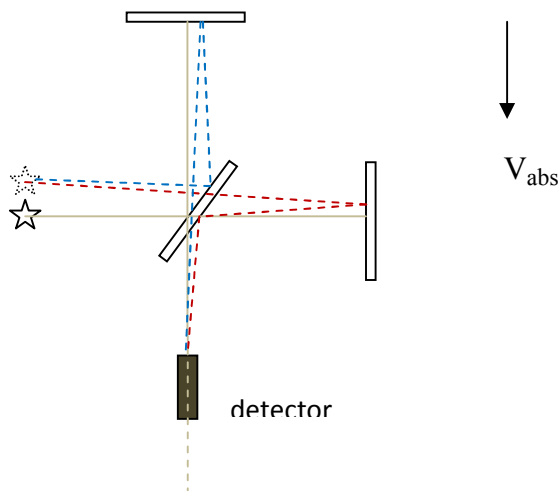

The blue and red dotted lines show the two beams. The drawing is not drawn to be accurate but only to illustrate the idea.

New proposed Michelson-Morley experiment

To detect absolute motion with an MMX type experiment, thus, we need two coherent light sources, as shown below. The single light source is omitted and the two reflecting mirrors are replaced by two coherent light sources.

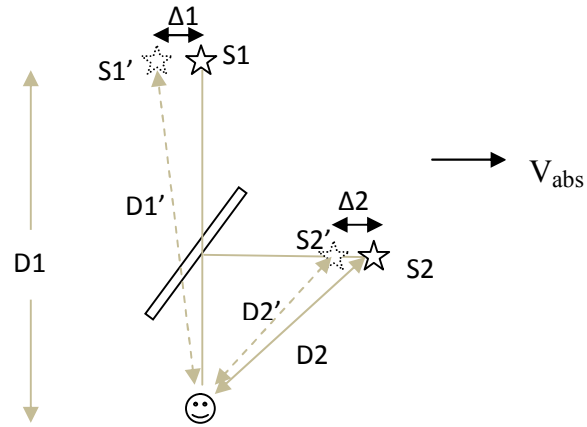

With zero absolute velocity, the two light beams arriving at the detector are aligned. However, with non zero absolute velocity, the two beams will be misaligned. Therefore, it becomes necessary to rotate the beam splitter until the two light beams are aligned and circular fringe shifts can be observed, from which absolute velocity can be determined, by taking into account the rotation of the beam splitter. Or the position of the source S1 may be adjusted (towards the right), until the two light beams are aligned. The amount of adjustment of position of S1 required to align the two beams can be used to determine the absolute velocity.

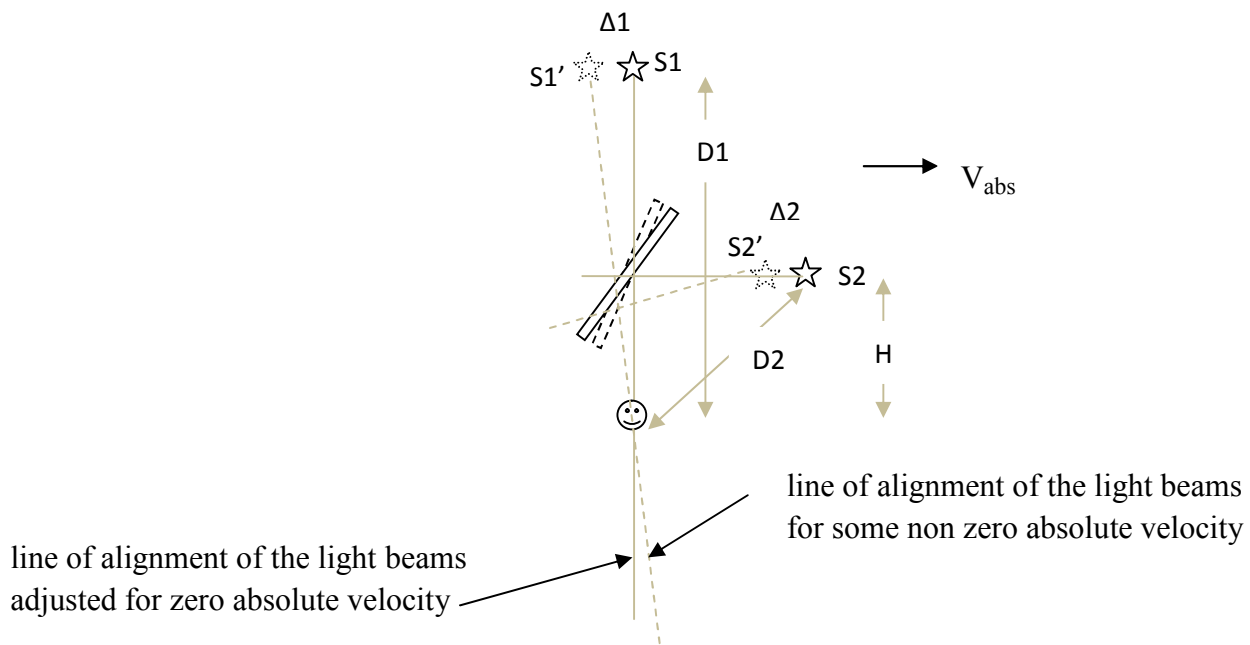

Let the two light sources be at distances $D1$ and $D2$ from the detector. Note that $D1$ and $D2$ are the *direct* distances between the detector and the sources and not between the mirror and the sources.

As discussed previously, therefore

$$t_{d1} = DI' / c$$

$$= DI / (c^2 - V_{abs}^2)^{1/2}$$

and

t_{d2} can be determined after $D2'$ is determined from the following equations.

$$D2' / c = V_{abs} / \Delta 2 \dots\dots\dots (1)$$

$$(D2'^2 - H^2)^{1/2} - (D2^2 - H^2)^{1/2} = \Delta 2 \dots\dots\dots(2)$$

A maximum fringe shift corresponding to the absolute velocity of the earth (about 390 Km/s) should be observed..

One may ask: The modern MMX experiments which are based on optical resonators use two independent orthogonal laser light beams from two laser light sources; why did the experiments failed to detect absolute motion? These experiments look for differences in the frequencies of the two orthogonal beams. As explained so far, the effect of absolute motion is to create a change in path length and hence a change in phase. The phases of the two beams change differently. Hence, there will be no effect on the frequencies. A change in phase difference (and not a change in frequencies) occurs.

Apparent contradiction in the new theory

There is a contradiction that needs resolution in the above theory/interpretation of absolute motion, however. Assume an absolutely co-moving system below.

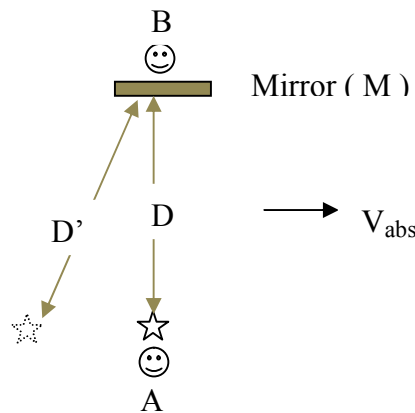

Suppose that a light pulse is emitted from the source towards the mirror M and reflected back to the source (to observer A). We assume that observer A is at the same point in space as the light source, hence, for observer A, the apparent position of the source will be the same as the real position of the source. Hence, observer A will predict that the time delay between emission of the light pulse and its reception (after reflection from mirror) will be:

$$t = 2D/c$$

From this observer A predicts that the time interval between emission and reflection at the mirror to be:

$$(t)/2 = D/c$$

However, observer B will predict this time to be

$$t = D'/c$$

Since $D' \neq D$, this is a contradiction which needs to be resolved.

Although the new theory has this apparent contradiction, the number of experiments and observations explained by the new theory far outweighs this contradiction.

If the theory is correct, this contradiction may lead to a new understanding of the nature of light. For example, the resolution of this paradox may lie in quantum mechanics. Any photon detected by observer B will be detected after a delay of D'/c . Since photons reflected from the mirror are not detected by the observer B, there will be no contradiction.

After all, the real behavior of light has remained to be subtle and there may be no surprise that there will be some apparent contradictions in a theory that is meant to explain its nature.

But there is a more plausible solution to this contradiction (see figure below).

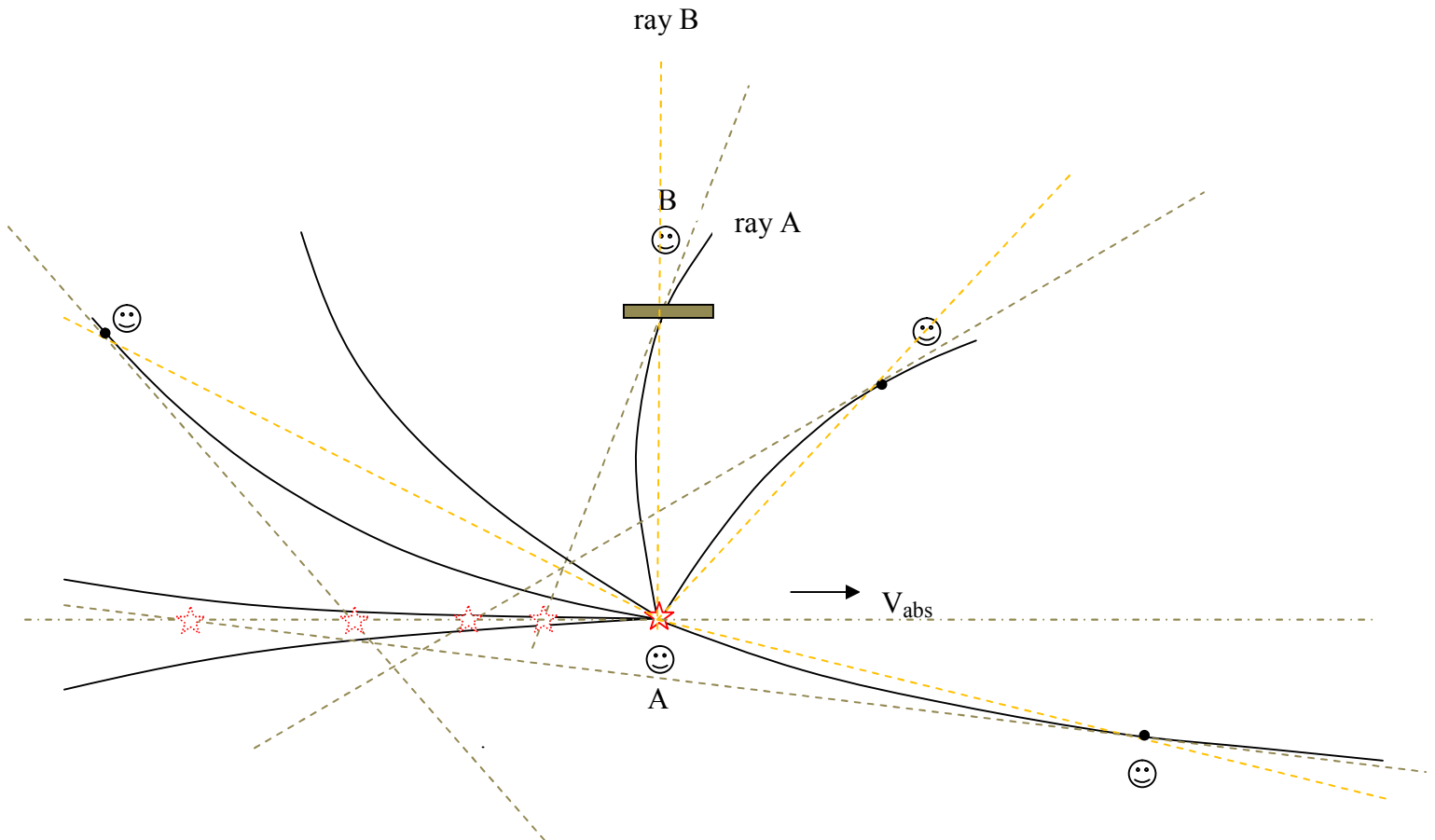

The light beam seen by observer B is thought as following the curved black path (ray B), where as the light beam going to the mirror and reflecting back to observer A follows the straight path with orange color (ray A). Apparent sources for observers at different positions are also shown. The orange radial straight lines show the path of the light beams going to each observer if the absolute velocity of the source was zero. Note that the relative position of the apparent sources may not be correct; the intention is just to propose a qualitative explanation.

The Sagnac effect

The analysis of (absolute) rotational motion is fundamentally different from that of translational motion. In this case we will not take the direct source-observer distance to determine the apparent position of the light source, as in the analysis of absolute translational motion.

Consider a Sagnac device at absolute rest, i.e not in absolute translation and rotation.

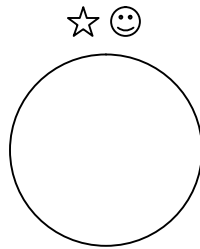

In this case the time delay for the forward and backward beams will be equal.

$$t_d = 2\pi R / c$$

Assume now that the device is rotating clockwise with angular velocity ω . We will apply the previous analysis for absolute translational motion. First consider the detector as 'looking' in the forward direction. This will be considered equivalent to a translational motion with co-moving source and detector, with the detector behind the source.

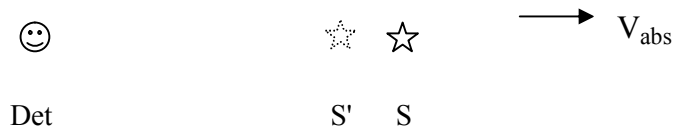

In this case, the source appears to have shifted by an amount Δ towards the detector. From previous discussion,

$$D' = D (c / (c+V_{abs}))$$

$$\Delta = D (V_{abs} / (c+V_{abs}))$$

But $D = 2\pi R$, $V_{abs} = \omega R$

$$\begin{aligned}\Delta_{FW} &= 2\pi R (\omega R) / (c + \omega R) \\ &= 2\omega A / (c + \omega R)\end{aligned}$$

Now consider the detector as 'looking' in the backward direction.

This will be considered equivalent to a translational motion with co-moving source and detector, with the detector in front of the source.



In this case, the source appears to have shifted by an amount Δ away from the detector. From previous discussion,

$$D' = D (c / (c - V_{abs}))$$

$$\Delta = D (V_{abs} / (c - V_{abs}))$$

but $D = 2\pi R$, $V_{abs} = \omega R$

$$\begin{aligned}\Delta_{BW} &= 2\pi R (\omega R) / (c - \omega R) \\ &= 2\omega A / (c - \omega R)\end{aligned}$$

The total path difference will be the sum of Δ_{FW} and Δ_{BW} .

$$\begin{aligned}\Delta &= \Delta_{FW} + \Delta_{BW} \\ &= 2\omega A / (c + \omega R) + 2\omega A / (c - \omega R) \\ &= 4\omega A c / (c^2 - (\omega R)^2)\end{aligned}$$

This can be written as:

$$\Delta = (4\omega A / c) / (1 - (\omega R / c)^2)$$

The well known standard equation for the path differences is: $4\omega A / c$

The Silvertooth experiment

Although the Sagnac effect can be taken as a strong evidence in support of absolute space/motion, it is usually claimed be explained by the Galilean principle of relativity.

The Silvertooth experiment is the other crucial evidence of absolute motion. Doug Marett has repeated the experiment[3].

In this section, the 'wavelength change effect' in Silvertooth experiment will be explained.

Imagine a light source S, an observer O and a mirror M, co-moving with absolute velocity V_{abs} to the right as shown below.

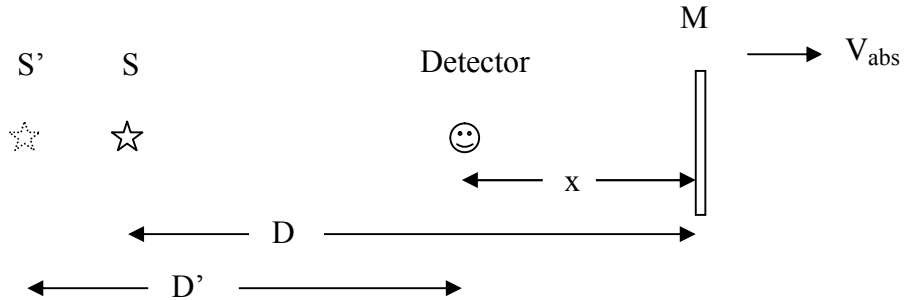

Wavelength and velocity of incident light

Light emitted by S at time $t = 0$ will be received by observer O after time delay t_d .

From the previous discussions

$$D' = (c / (c - V_{abs})) \cdot D \quad (\text{note that this } D \text{ is not the one shown in the above figure})$$

Substituting $D-x$ in place of D

$$D' = (c / (c - V_{abs})) \cdot (D - x)$$

Time delay will be

$$t_d = D' / c = (D - x) / (c - V_{abs})$$

Assume that the source emits according to

$$\sin \omega t$$

The light wave will be received at the detector as

$$\begin{aligned} \sin \omega(t - t_d) &= \sin \omega \left(t - \frac{D}{c - V_{abs}} + \frac{x}{c - V_{abs}} \right) \\ &= \sin \left(\omega t - \frac{\omega D}{c - V_{abs}} + \frac{\omega x}{c - V_{abs}} \right) \end{aligned}$$

The above is a wave equation. If we take a 'snapshot' of the wave at an instant of time $t = \tau$, the above equation will be:

$$\sin \left(\omega \tau - \frac{\omega D}{c - V_{abs}} + \frac{\omega x}{c - V_{abs}} \right)$$

The two terms $\omega \tau$ and $\omega D / (c - V_{abs})$ represent constant phases. The 'wavelength' is determined from the third term:

$$\omega x / (c - V_{abs})$$

If we have a function

$$\sin kx$$

then the wavelength can be shown to be

$$2 \pi / k$$

In the same way, for the function

$$\sin (\omega x / (c - V_{abs}))$$

$$k = \omega / (c - V_{abs})$$

Hence the 'wave length' of the incident light will be

$$\lambda_{INC} = 2 \pi / k = 2 \pi / (\omega / (c - V_{abs})) = 2 \pi (c - V_{abs}) / \omega = (c - V_{abs}) / f$$

$$\lambda_{INC} = (c - V_{abs}) / f$$

One may think that the speed of light relative to the observer changes and will be $c - v$ because of change in wave length shown above (since frequency will not change for co-moving source and observer, as stated by Silvertooth in his paper). This would disagree with the constant light speed postulate and also with emission theory in which the velocity of light is constant relative to the source.

However, one important interpretation in this analysis is that the 'wave length' determined above is not to be considered as a wavelength. According to the new theory, the apparent position of the source is different for two observers at different points of x . So an observer at point x can measure only the frequency and time delay and not wavelength because it is impossible to measure wavelength at a point. Therefore, the speed of light relative to an observer at point x is defined as the ratio of the distance from point x to the apparent source and the time delay between emission and reception, and this ratio is always equal to c for a source and observer at rest relative to each other, and cannot be determined as the product of wavelength and frequency.

Note that the wavelengths predicted here are different in form than the wavelength predicted by Silvertooth, in his paper, but the results obtained are nearly the same as will be shown shortly.

Wavelength and velocity of reflected light

Next we determine the wavelength of the reflected light.

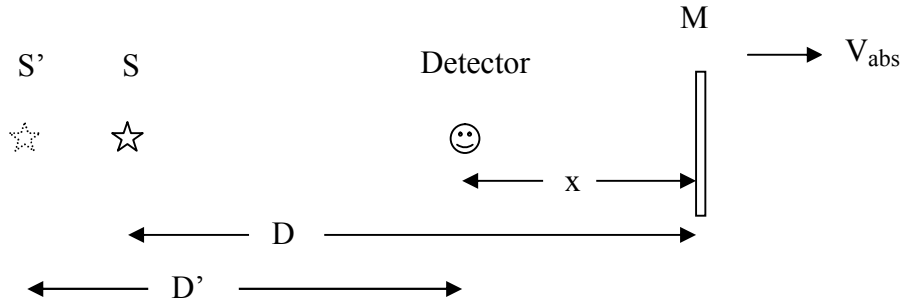

Time delay between emission and reception before reflection of light from mirror M, at point x, has been determined as follows (preceding section).

$$D' = (D-x) (c / (c-V_{abs}))$$

Relative to an observer at point x, who is observing the reflected light, time delay between emission and reception of reflected light will be:

$$\begin{aligned} t_d &= D' / c + 2x / c = (D-x) / (c-V_{abs}) + 2x/c \\ &= D / (c-V_{abs}) - x / (c-V_{abs}) + 2x/c \\ &= D / (c-V_{abs}) - x (1/(c-V_{abs}) - 2/c) \\ &= D / (c-V_{abs}) + x (c-2V_{abs}) / c(c-V_{abs}) \end{aligned}$$

If the source emits light according to

$$\sin \omega t$$

The light wave will be received at point x as

$$\sin \omega (t-t_d) = \sin \omega [t- D/(c-V_{abs}) - x (c-2V_{abs})/c(c-V_{abs})]$$

The coefficient of x is

$$k = \omega (c-2V_{abs}) / c(c-V_{abs})$$

As before, the 'wavelength' of reflected light will be:

$$\begin{aligned} \lambda_{REF} &= 2 \pi / k = 2 \pi / [\omega (c-2V_{abs}) / c(c-V_{abs})] \\ &= c (c-V_{abs}) / f (c-2V_{abs}) = 1/f \cdot [c (c-V_{abs}) / (c-2V_{abs})] \end{aligned}$$

One would expect the 'wave length' of the reflected light to be equal to $(c + V_{abs}) / f$, because the 'wavelength' of incident light is $(c - V_{abs}) / f$. However, it turned out in the above analysis that this is not the case. However, it can be shown that the actual difference between the two is

very small.

The absolute velocity of the earth is known to be $V_{abs} = 390 \text{ Km/s}$

$$\begin{aligned} \lambda_{REF} &= 1/f \cdot [c (c - V_{abs}) / (c - 2V_{abs})] \\ &= 1/f \cdot [300,000 (300,000 - 390) / (300,000 - 2 \cdot 390)] \\ &= 1/f \cdot 300,391 \text{ Km} \end{aligned}$$

According to $1/f \cdot (c + V_{abs})$ it will be

$$1/f \cdot (300,000 + 390) = 1/f \cdot 300,390 \text{ Km}$$

The difference between the two apparent velocities is only 1 Km/s , which is only about 0.25% of 390 Km/s .

Therefore, the 'wave length' change detected in the Silvertooth experiment has been justified above. However, this is not to be interpreted as a change of wave length. It should be interpreted as change in path length resulting from absolute motion.

In the above analyses, we considered the simplest cases in which the source, the observer and the mirror are in line and move along this line, with the light beam incident perpendicularly on a mirror and reflected back on itself. It is possible to extend the analysis to more general cases for a better clarification of the theory. In the next section we will look at the application of the new theory to some of these cases. As the resulting solutions are more complicated (but straight forward), we will show only how to proceed.

Let us look at a case in which the source observer relative position is perpendicular to the absolute velocity.

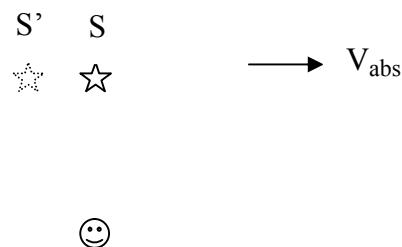

From previous discussion

$$t_d = D' / c = (D / (c^2 - V_{abs}^2)^{1/2})$$

If the source emits according to

$$\sin \omega t$$

then the light received will be

$$\sin(\omega t - t_d)$$

Next consider the following case, as in Doug Marett's replication of Silvertooth experiment [3].

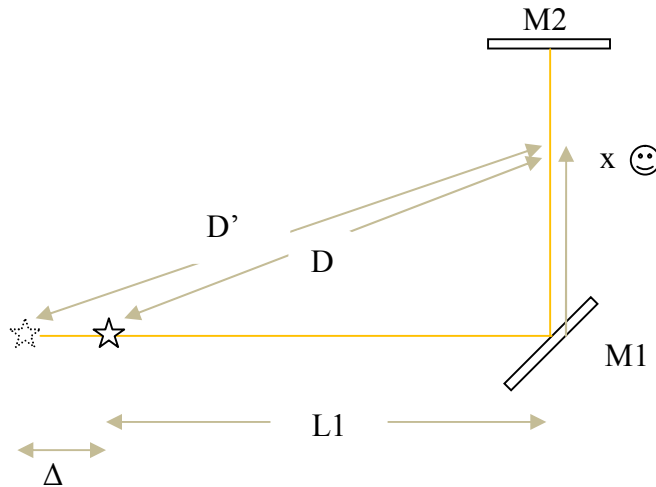

An observer at point x will observe the incident light (light reflected from mirror $M1$, but before reflection from mirror $M2$) and the reflected light (light reflected from mirror $M2$).

To analyze this problem, we first have to determine the change (Δ) in apparent position of the source due to absolute motion.

$$t_d = (\Delta + L1 + x) / c$$

But

$$D' / c = \Delta / V_{abs}$$

The above equation means that the time it takes a *direct* light beam to reach the observer from the apparent source position is equal to the time it takes for the source to move from position S' to position S . Note that we have assumed a direct light beam from point S' to point x to determine the apparent change in the position of the source for an observer at point x , even though there is no direct light beam from the source to the observer in this case (i.e. the observer observes only light reflected from mirror $M1$ in the case being considered)

Also

$$(\Delta + L1)^2 + x^2 = D'^2$$

and

$$L1^2 + x^2 = D^2$$

From the above three equations, the solution for Δ can be obtained as follows.

$$(\Delta + L1)^2 + x^2 = D'^2$$

$$(\Delta + L1)^2 = c^2 \Delta^2 / V_{abs}^2 - x^2$$

resulting in the quadratic equation

$$\Delta^2 (c^2 / V_{abs}^2 - 1) - \Delta (2L1) - (L1^2 + x^2) = 0$$

The solution for delta will be

$$\Delta = [2L1 + [4L1^2 + 4(c^2 / V_{abs}^2 - 1)(L1^2 + x^2)]^{1/2}] / 2(c^2 / V_{abs}^2 - 1)$$

Now the time delay t_d can be obtained in terms of x from the previous equation:

$$t_d = (\Delta + L1 + x) / c$$

The solution for Δ shows that time delay varies with x in a more complex way.

The term under square root should be expanded .

It can be seen that the time delay does not depend on x but on higher powers of x . This results in dependence of 'wavelength' on x .

For reflected light the equation for time delay t_d will be :

$$t_d = (\Delta + L1 + x + 2(L2 - x)) / d$$

The equation for Δ obtained above should be substituted in the above equation to determine the time delay and hence the 'wave length ' of the reflected light.

Argument against ether hypothesis

Absolute space and absolute motion exist, but the ether doesn't.

Until the beginning of the twentieth century, the hypothetical ether was thought as a medium for transmission of light, just as water is the transmission medium of water waves and air is the medium for sound transmission. The ether hypothesis was decisively ruled out by the historical Michelson-Morley experiment.

One of the assumed properties of ether was that it had no interaction with cosmic bodies and with all matter. Now, based on this assumed property of the ether, one can show that the ether hypothesis is not plausible at all.

If the ether doesn't interact with matter, then it is not affected by the presence of matter. We find it everywhere, including inside solid objects.

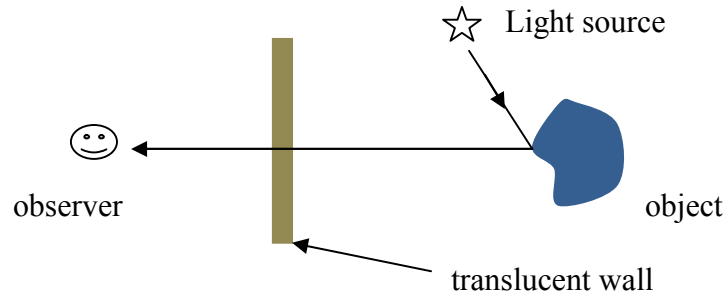

Since light is only a travelling disturbance (oscillation) of (on) the ether, then an observer would see an object behind a translucent wall, since the wall would have no effect on light (which is assumed to be an ether wave). If the translucent wall has no effect on the ether, then it would also have no effect on the ether wave. But this is not all. Even we would not be able to see any object because the ether (and the ether wave, which was assumed to be light) does not interact with our eyes also. There would be no vision. Light would not interact with matter at all. So the ether hypothesis, as it is known so far, is absurd.

'Anomalous' radar range data from Venus planet as dicovered by Bryan G. Wallace

One of the observations that seem to be in contradiction with Einstein's light postulate is the discovery by Bryan G. Wallace that analysis of radar range data of planet Venus did not conform to the principle of constancy of the speed of light.

The analysis of Bryan G. Wallace's experiment belongs to this section of co-moving source and observer because the source (RF transmitter) and the observer (RF receiver) are co-moving as both are bound to the earth. The planet Venus acts as a mirror moving relative to the earth. The effect of earth's absolute velocity is negligible in creating an apparent change of position of the RF transmitter as 'seen' by the RF receiver because they are located at nearly the same location and because the distance to Venus is much greater than the distance between the transmitter and the receiver, which may be, at most, not more than a few tens of meters.

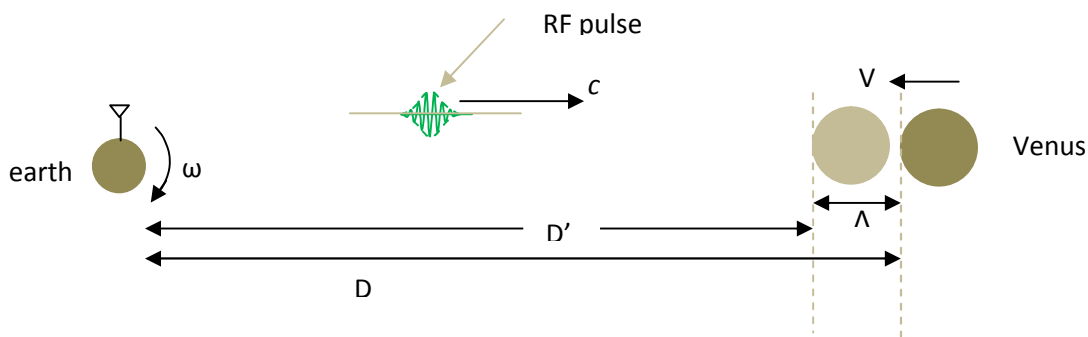

According to Special Relativity Theory (SRT), the center of the wave fronts of the transmitted RF pulse remains at the point in space where the source was at the instant of emission. According to this paper, the center of the wave fronts moves with the (apparent) source, for a constant source observer velocity. In this case, there is no significant difference between the real and the apparent positions of the source (the transmitter / antenna).

The procedure of analysis is:

1. Replace the real source with the apparent source
2. Then analyze the problem as if the earth is at rest, with Venus acting as a mirror moving relative to the earth.

Suppose that at the instant of the bouncing of the RF pulse from Venus surface the distance between the Earth and Venus is D and the Earth – Venus relative velocity is V .

The round trip time can be determined if we know the velocity of the RF pulse in the earth's reference frame (which we have already assumed to be an absolute reference frame, according to step 2 above). The velocity of the transmitted RF pulse is obviously equal to c relative to the transmitter. The velocity of the reflected pulse will be $c + 2V$, relative to the earth again.

Therefore, the total round trip time is determined as:

$$t = t_1 + t_2 = D/c + D / (c+2V) = D (2c + 2V) / [c (c + 2V)]$$

$$\Rightarrow D = (t/2) \cdot c \cdot (c + 2V) / (c + V)$$

where t_1 is the forward flight time, t_2 is the backward flight time and t is the round trip time of the pulse.

The distance at the instant of reception of the pulse on earth will be:

$$D' = D - \Delta = D - t_2 \cdot V$$

But

$$t_1 = D/c \quad t_2 = D / (c + 2V) \quad \text{and} \quad t_1 + t_2 = t$$

From which

$$t_2 = (t/2) \cdot [c / (c + V)]$$

Therefore,

$$D' = D - t_2 \cdot V = t \cdot c/2$$

In the case of Einstein's light postulate this would be:

$$D' = tc/2 - tv/2$$

Source and observer in absolute and relative motion. Why/how experiments failed to detect any dependence of the velocity of light on the velocity of the source.

In all our discussions so far, we have been considering the special case of (absolutely) co-moving source and observer. Hence, the source and the observer had equal (common) absolute velocities and there would be no relative motion between them.

In this section, we seek a way to formulate a general interpretation of absolute motion, which can be applied to the general case of source and observer having independent, arbitrary absolute velocities, differing in magnitude and/or direction, and hence also moving *relative* to each other. This problem involves a ‘mixture’ of absolute and relative velocities.

We already have at our hand the interpretation of the special case of co-moving source and observer. How can we go from this specific interpretation to a general interpretation?

After a considerable effort, a general formulation of the new theory was discovered.

Source in absolute motion and observer at absolute rest

Let us first consider the simple case in which only the source is in absolute motion, with the observer at absolute rest.

The effect of absolute motion of a light source is to create an apparent change of position of the light source as seen by an observer at absolute rest.

Assume an observer that is at absolute rest and an absolutely moving source. The source was at distance D from the observer, *at the moment of emission*.



$$D' / c = \Delta / V = (D - D') / V$$

$$\Rightarrow D' = D \cdot c / (c + V)$$

$$\Rightarrow dD' / dt = V' = (dD/dt) \cdot [c / (c + V)] = V \cdot [c / (c + V)]$$

$V' = V \cdot [c / (c + V)]$, for a light source absolutely moving away from an observer at rest

$V' = V \cdot [c / (c - V)]$, for a light source absolutely moving towards an observer at rest

The above equation shows the relationship between the velocity (V) of the real source and the

velocity (V') of the apparent source.

The apparent source is not moving towards an observer with the same velocity as the real source. This has implications on Doppler effect of light. *The Doppler shift for a light source moving absolutely away from a stationary observer will be 'less red' ; and it will be 'more blue' for a light source moving towards an observer. This means that the whole Doppler frequency change will shift towards blue, i.e. more blue than classical prediction, which assumes a medium for light transmission.*

Therefore, to get the Doppler shift due to motion of the source, we substitute V' for V in the Doppler shift formula derived in the previous section for a stationary source and a moving observer (assuming that that analysis is the same for a moving source and stationary observer).

From the above derivation, a new theory of light speed is proposed:

*The velocity of light is c relative to the apparent source.
The group velocity of light is equal to*

$$c + V' = c + V \cdot [c / (c + V)]$$

relative to absolute reference frame, for a source moving with an absolute velocity V towards an observer at absolute rest.

In this case also the phase velocity of light does not depend on the velocity of the source. We saw that motion of the observer does not change the phase of light: both a stationary and a moving observer see a phase point simultaneously. Therefore, the same should be true for a moving source. Motion of the source should not affect the phase velocity of light.

This postulate may explain the absence of fringe shifts expected from existing emission theories in moving source and moving mirror experiments, such as the Q.Majorana, Albert Michelson, Tolman, Miller, experiments.

The distinctive idea in this paper can be restated as follows.

Assume two observers A and B, both at absolute rest, with distance between them equal to D .

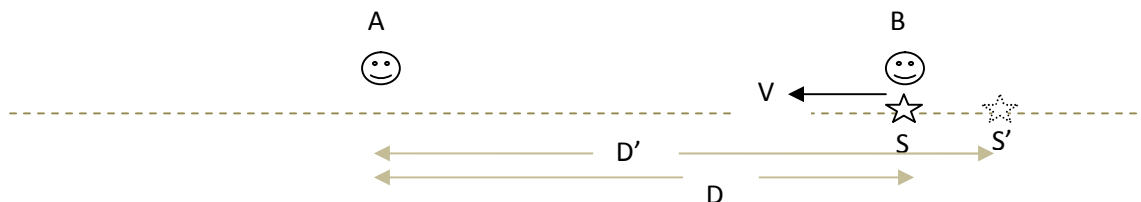

A light source is moving towards observer A. Assume that the source emits a very short light pulse just at the moment it is passing by observer B, as seen by observer B. The light pulse will be seen by observer A after a delay of time. A key idea introduced in this paper is as follows:

For observer B, the light beam was emitted from its own position, from point S. For observer A, however,

the light beam was emitted from the apparent source position, point S'.

Obviously, this is counterintuitive and will be the 'price' we have to pay if we have to accept the new theory.

However, there is a plausible way to solve this contradiction as shown in the next figure, and this has already been explained in a previous section.

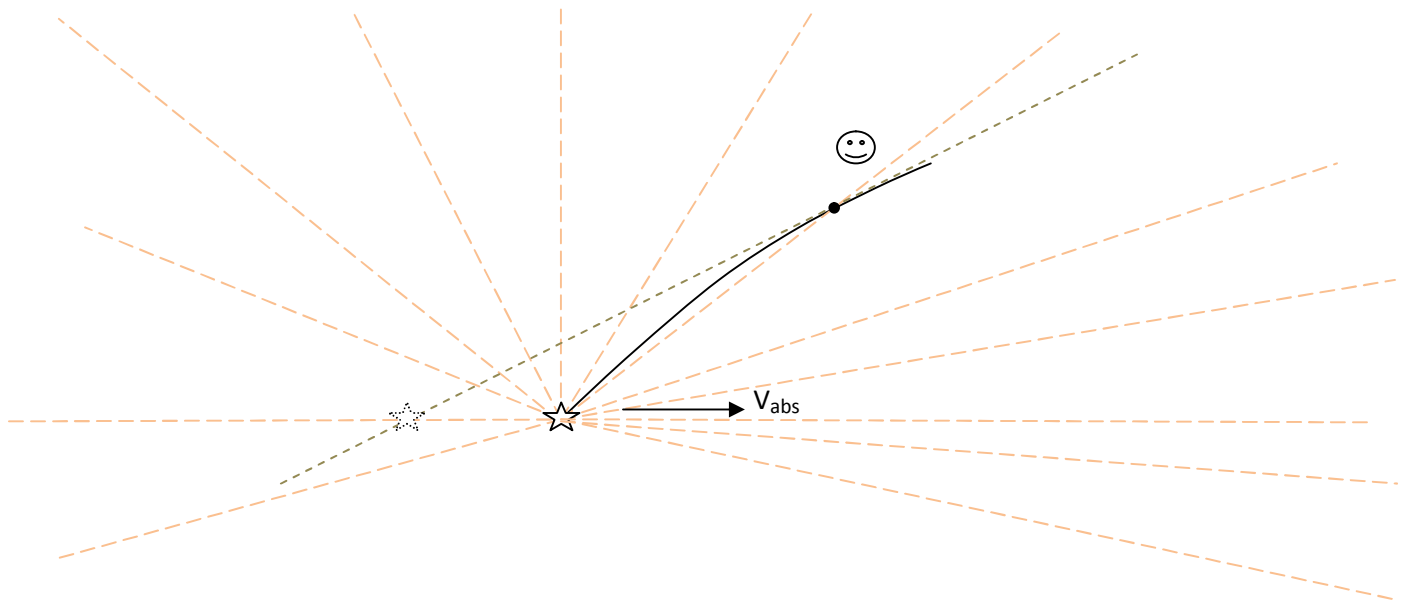

Both source and observer in absolute and relative motion



From previous analyses

$$D' = D \cdot c / (c - V_{absS}) \Rightarrow dD'/dt = V' = dD/dt \cdot c / (c - V_{absS}) = V \cdot c / (c - V_{absS})$$

where V is the source observer relative velocity.

But

$$V = V_{absS} - V_{absO} \text{ , for } V_{absS} > V_{absO}$$

The time delay τ between emission and observation of light is:

$$\tau = D' / (c + V')$$

(the plus sign is because the source and observer are approaching each other)

Substituting the previous values for D' , V' and V,

i.e. $D' = D \cdot c / (c - V_{\text{absS}})$, $V' = V \cdot c / (c - V_{\text{absS}})$, $V = V_{\text{absS}} - V_{\text{absO}}$

we get

$$\tau = D / (c - V_{\text{absO}})$$

We see that the (absolute) velocity of the source V_{absS} does not appear in the above equation.

Let us consider a case in which the observer's absolute velocity is directed towards the source and the source and observer are receding away from each other.

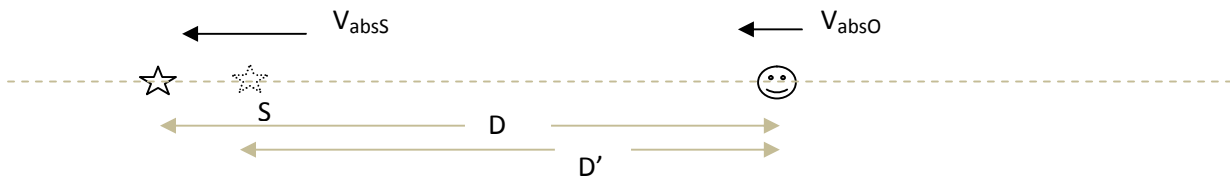

In this case

$$D' = D \cdot c / (c + V_{\text{absS}}) \Rightarrow dD'/dt = V' = dD/dt \cdot c / (c + V_{\text{absS}}) = V \cdot c / (c + V_{\text{absS}})$$

where V is the source observer relative velocity.

But

$$V = V_{\text{absS}} - V_{\text{absO}} \text{ , for } V_{\text{absS}} > V_{\text{absO}}$$

The time delay τ between emission and observation of light is:

$$\tau = D' / (c - V')$$

(the minus sign is because the source and observer are receding away from each other)

Substituting the previous values for D' , V' and V ,

i.e. $D' = D \cdot c / (c + V_{\text{absS}})$, $V' = V \cdot c / (c + V_{\text{absS}})$, $V = V_{\text{absS}} - V_{\text{absO}}$

we get

$$\tau = D / (c + V_{\text{absO}})$$

The above analysis can be applied to any combination of magnitude and direction of source and observer absolute velocities, with the source and observer moving *directly* (radially) towards each other or receding directly away from each other, with no transverse component of their relative velocity.

In general,

$$\tau = D / (c \pm V_{\text{absO}})$$

We see that the (absolute) velocity of the source, V_{absS} , does not appear in the above equation.

From the above equation we see that the velocity of light as determined experimentally (D/τ) is

$$D/\tau = c \pm V_{\text{absO}}$$

We see that the measured speed of light is independent of the absolute velocity of the source V_{absS} , which is in agreement with experiments and observations.

The (*group*) velocity of light, however, depends on the absolute velocity of the observer V_{absO} .

Why did many experiments fail to detect dependence of the speed of light on the speed of its source ? And, on the contrary, why did radar range data of planet Venus (as analyzed by Bryan G.Wallace) support the emission theory ?

This section is just a restatement of the last section, to emphasize how the new theory resolves the paradoxes.

Many experiments and observations failed to detect any dependence of the speed of light on the speed of its source. These include: the Albert Michelson moving mirror experiment, the Q. Majorana moving mirror and moving source experiments, experiments using sun light and star light (Tolman, Miller,), experiments using elementary particles (such as positron in annihilation in flight) moving with speeds comparable to the speed of light as sources of radiation. There is also the de Sitter's binary star argument.

On the other hand, Bryan G. Wallace discovered that analysis of radar data of planet Venus showed a result that appeared to agree with emission theory than (Einstein's) postulate of constant speed of light.

In this section we see the mystery behind all these divergent empirical evidences. We use the same postulate we have been applying so far:

The effect of absolute motion of a light source is to create an apparent change in its position relative to an observer.

We repeat the analysis presented already in a previous section. Assume an observer at absolute rest, with a light source moving with absolute velocity V towards him/her, as shown below.

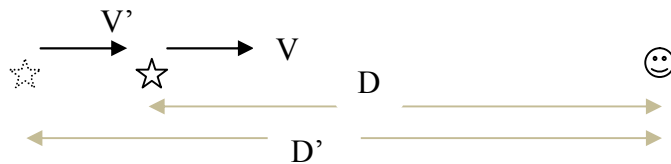

$$(D' - D) / V = D' / c \Rightarrow D' = D \cdot c / (c - V)$$

$$\Rightarrow dD'/dt = V' = Dd/dt \cdot c / (c - V) = V \cdot c / (c - V)$$

$$\tau = D' / (V' + c) = [D \cdot c / (c - V)] / [V \cdot c / (c - V)] = D/c$$

where τ is the time delay of a light pulse emitted by the source before it is seen by the observer. To the observer, the source appears to be at distance D' . The velocity of the light pulse is c relative to the apparent source, so its velocity relative to the observer will be:

$$V' + c = [V \cdot c / (c - V)] + c = c^2 / (c - V)$$

This is different from existing emission theories in which the velocity of light is $c + V$ relative to an observer, for a light source moving towards the observer.

In the above analysis an absolutely moving source and an observer at absolute rest were assumed. Recall that it has been shown in the previous section that the velocity of light is independent of the source's absolute velocity in the general case in which the source and the observer have independent, arbitrary absolute velocities.

Thus the new theory is a fusion of the absolute space (ether) and emission theory (and Einstein's light postulate).

Transverse relative motion between source and observer

In the preceding section, the source observer relative velocity was assumed to have no transverse component. The following figure shows both radial and transverse relative velocity components.

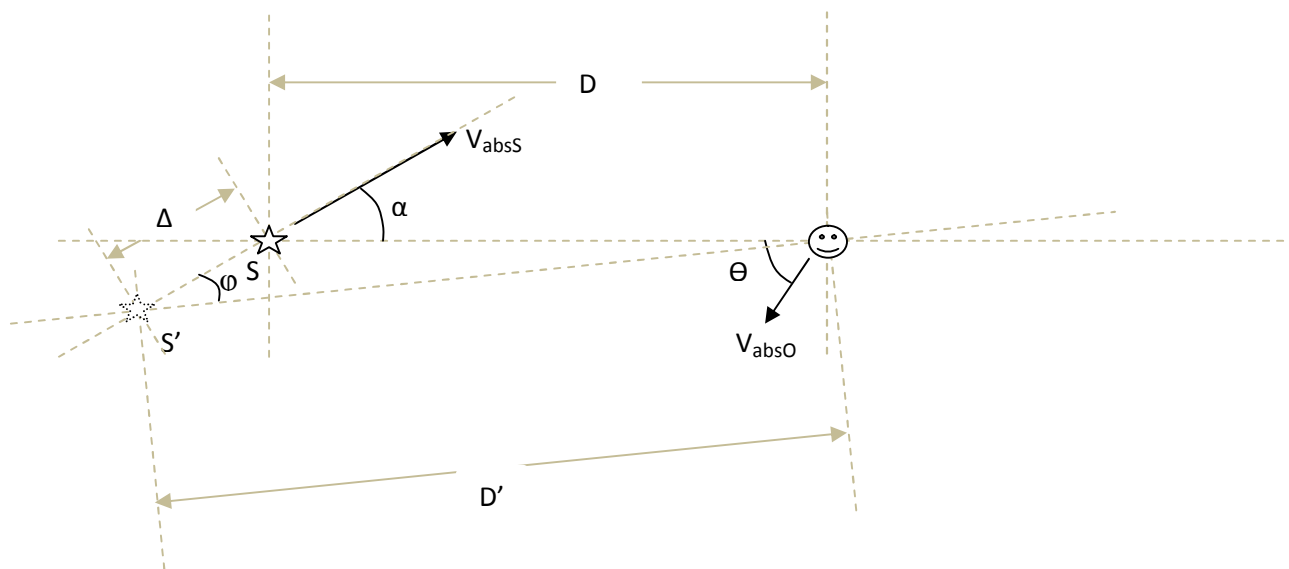

$$(\Delta \cdot \cos \alpha + D)^2 + (\Delta \cdot \sin \alpha)^2 = D'^2 \dots\dots\dots (1)$$

$$\Delta / V_{\text{absS}} = D' / c \dots\dots\dots(2).$$

$$V = V_{\text{absS}} \cdot \cos \alpha + V_{\text{absO}} \cdot \cos \Theta \dots\dots\dots(3)$$

where V is the source observer relative velocity.

Determine D' and Δ from the first two equations. From the equation for the expression of D' in terms of D, determine the expression for V' in terms of V (by differentiating both sides). V will have radial and transverse components. Then determine the time delay between emission and observation as:

$$\tau = D' / (c + V'_r) , \text{ where } V'_r \text{ is the radial velocity component of the apparent source.}$$

Stellar aberration

The phenomenon of stellar aberration, as observed from the earth, involves the absolute and relative velocities of both the star and the earth. We are certain that the earth is in absolute motion (390 Km/s), but the stars are also most probably in absolute motion.

In this section, however, we analyze the phenomenon of stellar aberration by assuming two simple cases:

- star in absolute motion and observer at absolute rest
- star at absolute rest and observer in absolute motion

Star at absolute rest and observer in absolute motion

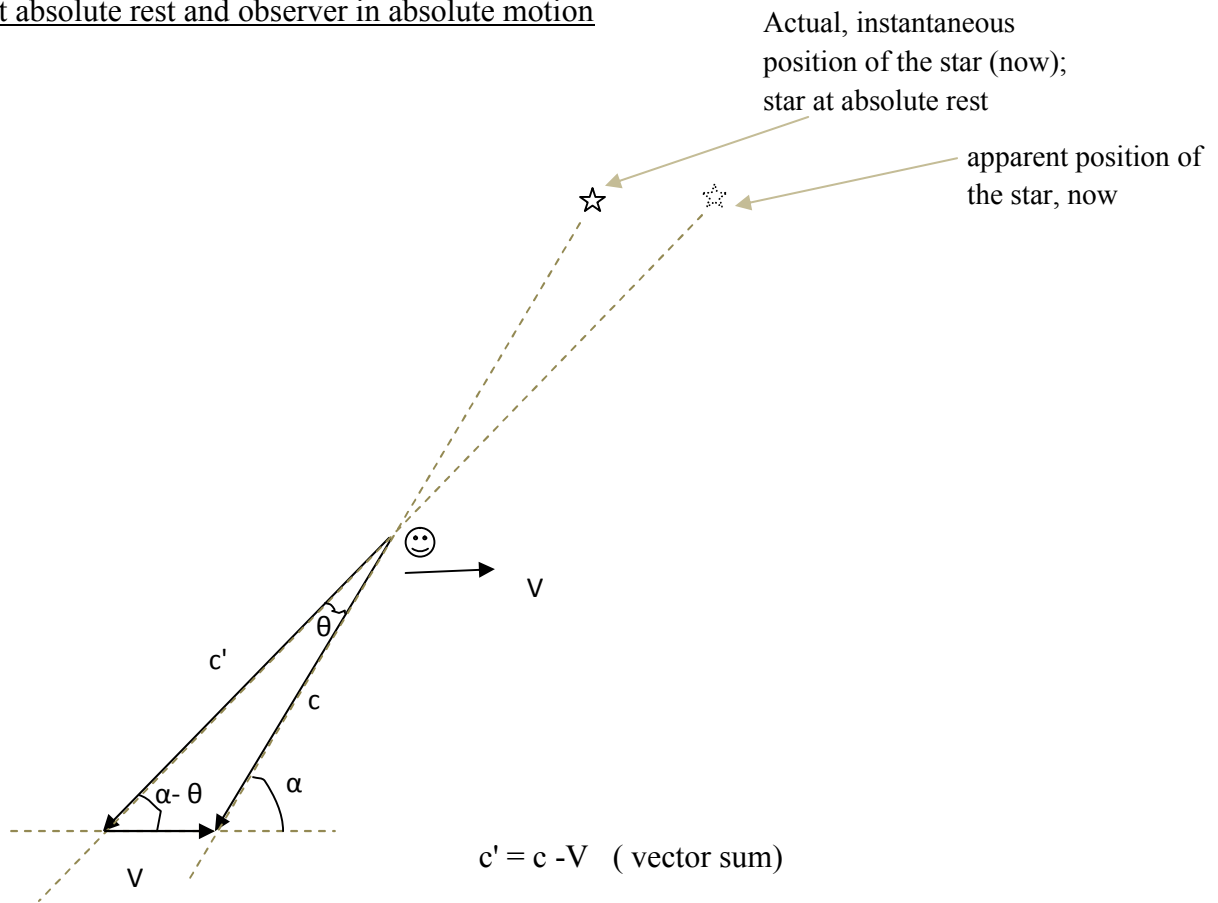

$$(\sin \theta) / V = \sin (180 - \alpha) / c' = \sin (\alpha - \theta) / c \quad \text{and} \quad \sin \theta \approx \theta \quad (\text{for small angle } \theta)$$

$$(\sin \theta) / V \approx \theta / V \approx (\sin \alpha) / c \Rightarrow$$

$$\theta = (V/c) \cdot \sin \alpha$$

This is the kind of aberration known as Bradley aberration. In this case, aberration is due to the difference between the actual (instantaneous) and apparent position of the star, caused by the

motion of the observer. In this case star light aberration is an apparent change of current (instantaneous) position of the star.

Note that, however, in the aberration observed by Bradley the star itself is not necessarily at absolute rest. The effect of absolute motion of the observer is ‘superimposed’ on the effect of absolute motion of the star. Quantitative treatment of this should not be difficult.

Star in absolute motion and observer at absolute rest

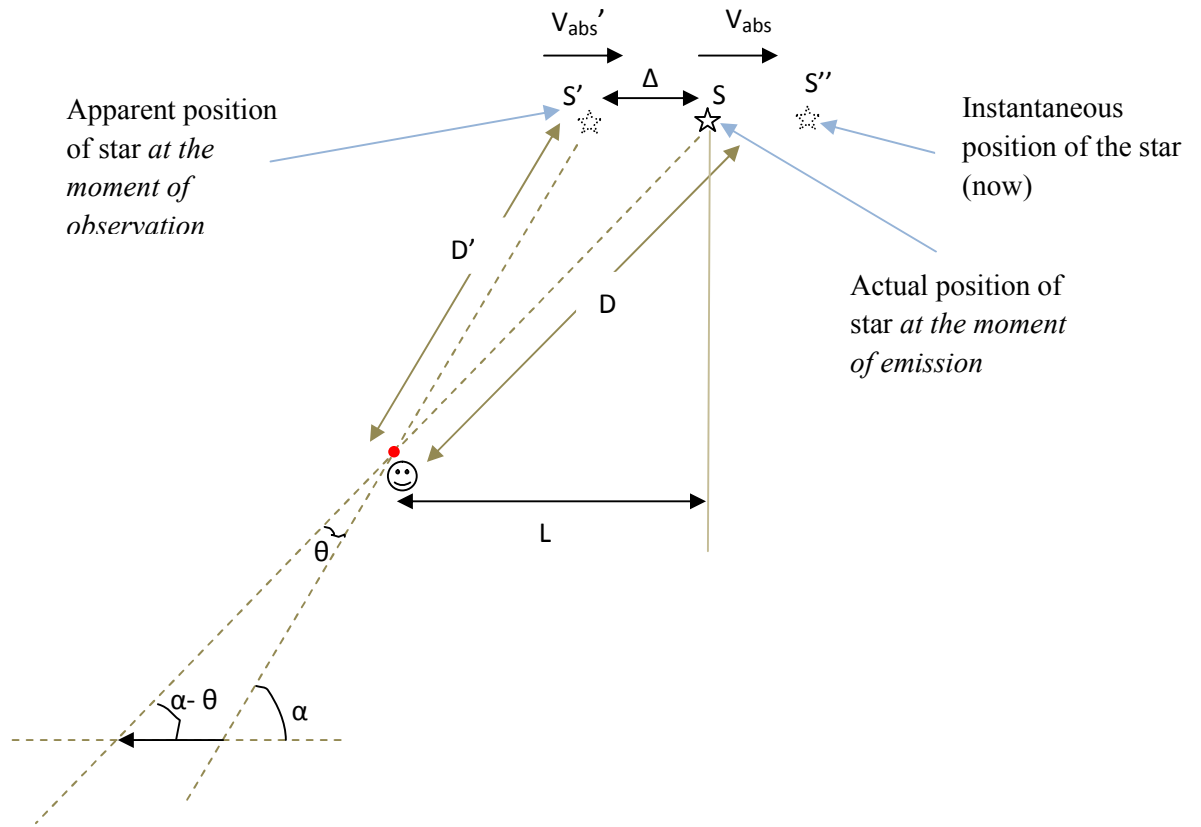

$$D' / c = \Delta / V_{abs} \dots\dots\dots (1)$$

$$D'^2 + (L - \Delta)^2 = D^2 - L^2 \dots\dots\dots (2)$$

From the above two equations, D' and Δ can be determined (it is a lengthy formula), and then the angle of aberration θ can be determined. Note that angle θ is due to a difference in the actual past position of the star and its apparent past position, as seen at the time of observation. Its current (instantaneous) position has no role in the explanation of stellar aberration as proposed in this paper.

For better clarification, suppose that the star is one light year away from the observer. Actually, the star emits light from position S . The observer sees the light after one year. It appears to the observer that the star emitted light from position S' *one year ago*, and not from position S . The current (instantaneous) position S'' of the star will have no relevance. For the case of an absolutely moving star, light aberration is an apparent change of the past position of the star.

Although the star *actually* emitted light from position S one year ago, it appears to the observer, at the time of observation (i.e. after one year), that the star emitted light one year ago from position S', and not from position S.

(In the case of absolutely moving observer and star at absolute rest (preceding section), light aberration is an apparent change of current (instantaneous) position of the star) .

This kind of star light aberration is due to the star's absolute motion. Therefore, even if an observer is at absolute rest, the observed position of stars may not be their actual past position. Theoretically, it is possible to know if a star is in absolute motion or not, and its absolute velocity. If the position of the star appears to change as the (stationary) observer changes his/her distance from the star, then the star is known to be in absolute motion. If the star is at absolute rest, then its position will not change apparently as the observer distance decreases or increases.

Interpretation of Einstein's light postulate: Relativity of electromagnetic waves

Imagine an observer moving towards or away from a light source that is at *absolute rest*. Maxwell's equations predict that the speed of light should always be the same, whether the observer is at rest or in motion relative to the source, as interpreted by Einstein as the light postulate. Such a conclusion comes from the non-existence of the ether. But how can two observer measure the same speed of the same light beam, coming from the same source?

Einstein was right when he called the light postulate a postulate. There is no proof of it but only an interpretation. SRT was Einstein's interpretation of the light postulate. This paper proposes an alternative interpretation.

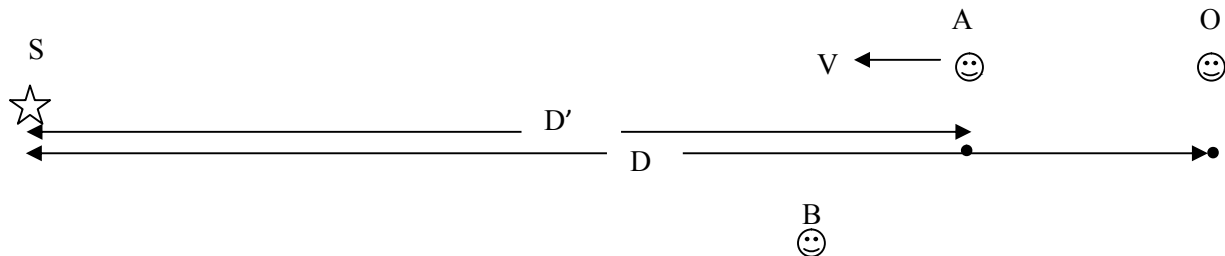

Assume an absolutely stationary light source S and two observers, observer O who is also at rest and observer A who is moving towards S. Assume also that there is a third stationary 'observer' B. Observers O and A report to observer B the time they received a light pulse. Suppose that at an instant of time, S is emitting a short light pulse while observers O and A are at the same distance D from the source, but with observer A moving with velocity V towards S at that instant of time. Observer O will obviously receive the light pulse after a time delay of D/c . Straight forward thinking tells us that observer A should detect the light pulse earlier than observer O, because A is moving towards S.

For light, however, this should not be the case because it would violate the constant light speed postulate implied by Maxwell's equations and the non-existence of the ether.. Both observers O and S should receive the light pulse simultaneously, and this is the new interpretation of

Einstein's light postulate and Maxwell's equations. It is as if the light slows down for observer A. This is the only way a third stationary 'observer' B can account for this. Let us call the velocity of light relative to its source for observer A as c' .

During the time (D/c) that the light pulse travels from S to O, observer A will also have advanced towards the source by a distance of $V \cdot D/c$, relative to O. If we postulate that the time delay for both observers is the same, then

$$\begin{aligned} \text{time delay for O} &= \text{time delay for A} \\ D/c &= (D - V \cdot D/c) / c' \end{aligned}$$

From which,

$$c' = c - V$$

Note that c' is the velocity of light relative to its source, for observer A. Therefore, 'observer' B predicts the velocity of light relative to observer A as the sum of c' and V .

$$\text{Velocity of light relative to observer A} = c' + V$$

But $c' = c - V$ (previous equation). So substitute in the above equation

$$\text{Velocity of light relative to observer A} = c' + V = (c - V) + V = c$$

Therefore, the velocity of light relative to observer A is still equal to c . Even though observer A is moving towards the light pulse, light will not go faster than c relative to him/her. The velocity c' is an apparent velocity and is not a physically accessible (measurable) quantity.

A similar analysis can be done for an observer moving away from the source.

Suppose that, instead of a short light pulse, the source emits a sinusoidal continuous light wave.

As before, assume that observers O and A are at the same distance D from the source S, at an instant of time. Assume also that observer A is moving towards S with velocity V and source S is just emitting a peak point P on the wave. Therefore, both observers will detect the peak point P simultaneously.

The below diagram is a frozen or snapshot pictures of the wave as seen by observer O (green wave) and by observer A (blue wave). We see that the wave should spatially be compressed towards its source for observer A, if observer A is to see peak point P' at the same instant observer O is seeing peak point P. Peak point P on the green wave for observer O corresponds to peak point P' on the blue wave for observer A.

From the above diagram, the number of frozen wave cycles (n) in the space between stationary observer O and the source is equal to the number of frozen wave cycles (n) in the space between observer A and the source.

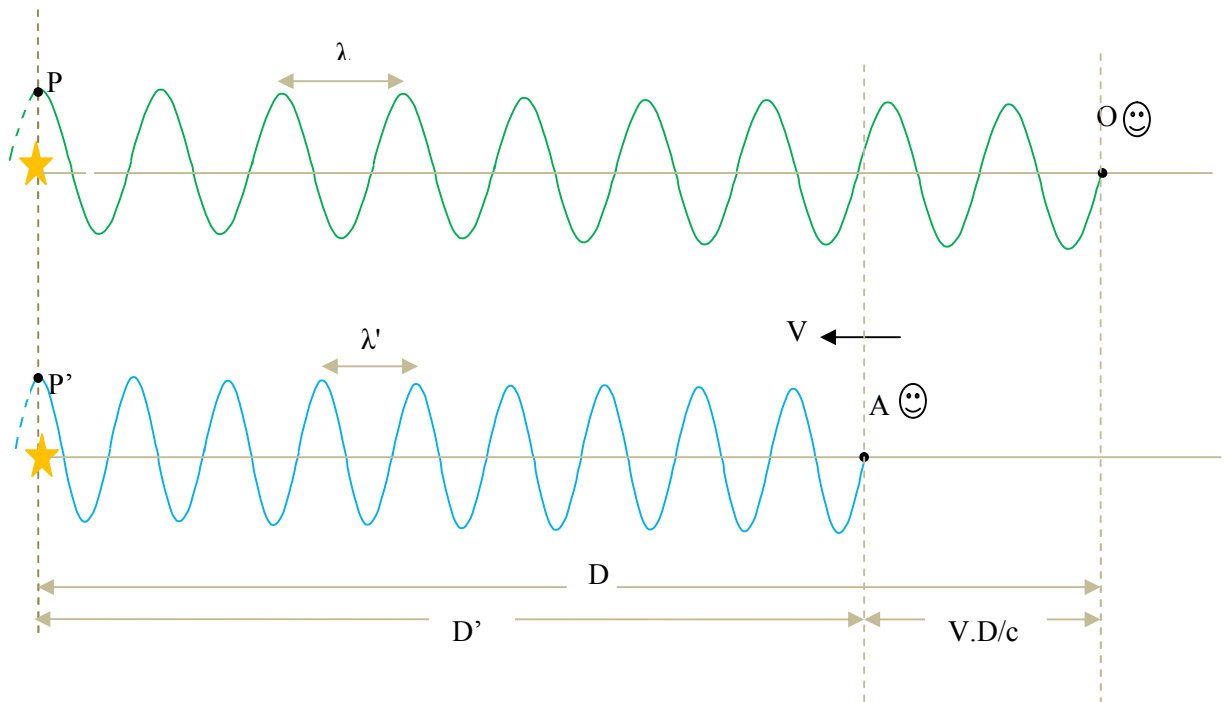

So we see that observer A sees a Doppler blue shifted form of the wave seen by observer O. We will determine the Doppler wavelength and frequency shift.

$$n \cdot \lambda - n \cdot \lambda' = v \cdot D/c$$

$$n (\lambda - \lambda') = v \cdot D/c$$

But, $n = D / \lambda$

Therefore,

$$(D/\lambda) (\lambda - \lambda') = v \cdot D/c$$

From which,

$$\lambda - \lambda' = \lambda \cdot v/c$$

$$\Delta \lambda = \lambda \cdot v/c \quad \text{and} \quad \lambda' = \lambda \cdot (c-v)/c$$

The Doppler frequency shift :

$$f' = c/\lambda'$$

$$= c/\lambda \cdot c/(c-v) \quad (\text{substituting for } \lambda' \text{ from above equation})$$

And

$$\Delta f = f' - f = f \cdot v/(c-v)$$

In Doppler effect of sound or water waves, wave length is fixed and is independent of the

observer's velocity, and the velocity of the wave will be $c_s \pm V$ relative to the observer, where c_s is the velocity of the sound or water wave and V is the velocity of the observer, both relative to the medium. Unlike the Doppler effect of sound and water waves, in Doppler effect of light, the wavelength changes and the speed remains constant. The new interpretation is restated as follows.

The apparent velocity c' of light relative to the source changes by the same amount of the source observer relative velocity V so that the velocity of light is always constant c relative to the observer. For an observer moving directly towards a light source, the light wave contracts towards the source so that the apparent velocity c' of light relative to the source will be $c-V$. The velocity of light relative to the observer will be $(c-V) + V = c$. The velocity c' is an apparent velocity because it is not a physically measurable velocity. For an observer moving at constant velocity directly (radially) away from a light source, the apparent velocity c' of light relative to the source will be $c + V$, so that the velocity of light relative to the observer will be $(c+V) - V = c$.

The consideration of the Doppler effect of light and the light postulate (Einstein's thought experiment: 'chasing a beam of light') give a hint on the correct interpretation of the light postulate.

Locally constant phase velocity and locally variable group velocity of light - a new theory

In the preceding section a theory which can successfully interpret the light postulate was proposed. This is a great success because we didn't resort to any such extraordinary claims as 'length contraction' and 'time dilation'. It was shown that frequency and wavelength change for an observer moving relative to a light source that is at absolute rest, such that the speed of light is always constant relative to an observer.

$$f \cdot \lambda = c = f' \cdot \lambda'$$

However, the new theory proposed is still counterintuitive. Logically, an observer moving towards a light source should detect a light pulse (or a peak point, as in our previous discussion) earlier than a stationary observer. The hypothesis that the two observers O and A (refer to preceding section) detect a light pulse (or peak point P) simultaneously is not only counterintuitive but also is not in accordance with experiments and observations.

Should we discard the new theory then? But we have successfully interpreted the light postulate with it! Therefore, we should keep the new theory and try to reconcile it with logic and observations.

It took me more than one year to discover the missing idea. The 'new' idea is not really new : *phase velocity and group velocity*.

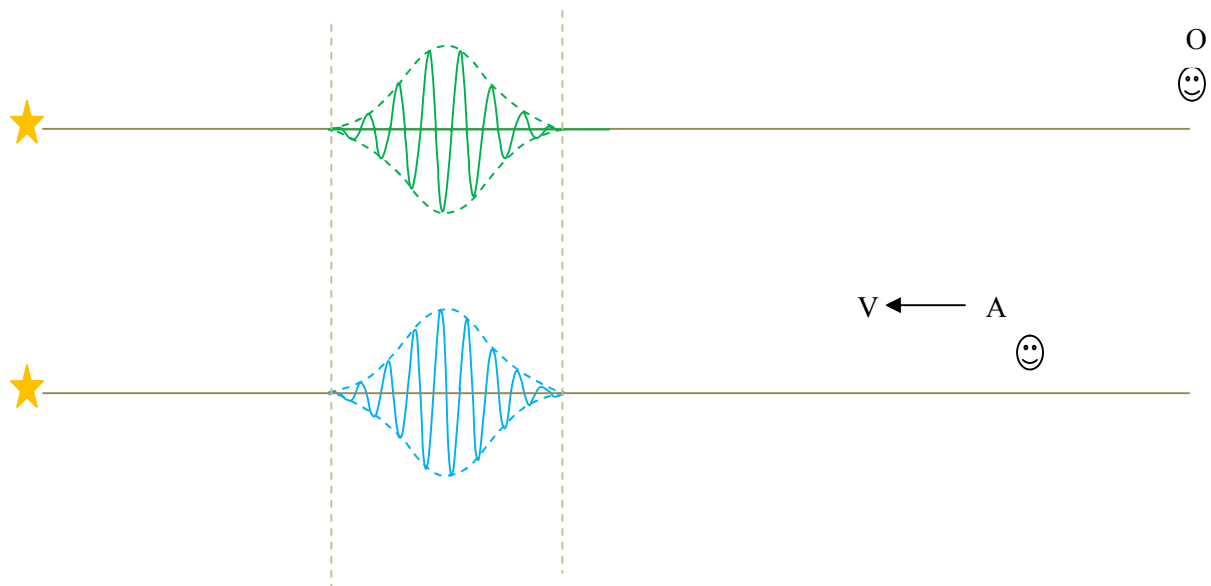

Observer A who is moving towards the light source should logically detect the light pulse earlier than the stationary observer O. However, observer A should observe a spatially compressed form of the wave observed by stationary observer O.

Here is the distinction:

Even though the (sinusoidal) waves are compressed, the envelop or the group is not compressed.

Note the slight compression of the blue sinusoidal waves as compared to the green sinusoidal waves, but that the two envelopes have the same width, in the figure above.

One implication here is that there is no conservation of the number of wave cycles in an envelope ?? (This might be a problem?). This may be counterintuitive. But at least we also know that any waveform can be seen as a Fourier series, containing sinusoidal waves at different frequencies, extending from minus infinity to plus infinity, in time.

Thus, as the observer A moves towards the light source, the phases will be spatially compressed, but the envelope is unchanged, i.e not compressed.

In a previous theory I proposed, both the sinusoidal wave and the envelop were postulated to be compressed, and this had counter intuitive implications which were not in agreement with experiments and observations.

For the stationary observer O, the phases are at rest relative to the envelope. However, for observer A, the phases are moving relative to the envelope.

It is the velocity of the phases which remains constant relative to the observer (and independent of source velocity), and not the velocity of the envelope (the group). The velocity (c') of the

phases apparently changes relative to the source, so that their velocity relative to the observer remains constant (c), i.e. $c' + V = c$ (vector sum).

The group velocity is 'ballistic' and not constant *relative to the observer*.

As determined in the preceding section, the Doppler frequency shift observed by observer A is:

$$\Delta f = f' - f = f \cdot V / (c - V)$$

Similar analysis can be done for an observer moving away from a light source.

Therefore, a complete and successful alternative interpretation of Einstein's light postulate has been developed. The constant c in Maxwell's equations has been interpreted

1. as a phase velocity relative to an observer
2. as group velocity of light pulse from source to observer, in the absolute reference frame

Assume a source at absolute rest, to avoid the 'complications' of a moving source.

The group velocity is determined as:

$$c = D/t$$

where D is the distance between source and observer *at the instant of observation* and t is the time elapsed between emission and observation.

The phase velocity is:

$$c = f \cdot \lambda$$

New light speed postulate

The findings are summarized as follows:

The phase velocity of light is locally constant, independent of the velocity of the source and the observer.

The group velocity of light is locally variable, varies with the absolute velocity of the observer but not varying with source absolute velocity.

The velocity of light is c relative to the apparent source, where c is the local velocity of light.

The velocity light reflected from a mirror is always equal to the velocity of the incident light, irrespective of the motion of the mirror.

Some experimental evidences for the variable group velocity of light, varying with observer's absolute velocity:

Ole Roamer observed that the eclipse time is longer when the earth is moving away from Jupiter than when it is moving towards Jupiter, by about 22 minutes. This can be seen as the effect of absolute motion of the observer.

The other experimental evidence that the group velocity of light depends on the observer absolute velocity is the observation made by Bryan G Wallace of radar data reflected from planet Venus. Wallace's observation shows that the group velocity of light depends on the absolute velocity of the observer.

A new result for Einstein's light speed thought experiment

Imagine a light source that is at absolute rest and an observer moving away from the source at the speed of light, as Einstein imagined in his thought experiment. Assume that the observer was at the source position but moving away at the speed of light at an instant of time $t=0$. Assume that the source emits a light pulse at this same instant of time.

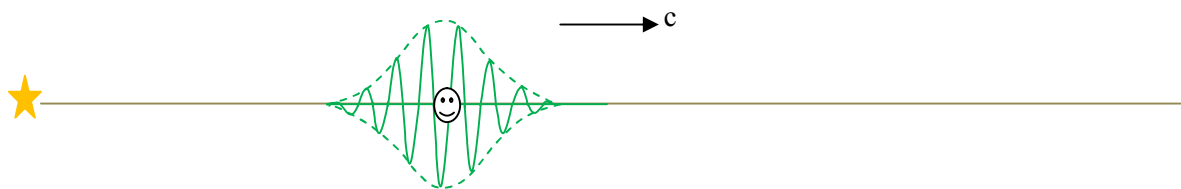

According to the new theory, the phases always go past the observer at the speed of light, and this was what Einstein postulated. But the envelop will always be at rest relative to the observer ('frozen'). Einstein (and no one else, I far as I know) never thought of such a possibility.

(Transverse) Doppler effect

We know that in Doppler effect of sound waves, there is no change in frequency or wavelength of light emitted at the point of closest approach, in the transverse (ninety degree) direction.

Light received at the moment of closest approach

Only a qualitative explanation has been presented and the quantitative analysis can be done based on the discussions so far. It will be presented in the next version of this paper.

Source at absolute rest and observer in absolute motion

From the figure below (parallel wave fronts, for simplicity) we see that transverse motion of the observer will have no effect on the phase velocity and hence on the wavelength and frequency of light seen by the observer. The phases will always go at c past the observer.

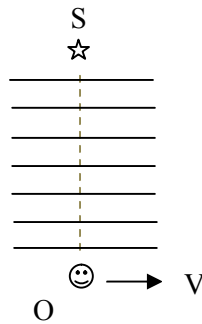

Source in absolute motion and observer at absolute rest

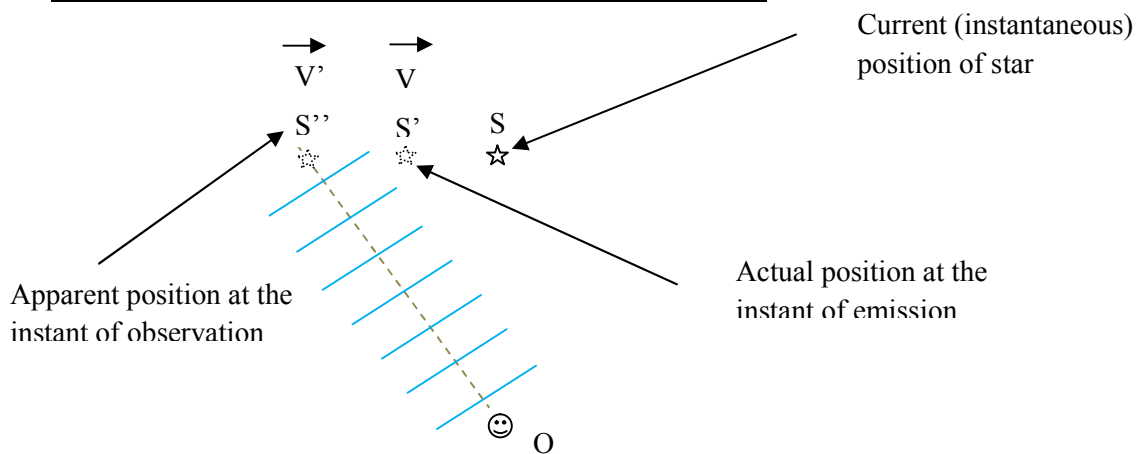

The source position now (at the moment of observation) is at S. But the source was at position S' at the moment of emission. The apparent position of the source at the moment of observation is at S'' as seen by the observer. i.e. it appears to the observer that the source emitted the light from position S''. Therefore, light received at the moment of closest approach will be blue shifted. But sound received at the moment of closest approach (for a moving source and stationary observer) is also Doppler positive shifted in frequency (increased in frequency). The distinction for light is that the frequency is 'more blue' than classical prediction.

Light emitted at the moment of closest approach

Source at absolute rest and observer in absolute motion

Light emitted at the instant of closest approach will be received after a delay of time. If the observer continues to move in the same direction, he /she will see, obviously, a red shifted light, as shown below.

The Doppler frequency and wavelength shift is already discussed in a previous section. Only the radial velocity component of the observer's velocity will result in a Doppler shift.

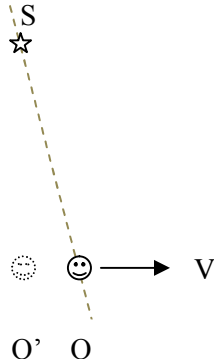

Source in absolute motion and observer at absolute rest

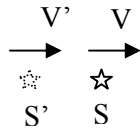

The source emitted light from point S. The observer receives the light after some delay. At the moment of observation, it appears to the observer that the light *was* emitted from point S', and not from point S. This effect has been explained thoroughly so far. Note that the position of the source *now* (instantaneous position) is irrelevant in this interpretation. Therefore, light emitted at the moment of closest approach will also be blue shifted.

At what position of the source will the observer then detect zero Doppler shift, for the case of an absolutely moving observer and an observer at absolute rest? The point of zero Doppler shift is ninety degrees for sound. Sound produced at the moment of the source position of ninety degrees to the velocity of the source will have zero Doppler shift. This point of zero Doppler shift for light is however is shifted to the right, as shown below.

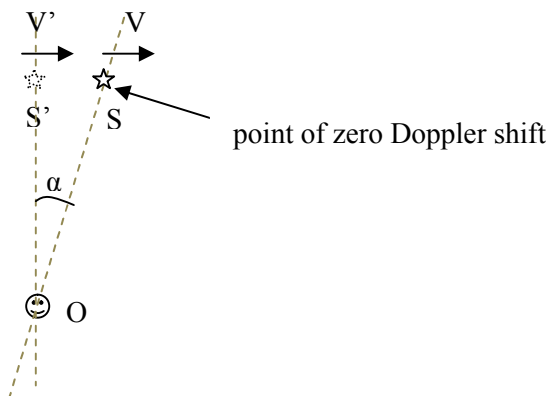

Although the source emitted light from point S, it appears to the observer (at the moment of observation) that the source emitted light from point S', which is at ninety degree position and hence zero Doppler frequency/wavelength shift. Therefore, light emitted from position S will have zero Doppler shift. It is possible to determine the angle α .

We see that the whole Doppler shift is shifted towards the blue, i.e 'more blue' (or 'less red') than classical theory, which assumes a medium of transmission for light. This is because the apparent source velocity V' is higher than the real source velocity V , up to the point of zero Doppler shift, as the source approaches the observer, and V' is less than V as the source is receding away from the observer, from the point of zero Doppler effect onwards.

Relativistic 'mass increase' of the electron

In our previous discussion, we hypothesized that the light wave apparently contracts towards or expands away from the source, for an observer moving towards or away from the source, respectively. If we interpret this also to mean that static fields expand or contract relative to their sources (charges) then this will lead to modification of Coulomb's law and hence account for the observed apparent increase of mass of charged particles, such as electrons and protons.

Velocity dependent version of Coulomb's law has been proposed by some authors also [1,2].

Suppose that there are two observers, O and A, is moving towards a light source.

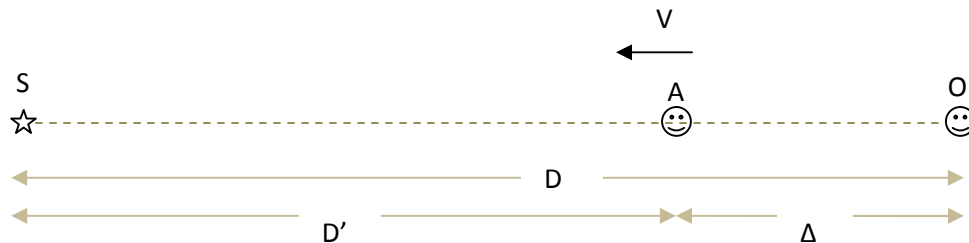

We already postulated that the phase velocity of light is constant, independent of the velocity of the source and the velocity of the observer.

Here we are just assuming that electrostatic effect (force) is propagating at the speed of light, and is not instantaneous.

Suppose that observers O and A were initially at the same distance D from the source, but observer A is moving towards the source. Assume that at this instant the source was just transmitting a peak point of a sinusoidal wave. The postulate of constancy of phase velocity requires that both observers should detect the peak point simultaneously. The wave apparently contracts towards or expands away from the source, so that the phase velocity is always constant.

During the time that the peak point travels from source to observer O, observer A will have moved towards the source by distance Δ .

$$D/c = (D-D') / V \Rightarrow D = (c / (c - V)) \cdot D'$$

For the moving observer, the wave contracts by an amount of $\Delta = D - D'$

If we apply this interpretation to static electric and magnetic fields also, we will get modified velocity dependent Coulomb's and Biot-Savart laws.

Coulomb's law is written as

$$F = \epsilon_0 \cdot q_1 \cdot q_2 / r^2$$



If q_1 and q_2 are both at absolute rest, then Coulomb's formula applies correctly.

Now assume that q_1 is at absolute rest and q_2 is moving towards q_1 with velocity V . For moving negative charge q_2 , the electric field of positive charge q_1 appears to contract towards q_1 . This means that equal potential lines drawn around q_1 now appear to have contracted towards q_1 , as 'seen' by q_2 .

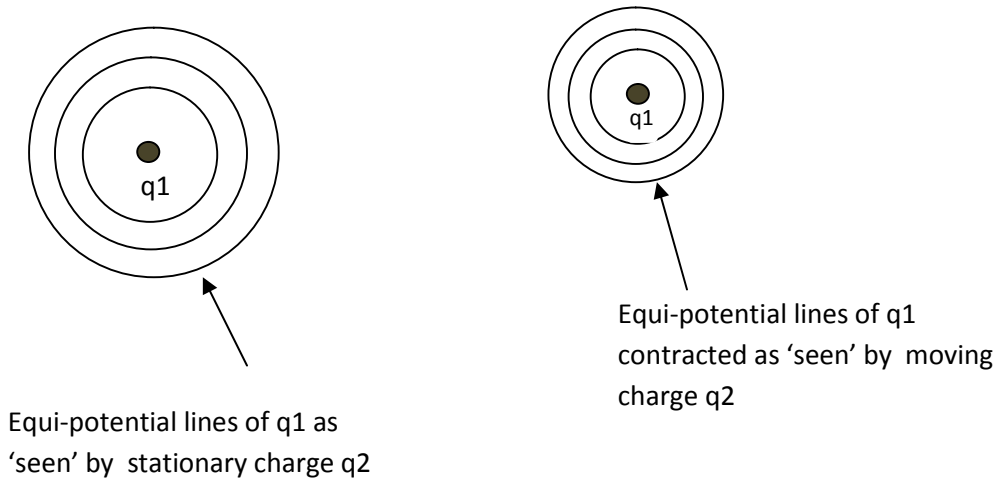

The moving charge q_2 will now experience less electric field of q_1 . Moving charge q_2 will experience the same electric field as stationary charge q_3 that is at distance r from q_1 , where

from the equation (see above), $D = (c / (c - V)) \cdot D'$

$$r = (c / (c - V)) \cdot r' \quad (\text{substituting } r \text{ for } D \text{ and } r' \text{ for } D')$$

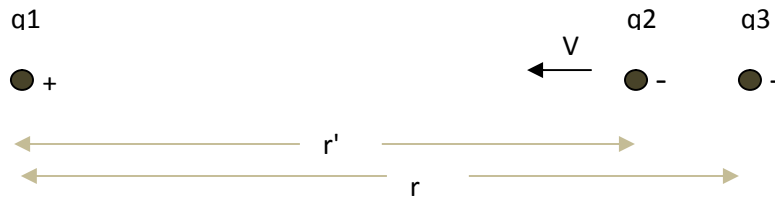

Coulomb's law:

$$F = \epsilon_0 \cdot q1 \cdot q2 / r^2$$

Substituting $r = (c / (c - V)) \cdot r'$

$$F = \epsilon_0 \cdot q1 \cdot q2 / [(c / (c - V)) \cdot r']^2$$

$$F = [\epsilon_0 \cdot q1 \cdot q2 / r'^2] \cdot [c / (c - V)]^2$$

We see that as the velocity of q2 approaches the speed of light, the electrostatic force will diminish towards zero. This might account for the 'relativistic mass increase' of the electron. Therefore, Coulomb's force will decrease by a factor of $[c / (c - V)]^2$, for a charge moving with velocity V towards another charge.

If q2 is moving away from q1, the electric field will increase. The electric field experienced by moving charge q2 is equal to the electric field experienced by stationary charge q3 that is at distance r from q1. In this case, the equipotential lines around q1 appears for the moving charge q2 to have expanded away from q2.



In this case,

$$r = (c / (c + V)) \cdot r'$$

Substituting in coulomb's formula

$$F = [\epsilon_0 \cdot q_1 \cdot q_2 / r^2] * [c / (c + V)]^2$$

If charge q2 moves in the transverse direction (see below) the field of q1 will appear to contract towards backwards as 'seen' by q2.

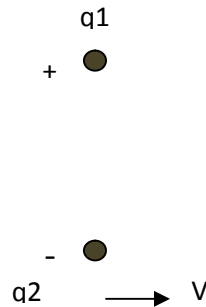

What has been proposed for electrostatic fields applies also for static magnetic fields. In experiments, an electron is initially accelerated by a high voltage and then delivered to a magnetic field. The electron velocity is transverse to the source of the magnetic field. Hence, the magnetic field appears to contract backwards as 'seen' by the electron, hence the magnitude of the magnetic field decreases with electron speed and hence less deflection. This effect is what has been considered as 'relativistic mass increase' in Special Relativity.

The explanation given in this section for the 'relativistic mass increase' of the electron is not meant to be a completely worked out theory but it is also intended to show that it can be an alternative promising theory.

Light speed measurement experiments

The speed of light has been measured with increasing accuracy by Ole Romer, Bradelly, Fizeau, Foucault and Albert Michelson, from observation of astronomical phenomena and by terrestrial experiments. Modern experiments use optical cavity resonators, microwave interferometer and laser methods. The currently accepted value is 2.99792458×10^8 m/s.

Apparently, no variation in the speed of light has ever been detected with different orientations of the measuring apparatus relative to the orbital velocity of the earth.

Let us consider the Michelson rotating mirror experiment.

As discussed so far, the source apparently shifts relative to the observer due to absolute velocity of the earth in space (about 390 Km/s). We see that this apparent shift of the position of the source relative to the observer does not affect the result of the experiment. The time taken by the light beam to move from the rotating mirror to the distant mirror and back to the rotating mirror is not affected by the absolute velocity of the earth. What is affected by absolute velocity of the earth is the total time taken for the light beam to go from the source to the observer and the experiment can not detect this change. One may think

of this as actually changing the distance between the source and the rotating mirror, which will not change the result of the experiment, obviously: the measured speed of light.

The same applies to optical cavity resonators and microwave and laser interferometer methods. The change in path length of the wave from source to detector due to absolute motion does not affect the result of such experiments. The *apparent* change of the position of the microwave source does not affect the frequency of a resonant cavity, just as *actually* changing the position of the source does not, in principle, affect the experiment. The frequency and the wavelength of light emitted by a source is not affected by an apparent or actual change of the position of the source.

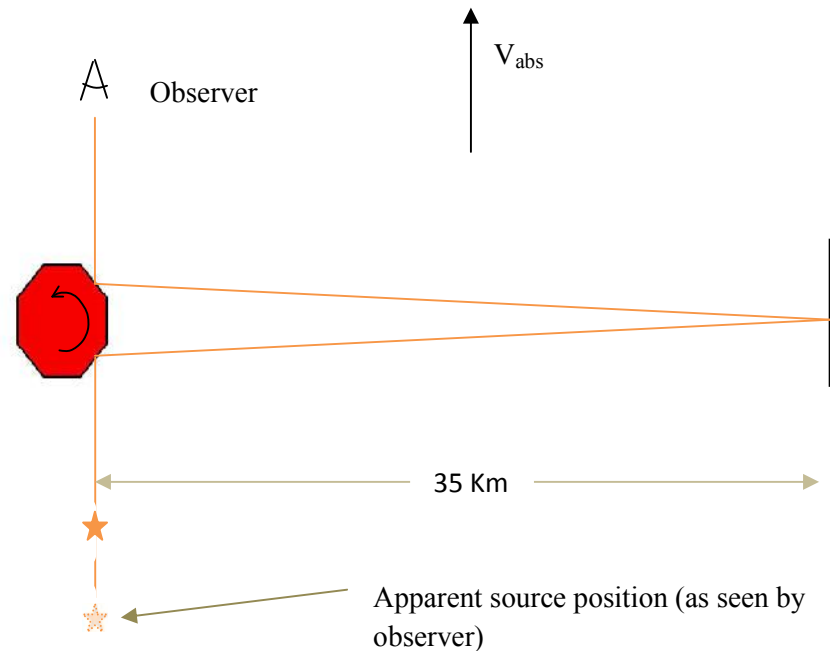

A different method was used by Rosa and Dorsey in 1907. They measured vacuum permittivity ϵ_0 and vacuum permeability μ_0 from which the speed of light can be computed from the equation $c^2 = 1 / \epsilon_0 \mu_0$. The result obtained was within 0.00005 % of the currently accepted value. This is an important experiment that shows that vacuum permittivity and vacuum permeability, and hence the vacuum *phase* velocity of light relative to any observer, are not affected by absolute motion. This can be another experimental evidence confirming Einstein's light postulate.

Absolute space is defined or ‘fixed’ by massive cosmic objects.

In free space, absolute translational motion does not exist. In absolute space (near massive cosmic objects) absolute motion exists. Massive cosmic objects define or ‘fix’ the space in their vicinity. According to the new interpretation of absolute motion of a light source, therefore, there will be no apparent change of position of light source in free space, i.e. there will be no ‘aberration’. Note that the new theory proposed in this paper means that aberration exists for source and observer co-moving absolutely in space, i.e. even with no relative motion between source and observer.

Imagine that the earth is moving in free space, isolated from all effects of the sun, planets, the stars, the galaxies. If we did a modified Michelson-Morley experiment (capable of detecting absolute motion) on such an earth, then we would get null result. But if we moved the modified MM device relative to (on) the earth with velocity V , we would get a corresponding fringe shift, because of the absolute space defined by the earth. What if the modified MM experiment was done at far away from the earth? We move the modified MM device (one with two coherent light sources in place of the forward and lateral mirrors) far away from the earth and any cosmic object, but at rest relative to earth. Obviously, there would be no fringe shift. Next we move the device so that its velocity relative to the earth is V . In this case, a much smaller fringe shift will occur (less than fringe shift detected when the experiment was done on the earth) and if the device is sufficiently far from the earth, no fringe shift will occur at all, even with large velocity of the device relative to earth.

Therefore, the absolute velocity of the device will be equal to its velocity relative to the earth on the surface of (or near) the earth. As distance from earth increases, the absolute velocity continuously diminishes even if the relative velocity was kept constant. Imagine the modified MM device mounted on a space ship launched from the earth, with constant velocity relative to the earth. As the space ship gets farther and farther away from the earth, the fringe shift diminishes continuously. Remember that so far we have been talking about a hypothetical earth which is in free space.

Next we do the thought experiment on the real earth, which is in the solar system. If we do the experiment with our modified MM device (stationary on earth), then a fringe shift will occur, corresponding to the absolute velocity of the earth, which is 378 Km/s as measured in Silvertooth’s experiment. If the device is moved relative to the earth, on or in the vicinity of the earth, additional fringe shift will be observed, superimposed on the fringe shift due to the 378 Km/s absolute velocity.

The absolute velocity of a body is the vector sum of all of its weighed velocities relative to cosmic massive objects in the universe.

A and B are massive cosmic objects (see next figure), with relative velocity V_{BA} . O is an object (an MM device) whose absolute velocity is to be determined, with velocity V_{OA} relative to A.

We see that the object O is far away from A and B. So its absolute velocity should be attenuated

in inverse proportion to the square of the distance from each object.

The velocity of O relative to A is V_{OA} (as indicated). The velocity of O relative to B (V_{OB}) will be the vector difference of V_{OA} and V_{BA} .

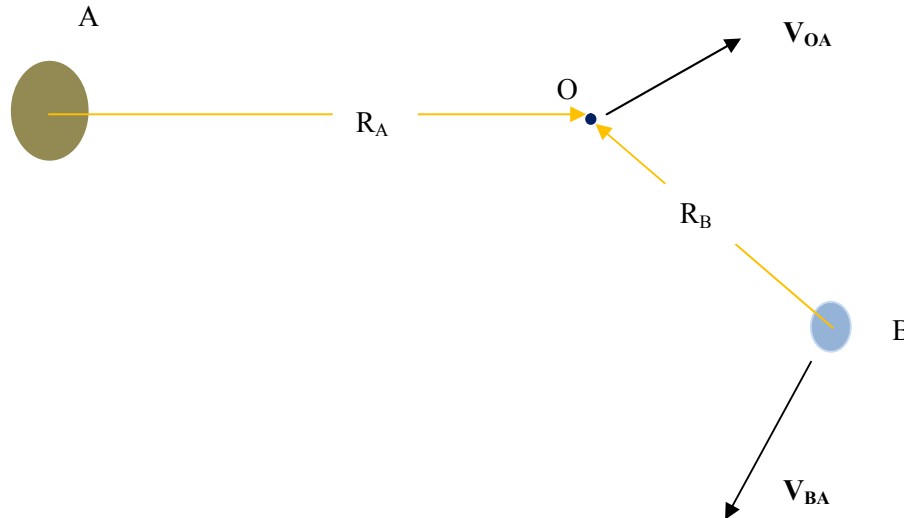

$$V_{OB} = V_{OA} - V_{BA}$$

$$V_{abs} = (K / R_A^2) V_{OA} + (K / R_B^2) V_{OB}$$

where K is some constant. Gravitational constant ?

Therefore, the absolute velocity (378 Km/s) of the earth as detected in the Silvertooth experiment is theoretically the resultant sum of all ‘inverse square distance weighed’ velocities of the earth relative to all cosmic objects in the universe. Cosmic objects with bigger masses and near to the earth will have more influence.

This theory will solve the centuries old perplexing paradox:

Relative to what is the absolute velocity of a body determined?

The proposed answer:

Relative to all cosmic objects in the universe.

The absolute velocity of a body is determined in an analogous (similar?) way to the determination of gravitational force acting on a body.

The Hafele Keating experiment and GPS correction may be explained by this theory.

The speed of light is infinite in free space; Explanation of star light bending near the sun, Hafele Keating experiment and the GPS correction.

Consider the Earth Centered Reference Frame that is not rotating with the earth.

Two effects can account for the results:

1. The speed of light increases as we go away from the earth
2. Motion of a clock in the ECR frame results in its absolute motion (of course, an absolute velocity which is to be superimposed on the absolute velocity of the earth or the solar system, which is about 390 Km/s) hence the effect of 'apparent change of position of light source due to absolute motion'

If you have an electronic clock in the geosynchronous orbit, therefore the above two effects will cause a difference in the rate of the clock, say, relative to a clock at rest on earth.

The first effect is one that is accounted to General Relativity, in main stream science. The second is one that is accounted to Special relativity.

The second effect is the 'time dilation'.

In this paper we have seen that absolute velocity has an effect on the (modified) Michelson – Morley and Sagnac interferometers (i.e. fringe shift). There is no reason, therefore, for absolute motion not to have effect at the atomic and molecular levels. For example, changing the quantum energy levels, and hence the frequency of radiation ?

Therefore, 'time dilation' is a real physical effect and not an effect of relative motion. It is a result of actual slow down of the rate of clocks in absolute motion.

One of the least understood problems in physics has been that of a free space endowed with characteristics such as ϵ_0 and μ_0 . This paper proposes that these parameters tend towards zero in free space, which is a region far away from cosmic massive objects. One implication of this is that the speed of light is infinite in free space. There also follows a question: what is the implication of zero permittivity and zero permeability ?

'Elliptic' orbits and Mercury perihelion advance

The new interpretation and theory of absolute motion proposed in this paper also gives a hint on gravitational phenomena: elliptic orbits, perihelion advance and the speed of gravity.

Most of the perihelion advance of Mercury is explained by Newton's laws, as effect of other planets on Mercury. However, a small residual value remains unexplained.

Regarding 'elliptic' orbits of planets, however, there is no satisfactory explanation. Why are planetary orbits not circular? Is it just because of a random initial velocity of the planets? A usual explanation given is that a circle is a very special case of an ellipse and hence the probability of a circular orbit is much less than that of an 'elliptic' orbit.

In this paper a fundamental cause of both phenomena is proposed: absolute motion of the solar system.

Even though much of Mercury's perihelion advance has been explained by Newton's laws, absolute motion may be the cause of the anomalous residual value.

The same kind of interpretation that was made for light (electromagnetism) may be applied for gravitation. The motivation for this analogy is that light and gravity both travel in empty space.

Consider a hypothetical solar system with a sun and one planet. Assume that the mass of the sun is much greater than the mass of the planet, for simplicity.

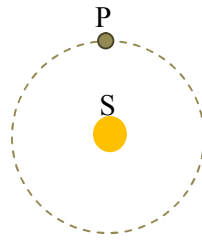

Assume that the hypothetical solar system is initially at absolute rest and the orbit of the planet is circular.

Next assume that the solar system is set into absolute motion (or is already in absolute motion somehow).

According to the new interpretation of absolute motion introduced in this paper, it appears to the planet P that the sun S is not at position S, but at position S'. Hence P will be attracted the apparent position S' of the sun. Actually, S' is always behind S for any position of the planet in its orbit. However, there will be a slight variation in the position of S' relative to S for different positions of P. Therefore, P will always be attracted towards a point behind the real position of the sun.



We can see that the perihelion point is always ahead of the sun S.

The above analysis is only a qualitative one.

The fact that the perihelion point is always in front of the sun (as seen in the direction of absolute motion) gives a hint on why / how it advances.

How can perihelion advance possibly arise ?

The solar system is likely moving around a galactic center and hence will not move in a straight path, but in a curved path.

Since the perihelion point is always in front of the sun, continuous change in direction of the sun's

absolute velocity will result in advance of perihelion point.

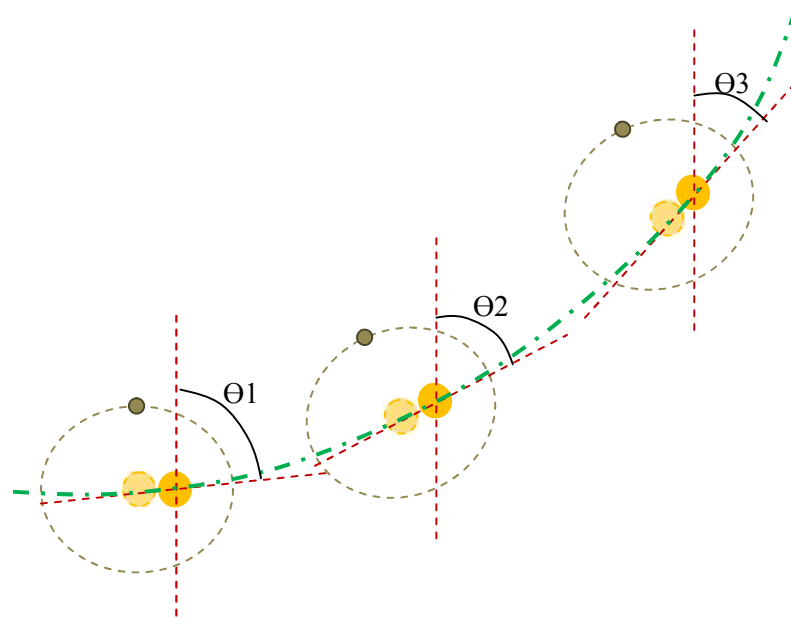

We can see that $\theta_1 > \theta_2 > \theta_3$.

As a speculation, there might also be ‘expansion’ and ‘contraction’ of gravitational field, analogous to electrostatic and magneto static fields, which is itself to be confirmed yet.

Conclusion

The real nature of the speed of light has remained a mystery ever since the historical Michelson-Morley experiment. There are numerous and divergent empirical evidences that have accumulated during the last century which have defied any natural and complete explanation by the known theories of light speed. The new theory proposed in this paper can explain all or most of the experiments and phenomena related to the speed of light. A single (or two) piece of idea(s) has been proposed that can resolve many of the contradictions.

Thanks to God and His Mother, Our Lady Saint Virgin Mary.

References

1. Alternatives to Relativistic Mass, www.alternativephysics.org
2. An alternative electrodynamics to the theory of Special Relativity, Musa D.Abdullahi
3. A replication of the Silvertooth experiment, Doug Marett
4. The Theory of Relativity- a mistake build on a wrong precondition, by ...

Bibliography

1. A Novel Solution to the Century Old Light Speed Paradox; Divorce of the Light Postulate from Special Relativity; Relativity of Electromagnetic Waves, Henok Tadesse
2. Apparent Shift of Position of Light Source Relative to Observer due to Rotation and Acceleration, Henok Tadesse
3. Absolute Motion is Intrinsic, Henok Tadesse

(The above three papers were published previously by this author. Although these papers did not present a complete theory and they contain some mistakes, they are the pathways to the new theory proposed in this paper.)

4. A Dissident View of Relativity, William H.Cantrell, PHD
5. Some Emission Theories of Light, Wikisource
6. The Theory of Relativity - a mistake build on wrong precondition-
7. There isn't Any Experimental Evidence to Support Relativity, Xinwei Huang
8. Physics 139 Relativity Notes 1999, G.E.SMOOT
9. Chasing a Beam of Light: Einstein's Most Famous Thought Experiment, John D. Norton
10. Ritz, Einstein and the Emission Hypothesis, Alberto A.Martinez
11. The Michelson-Morley Experiment, Michael Fowler U.Va.Physics 9/15/08
12. The Einstein Myths- Of Space, Time and Ether, Eugene F.Mallove, Sc.D
13. History of the Speed of Light (c), Jennifer Deaton and Tina Patrik
14. Lesson 25: Speed of Light

15. The Speed of Light: Historical Perspective and Experimental Findings, Trent Scarborough and Ben Williamson
16. How is the Speed of Light Measured ? Philip Gibbs 1997
17. Speed of Light-Wikipedia
18. Re- Analysis of the Marinov Light-Speed Anisotropy Experiment, Reginald T.Cahill
19. New Measurement of the Earth's Absolute Velocity with the Help of "Coupled Shutters" Experiment, Stephan Marinov
20. Experimental Detection of the Ether, Ernest Wilbur Silvertooth
21. A Replication of the Silvertooth Experiment, Doug Marett (2012)
22. Motion through the ether, E.W. Silvertooth
23. The Sagnac Effect and Uniform Motion, A.Kelly
24. Stellar Aberration and the Postulates on the Velocity of Light, Domina Eberle Spencer and Uma Y.Shama
25. The Michelson Gale Experiment and its Effect on the Postulates on the Velocity of Light, Parry Moon, Domina Eberle Spencer and Euclid Eberle Moon
26. On the Second Postulate of the Special Theory of Relativity, Wikisource (Q. Majorana)
27. Frensel, Fizeau, Hoek, Michelson-Morley, Michelson-Gale and Sagnac in Atherless Galilean Space, Curtis E. , 1996
28. Fizeau Experiment-Wikipedia
29. Can an Undulating Stream of Particles travel rectilinearly
30. Aberration of Light-Wikipedia
31. Doppler Shift for Sound and Light, Stevie Smith , 1957
32. Relativity of Light, JMJ (from relativityoflight.com)
33. The Michelson Gale Experiment, DougMarett (2010)
34. The Harvard Tower Experiment was frauded,Quantoken , Jan 27 2005
35. Is there a dynamic ether? A new reality for 21st century physics, Lew Price

36. Measuring Propagation Speed of Coulomb's Field,
A. Calcaterra, R.de Sangro, G.Finocchiaro, P.Patteri, M.Piccolo, G.Pizzela
37. Anti-Relativity: So Many Nobel Prize Winners Disagree
38. Einsteins Special Relativity has no Real World Evidence
39. Principles of Emission Theory, A.A.Cyrenika
40. Effect of Reflection From a Moving Mirror on the Velocity of Light, A.A. Michelson
41. The Development of Our Views On the Composition and Essence of Radiation
42. Modern Michelson Morley experiment using cryogenic optical resonators,
Holger, Muller, Sven Herrmann, Claus Braxmaier, Stephan Schiller, Achim Peters Feb 2008
43. Emission Theory-Wikipedia
44. Possible Experiments to test Einstein's Special Relativity Theory, Victor Otto de Hann
45. The Real Einstein, Roberto A.Monti
46. The Speed of Gravity – What the experiments say
47. Lumineferous Ether –Wikipedia
48. Sagnac effect – Wikipedia
49. The Feynman Lectures on Physics, www.feynmanlectures.caltech.edu
50. Aberration and the Speed of Gravity, S. Carlip
51. The Speed of Gravity- Why Einstein was wrong,Michaelsuede, My 14 2010
52. Experimental Demonstration of the Constancy of Velocity of Light Emitted by a Moving Source, Quirino Majorana (from Wikisource)
53. Radar Testing of the Relative Velocity of Light in Space, Bryan G.Wallace
54. A New Interpretation of the Hafele-Keating Experiment, Domina Eberle Spencer, Uma Y.Shama
55. Conducting a crucial experiment of the constancy of the speed of light using GPS, by Ruyong Wang, Ronald R. Hatch
56. The Ives-Stilwell Experiment, A.A. Faraj

57. The Relativistic Doppler Effect, Michael Richmond
58. NASA's astonishing evidence that c is not constant; The Pioneer Anomaly, E.D. Greaves
59. Radar Testing of the Relative Velocity of Light in Space, Bryan G. Wallace
60. Experiment on the Constancy of Velocity of Electromagnetic Radiation, Peter Beckman and Peter Mandics
61. Fundamental Physics: High precision tests of Special and General Relativity
62. Illuminating relativity :experimenting with the stars
63. The Michelson-Gale experiment, DougMarett (2010)
64. Moving magnet and conductor problem- Wikipedia
65. The Development of Our Views on the Composition and Essence of Radiation
66. Tests of Special Relativity- Wikipedia
67. Rethinking Relativity, Tom Bethel
68. The Sagnac Effect: Does it Contradict Relativity ? DougMarett , 2012
69. Relativity 4 Engineers
70. The Sagnac Effect and Uniform Motion, A.G. Kelly
71. Stellar Aberration and Einstein's Relativity, Paul Marmet
72. Where did the aether go ? Brendan D. Murphy
73. Is the Aether Entrained by the Motion of Celestial Bodies ? What do the Experiments Tell Us ? Joseph Levy
74. Bradley, Sagnac & Entrainment, John-Erik Persson
75. Einstein – His Life and the Universe, Walter Issacson
76. An Astronomical Test for the Second Postulate of the Special Theory of Relativity, Juan J. Schulz Poquet
77. Measurement of the Speed of Gravity, Yin Zhu
78. Speed of Gravity-Wikipedia
79. Correspondence. Light and Gravity Aberration –Ether-Wind Detection, Persson (from Galilean Electrodynamics)

80. The Speed of Gravity- Why Einstein was Wrong, Michael Suede
81. What is the Speed of Gravity, Ethan (August 25/2010)
82. What is the experimental basis of Special Relativity? Tom Roberts and Siegmar Schleif
83. Possible Experiments to Test Einstein's Special Relativity Theory, Victor-Otto de Hann
84. The Rotating Interferometer, Response to Robert Driscoll
85. Some more details on the Michelson-Morley experiment
86. The Surprising Results of the Michelson-Morley experiment, Michael Richmond
87. Galilean invariance-Wikipedia
88. Galileo's Ship-Wikipedia
89. Sagnac effect- Wikipedia
90. Tests of General Relativity-Wikipedia
91. Evidence of Warped Spacetime, Nick Strobel
92. Special Relativity-Wikipedia
93. On the Establishment of a Universal Time, Parry Moon and Domina Ebrle Spencer
94. On Seeing the Superluminals, Cynthia Kolb Whitney
95. Questioning Einstein, Tom Bethell (from Einstein Plus Two, by Petr Beckmann)
96. Trouton-Noble experiment-Wikipedia
97. Challenging dominant Physics Paradigms, by Juan Miguel Campanario and Brian Martin
98. Theory and Experimental Tests: The Nature of Space and Time (*from* Conspiracy of Light)
99. Doppler and Special Relativity, Han Erim
100. Relativistic Doppler effect- Wikipedia
101. What the Global Positioning System Tells Us about Relativity, Tom Van Flandern
102. Critique of Special Relativity (PRP-1), George A. Adriaenssens
103. Did the Hafele-Keating Experiment Prove Einstein Wrong?

V.Booblehead productions

104. Ives-Stilwell Experiment Fundamentally Flawed, Joseph A.Rybczyk
105. Why are orbits elliptical? Why isn't the sun at the center of the orbits? Is there a mathematical or gravitational answer or is it just a random placement after formation?
106. Theory of Relativity: A Critical Analysis, Robert A. Monte
107. Einstein's Relativity has no real world evidence, Werner Heisenberg
108. The Radiation Continuum Model of Light and the Galilean Invariance of Maxwell's Equations, Renshaw, 1996 *

* Interestingly, the theory of 'The Radiation Continuum Model of Light and ...' proposed by Renshaw has some similarity with the 'Relativity of Electromagnetic Fields and Waves' theory which I proposed one year before I even saw/ read the 'The Radiation Continuum ...' theory. The 'contraction' / 'expansion' of electromagnetic fields and waves I proposed has similarity with the 'elasticity' in the 'Radiation Continuum Model of Light'. Independent proposal of somewhat similar ideas by two authors may show the plausibility of the idea.