

SET THEORETIC APPROACH TO ALGEBRAIC STRUCTURES IN MATHEMATICS

A REVELATION

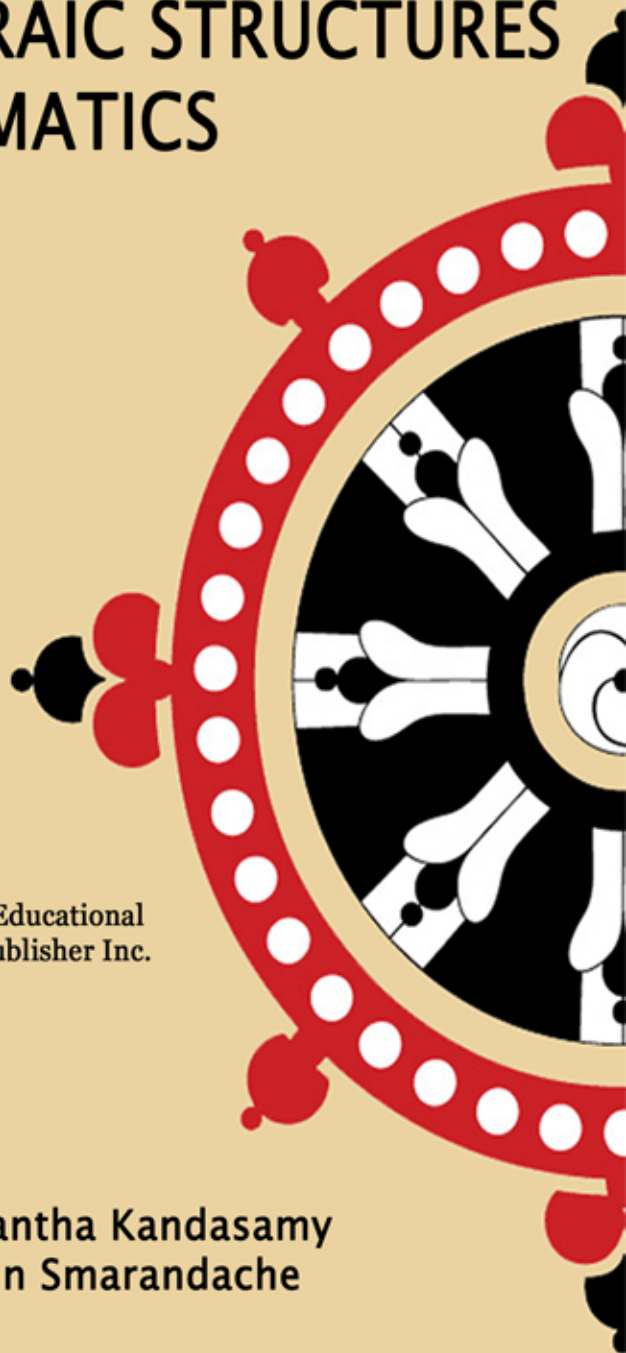

Educational
Publisher Inc.

W.B. Vasantha Kandasamy
Florentin Smarandache

Set Theoretic Approach to Algebraic Structures in Mathematics - A Revelation

**W. B. Vasantha Kandasamy
Florentin Smarandache**

**Educational Publisher Inc.
Ohio
2013**

This book can be ordered from:

Education Publisher Inc.
1313 Chesapeake Ave.
Columbus, Ohio 43212,
USA
Toll Free: 1-866-880-5373

Copyright 2013 by *Educational Publisher Inc.* and the *Authors*

Peer reviewers:

Dr. Ovidiu-Ilie Sandru, Polytechnic University of Bucharest, Romania.
Prof. Valeri Kroumov, Okayama Univ. of Science, Okayama, Japan.
Maikel Yelandi Leyva Vázquez, Universidad de Las Ciencias Informáticas,
Havana, Cuba.

Many books can be downloaded from the following
Digital Library of Science:
<http://fs.gallup.unm.edu/eBooks-otherformats.htm>

ISBN-13: 978-1-59973-212-1
EAN: 9781599732121

Printed in the United States of America

CONTENTS

Preface	5
Chapter One INTRODUCTION	7
Chapter Two SETS IN SEMIGROUPS	9
Chapter Three SET IDEALS IN RINGS	47
Chapter Four SETS IN VECTOR SPACES	77

Chapter Five	
APPLICATIONS OF SETS TO SET CODES	145
FURTHER READING	161
INDEX	163
ABOUT THE AUTHORS	166

PREFACE

In this book authors bring out how sets in algebraic structure can be used to construct most generalized algebraic structures, like set linear algebra/vector space, set ideals in rings and semigroups.

This sort of study is not only innovative but infact very helpful in cases instead of working with a large data we can work with a considerably small data. Thus instead of working with a vector space or a linear algebra V over a field F we can work with a subset in V and a needed subset in F , this can save both time and economy.

The concept of quasi set vector subspaces over a set or set vector spaces over a set are some examples of how sets are used and algebraic structures are given to them.

Further these set algebraic structures are used in the following, in the first place they are used in the construction of topological spaces of different types, which basically depend on the set over which the collection of subspaces are defined. For instance given a vector space defined over the field we can have one and only one topological space of subspaces associated with it, however for a given vector space we can have several topological set vector spaces associated with it; that too depending on the subsets which we choose in the field F . This notion has several advantages for we can use a needed part of the structure and study the problem.

Thus in case of semigroup S (or ring R), we can use the collection of set ideals defined over a subset M of the semigroup S (or ring R) to build a set ideal topological space T which depends on the subset M of S (or R). Infact we can have several such topological spaces for a given semigroup S (or ring R) by varying with the subsets of S (or R). This is one of the advantages of using set ideals in semigroups (or rings).

Finally set vector spaces are used in the construction of set codes which has several advantages over usual codes.

This book has five chapters. Chapter one is introductory in nature. Sets in semigroups are described and discussed in chapter two. Chapter three analyses set ideals in rings and studies their associated properties. Sets in vector spaces are studied in chapter four of this book. In final chapter we discuss the application of sets to set codes. We thank Dr. K.Kandasamy for proof reading and being extremely supportive.

W.B.VASANTHA KANDASAMY
FLORENTIN SMARANDACHE

Chapter One

INTRODUCTION

In this book authors describe the innovative ways in which they have used only subsets of an algebraic structure like rings, semigroups, vector spaces to construct nice algebraic structures.

These algebraic structures in turn are most generalized forms of ideals or vector spaces or topological spaces.

We use a semigroup S . The ideals of a semigroup form a topological space under intersection ' \cap ' of ideals and ' \cup ' is the ideal generated by the set union of two ideals. With this a topology can be given on the collection of ideals of a semigroup S .

It is pertinent to keep on record we have one and only ideal topological space associated with a semigroup S .

If we take subsemigroups of a semigroup S and build set ideals over these subsemigroups we get as many number of set ideal topological spaces associated with these semigroups.

In fact this concept of set ideals of a semigroup over a subsemigroup happens to be a most generalized concept.

Thus this mode of using set ideals leads to many set ideal topological spaces associated with a semigroup [14].

Likewise we can define set ideals of a ring over a subring. This also leads to several set ideal topological spaces associated with a ring.

However it is important to keep on record set ideals of a semigroup are distinct different from set ideals of a ring. For if we take Z_6 , $\{0, 1\}$ is a subsemigroup of Z_6 however it is not a subring of Z_6 .

Thus we have built set ideal topological spaces of a ring using subring [14, 17].

Such study using sets is both innovative and interesting.

Finally we define set vector spaces (set linear algebras) and special set linear algebras and special set vector spaces [16]. These new concepts find applications in the building of special classes of set codes [18].

Thus we have used just subsets of algebraic structures and give special structures on them.

Chapter Two

SETS IN SEMIGROUPS

When a semigroup S has a subset P in it, nothing can be attributed to the P contained in S . We say P is a subset but we have given a relative structure to it and based on this we define the new notion of set ideals in semigroup.

This study is not only interesting and important but such study can lead to revelation in building algebraic structures on these sets which was mainly constructed only as a set in a semigroup.

We just show how such structures are constructed and describe and develop such theory.

DEFINITION 2.1: *Let S be a semigroup, P a proper subset of S . T a proper subsemigroup of S . P is called a left set ideal of S relative to the subsemigroup T of S if for all $s \in T$ and $p \in P$; $sp \in P$.*

Similarly we can define right set ideals of the semigroup S over the subsemigroup T of S .

If S is a commutative semigroup then the notion of right set ideal and left set ideal coincide.

Further if in the definition sp and $ps \in P$ for all $p \in P$ and $s \in T$ we call P the set ideal of S over the subsemigroup T of S .

We will illustrate this situation by some examples.

Example 2.1: Let $S = \{Z_{15}, \times\}$ be a semigroup. $P = \{0, 5, 6, 10, 12, 1\}$ be a subset in S . Take $T = \{0, 5, 10\}$ a proper subsemigroup of S . P is a set ideal of S over the subsemigroup T of S .

Example 2.2: Let $S = \{Z_{16}, \times\}$ be a semigroup. $P = \{0, 5, 4, 8, 2, 9\} \subseteq S$ be a proper subset of S . $T = \{0, 4\} \subseteq S$ be a subsemigroup of S .

P is a set ideal of S over the subsemigroup T of S .

Example 2.3: Let $S = \{Z^+ \cup \{0\}, \times\}$ be a semigroup. $P = \{0, 5n, 8m / n, m \in N\} \subseteq S$ be a set. $T = \{2Z^+ \cup \{0\}\} \subseteq S$ be a subsemigroup. Clearly P is a set ideal of S over the subsemigroup T .

Infact P is also a set ideal of S over T .

However P is an ideal over several subsemigroups. Infact P is also an ideal of every one of the subsemigroups.

We see by the method of defining the notion of set ideals of a semigroup over a subsemigroup get many set ideals.

We will illustrate this situation by an example or two.

Example 2.4: Let $\{Z_6, \times\} = S$ be a semigroup.

Consider the subsemigroup $T = \{0, 3\}$. $P_1 = \{0, 2\} \subseteq S$ is a set ideal of S over the subsemigroup T of S .

$P_2 = \{0, 4\} \subseteq S$ is again a set ideal of S over the subsemigroup T of S .

$P_3 = \{0, 5, 3\}$ is again a set ideal of S over the subsemigroup T .

$P_4 = \{0, 4, 2\} \subseteq S$ is a set ideal of S over the subsemigroup T of S .

$P_5 = \{0, 2, 3, 5\} \subseteq S$ is a set ideal of S over the subsemigroup T of S .

$P_6 = \{0, 4, 3, 5\} \subseteq S$ is set ideal of S over the subsemigroup T of S .

$P_7 = \{0, 4, 2, 3, 5\}$ is also a set ideal of S over the subsemigroup T of S .

$P_8 = \{0, 2, 3\}$, $P_9 = \{0, 3, 4\}$, $P_{10} = \{1, 3, 0\}$, $P_{11} = \{0, 3, 2, 4\}$, $P_{12} = \{0, 3, 2, 5\}$, $P_{13} = \{0, 3, 4, 5\}$, $P_{15} = \{0, 3, 4, 5, 2\}$, $P_{16} = \{0, 1, 2, 3\}$, $P_{17} = \{0, 1, 4, 3\}$, $P_{18} = \{0, 1, 5, 3\}$, $P_{19} = \{0, 1, 4, 2, 3\}$ and $P_{20} = \{0, 1, 4, 2, 5, 3\} = Z_6 = S$.

Thus we have 20 such set ideals over $T = \{0, 3\} \subseteq Z_6$.

However in Z_6 we have only two ideals namely $T_1 = \{0, 3\}$ and $T_2 = \{0, 2, 4\}$.

Now consider the subsemigroup $S_1 = \{0, 2, 4\}$. We will enumerate all the set ideals of S over S_1 .

$T_1 = \{0, 3\} \subseteq S$ is a set ideal of S over the subsemigroup S_1 of S .

$T_2 = \{0, 3, 2\} \subseteq S$ is a set ideal of S over the subsemigroup S_1 of S .

$T_3 = \{0, 3, 4\} \subseteq S$ is a set ideal of S over the subsemigroup S_1 of S .

$T_4 = \{0, 3, 4, 2\} \subseteq S$ is a set ideal of S over the subsemigroup S_1 of S .

$T_5 = \{0, 1, 4, 2\} \subseteq S$ is a set ideal of S over the subsemigroup S_1 of S .

$T_6 = \{0, 4, 2, 5\} \subseteq S$ is a set ideal of S over the subsemigroup S_1 of S .

$T_7 = \{1, 4, 2, 5, 0\} \subseteq S$ is a set ideal of S over the subsemigroup S_1 of S .

$T_8 = \{0, 1, 3, 4, 2\} \subseteq S$ is a set ideal of S over the subsemigroup of S over S_1 of S .

$T_9 = \{1, 0, 2, 3, 4, 5\} \subseteq S$ is a set ideal of S over the subsemigroup of S over S_1 of S .

This we have 9 set ideals of S over S_1 of S .

Example 2.5: Let $S = Z_4 = \{0, 1, 2, 3\}$ be the semigroup under product \times .

The subsemigroups of S are $T_1 = \{0, 2\}$, $T_2 = \{0, 1, 2\}$, $T_3 = \{0, 1, 3\}$ and $T_4 = \{1, 3\}$.

We find the number of set ideals over these subsemigroups. $P_1 = \{0, 3, 2\}$ and $P_2 = \{0, 1, 2\}$ are set ideals of S over the subsemigroup T_1 of S .

$P_3 = \{0, 3, 2\}$ and $P_4 = \{0, 2\}$ are the set ideals of S over the subsemigroup T_2 of S .

Consider $P_5 = \{0, 2\} \subseteq S$ and $P_6 = \{2\}$, set ideals of S over T_3 .

$P_7 = \{0, 2\}$ and $P_8 = \{2\}$ are set ideals of S over T_4 .

We get in total barring $\{0\}$, 8 set ideals over the four subsemigroups of S .

However (Z_4, \times) has only one ideal $\{0, 2\}$ we have not worked with the subsemigroup $\{0, 1\}$.

Example 2.6: Let $S = \{Z_9, \times\}$ be a semigroup. The subsemigroups of S are $P_1 = \{1, 8\}$, $P_2 = \{0, 1, 8\}$, $P_3 = \{0, 3\}$, $P_4 = \{0, 6\}$, $P_5 = \{0, 3, 6\}$, $P_7 = \{0, 3, 6, 1\}$, $P_8 = \{0, 2, 4, 8, 7, 5, 1\}$ and $P_9 = \{0, 1\}$ be subsemigroups of S .

To find the set ideals over these subsemigroups of S .

$T_1 = \{0, 8\}$, $T_2 = \{0, 3, 6\}$, $T_3 = \{2, 7\}$, $T_4 = \{3, 6\}$, $T_5 = \{0, 2, 7\}$, $T_6 = \{4, 5\}$ and $T_7 = \{0, 4, 5\}$ are set ideals of S over the subsemigroup P_1 of S .

Now $M_1 = \{0, 8\}$, $M_2 = \{0, 3, 6\}$, $M_3 = \{0, 2, 7\}$, $M_4 = \{0, 2, 7\}$ and $M_5 = \{0, 4, 5\}$ are set ideals of S over the subsemigroup $P_2 = \{0, 1, 8\} \subseteq S$.

Further $N_1 = \{0, 6\}$, $N_2 = \{0, 2, 6\}$, $N_3 = \{0, 4, 3\}$, $N_4 = \{0, 2, 3, 4, 6\}$, $N_5 = \{0, 8, 6\}$, $N_6 = \{0, 8, 4, 3, 6\}$, $N_7 = \{0, 2, 3, 4, 6, 8\}$, $N_8 = \{0, 4, 1, 3\}$, $N_9 = \{0, 1, 2, 3, 4, 6\}$ and $N_{10} = \{0, 8, 4, 3, 6, 1\}$ are set ideals of S over the subsemigroup $P_3 = \{0, 3\} \subseteq S$.

Now consider $P_4 = \{0, 6\} \subseteq S$. To find the set ideals of S over the subsemigroup P_4 of S . $A_1 = \{0, 3\}$, $A_2 = \{0, 4, 6\}$, $A_3 = \{0, 2, 3\}$, $A_4 = \{0, 8, 6\}$, $A_5 = \{0, 1, 6\}$, $A_6 = \{0, 1, 2, 3, 6\}$, $A_7 = \{0, 8, 6, 1\}$, $A_8 = \{0, 3, 1, 6\}$, $A_9 = \{0, 1, 4, 6\}$, $A_{10} = \{0, 5, 3\}$, $A_{11} = \{0, 5, 3, 1, 6\}$, $A_{12} = \{0, 5, 3, 6\}$, $A_{13} = \{0, 1, 2, 3, 6, 5\}$, $A_{14} = \{5, 2, 3, 6, 0\}$, $A_{15} = \{0, 7, 6\}$, $A_{16} = \{0, 7, 1, 6\}$, $A_{17} = \{0, 3, 7\}$, $A_{18} = \{0, 1, 3, 7, 6\}$, $A_{19} = \{0, 1, 6, 8, 3, 7\}$ and so on.

It is pertinent to keep on record that by defining set ideals we can have several set ideals.

We leave the following problems open.

Problem 2.1: Let $S = (Z_n, \times)$ be a semigroup.

- (i) Find all subsemigroups of S .
- (ii) How many subsemigroups of S exist?
- (iii) Find all the set ideals of S regarding each of subsemigroups.
- (iv) Find the total number of set ideals of S .

Problem 2.2: Let $S = (Z_n, \times)$ be a semigroup.

Prove if H is a subsemigroup of S of highest cardinality then the number of set ideals over H is less in number in comparison with a subsemigroup P of S of least cardinality.

Problem 2.3: Prove or disprove in $S = (Z_n, \times)$; the subsemigroup $P = \{0, 1\} \subseteq S$ gives the maximum number of set ideals. (Of course we do not take $N = \{1\} \subseteq S$ as a subsemigroup of S).

For the definition of maximal and minimal set ideals of a semigroup are recalled for the sake of completeness.

Let S be a semigroup. P a subsemigroup of S . $M \subseteq S$ be a subset of S which is a set ideal of S over the subsemigroup P of S . We say M is a maximal set ideal relative to the subsemigroup P of S if $M \subseteq M_1 \subseteq S$ and M_1 a set ideal of S over P then $M = M_1$ or $M_1 = S$.

Let S be a semigroup; P a subsemigroup of S . $N \subseteq S$ be a set ideal of S over the subsemigroup P of S ; we say N is a minimal set ideal of S relative to P if $\{0\} \neq N_1 \subseteq N \subseteq S$ then $N = N_1$ or $N_1 = \{0\}$.

We will give examples of this situation.

Example 2.7: Let $S = (\mathbb{Z}_6, \times)$ be a semigroup. $P = \{0, 3\} \subseteq S$ be a subsemigroup of S . $T = \{0, 2, 4, 5, 3\} \subseteq S$ is a maximal set ideal of S over the subsemigroup P of S .

Take $M = \{0, 2\} \subseteq S$; M is a minimal set ideal of S over the subsemigroup P of S . Infact $N = \{0, 4\} \subseteq S$ is also a minimal set ideal of S over the subsemigroup P of S .

$W = \{0, 5, 3\} \subseteq S$ is also a special minimal set ideal of S over P for $P \subseteq W$ and P is itself the trivial minimal set ideal of S over P .

$B = \{0, 1, 3\} \subseteq S$ is also a minimal set ideal of S over the subsemigroup P of S .

Example 2.8: Let $S = (\mathbb{Z}_{12}, \times)$ be a semigroup. Suppose $P = \{0, 4\} \subseteq S$ be a subsemigroup of S . To find the set ideals which are maximal and minimal over P .

$M_1 = \{0, 3\} \subseteq S$ is a minimal set ideal of S over P . $M_2 = \{0, 6\} \subseteq S$ is a minimal set ideal of S over P . $M_3 = \{0, 9\} \subseteq S$ is again a minimal set ideal of S over P .

$M_4 = \{0, 1, 4\} \subseteq S$ is again a minimal set ideal of S over P . Consider $M_5 = \{0, 2, 8\} \subseteq S$ is a minimal set ideal of S over P .

$M_6 = \{0, 2, 8, 5, 6, 3\}$ is neither a minimal set ideal of S over P nor a maximal set ideal of S over P .

$M_7 = \{0, 2, 8, 5, 1, 3, 6, 9, 7, 4, 10\} \subseteq S$ is a maximal set ideal of S over P . Thus we see for a given subsemigroup P of a semigroup S we can have several minimal set ideals of S over P .

$M_8 = \{0, 11, 4, 8\} \subseteq S$ is again a minimal set ideal of S over P for $\{0, 8\} = N \subseteq M_8$. $M_9 = \{0, 7, 8, 4\} \subseteq S$ is again a minimal set ideal of S over P . $M_{10} = \{0, 5, 4, 8\} \subseteq S$ is not a minimal set ideal of S over P ; for $\{0, 8\} \subseteq M_{10} \subseteq S$.

By the method of defining minimal set ideals we get several minimal set ideals and several maximal set ideals for a given subsemigroup.

These concepts will be useful in application for instead of working with a very large subsemigroup we can work in that semigroup by opting for a proper subsemigroup.

Example 2.9: Let $S = (\mathbb{Z}_{10}, \times)$ be a semigroup. The subsemigroups of S are $P_1 = \{0, 1\}$, $P_2 = \{0, 5\}$, $P_3 = \{0, 9, 1\}$, $P_4 = \{0, 2, 4, 8, 6\}$, $P_5 = \{0, 6\}$, $P_6 = \{0, 7, 9, 1, 3\}$, $P_7 = \{0, 5, 1\}$, $P_8 = \{0, 1, 6\}$ and $P_9 = \{0, 1, 2, 4, 8, 6\}$.

One can find several set ideals related with these subsemigroup.

We work with the subsemigroup $\{0, 5\} = P_2$ in S .

$M_1 = \{0, 3, 5\} \subseteq S$ is a set ideal of S over P_2 . $M_2 = \{0, 2\} \subseteq S$ is a set ideal of S over P_2 which is also a minimal set ideal of S over P_2 .

$M_3 = \{0, 4\} \subseteq S$ is again a minimal set ideal of S over the set P_2 .

$M_4 = \{0, 6\} \subseteq S$ is a minimal set ideal of S over P_2 .

$M_5 = \{0, 8\} \subseteq S$ is a minimal set ideal of S over P_2 .

$M_6 = \{0, 7, 5\}$ is a set ideal of S over P_2 .

$M_7 = \{0, 2, 4, 6, 8, 9, 1, 7, 5\}$ is a maximal set ideal of S over P_2 .

It is pertinent to record that we can have several subsemigroups over which a given set can be maximal set ideal or a minimal set ideal this is yet another interesting feature enjoyed by set ideals of a semigroup.

Now we have been working only with set ideals of a semigroup built using Z_n . We can have set ideals of the semigroup $C(Z_n) = \{a + bi_F \mid a, b \in Z_n, i_F^2 = n-1\}$ these set ideals can also be mentioned as complex set ideals.

We will just illustrate this by an example or two.

Example 2.10: Let

$$S = \{C(Z_4), \times\} = \{a + bi_F \mid a, b \in Z_4, i_F^2 = 3, \times\}$$

be a complex modulo integer semigroup.

The subsemigroups of S are $P_1 = \{0, 2i_F\}$, $P_2 = \{0, 2\}$, $P_3 = \{0, 1, 3\}$, $P_4 = \{0, i_F, 3, 1, 3i_F\}$ and so on.

We just find set ideal of S relative to the subsemigroup $P_1 = \{0, 2i_F\}$, $T_1 = \{0, i_F, 2\}$, $T_2 = \{0, 1, 2i_F\}$, $T_2 = \{0, 2\}$, $T_3 = \{0, 3, 2i_F\}$, $T_4 = \{1, 0, 2i_F, i_F, 2\}$, $T_5 = \{0, 3i_F, 2\}$ and so on are set ideals of S over the subsemigroup P_1 of S .

We see T_2 is a minimal set ideal of S over P_1 .

$S_1 = \{0, 1+i_F\}$ is also a minimal set ideal of S over P_1 , $S_2 = \{0, 2+2i_F\}$ is again a minimal set ideal of S over P_1 .

Thus over the subsemigroup $P_1 = \{0, 2i_F\}$, S has many set ideals over P_1 . Take $P_4 = \{0, 1, 3, i_F, 3i_F\}$.

Consider a set $M_1 = \{0, 2, 2i_F\} \subseteq S$, M_1 is a minimal set ideal of S over the subsemigroup P_4 .

Consider $M_2 = \{0, 2 + 2i_F\} \subseteq S$, M_2 is also a minimal set ideal of S over P_4 . $M_3 = \{0, 1+i_F, 3+3i_F, i_F+3, 3i_F+1\}$ is also a minimal set ideal of S over P_4 .

Example 2.11: Let $S = C(Z_7) = \{a + bi_F \mid a, b \in Z_7, i_F^2 = 6\}$ be the semigroup under product. Take $P_1 = \{0, 1+i_F, 2i_F, 2i_F+3, 1+5i_F, 2i_F + 4, i_F+3, 6i_F+5, 3i_F+2, 4i_F+1, 4+5i_F, 4i_F+6, 3, 3+3i_F,$

$6i_F+2, 2, 2+2i_F, 4+4i_F, 6+6i_F, 6, 6i_F, 4i_F, 5i_F, i_F, 5, 5+5i_F, 1, 3i_F, 5i_F$ and so on}.

We see if we have a very large subsemigroup it need not imply the set ideal will be minimal.

However we take a small subsemigroup $P_2 = \{0, i_F, 6, 6i_F, 1\}$. The set ideals over P_2 are as follows:

$M_1 = \{0, 6+6i_F, 6i_F+1, i_F+1, 6+i_F\} \subseteq S$ is a minimal set ideal of S over P_2 .

Interested reader can work with more set ideals in S over P_2 .

Example 2.12: Let $S = \{C(\mathbb{Z}_9) = a + bi_F \mid a, b \in \mathbb{Z}_9, i_F^2 = 8\}$ be the semigroup of complex modulo integers.

$P_1 = \{0, 3\}$, is a subsemigroup of S .

$P_2 = \{0, 6\}$ is also a subsemigroup of S . The set ideals relative to P_1 is as follows.

$M_1 = \{0, 6\}$ is a minimal set ideal of S over P_1 .

$M_2 = \{0, 3i_F\}$ is also a minimal set ideal of S over P_1 .

$M_3 = \{0, 6i_F\} \subseteq S$ is also a minimal set ideal of S over P_1 .

$M_4 = \{0, 3i_F, 6i_F\}$ is a set ideal of S which is not minimal over P_1 .

M_2, M_3 and M_4 are also set ideals of S over P_2 .

Infact M_2 and M_3 are minimal set ideals of S over P_2 .

This observation is interesting.

$P_3 = \{0, 3i_F\}$ is a subsemigroup of S .

$N_1 = \{0, 3\}$ is a minimal set ideal of S over the subsemigroup P_3 of S .

Consider $N_2 = \{0, 6\}$; N_2 is a minimal set ideal of S over the subsemigroup P_3 . But $N_3 = \{0, 3, 6\}$ is not a minimal set ideal of S over subsemigroup P_3 .

We see N_1 and N_2 are also minimal set ideals of S over P_3 , P_1 and P_2 .

Consider $N_4 = \{0, i_F, 1, 6, 6i_F\} \subseteq S$, a subsemigroup of S .

Take $B_1 = \{0, 3, 3i_F\} \subseteq S$; B_1 is a set ideal of S over N_4 which is also minimal.

We have seen examples of set ideals, minimal set ideals and maximal set ideals of the complex modulo integer semigroups.

Another class of semigroups using Z_n are dual number semigroup which is as follows:

$Z_n(g) = \{a + bg \mid a, b \in Z_n; g^2 = 0\}$ is a semigroup under product \times .

We will illustrate this situation by some examples.

Example 2.13: Let S be a dual number semigroup.

$S = Z_6(g) = \{a + bg \mid a, b \in Z_6, g = 2 \in Z_4, \text{ so that } g^2 = 0 \pmod{4}\}$. (S, \times) is a semigroup.

To find set ideals of S . Take $P_1 = \{3 + 3g, 0, 3\}$, P_1 is a semigroup of dual numbers.

Suppose $B = \{0, 2, 2g\} \subseteq S$ is a set ideal semigroup of dual numbers over the subsemigroup P_1 of S .

B is not a minimal set ideal.

However $B_1 = \{0, 2\} \subseteq S$ is a minimal set ideal of S over the subsemigroup P_1 of S .

$B_2 = \{0, 2g\} \subseteq S$ is also a minimal set ideal of S over the dual number subsemigroup P_1 of S .

$B_3 = \{0, 2g+2\}$ is a minimal set ideal of S over the dual number subsemigroup P_1 of S .

Example 2.14: Let $S = \{a + bg \mid a, b \in \mathbb{Z}_5, g = 6 \in \mathbb{Z}_{36}, \times\}$ be a dual number semigroup.

Consider $P = \{0, g, 2g, 3g, 4g\}$ a subsemigroup of S .

We see $T_1 = \{0, g\}$ is a minimal set ideal of S over P .

We have several such dual number minimal set ideals and dual number maximal set ideals over P .

Example 2.15: Let

$$S = \{a + bg_1 + cg_2 \mid a, b, c \in \mathbb{Z}_{12}, g_1 = 3, g_2 = 6; g_1, g_2 \in \mathbb{Z}_9\}$$

be a dual number semigroup of dimension two under product.

$P = \{3g_1, 5g_2, 0\}$ is a subsemigroup of S .

Now $S_1 = \{0, g_1\}$ is a dual number minimal set ideal of S over P .

Take $S_2 = \{0, 6g_2\} \subseteq S$; S_2 is also a dual number minimal set ideal of S over P .

$S_3 = \{0, g_1 + 2g_3\} \subseteq S$ is a minimal set ideal of dual number over a subsemigroup P of S .

$S_4 = \{0, 2g_1 + 8g_2\} \subseteq S$ is a dual number minimal set ideal of S over the subsemigroup P of S .

Let $M = \{0, 1+g_1, 3g_1, 5g_2\}$ be a set ideal of S over $P = \{0, 3g, 5g_2\}$. Clearly M is not a minimal set ideal of S over P for $\{3g_1, 0\} = M_1 \subseteq M$ is a minimal set ideal of S over P .

We see in this case part of a subsemigroup over which the set ideal is defined can also be a set ideal.

Also $M_2 = \{0, 5g_2\} \subseteq M$ is a minimal set ideal of S over P .

Example 2.16: Let $S = \{a_1 + a_2g_1 + a_3g_2 + a_4g_3 \mid a_i \in \mathbb{Z}_6; 1 \leq i \leq 4, g_1 = 5, g_2 = 10 \text{ and } g_3 = 15, g_j \in \mathbb{Z}_{25}; 1 \leq j \leq 3; \times\}$ be a dual number semigroup under product \times .

Let $P = \{0, g_1, g_2, g_3\} \subseteq S$ be a subsemigroup of S .

$M_1 = \{0, 3g_1\} \subseteq S$ is a minimal dual number set ideal of S over P .

$M_2 = \{0, 5g_2\} \subseteq S$ is a minimal dual number set ideal of S over P .

$M_3 = \{0, 4g_3\} \subseteq S$ is a minimal dual number set ideal of S over P .

$M_4 = \{0, 3g_1 + 2g_3\} \subseteq S$ is a minimal set ideal of S over P .

We have very many dual number set ideals which are minimal over P .

In view of all these examples we propose the following problems.

Problem 2.4: Let

$S = \{a + bg \mid a, b \in \mathbb{Z}_n, g \text{ the special number such that } g^2 = 0\}$ be a semigroup under product.

- (i) Find the number of subsemigroups of S .

- (ii) Find the total number of set ideals for each and every subsemigroups of S.
- (iii) How many of them are maximal set ideals?
- (iv) Find the total number of minimal set ideals?
- (v) Can a set ideal which is maximal over a subsemigroup say P_1 be a minimal set ideal over a subsemigroup P_2 ($P_1 \neq P_2$)?

Problem 2.5: Let $S = \{a_1 + a_2g_1 + a_3g_2 + \dots + a_tg_{t-1} \mid a_i \in \mathbb{Z}_n, 1 \leq i \leq t, g_j^2 = 0, g_j g_k = 0 \text{ if } j \neq k, 1 \leq j, k \leq t-1\}$ be a semigroup under product.

- (i) Find the number of subsemigroups of S.
- (ii) Find the total number of set ideals of S.
- (iii) Does the number subsemigroups depend on t?

Next we proceed onto find set ideals of semigroups of special dual like numbers.

We say $x = a + bg$ is a special dual like number if $g^2 = g$ and $a, b \in \text{reals or } \mathbb{Z}_n \text{ or complex numbers.}$

Example 2.17: Let

$S = \{a + bg \mid a, b \in \mathbb{Z}_6, g = 3 \in \mathbb{Z}_6; g^2 = g \pmod{6}\}$
 be a semigroup under product. Consider $M_1 = \{0, 3g\}$, $M_2 = \{0, g\}$, $M_3 = \{0, 4g\}$, $M_4 = \{0, 3, 3g\}$, $M_5 = \{0, g, 1\}$, $M_6 = \{0, 4, 4g\}$, $M_7 = \{0, 1, 5, g, 5g\}$ and so on. To find the set ideals of S over subsemigroups.

The set ideals of S over the subsemigroup M_1 is as follows:

$P_1 = \{0, 2g\}$, $P_2 = \{0, 2\}$, $P_3 = \{0, 4\}$, $P_4 = \{0, 4g\}$, $P_5 = \{0, 2, 2g\}$, $P_6 = \{0, 4, 2\}$, $P_7 = \{0, 4g, 2\}$, $P_8 = \{0, 4g, 2g\}$ and so on are set ideals of S over the subsemigroup M_1 .

Clearly P_1, P_2, P_3 and P_4 are minimal set ideals of special dual like numbers over the semigroup M_1 .

Example 2.18: Let $S = \{a + bg \mid a, b \in \mathbb{Z}_9; g = 4 \in \mathbb{Z}_{12}\}$ be the collection of all special dual like numbers (S, \times) is a semigroup.

$M_1 = \{0, 3g\}, M_2 = \{0, 3\}, M_3 = \{0, 6\}, M_4 = \{0, 6g\}, M_5 = \{0, 1, 8\}, M_6 = \{0, g, 8g\}, M_7 = \{0, 3g, 1\}, M_8 = \{0, 3, 1\}$ and so on are subsemigroups of S .

We can have set ideals over each of these subsemigroups.

Consider the subsemigroup $\{0, 3g\} = M_1$. The set ideals of S over the subsemigroup M_1 are as follows:

$P_1 = \{0, 3\}, P_2 = \{0, 6\}, P_3 = \{0, 6g\}, P_4 = \{0, 3, 6\}, P_5 = \{0, 3g, 6\}, P_6 = \{0, 3g, 6g\}, P_7 = \{0, 6g, 6\}, P_8 = \{0, 3, 3g\}, P_9 = \{0, 3g, 6, 6g\}, P_{10} = \{0, 3g, 3, 6g, 6\}$ and so on.

P_1, P_2 and P_3 are minimal set ideals of S over the subsemigroup M_1 of S .

$N_1 = \{0, 1, 3g\}, N_2 = \{0, 6g\}, N_3 = \{0, 1, 3g, 3\}, N_4 = \{0, 1, 3g, 6\}$ are all set ideals of S over M_1 which are neither minimal or maximal set ideals of S over M_1 .

Consider $T_1 = \{0, 2, 6g\}, T_2 = \{0, 4, 3g\}, T_3 = \{0, 2g, 6g\}, T_4 = \{0, 4g, 3g\}, T_5 = \{0, 2, 4, 2g, 4g, 6g, 3g\}, T_6 = \{0, 5, 6g\}, T_7 = \{0, 5g, 6g\}, T_8 = \{0, 7, 3g\}, T_9 = \{0, 7g, 3g\}, T_{10} = \{0, 8, 6g\}, T_{11} = \{8g, 6g, 0\}$ and so on are not set ideals over any subsemigroup $M_i, 1 \leq i \leq 8$.

Example 2.19: Let $S = \{a_1 + a_2g_1 + a_3g_2 \mid a_i \in \mathbb{Z}_4; 1 \leq i \leq 3\}, g_1 = 4$ and $g_2 = 9$ in \mathbb{Z}_{12} so that $4^2 \equiv 4 \pmod{12}$ and $9^2 \equiv 9 \pmod{12}, 4 \cdot 9 \equiv 0 \pmod{12}$ be the special dual like number semigroup of dimension two.

Consider the subsemigroups of S .

$M_1 = \{0, 2\}$, $M_2 = \{0, 2g_1\}$, $M_3 = \{0, g_1\}$, $M_4 = \{0, g_2\}$, $M_5 = \{0, 2g_2\}$, $M_6 = \{0, 1\}$, $M_7 = \{0, 1, 3\}$, $M_8 = \{0, 1, 3, g_1, 3g_1\}$, $M_9 = \{0, g_1, 3g_1\}$, $M_{10} = \{0, g_2, 3g_2\}$ and so on. We see there are many set ideal over the subsemigroups.

Consider the subsemigroup $M_2 = \{0, 2g_1\}$. The set ideals of S over the subsemigroup M_2 are as follows:

$W_1 = \{0, 2\}$, $W_2 = \{0, 2g_2\}$, $W_3 = \{0, 2 + 2g_1\}$, $W_4 = \{0, 2+2g_2\}$, $W_5 = \{0, 2g_1 + 2g_2\}$, $W_6 = \{0, 2 + 2g_1 + 2g_2\}$ are some of the minimal set ideals of S over the subsemigroup M_2 of S .

We can have many higher dimensional special dual like semigroups.

Next we proceed onto give examples of special dual like semigroups.

Example 2.20: Let

$S = \{a + bI \mid a, b \in \mathbb{Z}_{10}, \text{ and } I \text{ indeterminate such that } I^2 = I\}$ be the semigroup under product modulo 10.

The subsemigroups of S are $M_1 = \{0, I\}$, $M_2 = \{0, 5\}$, $M_3 = \{0, 5I\}$, $M_4 = \{0, 5+5I\}$, $M_5 = \{0, I, 9I\}$, $M_6 = \{0, 1, 9\}$ and so on.

We can have set ideals built using any of these subsemigroups.

Consider $M_1 = \{0, I\}$ the subsemigroup of S . The collection of set ideals of S over M_1 is as follows:

$P_1 = \{0, 1, I\}$, $P_2 = \{0, 2I\}$, $P_3 = \{0, 4I\}$, $P_4 = \{0, 3I\}$, $P_5 = \{0, 5I\}$, $P_6 = \{0, 6I\}$, $P_7 = \{0, 7I\}$, $P_8 = \{0, 8I\}$, $P_9 = \{0, 9I\}$, $P_{10} = \{0, I, 2I\}$, $P_{11} = \{0, I, 3I\}$, $P_{12} = \{0, I, 4I\}$ and so on are set ideals of S over the subsemigroup M_1 of S .

We see $P_1, P_2, P_3, \dots, P_9$ are all minimal set ideals of S over the subsemigroup M_1 of S .

These set ideals will also be known as the neutrosophic set ideals of the neutrosophic semigroup.

Example 2.21: Let

$S = \{a + bI \mid a, b \in \mathbb{Z}_{24}, I^2 = I \text{ is the indeterminate}\}$ be the semigroup under product.

$M_1 = \{0, I\}$ a subsemigroup of S . The set ideals over M_1 are $P_1 = \{0, 2I\}$, $P_2 = \{0, 3I\}$, $P_3 = \{0, 4I\}$... and $P_{22} = \{0, 23I\}$. All of them are minimal set ideals of S over the subsemigroup M_1 of S .

$N = \{0, a + bI, I, 2I, \dots, 23I, a, b \in \mathbb{Z}_{24} \setminus \{0\}, 2, 3, \dots, 22\} = S \setminus \{23\}$ is a maximal set ideal of S over M_1 .

Now having seen set ideals of special dual like number semigroups we now proceed on to give examples of set ideals of mixed dual number semigroups.

Example 2.22: Let $S = \{a_1 + a_2g_1 + a_3g_2 \mid a_i \in \mathbb{Z}_{12}; 1 \leq i \leq 3, g_1 = 4 \text{ and } g_2 = 6 \in \mathbb{Z}_{12}, g_1^2 \equiv 4 \pmod{12} \text{ and } g_2^2 \equiv 0 \pmod{12}, g_1g_2 \equiv 0 \pmod{12}\}$ be the semigroup of mixed dual numbers. Consider $M_1 = \{0, g_1\}$, $M_2 = \{0, g_2\}$ and $M_3 = \{0, g_1 + g_2\}$ subsemigroups of S .

The set ideals of S over the subsemigroup $M_1 = \{0, g_1\}$ is as follows:

$P_1 = \{0, g_2\}$, $P_2 = \{0, 2g_2\}$, $P_3 = \{0, 3g_2\}$, $P_4 = \{0, 4g_2\}$, ..., $P_{15} = \{0, 15g_2\}$, $B_1 = \{0, 2g_1\}$, $B_2 = \{0, 3g_1\}$, $B_3 = \{4g_1, 0\}$, $B_4 = \{0, 5g_1\}$, ..., $B_{16} = \{0, 15g_1\}$ are some of the minimal set ideals of S over the subsemigroup M_1 .

Example 2.23: Let $S = \{a_1 + a_2g_1 + a_3g_2 \mid a_i \in \mathbb{Z}_8; 1 \leq i \leq 43, g_1 = 5, g_2^2 = 10, g_1^2 = 5 \pmod{20}, g_2^2 = 0 \pmod{20} = g_1g_2 = g_2 \pmod{20}\}$ be a semigroup of mixed dual numbers. $M_1 = \{0, g_1\}$

is a subsemigroup. $M_2 = \{0, g_2\}$ is also a subsemigroup of S . We can have a collection of set ideals of S over M_1 and M_2 .

Now we say two subsemigroups S_1 and S_2 of a semigroup S are set ideally isomorphic if the collection of set ideals of S_1 over S is identical with the collection of set ideals of S_2 .

Problem 2.6: For any semigroup $S = \{Z_n, \times\}$ find set ideally isomorphic subsemigroups of S .

Example 2.24: Let $S = \{Z^+ \cup \{0\}, \times\}$ be a semigroup. Take $M_1 = \{0, 1\} \subseteq S$, a subsemigroup of S . Every subset of S is a set ideal of S over M_1 , be it finite or infinite we further see all sets $\{0, a\}$ where $a \in Z^+$ is a collection of minimal set ideals of S over M_1 .

However if we take $M_2 = \{0, 2Z^+\} \subseteq S$ to be a subsemigroup, all set ideals of S over M_2 are of infinite order.

Example 2.25: Let $S = \{a + bg \mid a, b \in Z^+ \cup \{0\}, g = 6 \in Z_{12} \text{ that is } g^2 = 6^2 \equiv 0 \pmod{12}; \times\}$ S is a semigroup of finite order. Take $M_1 = \{0, 1\}$ and $M_2 = \{0, g\}$ to be subsemigroups of S . We see the set ideals over M_1 are distinctly different from set ideals over M_2 .

However all set ideals over M_2 are set ideals over M_1 and not vice versa.

That is set ideals over M_1 in general is not a set ideal over M_2 .

Now we have seen examples of both finite and infinite semigroups and set ideals related with them. However all the semigroups considered by us are commutative.

Example 2.26: Let $S = \{a + bg \mid g_2 = -g, a, b \in Z_6, g = 8 \in Z_{12} \text{ } g^2 = -g = 4 \pmod{12}\}$ be a special quasi dual number semigroup of modulo integers.

$M_1 = \{0, g, 5g\}$, $M_2 = \{0, 1\}$, $M_3 = \{0, 3g\}$, $M_4 = \{0, 2g\}$, $M_5 = \{0, 4g, 2g\}$ and so on are subsemigroups of S .

The set ideals of S relative to the subsemigroup M_4 is as follows:

$P_1 = \{0, 1, 2g\}$, $P_2 = \{0, 3\}$, $P_3 = \{0, 3g\}$, $P_4 = \{0, 3+3g\}$, $P_5 = \{3, 3+3g, 0\}$, $P_6 = \{0, 3g, 3+3g\}$ and so on are set ideals of S over the subsemigroup M_4 of S .

Example 2.27: Let $S = \{a + bg \mid a, b \in \mathbb{Z}, g^2 = -g \text{ where } g = 15 \in \mathbb{Z}_{20}, 15^2 = 225 \pmod{20} = 5 \pmod{20} = -15 \pmod{20}\}$ be a semigroup of special quasi dual numbers.

$P_1 = \{1, -1, 0\}$ is a subsemigroup of S ; $P_2 = \{0, g, -g\}$ is a subsemigroup of S . All set $T_a = \{a, -a, 0\}$ with $a \in \mathbb{Z}$ is set ideal of S over P_1 ; however T_a is not a set ideal over P_2 .

Thus we get several set ideals of the special quasi dual number semigroup.

Example 2.28: Let $S = \{a_1 + a_2g_1 + a_3g_2 \mid a_i \in \mathbb{Z}_{12}; 1 \leq i \leq 3, g_1 = 4 \text{ and } g^2 = 8, g_1^2 = g_1 \pmod{12} \text{ and } g_2^2 = -g^2 = 4 \pmod{12}, g_1, g_2 \in \mathbb{Z}_{12}, \times\}$ be the semigroup of a mixed special quasi dual numbers.

The subsemigroups of S are $M_1 = \{0, g_1\}$, $M_2 = \{0, 1\}$, $M_3 = \{0, g_2, g_1\}$, $M_4 = \{0, (g_1+g_2), 2(g_1+g_2), 3(g_1+g_2), 4(g_1+g_2), 5(g_1+g_2)\}$. $M_5 = \{0, 6g_1\}$, $M_6 = \{0, 6\}$, $M_7 = \{0, 6g_2\}$ and $M_8 = \{0, 4\}$, $M_9 = \{0, 4g_1\}$.

$P_1 = \{0, 5\}$, $P_2 = \{0, 4\}$, $P_3 = \{0, 6\}$, $P_4 = \{0, 2\}$, $P_5 = \{0, 11\}$, $P_6 = \{0, 10\}$, $P_7 = \{0, 9\}$, $P_8 = \{0, 8\}$, $P_9 = \{0, 3\}$, $P_{10} = \{0, 7\}$ are all minimal set ideals of S over the subsemigroup $M_2 = \{0, 1\}$.

$T_1 = \{0, 2g_1\}$, $T_2 = \{0, 3g_1\}$, $T_3 = \{0, 4g_1\}$, $T_4 = \{0, 5g_1\}$, $T_5 = \{0, 6g_1\}$, $T_6 = \{0, 7g_1\}$, $T_7 = \{0, 8g_1\}$, $T_8 = \{0, 9g_1\}$,

$T_9 = \{0, 10g_1\}$ and $T_{10} = \{0, 11g_1\}$ are all minimal set ideals of S over the subsemigroup $M_2 = \{0, 1\}$ as well as $M_1 = \{0, g_1\}$.

Consider the subsemigroup $M_3 = \{0, g_1, g_2\}$ of S . The set ideals over M_3 are $W_1 = \{0, 2g_2, 2g_1\}$, $W_2 = \{0, 3g_1, 3g_2\}$, $W_3 = \{0, 4g_1, 4g_2\}$, $W_4 = \{0, 5g_1, 5g_2\}$, $W_5 = \{0, 6g_1, 6g_2\}$, $W_6 = \{0, 7g_1, 7g_2\}$, $W_7 = \{0, 8g_1, 8g_2\}$, $W_8 = \{0, 9g_1, 9g_2\}$, $W_9 = \{0, 10g_1, 10g_2\}$ and $W_{10} = \{0, 11g_1, 11g_2\}$ are all collection of minimal set ideals of S over the subsemigroup M_3 .

Example 2.29: Let $S = \{a_1 + a_2g_1 + a_3g_2 + a_4g_3 \mid a_i \in \mathbb{Z}_4, 1 \leq i \leq 4, g_1 = 4, g_2 = 6 \text{ and } g_3 = 8 \in \mathbb{Z}_{12}, g_1^2 = g_1 \pmod{12}, g_2^2 = 0 \pmod{12} \text{ and } g_3^2 = g_1 = -g_3 \pmod{12}\}$ be a semigroup of mixed special dual numbers.

Clearly $M_1 = \{0, g_1\}$, $M_2 = \{0, g_2\}$, $M_3 = \{0, g_1, g_2\}$, $M_4 = \{0, g_1, g_2, g_3\}$, $M_5 = \{0, 1\}$, $M_6 = \{0, 2\}$, $M_7 = \{0, 2g_1\}$, $M_8 = \{0, 2g_2\}$ and $M_9 = \{0, 2g_3\}$ are all subsemigroups of S .

We have set ideals over these subsemigroups some of which are minimal some maximal and some neither maximal nor minimal.

Now we just proceed onto describe non commutative semigroups.

Consider $S(n) = \{\text{set of all maps of the set } \{1, 2, \dots, n\} \text{ to itself}\}$; $S(n)$ is a symmetric semigroup.

Clearly $S(n)$ is non commutative. Using $S(n)$ we can define set ideals over subsemigroups.

$M_{m \times m} = \{\text{all } m \times m \text{ matrices with entries from } \mathbb{Z}_n, \mathbb{Z} \text{ or } \mathbb{Q} \text{ or } \mathbb{R}\}$ is again a non commutative semigroup under matrix product for under natural product; $M_{m \times m}$ is a commutative semigroup.

We can use subsemigroups $M_{m \times m}$ to build set ideals. This task is a routine so left as an exercise to the reader.

However it is pertinent to keep on record that we can have in case of non commutative semigroups left set ideals or set left ideals and right set ideals or set right ideals defined over a subsemigroup.

We now proceed onto define the notion of set Smarandache ideals defined over a group G in the semigroup.

DEFINITION 2.2: *Let S be a semigroup. $A \subseteq S$ be a subset of S which is a group under the operations of S .*

Let $P \subseteq S$ (a proper subset of S). If for all $p \in S$ and $a \in A$ pa and $ap \in P$ we define P to be a set Smarandache ideal of S over the group A of S .

We will now illustrate this situation by some examples.

Example 2.30: Let $S = \{0, 1, 2, 3, 4, 5\} = Z_6$ be a semigroup. $A = \{1, 5\} \subseteq S$ is a group. Consider $\{3, 0\} = P_1$ is a set Smaradache ideal of S over A .

$P_2 = \{0, 2, 4\} \subseteq S$ is a set Smarandache ideal of S over the group A .

Both are minimal set Smarandache ideals of S over the group A .

Example 2.31: Let $S = \{0, 1, 2, \dots, 14\}$ be a semigroup. $P_2 = \{13, 1\} \subseteq S$ be a group under product. $T = \{0, 2, 12\}$ is a set Smarandache ideal of S over the group P_2 .

Example 2.32: Let $S = \{C(Z_9), \times\}$ be a semigroup; $A = \{1, 8\}$ is a group of S .

$M_1 = \{2, 7\}$, $M_2 = \{3, 6\}$ and $M_3 = \{4, 5\}$ are set Smarandache minimal ideals of S over the group A .

$P = S \setminus \{0\}$ is a maximal set Smarandache ideal of S over the group A or well known strong set ideal of S over A [-].

Example 2.33: Let $S = \{a + bg \mid a, b \in \mathbb{Z}_{11}, g = 4 \in \mathbb{Z}_8\}$ be a dual number modulo integer semigroup under product.

$P = \{1, 2, \dots, 10\} \subseteq S$ is a group.

$M = \{0, g, 2g, \dots, 10g\} \subseteq S$ is a set Smarandache ideal of S over P which is neither maximal nor minimal.

Let $A = \{10, 1\} \subseteq S$ be a group in S . $P_1 = \{2, 9\}$, $P_2 = \{3, 8\}$, $P_3 = \{4, 7\}$ and $P_4 = \{5, 6\}$ are set Smarandache minimal dual number ideals of S over the group A .

Example 2.34: Let $S = \{\mathbb{Z}, \times\}$ be a semigroup. $A = \{-1, 1\}$ is a group in S .

Take $P_1 = \{2, -2\}$, $P_2 = \{3, -3\}$, $P_3 = \{4, -4\}$, $P_4 = \{5, -5\}$, ..., $P_n = \{n+1, -(n+1)\}$ ($n \in \mathbb{N}$) are all set Smarandache minimal ideals of S over the group A .

Example 2.35: Let $S = \{a + bg \mid a, b \in \mathbb{Z}_{10}, g = 3 \in \mathbb{Z}_6\}$ be the semigroup of special dual like numbers.

Let $A = \{1, 9\}$ be a group in S . $P_1 = \{2, 8\}$, $P_2 = \{3, 7\}$, $P_3 = \{34, 6\}$ and $P_4 = \{5\}$ are set Smarandache minimal ideals of S over A .

Inview of these results we have the following theorem.

THEOREM 2.1: Let $S = (\mathbb{Z}_n, \times)$ be a semigroup. $A = \{1, n-1\}$ be a group in S . S has atleast $(n/2) - 1$ set Smarandache minimal ideals over A if n is even and $(n-1)/2 - 1$ set Smarandache minimal ideals in case n is odd.

The proof is direct, hence left as an exercise to the reader.

We propose some open problems.

Problem 2.7: Let $S = (\mathbb{Z}_n, \times)$ (n an integer) be a semigroup.

- (i) Find the number of groups in S .
- (ii) Find the total number of set Smarandache ideals of S over these groups in S .
- (iii) Find the total number of set Smaradache minimal ideals of S over the group $A = \{1, n-1\}$.

Example 2.36: Let

$S = \{a + bg \mid a, b \in \mathbb{Z}_{15}, g = 8 \in \mathbb{Z}_{12}, g^2 = -g = 4 \in \mathbb{Z}_{12}, \times\}$
 be a semigroup.

Take $A = \{1, 14\} \subseteq S$ is a group. The set Smarandache ideals (strong set ideal) of S over A are $P_1 = \{2, 13\}$, $P_2 = \{0, 2, 13\}$, $P_3 = \{3, 12\}$, $P_4 = \{0, 3, 12\}$, $P_5 = \{4, 11\}$, $P_6 = \{0, 4, 11\}$, $P_7 = \{5, 10\}$, $P_8 = \{0, 5, 10\}$, $P_9 = \{6, 9\}$, $P_{10} = \{0, 6, 9\}$, $P_{11} = \{g, 14g\}$, $P_{12} = \{0, g, 14g\}$, $P_{13} = \{2g, 13g\}$, $P_{14} = \{0, 2g, 13g\}$, $P_{15} = \{0, 3g, 12g\}$, $P_{16} = \{3g, 12g\}$, $P_{17} = \{0, 4g, 11g\}$, $P_{18} = \{4g, 11g\}$, $P_{19} = \{5g, 10g\}$, $P_{20} = \{0, 5g, 10g\}$, $P_{21} = \{6g, 9g\}$, $P_{22} = \{0, 6g, 9g\}$, $P_{23} = \{7g, 8g\}$, $P_{24} = \{0, 7g, 8g\}$, $P_{25} = \{7, 8\}$, $P_{26} = \{0, 7, 8\}$, $P_{27} = \{0, g+1, 14g + 14\}$, $P_{28} = \{g+1, 14+14g\}$ $P_{29} = \{2g + 2, 13g + 13\}$ and so on.

Of these set Smarandache ideals some are minimal and some are neither minimal nor maximal.

Example 2.37: Let $S = \{a_1 + a_2g_1 + a_3g_2 \mid a_i \in \mathbb{Z}_{10}; 1 \leq i \leq 3, g_1 = 5, g_2 = 6 \in \mathbb{Z}_{10}, g_1^2 = g_1 \pmod{10}, g_2^2 = g_2 \pmod{10}, g_1 g_2 \equiv 0 \pmod{10}, \times\}$ be a two dimensional dual number semigroup.

$A = \{1, 9\}$ is a group in S . $P_1 = \{1 + g_1 + g_2, 9 + 9g_1 + 9g_2\}$ is a minimal set Smaradache ideal of S over A .

$P_2 = \{2, 8\}$, $P_3 = \{3, 7\}$, $P_4 = \{4, 6\}$ and $P_5 = \{5\}$ are set Smarandache minimal ideals of S over A .

Example 2.38: Let $S = \{a_1 + a_2g_1 + a_3g_2 \mid a_i \in \mathbb{Z}_{12}, 1 \leq i \leq 3, g_1 = 4, \text{ and } g_2 = 3 \text{ in } \mathbb{Z}_6. g_2^2 = g_2 \pmod{6} \text{ and } g_1^2 = g_1 \pmod{6} g_1 g_2 = 0 \pmod{6}, \times\}$ be a mixed special dual like number semigroup of dimension two. Let $A = \{1, 11\}$ be a group in S . We have several set Smarandache ideals some of which are maximal and some are minimal.

Let $P_1 = \{2, 10\}, P_2 = \{3, 9\}, P_3 = \{4, 8\}, P_4 = \{5, 7\}, P_5 = \{6\}, P_6 = \{0, 2, 10\}, P_7 = \{0, 3, 9\}, P_8 = \{0, 4, 8\}, P_9 = \{0, 5, 7\}, P_{10} = \{0, 6\}, P_{11} = \{1 + g_1 + g_2, 11 + 11g_1 + 11g_2\}, P_{12} = \{2 + 2g_1 + 2g_2 + 10g_1 + 10 + 10g_2\}$ and so on are some of the set Smarandache ideals of S over A some of which are minimal and others neither minimal nor maximal.

Example 2.39: Let $S = \{a + bg_1 + cg_2 \mid a, b, c \in \mathbb{Z}_{24}, g_1 = 3, g_2 = 6 \text{ in } \mathbb{Z}_9 \text{ so that } g_1^2 \equiv 0 \pmod{9} \text{ and } g_2^2 \equiv 0 \pmod{9}\}$ be a semigroup under product.

$A = \{1, 13\}$ is a group. $P_1 = \{2, 12\}, P_2 = \{3, 11\}, P_3 = \{4, 10\}, P_4 = \{5, 9\}, P_6 = \{6, 8\}, P_7 = \{7\}$ are all minimal set Smarandache ideals of S over A .

We can find several such set Smarandache ideals.

Now we proceed onto define the notion of set generalized Smarandache ideals of a semigroup over a S -semigroup.

DEFINITION 2.3: Let (S, \times) be a semigroup. A a Smarandache subsemigroup of S . If P is a set ideal over the subsemigroup A then we define P to be the set generalized Smarandache ideal of S over A .

We will illustrate this by some simple examples.

Example 2.40: Let $S = (\mathbb{Z}_{15}, \times)$ be a semigroup. Consider the S -subsemigroup $A = \{0, 5, 10\}$. Take $P_1 = \{0, 3, 6, 9\} \subseteq S$; P_1 is a set generalized Smarandache ideal of S over A .

$B = \{0, 3, 6, 9, 12\}$, B is a S -subsemigroup. $P_2 = \{0, 5\} \subseteq S$ is a set generalized Smarandache ideal of S over B .

Example 2.41: Let $S = \{Z_{24}, \times\}$ be a semigroup under product $A = \{0, 8, 16\} \subseteq S$ is a S -subsemigroup of S . $P_1 = \{0, 12\} \subseteq S$ is a set generalized Smarandache ideal of S over A . Infact P_1 is a minimal set generalized Smarandache ideal.

Example 2.42: Let $S = \{Z_{30}, \times\}$ be a semigroup. $A = \{0, 6, 12, 18, 24\}$ be a S -subsemigroup of S . $P_1 = \{0, 10\}$ is a set Smarandache generalized ideal of S over A .

Example 2.43: Let $S = \{Z_{18}, \times\}$ be a semigroup. $A = \{0, 6, 12\}$ be a S -subsemigroup of S . $P_1 = \{0, 3\}$ is a set Smarandache generalized ideal of S over A . Infact P_1 is minimal.

Example 2.44: Let $S = \{Z_{35}, \times\}$ be a semigroup. $A = \{0, 5, 10, 15, 20, 25\}$ is a S subsemigroup. Take $P_1 = \{7, 0\}$, P_1 is a set Smarandache generalized (general) ideal of S over A . P_1 is infact minimal. However $P_2 = \{0, 7, 14\} \subseteq S$ is also a set Smarandache generalized ideal of S over A which is neither maximal nor minimal over A .

Example 2.45: Let $S = \{Z_{55}, \times\}$ be a semigroup. $A = \{0, 11, 22, 33, 44\}$ is a S -semigroup. $P_1 = \{0, 5\}$ is a set Smarandache generalized minimal ideal of S over A .

$P_2 = \{0, 5, 10, 20, 25\}$ is a set Smarandache generalized ideal of S over A .

Example 2.46: Let $S = \{Z_{26}, \times\}$ be a semigroup.

$A = \{0, 2, 4, 6, 8, 10, 12, 14, 16, 18, 20, 22, 24\}$ be a S -subsemigroup of S . Take $P_1 = \{0, 13\} \subseteq S$; P_1 is a set generalized minimal ideal of S over A .

Inview of all these informations from these examples we give the following theorem the proof of which is left as an exercise to the reader.

THEOREM 2.2: *Let $S = \{Z_{pq}, \times \mid p \text{ and } q \text{ are two distinct primes}\}$ be a semigroup. S is a S -semigroup and has set generalized minimal ideals.*

We just give the hint for the proof of this theorem.

$A = \{0, p, 2p, \dots, (q-1)p\} \subseteq S$ is a S -subsemigroup and $P_1 = \{0, g\}$ is a set generalized minimal ideal of S over A or $B = \{0, q, 2q, \dots, (p-1)q\} \subseteq S$ is a S -subsemigroup of S and $P_2 = \{0, p\}$ is a set generalized minimal ideal of S over B .

The reader is left with the task of finding set maximal generalized ideals of $S = Z_{pq}$.

Now having seen examples of minimal, maximal Smarandache and generalized Smarandache set ideals of S of semigroup we now proceed onto describe prime set ideals of a semigroup.

DEFINITION 2.4: *Let S be a semigroup. P a set ideal of S over the subsemigroup A of S . If $x \in P$ is such that $x = ab$ and if both a and b are not in P then we say P is a prime ideal ($a \neq x$ and $b \neq x$).*

We will give examples of this situation.

Example 2.47: Let $S = \{Z_{20}, \times\}$ be a semigroup. $A = \{0, 5, 10, 15\}$ be a subsemigroup of S . $P_1 = \{0, 4\}$ is a minimal set ideal of S over A . Clearly P_1 is not a prime set ideal of S over A .

Let $P_2 = \{0, 4, 8\}$ be a set ideal of S over A . P_2 is not a minimal set ideal of S over A . P_2 is not a prime set ideal of S over A .

$P_3 = \{0, 6\} \subseteq S$ is a minimal set ideal of S and P_3 is not a prime set ideal of S over A .

Consider $P_4 = \{0, 2, 4, 6, 8, 10, 12, 14, 16, 18\} \subseteq S$, P_4 is a set ideal of S over A is a prime set ideal of S over A , however P_4 is not a maximal set ideal of S .

Thus we wish to state the following problems.

Problem 2.8: If S is a semigroup. $P \subseteq S$ is a subsemigroup of S . M a set ideal of S .

- (i) Is every maximal set ideal of S over P prime?
- (ii) Do we have set ideals which are not maximal over P to be prime?
- (iii) Can we say all minimal set ideals are not prime?

Example 2.48: Let $S = \{\mathbb{Z}, \times\}$ be a semigroup. $P = \{-1, 1\}$ be a subsemigroup of S . $P_1 = \{2, -2\}$, $P_2 = \{3, -3\}$, $P_4 = \{4, -4\}$, ..., $P_n = \{(n+1), -(n+1)\}$ are set ideals of S over P .

Infact every one of them is minimal set ideal of S over P . Further all these are not prime ideals. However $\langle 2\mathbb{Z} \rangle = M$ is a prime set ideal of S over the subsemigroup P .

Now we see if S is any semigroup. P_1 and P_2 two subsemigroups of S . Let M_1 and M_2 be set ideals of S over P_1 and P_2 respectively.

Can we say $M_1 \cap M_2$ is a set ideal of S over $P_1 \cap P_2$?

We will illustrate this situation by some simple examples.

Example 2.49: Let $S = \{\mathbb{Z}_{12}, \times\}$ be a semigroup. $P_1 = \{0, 3, 6, 9\}$ and $P_2 = \{0, 2, 4, 6, 8, 10\}$ be subsemigroups of S .

Take $M_1 = \{0, 4, 8\} \subseteq S$, M_1 is a set ideal of S over P_1 . $M_2 = \{6, 0\} \subseteq S$, M_2 is a set ideal of S over P_2 . We see $M_1 \cap M_2 = \{0\}$ and $P_1 \cap P_2 = \{0, 6\}$. We see $M_1 \cap M_2$ is only a trivial or zero set ideal of S over $P_1 \cap P_2 = \{0, 6\}$.

Thus we can say in this case $\{0\}$ is the set ideal.

Example 2.50: Let $S = \{\mathbb{Z}_{30}, \times\}$ be a semigroup. $T_1 = \{0, 10, 20\}$ and $T_2 = \{0, 6, 12, 18, 24\}$ be two subsemigroups.

Clearly we see $T_1 \cap T_2 = \{0\}$ so we cannot think of set ideals over $T_1 \cap T_2$.

$P_1 = \{0, 10, 20\}$ and $P_2 = \{0, 5, 10, 20, 25, 15\}$ be two subsemigroups of S . Clearly $P_1 \cap P_2 = P_1$.

Consider $S_1 = \{0, 15, 6\} \subseteq S$, S_1 is a set ideal over P_1 , $S_2 = \{0, 2, 10, 20\}$ be a set ideal over P_2 .

We see $P_1 \cap P_2 = P_1$ but $S_1 \cap S_2 = \{0\}$.

Thus we may or may not get the intersection of two set ideals to be a set ideals.

Example 2.51: Let $S = \{\mathbb{Z}_{24}, \times\}$ be a semigroup. $P_1 = \{0, 8, 16\}$ and $P_2 = \{6, 0, 12, 18\}$ be subsemigroups of S . We see $P_1 \cap P_2 = \{0\}$ but $T = \{0, 2, 4, \dots, 22\}$ is a set ideal of S over both P_1 and P_2 .

In general union of two subsemigroup is not a subsubsemigroup. For even $P_1 \cup P_2$ is not a subsemigroup.

So none of the theories about set ideals can be compatible with usual ideals.

However we just mention by passing the following result, the proof of which is left as an exercise to the reader.

THEOREM 2.3: *Let S be a semigroup. If P is a set Smarandache ideal (set Smarandache general ideal) over a group A (or over a S -subsemigroup A), then P is a set ideal over A . However the converse is not true.*

The proof follows from the very definition. For the converse we request the reader to construct a counter example.

Finally we keep in record the set Smarandache ideals are the strong set ideals mentioned in [7]. We have used the term set Smarandache ideals mainly to show that the semigroups taken under for construction is a S-semigroup [6]. All other definitions of set ideals can be studied as a matter of routine for such elaborate study is carried out in the book on set ideal topological spaces [14].

Finally we just indicate how set ideal topological space of a semigroup S relative to a subsemigroup S_1 of S is built.

We just recall $S = (Z, \times)$ is a semigroup. $S_1 = \{0, 1, -1\}$ is a subsemigroup of S.

$P = \{\text{Collection of all set ideals of S over the subsemigroup } S_1 \text{ of S}\}$ is a set ideal topological space of S the semigroup over the subsemigroups S_1 of S [6].

The lattice associated with P is an infinite lattice with $\{0\}$ as the least element and Z as the greatest element and $\{0, -a, a\}$ where $a \in \mathbb{N}$ are the atoms. Infact the lattice associated with P has an infinite number of atoms.

Similarly $\{C, \times\}$ be the complex semigroup, $S_1 = \{0, -1, 1\}$ is a subsemigroup of S. Infact $P = \{\text{Collection of all set ideals of S over the subsemigroup } S_1 \text{ of S}\}$ be the set ideal topological space associated with the semigroup S over the subsemigroup S_1 of S. Clearly Z can be replaced by R or Q and $S_1 = \{0, -1, 1\}$ will continue to be the subsemigroup of R or Q and we can get the set ideal topological space of R or Q over S_1 .

Infact P_z is the set ideal topological space of (Z, \times) associated with the subsemigroup $S = \{0, -1, 1\}$,

P_Q be the set ideal topological space of the semigroup (Q, \times) over the subsemigroup $S = \{0, 1, -1\}$,

P_R be the set ideal topological space of the semigroup (R, \times) over the subsemigroup $S = \{0, -1, 1\}$ and

P_C be the set ideal topological space of the semigroup (C, \times) over the subsemigroup $S_1 = \{0, -1, 1\}$.

We see $P_Z \subsetneq P_Q \subsetneq P_R \subsetneq P_C$ of course the containment relation is strict.

However if Z or Q or R or C is used as ring certainly this form of relation is not possible as $S = \{-1, 0, +1\}$ is not a ring.

Now consider the integer neutrosophic semigroup $S = \langle Z \cup I \rangle = \{a + bI \mid a, b \in Z\}$ under product.

$S_1 = \{0, 1, I\}$ be the subsemigroup of S .

$P_{\langle Z \cup I \rangle} = \{\text{Collection of all set ideal of } S \text{ over the subsemigroup } S_1 \text{ of } S\}$ be the neutrosophic set ideal topological space of the semigroup $(\langle Z \cup I \rangle, \times)$ over the subsemigroup $S = \{1, I, 0\}$.

Let $S = \langle Q \cup I \rangle$ be the rational neutrosophic semigroup under product.

$S_1 = \{0, I, 1\}$ be the subsemigroup of $\langle Q \cup I \rangle$.

$P_{\langle Q \cup I \rangle} = \{\text{Collection of all set ideals of } S = \langle Q \cup I \rangle \text{ over the subsemigroup } S_1 = \{0, 1, I\}\}$ be the rational neutrosophic set ideal topological space of $\langle Q \cup I \rangle$ over the subsemigroup S_1 of $\langle Q \cup I \rangle$.

Let $\langle R \cup I \rangle$ be the neutrosophic semigroup of reals under \times . Let $S_1 = \{0, 1, I\}$ be a subsemigroup of $\langle R \cup I \rangle$.

$P_{\langle R \cup I \rangle} = \{\text{Collection of all set ideals of } S = \langle R \cup I \rangle \text{ over the subsemigroup } S_1 = \{0, 1, I\}\}$ be the real neutrosophic set ideal topological space of $\langle R \cup I \rangle$ over S_1 .

Finally let $\langle C \cup I \rangle = \{a + bi + cI \mid a, b, c \in \mathbb{R}\}$ be the complex neutrosophic semigroup under product. $S = \{0, 1, I\}$ be a subsemigroup of $\langle C \cup I \rangle$.

$P_{\langle C \cup I \rangle} = \{\text{collection of all set ideals of } \langle C \cup I \rangle \text{ over the subsemigroup } S_1 = \{0, 1, I\}\}$ be the complex neutrosophic set ideal topological subspace of $\langle C \cup I \rangle$ over the subsemigroup $S_1 = \{0, 1, I\}$.

$$\text{Clearly } P_{\langle Z \cup I \rangle} \subsetneq P_{\langle Q \cup I \rangle} \subsetneq P_{\langle R \cup I \rangle} \subsetneq P_{\langle C \cup I \rangle}.$$

We see $P_{\langle Z \cup I \rangle}$ is a set ideal neutrosophic integer topological space, $P_{\langle Q \cup I \rangle}$ is the set ideal neutrosophic rational topological space. $P_{\langle R \cup I \rangle}$ is the set ideal neutrosophic real topological space and $P_{\langle C \cup I \rangle}$ is the set ideal neutrosophic complex topological space.

Now let $Z(g) = \{a + bg \mid a, b \in \mathbb{Z}, g^2 = 0\}$ be the semigroup of integer dual numbers, $Q(g) = \{a + bg \mid a, b \in \mathbb{Q}, g^2 = 0\}$ be the semigroup of rational dual numbers $R(g) = \{a + bg \mid a, b \in \mathbb{R}, g^2 = 0\}$ be the semigroup of real dual numbers and

$C(g) = \{a + bg \mid a, b \in \mathbb{C}, g^2 = 0\}$ be the semigroup of complex dual numbers.

$$\text{We see } Z(g) \subsetneq Q(g) \subsetneq R(g) \subsetneq C(g).$$

Now $S_1 = \{0, \pm 1\}$ be the subsemigroup of $Z(g)$, $Q(g)$, $R(g)$ and $C(g)$. $P_{Z(g)}$, $P_{Q(g)}$, $P_{R(g)}$ and $P_{C(g)}$ be the set ideal topological spaces of semigroup $Z(g)$, $Q(g)$, $R(g)$ and $C(g)$ respectively over the subsemigroup, $S_1 = \{0, 1, -1\}$.

Clearly $P_{Z(g)} \subsetneq P_{Q(g)} \subsetneq P_{R(g)} \subsetneq P_{C(g)}$ we see the set ideal topological space of dual integers is a proper set ideal topological subspace of the set ideal topological space of dual rational numbers.

$P_{Q(g)}$ is the proper set ideal topological subspace of dual real numbers $P_{R(g)}$ and $P_{R(g)}$ is the set ideal dual real numbers topological subspace of $P_{C(g)}$.

Now we can on similar lines define:

$Z(g_1) = \{a + bg_1 \mid a, b \in Z, g_1^2 = g_1\}$ be the semigroup of special dual like integer numbers.

$Q(g_1) = \{a + bg_1 \mid a, b \in Q, g_1^2 = g_1\}$ be the semigroup of special dual like rational numbers.

$R(g_1) = \{a + bg_1 \mid a, b \in R; g_1^2 = g_1\}$ be the semigroup of special dual like real numbers and

$C(g_1) = \{a + bg_1 \mid g_1^2 = g_1\}$ be the semigroup of special dual like complex numbers.

We can have $P_{Z(g_1)} \subsetneq P_{Q(g_1)} \subsetneq P_{R(g_1)} \subsetneq P_{C(g_1)}$ where $P_{Z(g_1)}$, $P_{Q(g_1)}$, $P_{R(g_1)}$ and $P_{C(g_1)}$ are set ideal topological spaces of special dual like numbers.

Finally we see $Z(g_2) = \{a + bg_2 \mid g_2^2 = -g_2, a, b \in Z\}$ be the semigroup of special quasi dual integer numbers.

$Q(g_2) = \{a + bg_2 \mid a, b \in Q; g_2^2 = -g_2\}$ be the semigroup of special quasi dual rational numbers. $R(g_2) = \{a + bg_2 \mid a, b \in R, g_2^2 = -g_2\}$ be the semigroup of special quasi dual real numbers and

$C(g_2) = \{a + bg_2 \mid a, b \in C, g_2^2 = -g_2\}$ be the semigroup of special quasi dual complex numbers.

The corresponding set ideal topological spaces over these semigroups will be known as the set ideal topological space of special quasi dual integer (real or rational complex) number.

We can replace Z , Q , R and C by $\langle Z \cup I \rangle$, $\langle Q \cup I \rangle$, $\langle R \cup I \rangle$ and $\langle C \cup I \rangle$ and

$\langle Z \cup I \rangle (g) = \{\text{collection of all neutrosophic integer dual numbers}\}$

$\langle Q \cup I \rangle (g) = \{a + bg \mid a, b \in \langle Q \cup I \rangle\}$ is the neutrosophic rational dual numbers.

$\langle R \cup I \rangle (g) = \{a + bg \mid a, b \in \langle R \cup I \rangle, g^2 = g\}$ be the neutrosophic real dual numbers and

$\langle C \cup I \rangle (g) = \{a + bg \mid a, b \in \langle C \cup I \rangle; g^2 = g\}$ be the collection of neutrosophic complex dual numbers.

Likewise we can define

$$\langle Z \cup I \rangle (g_1) = \{a + bg_1 \mid a, b \in \langle Z \cup I \rangle, g_1^2 = g_1\}$$

to be the semigroup of neutrosophic integer special dual like numbers

$\langle Q \cup I \rangle (g_1) = \{a + bg_1 \mid a, b \in \langle Q \cup I \rangle, g_1^2 = g_1\}$ be the semigroup of neutrosophic rational special dual like numbers.

$\langle R \cup I \rangle (g_1) = \{a + bg_1 \mid a, b \in \langle R \cup I \rangle, g_1^2 = g_1\}$ be the semigroup of neutrosophic real special dual like numbers and

$\langle C \cup I \rangle (g_1) = \{a + bg_1 \mid a, b \in \langle C \cup I \rangle, g_1^2 = g_1\}$ be the semigroup of neutrosophic complex special dual like numbers.

Using these four semigroups of neutrosophic special dual like numbers we can build set ideal topological neutrosophic special dual like numbers.

Likewise we can define semigroups of neutrosophic special quasi dual numbers of four types $\langle Z \cup I \rangle (g_2)$, $\langle Q \cup I \rangle (g_2)$, $\langle R \cup I \rangle (g_2)$ and $\langle C \cup I \rangle (g_2)$ where $g_2^2 = -g_2$.

Corresponding to these four types of semigroups of neutrosophic special quasi dual numbers we can build the set ideal topological neutrosophic special quasi dual numbers.

We have seen all new types of set ideal topological spaces of infinite order.

Now we proceed onto define the notion of set ideal topological spaces of finite semigroups.

Let $S = (Z_n, \times)$ be a semigroup. If $S_1 = \{0, 1\}$ is a subsemigroup of (Z_n, \times) then $P = \{\text{Collection of all set ideals of } S \text{ over the subsemigroup } S_1 \text{ of } S\}$ be the set ideal topological space of S over S_1 . Clearly P is of finite order.

By varying the subsemigroup S_1 of S we get very many distinct set ideal topological spaces of the semigroup (Z_n, \times) over subsemigroups of S .

Let $S = \{C(Z_n) = \{a + bi_F \mid a, b \in Z_n, i_F^2 = n-1\}\}$ be a semigroup under \times . $S_1 = \{0, 1\}$ be the subsemigroup of S . $P = \{\text{collection of all set ideals of } S \text{ over } S_1\}$. P is a set ideal topological space of S over S_1 of finite order; will be known as the set ideal complex modulo integer topological space of S over S_1 .

$S = Z_n(g) = \{a + bg \mid a, b \in Z_n, g^2 = g\}$ be the semigroup of dual numbers. $S_1 = \{0, 1\}$ be a subsemigroup of S .

$P = \{\text{Collection of all set ideals of } S \text{ over the subsemigroup } S_1 \text{ of } S\}$ be the set ideal topological space of dual number modulo integers.

Let $S = Z_n(g_1) = \{a + bg_1 \mid a, b \in Z_n, g_1^2 = g_1\}$ be the semigroup of special dual like number of modulo integers $S_1 = \{0, 1\}$ be a subsemigroup of S .

$P = \{\text{Collection of all set ideals of } S \text{ over } S_1\}$ be the set ideal modulo integer topological space of special dual like numbers.

Now let $S = \{a + bg_2 \mid a, b \in Z_n, g_2^2 = -g_2\} = Z_n(g_2)$ be the semigroup of special quasi dual numbers. Let $S_1 = \{0, 1\}$ be a subsemigroup of S .

$P = \{\text{Collection of all set ideals of special quasi dual numbers}\}$ is the set ideal modulo integer topological space of special quasi dual numbers over S_1 .

We get several such set ideal topological spaces by varying the subsemigroups. Thus if $Z_n(g)$ has say m number of subsemigroups then we have m set ideal topological spaces of dual numbers for each of these m subsemigroups S_m of S .

Now if $S = Z_n(g_1, g_2)$ be the semigroup of mixed dual numbers and if S has say some t number of subsemigroups then for this S we have t number of set ideal topological spaces all of them are of finite order.

Now if $S = \langle Z_n \cup I \rangle$ be the neutrosophic semigroup under product and if S has say q number of distinct proper subsemigroups then associated with S we have q number of set ideal neutrosophic topological spaces of S over each of the q subsemigroups.

Suppose

$S = \langle Z_n \cup I \rangle (g_1) = \{a + bI \mid a, b \in \langle Z_n \cup I \rangle, g_1^2 = g_1\}$ be the neutrosophic dual number semigroup and if S has m number of subsemigroups. Then associated with S we have m number of set ideal topological spaces of neutrosophic dual numbers over each of these m subsemigroups.

$S = C(Z_n)(g_1) = \{a + bg_1 \mid a, b \in C(Z_n) = \{x + yi_F \mid x, y \in Z_n, i_F^2 = n-1, g_1^2 = 0\}$ under product is a finite complex modulo

integer semigroup of dual numbers. Take $S_1 = \{0, 1\}$ a subsemigroup of S .

$P_1 = \{\text{Collection of all set ideals of } S \text{ over } S_1\}$ is a set ideal topological space of finite complex modulo integer dual numbers over the subsemigroup S_1 .

By varying the subsemigroups of S we can get several set ideal topological spaces of finite complex modulo dual numbers.

Next if we take $S = C(\mathbb{Z}_n) (g_1, g_2, \dots, g_t) = \{a_1 + a_2g_1 + \dots + a_{t+1}g_t \mid g_i^2 = 0, g_i g_j = 0 \text{ if } i \neq j; a_j \in C(\mathbb{Z}_n), 1 \leq j \leq t+1\}$ under product S is a semigroup of higher dimensional finite complex modulo integer dual numbers.

We can take any subsemigroup $S_1 \subseteq S$ and find $P_1 = \{\text{Collection of all set ideals of } S \text{ over } S_1\}$ to be the set ideal topological space of finite complex modulo integers of higher dimension over the subsemigroup S_1 of S .

By varying S_1 the subsemigroup we get many set ideal topological space of finite complex modulo integer higher dimensional dual numbers.

Next we can define finite complex modulo integer special dual like numbers semigroups.

Let $C(\mathbb{Z}_n) (g_1) = \{a + bg_1 \mid a, b \in C(\mathbb{Z}_n), g_1^2 = g_1\}$ be the finite complex modulo integer special dual like number semigroup. Let $S_1 = \{0, 1\}$ or $S_2 = \{0, g_1\}$ be subsemigroup of S under product.

We can define

$P_i = \{\text{Collection of all set ideals of } S \text{ over the subsemigroup } S_i\}$ be the set ideal topological space of special dual like finite complex modulo integers of S over $S_i, 1 \leq i \leq 2$.

Further we can also define set ideal topological space of finite complex modulo integers of special quasi dual numbers.

Let $C(\mathbb{Z}_n) (g_2) = \{a + bg_2 \mid a, b \in C(\mathbb{Z}_n), g_2^2 = -g_2\}$ be the semigroup of finite complex modulo integer special quasi dual numbers under \times .

$S_1 = \{0, 1\}$, $S_2 = \{0, i_F, (n-1), (n-1)i_F\}$ and so on be some subsemigroups of S .

Let $P_i = \{\text{Collection of all set ideals of } S \text{ over the subsemigroup } S_i \text{ of } S\}$ be the set ideal topological space of special quasi dual number of modulo finite complex integers over S_i of S $1 \leq i \leq 2$.

By varying the subsemigroups we can get many such set ideal topological spaces of finite order of S over S_i for every subsemigroup S_i of S .

We can also have mixed dual numbers and mixed special dual numbers which we shall describe by an example or two.

Let $S = C(\mathbb{Z}_n) (g_1, g_2) = \{a_i + a_2g_1 + a_2g_2 \mid a_i \in C(\mathbb{Z}_n), 1 \leq i \leq 3, g_1^2 = 0, g_2^2 = g_2, g_1g_2 = g_2g_1 = 0\}$ be a semigroup of mixed dual finite complex modulo numbers.

Take $S_1 = \{1, 0\}$, $S_2 = \{0, g_1\}$, $S_3 = \{0, g_2\}$ be some of the subsemigroups of S .

$P_i = \{\text{Collection of all set ideals of } S \text{ over } S_i\}$ be the set ideal topological space of finite complex modulo integer dual mixed numbers over S_i of S , $1 \leq i \leq 3$.

By taking various subsemigroup of S we get several set ideal topological spaces of S related to these subsemigroups.

Let $S = C(\mathbb{Z}_n) (g_1, g_2, g_3) = \{a_1 + a_2g_1 + a_3g_2 + a_4g_3 \mid a_i \in C(\mathbb{Z}_n); 1 \leq i \leq 4; g_1^2 = 0, g_2^2 = g_2 \text{ and } g_3^2 = -g_3 \text{ with } g_i g_j = 0 \text{ or}$

g_1 or g_2 or $g_3, 1 \leq i, j \leq 3$ under product be a semigroup of mixed finite complex modulo integer special dual number.

Take $S_1 = \{0, 1\}$, $S_2 = \{0, i_F, (n-1), (n-1)i_F\}$, $S_3 = \{0, g_1\}$, $S_4 = \{0, g_2\}$, $S_5 = \{0, 1, g_1\}$, $S_6 = \{0, 1, g_2\}$, $S_7 = \{0, g_3, g, g_2\}$ and so on.

Let $P_i = \{\text{Collection of all set ideals of } S \text{ over } S_i \text{ of } S\}$ be the set ideal topological space of mixed special dual numbers over $S_i; 1 \leq i \leq 7$.

We can get as many number of set ideal topological spaces as the subsemigroups of S .

Finally it is interesting to note we can have several such set ideals topological spaces; we can also define set right ideal topological spaces or set left ideal topological spaces by taking semigroups which are non commutative.

Thus sets in semigroup S play a major role in building various number of set ideal topological spaces using S .

Chapter Three

SET IDEALS IN RINGS

In this chapter we proceed onto describe the use of sets in the rings. When a set a is contained in a ring R we see we can define set ideals of R .

Throughout this book R is a ring commutative or otherwise. We now recall the definition of set ideals of a ring R .

DEFINITION 3.1: *Let R be a ring, P a proper subset of R . S a proper subring of R . P is called a set left ideal of R relative to the subring S or R (or over the subring S of R) if for all $s \in S$ and $p \in P$, $sp \in P$. One can similarly define set right ideal of R if $ps \in P$ for all $p \in P$ and $s \in S$. We say P is a set ideal if ps and $sp \in P$; for all $s \in S$ and $p \in P$.*

We will give examples of this situation.

Example 3.1: Let $R = (\mathbb{Z}_{40}, +, \times)$ be the ring $A = \{0, 10, 20, 30\}$ be the subring of R .

Consider $X = \{0, 4, 8, 16, 24, 28, 32, 36\} \subseteq R$, X is a set ideal of R over the subring A of R .

Consider $X_1 = \{12, 0\} \subseteq R$, X_1 is again a set ideal of R over the subring A over R .

Example 3.2: Let $R = (\mathbb{Z}_{24}, +, \times)$ be a ring. $A = \{0, 12\}$ is a subring of R . $X = \{0, 4, 6, 8, 16\}$ is a set ideal of R over the subring A of R . $Y = \{0, 10, 4\}$ is a set ideal of R over the subring A of R .

Example 3.3: Let $R = (\mathbb{Z}_{100}, +, \times)$ be a ring. $A = \{0, 10\}$ is a subring of R . $X = \{0, 20, 30, 40, 50, 80\}$ is a set ideal of R over the subring A of R . Let $A_1 = \{0, 25, 50, 75\}$ be a subring of R .

$Y = \{0, 4, 8, 12, 20, 16\}$; Y is a set ideal of R over the subring A_1 of R .

Example 3.4: Let $R = (\mathbb{Z}_{60})$ be a ring. $A = \{0, 30\}$ be the subring of R . Let $X = \{0, 20, 2, 4, 8\}$ is a set ideal of R over the subring A of R .

$Y = \{0, 12, 10, 14\}$ is again a set ideal of the ring R over the subring A of R .

Clearly in a ring R if S is a subring. A set ideal X of the ring R over the subring S need not in general be a set ideal over the subring S_1 of R .

It is easy to verify every ideal of a ring is a set ideal of R for every subring of R .

So we have not in any way disturbed the ideal theory but only broadened it and generalized it without affecting the existing classical theorems. As of today the work with sets will be more useful and simple for any non mathematician also.

Further for the ring of integers \mathbb{Z} there exists no finite set $\{0\} \neq P \subseteq \mathbb{Z}$ which is a subring S of \mathbb{Z} .

Let R be a ring. $P \subseteq R$ is a set ideal of R over a subring S of R we say P is a prime set ideal of R over S if for $x = pq \in P$; p or q is in P .

It is pertinent to record here that as in case of usual ideals in case of set ideals also $\{0\}$ is always an element of it; however if 1 is an element of the set ideal P defined over the subring S then it is essential that $S \subseteq P$.

Thus once again we keep on record that we have not destroyed any of the classical flavour of ring theory. But at the same time give a nice structure to subsets in a ring.

We can define as in case of usual ideal the concept of maximal set ideals and minimal set ideals over subrings of a ring R [7].

We give only illustrations of them.

Example 3.5: Let $R = Z_{16}$ be the ring. $S = \{0, 8\}$ be a subring of R . $P_1 = \{0, 2\}$, $P_2 = \{0, 4\}$ and $P_3 = \{6, 0\}$ are all minimal set ideals of R over S .

$T = \{0, 2, 4, 6, 10, 12, 14, 3, 8, 5, 7, 9, 11, 13, 15\}$ is a maximal ideal of R over the subring $\{0, 8\}$.

Example 3.6: Let $R = Z_{12} = \{0, 1, 2, \dots, 11\}$ be the ring.

$P = \{0, 6\}$ be a subring of Z_{12} . $T_1 = \{0, 2\}$, $T_2 = \{0, 4\}$, $T_3 = \{0, 8\}$ and $T_4 = \{0, 10\}$ are all minimal set ideals of R over the subring P .

$M = \{0, 2, 4, 8, 10, 6, 3, 9, 6, 7\}$ is a maximal set ideal of R over the subring $P = \{0, 6\}$.

Several interesting properties are derived [7].

The notion of pseudo set ideals is very interesting.

We leave it as an open problem.

Problem 3.1: Characterize the pseudo set ideals of a ring Z_n .

Does there exist a finite ring which has no pseudo set ideals?

Another nice property of set ideals in a ring is we need not waste time working with all elements of a ring only a subring S will do the work and a set in R will be a set ideal of R over the subring S of R . We can as in case of usual ideals define set quotient ideals [7].

We have obtained several interesting properties of set quotient ideals. We just recall the definition.

Let R be a ring, P a set ideal of R over the subring S of R (P is only a subset of R). Then R/P is the set quotient ideal if and only if R/P is a set ideal of R relative to the same subring S of R .

Example 3.7: Let $R = Z_{10}$ be the ring, $S = \{0, 5\}$ be a subring $P = \{0, 2, 4, 8\}$ is a set ideal of R over S .

$Z_{10}/P = \{P, 1+P, 3+P, 9+P, 5+P, 6+P, 7+P\}$. Clearly Z_{10}/P is a quotient set ideal of R relative to the subring $S = \{0, 5\} \subseteq R$.

Example 3.8: Let $Z_{14} = R$ be a ring. $S = \{0, 7\} \subseteq R$ be a subring of R . $P_1 = \{0, 2, 4, 8, 10\}$ be a set ideal of R over S . The quotient set ideal $R/P_1 = \{P_1, 1+P_1, 3+P_1, 5+P_1, 6+P_1, 7+P_1, 9+P_1, 11+P_1, 12+P_1, 13+P_1\}$ over $S \subseteq R$.

We just recall the definition of a Smarandache set ideal of a ring R .

Let R be any ring. S a subring of R . Suppose P is a set ideal of R relative to the subring S of R and $S \subseteq P$ then we call P to be a Smarandache set ideal of R over the subring S of R .

We will illustrate this situation by some examples.

Example 3.9: Let $R = Z_{40}$ be a ring. $S = \{0, 10, 20, 30\}$ be a subring of R .

$P = \{0, 4, 6, 8, 10, 20, 30, 40, 12, 16, 24, 28, 32, 36\}$ is a Smarandache set ideal (S-set ideal) of R over the subring S of R ; that is P is a set ideal of R .

Example 3.10: Let $R = Z_{25}$ be a ring. $S = \{0, 5, 10, 15, 20\}$ be a subring of R . $P = \{0, 5, 10, 20, 15, 4, 3, 68\} \subseteq R$ is a set ideal of the ring R over the subring S of R .

It is easily verified by any interested reader. That a S-set ideal of a ring R over a subring S of R is a set ideal of a ring R over S but a set ideal P of a ring R over a subring S in R in general is not a S-set ideal of R .

We prove this claim by an example.

Example 3.11: Let $R = Z_{36}$ be a ring. $S = \{0, 18\}$ be a subring of R . $P = \{0, 2, 4, 6, 8, 10, 12, 14, 16, 20, 22, 24\} \subseteq R$ is only a set ideal of R over the subring S , but P is not a S-set ideal of R over S as $18 \notin P$ that is $S \not\subseteq P$.

Example 3.12: Let $R = Z_{24}$ be a ring. $S = \{0, 8, 16\}$ be a subring of R . Take $P = \{0, 3, 6, 9, 12, 15, 18, 21\} \subseteq R$, P is a set ideal of R over the subring S of R . Clearly P is not a S-set ideal of R as $S \not\subseteq P$.

We can have several such examples.

We just recall the definition of a quasi set ideal of a ring R .

Let R be a ring. P a set ideal of R over a subring S of P . If P contains a subring S_1 of R ($S_1 \neq R$, $S \neq S_1$) then we call P to be Smarandache a quasi set ideal of R relative to the subring S of R .

Example 3.13: Let $R = (\mathbb{Z}_{42}, +, \times)$ be a ring. $S_1 = \{0, 21\}$ is a subring of R . $P = \{0, 6, 12, 18, 24, 30, 36, 2, 4\}$ is a set ideal of R over the subring S_1 of R . We see $S_2 = \{0, 6, 12, 18, 24, 30, 36\} \subseteq P$ is a subring of R so P is a S -quasi set ideal of R over the subring S_1 of R .

Example 3.14: Let $R = \mathbb{Z}_{20}$ be a ring. $S = \{0, 10\}$ is a subring of R . $P = \{0, 4, 8, 12, 16, 6, 18\} \subseteq R$ is a S -quasi set ideal but is not a S -set ideal of R over S as $S \not\subseteq P$.

In view of this we have the following theorem.

THEOREM 3.1: *Let R be a ring, S a subring of R . Any S -quasi set ideal P_1 of R over any subring S of R in general is not a S -set ideal and any S -set ideal P_2 of R over any subring S_1 of R in general is not a S -quasi set ideal.*

The proof is supplied by giving counter examples and this task is left as an exercise to the reader.

Thus we see the two notions of S -set ideals and S -quasi set ideals happens to be disjoint or in general disassociated.

This leads us to define the new notion of Smarandache strongly quasi set ideal of a ring R [7, 17].

Let R be any ring. S and S_1 be any two subrings of R . $S \not\subseteq S_1$ and $S_1 \not\subseteq S$. If P is a subset of R such that P contains both S_1 and S and P is a set ideal relative to both S_1 and S then we define P to be a Smarandache strongly quasi set ideal of R .

Thus this concept will be illustrated in the following examples.

Example 3.15: Let $R = \mathbb{Z}_{30}$ be the ring. $S_1 = \{0, 6, 12, 18, 24\}$ and $S_2 = \{0, 10, 20\}$ be two subrings of R .

$P = \{0, 10, 20, 6, 12, 18, 24, 15, 5\}$ is a set ideal of R over both S_1 and S_2 .

Infact P is a S -set ideal of R over S_1 and S_2 . Thus P is a S -strong quasi set ideal of R .

Example 3.16: Let $R = \mathbb{Z}_{42}$ be a ring of modulo integers $S_1 = \{0, 14, 28\}$ and $S = \{0, 6, 12, 18, 24, 30, 36\}$ be two proper subrings of R .

Take $P = \{0, 14, 28, 6, 12, 18, 24, 30, 36, 2, 4\} \subseteq R$. P is a set ideal over both S_1 and S and infact P is a S -set ideal over both S_1 and S hence P is a S -strong quasi set ideal of R .

We have the following results the proof of which is left as an exercise to the reader.

Let R be a ring. S_1 and S be two distinct subrings of R such that $S_1 \not\subseteq S$ and $S \not\subseteq S_1$.

Let $P \subseteq R$ be a S -strong quasi set ideal of R .

Then

- (i) P is a S -set ideal over both S_1 and S .
- (ii) P is a S -quasi set ideal of R with respect to both S_1 and S .
- (iii) P is a set ideal of R over S_1 and S .

The proof of this is very direct and hence left as an exercise to the reader.

However we suggest the following problem.

Problem 3.2: Let $R = \mathbb{Z}_n$ be the ring.

- (i) How many distinct S -strong quasi set ideals of R exist?

- (ii) If n is a prime what happens for S -strong quasi set ideals?

Problem 3.3: Let $R = \mathbb{Z}$ be the ring of integers.

Prove every S -strong quasi set ideal is of infinite order.

Does \mathbb{Z} contain infinite number of S -strong quasi set ideals?

Now all these problems can be studied for $C(\mathbb{Z}_n)$, the ring of complex modulo finite integers.

Example 3.17: Let

$R = C(\mathbb{Z}_{20}) = \{a + bi_F \mid a, b \in \mathbb{Z}_{20} \text{ and } i_F^2 = 19\}$ be a ring.

$S_1 = \{0, 5, 10, 15\}$ and $S_2 = \{2, 4, 6, 8, 10, \dots, 18\}$ be two subrings of R . We can have several S -strong quasi set ideals of R over both S_1 and S_2 .

We can replace \mathbb{Z}_n by $\mathbb{Z}_n(g)$ the modulo dual numbers and study the same problem.

Example 3.18: Let $R = C(\mathbb{Z}_6)$ be the ring of complex modulo integers. $S = \{0, 3\}$ be the subring R .

$P = \{0, 2, 4, 2i_F, 4i_F, 2+4i_F, 2+2i_F, 4+4i_F\} \subseteq R$ is a set ideal of complex modulo integers.

We just give a problem.

Problem 3.4: Let

$R = C(\mathbb{Z}_n) = \{a + bi_F \mid a, b \in C(\mathbb{Z}_n), i_F^2 = n-1\}$ be the complex ring of modulo integers.

- (i) Find the number of subrings of R .
- (ii) Find the collection of set ideals of R over every subring S of R .

Example 3.19: Let $R = C(\mathbb{Z}_{11})$ be the ring of complex modulo integers.

Take $S = \{1, 2, \dots, 0, 10\}$ be the subring of R .

$P = \{0, i_F, 2i_F, \dots, 10i_F\}$ is a set ideal of R over S , the subring of R .

Now we just indicate by examples the set ideals of dual number ring, special dual like number ring, special quasi dual number ring and finally the mixed dual number rings and rings of higher dimensional dual numbers.

Example 3.20: Let

$R = \mathbb{Z}_{12}(g) = \{a + bg \mid a, b \in \mathbb{Z}_{12}, g = 5 \in \mathbb{Z}_{25} \text{ so that } g^2 = 0\}$ be the ring of modulo dual numbers. Let $S = \{0, 4, 8\}$ be a subring of R .

$P = \{0, 3g, 3, 6g, 6, 3+6g, 6+6g, 3+3g, 9g, 9, 9+3g, 9+6g\} \subseteq R$ is a set ideal of R over the subring S of R .

Consider $S_1 = \{0, 6, 6g, 6+6g\}$, the subring of R . $P_1 = \{0, 2, 2g, 4g, 4, 8, 8g, 10, 10g, 2+2g, 4 + 4g, 8+4g, 10+2g, 10+8g, 10+4g\} \subseteq R$ is a set ideal of R over the subring S_1 of R .

Clearly both the set ideals are not S -set ideals.

Example 3.21: Let

$R = \mathbb{Z}_{10}(g) = \{a + bg \mid a, b \in \mathbb{Z}_{10} \text{ and } g = 6 \in \mathbb{Z}_{12}\}$ be the ring of modulo integers dual ring.

Consider $S = \{0, 2, 4, 6, 8\}$ be the subring of $\mathbb{Z}_{10}(g)$.

$P = \{0, 5, 5g, 5+5g\}$ is a set ideal of R over S .

Now let $S_1 = \{0, 5, 5g, 5+5g\} \subseteq \mathbb{Z}_{10}(g)$ be a subring of R . Clearly $P_1 = \{0, 2, 4, 6, 8\}$ is a set ideal of R over the subring S_1 of R .

This sort of set ideals are interesting feature.

Example 3.22: Let

$R = \{Z_9(g) = a + bg \mid a, b \in Z_9, g = 4 \in Z_{12}; g^2 = g \pmod{12}\}$
be a ring of special dual like numbers.

Take $S = \{0, 3, 6, 3g, 6g, 3+3g, 3+6g, 6+6g, 6+3g\}$ be the subring of R .

Take $P = \{0, g, 3g, 6g\} \subseteq R$ is a set ideal of R . Clearly P is not a S -set ideal over $S \subseteq R$.

Example 3.23: Let

$R = \{Z_{15}(g) = \{a + bg \mid g = 3 \in Z_6, a, b \in Z_{15}\}$
be the ring of special dual like numbers.

Take $S = \{0, 3, 6, 12, 9\}$ to be a subring of R .

Consider $P = \{0, 5g, 10g, 5, 10, 5g+10, 10g+5\} \subseteq R$, P is a special dual like number set ideal of R over the subring S of R .

Example 3.24: Let $R = \{Z_{12}(g) \mid g_2 = g \text{ where } g = 3 \in Z_6\}$ be the special dual like number ring of modulo integers.

Consider $S = \{0, 3, 6, 9\}$ a subring of R .

Take $P = \{0, 4, 4g\} \subseteq R$, P is a set ideal of R over S and clearly is not a S -set ideal or S -quasi set ideal or a S -strong quasi set ideal of R over S .

Suppose $P_1 = \{4, 4g, 0, 8, 8g, 8+4g, 2, 6, 9, 0\} \subseteq R$, P_1 is a S -set ideal over the subring S of R .

However P_1 is not a S -quasi set ideal of R over S .

Consider

$P_2 = \{0, 2, 4, 6, 8, 4g, 10, 3, 6, 9, 10g, 2g, 8g, 6g\} \subseteq R$.
 P_2 is a S -quasi set ideal of R over the subring S .

For $S_1 = \{0, 2, 4, 6, 8, 10\} \subseteq P_2$ is also a subring of R . Further P_2 is also a set ideal of R over the subring S_1 of R . Thus P_2 is a S -quasi set ideal.

Since both S_1 and S are contained in P_2 we see P_2 is a S strong quasi set ideal of R .

Example 3.25: Let $R = \{Z_{20}(g) \mid g = 4 \in Z_{12}\}$ be the special dual like ring. Consider $S_1 = \{0, 10g\}$ and $S_2 = \{0, 4, 8, 12, 16\}$ subrings of R .

Take

$P_1 = \{0, 10g, 10, 4, 8, 12, 16, 4g, 8g, 12g, 16g, 12+12g\} \subseteq R$, P_1 is a S -strong quasi set ideal of R .

Now we proceed onto describe some special quasi dual number modulo integer ring set ideals.

Example 3.26: Let $R = \{Z_6(g_1) \mid g_1 = 8 \in Z_{12}, g_1^2 = -g_1\}$ be the ring of special quasi dual modulo integers.

Let $S_1 = \{0, 3g_1\}$ and $S_2 = \{0, 2, 4\}$ be subrings of the ring R .

Take $P = \{0, 2g_1, 4g_1\} \subseteq R$, P is just a set ideal of special quasi modulo integers over the subring S_1 of R .

$P_1 = \{0, 3g_1 + 3\}$ is a set ideal over both the subrings S_1 and S_2 . But P_1 is not a S -strong quasi set ideal of R .

Consider

$P_2 = \{0, 2, 4, 3g_1, 2g_1, 4g_1, 2+2g_1, 4+4g_1, 2+4g_1, 2g_1+4\} \subseteq R$
 P_2 is a S -strong set ideal of R .

For we see P_2 is a set ideal over S_1 and $S_2 \subseteq P_2$ so that P_2 is a S -quasi set ideal of R over S_1 . Further $S_1 \subseteq P_2$ so P_2 is a S -set ideal of R .

Example 3.27: Let $R = \{Z_{12}(g_1) = a + bg_1 \mid a, b \in Z_{12}, g_1 = 2 \in Z_6 \text{ so that } g_1^2 = -g_1 \pmod{6}\}$ be the special quasi dual number ring.

Let $S_1 = \{0, 4, 8\}$ and $S_2 = \{0, 6g_1\}$ be subrings of R . Consider $P_1 = \{0, 4, 8, 6, 6g_1, 3, 3g_1, 9, 9g_1\} \subseteq R$. P_1 is a S -strong quasi set ideal of R . For both S_1 and S_2 are subsets of P_1 .

Now we proceed onto give examples of mixed dual number set ideals.

Example 3.28: Let $R = \{Z_{10}(g_1, g_2) = a_1 + a_2g + a_3g_1 \mid a_i \in Z_{10}, 1 \leq i \leq 10, g = 6, g_1 = 4, g_1^2 = 0 \pmod{12}, g_1^2 = 4 \pmod{12}, gg_1 = 0 \pmod{12}, g_1g_1 \in Z_{12}\}$ be the mixed dual number ring.

Take $S_1 = \{0, 2, 4, 6, 8\}$ and $S_2 = \{0, 5g_1\}$ as subrings of R . We see $P_1 = \{0, 4, 8\} \subseteq R$ is a set ideal of R over S_2 .

$P_2 = \{0, 5g_1, 5g_2, 5, 5+5g_2\} \subseteq R$ is a set ideal of R over S_1 . Clearly P_2 is not S -set ideal or a S -quasi set ideal of R .

Example 3.29: Let $R = Z_{12}(g, g_1, g_2) = \{a_1 + a_2g + a_3g_1 + a_4g_2 \mid a_i \in Z_{12}; g = 10, g_1 = 5, g_2 = 15, g, g_1, g_2 \in Z_{20}; g^2 = 0 \pmod{20}, g_1^2 = 5 \pmod{20}, g_2^2 = -g_2 = 5 \pmod{20}; 1 \leq i \leq 4\}$ be the ring of mixed dual numbers.

Consider

$S_1 = \{0, 6, 6g_1, 6g, 6+6g, 6+6g_1, 6+6g_1 + 6g, 6+6g_1\}$
to be a subring of R .

$P = \{0, 2, 8, 10, 2g, 8g, 10g, 2g_1, 8g_1, 10g_1\} \subseteq R$ is a set ideal of R over the subring S_1 . Clearly P is not a S -set ideal or S -quasi set ideal of R .

Now we give higher dimensional dual number rings.

Example 3.30: Let $R = \{a_1 + a_2g_1 + a_3g_2 + a_4g_3 \mid a_i \in \mathbb{Z}_{15}; 1 \leq i \leq 4, g_1 = 4, g_2 = 9 \text{ and } g_3 = 6 \text{ are such that } g_1^2 \equiv g_1 \pmod{12}, g_2^2 \equiv -g_2 \pmod{12} \text{ and } g_3^2 \equiv 0 \pmod{12}; g_1, g_2, g_3 \in \mathbb{Z}_{12}\}$ be the mixed special quasi dual numbers ring. Take $S_1 = \{0, 5, 10\}$ be a subring of R . $S_2 = \{0, 5g_1, 10g_2, 5+5g_1, 5g_2, 10+5g_1, 10+10g_2, 10+19g_1 + 10g_2 \dots, 10, 10g, 5 + 5g_1 + 5g_2, 5\}$ be a subring of R .

Take $P_1 = \{0, 3\}$, $P_2 = \{0, 6\}$, $P_3 = \{0, 6\}$ and $P_4 = \{0, 12\}$ are all set ideals over both the subrings S_1 and S_2 . However none of them is a S -set ideal or a S -quasi set ideal of R .

$M = \{0, 3, 6, 9, 12, 3g_1, 3g_2, 3g_3\} \subseteq R$ is a set ideal of R over both S_1 and S_2 .

M is a S -quasi set ideal of R over both the subring S_1 and S_2 of R .

However M is not a S -set ideal of R or M is not a S -strong set ideal of R .

Now we proceed onto give some more examples of set-ideals of complex modulo integer dual numbers, special dual like numbers and special quasi dual numbers.

Example 3.31: Let $R = \{C(\mathbb{Z}_{10})(g) = a + bg \mid a, b \in C(\mathbb{Z}_{10}), f = g \in \mathbb{Z}_{12}, g^2 = 0 \pmod{12}, i_F^2 = 9\}$ be the ring of complex modulo integers of dual numbers.

Let $S_1 = \{0, 5, 5+5g, 5g\}$ and $S_2 = \{0, 2, 4, 6, 8\}$ be subring of R . Consider $P_1 = \{0, 4\} \subseteq R$, P_1 is a set ideal of R over S_1 , of course is not a set ideal over S_2 . Take $P_2 = \{0, 5\} \subseteq P$, P_2 is a set ideal of R over S_2 and is not a set ideal over S_1 .

Consider $P_3 = \{0, 2, 4, 6, 8, 2g, 4g, 6g, 8g, 2+2g, 2+4g, 2+6g, 2+8g, 4+2g, 4+6g+4+4g, 4+8g, \dots, 8+8g\} \subseteq R$, P_3 is a S -set ideal over S_2 as well as S_1 .

However P_3 is not a S-quasi set ideal of R or a S-strong quasi set ideal of R .

Example 3.32: Let

$R = C(\mathbb{Z}_6)$ (g_1) = $\{a + bg_1 \mid g_1 = 4 \in \mathbb{Z}_{12}, a, b \in C(\mathbb{Z}_6); i_F^2 = 5\}$ be the complex modulo integer ring of special dual like numbers.

Take $S_1 = \{0, 2, 4\}$, $S_2 = \{0, 3\}$, $S_3 = \{0, 3, 3g, 3+3g_1\}$ and $S_4 = \{0, 2g_1, 4g_1\}$ to be subrings of R .

We see $P_1 = \{0, 3, 3i_F, 3+3i_F, 3g_1, 3g_1i_F, 3+3g_1, 3+3g_1 + 3i_F, 3+3g_1 + 3i_F + 3g_1i_F\}$ is a set ideal of R over S_1, S_2, S_3 and S_4 .

However it is interesting to note that P_1 is a S-set ideal with respect to S_2 and S_3 . But P_1 is not a S-set ideal with respect to S_1 and S_4 .

Further relative to S_1 and S_4 , P_1 is a S-quasi set ideal of R over S_1 and S_4 as P_1 contains subrings S_2 and S_3 .

Finally P_1 is not a S-strong quasi set ideal of R .

Example 3.33: Let $R = \{C(\mathbb{Z}_{12}) (g_1, g_2, g_3) = a_1 + a_2g_1 + a_3g_2 + a_4g_3 \mid a_i \in C(\mathbb{Z}_{12}); 1 \leq i \leq 4 \text{ and } g_1 = 6, g_2 = 9 \text{ and } g_3 = 12 \in \mathbb{Z}_{36}\}$ be a ring $S_1 = \{0, 6, 6g_1, 6+6g_1\}$, $S_2 = \{0, 4, 8\}$ and $S_3 = \{0, 6, 6g_3, 6+6g_3\}$ be subrings of R .

Take $P_1 = \{a_1 + a_2g_1 + a_3g_2 + a_4g_3; a_i \in \{2, 4, 6, 8, 10, 0, 2i_F, 4i_F, 6i_F, 8i_F, 10i_F\}\} \subseteq R$, P_1 is a set ideal of R over S_1, S_2 and S_3 .

Clearly P_1 is a S-set ideal over the subrings S_2 and S_3 . Further P_1 is not a S-set quasi ideal or S-strong quasi set ideal of R .

Example 3.34: Let $R = \{C(\mathbb{Z}_{12}) (g_1, g_2, g_3) \mid a_1 + a_2g_1 + a_3g_2 + a_4g_3 + a_5g_4 \text{ with } a_j \in C(\mathbb{Z}_{12}); 1 \leq j \leq 5, g_1 = 6, g_2 = 9, g_3 = 8 \text{ and } g_4 = 12 \text{ in } \mathbb{Z}_{18} \text{ are such that } g_1^2 = 0 \pmod{18}, g_2^2 = 9 \pmod{18},$

$g_3^2 = -g_3 \pmod{18}$, $g_1g_2 = 0 \pmod{18}$, $g_1g_4 = 0 \pmod{18}$, $g_4^2 = 0 \pmod{18}$, $g_1g_3 = 12 = g_4 \pmod{18}$, $g_2g_3 = 0 \pmod{18}$, $g_2g_4 = 0 \pmod{18}$, $g_3g_4 = 0 \pmod{18}$ } be the ring.

Consider $S_1 = \{C(Z_{12})\}$, $S_2 = Z_{12}$ and $S_3 = \{0, 6, 6g_1, 6+g_1\}$ be subrings of R . $P_1 = \{0, 2, 4, 8, 6, 10\}$ is a set ideal of R over both S_2 and S_3 . P_1 is a S -quasi set ideal of R over S_1 and S_3 as $\{0, 6\} \subseteq P_1$ is a subring of R .

Now having seen dual number rings and set ideals in them now we proceed onto construct the notion of set ideal topological spaces of a ring R relative to a subring of R .

It is pertinent to mention here that using the ideals of a ring R we can construct a ideal topological space.

Let us first illustrate it by an example.

Example 3.35: Let $R = Z_6$ be the ring of modulo integers. The ideals of R are $T = \{\{0\}, R, J = \{0, 2, 4\}, I = \{0, 3\}\}$.

T is a ideal topological space of R and the lattice associated with T is as follows:

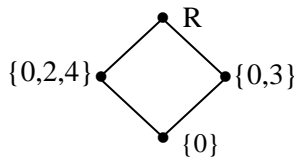

By ‘ \cup ’ we mean the ideal generated by the ideals J and I and $J \cap I$ is just the usual intersection.

We call T the ideal topological space of a ring.

Example 3.36: Let Z_{12} be the ring of integers. The ideals of Z_{12} denoted by $T = \{\{0\}, Z_{12}, I_1 = \{0, 6\}, I_2 = \{0, 2, 4, 6, 8, 10\}, I_3 = \{0, 3, 6, 9\}, I_4 = \{0, 4, 8\}\}$. T is a topological space and $I_i \cup I_j = \{\text{ideal generated by } I_i \text{ and } I_j\}$.

$I_i \cap I_j = I_k$ is an idea of T , T under the usual topology is defined as the ring-ideal topological space or ideal topological space of a ring for we see $\{0\} \in T$, $I \cap J \in T$ and $\langle I \cup J \rangle \in T$, $R \in T$ so T is a topological space called the ring - ideal topological space or ideal - topological space of a ring R .

We will illustrate this by some more examples.

Example 3.37: Let $R = Z_8 = \{0, 1, 2, \dots, 7\}$ be the ring of integers. The ideals of R are $T = \{\{0\}, R, I_1 = \{0, 4\}, I_2 = \{0, 2, 6, 4\}\}$.

T is a ideal topological space of a ring R and the lattice associated with the space T is as follows:

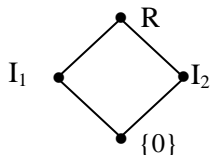

Example 3.38: Let $R = Z_{24}$ be the ring of integers modulo 24. The ideals of R are $T = \{\{0\}, R, I_1 = \{0, 12\}, I_2 = \{0, 6, 12, 18\}, I_3 = \{0, 8, 16\}, I_4 = \{0, 4, 8, 12, 16, 20\}, I_5 = \{0, 3, 6, 9, 12, 15, 18, 21\}$ and $I_6 = \{0, 2, 4, \dots, 22\}\}$.

T is a ideal topological space of the ring R . T has eight elements. The lattice associated with T is as follows:

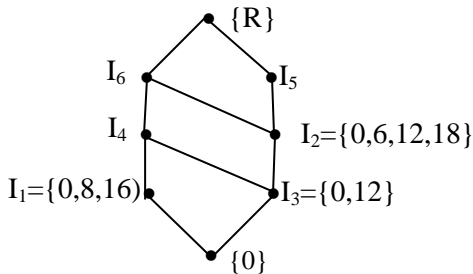

Example 3.39: Let $R = \mathbb{Z}_{20}$ be the ring of modulo integers. The ideals of R are $T = \{\{0\}, R, \{0, 10\} = I_1, I_2 = \{0, 5, 10, 15\}, I_3 = \{0, 4, 8, 12, 16\}, I_4 = \{0, 2, 4, \dots, 18\}\}$.

The lattice associated with the ideal topological space of R is as follows:

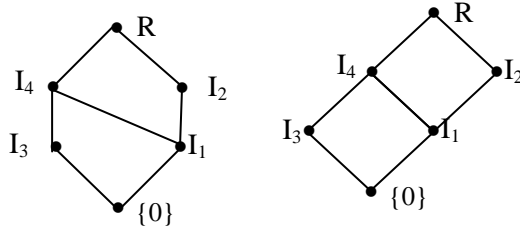

Example 3.40: Let $R = \mathbb{Z}_{10}$ be the ring of integers. The ideals of R are $T = \{\{0\}, R, I_1 = \{0, 5\}, I_2 = \{0, 2, 4, 6, 8\}\}$. The lattice associated with T is as follows:

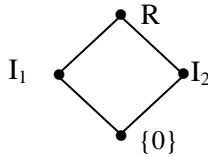

Example 3.41: Let

$R = \{a + bg \mid a, b \in \mathbb{Z}_4, g = 6 \in \mathbb{Z}_{12}, g^2 = 0 \pmod{12}\}$ be the ring.

The ideals of R are $T = \{\{0\}, R, I_1 = \{0, 2\}, I_2 = \{0, 2g\}, I_3 = \{0, 2+2g\}, I_4 = \{0, 2, 2g, 2+2g\}, I_5 = \{0, g, 2g, 3g\}\}$.

This T is an ideal topological space of the ring whose associated lattice is as follows:

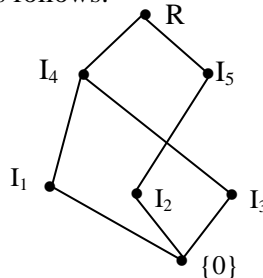

Interested reader is expected to solve the following problem.

Problem 3.5: Let $R = \{Z_n (g) = a + bg \mid a, b \in Z_n, g^2 = 0\}$ be a ring.

- (i) Find the number of ideals of R .
- (ii) Find the ideal topological space of rings.
- (iii) Find the lattice associated with T .

Example 3.42: Let $R = \{a + bg \mid a, b \in Z_3, g^2 = 0\}$ be the ring of dual numbers. To find all the ideals of R . Let $T = \{\{0\}, R, I_1 = \{0, g, 2g\}\}$ be the set of ideals of R .

The ideal topological space of the ring R . The lattice associated with it is as follows:

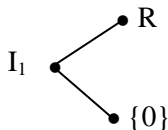

Example 3.43: Let $R = \{a + bg \mid a, b \in Z_5, g^2 = 0\}$ be the ring of dual numbers.

The ideals of R are $\{\{0\}, R, I_1 = \{0, g, 2g, 3g, 4g\}\} = T$; T is a ideal topological space of the ring R .

The lattice associated with T is as follows.

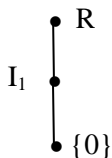

Example 3.44: Let $R = \{a + bg \mid a, b \in \mathbb{Z}_2, g^2 = g\}$ be the ring of special dual like numbers.

The ideals of R are $T = \{\{0\}, R, \{0, 1+g\} = I_1, I_2 = \{0, g\}\}$. T is the ideal topological space of the ring. The lattice associated by T is as follows:

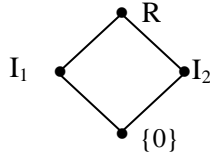

Example 3.45: Let $R = \{a + bg \mid a, b \in \mathbb{Z}_4, g^2 = g\}$ be the ring of special dual like numbers.

The ideals of R are $\{\{0\}, R, I_1 = \{0, 2, 2+2g, 2g\}, I_2 = \{0, g, 2g, 3g\}\} = T$.

T is an ideal topological space of the ring R .

The lattice associated with T is as follows:

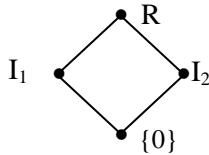

Now we proceed onto suggest a problem.

Problem 3.6: Let $R = \{a + bg \mid a, b \in \mathbb{Z}_n, g \text{ is such that } g^2 = g\}$ be a ring.

- (i) Find all ideals of G .
- (ii) Find the ideal topological space T of the ring R .
- (iii) Find the associated lattice of T .
- (iv) Is the lattice associated with T modular? Justify.

Example 3.46: Let

$R = \{a + bg + cg_1 \mid a, b, c \in \mathbb{Z}_2, g^2 = 0, g_1^2 = g_1, g_1g = 0\}$
 be the ring. The ideals of R are $T = \{\{0\}, R, I_1 = \{0, g\}, I_2 = \{0, g_1\}, I_3 = \{0, g + g_1, g_1, g\}, R\}$.

The lattice associated with T is as follows:

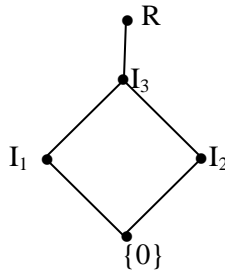

Example 3.47: Let $R = \{a_1 + a_2g_1 + a_3g_2 + a_3g_3 \mid a_i \in \{0, 1\} = \mathbb{Z}_2, g_1^2 = 0 \pmod{12}, g_2^2 = 4 \pmod{12}, g_1 = 6, g_2 = 4, g_1g_2 = 0 \pmod{12}, g_3 = 8, g_3^2 = -4 \pmod{12}, g_2g_3 = 8 \pmod{12}, g_3g_1 \equiv 0 \pmod{12}\}$ be the ring of special mixed dual numbers.

The reader is left with the task of finding the ring ideal topological space of R . However for a given ring R we can have one and only one ideal topological space of the ring R .

Now if we define set ideal of a ring R over a subring we can have as many set ideal collection as the number of subrings.

Thus we can define the topological space for the collection of all set ideals of a ring R over the subring S of R . So we can have as many number of set ideal topological spaces for a given ring over these subrings.

Thus this is the first main advantage of defining set ideals of a ring R over a subring S of R .

We will illustrate this after we define set ideal topological space of the ring over the subring.

Let R be a ring S be a subring of R .

$T = \{\text{Collection of all set ideals of } R \text{ over the subring } S \text{ of } R\}$;
 T is a topological space under \cup and \cap of operations on T . T is called the set ideal topological space of the ring over the subring S of R .

We see we have as many number of set ideal topological spaces over the subring as the number of subrings of the ring R .

We will first illustrate this situation by an example or two.

Example 3.48: Let $R = \mathbb{Z}_6$ be the ring. The subrings of R are $S_1 = \{0, 3\}$ and $S_2 = \{0, 2, 4\}$.

Let $T_1 = \{\text{Collection of all ideals of } R \text{ over } S_1\} = \{\{0\}, \mathbb{Z}_6, I_1 = \{0, 2\}, I_2 = \{0, 4\}, I_3 = \{0, 2, 4\}, I_4 = \{0, 1, 3\}, \{0, 3, 5\} = I_5, I_6 = \{0, 1, 3, 2\}, I_7 = \{0, 1, 3, 4\}, I_8 = \{0, 1, 2, 4, 3\}, I_9 = \{0, 1, 3, 5\}, I_{10} = \{0, 2, 3, 5\}, I_{11} = \{0, 4, 3, 5\}, I_{12} = \{0, 4, 3, 2, 5\}, I_{13} = \{0, 3\}, I_{14} = \{0, 3, 2, 1, 5\}, I_{15} = \{0, 3, 4, 1, 5\}, I_{17} = \{0, 3, 2\}, I_{18} = \{0, 3, 4\}\}$ we see T_1 is a set ideal topological space of R over S_1 and $o(T_1) = 19$.

The lattice associated with T_1 is as follows:

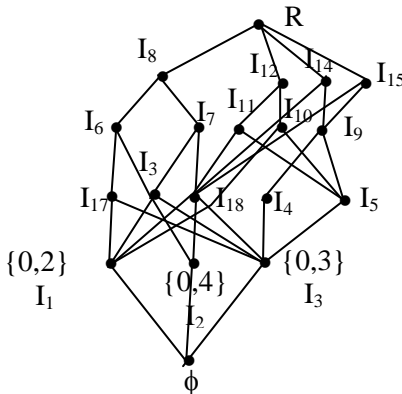

We see by defining set ideals of a ring over a subring we get many elements in the set ideal topological space of the ring.

Now let $T_2 = \{\text{Collection of all set ideals of } R \text{ (relative) over the subring } S_2 = \{0, 2, 4\} = \{\{0\}, R, I_1 = \{0, 3\}, I_2 = \{0, 3, 2\}, I_3 = \{0, 3, 4\}, I_4 = \{0, 2, 4, 1\}, I_5 = \{0, 4, 2, 5\}, I_6 = \{0, 4, 2, 5, 3\}, I_7 = \{0, 4, 2, 1, 5\}, I_8 = \{0, 1, 4, 2, 3\}, I_{10} = \{0, 4, 2\}, I_{11} = \{0, 4, 2, 3\}\}$.

We see T_2 the set ideal topological space of the ring R over the subring S_2 R and T_2 has 13 set ideals including 0 and R .

Now we give the lattice associated with the set ideal topological space T_2 .

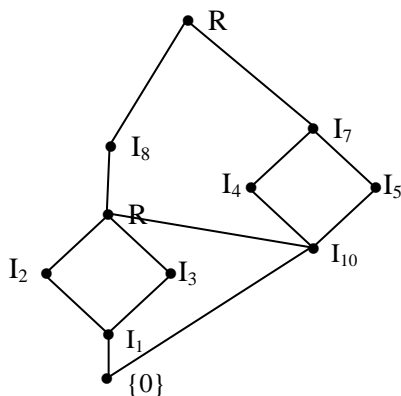

But for the ideal topological space of the ring Z_6 , we have the following associated lattice.

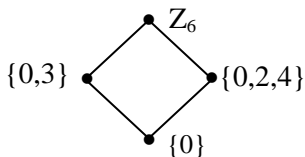

Example 3.49: Let $R = \mathbb{Z}_4$ be the ring. The ideal topological space of the ring R be $T = \{\{0\}, R, I_1 = \{0, 2\}\}$.

The lattice associated with T is as follows:

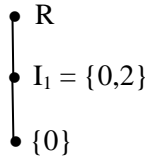

Let the set ideal of R over the subring $S_1 = \{0, 2\}$ is as follows: $T_1 = \{\text{Collection of set ideals of } \mathbb{Z}_4 \text{ over } S_1\} = \{\{0\}, R, I_1 = \{0, 2\}, \{0, 2, 1\} = I_2, \{0, 2, 3\} = I_3\}$.

T_1 is a set ideal topological space of R over the subring S_1 of R . The lattice associative with T_2 is as follows:

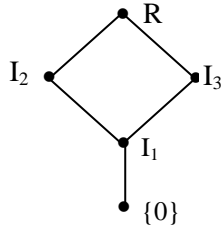

Example 3.50: Let $R = \mathbb{Z}_{10}$ be the ring. Let $S_1 = \{0, 5\}$ and $S_2 = \{0, 2, 4, 6, 8\}$ be two subrings of R . The set ideals S_1 of R be T_1 .

$T_1 = \{\text{Collection of all set ideals of } R \text{ over } S_1\} = \{\{0\}, R, \{0, 5\} = I_1, \{0, 2\} = I_2, \{0, 4\} = I_3, \{0, 6\} = I_4, \{0, 8\}, I_6 = \{0, 5, 3\}, I_7 = \{0, 5, 7\}, I_8 = \{0, 6, 9\}, \{0, 1, 5\} = I_9, I_{10} = \{0, 2, 4\}, I_{11} = \{0, 2, 6\}, I_{12} = \{0, 2, 8\}, I_{13} = \{0, 4, 6\}, I_{14} = \{0, 4, 8\}, I_{15} = \{0, 6, 8\}, I_{16} = \{0, 1, 5, 3\}, I_{17} = \{0, 5, 7, 1\}, I_{18} = \{0, 5, 1, 9\}, I_{20} = \{0, 2, 4, 6\}, I_{21} = \{0, 2, 4, 8\}, I_{22} = \{0, 4, 6, 8\}, I_{23} = \{0, 2, 4, 6, 8\}, I_{24} = \{0, 2, 4, 6, 8, 5\}, I_{25} = \{0, 2, 4, 6, 8, 3, 5\}, I_{27} = \{0, 2, 4, 6, 8, 9, 5\}, I_{28} = \{0, 2, 4, 6, 8, 5, 1\}, I_{29} = \{0, 2, 4, 6, 8, 5, 3, 7\}, I_{30} = \{0, 2, 4, 6, 8, 5, 3, 9\}, I_{31} = \{0,$

$2, 4, 6, 8, 5, 7, 9\}$, $I_{32} = \{0, 2, 4, 6, 8, 5, 1, 3\}$, $I_{33} = \{0, 2, 4, 6, 8, 5, 1, 7\}$, $I_{34} = \{0, 2, 4, 6, 8, 5, 1, 9\}$, $I_{35} = \{0, 2, 4, 6, 8, 5, 3, 7, 1\}$, $I_{36} = \{0, 2, 4, 6, 8, 5, 3, 9, 1\}$, $I_{37} = \{0, 2, 4, 6, 8, 5, 9, 7, 1\}$, $I_{38} = \{0, 2, 4, 6, 8, 5, 3, 9, 7\}$, $I_{39} = \{0, 4, 6, 8, 5, 3, 9, 7, 1\}$, $I_{40} = \{0, 2, 4, 6, 5, 3, 9, 7, 1\}$, $I_{41} = \{0, 8, 6, 2, 5, 3, 9, 7, 1\}$, $I_{42} = \{0, 2, 4, 8, 5, 3, 9, 7, 1\}$ is the set ideal topological space of the ring over the subring S_1 of R .

$T_2 = \{\text{Collection of all set ideals of the ring } R \text{ over } S_2\} = \{\{0\}, R, I_1 = \{0, 5\}, I_2 = \{0, 5, 2, 4, 6, 8\}, \{0, 5, 1, 2, 4, 6, 8\} = I_3, I_4 = \{0, 3, 6, 2, 4, 8, I_5 = \{0, 3, 1, 6, 2, 4, 8\}, I_6 = \{0, 7, 4, 8, 2, 6\}, I_7 = \{1, 7, 0, 4, 2, 6, 8\}, I_8 = \{0, 3, 1, 2, 4, 6, 8\}, I_9 = \{0, 9, 2, 4, 8, 6\}, I_{10} = \{0, 9, 1, 2, 4, 6, 8\}, I_{11} = \{0, 3, 5, 2, 4, 6, 8\}, I_{12} = \{0, 3, 7, 2, 4, 6, 8\}, I_{13} = \{0, 3, 9, 2, 4, 6, 8\}, I_{14} = \{0, 5, 7, 2, 4, 8, 6\}, I_{15} = \{0, 5, 9, 2, 4, 6, 8\}, I_{16} = \{0, 7, 9, 2, 4, 6, 8\}, I_{17} = \{0, 7, 9, 3, 2, 4, 6, 8\}, I_{19} = \{0, 5, 9, 2, 4, 6, 8, 1\}, I_{20} = \{0, 5, 7, 2, 4, 6, 8, 1\}$ and so on.

However T_2 is only a finite set ideal topological space of the ring R over the subring S_2 of R .

We see the advantage of defining set ideal topological space of a ring over a subring of the ring.

Problem 3.7: Let $R = Z_n$ be the ring of integers.

- (i) Find all the subrings of Z_n .
- (ii) Find all the set ideal topological spaces of the ring R over the subrings of R .
- (iii) What is the minimum number of elements in the set ideal topological spaces of R associated with the subring?
- (iv) Find the maximum number of elements in the set ideal topological spaces of the ring R over the subring.

Now we can have set ideal topological spaces of Z .

It is pertinent to keep on record that for Z we have one and only ideal topological space of the ring for Z .

However we have infinite number of set ideal topological spaces for the ring Z over the subrings of Z . For Z has infinitely many subrings. This is one of the main advantages of using set ideal topological concept of a ring over a subring.

Certainly this new concept will find applications in due course of time.

Now we proceed onto find set ideal topological spaces of a dual number ring $Z_n(g)$.

Example 3.51: Let $R = Z_8(g) = \{a + bg \mid a, b \in Z_8, g^2 = 0\}$ be the dual number ring. The subrings of R are $S_1 = \{0, 4g\}$, $S_2 = \{0, 4\}$, $S_3 = \{0, 2, 4, 6\}$, $S_4 = \{0, 2g, 4g, 6g\}$, $S_5 = \{0, 2+2g, 4+4g, 6+6g\}$ and so on.

Relative to each of these five subrings we get five set ideals topological spaces of the ring R over these subrings of R .

Infact R has more such subrings.

Let $T_1 = \{\text{Collection of all set ideal of } R \text{ over the subring } S_1 \text{ of } R\} = \{\{0\}, \{0, 2\}, \{0, 4\}, \{0, 6\}, \{0, 2g\}, \{0, 4g\}, \{0, 6g\}, \{0, 2, 4\}, \{0, 2, 6\}, \{0, 4, 6\}, \{0, 2, 2g\}, \{0, 2, 4g\}, \{0, 2, 6g\}, \{0, 4g, 4\}, \{0, 4g, 6\}, \{0, 4g, 6g\}, \{0, 4, 2g\}, \{0, 4, 6g\}, \{0, 6, 2g\}, \{0, 6, 4g\}, \{0, 6, 6g\}, \{0, 2, 4, 2g\} \text{ and so on}\}$

We get very large collection of set ideals over $S_1 = \{0, 4g\}$. Thus the method of finding set ideals of a ring over the subring of a ring leads to a very large but finite set ideal topological spaces over the subrings. These set ideal topological spaces would be known as the set ideal dual number topological spaces of the ring over the subring.

We suggest a problem for the reader.

Problem 3.8: Let $R = Z_n(g) = \{a + bg \mid a, b \in Z_n, g^2 = 0\}$ be the ring of modulo dual numbers.

- (i) Find the number of subrings of this dual number ring.
- (ii) Find the order of each of the set ideal topological spaces of R associated with each subring of R .

Next we proceed onto give examples of special dual like number rings.

Example 3.52: Let $R = Z_6(g_1) = \{a + bg_1 \mid a, b \in Z_6, g_1^2 = g_1\}$ be the special dual like number ring.

Let $S_1 = \{0, 3\}$, $S_2 = \{0, 3g\}$, $S_3 = \{0, 2, 4\}$,
 $S_4 = \{0, 2g, 4g\}$, $S_5 = \{0, 2g+2, 4, 2, 4+4g, 2g, 4g, 4g+2, 2g+4\}$,
 $S_6 = \{0, 3 + 3g\}$, $S_7 = \{0, 3, 3g, 3+3g\}$ and so on.

Interested reader can find the associated set ideal topological spaces of the ring over the subrings.

Infact we see we have several such set ideal topological spaces.

Problem 3.9: Let $Z_n(g_1) = \{a + bg_1 \mid a, b \in Z_n, g_1^2 = g_1\}$ be the special dual like number ring.

- (i) Find the number of subrings of R .
- (ii) Find the number of set ideal topological spaces over these subrings.
- (iii) Find the order of each of these set ideal topological spaces.

Next we proceed onto give an example of a special quasi dual number rings.

Example 3.53: Let $R = Z_4(g_2) = \{a + bg_2 \mid a, b \in Z_4, g_2^2 = -g_2\}$ be the special quasi dual number ring. The subrings of Z_4 are $S_1 = \{0, 2\}$, $S_2 = \{0, 2g_2\}$, $S_3 = \{0, 2, 2g_2, 2+2g_2\}$, $S_4 = \{2 + 2g_2, 0\}$, $\{0, 1+g_2, 2(1+g_2), 3(1+g_2)\} = S_5$ and so on.

Associated with each of the subrings we have set ideal topological spaces of R over these subrings.

Now based on this we propose the following problem.

Problem 3.10: Let $R = \{Z_n(g_2) = a + bg_2 \mid a, b \in Z_n, g_2^2 = -g_2\}$ be the ring of special quasi dual numbers.

- (i) Find all the subrings of R .
- (ii) Find all the set ideal topological spaces of R over the subrings.
- (iii) Find the cardinality of each of these topological spaces.

Now we just discuss about set ideal topological spaces of the ring $Z(g)$ over subrings.

Let $Z(g) = \{a + bg \mid a, b \in Z, g^2 = 0\}$ be the ring of dual numbers.

We know the dual number of subrings of $Z(g)$ is infinite.

In fact $Z(g)$ has infinite number of set ideal topological spaces over subrings of $Z(g)$.

Interested reader can compare the set ideal topological spaces of Z with $Z(g)$ over same subrings of Z and $Z(g)$.

Next we see $Q(g)$ is the dual number ring.

$$Q(g) = \{a + bg \mid a, b \in Q, g^2 = 0\}.$$

We can have several subrings of $Q(g)$.

In fact all subrings of Z are also subrings of $Q(g)$. So we can have infinite number of set ideal topological spaces of $Q(g)$ over subrings of $Q(g)$.

A natural question would be can fields have set ideals and set ideal topological spaces associated with fields. The answer is yes. Fields do not have ideals but they have set ideals defined over subrings. This is true for only fields of characteristic zero or over field Z_{p^t} , $t > 1$.

We will first illustrate this situation by some examples.

Example 3.54: Let $R = Q$ be the field of rationals. R contains infinite number of subrings viz., nZ where $n \in N$. Using these subrings we can have infinite number of set ideals.

For instance take $S_1 = 12Z \subseteq Q$, S_1 is a subring of Q . $T_1 = \{\text{Collection of all set ideals of } Q = R \text{ over the subring } 12Z\} = \{\{0\}, Q, 2Z, 3Z, 4Z, 5Z, I_1 = \{n(1/2) \mid n \in Z\} \text{ and so on}\}$ is the set ideal topological space of the field over S_1 .

Thus by introducing the concept of set ideals of a ring we can have set ideals of a field also.

Hence by using these fields we get infinite number of set ideal topological spaces of the field over subrings.

Finally we give also set ideal topological spaces of dual numbers $R(g)$, $C(g)$, $R(g_1)$, $C(g_1)$, $R(g_2)$ and $C(g_2)$. All these have infinite number of set ideal topological spaces of $R(g)$, $C(g)$, or $C(g_1)$ or $C(g_2)$ or $R(g_1)$ or $R(g_2)$ over subrings of $R(g)$ (or $C(g)$ or $C(g_1)$ or $C(g_2)$ or $R(g_1)$ or $R(g_2)$).

It is also pertinent at this juncture to keep on record that rings of complex modulo integers too contribute for set ideal topological spaces over ring $C(Z_n)$ over subrings.

We just illustrate this situation by some examples.

Example 3.55: Let $R = C(Z_4)$ be the ring of complex modulo integers.

$R = C(Z_4) = \{a + bi_F \mid a, b \in Z_4; i_F^2 = 3\}$. The subrings of R are $\{0, 2\} = S_1$, $S_2 = \{0, 2i_F\}$ and $S_3 = \{0, 2, 2i_F, 2+2i_F\}$.

Now we can have 3 set ideal topological spaces of R over these 3 subrings.

Let $T_1 = \{\text{Collection of all set ideals of } R \text{ over } S_1\} = \{\{0\}, R, I_1 = \{0, 2i_F\}, I_2 = \{0, 2\}, I_3 = \{0, 2+2i_F\}, I_4 = \{0, 2, 2+2i_F\}, I_5 = \{0, 2i_F, 2+2i_F\}, I_6 = \{0, 2i_F, 2\}, I_7 = \{0, 2, 2i_F, 2+2i_F\}, I_8 = \{0, 1, 2\}, I_9 = \{0, 3, 2\}, I_{10} = \{0, 1, 2, 3\}, I_{11} = \{0, i_F, 2i_F\}, I_{12} = \{0, i_F, 3, 2, 2i_F\}, I_{13} = \{0, i_F, 3i_F, 2i_F\} \text{ and so on}\}$.

Thus with the complex modulo integer ring $C(Z_4)$ we get set ideal topological spaces of very high order.

Example 3.56: Let $R = C(Z_6) = \{a + bi_F \mid a, b \in Z_6, i_F^2 = 5\}$ be the complex modulo integer ring.

R has subrings of the form $\{0, 3\} = S_1$, $S_2 = \{0, 2, 4\}$, $S_3 = \{0, 1, 2, 3, 4, 5\}$, $S_6 = \{0, 3, 3i_F, 3+3i_F\}$, $S_7 = \{0, 2i_F, 2, 2+2i_F, 4+4i_F, 4, 4i_F + 2, 4i_F, 2i_F + 4\}$ and so on.

Related with each of these subrings we get a set ideal topological spaces of the complex modulo integer rings over the subring.

Of course all of them will be of finite order.

We can conclude this chapter with the following problem.

Problem 3.11: Let $R = C(Z_n)$ be a complex modulo integer ring.

- (i) Find the number of subrings of R .
- (ii) Find the number of distinct set ideal topological spaces of R over these subrings.
- (iii) Find the biggest set ideal topological space of R and the smallest set ideal topological space of R .

As in case of usual topological spaces we can find set ideal topological subspaces of a set ideal topological space. For more refer [14].

Chapter Four

SETS IN VECTOR SPACES

In this chapter we show how sets in a vector space V defined over a field F can be given some nice algebraic structures. Further we also build set vector spaces using sets that is the additive abelian group V is replaced by a set and the field over which it is defined also is replaced by a set. Here we define and describe them.

DEFINITION 4.1: *Let V be a vector space defined over a field F . Let $S \subseteq V$ (S a proper subset of V) and $P \subseteq F$ (P a proper subset of the field F). If for all $s \in S$ and $p \in P$ we have ps and $sp \in S$ then we define S to be a quasi set vector subspace of V over the set P in F .*

So in general given any set in V we will be in a position to find a set P in F (V is the vector space defined over the field F) such that S is a quasi set vector subspace of V over the set P in F .

This is the way set is used and given a nice algebraic structure. We will illustrate this by some examples.

Example 4.1: Let $V = (Q \times Q \times Q)$ be a vector space over the field Q . Let $S = \{(3Z^+ \cup \{0\}) \times (5Z^+ \cup \{0\}) \times (7Z^+ \cup \{0\})\} \subseteq V$; $P = 2Z^+ \cup \{0\} \subseteq Q$; we see S is a quasi set vector subspace of V over P .

Consider $S_1 = \{(17Z^+ \cup \{0\}) \times \{0\} \times \{0\}\} \subseteq V$, S_1 is again a quasi set vector subspace of V over P .

Now consider $P_1 = 3Z^+ \cup 5Z^+ \cup \{0\} \subseteq Q$ both S and S_1 are quasi set vector subspaces of V over P_1 .

It is interesting to note for a given set $S \subseteq V$ we may have several subsets in V which are quasi set vector subspaces of V over the set $P \subseteq F$.

Example 4.2: Let

$$V = \left\{ \begin{bmatrix} a & b \\ c & d \end{bmatrix} \middle| a, b, c, d \in Q \right\}$$

be a vector space over the field Q .

Let

$$S = \left\{ \begin{bmatrix} a & b \\ 0 & 0 \end{bmatrix} \middle| a, b \in 5Z^+ \cup 2Z^+ \right\} \subseteq V$$

be a quasi set vector subspace over the set $P = \{3Z^+ \cup 16Z^+ \cup 7Z^+ \cup \{0\}\} \subseteq Q$. We see we can have several quasi set vector subspaces of V over the set P .

For

$$S_1 = \left\{ \begin{bmatrix} 0 & 0 \\ a & 0 \end{bmatrix} \middle| a \in 3Z^+ \cup 12Z^+ \cup \{0\} \right\} \subseteq V,$$

$$S_2 = \left\{ \begin{bmatrix} 0 & a \\ 0 & b \end{bmatrix} \mid a, b \in 6\mathbb{Z}^+ \cup \{0\} \right\} \subseteq V,$$

$$S_3 = \left\{ \begin{bmatrix} 0 & a \\ b & 0 \end{bmatrix} \mid a, b \in 17\mathbb{Z}^+ \cup \{0\} \right\} \subseteq V,$$

$$S_4 = \left\{ \begin{bmatrix} a & 0 \\ 0 & b \end{bmatrix} \mid a, b \in 19\mathbb{Z}^+ \cup \{0\} \right\} \subseteq V,$$

$$S_5 = \left\{ \begin{bmatrix} a & b \\ c & d \end{bmatrix} \mid a, b, c, d \in \mathbb{Z} \right\} \subseteq V$$

and

$$S_6 = \left\{ \begin{bmatrix} a & b \\ c & d \end{bmatrix} \mid a, b, c, d \in \mathbb{Q}^+ \cup \{0\} \right\} \subseteq V$$

are all quasi set vector subspaces of V over the set $P \subseteq \mathbb{Q}$.

Consider the set

$$S = \left\{ \begin{bmatrix} a & b \\ 0 & 0 \end{bmatrix} \mid a, b \in \mathbb{Q}^+ \cup \{0\} \right\} \subseteq V;$$

we see S is a quasi set vector subspace of V over the sets $P_1 = \{\mathbb{Z}^+ \cup \{0\}\} \subseteq \mathbb{F}$, $P_2 = \{3\mathbb{Z}^+ \cup 2\mathbb{Z}^+ \cup \{0\}\} \subseteq \mathbb{F}$, $P_3 = \{5\mathbb{Z}^+ \cup 17\mathbb{Z}^+ \cup \{0\}\} \subseteq \mathbb{F}$, $P_4 = \{7\mathbb{Z}^+ \cup 2\mathbb{Z}^+ \cup \{0\}\} \subseteq \mathbb{F}$, $P_5 = \{19\mathbb{Z}^+ \cup 23\mathbb{Z}^+ \cup 29\mathbb{Z}^+\} \subseteq \mathbb{F}$ and so on.

Also if $M = \{0, 1, 5, 7, 8, 11\} \subseteq \mathbb{F}$, still S is a quasi set vector subspace of V over M .

We see all subsets of $\mathbb{Q}^+ \cup \{0\}$ will serve as a subset in $\mathbb{F} = \mathbb{Q}$ to make S a quasi set vector subspace of V over M .

The advantage is for a given set P in the field F we can get several quasi set vector subspaces over the set P .

Example 4.3: Let

$$V = \left\{ \begin{bmatrix} a_1 & a_2 & \dots & a_{10} \\ a_{11} & a_{12} & \dots & a_{20} \end{bmatrix} \mid a_i \in \mathbb{R}; 1 \leq i \leq 20 \right\}$$

be a vector space over the field of reals $\mathbb{R} = F$.

Consider

$$M = \left\{ \begin{bmatrix} a_1 & a_2 & \dots & a_{10} \\ 0 & 0 & \dots & 0 \end{bmatrix} \mid a_i \in \mathbb{R}^+ \cup \{0\}; 1 \leq i \leq 10 \right\} \subseteq V$$

to be a quasi set vector subspace of V over the set $P = \mathbb{R}^+ \cup \{0\} \subseteq \mathbb{R} = F$.

In fact all subsets of $\mathbb{R}^+ \cup \{0\}$ finite or infinite will be sets over which M is a quasi set vector subspace of V over those sets.

Now on the other hand if we fix $P = \mathbb{Z}^+ \cup \{0\} \subseteq \mathbb{R} = F$ then all matrices with entries from \mathbb{R} such that it should always be of infinite order and minimum the elements in V or entries of the matrices in V are from the ideals of $\mathbb{Z}^+ \cup \{0\}$. So no finite set in V can be a quasi set vector subspace of V over $P = \mathbb{Z}^+ \cup \{0\} \subseteq \mathbb{R} = F$.

Example 4.4: Let $V = \{\mathbb{Z}_{29} \times \mathbb{Z}_{29}\}$ be a vector space over the field $\mathbb{Z}_{29} = F$. Take $S = \{\mathbb{Z}_{29} \times \{0\}\} \subseteq V$, S is a quasi set vector subspace of V over every subset of \mathbb{Z}_{29} . Suppose

$S_1 = \{(0, 0), (1, 1), (28, 28), (0, 1), (1, 0), (28, 0), (0, 28)\} \subseteq V$ then S_1 is a quasi set vector subspace of V over the sets $P = \{0, 1, 28\} \subseteq \mathbb{Z}_{29}$, $P_1 = \{0, 1\} \subseteq \mathbb{Z}_{29}$, $P_2 = \{0, 28\} \subseteq \mathbb{Z}_{29}$ and $P_3 = \{1, 28\} \subseteq \mathbb{Z}_{29}$.

Let $S_2 = \{(0, 0), (0, 2), (0, 27), (2, 0), (27, 0), (2, 2), (27, 27), (5, 0), (24, 0), (5, 5), (24, 24)\} \subseteq V$ be a quasi set vector subspace of V defined over the set $P_4 = \{0, 1, 28\} \subseteq Z_{29}$.

Thus we have finitely many quasi set vector subspaces of V defined over the subsets of $Z_{29} = F$.

It is an interesting open problem to find the number of quasi set vector subspaces of V when $V = \{Z_p \times Z_p\}$ where p is a prime, V defined over the field Z_p .

Example 4.5: Let $V = \{Z_7 \times Z_7\}$ be a vector space over the field Z_7 . Let $S = \{Z_7 \times \{0\}\}$ be a quasi set vector subspace of V over the set $P = \{0, 1, 2\} \subseteq Z_7$.

Infact S is a quasi set vector subspace of V over every subset of Z_7 .

Let $P_1 = \{0, 1, 2\} \subseteq Z_7$. Consider $S_1 = \{(0, 0), (1, 0), (2, 0), (4, 0)\} \subseteq V$, S_1 is a quasi set vector subspace of V over P_1 .

$S_2 = \{(0, 0), (1, 1), (2, 2), (4, 4)\} \subseteq V$ is a quasi set vector subspace of V over P_1 .

$S_3 = \{(0, 0), (0, 1), (0, 2), (0, 4)\} \subseteq V$ is also a quasi set vector subspace of V over the set P_1 .

Consider $S_2 = \{(0, 0), (3, 0), (6, 0), (5, 0)\} \subseteq V$, S_2 is also a quasi set vector subspace of V over the set P_1 . $S_2 = \{(0, 0), (3, 3), (6, 6), (5, 5)\} \subseteq V$ is also a quasi set vector subspace of V over the set P_1 . $S_2 = \{(0, 0), (1, 3), (2, 6), (4, 5)\} \subseteq V$ is a quasi set vector subspace of V over the set P_1 .

Example 4.6: Let $V = \{Z_{12} \times Z_{12} \times Z_{12}\}$ be a vector space over the field $F = \{0, 4, 8\} \cong Z_3$. Consider the subset $P = \{0, 4\} \subseteq F$ then $S = \{(0, 0, 0), (0, 1, 0), (0, 4, 0)\}, \{(0, 0, 0), (1, 1, 1), (4, 4, 4)\}, \{(0, 0, 0), (2, 2, 2), (8, 8, 8)\}, \{(0, 0, 0), (3, 3, 3)\} \{(0, 0,$

$0), (1, 4, 6), (4, 4, 0)\}$ generates a quasi set vector subspace of V defined over the set P .

Now if we have a quasi set vector subspace over the set $P = \{0, 4\} \subseteq F$.

We see the base set be generated under addition further the base set is heavily dependent on the set over which it is defined. As in case of topological space of set ideals of a semigroup (ring) defined over a subsemigroup (subring), we can define in case of quasi set vector spaces the notion of quasi set topological vector subspace over a set.

Study in this direction is very interesting.

Example 4.7: Let $V = Z_9 \times Z_9$ be the vector space over the field $F = \{0, 3, 6\} \cong Z_3$. $P = \{0, 6\} \subseteq F$ be a set in V . The quasi set vector subspace of V is generated by $S = \langle \{(0, 0), (1, 0), (6, 0)\}, \{(0, 0), (2, 0), (3, 0)\}, \{(0, 0), (2, 3), (3, 0)\} \rangle$.

Thus S is a quasi set topological vector subspace of V over the set $\{0, 6\} = P$. Infact S is pseudo simple but is not simple for $\langle T \rangle = \langle \{(0, 0), (2, 0), (3, 0)\}, \{(0, 0), (2, 3), (3, 0)\} \rangle \subseteq S$ is a quasi set subtopylogical vector subspace of S over the set $P = \{0, 6\}$.

Example 4.8: Let

$$V = \left\{ \begin{bmatrix} a_1 & a_2 & a_3 \\ a_4 & a_5 & a_6 \end{bmatrix} \middle| a_i \in Z_{25}; 1 \leq i \leq 6 \right\}$$

be a vector space over the field $F = \{0, 1, 2, 3, 4\} \cong Z_5$.

Take

$$B = \left\{ \begin{bmatrix} a_1 & a_2 & a_3 \\ 0 & 0 & 0 \end{bmatrix}, \begin{bmatrix} 0 & 0 & 0 \\ a_1 & a_2 & a_3 \end{bmatrix} \middle| a_i \in Z_{25}; 1 \leq i \leq 6 \right\} \subseteq V;$$

B is a quasi set vector subspace of V over the set $P = \{0, 1, 3\} \subseteq F$.

Now if $T = \{\text{Collection of all quasi set vector subspaces of } V \text{ over the set } P = \{0, 1, 3\}\}$;

T is a quasi set topological vector subspace of V over P and the quasi basic set of T is

$$\begin{aligned}
 B_T = & \left\{ \left[\begin{array}{ccc} 0 & 0 & 0 \\ 1 & 0 & 0 \end{array} \right], \left[\begin{array}{ccc} 0 & 0 & 0 \\ 0 & 0 & 0 \end{array} \right], \left[\begin{array}{ccc} 0 & 0 & 0 \\ 3 & 0 & 0 \end{array} \right], \left[\begin{array}{ccc} 0 & 0 & 0 \\ 9 & 0 & 0 \end{array} \right], \right. \\
 & \left[\begin{array}{ccc} 0 & 0 & 0 \\ 2 & 0 & 0 \end{array} \right], \left[\begin{array}{ccc} 0 & 0 & 0 \\ 6 & 0 & 0 \end{array} \right], \left[\begin{array}{ccc} 0 & 0 & 0 \\ 18 & 0 & 0 \end{array} \right], \left[\begin{array}{ccc} 0 & 0 & 0 \\ 4 & 0 & 0 \end{array} \right], \left[\begin{array}{ccc} 0 & 0 & 0 \\ 12 & 0 & 0 \end{array} \right], \\
 & \left[\begin{array}{ccc} 0 & 0 & 0 \\ 11 & 0 & 0 \end{array} \right], \left[\begin{array}{ccc} 0 & 0 & 0 \\ 8 & 0 & 0 \end{array} \right], \left[\begin{array}{ccc} 0 & 0 & 0 \\ 24 & 0 & 0 \end{array} \right], \left[\begin{array}{ccc} 0 & 0 & 0 \\ 22 & 0 & 0 \end{array} \right], \left[\begin{array}{ccc} 0 & 0 & 0 \\ 16 & 0 & 0 \end{array} \right], \\
 & \left[\begin{array}{ccc} 0 & 0 & 0 \\ 23 & 0 & 0 \end{array} \right], \left[\begin{array}{ccc} 0 & 0 & 0 \\ 19 & 0 & 0 \end{array} \right], \left[\begin{array}{ccc} 0 & 0 & 0 \\ 7 & 0 & 0 \end{array} \right], \left[\begin{array}{ccc} 0 & 0 & 0 \\ 21 & 0 & 0 \end{array} \right], \left[\begin{array}{ccc} 0 & 0 & 0 \\ 13 & 0 & 0 \end{array} \right], \\
 & \left. \left[\begin{array}{ccc} 0 & 0 & 0 \\ 14 & 0 & 0 \end{array} \right], \left[\begin{array}{ccc} 0 & 0 & 0 \\ 17 & 0 & 0 \end{array} \right] \right\}, \\
 & \left\{ \left[\begin{array}{ccc} 0 & 0 & 0 \\ 0 & 0 & 0 \end{array} \right], \left[\begin{array}{ccc} 0 & 0 & 0 \\ 5 & 0 & 0 \end{array} \right], \left[\begin{array}{ccc} 0 & 0 & 0 \\ 15 & 0 & 0 \end{array} \right], \left[\begin{array}{ccc} 0 & 0 & 0 \\ 20 & 0 & 0 \end{array} \right], \left[\begin{array}{ccc} 0 & 0 & 0 \\ 10 & 0 & 0 \end{array} \right] \right\}, \\
 & \left\{ \left[\begin{array}{ccc} 0 & 0 & 0 \\ 0 & 1 & 0 \end{array} \right], \left[\begin{array}{ccc} 0 & 0 & 0 \\ 0 & 2 & 0 \end{array} \right], \left[\begin{array}{ccc} 0 & 0 & 0 \\ 0 & 3 & 0 \end{array} \right], \left[\begin{array}{ccc} 0 & 0 & 0 \\ 0 & 4 & 0 \end{array} \right], \left[\begin{array}{ccc} 0 & 0 & 0 \\ 0 & 6 & 0 \end{array} \right], \right. \\
 & \left. \left[\begin{array}{ccc} 0 & 0 & 0 \\ 0 & 7 & 0 \end{array} \right], \left[\begin{array}{ccc} 0 & 0 & 0 \\ 0 & 8 & 0 \end{array} \right], \left[\begin{array}{ccc} 0 & 0 & 0 \\ 0 & 9 & 0 \end{array} \right], \left[\begin{array}{ccc} 0 & 0 & 0 \\ 0 & 11 & 0 \end{array} \right], \left[\begin{array}{ccc} 0 & 0 & 0 \\ 0 & 12 & 0 \end{array} \right] \right\},
 \end{aligned}$$

$$\begin{bmatrix} 0 & 0 & 0 \\ 0 & 13 & 0 \end{bmatrix}, \begin{bmatrix} 0 & 0 & 0 \\ 0 & 14 & 0 \end{bmatrix}, \begin{bmatrix} 0 & 0 & 0 \\ 0 & 17 & 0 \end{bmatrix}, \begin{bmatrix} 0 & 0 & 0 \\ 0 & 24 & 0 \end{bmatrix}, \begin{bmatrix} 0 & 0 & 0 \\ 0 & 22 & 0 \end{bmatrix},$$

$$\left\{ \begin{bmatrix} 0 & 0 & 0 \\ 0 & 16 & 0 \end{bmatrix}, \begin{bmatrix} 0 & 0 & 0 \\ 0 & 23 & 0 \end{bmatrix}, \begin{bmatrix} 0 & 0 & 0 \\ 0 & 18 & 0 \end{bmatrix}, \begin{bmatrix} 0 & 0 & 0 \\ 0 & 21 & 0 \end{bmatrix}, \begin{bmatrix} 0 & 0 & 0 \\ 0 & 19 & 0 \end{bmatrix} \right\}$$

$$\left\{ \begin{bmatrix} 0 & 0 & 0 \\ 0 & 0 & 0 \end{bmatrix}, \begin{bmatrix} 0 & 0 & 0 \\ 0 & 5 & 0 \end{bmatrix}, \begin{bmatrix} 0 & 0 & 0 \\ 0 & 15 & 0 \end{bmatrix}, \begin{bmatrix} 0 & 0 & 0 \\ 0 & 20 & 0 \end{bmatrix}, \begin{bmatrix} 0 & 0 & 0 \\ 0 & 10 & 0 \end{bmatrix} \right\}$$

and so on}. We see $o(B_T) = 12$.

The associated lattice is a Boolean algebra of order 2^{12} .

Example 4.9: Let

$$V = \left\{ \begin{bmatrix} a \\ b \\ c \\ d \end{bmatrix} \mid a, b, c, d \in \mathbb{Z}_{42} \right\}$$

be a vector space defined over the field

$$F = \{0, 6, 12, 18, 24, 30, 36\} \cong \mathbb{Z}_7.$$

Consider $P = \{6, 0, 12\} \subseteq F$. Let $T = \{\text{Collection of all quasi set vector subspaces of } V \text{ over the set } P = \{0, 6, 12\} \subseteq F\}$, be the quasi set topological vector subspace of V defined over the set $P = \{0, 6, 12\} \subseteq F$.

The basic set of T is

$$B_T = \left\{ \left\{ \begin{bmatrix} 0 \\ 0 \\ 0 \\ 0 \end{bmatrix}, \begin{bmatrix} 1 \\ 0 \\ 0 \\ 0 \end{bmatrix}, \begin{bmatrix} 6 \\ 0 \\ 0 \\ 0 \end{bmatrix}, \begin{bmatrix} 36 \\ 0 \\ 0 \\ 0 \end{bmatrix}, \begin{bmatrix} 12 \\ 0 \\ 0 \\ 0 \end{bmatrix}, \begin{bmatrix} 30 \\ 0 \\ 0 \\ 0 \end{bmatrix}, \begin{bmatrix} 24 \\ 0 \\ 0 \\ 0 \end{bmatrix}, \begin{bmatrix} 18 \\ 0 \\ 0 \\ 0 \end{bmatrix} \right\} \right\},$$

$$\left\{ \begin{bmatrix} 0 \\ 0 \\ 0 \\ 0 \end{bmatrix}, \begin{bmatrix} 2 \\ 0 \\ 0 \\ 0 \end{bmatrix}, \begin{bmatrix} 12 \\ 0 \\ 0 \\ 0 \end{bmatrix}, \begin{bmatrix} 24 \\ 0 \\ 0 \\ 0 \end{bmatrix}, \begin{bmatrix} 18 \\ 0 \\ 0 \\ 0 \end{bmatrix}, \begin{bmatrix} 30 \\ 0 \\ 0 \\ 0 \end{bmatrix} \right\},$$

$$\left\{ \begin{bmatrix} 0 \\ 0 \\ 0 \\ 0 \end{bmatrix}, \begin{bmatrix} 4 \\ 0 \\ 0 \\ 0 \end{bmatrix}, \begin{bmatrix} 24 \\ 0 \\ 0 \\ 0 \end{bmatrix}, \begin{bmatrix} 6 \\ 0 \\ 0 \\ 0 \end{bmatrix}, \begin{bmatrix} 36 \\ 0 \\ 0 \\ 0 \end{bmatrix}, \begin{bmatrix} 12 \\ 0 \\ 0 \\ 0 \end{bmatrix}, \dots \dots \right\}.$$

Example 4.10: Let $V = \{Z_3 \times Z_3\}$ be a vector space over the field Z_3 . Let $P = \{0, 1\} \subseteq Z_3$. $T = \{\text{Collection of all quasi set vector subspaces of } V \text{ over the set } P\}$ be the quasi set topological vector subspace of V defined over the set $P \subseteq Z_3$.

The basic set of T ,

$$B_T = \{(0, 0), (1, 0)\}, \{(0, 0), (2, 0)\}, \{(0, 0), (0, 2)\}, \{(0, 0), (0, 1)\}, \{(0, 0), (1, 1)\}, \{(0, 0), (2, 2)\}, \{(0, 0), (1, 2)\}, \{(0, 0), (2, 1)\}.$$

$o(B_T) = 8$. The basic set for any quasi vector subspace over $\{0, 1\}$ is of order one.

Example 4.11: Let $V = \{Z_{10} \times Z_{10} \times Z_{10}\}$ be a vector space defined over the field $F = \{0, 2, 4, 6, 8\} \subseteq Z_{10}$. Let $P = \{0, 2, 8\} \subseteq F$ be a subset in F . Consider $T = \{\text{Collection of all quasi set vector subspaces of } V \text{ over the set } P = \{0, 2, 8\} \subseteq F\}$. T is a quasi set topological vector subspace of V over P .

The basic set of T is $B_T = \{(0, 0, 0), (1, 0, 0), (2, 0, 0), (6, 0, 0), (0, 2, 0), (0, 6, 0), (0, 8, 0), (0, 4, 0)\}, \{(0, 0, 0), (0, 0, 2), (0, 0, 4), (0, 0, 6), (0, 0, 8)\}, \{(0, 0, 0), (3, 0, 0), (6, 0, 0), (4, 0, 0), (2, 0, 0), (8, 0, 0)\}, \dots, \{(0, 0, 0), (7, 8, 9), (4, 6, 8), (8, 2, 6), (6, 4, 2), (2, 8, 4)\}$.

Any proper subset of T will generate a quasi set subtopological vector subspace of T defined over the set $P = \{0, 2, 8\}$. Let $P_1 = \{0, 8\} \subseteq P$.

Now $T_1 = \{\text{Collection of all quasi set vector subspaces of } V \text{ over the set } P_1\}$ is the quasi set topological vector subspace of V defined over the set P_1 .

Now the basic set of T_1 is $B_{T_1} = \{(0, 0, 0), (1, 0, 0), (8, 0, 0), (4, 0, 0), (2, 0, 0), (6, 0, 0)\}, \{(0, 0, 0), (3, 0, 0), (4, 0, 0), (2, 0, 0), (6, 0, 0), (8, 0, 0)\}, \{(0, 0, 0), (5, 0, 0)\}, \{(0, 0, 0), (0, 5, 0)\}, \{(0, 0, 0), (0, 0, 5)\}, \{(0, 0, 0), (5, 5, 5)\}, \{(0, 0, 0), (0, 1, 0), (0, 8, 0), (0, 4, 0), (0, 2, 0), (0, 6, 0)\}, \dots, \{(0, 0, 0), (1, 4, 3), (8, 2, 4), (4, 6, 2), (2, 8, 6), (6, 4, 8)\}, \{(0, 0, 0), (5, 3, 9), (0, 4, 2), (0, 2, 6), (0, 6, 8), (0, 8, 4)\}, \{(0, 0, 0), (9, 0, 0), (2, 0, 0), (6, 0, 0), (8, 0, 0), (4, 0, 0)\}$.

We see $T_1 \subseteq T$ however we cannot compare the basic set elements of T_1 and T .

Thus T is both not simple as well as pseudo simple.

We see by defining quasi set vector subspaces (of a vector space) defined over the set P , we can make the collection of such spaces into a topological space and this topological space depends on P . Thus for a given vector space we can get several topological spaces which depends only on the subsets of the field F .

Example 4.12: Let

$$V = \left\{ \begin{bmatrix} a & b \\ c & d \end{bmatrix} \mid a, b, c, d \in Z_6 \right\}$$

be a vector space over the field $F = \{0, 2, 4\} \subseteq Z_6$.

Let

$$B = \left\{ \left[\begin{array}{cc} a & b \\ 0 & d \end{array} \right], \left[\begin{array}{cc} c & 0 \\ e & f \end{array} \right] \mid a, b, d \in 3Z_2 \text{ and } c, e, f \in 2Z_2 \right\}$$

be a set vector space over $P = \{0, 2\} \subseteq F$. Now consider $T = \{\text{Collection of all quasi set vector subspaces of } V \text{ over the set } P\}$, T is the quasi set topological vector subspace of V over the set P .

The basic set associated with T be

$$B_T = \left\{ \left\{ \left[\begin{array}{cc} 0 & 0 \\ 0 & 0 \end{array} \right], \left[\begin{array}{cc} 1 & 0 \\ 0 & 0 \end{array} \right], \left[\begin{array}{cc} 2 & 0 \\ 0 & 0 \end{array} \right], \left[\begin{array}{cc} 4 & 0 \\ 0 & 0 \end{array} \right] \right\}, \left\{ \left[\begin{array}{cc} 0 & 0 \\ 0 & 0 \end{array} \right], \left[\begin{array}{cc} 3 & 0 \\ 0 & 0 \end{array} \right] \right\}, \right. \\ \left. \left\{ \left[\begin{array}{cc} 0 & 0 \\ 0 & 0 \end{array} \right], \left[\begin{array}{cc} 0 & 0 \\ 1 & 0 \end{array} \right], \left[\begin{array}{cc} 0 & 0 \\ 2 & 0 \end{array} \right], \left[\begin{array}{cc} 0 & 0 \\ 4 & 0 \end{array} \right] \right\}, \right. \\ \left. \left\{ \left[\begin{array}{cc} 0 & 0 \\ 0 & 0 \end{array} \right], \left[\begin{array}{cc} 0 & 0 \\ 3 & 0 \end{array} \right] \right\}, \left\{ \left[\begin{array}{cc} 0 & 0 \\ 0 & 0 \end{array} \right], \left[\begin{array}{cc} 5 & 0 \\ 0 & 0 \end{array} \right], \left[\begin{array}{cc} 4 & 0 \\ 0 & 0 \end{array} \right], \left[\begin{array}{cc} 2 & 0 \\ 0 & 0 \end{array} \right] \right\}, \dots, \right. \\ \left. \left\{ \left[\begin{array}{cc} 0 & 0 \\ 0 & 0 \end{array} \right], \left[\begin{array}{cc} 2 & 3 \\ 4 & 5 \end{array} \right], \left[\begin{array}{cc} 4 & 0 \\ 2 & 4 \end{array} \right], \left[\begin{array}{cc} 2 & 0 \\ 4 & 2 \end{array} \right] \right\} \text{ and so on} \}.$$

Clearly T is pseudo simple as P has no proper subsets of cardinality 2.

Example 4.13: Let $V = \{Z_5 \times Z_5\}$ be a vector space defined over the field Z_5 . Let $P = \{0, 1, 4\}$ be a subset of S .

$T = \{\text{Collection of all quasi set vector subspaces of } V \text{ over the set } P\}$, be the quasi set topological vector subspace of V over the set P . The basic set of T is $B_T = \{(0, 0), (1, 0), (4, 0)\}, \{(0, 0), (0, 1), (0, 4)\}, \{(0, 0), (1, 1), (4, 4)\}, \{(0, 0), (2, 0), (3,$

$0\}$, $\{(0, 0), (0, 2), (0, 3)\}$, $\{(0, 0), (2, 2), (3, 3)\}$, $\{(0, 0), (1, 2), (4, 3)\}$, $\{(0, 0), (2, 1), (3, 4)\}$, $\{(0, 0), (1, 3), (4, 2)\}$, $\{(0, 0), (3, 1), (2, 4)\}$, $\{(0, 0), (2, 3), (3, 2)\}$, $\{(0, 0), (1, 4), (4, 1)\}$).

Clearly $o(B_T) = 12 = (o(V)-1)/2$.

We see T is not simple as it has quasi set subtopological vector subspaces say $M = \langle \{(0, 0), (1, 0), (4, 0)\}, \{(0, 0), (1, 1), (4, 4)\}, \{(0, 0), (1, 3), (4, 2)\}, \{(0, 0), (1, 4), (4, 1)\} \rangle$. M is a quasi set subtopological vector subspace of T of order 2^4 .

Consider $P_1 = \{0, 4\} \subseteq Z_5$. Let $N = \langle \{(0, 0), (1, 0), (4, 0)\}, \{(0, 0), (2, 0), (3, 0)\}, \{(0, 0), (0, 1), (0, 4)\}, \{(0, 0), (0, 2), (0, 3)\}, \{(0, 0), (1, 1), (4, 4)\}, \{(0, 0), (2, 3), (3, 2)\}, \{(0, 0), (2, 2), (3, 3)\}, \{(0, 0), (1, 4), (4, 1)\}, \{(0, 0), (1, 2), (4, 3)\}, \{(0, 0), (2, 1), (3, 4)\}, \{(0, 0), (1, 3), (4, 2)\}, \{(0, 0), (3, 1), (2, 4)\} \rangle$ $o(B_N) = 12$ and $B_N = B_T$; however the subsets are different but the quasi set topological vector subspaces are identical.

Consider $P_2 = \{0, 1\} \subseteq P$. Thus $S = \{ \text{Collection of all quasi set vector subspaces of } V \text{ over the set } P_2 \}$ be the quasi subset subtopological vector subspace of T over the set $P_2 = \{0, 1\}$. The basic set associated with T is $B_S = \langle \{(0, 0), (1, 0)\}, \{(0, 0), (2, 0)\}, \{(0, 0), (3, 0)\}, \{(0, 0), (4, 0)\}, \{(0, 0), (0, 1)\}, \{(0, 0), (0, 2)\}, \{(0, 0), (0, 3)\}, \{(0, 0), (0, 4)\}, \{(0, 0), (1, 1)\}, \{(0, 0), (2, 2)\}, \{(0, 0), (3, 3)\}, \{(0, 0), (4, 4)\}, \{(0, 0), (1, 2)\}, \{(0, 0), (1, 3)\}, \{(0, 0), (1, 4)\}, \{(0, 0), (2, 3)\}, \{(0, 0), (2, 4)\}, \{(0, 0), (3, 4)\}, \{(0, 0), (3, 2)\}, \{(0, 0), (3, 1)\}, \{(0, 0), (4, 1)\}, \{(0, 0), (2, 1)\}, \{(0, 0), (4, 3)\}, \{(0, 0), (4, 2)\} \rangle$. $o(B_S) = 2^4 = o(V)-1$.

We see $S \subseteq T$ but $o(B_S) > o(B_T)$.

Example 4.14: Let $V = \{Z_{10} \times Z_{10}\}$ be the vector space defined over the field $F = \{0, 5\} \cong Z_2$.

We see V is such that we cannot have a quasi set vector subspace associated with V. For F is itself of order two.

Example 4.15: Let $V = \{Z_{22} \times Z_{22} \times Z_{22} \times Z_{22}\}$ be a vector space defined over the field $F = \{0, 11\} \subseteq Z_{22}$. We see V has no quasi set vector subspace of V associated with it, we have a class of such vector spaces.

THEOREM 4.1: Let V be a vector space whose entries are from Z_{2p} defined over the field $F = \{0, p\}$ (p a prime). V has no quasi set vector subspace associated with it.

That is V has no quasi set topological vector subspace associated with it.

Proof: Follows from the very fact $F = \{0, p\}$ has no proper subsets of order two as F itself is of order two.

Example 4.16: Let $V = \{Z_{21} \times Z_{21}\}$ be a vector space defined over the field $F = \{0, 1, 7\} \subseteq Z_{21}$ ($F \cong Z_3$). Let $P = \{0, 1\} \subseteq F$.

$T = \{\text{Collection of all quasi set vector subspaces defined over } P\}$ be the quasi set topological vector subspace of V over the set P .

The basic set of T is given by $B_T = \{\{(0, 0), (0, 1)\}, \{(0, 0), (0, 2)\}, \dots, \{(0, 0), (20, 20)\}\}$ and $o(B_T) = o(V) - 1 = 21^2 - 1 = 440$.

Suppose we take $S = \{\text{Collection of all quasi set vector subspaces of } V \text{ over the set } P_1 = \{0, 7\}\}$; the quasi set topological vector subspace of V over P_1 .

The basic set of S ; $B_S = \{\{(0, 0), (0, 1), (0, 7)\}, \{(0, 0), (0, 2), (0, 14)\}, \{(0, 0), (0, 3)\}, \{(0, 0), (3, 0)\}, \{(0, 0), (0, 4), (0, 7)\}, \{(0, 0), (0, 5), (0, 14)\}, \{(0, 0), (0, 6)\}, \{(0, 0), (0, 8), (0, 14)\}, \{(0, 0), (0, 9)\}, \{(0, 0), (0, 10), (0, 7)\}, \{(0, 0), (0, 11), (0, 14)\}, \{(0, 0), (0, 12)\}, \{(0, 0), (0, 13), (0, 7)\}, \{(0, 0), (0, 15)\}, \{(0, 0), (0, 16), (0, 7)\}, \{(0, 0), (0, 17), (0, 14)\}, \{(0, 0), (0, 18)\}, \{(0, 0), (0, 19), (0, 7)\}, \{(0, 0), (0, 20), (0, 14)\} \dots \{(0, 0), (1, 2), (7, 14)\}, \{(0, 0), (1, 3), (7, 0)\}, \{(0, 0), (1, 4), (7, 7)\}, \{(0, 0), (1, 5), (7, 14)\} \dots\}$.

Clearly $\mathfrak{o}(B_S) \neq \mathfrak{o}(B_T)$. T and S different quasi set topological vector subspaces of V over the set $P = \{0, 1\}$ and $P_1 = \{0, 7\}$ respectively.

Let $P_2 = \{7, 14\} \subseteq F$; $M = \{\text{Collection of all quasi set vector subspace of V over the set } P_2 = \{7, 14\} \subseteq F\}$ be the quasi set topological vector subspace of V over the set P_2 .

The basic set of M be $B_M = \{(0, 0)\}, \{(0, 1), (0, 7), (0, 14)\}, \{(0, 2), (0, 14), (0, 7)\}, \{(0, 3)\}, \{(3, 0)\}, \{(3, 3)\}, \{(0, 4), (0, 7), (0, 14)\}, \{(0, 5), (0, 14), (0, 7)\}, \{(0, 6)\}, \{(6, 0)\}, \{(6, 6)\}, \{(0, 8), (0, 14), (0, 7)\}, \{(0, 9)\}, \{(9, 0)\}, \{(9, 9)\}, \{(0, 10), (0, 7), (0, 14)\}, \{(0, 11), (0, 14), (0, 7)\}, \{(0, 12)\}, \{(12, 0)\}, \{(12, 12)\}, \{(0, 13), (0, 7), (0, 14)\}, \{(0, 15)\}, \{(15, 0)\}, \{(15, 15)\}, \{(0, 16), (0, 7), (0, 14)\}, \{(0, 17), (0, 14), (0, 7)\}, \{(0, 18)\}, \{(0, 19), (0, 7), (0, 14)\}, \{(0, 20), (0, 14), (0, 7)\}, \dots, \{(20, 20), (14, 14), (7, 7)\}$.

M is also a different quasi set topological vector subspace different from T and S.

We see all the three quasi set topological vector subspace are pseudo simple and they are not simple. All the three quasi set topological vector subspaces M, S and T have several quasi set subtopological vector subspace.

Example 4.17: Let $V = Z_{39} \times Z_{39}$ be a vector space over the field $F = \{0, 13, 26\} \cong Z_3$. Let $P_1 = \{0, 13\} \subseteq F$ and $T_1 = \{\text{Collection of all quasi set vector subspaces of V defined over the set } P_1\}$ be the quasi set topological vector subspace of V over the set P. The basic set of T_1 denoted by

$B_{T_1} = \{(0, 0), (1, 0), (13, 0)\}, \{(0, 0), (1, 1), (13, 13)\}, \{(0, 0), (0, 1), (0, 13)\}, \{(0, 0), (2, 0), (26, 0)\}, \{(0, 0), (3, 0)\}, \{(0, 0), (4, 0), (13, 0)\}, \{(0, 0), (5, 0), (26, 0)\}, \{(0, 0), (6, 0)\}, \{(0, 0), (7, 0), (13, 0)\}, \{(0, 0), (8, 0), (26, 0)\}, \{(0, 0), (9, 0)\}, \{(0, 0), (10, 0), (13, 0)\}, \{(0, 0), (11, 0), (26, 0)\}, \{(0, 0), (15, 0)\}, \{(0, 0), (16, 0), (13, 0)\}, \{(0, 0), (17, 0), (26, 0)\}, \{(0, 0),$

$(18, 0)\}, \{(0, 0), (19, 0), (13, 0)\}, \{(0, 0), (20, 0), (26, 0)\}, \{(0, 0), (21, 0)\}, \{(0, 0), (22, 0), (13, 0)\}, \{(0, 0), (23, 0), (26, 0)\}, \{(0, 0), (24, 0)\}, \{(0, 0), (25, 0), (13, 0)\}, \{(0, 0), (27, 0)\}, \{(0, 0), (28, 0), (13, 0)\}, \{(0, 0), (29, 0), (26, 0)\}, \{(0, 0), (30, 0)\}, \{(0, 0), (31, 0), (13, 0)\}, \{(0, 0), (32, 0), (26, 0)\}, \{(0, 0), (33, 0)\}, \{(0, 0), (34, 0), (13, 0)\}, \{(0, 0), (35, 0), (26, 0)\}, \{(0, 0), (36, 0)\}, \{(0, 0), (37, 0), (13, 0)\}, \{(0, 0), (38, 0), (26, 0)\} \dots\}.$

Let $P_2 = \{0, 26\} \subseteq F$ and $T_2 = \{\text{Collection of all quasi set vector subspaces of } V \text{ over the set } P_2\}$, be the quasi set topological vector subspace of V over the set P_2 . Let the basic set of T_2 denoted by

$B_{T_2} = \{\{(0, 0), (1, 0), (26, 0), (13, 0)\}, \{(0, 0), (2, 0), (13, 0), (26, 0)\}, \{(0, 0), (3, 0)\}, \{(0, 0), (4, 0), (26, 0), (13, 0)\}, \{(0, 0), (5, 0), (13, 0), (26, 0)\}, \{(0, 0), (6, 0)\}, \{(0, 0), (7, 0), (26, 0), (13, 0)\}, \{(0, 0), (8, 0), (13, 0), (26, 0)\}, \{(0, 0), (9, 0)\}, \{(0, 0), (10, 0), (26, 0), (13, 0)\}, \{(0, 0), (11, 0), (13, 0), (26, 0)\}, \{(0, 0), (12, 0)\}, \{(0, 0), (14, 0), (13, 0), (26, 0)\}, \{(0, 0), (15, 0)\}, \{(0, 0), (16, 0), (26, 0), (13, 0)\}, \{(0, 0), (17, 0), (26, 0), (13, 0)\}, \{(0, 0), (18, 0)\}, \{(0, 0), (19, 0), (13, 0), (26, 0)\}, \{(0, 0), (20, 0), (13, 0), (26, 0)\}, \{(0, 0), (21, 0)\}, \{(0, 0), (22, 0), (13, 0), (26, 0)\}, \{(0, 0), (23, 0), (13, 0), (26, 0)\}, \{(0, 0), (24, 0)\}, \{(0, 0), (25, 0), (13, 0), (26, 0)\}, \{(0, 0), (27, 0)\}, \{(0, 0), (28, 0), (13, 0), (26, 0)\}, \{(0, 0), (29, 0), (13, 0), (26, 0)\}, \{(0, 0), (30, 0)\}, \{(0, 0), (31, 0), (26, 0), (13, 0)\}, \{(0, 0), (32, 0), (26, 0), (13, 0)\}, \{(33, 0), (0, 0), (26, 0), (13, 0)\}, \{(34, 0), (0, 0), (26, 0), (13, 0)\}, \{(36, 0), (0, 0)\}, \{(0, 0), (35, 0), (13, 0), (26, 0)\}, \{(0, 0), (37, 0), (26, 0), (13, 0)\}, \{(0, 0), (38, 0), (13, 0), (26, 0)\}, \dots\}.$

Let $P_3 = \{13, 26\} \subseteq F$; $T_3 = \{\text{Collection of all quasi set vector subspaces of } V \text{ over the set } P_3 = \{13, 26\}\}$, be the quasi set topological vector subspace of V over P_3 .

Let B_{T_3} be the basic set, $B_{T_3} = \{(0, 0)\}, \{(1, 0), (13, 0), (26, 0)\}, \{(2, 0), (26, 0), (13, 0)\}, \{(3, 0)\}, \{(4, 0), (13, 0), (26, 0)\}, \{(5, 0), (26, 0), (13, 0)\}, \{(6, 0)\}, \{(7, 0), (26, 0), (13, 0)\}, \{(8,$

$(0), (26, 0), (13, 0)\}, \{(9, 0)\}, \{(10, 0), \{(26, 0), (13, 0)\}, \{(11, 0), (26, 0), (13, 0)\}, \{(12, 0)\}, \{(14, 0), (26, 0), (13, 0)\}, \{(15, 0)\}, \{(16, 0), (26, 0), (13, 0)\}, \{(17, 0), (26, 0), (13, 0)\}, \{(18, 0)\}, \{(19, 0), (26, 0), (13, 0)\}, \{(20, 0), (26, 0), (13, 0)\}, \{(21, 0)\}, \{(22, 0), (26, 0), (13, 0)\}, \{(23, 0), (13, 0), (26, 0)\}, \{(24, 0), (25, 0), (13, 0), (26, 0)\}, \{(27, 0)\}, \{(28, 0), (26, 0), (13, 0)\}, \{(29, 0), (13, 0), (26, 0)\}, \{(30, 0)\}, \{(31, 0), (13, 0), (26, 0)\}, \{(32, 0), (13, 0), (26, 0)\}, \{(33, 0)\}, \{(34, 0), (13, 0), (26, 0)\}, \{(35, 0), (13, 0), (26, 0)\}, \{(36, 0)\}, \{(37, 0), (13, 0), (26, 0)\}, \{(38, 0), (13, 0), (26, 0)\}$ and so on}.

We see of the three topologies T_1, T_2 and T_3, T_1 and T_2 are identical as $B_{T_1} = B_{T_2}$. We see T_3 is different from T_1 and T_2 .

Further we see all the three quasi set topological vector subspaces are not simple and we see they have several quasi set subtopylogical vector subspaces. However all the three quasi set topological vector subspaces are pseudo simple for the simple reason the sets P_i are of cardinality two so we cannot find proper subsets of cardinality two on $P_i, i = 1, 2, 3$.

THEOREM 4.2: *Let V be a vector space with entries from Z_{3p} (p a prime) defined over the field $F = \{0, p, 2p\} \subseteq Z_{3p}$. V has three quasi set topological vector subspaces all of them pseudo simple but not simple.*

Proof is direct and exploits only simple number theoretic techniques.

We leave the following problems as open conjectures.

Problem 4.1: Let V be a vector space with entries frame Z_{pq} where p and q are two distinct primes be defined over $F \cong Z_p$ or $F \cong Z_q$.

- (i) Find the number of quasi set topological vector subspaces defined over the field $F \cong Z_p$ (and $F \cong Z_q$).
- (ii) When are these pseudo simple?

(iii) How many distinct such quasi set topological vector subspaces exist?

Problem 4.2: Study the problems mentioned in problem 4.2 of Z_n , $n = p_1, p_2, \dots, p_t$ where each p_i 's are prime; $1 \leq i \leq t$.

Example 4.18: Let $V = Z_{30} \times Z_{30} \times Z_{30}$ be a vector space defined over the field $F = \{0, 10, 20\} \cong Z_{30}$. Let $P_1 = \{0, 10\} \subseteq F$ and $T_1 = \{\text{Collection of all quasi set vector subspaces of } V \text{ over } P_1\}$ be the quasi set topological vector subspace of V over the set P_1 .

The basic set of T_1 ; $B_{T_1} = \{(0, 0, 0), (10, 0, 0), (1, 0, 0)\}, \{(0, 0, 0), (2, 0, 0), (20, 0, 0)\}, \{(0, 0, 0), (3, 0, 0)\}, \{(0, 0, 0), (4, 0, 0), (10, 0, 0)\}, \{(0, 0, 0), (5, 0, 0), (20, 0, 0)\}, \{(0, 0, 0), (6, 0, 0)\}, \{(0, 0, 0), (7, 0, 0), (10, 0, 0)\}, \dots, \{(0, 0, 0), (6, 9, 28), (0, 0, 10)\}, \dots\}$.

In the same way we can find quasi set topological vector subspaces over $\{0, 20\} = P_2$ and $P_3 = \{10, 20\}$.

Further we can take V to be a vector space defined over the field $F_1 = \{0, 6, 12, 18, 24\} \cong Z_5$; we see this V defined on F has different set of quasi set topological vector subspaces. Further the number of quasi set topological vector subspaces defined is ${}_5C_2 + {}_5C_3 + {}_5C_4 = 10 + 10 + 5 = 25$.

Of these only 10 quasi set topological vector subspaces are pseudo simple rest of the 15 spaces are not pseudo simple.

Further all the 25 spaces are not simple, several quasi set subtopological vector subspaces can be defined.

For take $P_1 = \{0, 6, 12\} \subseteq F_1$. $T_1 = \{\text{Collection of all quasi set vector subspaces of } V \text{ defined over } P_1\}$ be the quasi set topological vector subspaces of V over P_1 .

The basic set of T_1 is $B_{T_1} = \{(0, 0, 0), (1, 0, 0), (6, 0, 0), (12, 0, 0), (24, 0, 0), (18, 0, 0)\}, \{(0, 0, 0), (0, 1, 0), (0, 12, 0), (0, 24, 0), (0, 18, 0)\}, \dots, \{(0, 0, 0), (2, 0, 0), (12, 0, 0), (24, 0, 0), (6, 0, 0), (18, 0, 0)\}, \{(0, 0, 0), (3, 0, 0), (18, 0, 0), (6, 0, 0), (12, 0, 0), (24, 0, 0)\}, \{(0, 0, 0), (4, 0, 0), (24, 0, 0), (18, 0, 0)\}, \{(0, 0, 0), (5, 0, 0)\}, \{(0, 0, 0), (7, 0, 0), (12, 0, 0), (24, 0, 0), (18, 0, 0), (6, 0, 0)\}, \dots\}$.

The basic set of T_1 is of finite order any element or a pair of elements or a triple element will generate a quasi set subtopological vector subspace of V .

Let $P_2 = \{0, 18\} \subseteq F$ be a subset of F_1 . T_2 be the collection of all quasi set vector subspaces of V over the set P_2 . Then T_2 is a quasi set topological vector subspace of V over the set P_2 .

The basic set of T_2 be $B_{T_2} = \{(0, 0, 0), (1, 0, 0), (18, 0, 0), (24, 0, 0), (12, 0, 0), (6, 0, 0)\}, \{(0, 0, 0), (2, 0, 0), (6, 0, 0), (18, 0, 0), (24, 0, 0), (12, 0, 0)\}$ and so on}.

Let $P_3 = \{0, 24\} \subseteq F_1$; if T_3 be the collection of all quasi set vector subspaces of V defined over the set P_3 ; then T_3 is the quasi set topological vector subspaces of V over T_3 . We see T_3 is pseudo simple but T_3 is not simple for T_3 has several quasi set subtopological vector subspaces defined over the set P_3 .

Now thus using vector spaces we can build not subvector spaces or vector subspaces but build quasi set vector subspaces which are set vector subspaces of a vector space defined over the field. Thus here only the set theory concept alone is exploited we do not use the complete vector space notion alone.

Thus by using sets we have made these concepts simple and we see some naturally defined algebraic structure can be developed on them.

Now we may have for the given vector space defined over a field F the collection of all vector subspaces of V over F is a topological space.

We will compare this by an example.

Example 4.19: Let $V = Z_3 \times Z_3$ be a vector space defined over the field $F = Z_3$. The vector subspaces of V over Z_3 are

$W_1 = \{Z_3 \times \{0\}\} \subseteq V$ is a vector subspace of V over F .
 $W_2 = \{\{0\} \times Z_3\} \subseteq V$ is again a vector subspace of V over F .
 We see the topological space associated with the vector subspaces is $\{(0, 0), W_1, W_2 \text{ and } V = W_1 \cup W_2\}$. Thus the lattice associated with V is

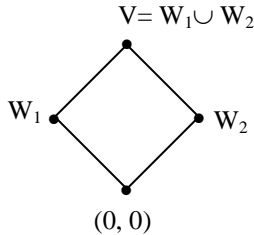

Now we find the quasi set topological subspaces associated with V .

Let us take $P_1 = \{0, 1\} \subseteq Z_3$.

$T_1 = \{\text{Collection of all quasi set vector subspaces of } V \text{ over } P_1\}$ be the quasi set topological vector subspace. The basic set of T_1 ,

$B_{T_1} = \{\{(0, 0), (1, 0)\}, \{(0, 0), (0, 1)\}, \{(0, 0), (2, 0)\}, \{(0, 0), (0, 2)\}, \{(0, 0), (2, 1)\}, \{(0, 0), (1, 2)\}, \{(0, 0), (1, 1)\}, \{(0, 0), (2, 2)\}\}$. The lattice associated with T_1 is a Boolean algebra of order 2^8 with elements of B_{T_1} as atoms.

Let us take $P_2 = \{0, 2\} \subseteq Z_3$.

$T_2 = \{\text{Collection of all quasi set vector subspaces of } V \text{ over } P_2\}$ be the quasi set topological vector subspace of V over P_2 . The basic set of T_2 be $B_{T_2} = \{\{(0, 0), (1, 0), (2, 0)\}, \{(0, 0), (0, 1), (0, 2)\}, \{(0, 0), (1, 1), (2, 2)\}, \{(0, 0), (1, 2), (2, 1)\}\}$.

$o(B_{T_2}) = 4$ and the associated lattice is a Boolean algebra of order 2^4 .

Take $P_3 = \{1, 2\} \subseteq Z_3$ be the subset of Z_3 . T_3 be the collection of all quasi set vector subspaces of V over P_3 . T_3 is a quasi set topological vector subspace of V over the set P_3 . The basic set of T_3 denoted by $B_{T_3} = \{\{(0, 0)\}, \{(1, 0), (2, 0)\}, \{(0, 1), (0, 2)\}, \{(1, 1), (2, 2)\}, \{(1, 2), (2, 1)\}\}$.

The lattice associated with the quasi set topological vector subspace T_3 of V is of order 2^5 . We have three quasi set topological vector subspaces associated with V .

Thus is the marked difference between the usual vector subspace topological spaces and the quasi set topological vector subspaces of V .

Example 4.20: Let $V = \{Z_5 \times Z_5\}$ be a vector space over the field $Z_5 = F$. The set of all vector subspaces of V over the field Z_5 is $T = \{Z_5 \times \{0\}, \{0\} \times Z_5\}$. Thus the lattice associated with the topological vector subspace. T is a Boolean algebra of order four.

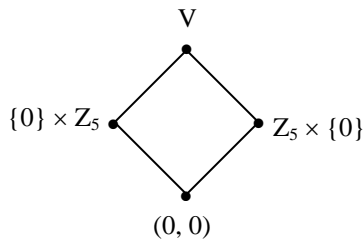

We see for the vector space $V = Z_5 \times Z_5$, we have 25 quasi set topological vector subspaces of V defined over different subsets of the field Z_5 .

This is one of the fundamental advantages of studying and defining the new notion of quasi set topological vector subspaces of a vector space.

THEOREM 4.3: *Let V be any vector space defined the field Z_p (p a prime). V has only one topological vector subspace associated with V and ${}_pC_2 + {}_pC_3 + \dots + {}_pC_{p-1}$ quasi set topological vector subspaces associated with V .*

This is an advantage over the usual topological vector subspaces. This using set theoretic methods in usual algebraic structures happens to be an added advantage to the existing structures.

Also we can have many quasi set subtopological vector subspaces for this V .

Thus such study initiated by the authors pave way for several substructures and the very “set structures”.

Also while using infinite dimensional vector spaces and vector spaces of infinite cardinality; we see the following.

Example 4.21: Let $V = Q \times Q$ be a vector space over the field Q . The vector subspaces of V are $Q \times \{0\}$ and $\{0\} \times Q$. Thus the topological vector subspace of V over Q is of cardinality four and it is a Boolean algebra of order four.

However if we take any set of finite order say $\{0, 1\}$ or $\{0, -1\}$, $\{0, a\}$ or $\{0, a, -a\}$ or so on we get infinite number of quasi set topological vector subspaces and the order of their corresponding lattices represented by them in most cases is of infinite order.

This is again an advantage of using quasi set topologies of vector spaces. We can get several quasi set topologies in this case infinite number where as in case of the topologies constructed using only vector subspaces of a vector space we

get only one topological space. Thus this study has lots of applications as well of flexibility in using these notions.

Example 4.22: Let $V = \{Z_{14}\}$ be a vector space defined over the field $F = \{0, 2, 4, 6, 8, 10, 12\}$. $\{0\}$ and V are the only vector subspaces. So the topological vector subspaces gives a discrete topology with two elements.

On the other hand if we take the quasi set topological vector subspaces we have ${}_{7}C_2 + {}_{7}C_3 + {}_{7}C_4 + {}_{7}C_5 + {}_{7}C_6 = 119$ quasi set topological vector subspaces over subsets of F apart from the discrete topology.

We just give one or two examples of them.

Take $P_1 = \{0, 2\} \subseteq F$ and $T_1 = \langle \{\{0, 1, 2, 4, 8\} = v_1, \{0, 3, 6, 12, 10\} = v_2, \{0, 5, 10, 6, 12\} = v_3, \{0, 7\} = v_4, \{0, 9, 4, 8, 2\} = v_5, \{0, 11, 8, 2, 4\} = v_6, v_7 = \{0, 13, 12, 10, 6\}\} \rangle$ (T is generated by these basic elements or B_{T_1}). Order of T_1 is 2^7 .

It is also important to mention these 119 topologies include only all quasi set topological vector subspaces and quasi subset subtopological vector subspaces and not the quasi set subtopological vector subspaces.

For it is clear the space T_1 alone has quasi set subtopological vector subspaces given by $S_1 = \{(0), (0,1, 2, 4, 8)\} \subseteq T_1, S_2 = \{(0), (0, 3, 6, 12, 10)\} S_3 = \{(0), v_3\}, \dots, S_7 = \{(0, v_7)\}, S_8 = \{(0), v_1, v_2, v_1 \cup v_2\}, \dots, S_{29} = \{07, v_6, v_7, v_6 \cup v_7\}, S_{30} = \{(0, v_1, v_2, v_3, v_1 \cup v_2, v_1 \cup v_3, v_2 \cup v_3, v_1 \cup v_2 \cup v_3)\}$ and so on.

All these quasi set subtopological vector subspaces are not included in the collection of $119 + 1$ spaces. These are only the quasi set subtopological vector subspaces associated with T_1 .

Thus with each quasi set topological vector subspace we can built several quasi set subtopological vector subspaces. Here we leave the problem as an open problem.

Problem 4.3: Let $V = \{Z_n\}$ be a vector space defined over the field $F = \{0, 1, 2, \dots, p-1\}$ where $n = 2p$, p a prime.

- (i) How many quasi set topological vector subspaces can be built using $V = \{Z_n\}$ where $n = 2p$ over F ?
- (ii) Find the total number of quasi set subtopological vector subspaces of the quasi set topological vector subspaces mentioned in (i).
- (iii) If $n = p_1 p_2 \dots p_t$; where each p_i is a distinct prime; $V = \{Z_n\}$ a vector space over the field $F_i = \{0, 1, 2, \dots, p_i-1\}$; ($1 \leq i \leq t$).
 - (1) How many quasi set topological vector subspaces of V over F_i exist; $1 \leq i \leq t$?
 - (2) If V be a vector space of dimension n over a field Z_p (p a fixed prime);
 - (i) Find the number of quasi set topological vector subspaces over Z_p .
 - (ii) Find the total number of quasi set subtopological vector subspaces constructed using V .
 - (iii) Characterize those pseudo simple quasi set topological vector subspaces.
 - (iv) Does there exists super simple quasi set topological vector subspaces?
 - (3) Let V be a vector space of dimension n over the field of rationals Q .

Study the questions (i) to (iv); if Q is replaced by R that is V is a n dimensional vector space over R study questions (i) to (iv).

Are those quasi set topological vector subspaces mentioned in (3) and (2) second countable?

Now we have established that defining quasi set topological vector subspaces beyond doubt yields several quasi set topological vector subspaces and can be utilized appropriately for any given vector space V defined over the field F .

Further we can have quasi set topological vector subspaces using complex numbers and finite complex modulo integers.

We will only illustrate these situations by some examples.

Example 4.23: Let $V = C(Z_5) \times C(Z_5)$ be a complex modulo integer vector space over the field $F = Z_5$.

Let $P = \{0, 1\} \subseteq Z_5$ be a proper subset of F . We see if $T = \{\text{Collection of all quasi set vector subspaces of } V \text{ over } F\}$ then T is a quasi set topological vector subspace of V over Z_5 . The basic set associated with T is $B_T = \{(0, 0), (1, 0)\}, \{(0, 0), (0, 1)\}, \{(0, 0), (i_F, 0)\} \dots \{(0, 0), (4, 4i_F)\}$.

$$o(B_T) = o(V) - 1.$$

We see this complex modulo integer quasi set topological vector subspace contains the quasi set subtopological vector subspace which contains only the real part of $C(Z_5)$ that is the quasi set topological vector subspace constructed using Z_5 .

We will also see this is impossible if $P = \{0, 1\}$ is replaced by $P_1 = \{0, i_F\}$. Suppose $T_1 = \{\text{collection of all quasi set vector subspaces of } V \text{ over } P_1\}$ that is T_1 is a complex modulo integer quasi set topological vector subspace of V over the set P_1 .

The basic set of T_1 is

$$B_{T_1} = \{(0, 0), (1, 0), (i_F, 0), (4, 0), (4i_F, 0)\}, \{(0, 0), (0, 1), (0, i_F), (0, 4), (0, 4i_F)\}, \{(0, 0), (1, 1), (i_F, i_F), (4, 4), (4i_F, 4i_F)\}, \{(0, 0), (0, 2), (0, 2i_F), (0, 3), (0, 3i_F)\} \text{ and so on}.$$

Clearly T_1 cannot have a quasi set subtopological vector subspace which is real.

That is if the set P has complex modulo integer then the associated quasi set topological vector subspaces cannot have quasi set subtopological vector subspaces which is real.

Example 4.24: Let $V = \{C(Z_7)\}$ be a vector space over Z_7 . Let $P = \{0, 1, 6\} \subseteq Z_7$. T be the collection of all quasi set vector subspaces of V over P .

T is complex modulo integer quasi set topological vector subspace of V over P . T has both real and complex modulo integer quasi set subtopological vector subspaces defined over P .

Further T is not pseudo simple for T has three real quasi subset subtopological vector subspaces defined over $P_i \subseteq P$, $i = 1, 2, 3$; where $P_2 = \{0, 1\}$, $P_1 = \{0, 2\}$ and $P_3 = \{1, 6\}$.

The basic set of T_1 given by $B_{T_1} = \{\{0, 1, 6\} = v_1, \{0, 2, 5\} = v_2, \{0, 3, 4\} = v_3\}$ where T_1 is a quasi set topological vector subspace of V over $P_1 = \{0, 6\}$.

The lattice associated with T_1 is

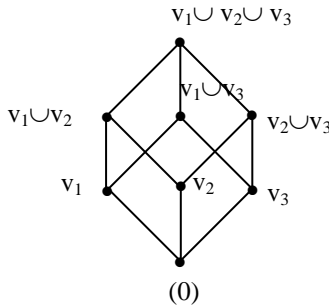

T_1 is a Boolean algebra of order 8.

Let $P_2 = \{0, 1\} \subseteq P$,
 $T_2 = \{\text{Collection of all quasi set vector subspaces of } V \text{ over } P_2\}$;
 be the quasi set topological vector subspace of V over P_2 . The
 basic set B_{T_2} associated with
 $T_2 = \{\{0, 1\}, \{0, 2\}, \{0, 3\}, \{0, 4\}, \{0, 5\}, \{0, 6\}\}$. The
 Boolean algebra generated by B_{T_2} is of order 2^6 .

Let T_3 be the collection of all quasi set vector subspaces of
 V over $P_3 = \{1, 6\}$. T_3 is a quasi set topological vector subspace
 of V over the set P_3 .

The basic set $B_{T_3} = \{\{0\}, \{1, 6\}, \{2, 5\}, \{3, 4\}\}$ and $o(B_{T_3}) = 4$
 and T_3 is a quasi set real topological vector subspace of order 2^4 .

The lattice Boolean algebra associated with T_3 is of order
 2^4 . Now we study the complex modulo integer quasi set
 topological vector subspaces of V .

Take $P_1 = \{0, 1\}$; the collection all complex modulo integer
 quasi set vector subspaces of V defined over P_1 be denoted by
 T_1 .

T_1 is a complex modulo integer quasi set topological vector
 subspace of V defined over the set $P_1 = \{0, 1\} \subseteq Z_7 = F$. The
 basic set of T_1 be $B_{T_1} = \{\{0, 1\}, \{0, 2\}, \dots, \{0, 6\}, \{0, i_F\}, \dots,$
 $\{0, 6i_F\}, \{0, 1+i_F\}, \dots, \{0, 6+i_F\}, \dots, \{0, 6+6i_F\}$.

Clearly $o(B_{T_1}) = o(V) - 1$.

T_1 is pseudo simple but not simple. T_1 has several quasi set
 subtopological vector subspaces.

Take $P_2 = \{0, 6\} \subseteq F$; let T_2 be the collection of all quasi set
 complex modulo integer vector subspaces of V defined over the
 set P_2 . T_2 is a complex modulo integer quasi set topological
 vector subspace of V defined over the set P_2 .

The basic set of T_2 is given by $B_{T_2} = \{\{0, 1, 6\}, \{0, 2, 5\}, \{0, 3, 4\}, \{0, i_F, 6i_F\}, \{0, 2i_F, 5i_F\}, \{0, 3i_F, 4i_F\}, \{0, 1+i_F, 6+6i_F\}, \{0, 1+2i_F, 6+5i_F\}, \dots, \{0, 4+3i_F, 3+4i_F\}\}$.

T_2 is pseudo simple but is not simple for T_2 has several real and complex modulo integer quasi set subtopological vector subspaces of V defined over the set P_2 .

$P_3 = \{1, 6\} \subseteq F = Z_7$. Let $T_3 = \{\text{Collection of all quasi set vector subspaces of } V \text{ defined over } P_3\}$ be the complex modulo integer quasi set vector subspace of V defined over the set P_3 . The basic set B_{T_3} of T_3 is $\{\{0\}, \{1, 6\}, \{2, 5\}, \{3, 4\}, \dots, \{3 + 3i_F, 4+4i_F\}, \dots, \{5+6i_F, i_F+2\}\}$. We see T_3 is also pseudo simple but has several complex modulo integer (real) quasi set topological vector subspaces of V defined over the set P_3 .

Take $P_4 = \{0, 1, 2, i_F, 4i_F\} \subseteq F = Z_7$. Let $T_4 = \{\text{Collection of all quasi set vector subspace of } V \text{ over the set } P_4\}$, be the complex modulo integer set vector subspace of V over P_4 . Let B_{T_4} be the basic set of T_4 . $B_{T_4} = \{\{0, 1, 2, i_F, 4, 4i_F, 3, 3i_F, 6, 2i_F, 5i_F, 6i_F, 5\}, \{0, 1+i_F, 2+2i_F, 4+4i_F, i_F+6, 2i_F+5, 4i_F+3, 5+5i_F, 3+3i_F, 6+6i_F, 5i_F+2, 4+3i_F, 6i_F+1\}, \{0, 1+2i_F, 2+4i_F, i_F+5, 4i_F+6, 6i_F+3, 6+5i_F, 3+2i_F, 3i_F+5, 4+5i_F, 3i_F+1, i_F+4, 2+6i_F\}, \{0, 2+i_F, 2i_F+6, 4+2i_F, i_F+3, 3i_F+6, 6i_F+4, 4i_F+5, 5i_F+3, 3i_F+2, 1+4i_F, 6i_F+5, 1+5i_F\}\}$.

$= (v_1, v_2, v_3, v_4)$ and $o(B_{T_4}) = 4$ we see $o(T_4) = 2^4$. Thus the lattice associated with T_4 is a Boolean algebra of order 16.

Example 4.25: Let $V = C(Z_{11})$ be a vector space defined over the field Z_{11} . Let $P = \{0, 10, 5, 2\} \subseteq Z_{11}$. Let $T = \{\text{Collection of all quasi set vector subspaces of } V \text{ defined over the set } P\}$ be the quasi set topological vector subspace of V defined over the set P .

The basic set of T is $B_T = \{\{0, 1, 10, 9, 2, 5, 4, 8, 7, 3, 6\}, \{0, i_F, 2, 3i_F, 4i_F, 5i_F, 6i_F, 7i_F, 8i_F, 9i_F, 10i_F\}, \{0, 1+i_F, 2+2i_F,$

$3+3i_F, \dots, 9+9i_F, 10+10i_F\}, \{0, 1+2i_F, 2+4i_F, 4+8i_F, 8+5i_F,$
 $5+10i_F, 10+9i_F, 9+7i_F, 7+3i_F, 3+6i_F, 6+i_F\} \{0, 2+i_F, 4+2i_F, 8+4i_F,$
 $5+8i_F, 10+5i_F, 9+10i_F, 7+9i_F, 3+7i_F, 6+3i_F, 1+6i_F\}, \{0, 1+3i_F,$
 $2+6i_F, 4+i_F, 8+2i_F, 5+4i_F, 10+8i_F, 9+5i_F, 7+10i_F, 3+9i_F, 6+7i_F\}$
 $\{0, 3+i_F, 6+2i_F, 1+4i_F, 2+8i_F, 4+5i_F, 8+10i_F, 5+9i_F, 10+7i_F,$
 $9+3i_F, 7+6i_F\}, \{0, 1+5i_F, 2+10i_F, 4+9i_F, 8+7i_F, 5+3i_F, 10+6i_F,$
 $9+i_F, 7+2i_F, 3+4i_F, 6+8i_F\}, \{0, 5+i_F, 10+2i_F, 9+4i_F, 7+8i_F, 3+5i_F,$
 $6+10i_F, 1+9i_F, 2+7i_F, 4+3i_F, 8+6i_F\}, \{0, 1+7i_F, 2+3i_F, 4+6i_F,$
 $8+i_F, 5+2i_F, 10+4i_F, 9+8i_F, 7+5i_F, 3+10i_F, 6+9i_F\}, \{0, 7+i_F,$
 $3+2i_F, 6+4i_F, 1+8i_F, 2+5i_F, 4+10i_F, 8+9i_F, 5+7i_F, 10+3i_F, 9+6i_F\},$
 $\{0, 1+10i_F, 2+9i_F, 4+7i_F, 8+3i_F, 5+6i_F, 10+i_F, 9+2i_F, 7+4i_F,$
 $3+8i_F, 6+5i_F\}\}.$

Clearly $o(B_T) = 12 = (11^2 - 1) / 10$.

The lattice associated with T is a Boolean algebra of order 2^{12} . Take $P_1 = \{0, 3, 6\} \subseteq Z_{11}$. Let $T_1 = \{\text{Collection of all quasi set vector subspaces of } V \text{ over the set } P_1\}$ be the quasi set topological vector subspace of V over the set P_1 . Let B_{T_1} be the basic set of T_1 associated with P_1 .

$B_{T_1} = \{\{0, 1, 3, 9, 6, 2, 7, 5, 4, 10, 8\}, \{0, i_F, 2i_F, 3i_F, 4i_F, 5i_F,$
 $6i_F, 7i_F, 8i_F, 9i_F, 10i_F\}, \dots, \{0, 1+10i_F, 3+8i_F, 9+2i_F, 5+6i_F, 4+7i_F,$
 $2+9i_F, 6+5i_F, 7+4i_F, 10+i_F\}\}.$

Thus we see for the two different sets $P = \{0, 2, 5, 10\}$ and $P_1 = \{0, 3, 6\}$ the quasi set topological vector subspaces T and T_1 are identical or one and the same.

Let us take $P_2 = \{0, 4, 7\} \subseteq Z_{11}$. The collection of quasi set vector subspaces of V over the set P_3 be denoted by T_2 . T_2 is a quasi set topological vector subspace of V over the set P_3 . Let B_{T_2} denote the basic set of T_2 . $B_{T_2} = \{\{0, 1, 4, 5, 9, 3, 7, 6, 2,$
 $8, 10\}, \{0, i_F, 2i_F, 3i_F, \dots, 10i_F\}, \dots, \{1+10i_F, 0, 10+i_F, 2+9i_F,$
 $9+2i_F, 7+4i_F, 7i_F+4, 6+5i_F, 5+6i_F, 3+8i_F, 8+3i_F\}\}.$ We see $o(B_{T_2}) = 12$.

We see the quasi set topological vector subspace T_2 of V over P_2 ; T_2 is also the identical quasi set topological vector subspaces of V viz. T_1 and T . Thus for sets $P = \{0, 2, 5, 10\}$, $P_1 = \{0, 3, 6\}$ and $P_2 = \{0, 4, 7\}$ the quasi set topological vector subspaces are identical with T that is T, T_1 and T_2 are the same.

Suppose we take $P_3 = \{0, 1, 10\} \subseteq Z_{11}$.

Let $T_3 = \{\text{Collection of all quasi set vector subspace of } V \text{ over the set } P_3\}$ be the quasi set topological vector subspace of V over the set P_3 . The basic set of T_3 be $B_{T_3} = \{\{0, 1, 10\}, \{0, 2, 9\}, \{0, 3, 8\}, \{0, 4, 7\}, \{0, 5, 6\}\}, \{\{0, i_F, 10i_F\}, \{0, 2i_F, 9i_F\}, \{0, 3i_F, 8i_F\}, \{0, 4i_F, 7i_F\}, \{0, 5i_F, 6i_F\}, \{0, 1+i_F, 10+10i_F\}, \{0, 2+2i_F, 9+9i_F\}, \dots, \{0, 10+9i_F, 1+2i_F\}\}$.

We see $o(B_{T_3}) = 60 = (11^2 - 1) / 2$. However T_3 is a different quasi set topological vector subspace from T, T_1 and T_2 .

Let $P_4 = \{0, 2, 9\} \subseteq Z_{11}$, $T_4 = \{\text{Collection of quasi set vector subspaces of } V \text{ over the set } P_4\}$ be the quasi set topological vector subspace of V over P_4 .

Let B_{T_4} denote the basic set of T_4 , $B_{T_4} = \{\{0, 1, 2, 9, 4, 8, 7, 3, 6, 5, 10\}, \{0, i_F, \dots, 10i_F\}, \dots, \{0, 1+10i_F, 2+9i_F, 4+7i_F, 8+3i_F, 5+6i_F, 10+i_F, 9+2i_F, 7+4i_F, 5+6i_F, 3+8i_F\}\}$.

We see T, T_1, T_2 and T_4 are identical quasi set topological vector subspaces. However T_3 is the different from T, T_1, T_2 and T_4 .

Example 4.26: Let $V = C(Z_7) \times C(Z_7)$ be a vector space defined over the complex modulo integer field $C(Z_7)$. Let $P_1 = \{0, 1, i_F\} \subseteq C(Z_7)$ and $T_1 = \{\text{Collection of all quasi set vector subspaces of } V \text{ over the set } P_1\}$ be the quasi set topological vector subspace of V over P_1 .

Let B_{T_1} be the basic set associated with T_1 . $B_{T_1} = \{(0, 0), (1, 1), (i_F, i_F), (6, 6), (6i_F, 6i_F)\}, \{(0, 0), (2, 2), (2i_F, 2i_F), (5, 5), (5i_F, 5i_F)\}, \{(0, 0), (3, 3), (3i_F, 3i_F), (4, 4), (4i_F, 4i_F)\}, \{(0, 0), (0, 1), (0, i_F), (0, 6), (0, 6i_F)\}, \dots, \{(0, 0), (2+3i_F, 6+5i_F), (2i_F+4, 6i_F+2), (4i_F+5, 2i_F+1), (5i_F+3, i_F+5)\}$.

We see $o(B_{T_1}) = 600 = (7^4 - 1) / 4$. Let $P_2 = \{0, 1, 6, i_F, 6i_F\} \subseteq C(Z_7)$. $T_2 = \{\text{Collection of all quasi set vector subspaces of } V \text{ over the set } P_2\}$ be the quasi set topological vector subspace of V over the set P_2 .

Suppose B_{T_2} be the basic set of T_2 then $B_{T_2} = \{(0, 0), (1, 0), (6, 0), (i_F, 0), (6i_F, 0)\}, \{(0, 0), (1, 1), (6, 6), (i_F, i_F), (6i_F, 6i_F)\}, \dots, \{(0, 0), (2+3i_F, 6+5i_F), (2i_F+4, 6i_F+2), (4i_F+5, 2i_F+1), (5i_F+3, i_F+5)\}$. $o(B_{T_2}) = 600 = 7^4 - 1 / 4$.

We see T_1 and T_2 are identical. Let $P_3 = \{0, 1\} \subseteq C(Z_7)$ be a set and $T_3 = \{\text{Collection of all quasi set vector subspaces of } V \text{ over } P_3\}$ be the quasi set topological vector subspaces of V over the set P_3 .

$B_{T_3} = \{(0, 0), (1, 0)\}, \{(0, 0), (i_F, 0)\}, \dots, \{(0, 0), (5+6i_F, 0)\}$ is the basic set associated with T_3 .

$$o(B_{T_3}) = 2401 - 1 = o(V) - 1 = 2400.$$

T_3 is different from T_1 and T_2 . Let $P_4 = \{0, i_F, 2+3i_F\} \subseteq C(Z_7)$. $T_4 = \{\text{Collection of all quasi set vector subspaces of } V \text{ over the set } P_4\}$ be the quasi set topological vector subspace of V defined over the set P_4 . The basic set of T_4 be B_{T_4} ;

$B_{T_4} = \{(0, 0), (1, 1), (3, 3), (2, 2), (4, 4), (2i_F, 2i_F), (i_F, i_F), (4i_F, 4i_F), (3i_F, 3i_F), (6i_F, 6i_F), (5, 5), (5i_F, 5i_F), (6, 6)\}, \{(0, 0), (1, 0), (2, 0), (i_F, 0), (3i_F, 0), (6, 0), (2i_F, 0), (4, 0), (6i_F, 0), (3, 0), (5, 0), (5i_F, 0), (4i_F, 0)\}, \dots, \{(0, 0), (3 + 5i_F, 6 + 4i_F), (6 + 3i_F, 5 + i_F), (3i_F + 2, 6i_F + 3), (6i_F + 4, 5i_F + 6), (2i_F + 6, 4i_F + 2), (4i_F +$

$5, i_F + 4), (i_F + 3, 2i_F + 1), (4 + 2i_F, 1 + 3i_F), (1 + 4i_F, 2 + 6i_F), (5i_F + 1, 3i_F + 5), (2 + i_F, 4 + 5i_F), (2i_F + 3, 2i_F + 1)\}$.

Clearly $o(B_{T_4}) = 200 = (2401 - 1)/12$. Clearly T_4 is different from T_1, T_2 and T_3 .

Next we proceed on to describe how set vector spaces are defined and the use of them in the construction of New Set Topological vector subspaces. For more refer [14, 17].

DEFINITION 4.2: Let V be a set and S another set we say V is a set vector space defined over the set S if for all $v \in V$ and $s \in S$ vs and $sv \in V$.

We give one to two examples of them.

Example 4.27: Let

$$V = \{Z_7 \times Z_7, \begin{bmatrix} a & b \\ c & d \end{bmatrix} \mid a, b, c, d \in Z_7\}$$

be a set vector space over the set $S = \{0, 1, 2, 4\} \subseteq Z_7$.

Example 4.28: Let

$$V = \left\{ \begin{bmatrix} a_1 \\ a_2 \\ a_3 \\ a_4 \end{bmatrix}, \begin{bmatrix} b_1 & b_2 & \dots & b_7 \\ b_8 & b_9 & \dots & b_{14} \end{bmatrix}, Z_{12} \times Z_{12} \times Z_{12} \mid a_i, b_j \in Z_{12}; \right. \\ \left. 1 \leq i \leq 4, 1 \leq j \leq 14 \right\}$$

be a set vector space over the set $S = \{0, 1, 6, 7, 11\} \subseteq Z_{12}$.

Example 4.29: Let

$$V = \left\{ 2Z_{46} \times 23Z_{46}, \left[\begin{array}{cc} a_1 & a_2 \\ \vdots & \vdots \\ a_7 & a_8 \end{array} \right], \left[\begin{array}{ccc} a_1 & a_2 & a_3 \\ a_4 & a_5 & a_6 \\ a_7 & a_8 & a_9 \end{array} \right] \right\}$$

$$a_i \in Z_{46}, 1 \leq i \leq 9\}$$

be a set vector space over the set $S = \{1, 0, 23, 41\} \subseteq Z_{46}$.

Example 4.30: Let

$$V = \left\{ Z \times Z, \left[\begin{array}{c} a_1 \\ a_2 \\ \vdots \\ a_{11} \end{array} \right], \left[\begin{array}{cccccc} a_1 & a_2 & a_3 & \dots & a_{10} \\ a_{11} & a_{12} & a_{13} & \dots & a_{20} \\ a_{21} & a_{22} & a_{23} & \dots & a_{30} \end{array} \right] \right\} \left| a_i \in Z; 1 \leq i \leq 30 \right\}$$

be a set vector space defined over the set $S = 3Z^+ \cup 5Z \cup 17Z^+$.

Example 4.31: Let

$$V = \left\{ R \times R \times R \times R, \left(\begin{array}{cccc} a_1 & a_2 & \dots & a_7 \\ a_8 & a_9 & \dots & a_{14} \end{array} \right) \right\} \left| a_i \in R; 1 \leq i \leq 14 \right\}$$

be a set vector space over the set $S = 3Z^+ \cup 7Z \cup 19Z^+$.

We can have several such set vector spaces for more about these concepts please refer [set lin. Alg.].

Now we just indicate how this notion has been used in the construction of New Set Topological vector subspaces (NS-topological vector subspaces). For information about these refer [14].

However we give some examples so that the reader can realize how this can increase the types of set topologies; further

the sets of this topological space need has always enjoy the common form or structure. We see even the set vector spaces all the elements do not enjoy the same proper type of properties.

We see if V is a set vector space whose elements of row matrices, column matrices and matrices of order say $(m \times n)$ all these three types of matrices together will form a set vector space but however no interrelation may exists between all pairs. This is the marked difference between the usual vector spaces and the set vector spaces.

Similar difference exists between the topological spaces built on sets and NS-topological vector subspaces.

These claims would be easily understood from the following examples.

Example 4.32: Let

$$V = \left\{ Z_{10} \times Z_{10}, \begin{bmatrix} a_1 \\ a_2 \\ a_3 \\ a_4 \end{bmatrix}, \begin{pmatrix} a_1 & a_2 \\ a_3 & a_4 \end{pmatrix} \right\} \left| a_i \in Z_{10}; 1 \leq i \leq 4 \right.$$

be a set vector space defined over the set $S = \{0, 2, 1, 3\} \subseteq Z_{10}$. Let $P_1 = \{0, 3\} \subseteq Z_{10}$. $T_1 = \{\text{Collection of all set vector subspaces of } V \text{ defined over the set } P_1\}$ be the NS-topological vector subspace of V defined over P_1 .

The basic set of T_1 is

$$B_{T_1} = \{ \{(0, 0), (1, 0), (3, 0), (9, 0), (7, 0)\}, \{(0, 0), (0, 1), (0, 3), (0, 9), (0, 7)\}, \{(0, 0), (2, 0), (6, 0), (8, 0), (4, 0)\}, \{(0, 0), (0, 2), (0, 6), (0, 8), (0, 4)\}, \{(0, 0), (5, 0)\}, \{(0, 0), (0, 5)\}, \{(0, 0), (5, 5)\}, \{(0, 0), (1, 1), (3, 3), (9, 9), (7, 7)\}, \{(0, 0), (2, 2), (6, 6), (8, 8), (4, 4)\}, \{(0, 0), (1, 2), (3, 6), (9, 8), (7, 4)\}, \{(0, 0), (2, 1), (8, 9), (4, 7)\}, \dots, \{(0, 0), (8, 1), (4, 3), (2, 9), (6, 7)\} \}$$

$$\left\{ \begin{bmatrix} 0 \\ 0 \\ 0 \\ 0 \end{bmatrix}, \begin{bmatrix} 1 \\ 0 \\ 0 \\ 0 \end{bmatrix}, \begin{bmatrix} 3 \\ 0 \\ 0 \\ 0 \end{bmatrix}, \begin{bmatrix} 9 \\ 0 \\ 0 \\ 0 \end{bmatrix}, \begin{bmatrix} 7 \\ 0 \\ 0 \\ 0 \end{bmatrix} \right\}, \dots, \left\{ \begin{bmatrix} 0 \\ 0 \\ 0 \\ 0 \end{bmatrix}, \begin{bmatrix} 1 \\ 2 \\ 5 \\ 7 \end{bmatrix}, \begin{bmatrix} 3 \\ 6 \\ 5 \\ 1 \end{bmatrix}, \begin{bmatrix} 9 \\ 8 \\ 5 \\ 3 \end{bmatrix}, \begin{bmatrix} 7 \\ 4 \\ 5 \\ 9 \end{bmatrix} \right\},$$

$$\left\{ \begin{pmatrix} 0 & 0 \\ 0 & 0 \end{pmatrix}, \begin{pmatrix} 1 & 0 \\ 0 & 0 \end{pmatrix}, \begin{pmatrix} 3 & 0 \\ 0 & 0 \end{pmatrix}, \begin{pmatrix} 9 & 0 \\ 0 & 0 \end{pmatrix}, \begin{pmatrix} 7 & 0 \\ 0 & 0 \end{pmatrix} \right\}, \dots,$$

$$\left\{ \begin{pmatrix} 0 & 0 \\ 0 & 0 \end{pmatrix}, \begin{pmatrix} 6 & 7 \\ 8 & 4 \end{pmatrix}, \begin{pmatrix} 8 & 1 \\ 4 & 2 \end{pmatrix}, \begin{pmatrix} 4 & 3 \\ 2 & 6 \end{pmatrix}, \begin{pmatrix} 2 & 9 \\ 6 & 8 \end{pmatrix} \right\}.$$

Thus is a basic set and all these elements in B_{T_1} forms the generating set of T_1 . They are such that in some cases intersection is empty in some cases intersection is

$$(0, 0) \text{ or } \begin{bmatrix} 0 \\ 0 \\ 0 \\ 0 \end{bmatrix} \text{ or } \begin{bmatrix} 0 & 0 \\ 0 & 0 \end{bmatrix}.$$

Suppose $B_{T_1} = \{ B_{T_1}^1, B_{T_1}^2, B_{T_1}^3 \}$ where

$B_{T_1}^1 = \{ \{(0, 0), (1, 0), (3, 0), (9, 0), (7, 0)\}, \{(0, 0), (0, 1), (0, 3), (0, 9), (0, 7)\}, \{(0, 0), (1, 1), (3, 3), (9, 9), (7, 7)\}, \{(0, 0), (2, 0), (6, 0), (8, 0), (4, 0)\}, \{(0, 0), (0, 2), (0, 6), (0, 8), (0, 4)\}, \{(0, 0), (2, 2), (6, 6), (8, 8), (4, 4)\}, \{(0, 0), (1, 2), (3, 6), (9, 8), (7, 4)\}, \{(0, 0), (2, 1), (6, 3), (8, 9), (4, 7)\}, \{(0, 0), (2, 1), (3, 9), (9, 7), (7, 1)\}, \{(0, 0), (3, 1), (9, 3), (7, 9), (1, 7)\}, \{(0, 0), (1, 4), (3, 2), (9, 6), (7, 8)\}, \{(0, 0), (4, 1), (2, 3), (6, 9), (8, 7)\}, \{(0, 0), (1, 5), (3, 5), (9, 5), (7, 5)\}, \{(0, 0), (5, 1), (5, 3), (5, 9), (5, 7)\}, \{(0, 0), (1, 6), (3, 8), (9, 4), (7, 2)\}, \{(0, 0), (6, 1), (8, 3), (4, 9), (2, 7)\}, \{(0, 0), (1, 8), (3, 4), (9, 2), (7, 6)\}, \{(0, 0), (8, 1), (4, 3), (2, 9), (6, 7)\}, \{(0, 0), (1, 9), (3, 7), (9, 1), (7, 3)\}, \{(0, 0), (0, 5)\}, \{(0, 0), (5, 0)\}, \{(0, 0), (5, 5)\}, \dots \}.$

Clearly $o(B_{T_1}^1) = 27$

We see the lattice associated with T_1 is a Boolean algebra of order 2^{27} .

The least element is $\{(0, 0)\}$ and the largest element is $Z_{10} \times Z_{10}$.

Let $B_{T_1}^2$ denote basic set associated with the set

$$\left\{ \begin{bmatrix} a \\ b \\ c \\ d \end{bmatrix} \mid a, b, c, d \in Z_{10} \right\}$$

set vector subspaces over the set $P_1 = \{0, 3\}$.

$$B_{T_1}^2 = \left\{ \left\{ \begin{bmatrix} 0 \\ 0 \\ 0 \\ 0 \end{bmatrix}, \begin{bmatrix} 1 \\ 0 \\ 0 \\ 0 \end{bmatrix}, \begin{bmatrix} 3 \\ 0 \\ 0 \\ 0 \end{bmatrix}, \begin{bmatrix} 9 \\ 0 \\ 0 \\ 0 \end{bmatrix}, \begin{bmatrix} 7 \\ 0 \\ 0 \\ 0 \end{bmatrix} \right\}, \dots, \left\{ \begin{bmatrix} 8 \\ 9 \\ 5 \\ 7 \end{bmatrix}, \begin{bmatrix} 0 \\ 0 \\ 0 \\ 0 \end{bmatrix}, \begin{bmatrix} 4 \\ 7 \\ 5 \\ 1 \end{bmatrix}, \begin{bmatrix} 2 \\ 1 \\ 5 \\ 3 \end{bmatrix}, \begin{bmatrix} 6 \\ 3 \\ 5 \\ 9 \end{bmatrix} \right\} \right\}$$

We see $B_{T_1}^2$ is also a Boolean algebra with $\left\{ \begin{bmatrix} 0 \\ 0 \\ 0 \\ 0 \end{bmatrix} \right\}$ as the

least element and $\left\{ \begin{bmatrix} a \\ b \\ c \\ d \end{bmatrix} \mid a, b, c, d \in Z_{10} \right\}$ as the greatest

element.

Now consider the set vector space

$$\left\{ \begin{pmatrix} a_1 & a_2 \\ a_3 & a_4 \end{pmatrix} \middle| a_i \in \mathbb{Z}_{10}, 1 \leq i \leq 4 \right\} \text{ over the set } P_1 = \{0, 3\}.$$

Let $B_{T_1}^3$ be the basic set associated with this NS-topological vector subspace. The elements from the set vector subspace are

$$\left\{ \begin{pmatrix} a & b \\ c & d \end{pmatrix} \middle| a, b, c, d \in \mathbb{Z}_{10} \right\} \text{ over the set } P_1 = \{0, 3\}.$$

$$B_{T_1}^3 = \left\{ \begin{pmatrix} 0 & 0 \\ 0 & 0 \end{pmatrix}, \begin{pmatrix} 1 & 0 \\ 0 & 0 \end{pmatrix}, \begin{pmatrix} 3 & 0 \\ 0 & 0 \end{pmatrix}, \begin{pmatrix} 9 & 0 \\ 0 & 0 \end{pmatrix}, \begin{pmatrix} 7 & 0 \\ 0 & 0 \end{pmatrix} \right\},$$

$$\left\{ \begin{pmatrix} 0 & 0 \\ 0 & 0 \end{pmatrix}, \begin{pmatrix} 0 & 1 \\ 0 & 0 \end{pmatrix}, \begin{pmatrix} 0 & 3 \\ 0 & 0 \end{pmatrix}, \begin{pmatrix} 0 & 9 \\ 0 & 0 \end{pmatrix}, \begin{pmatrix} 0 & 7 \\ 0 & 0 \end{pmatrix} \right\}, \dots,$$

$$\left\{ \begin{pmatrix} 0 & 0 \\ 0 & 0 \end{pmatrix}, \begin{pmatrix} 8 & 7 \\ 4 & 3 \end{pmatrix}, \begin{pmatrix} 4 & 1 \\ 2 & 9 \end{pmatrix}, \begin{pmatrix} 2 & 3 \\ 6 & 7 \end{pmatrix}, \begin{pmatrix} 6 & 9 \\ 8 & 1 \end{pmatrix} \right\}$$

We see for this basic set of the NS-topological vector subspace; $\left\{ \begin{pmatrix} 0 & 0 \\ 0 & 0 \end{pmatrix} \right\}$ is the least element and

$$M = \left\{ \begin{pmatrix} a & b \\ c & d \end{pmatrix} \middle| a, b, c, d \in \mathbb{Z}_{10} \right\}$$

is the largest element.

Thus the lattice associated with $B_{T_1}^3$ is a Boolean algebra. However if we take the lattice L associated with $B_{T_1} = \{ B_{T_1}^1, B_{T_2}^2, B_{T_3}^3 \}$ we see the lattice L is not a Boolean algebra.

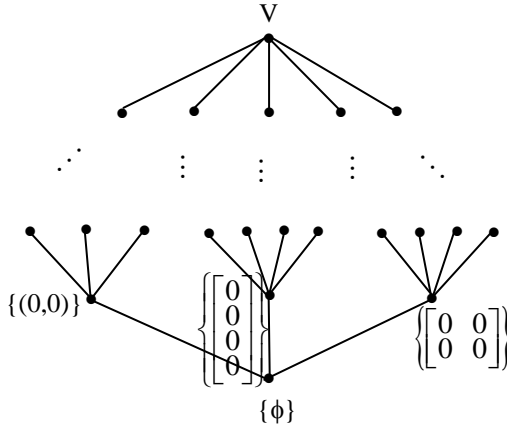

We see for this lattice we cannot define the atoms as atoms which cover the least element $\{\phi\}$ cannot generate the lattice.

Only if $\{(0, 0)\}, \left\{ \begin{bmatrix} 0 \\ 0 \\ 0 \\ 0 \end{bmatrix} \right\}, \left\{ \begin{bmatrix} 0 & 0 \\ 0 & 0 \end{bmatrix} \right\}$ are considered as

second layer atoms they generate the lattice. In view of this we define the following.

DEFINITION 4.3: Let L be a lattice. If L has $\{\phi\}$ to be the first layer and if the second layer which covers $\{\phi\}$ cannot generate the lattice say some a_1, \dots, a_n and if the next layer which cover a_1, \dots, a_n can generate the lattice L then we call the second layer as second layer atoms and the lattice is defined as the special second layered lattice.

We will illustrate this by some examples.

Example 4.33: Let L be the lattice given by the following Hasse diagram.

$\{\phi\}$ is the least element and V is the largest element.

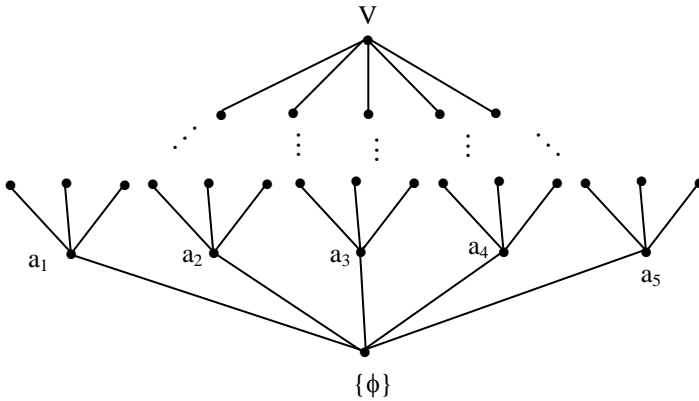

Example 4.34: Let L be the following lattice given by the Hasse diagram.

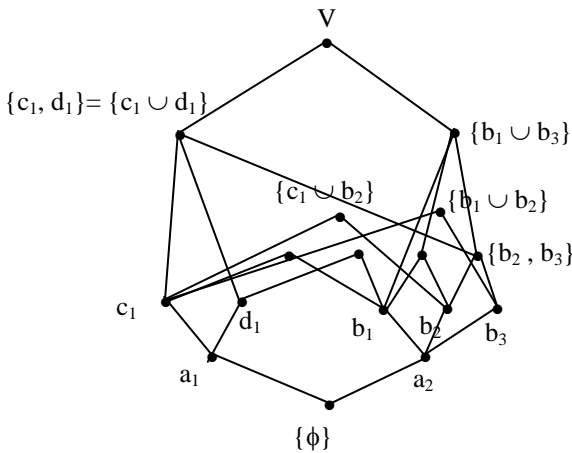

Example 4.35: Let L be the lattice given by the figure.

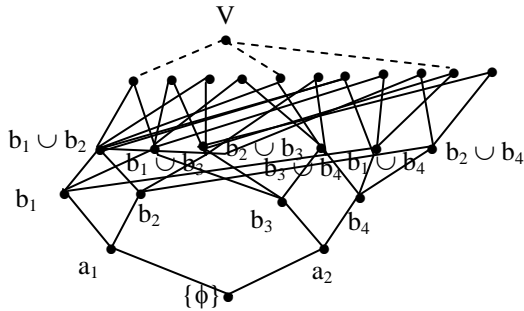

We can get NS topological spaces corresponding to this type of lattices.

We leave it as an open problem.

Problem 4.4: Can we find for every lattice L which is generated by second layer of atoms a corresponding NS-topological vector subspace T whose lattice is identical with L ?

Now we proceed onto give more examples of such lattices which are associated with NS-topological vector subspaces.

Example 4.36: Let

$$V = \{Z_3 \times Z_3, \begin{bmatrix} a \\ b \\ c \end{bmatrix} \mid a, b, c \in Z_3\}$$

be a set vector space defined over the set $S = \{0, 1, 2\}$. Let $T = \{\text{Collection of all subset vector subspaces of } V \text{ over the set } \{0, 2\} \subseteq S\}$ be the NS-topological vector subspace of V over the set S . The basic set of T is

$$B_T = \{v_1 = \{(0, 0), (1, 0), (2, 0)\}, v_2 = \{(0, 0), (0, 1), (0, 2)\}, v_3 = \{(0, 0), (1, 1), (2, 2)\}, \{(0, 0), (1, 2), (2, 1)\} = v_4,$$

$$\left\{ \begin{bmatrix} 0 \\ 0 \\ 0 \end{bmatrix}, \begin{bmatrix} 1 \\ 0 \\ 0 \end{bmatrix}, \begin{bmatrix} 2 \\ 0 \\ 0 \end{bmatrix} \right\} = v_5, \quad \left\{ \begin{bmatrix} 0 \\ 0 \\ 0 \end{bmatrix}, \begin{bmatrix} 0 \\ 1 \\ 0 \end{bmatrix}, \begin{bmatrix} 0 \\ 2 \\ 0 \end{bmatrix} \right\} = v_6,$$

$$\left\{ \begin{bmatrix} 0 \\ 0 \\ 0 \end{bmatrix}, \begin{bmatrix} 0 \\ 0 \\ 1 \end{bmatrix}, \begin{bmatrix} 0 \\ 0 \\ 2 \end{bmatrix} \right\} = v_7, \quad v_8 = \left\{ \begin{bmatrix} 0 \\ 0 \\ 0 \end{bmatrix}, \begin{bmatrix} 1 \\ 1 \\ 0 \end{bmatrix}, \begin{bmatrix} 2 \\ 2 \\ 0 \end{bmatrix} \right\},$$

$$v_9 = \left\{ \begin{bmatrix} 0 \\ 0 \\ 0 \end{bmatrix}, \begin{bmatrix} 0 \\ 1 \\ 1 \end{bmatrix}, \begin{bmatrix} 0 \\ 2 \\ 2 \end{bmatrix} \right\}, \quad v_{10} = \left\{ \begin{bmatrix} 0 \\ 0 \\ 0 \end{bmatrix}, \begin{bmatrix} 1 \\ 0 \\ 1 \end{bmatrix}, \begin{bmatrix} 2 \\ 0 \\ 2 \end{bmatrix} \right\},$$

$$v_{11} = \left\{ \begin{bmatrix} 0 \\ 0 \\ 0 \end{bmatrix}, \begin{bmatrix} 1 \\ 2 \\ 0 \end{bmatrix}, \begin{bmatrix} 2 \\ 1 \\ 0 \end{bmatrix} \right\}, \quad v_{12} = \left\{ \begin{bmatrix} 0 \\ 0 \\ 0 \end{bmatrix}, \begin{bmatrix} 1 \\ 0 \\ 2 \end{bmatrix}, \begin{bmatrix} 2 \\ 0 \\ 1 \end{bmatrix} \right\},$$

$$v_{13} = \left\{ \begin{bmatrix} 0 \\ 0 \\ 0 \end{bmatrix}, \begin{bmatrix} 0 \\ 1 \\ 2 \end{bmatrix}, \begin{bmatrix} 0 \\ 2 \\ 1 \end{bmatrix} \right\}, \quad v_{14} = \left\{ \begin{bmatrix} 0 \\ 0 \\ 0 \end{bmatrix}, \begin{bmatrix} 1 \\ 1 \\ 1 \end{bmatrix}, \begin{bmatrix} 2 \\ 2 \\ 2 \end{bmatrix} \right\},$$

$$v_{15} = \left\{ \begin{bmatrix} 0 \\ 0 \\ 0 \end{bmatrix}, \begin{bmatrix} 1 \\ 1 \\ 2 \end{bmatrix}, \begin{bmatrix} 2 \\ 2 \\ 1 \end{bmatrix} \right\}, \quad v_{16} = \left\{ \begin{bmatrix} 0 \\ 0 \\ 0 \end{bmatrix}, \begin{bmatrix} 1 \\ 2 \\ 1 \end{bmatrix}, \begin{bmatrix} 2 \\ 1 \\ 2 \end{bmatrix} \right\},$$

$$v_{17} = \left\{ \begin{bmatrix} 0 \\ 0 \\ 0 \end{bmatrix}, \begin{bmatrix} 2 \\ 1 \\ 1 \end{bmatrix}, \begin{bmatrix} 1 \\ 2 \\ 2 \end{bmatrix} \right\}.$$

$$o(\mathbf{B}_T) = 17.$$

If L is a lattice associated with T then we have the following diagram for L

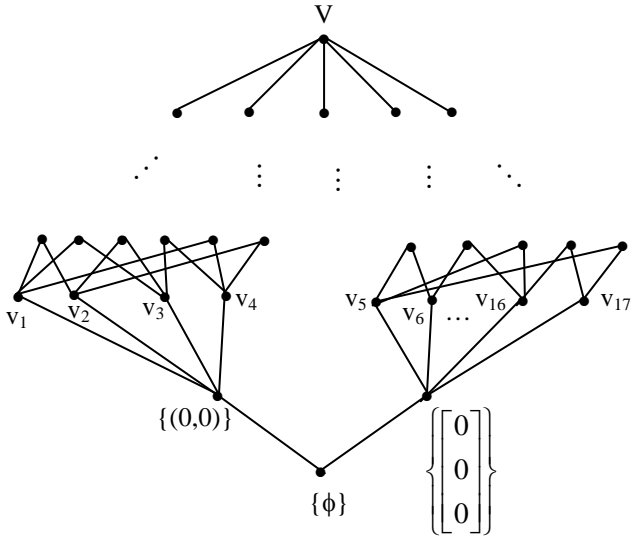

Example 4.37: Let $V = \{\mathbb{Z}_5, \mathbb{Z}_5 \times \mathbb{Z}_5\}$ be set vector space defined over the set $\{0, 2, 3, 4\} \subseteq \mathbb{Z}_5$.

Let $P = \{0, 2, 3\} \subseteq \mathbb{Z}_5$ and

$T = \{\text{Collection of all subset vector subspaces of } V \text{ over } P\}$ be the NS topological vector subspace of V over P .

Let B_T denote the basic set associated with T .

$B_T = \{\{0, 1, 2, 4, 3\} = v_1, \{(0, 0), (1, 0), (2, 0), (3, 0), (4, 0)\} = v_2, \{(0, 0), (0, 1), (0, 2), (0, 3), (0, 4)\} = v_3, \dots, v_7 = \{(0, 0), (1, 4), (2, 3), (4, 1), (3, 2)\}\}$.

The lattice L of T is as follows:

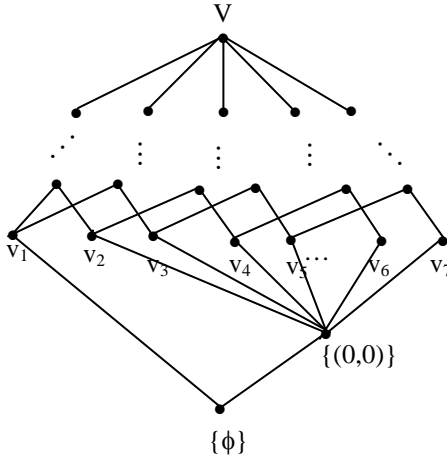

Now we proceed onto define two more types of set topological vector spaces using the group topological vector space and the semigroup topological vector space.

Let us recall the definition of semigroup vector space.

DEFINITION 4.4: Let V be a set S an additive semigroup with 0 . If for all $s \in S$ and $v \in V$ we have sv and $vs \in V$; $0.v = 0$ for all $v \in V$ and $0 \in S$.

$(s_1 + s_2) v = s_1v + s_2v$ we call V a semigroup vector space over the semigroup S .

For more please refer [19]. We define New Set semigroup vector subspace of V over a set $P \subseteq S$ (S the semigroup over which V is defined) or just set semigroup vector subspace of V over a set P in S .

DEFINITION 4.5: Let V be a semigroup vector space defined over the semigroup S . Let $W \subseteq V$ (W a proper subset of V) and $P \subseteq S$ (P only a subset of S). If W is a set vector space over P

then we define W to be a set semigroup vector subspace of V over the set P .

If $T = \{\text{Collection of all set semigroup vector subspaces of } V \text{ over the set } P \subseteq S\}$ then we define T to be a set semigroup topological vector subspace of V over the set $P \subseteq S$.

We will illustrate this situation by some simple examples.

Example 4.38: Let

$$V = \left\{ \mathbb{Z}_{12} \times \mathbb{Z}_{12}, \begin{bmatrix} a_1 \\ a_2 \\ a_3 \end{bmatrix} \mid a_i \in \mathbb{Z}_{12}, 1 \leq i \leq 3 \right\}$$

be a semigroup vector space defined over the semigroup $S = \{0, 4, 8\}$ under $+$.

Let $M = \{\text{all set semigroup vector subspaces of } V \text{ defined over the set } P = \{0, 8\} \subseteq S\}$ be the set semigroup topological vector subspace of V over the set P .

The basic set of M be

$$B_M = \{(0, 0), (1, 0), (8, 0), (4, 0)\}, \{(0, 0), (0, 1), (0, 8), (0, 4)\}, \dots, \{(0, 0), (5, 7), (4, 8), (8, 4)\},$$

$$\left\{ \begin{bmatrix} 0 \\ 0 \\ 0 \end{bmatrix}, \begin{bmatrix} 1 \\ 0 \\ 0 \end{bmatrix}, \begin{bmatrix} 8 \\ 0 \\ 0 \end{bmatrix}, \begin{bmatrix} 4 \\ 0 \\ 0 \end{bmatrix} \right\}, \left\{ \begin{bmatrix} 0 \\ 0 \\ 0 \end{bmatrix}, \begin{bmatrix} 0 \\ 0 \\ 5 \end{bmatrix}, \begin{bmatrix} 0 \\ 0 \\ 4 \end{bmatrix}, \begin{bmatrix} 0 \\ 0 \\ 8 \end{bmatrix} \right\}, \dots,$$

$$\left\{ \begin{bmatrix} 0 \\ 0 \\ 0 \end{bmatrix}, \begin{bmatrix} 7 \\ 6 \\ 9 \end{bmatrix}, \begin{bmatrix} 8 \\ 0 \\ 0 \end{bmatrix}, \begin{bmatrix} 4 \\ 0 \\ 0 \end{bmatrix} \right\}.$$

Example 4.39: Let

$$V = \left\{ (a_1, a_2, a_3), \begin{bmatrix} a_1 & a_2 & a_3 & a_4 \\ a_5 & a_6 & a_7 & a_8 \end{bmatrix}, \begin{bmatrix} a_1 \\ a_2 \\ a_3 \\ a_4 \end{bmatrix} \mid a_i \in \mathbb{Z}, 1 \leq i \leq 8 \right\}$$

be a semigroup vector space over the semigroup $S = \mathbb{Z}^+ \cup \{0\}$. Let $P = 5\mathbb{Z}^+ \cup 9\mathbb{Z}^+ \cup \{0\} \subseteq S$ be a subset.

$T = \{\text{Collection of all set semigroup vector subspaces of } V \text{ over the set } P \subseteq S\}$; be the set semigroup topological vector subspace of V over P . The basic set of T is of infinite order.

Example 4.40: Let

$$V = \left\{ \begin{pmatrix} a_1 & a_2 & a_3 \\ a_4 & a_5 & a_6 \end{pmatrix}, \begin{pmatrix} a_1 & a_2 \\ a_3 & a_4 \end{pmatrix}, \begin{bmatrix} a_1 \\ \vdots \\ a_{10} \end{bmatrix}, (a_1, \dots, a_6) \mid \right.$$

$$\left. a_i \in \mathbb{Z}_6; 1 \leq i \leq 6 \right\}$$

be a semigroup vector space defined over the semigroup $(\mathbb{Z}_6, +)$.

Let $P_1 = \{0, 1, 4, 3, 5\} \subseteq \mathbb{Z}_6$. $T_1 = \{\text{Collection of all set semigroup vector subspaces of } V \text{ defined over the set } P_1\}$ be the set semigroup topological vector subspace of V over the set P_1 . We see if B_{T_1} is the basic set of T_1 over P_1 then,

$$B_{T_1} = \left\{ v_1 = \left\{ \begin{pmatrix} 0 & 0 & 0 \\ 0 & 0 & 0 \end{pmatrix}, \begin{pmatrix} 1 & 0 & 0 \\ 0 & 0 & 0 \end{pmatrix}, \begin{pmatrix} 3 & 0 & 0 \\ 0 & 0 & 0 \end{pmatrix}, \right.$$

$$\left. \begin{pmatrix} 4 & 0 & 0 \\ 0 & 0 & 0 \end{pmatrix}, \begin{pmatrix} 5 & 0 & 0 \\ 0 & 0 & 0 \end{pmatrix}, \begin{pmatrix} 2 & 0 & 0 \\ 0 & 0 & 0 \end{pmatrix} \right\},$$

$$v_2 = \left\{ \begin{pmatrix} 0 & 0 & 0 \\ 0 & 0 & 0 \end{pmatrix}, \begin{pmatrix} 0 & 0 & 0 \\ 0 & 0 & 1 \end{pmatrix}, \begin{pmatrix} 0 & 0 & 0 \\ 0 & 0 & 2 \end{pmatrix}, \right.$$

$$\left. \begin{pmatrix} 0 & 0 & 0 \\ 0 & 0 & 4 \end{pmatrix}, \begin{pmatrix} 0 & 0 & 0 \\ 0 & 0 & 3 \end{pmatrix}, \begin{pmatrix} 0 & 0 & 0 \\ 0 & 0 & 5 \end{pmatrix} \right\}, \dots,$$

$$\left\{ \begin{pmatrix} 0 & 0 & 0 \\ 0 & 0 & 0 \end{pmatrix}, \begin{pmatrix} 2 & 4 & 3 \\ 5 & 1 & 0 \end{pmatrix}, \begin{pmatrix} 0 & 0 & 3 \\ 3 & 3 & 0 \end{pmatrix}, \begin{pmatrix} 4 & 2 & 3 \\ 1 & 5 & 0 \end{pmatrix} \right\},$$

$$\left\{ \begin{pmatrix} 0 & 0 \\ 0 & 0 \end{pmatrix}, \begin{pmatrix} 2 & 0 \\ 0 & 0 \end{pmatrix}, \begin{pmatrix} 3 & 0 \\ 0 & 0 \end{pmatrix}, \begin{pmatrix} 5 & 0 \\ 0 & 0 \end{pmatrix}, \begin{pmatrix} 4 & 0 \\ 0 & 0 \end{pmatrix} \right\},$$

$$\left\{ \begin{pmatrix} 0 & 0 \\ 0 & 0 \end{pmatrix}, \begin{pmatrix} 1 & 2 \\ 3 & 4 \end{pmatrix}, \begin{pmatrix} 4 & 2 \\ 0 & 4 \end{pmatrix}, \begin{pmatrix} 6 & 0 \\ 3 & 0 \end{pmatrix}, \begin{pmatrix} 5 & 4 \\ 3 & 2 \end{pmatrix}, \begin{pmatrix} 2 & 4 \\ 0 & 2 \end{pmatrix} \right\}, \dots,$$

$\{(0\ 0\ 0\ 0\ 0\ 0), (1\ 0\ 0\ 0\ 0\ 0), (4\ 0\ 0\ 0\ 0\ 0), (3\ 0\ 0\ 0\ 0\ 0), (5\ 0\ 0\ 0\ 0\ 0), (2\ 0\ 0\ 0\ 0\ 0), \dots, \{(2\ 4\ 3\ 0\ 5\ 1), (0\ 0\ 0\ 0\ 0\ 0), (2\ 4\ 0\ 0\ 2\ 4), (0\ 0\ 3\ 0\ 3\ 3), (4\ 2\ 0\ 0\ 4\ 2), (4\ 2\ 3\ 0\ 2\ 5)\},$

$$v_n = \left\{ \begin{bmatrix} 0 \\ 0 \\ \vdots \\ 0 \end{bmatrix}, \begin{bmatrix} 1 \\ 0 \\ \vdots \\ 0 \end{bmatrix}, \begin{bmatrix} 5 \\ 0 \\ \vdots \\ 0 \end{bmatrix}, \begin{bmatrix} 3 \\ 0 \\ \vdots \\ 0 \end{bmatrix}, \begin{bmatrix} 4 \\ 0 \\ \vdots \\ 0 \end{bmatrix}, \begin{bmatrix} 2 \\ 0 \\ \vdots \\ 0 \end{bmatrix} \right\} \text{ and so on}$$

is a basic set of T_1 over P_1 . We see the lattice associated with T_1 has only second layer of atoms.

The elements which are elements of the lattices are

$$B_{T_1} \setminus \left\{ \begin{pmatrix} 0 & 0 & 0 \\ 0 & 0 & 0 \end{pmatrix}, \begin{pmatrix} 0 & 0 \\ 0 & 0 \end{pmatrix}, \begin{bmatrix} 0 \\ 0 \\ \vdots \\ 0 \end{bmatrix}, (0, 0, 0, 0, 0, 0) \right\}.$$

Thus we have the following to be the lattice L of T_1 .

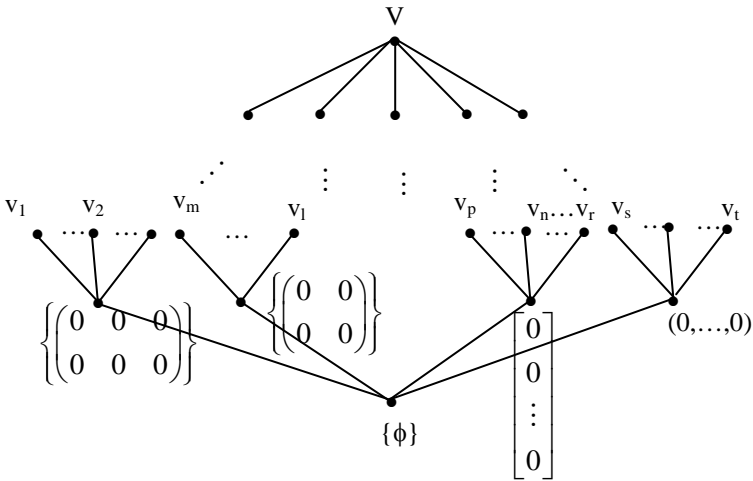

Example 4.41: Let

$$V = \left\{ \begin{pmatrix} a_1 & a_2 \\ a_3 & a_4 \end{pmatrix}, \mathbb{Z}_3 \times \mathbb{Z}_3, \mathbb{Z}_3 \right\}$$

be a semigroup vector space defined over the semigroup $S = \mathbb{Z}_3$.

Let $T_1 = \{\text{Collection of all set semigroup vector subspaces of } V \text{ over the set } P_1 = \{0, 2\}\}$ be the set semigroup topological vector subspaces of V over the set $P_1 = \{0, 2\}$.

The basic set of T_1 be

$$\begin{aligned}
 B_{T_1} = & \left\{ \left\{ \begin{pmatrix} 0 & 0 \\ 0 & 0 \end{pmatrix}, \begin{pmatrix} 1 & 0 \\ 0 & 0 \end{pmatrix}, \begin{pmatrix} 2 & 0 \\ 0 & 0 \end{pmatrix} \right\}, \left\{ \begin{pmatrix} 0 & 0 \\ 0 & 0 \end{pmatrix}, \begin{pmatrix} 0 & 1 \\ 0 & 0 \end{pmatrix}, \begin{pmatrix} 0 & 2 \\ 0 & 0 \end{pmatrix} \right\}, \\
 & \left\{ \begin{pmatrix} 0 & 0 \\ 0 & 0 \end{pmatrix}, \begin{pmatrix} 0 & 0 \\ 1 & 0 \end{pmatrix}, \begin{pmatrix} 0 & 0 \\ 2 & 0 \end{pmatrix} \right\}, \left\{ \begin{pmatrix} 0 & 0 \\ 0 & 0 \end{pmatrix}, \begin{pmatrix} 0 & 0 \\ 0 & 1 \end{pmatrix}, \begin{pmatrix} 0 & 0 \\ 0 & 2 \end{pmatrix} \right\}, \\
 & \left\{ \begin{pmatrix} 1 & 1 \\ 0 & 0 \end{pmatrix}, \begin{pmatrix} 0 & 0 \\ 0 & 0 \end{pmatrix}, \begin{pmatrix} 2 & 2 \\ 0 & 0 \end{pmatrix} \right\}, \left\{ \begin{pmatrix} 0 & 0 \\ 0 & 0 \end{pmatrix}, \begin{pmatrix} 0 & 0 \\ 1 & 1 \end{pmatrix}, \begin{pmatrix} 0 & 0 \\ 2 & 2 \end{pmatrix} \right\}, \\
 & \left\{ \begin{pmatrix} 0 & 0 \\ 0 & 0 \end{pmatrix}, \begin{pmatrix} 1 & 0 \\ 1 & 0 \end{pmatrix}, \begin{pmatrix} 2 & 0 \\ 2 & 0 \end{pmatrix} \right\}, \dots, \left\{ \begin{pmatrix} 0 & 0 \\ 0 & 0 \end{pmatrix}, \begin{pmatrix} 1 & 1 \\ 1 & 1 \end{pmatrix}, \begin{pmatrix} 2 & 2 \\ 2 & 2 \end{pmatrix} \right\},
 \end{aligned}$$

$\{(0, 0), (1, 0), (2, 0)\}$, $\{(0, 0), (0, 1), (0, 2)\}$, $\{(0, 0), (1, 1), (2, 2)\}$, $\{(0, 0), (1, 2), (2, 1)\}$, $\{0, 1, 2\}$.

The lattice associated with T is as follows:

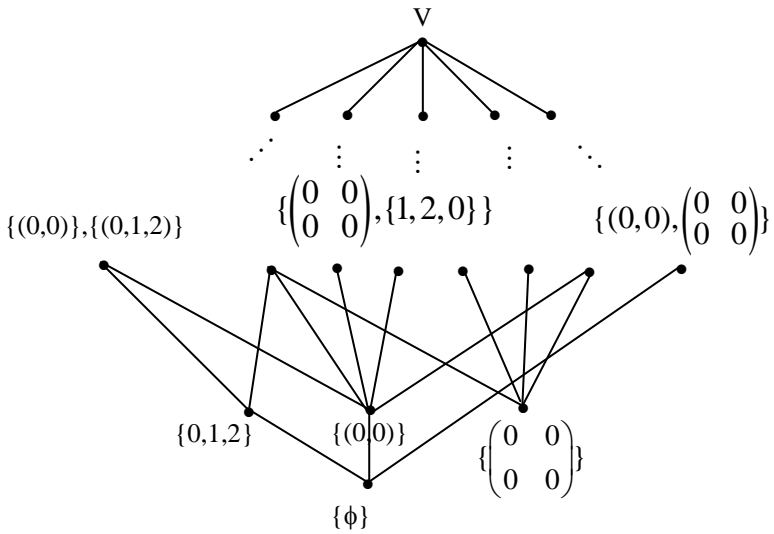

This is also a very different situation than the lattice of usual quasi set topological vector subspaces or New set topological vector subspaces defined over the set.

Example 4.42: Let

$$V = \left\{ Z_5, \begin{bmatrix} a_1 \\ a_2 \\ a_3 \end{bmatrix}, (a_1, a_2), \begin{pmatrix} a_1 & a_2 \\ a_3 & a_4 \end{pmatrix} \mid a_i \in Z_5, 1 \leq i \leq 4 \right\}$$

be a semigroup vector space defined over the semigroup $S = Z_5$.

Let $P_1 = \{0, 1, 2\} \subseteq Z_5$ and $T_1 = \{\text{Collection of set semigroup vector subspaces of } V \text{ over the set } P_1\}$ be the set semigroup topological vector subspace of V over P_1 .

Let B_{T_1} be the basic set of T_1 ,

$$B_{T_1} = \{ \{0, 1, 2, 4, 3\}, \{(0, 0), (1, 0), (2, 0), (4, 0), (3, 0)\}, \{(0, 0), (0, 1), (0, 2), (0, 3), (0, 4)\}, \{(0, 0), (1, 1), (2, 2), (3, 3), (4, 4)\}, \{(0, 0), (1, 2), (2, 4), (4, 3), (3, 1)\}, \{(0, 0), (1, 3), (2, 1), (4, 2), (3, 4)\}, \{(0, 0), (1, 4), (2, 3), (4, 1), (3, 2)\},$$

$$\left\{ \begin{bmatrix} 0 \\ 0 \\ 0 \end{bmatrix}, \begin{bmatrix} 1 \\ 2 \\ 4 \end{bmatrix}, \begin{bmatrix} 2 \\ 4 \\ 3 \end{bmatrix}, \begin{bmatrix} 4 \\ 3 \\ 1 \end{bmatrix}, \begin{bmatrix} 3 \\ 1 \\ 2 \end{bmatrix} \right\},$$

$$\left\{ \begin{pmatrix} 0 & 0 \\ 0 & 0 \end{pmatrix}, \begin{pmatrix} 1 & 0 \\ 0 & 0 \end{pmatrix}, \begin{pmatrix} 2 & 0 \\ 0 & 0 \end{pmatrix}, \begin{pmatrix} 4 & 0 \\ 0 & 0 \end{pmatrix}, \begin{pmatrix} 3 & 0 \\ 0 & 0 \end{pmatrix} \right\}, \dots,$$

$$\left\{ \begin{pmatrix} 0 & 0 \\ 0 & 0 \end{pmatrix}, \begin{pmatrix} 1 & 2 \\ 4 & 3 \end{pmatrix}, \begin{pmatrix} 2 & 4 \\ 3 & 1 \end{pmatrix}, \begin{pmatrix} 4 & 3 \\ 1 & 2 \end{pmatrix}, \begin{pmatrix} 3 & 1 \\ 2 & 4 \end{pmatrix} \right\}.$$

The lattice L associated with T is as follows:

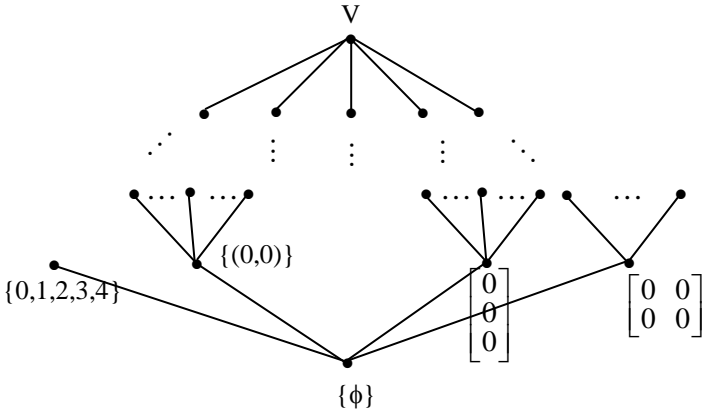

Example 4.43: Let

$$V = \left\{ \mathbb{Z}, \mathbb{Z} \times \mathbb{Z}, \begin{bmatrix} a \\ b \end{bmatrix}, \mathbb{Z} \times \mathbb{Z} \times \mathbb{Z}, \begin{bmatrix} a \\ b \\ c \end{bmatrix} \mid a, b, c \in \mathbb{Z} \right\}$$

be a semigroup vector space defined over the semigroup $S = \mathbb{Z}^+ \cup \{0\}$. Let $P = \{0, 1\} \subseteq S$ be a subset of S .

$T = \{ \text{Collection of all set semigroup vector subspaces of } V \text{ over the set } P = \{0, 1\} \}$ be the set semigroup topological vector subspace of V over P . Let B_T be the basic set of T .

$$B_T = \{ \{0, 1\}, \{0, 2\}, \{0, -1\}, \{0, -2\}, \dots, \{0, n\}, \{0, -n\}, \dots, \{(0, 0), (1, 0)\}, \{(-1, 0), (0, 0)\}, \{(0, 0), (0, 1)\}, \{(0, -1), (0, 0)\}, \dots, \{(1, 1), (0, 0)\}, \{(1, -1), (0, 0)\}, \{(-1, 1), (0, 0)\}, \{(-1, -1), (0, 0)\}, \dots, \{(n, n), (0, 0)\}, \dots, \{(n, m), (0, 0)\}, \{(0, 0), (-n, -m)\}, \{(n, -m), (0, 0)\},$$

$$\{(-n, m), (0, 0)\}, \dots, \left\{ \begin{bmatrix} 0 \\ 0 \end{bmatrix}, \begin{bmatrix} 1 \\ 0 \end{bmatrix} \right\}, \left\{ \begin{bmatrix} 0 \\ 0 \end{bmatrix}, \begin{bmatrix} 0 \\ 1 \end{bmatrix} \right\}, \left\{ \begin{bmatrix} 0 \\ 0 \end{bmatrix}, \begin{bmatrix} 1 \\ 1 \end{bmatrix} \right\},$$

$$\left\{ \begin{bmatrix} 0 \\ 0 \end{bmatrix}, \begin{bmatrix} 1 \\ 2 \end{bmatrix} \right\}, \dots, \left\{ \begin{bmatrix} 0 \\ 0 \end{bmatrix}, \begin{bmatrix} n \\ m \end{bmatrix} \right\}, \dots, \{(0, 0, 0), (1, 0, 0)\},$$

$$\{(0, 0, 0), (0, 1, 0)\}, \{(0, 0, 0), (0, 0, 1)\}, \{(0, 0, 0), (1, 1, 1)\}, \dots, \{(0, 0, 0), (m, m, m)\}, \{(0, 0, 0), (m, n, t)\}, \dots,$$

$$\left\{ \begin{bmatrix} 0 \\ 0 \\ 0 \end{bmatrix}, \begin{bmatrix} 1 \\ 0 \\ 0 \end{bmatrix} \right\}, \left\{ \begin{bmatrix} 0 \\ 0 \\ 0 \end{bmatrix}, \begin{bmatrix} n \\ 0 \\ 0 \end{bmatrix} \right\}, \dots, \left\{ \begin{bmatrix} 0 \\ 0 \\ 0 \end{bmatrix}, \begin{bmatrix} m \\ n \\ t \end{bmatrix} \right\}, \dots\}.$$

We see $o(B_T) = \infty$.

The lattice associated with T is as follows:

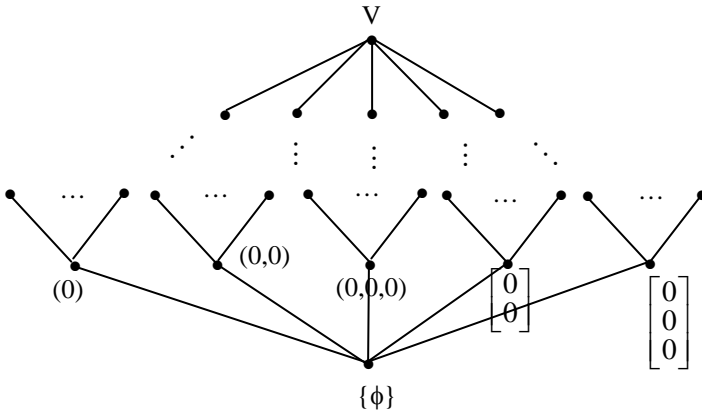

Example 4.44: Let

$$V = \{Z_{11} \times Z_{11} \times Z_{11}, \begin{pmatrix} a_1 & a_2 & a_3 \\ a_4 & a_5 & a_6 \end{pmatrix}, \begin{bmatrix} a_1 \\ a_2 \\ a_3 \\ a_4 \end{bmatrix} \mid$$

$$a_i \in Z_{11}; 1 \leq i \leq 8\}$$

be the semigroup set vector space defined over the semigroup Z_{11} . Let $P = \{0, 1, 2\} \subseteq Z_{11}$.

Let $T = \{\text{Collection of all set semigroup vector subspace of } V \text{ over the set } P\}$; be the set semigroup topological vector subspace of V over P . Let B_T be the basic set of T over P .

$B_T = \{\{0, 1, 2, 4, 8, 5, 10, 9, 7, 3, 6\}, \{(0, 0), (1, 0), \dots, (10, 0)\}, \dots, \{(0, 0), (1, 4), (2, 8), (4, 5), (8, 10), (5, 9), (10, 7), (9, 3), (7, 6), (3, 1), (6, 2)\},$

$$\left\{ \begin{pmatrix} 0 & 0 & 0 \\ 0 & 0 & 0 \end{pmatrix}, \begin{pmatrix} 1 & 0 & 0 \\ 0 & 0 & 0 \end{pmatrix}, \begin{pmatrix} 2 & 0 & 0 \\ 0 & 0 & 0 \end{pmatrix}, \dots, \begin{pmatrix} 10 & 0 & 0 \\ 0 & 0 & 0 \end{pmatrix} \right\}, \dots,$$

$$\left\{ \begin{pmatrix} 0 & 0 & 0 \\ 0 & 0 & 0 \end{pmatrix}, \begin{pmatrix} 2 & 5 & 7 \\ 6 & 4 & 3 \end{pmatrix}, \begin{pmatrix} 4 & 10 & 3 \\ 7 & 8 & 6 \end{pmatrix}, \begin{pmatrix} 8 & 9 & 6 \\ 2 & 5 & 1 \end{pmatrix}, \begin{pmatrix} 5 & 7 & 1 \\ 4 & 10 & 2 \end{pmatrix}, \right.$$

$$\left. \begin{pmatrix} 10 & 3 & 2 \\ 8 & 9 & 4 \end{pmatrix}, \begin{pmatrix} 9 & 6 & 4 \\ 5 & 7 & 8 \end{pmatrix}, \begin{pmatrix} 7 & 1 & 8 \\ 10 & 3 & 5 \end{pmatrix}, \right.$$

$$\left. \begin{pmatrix} 3 & 2 & 5 \\ 9 & 6 & 10 \end{pmatrix}, \begin{pmatrix} 6 & 4 & 10 \\ 7 & 1 & 9 \end{pmatrix}, \begin{pmatrix} 1 & 8 & 9 \\ 3 & 2 & 7 \end{pmatrix} \right\},$$

$$\left\{ \begin{bmatrix} 0 & 0 \\ 0 & 0 \\ 0 & 0 \\ 0 & 0 \end{bmatrix}, \begin{bmatrix} 1 & 0 \\ 0 & 0 \\ 0 & 0 \\ 0 & 0 \end{bmatrix}, \begin{bmatrix} 2 & 0 \\ 0 & 0 \\ 0 & 0 \\ 0 & 0 \end{bmatrix}, \dots, \begin{bmatrix} 10 & 0 \\ 0 & 0 \\ 0 & 0 \\ 0 & 0 \end{bmatrix} \right\}, \dots,$$

$$\left\{ \begin{bmatrix} 0 & 0 \\ 0 & 0 \\ 0 & 0 \\ 0 & 0 \end{bmatrix}, \begin{bmatrix} 4 & 5 \\ 3 & 2 \\ 7 & 6 \\ 9 & 10 \end{bmatrix}, \begin{bmatrix} 8 & 10 \\ 6 & 4 \\ 3 & 1 \\ 7 & 9 \end{bmatrix}, \begin{bmatrix} 5 & 9 \\ 1 & 8 \\ 6 & 2 \\ 3 & 7 \end{bmatrix}, \begin{bmatrix} 10 & 7 \\ 2 & 5 \\ 1 & 4 \\ 6 & 3 \end{bmatrix}, \right.$$

$$\left. \left. \left. \left. \begin{bmatrix} 9 & 3 \\ 4 & 10 \\ 2 & 8 \\ 1 & 6 \end{bmatrix}, \begin{bmatrix} 7 & 9 \\ 8 & 9 \\ 4 & 5 \\ 2 & 1 \end{bmatrix}, \begin{bmatrix} 3 & 1 \\ 5 & 7 \\ 8 & 10 \\ 4 & 2 \end{bmatrix}, \begin{bmatrix} 2 & 8 \\ 7 & 1 \\ 9 & 3 \\ 10 & 5 \end{bmatrix} \right\} \right\} \right\}.$$

The lattice associated with T is not a Boolean algebra it is as follows:

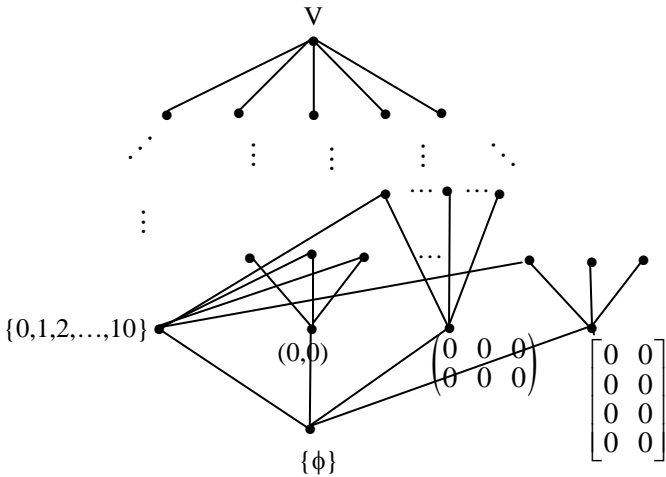

We see in case of set semigroup topological vector subspaces the lattice may or may not be a Boolean algebra.

However we have set semigroup subtopological vector subspaces of a set semigroup topological space's sublattice can be Boolean algebra.

To this end we give some examples.

Example 4.45: Let

$$V = \{Z_6 \times Z_6, Z_6, Z_6 \times Z_6 \times Z_6 \times Z_6,$$

$$\left[\begin{array}{cc} a & b \\ c & d \end{array} \right], \left(\begin{array}{cccc} a_1 & a_2 & a_3 & a_4 \\ a_5 & a_6 & a_7 & a_8 \end{array} \right) \mid a, b, c, d, a_i \in Z_6, 1 \leq i \leq 8\}$$

be a set semigroup vector space over the semigroup $S = Z_6$.

Let $T = \{\text{Collection of all set semigroup vector subspaces of } V \text{ over the set } P = \{0, 2, 5, 3\} \subseteq S\}$ be the New set semigroup topological vector subspace of V over P .

Let B_T be the basic set of T .

$$B_T = \{\{0, 1, 2, 3, 5, 4\}, \{(0, 0), (1, 0), (2, 0), (3, 0), (5, 0), (4, 0)\}, \dots, \{(0, 0), (4, 5), (2, 4), (4, 2), (0, 3), (2, 1)\}, \{(0\ 0\ 0\ 0), (1\ 0\ 0\ 0), (3\ 0\ 0\ 0), (2\ 0\ 0\ 0), (4\ 0\ 0\ 0), (5\ 0\ 0\ 0)\}, \dots, \{(0\ 0\ 0\ 0), (2\ 4\ 3\ 1), (4\ 2\ 0\ 2), (0\ 0\ 3\ 3), (4\ 2\ 3\ 5), (2\ 4\ 0\ 4)\},$$

$$\left\{ \begin{pmatrix} 0 & 0 \\ 0 & 0 \end{pmatrix}, \begin{pmatrix} 1 & 0 \\ 0 & 0 \end{pmatrix}, \begin{pmatrix} 5 & 0 \\ 0 & 0 \end{pmatrix}, \right.$$

$$\left. \begin{pmatrix} 2 & 0 \\ 0 & 0 \end{pmatrix}, \begin{pmatrix} 3 & 0 \\ 0 & 0 \end{pmatrix}, \begin{pmatrix} 4 & 0 \\ 0 & 0 \end{pmatrix} \right\}, \dots, \left\{ \begin{pmatrix} 0 & 0 \\ 0 & 0 \end{pmatrix}, \begin{pmatrix} 3 & 5 \\ 2 & 1 \end{pmatrix}, \begin{pmatrix} 0 & 4 \\ 4 & 2 \end{pmatrix}, \right.$$

$$\left. \begin{pmatrix} 3 & 3 \\ 0 & 3 \end{pmatrix}, \begin{pmatrix} 0 & 2 \\ 2 & 4 \end{pmatrix}, \begin{pmatrix} 3 & 1 \\ 4 & 5 \end{pmatrix} \right\},$$

$$\left\{ \begin{pmatrix} 0 & 0 & 0 & 0 \\ 0 & 0 & 0 & 0 \end{pmatrix}, \begin{pmatrix} 1 & 0 & 0 & 0 \\ 0 & 0 & 0 & 0 \end{pmatrix}, \begin{pmatrix} 2 & 0 & 0 & 0 \\ 0 & 0 & 0 & 0 \end{pmatrix}, \right.$$

$$\left. \begin{pmatrix} 4 & 0 & 0 & 0 \\ 0 & 0 & 0 & 0 \end{pmatrix}, \begin{pmatrix} 5 & 0 & 0 & 0 \\ 0 & 0 & 0 & 0 \end{pmatrix}, \begin{pmatrix} 3 & 0 & 0 & 0 \\ 0 & 0 & 0 & 0 \end{pmatrix} \right\},$$

$$\cdots, \left\{ \begin{pmatrix} 0 & 0 & 0 & 0 \\ 0 & 0 & 0 & 0 \end{pmatrix}, \begin{pmatrix} 1 & 2 & 3 & 4 \\ 2 & 3 & 4 & 1 \end{pmatrix}, \begin{pmatrix} 2 & 4 & 0 & 2 \\ 4 & 0 & 2 & 2 \end{pmatrix}, \right. \\ \left. \begin{pmatrix} 3 & 0 & 3 & 0 \\ 0 & 3 & 0 & 3 \end{pmatrix}, \begin{pmatrix} 4 & 2 & 0 & 4 \\ 2 & 0 & 4 & 4 \end{pmatrix}, \begin{pmatrix} 5 & 4 & 3 & 2 \\ 4 & 3 & 2 & 5 \end{pmatrix} \right\}.$$

We see $M_1 = \langle (0, 1, 2, 3, 4, 5) \rangle$ generates the topology of order two. M_1 is a set semigroup subtopological vector subspace of T over P .

$M_2 = \{ \langle (0, 0), (1, 0), (2, 0), (3, 0), (4, 0), (5, 0) \rangle, \dots, \langle (0, 0), (4, 5), (2, 4), (4, 2), (0, 3) \rangle \}$ generates a set semigroup subtopological vector subspace of T over P . The sublattice associated with M_2 is a Boolean algebra of order 2^7 . We had the seven atoms which generate M_2 .

$M_3 = \langle \{ (0\ 0\ 0\ 0), (1\ 0\ 0\ 0), (2\ 0\ 0\ 0), (3\ 0\ 0\ 0), (5\ 0\ 0\ 0), (4\ 0\ 0\ 0) \} \dots \rangle$ generates a set semigroup subtopological vector subspace of T .

The sublattice associated with M_3 is also a Boolean algebra with $\{(0, 0, 0, 0)\}$ as its least element and $Z_6 \times Z_6 \times Z_6 \times Z_6$ acts as the greatest element.

Let

$$M_4 = \left\langle \left\{ \begin{pmatrix} 0 & 0 \\ 0 & 0 \end{pmatrix}, \begin{pmatrix} 1 & 0 \\ 0 & 0 \end{pmatrix}, \begin{pmatrix} 2 & 0 \\ 0 & 0 \end{pmatrix}, \begin{pmatrix} 3 & 0 \\ 0 & 0 \end{pmatrix}, \begin{pmatrix} 4 & 0 \\ 0 & 0 \end{pmatrix}, \begin{pmatrix} 5 & 0 \\ 0 & 0 \end{pmatrix} \right\}, \right. \\ \left. \left\{ \begin{pmatrix} 0 & 0 \\ 0 & 0 \end{pmatrix}, \begin{pmatrix} 0 & 2 \\ 0 & 0 \end{pmatrix}, \begin{pmatrix} 0 & 3 \\ 0 & 0 \end{pmatrix}, \begin{pmatrix} 0 & 1 \\ 0 & 0 \end{pmatrix}, \begin{pmatrix} 0 & 4 \\ 0 & 0 \end{pmatrix}, \begin{pmatrix} 0 & 5 \\ 0 & 0 \end{pmatrix} \right\}, \dots \right\rangle$$

generates a set semigroup subtopological vector subspace of T over P .

The sublattice generated M_4 is Boolean algebra with $\left\{ \begin{pmatrix} 0 & 0 \\ 0 & 0 \end{pmatrix} \right\}$ as its least element and

$$\left\{ \begin{pmatrix} a & b \\ c & d \end{pmatrix} \mid a, b, c, d \in \mathbb{Z}_6 \right\} \text{ as its greatest element.}$$

We see however the lattice associated with T is not a Boolean algebra.

Further T has set semigroup subtopological vector subspaces which are not Boolean algebras. For $M_1 \cup M_2$ and $M_2 \cup M_3$ are also set semigroup subtopological vector subspaces of T and the lattices associated with $M_1 \cup M_2$ and $M_2 \cup M_3$ are not Boolean algebras and $\{\phi\}$ is the least element of both $M_1 \cup M_2$ and $M_2 \cup M_3$.

We see the lattice L of a set semigroup topological vector subspace, T of V over P is not a Boolean algebra. However the lattice L has sublattices which are Boolean algebras. L has also sublattices which are not Boolean algebras.

Example 4.46: Let

$$V = \left\{ \mathbb{Z}_4 \times \mathbb{Z}_4, \begin{bmatrix} a_1 \\ a_2 \\ a_3 \end{bmatrix}, \begin{bmatrix} a_1 & a_2 \\ a_3 & a_4 \end{bmatrix} \mid a_i \in \mathbb{Z}_4, 1 \leq i \leq 4 \right\}$$

be a semigroup vector space over the semigroup \mathbb{Z}_4 . Let $P = \{0, 2\} \subseteq \mathbb{Z}_4$. $T = \{\text{Collection of all set semigroup vector subspaces of } V \text{ over the set } P = \{0, 2\}\}$ be the set semigroup topological vector subspace of V over P .

Let B_T be the basic set of the set semigroup topological vector subspace of V over P .

$$B_T = \{ \{(0, 0), (1, 0), (2, 0)\}, \{(0, 0), (0, 1), (0, 2)\}, \{(0, 0), (0, 3), (0, 2)\}, \{(0, 0), (3, 0), (2, 0)\}, \{(0, 0), (1, 1), (2, 2)\}, \{(0, 0), (3, 3), (2, 2)\}, \{(0, 0), (1, 2), (2, 0)\}, \{(0, 0), (2, 1), (0, 2)\}, \{(0, 0), (1, 3), (2, 2)\}, \{(0, 0), (3, 1), (2, 2)\}, \{(0, 0), (2, 3), (0, 2)\}, \{(0, 0), (3, 0), (2, 0)\}, \{(0, 0), (3, 2), (2, 0)\},$$

$$\left\{ \begin{bmatrix} 0 \\ 0 \\ 0 \end{bmatrix}, \begin{bmatrix} 1 \\ 0 \\ 0 \end{bmatrix}, \begin{bmatrix} 2 \\ 0 \\ 0 \end{bmatrix} \right\}, \left\{ \begin{bmatrix} 0 \\ 0 \\ 0 \end{bmatrix}, \begin{bmatrix} 1 \\ 0 \\ 0 \end{bmatrix}, \begin{bmatrix} 2 \\ 0 \\ 0 \end{bmatrix} \right\}, \left\{ \begin{bmatrix} 0 \\ 0 \\ 0 \end{bmatrix}, \begin{bmatrix} 0 \\ 1 \\ 0 \end{bmatrix}, \begin{bmatrix} 2 \\ 0 \\ 0 \end{bmatrix} \right\},$$

$$\left\{ \begin{bmatrix} 0 \\ 0 \\ 0 \end{bmatrix}, \begin{bmatrix} 0 \\ 0 \\ 1 \end{bmatrix}, \begin{bmatrix} 0 \\ 0 \\ 2 \end{bmatrix} \right\}, \dots, \left\{ \begin{bmatrix} 0 \\ 0 \\ 0 \end{bmatrix}, \begin{bmatrix} 1 \\ 2 \\ 2 \end{bmatrix}, \begin{bmatrix} 2 \\ 0 \\ 0 \end{bmatrix} \right\},$$

$$\left\{ \begin{bmatrix} 0 & 0 \\ 0 & 0 \end{bmatrix}, \begin{bmatrix} 1 & 0 \\ 0 & 0 \end{bmatrix}, \begin{bmatrix} 2 & 0 \\ 0 & 0 \end{bmatrix} \right\}, \left\{ \begin{bmatrix} 0 & 0 \\ 0 & 0 \end{bmatrix}, \begin{bmatrix} 0 & 0 \\ 1 & 0 \end{bmatrix}, \begin{bmatrix} 0 & 0 \\ 2 & 0 \end{bmatrix} \right\}, \dots,$$

$$\left\{ \begin{bmatrix} 0 & 0 \\ 0 & 0 \end{bmatrix}, \begin{bmatrix} 1 & 2 \\ 3 & 1 \end{bmatrix}, \begin{bmatrix} 2 & 0 \\ 2 & 2 \end{bmatrix} \right\}.$$

Suppose L is the lattice associated T. L is not a Boolean algebra. The lattice associated with T is as follows:

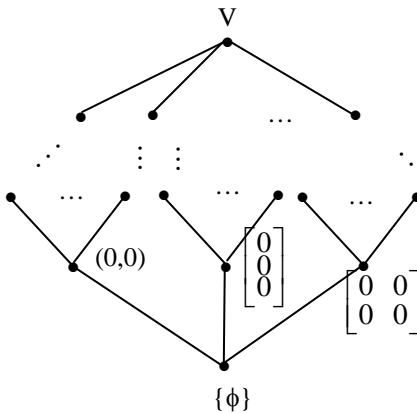

However this lattice associated with T has sublattices which are Boolean algebras. Further these sublattices give way to the set semigroup subtopological vector subspaces of T .

Now we proceed onto describe set group topological vector subspaces.

Let V be the group vector space over the group G under '+'. Let $P \subseteq G$ be a proper subset of G . Let $S \subseteq V$ be again a proper subset of V . If for all $g \in P$ and $s \in S$, sg and gs is in S . We define S to be a set group vector subspace of V over the set P of the group G .

We will illustrate this by some examples.

Example 4.47: Let

$$V = \left\{ \begin{pmatrix} 0 & 0 & 0 \\ 0 & g & 0 \end{pmatrix}, \begin{pmatrix} a & 0 & 0 \\ 0 & 0 & 0 \end{pmatrix}, \begin{pmatrix} 0 & b & 0 \\ 0 & 0 & c \end{pmatrix}, \begin{pmatrix} 0 & 0 & d \\ e & f & 0 \end{pmatrix} \right\}$$

$$a, b, c, d, e, f, g \in \mathbb{Z}_{12}$$

be the group vector space over group $G = (\mathbb{Z}_{12}, +)$.

Let $P = \{0, 2, 3\}$ and

$$S = \left\{ \begin{pmatrix} 0 & 0 & 0 \\ 0 & 0 & 0 \end{pmatrix}, \begin{pmatrix} a & 0 & 0 \\ 0 & 0 & 0 \end{pmatrix}, \begin{pmatrix} 0 & b & 0 \\ 0 & 0 & c \end{pmatrix} \right\}$$

$$a, b, c, \in \{0, 2, 4, 6, 8, 10, 3, 9\} \subseteq \mathbb{Z}_{12} \subseteq V$$

is a set group vector subspace of V over the set $P = \{0, 2, 3\} \subseteq G$.

It is interesting to note we can have several such set group vector subspaces of V for a given set P of G .

Example 4.48: Let $V = \{(a, 0), (b, 0) \mid a, b \in \mathbb{Z}_5\}$ be a group vector space over the group $G = (\mathbb{Z}_5, +)$. Let $P = \{0, 1\} \subseteq G$ be a subset of G .

$S_1 = \{(0, 0), (1, 0)\} \subseteq V$ is a set group vector subspace of V over the set P . $S_2 = \{(0, 0), (0, 1)\} \subseteq V$ is a set group vector subspace of V over the set $P \subseteq G$. $S_3 = \{(0, 0), (2, 0)\} \subseteq V$ is also a set group vector subspace of V over the set $P \subseteq G$.

$S_4 = \{(0, 0), (0, 2)\} \subseteq V$ is again a set group vector subspace of V over the set $P \subseteq G$. $S_5 = \{(0, 0), (0, 3)\} \subseteq V$ is a set group vector subspace of V over the set $P \subseteq G$, $S_6 = \{(0, 0), (3, 0)\} \subseteq V$ is a set group vector subspace of V over the set $P \subseteq G$ and so on.

We see in S_i we cannot have any subset to be a set group vector subspace of V over $P \subseteq G$, $1 \leq i \leq 6$.

Example 4.49: Let $M = \{(0, 0, 0), (a, 0, 0), (0, b, 0), (0, 0, c) \mid a, b, c \in \mathbb{Z}_3\}$ be a group vector space over the group $G = (\mathbb{Z}_3, +)$. Let $P = \{0, 1\} \subseteq G$ be a set in G . $S_1 = \{(0, 0, 0), (1, 0, 0)\} \subseteq M$ is a set group vector subspace of M over the set $P \subseteq G$.

$$\begin{aligned} S_2 &= \{(0, 0, 0), (2, 0, 0)\} \subseteq M, \\ S_3 &= \{(0, 0, 0), (0, 1, 0)\} \subseteq M, \\ S_4 &= \{(0, 0, 0), (0, 2, 0)\} \subseteq M, \\ S_5 &= \{(0, 0, 0), (0, 0, 1)\} \subseteq M \text{ and} \\ S_6 &= \{(0, 0, 0), (0, 0, 2)\} \subseteq M \end{aligned}$$

are set group vector subspaces of V which has no subsets which are again set group vector subspaces of V over P .

We have a collection of them.

Let V be a group vector space over the group $(G, +)$. Let $P \subseteq G$ be a proper subset of G . $S \equiv V$ be a proper subset of V . $T = \{\text{Collection of all set group vector subspaces of } V \text{ over the set } P \text{ of } G\}$.

T can be given a topology and T with the topology; the whole set and the empty set or zero set is in T . Union of sets in T are in T .

Intersection of sets in T are in T . T with this topology will be defined as the set group topological vector subspace.

We will illustrate this situation by some examples.

Example 4.50: Let $V = \{(0, 0, 0), (a, 0, 0), (0, b, b) \mid a, b \in \mathbb{Z}_4\}$ be the group vector space over the group $G = (\mathbb{Z}_4, +)$.

$V = \{(0, 0, 0), (1, 1, 0), (0, 1, 1), (2, 2, 0), (0, 2, 2), (3, 3, 0), (0, 3, 3)\}$. Let $P = \{0, 1\} \subseteq G$.

The set group vector subspaces of V over P are as follows:

$S_1 = \{(0, 0, 0), (1, 1, 0)\}$, $S_2 = \{(0, 0, 0), (2, 2, 0)\}$, $S_3 = \{(0, 0, 0), (3, 3, 0)\}$, $S_4 = \{(0, 0, 0), (0, 1, 1)\}$, $S_5 = \{(0, 0, 0), (0, 2, 2)\}$, $S_6 = \{(0, 0, 0), (0, 3, 3)\}$, $S_7 = \{(0, 0, 0), (0, 1, 1), (0, 2, 2)\}$, $S_8 = \{(0, 0, 0), (0, 1, 1), (0, 3, 3)\}$, $S_9 = \{(0, 0, 0), (0, 3, 3), (0, 2, 2)\}$ and so on.

$T = \{\text{Collection of all set group vector subspaces of } V \text{ over the set } P = \{0, 1\}\}$. T is a set group topological vector subspace of V associated with P .

We see the lattice associated with this topological space T is as follows.

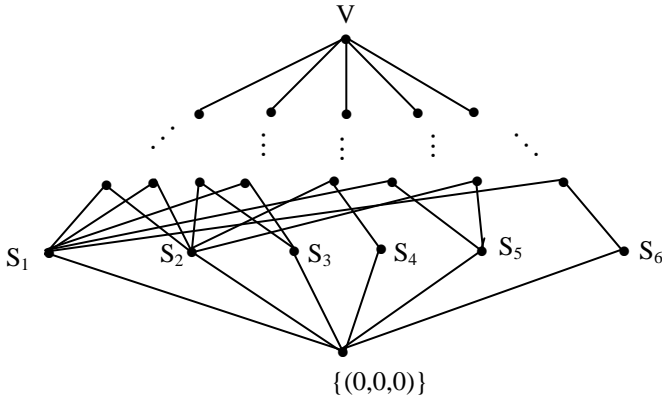

The lattice is a Boolean algebra of order 2^6 with $\{(0, 0, 0)\}$ as the least element and V is the largest element in the lattice of T . We can have set group subtopological vector subspaces of T also.

For instance take $T_1 = \langle \{(0, 0, 0), (0, 1, 1)\}, \{(0, 0, 0), (0, 2, 2)\}, \{(0, 0, 0), (1, 0, 0)\} \rangle$. T_1 is a subtopological set group vector subspace of T . The lattice associated with T is as follows:

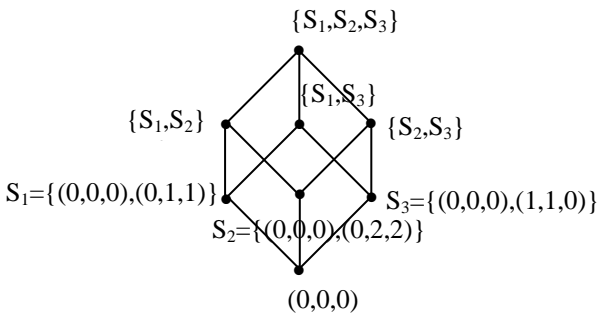

The lattice is a Boolean algebra of order 8.

We can have several such set group subtopological vector subspaces of T .

Example 4.51: Let

$$V = \left\{ \begin{bmatrix} 1 \\ 0 \\ 1 \end{bmatrix}, \begin{bmatrix} 0 \\ 0 \\ 0 \end{bmatrix}, \begin{bmatrix} 2 \\ 0 \\ 2 \end{bmatrix}, \begin{bmatrix} 0 \\ 1 \\ 0 \end{bmatrix}, \begin{bmatrix} 0 \\ 2 \\ 0 \end{bmatrix} \mid 1, 2, 0 \in \mathbb{Z}_3 \right\}$$

be a group vector space over the group \mathbb{Z}_3 under addition.

Take $P = \{0, 2\} \in \mathbb{Z}_3$ a proper subset of \mathbb{Z}_3 .

Let

$T = \{\text{Collection of all set group vector subspaces of } V \text{ over } P\}$.

$$S_1 = \left\{ \begin{bmatrix} 0 \\ 0 \\ 0 \end{bmatrix} \right\}, \left\{ \begin{bmatrix} 0 \\ 0 \\ 0 \end{bmatrix}, \begin{bmatrix} 1 \\ 0 \\ 1 \end{bmatrix}, \begin{bmatrix} 2 \\ 0 \\ 2 \end{bmatrix} \right\} \text{ and } S_2 = \left\{ \begin{bmatrix} 0 \\ 0 \\ 0 \end{bmatrix}, \begin{bmatrix} 0 \\ 1 \\ 0 \end{bmatrix}, \begin{bmatrix} 0 \\ 2 \\ 0 \end{bmatrix} \right\}$$

be the set group topological vector subspaces of V over the set P .

The lattice associated with T is as follows:

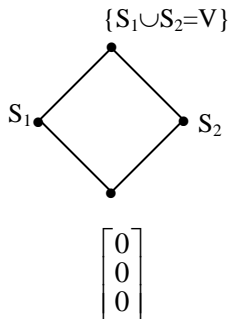

The set group subtopological spaces are $\left\{ \begin{bmatrix} 0 \\ 0 \\ 0 \end{bmatrix} \right\}, V,$

$$\left\{ \begin{bmatrix} 0 \\ 0 \\ 0 \end{bmatrix}, \begin{bmatrix} 0 \\ 1 \\ 0 \end{bmatrix}, \begin{bmatrix} 0 \\ 2 \\ 0 \end{bmatrix} \right\} \text{ and } \left\{ \begin{bmatrix} 0 \\ 0 \\ 0 \end{bmatrix}, \begin{bmatrix} 1 \\ 0 \\ 1 \end{bmatrix}, \begin{bmatrix} 2 \\ 0 \\ 2 \end{bmatrix} \right\}.$$

It is important to observe that if we change the underlying set $P \subseteq G$ then their will change in T .

For instance if we take $P_1 = \{0, 1\} \subseteq Z_3$ to find T_1 the set group topological vector subspace associated with P_1 .

$$T_1 = \left\{ \left\{ \begin{bmatrix} 0 \\ 0 \\ 0 \end{bmatrix} \right\}, \left\{ \begin{bmatrix} 0 \\ 0 \\ 0 \end{bmatrix}, \begin{bmatrix} 0 \\ 1 \\ 0 \end{bmatrix} \right\}, \left\{ \begin{bmatrix} 0 \\ 0 \\ 0 \end{bmatrix}, \begin{bmatrix} 0 \\ 2 \\ 0 \end{bmatrix} \right\}, \left\{ \begin{bmatrix} 0 \\ 0 \\ 0 \end{bmatrix}, \begin{bmatrix} 1 \\ 0 \\ 1 \end{bmatrix} \right\}, \right.$$

$$\left. \left\{ \begin{bmatrix} 0 \\ 0 \\ 0 \end{bmatrix}, \begin{bmatrix} 2 \\ 0 \\ 2 \end{bmatrix} \right\}, \left\{ \begin{bmatrix} 0 \\ 0 \\ 0 \end{bmatrix}, \begin{bmatrix} 0 \\ 1 \\ 0 \end{bmatrix}, \begin{bmatrix} 1 \\ 0 \\ 1 \end{bmatrix} \right\}, \left\{ \begin{bmatrix} 0 \\ 0 \\ 0 \end{bmatrix}, \begin{bmatrix} 0 \\ 1 \\ 0 \end{bmatrix}, \begin{bmatrix} 2 \\ 0 \\ 2 \end{bmatrix} \right\}, \right.$$

$$\left. \left\{ \begin{bmatrix} 0 \\ 0 \\ 0 \end{bmatrix}, \begin{bmatrix} 0 \\ 1 \\ 0 \end{bmatrix}, \begin{bmatrix} 2 \\ 0 \\ 2 \end{bmatrix} \right\}, \left\{ \begin{bmatrix} 0 \\ 0 \\ 0 \end{bmatrix}, \begin{bmatrix} 0 \\ 1 \\ 2 \end{bmatrix}, \begin{bmatrix} 0 \\ 0 \\ 1 \end{bmatrix} \right\}, \right.$$

$$\left. \left\{ \begin{bmatrix} 0 \\ 0 \\ 0 \end{bmatrix}, \begin{bmatrix} 0 \\ 1 \\ 2 \end{bmatrix}, \begin{bmatrix} 0 \\ 0 \\ 2 \end{bmatrix} \right\}, \dots, \left\{ \begin{bmatrix} 0 \\ 0 \\ 0 \end{bmatrix}, \begin{bmatrix} 0 \\ 1 \\ 2 \end{bmatrix}, \begin{bmatrix} 2 \\ 0 \\ 2 \end{bmatrix}, \begin{bmatrix} 0 \\ 0 \\ 1 \end{bmatrix} \right\} \right\}.$$

We now give the lattice associated with T_1 .

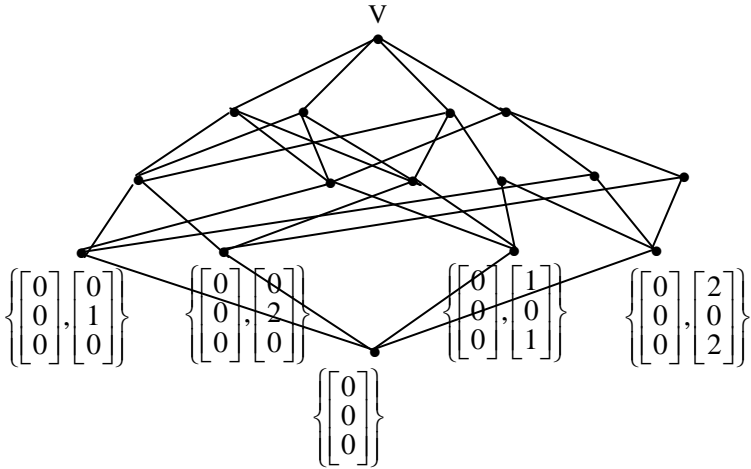

We see the resultant lattice is a Boolean algebra of order 2^4 . We have set group subtopological vectors subspaces of T_1 given by

$$S_1 = \left\{ \begin{bmatrix} 0 \\ 0 \\ 0 \end{bmatrix}, \begin{bmatrix} 0 \\ 0 \\ 0 \end{bmatrix}, \begin{bmatrix} 0 \\ 1 \\ 0 \end{bmatrix}, \begin{bmatrix} 0 \\ 2 \\ 0 \end{bmatrix} \right\}, \subseteq T_1.$$

The lattice associated with S_1 is as follows:

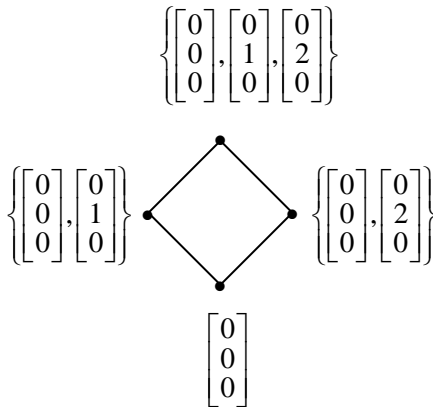

$$\begin{aligned}
 S_2 = & \left\{ \left\{ \begin{bmatrix} 0 \\ 0 \\ 0 \end{bmatrix} \right\}, \left\{ \begin{bmatrix} 0 \\ 0 \\ 0 \end{bmatrix}, \begin{bmatrix} 0 \\ 1 \\ 2 \end{bmatrix} \right\}, \left\{ \begin{bmatrix} 0 \\ 0 \\ 0 \end{bmatrix}, \begin{bmatrix} 1 \\ 0 \\ 1 \end{bmatrix} \right\}, \left\{ \begin{bmatrix} 0 \\ 0 \\ 0 \end{bmatrix}, \begin{bmatrix} 2 \\ 0 \\ 2 \end{bmatrix} \right\}, \\
 & \left\{ \begin{bmatrix} 0 \\ 0 \\ 0 \end{bmatrix}, \begin{bmatrix} 1 \\ 0 \\ 0 \end{bmatrix}, \begin{bmatrix} 2 \\ 0 \\ 2 \end{bmatrix} \right\}, \left\{ \begin{bmatrix} 0 \\ 0 \\ 0 \end{bmatrix}, \begin{bmatrix} 1 \\ 0 \\ 1 \end{bmatrix}, \begin{bmatrix} 0 \\ 1 \\ 2 \end{bmatrix} \right\}, \\
 & \left\{ \begin{bmatrix} 0 \\ 0 \\ 0 \end{bmatrix}, \begin{bmatrix} 2 \\ 0 \\ 2 \end{bmatrix}, \begin{bmatrix} 0 \\ 1 \\ 0 \end{bmatrix}, \begin{bmatrix} 0 \\ 1 \\ 2 \end{bmatrix} \right\}, V \}.
 \end{aligned}$$

The lattice associated with S_2 is as follows:

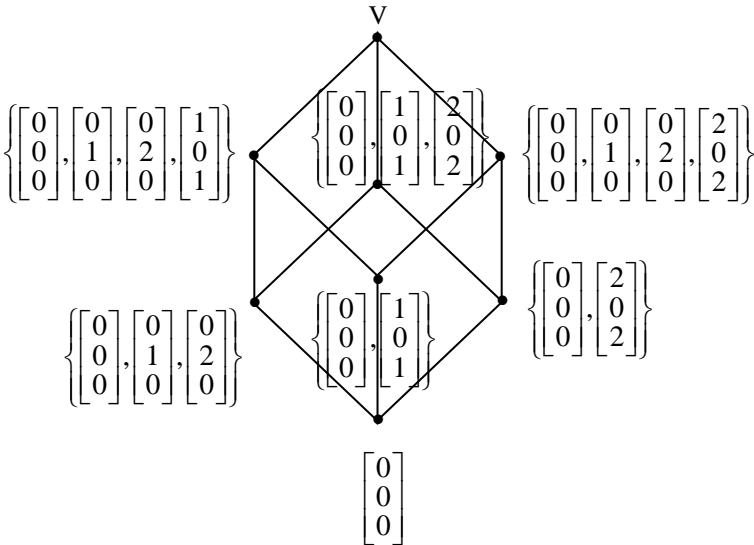

We see the lattice related with S_2 is a Boolean algebra of order 8. We can have several such set group subtopological vector subspaces of T_1 .

$$\text{Take } S_2 = \left\{ \left\{ \begin{bmatrix} 0 \\ 0 \\ 0 \end{bmatrix} \right\}, \left\{ \begin{bmatrix} 0 \\ 0 \\ 0 \end{bmatrix}, \begin{bmatrix} 1 \\ 0 \\ 1 \end{bmatrix} \right\} \right\} \subseteq T_1 \text{ is also a set group}$$

subtopological vector subspace of T_1 given by $\left\{ \begin{bmatrix} 0 \\ 0 \\ 0 \end{bmatrix}, \begin{bmatrix} 1 \\ 0 \\ 1 \end{bmatrix} \right\}$.

$$\begin{array}{c} \left\{ \begin{bmatrix} 0 \\ 0 \\ 0 \end{bmatrix}, \begin{bmatrix} 1 \\ 0 \\ 1 \end{bmatrix} \right\} \\ \vdots \\ \begin{bmatrix} 0 \\ 0 \\ 0 \end{bmatrix} \end{array}$$

Example 4.52: Let

$$V = \left\{ \begin{bmatrix} a & 0 & 0 \\ 0 & 0 & 0 \end{bmatrix}, \begin{bmatrix} 0 & b & 0 \\ 0 & 0 & 0 \end{bmatrix}, \begin{bmatrix} 0 & 0 & 0 \\ 0 & 0 & 0 \end{bmatrix}, \begin{bmatrix} 0 & 0 & d \\ 0 & d & 0 \end{bmatrix} \right\}$$

$$a, b, d \in \mathbb{Z}_6$$

be a group vector space over the group $G = (\mathbb{Z}_6, +)$.

Let $P = \{0, 2, 5\} \subseteq \mathbb{Z}_6$ be a proper subset of V .

The set group vector subspace of V over the set P are as follows:

$$S_1 = \left\{ \begin{bmatrix} 0 & 0 & 0 \\ 0 & 0 & 0 \end{bmatrix} \right\},$$

$$S_2 = \left\{ \begin{bmatrix} 0 & 0 & 0 \\ 0 & 0 & 0 \end{bmatrix}, \begin{bmatrix} 4 & 0 & 0 \\ 0 & 0 & 4 \end{bmatrix}, \begin{bmatrix} 1 & 0 & 0 \\ 0 & 0 & 1 \end{bmatrix}, \right. \\ \left. \begin{bmatrix} 2 & 0 & 0 \\ 0 & 0 & 2 \end{bmatrix}, \begin{bmatrix} 5 & 0 & 0 \\ 0 & 0 & 5 \end{bmatrix} \right\},$$

$$S_3 = \left\{ \begin{bmatrix} 3 & 0 & 0 \\ 0 & 0 & 3 \end{bmatrix}, \begin{bmatrix} 0 & 0 & 0 \\ 0 & 0 & 0 \end{bmatrix} \right\},$$

$$S_4 = \left\{ \begin{bmatrix} 0 & 0 & 0 \\ 0 & 0 & 0 \end{bmatrix}, \begin{bmatrix} 0 & 1 & 0 \\ 1 & 0 & 0 \end{bmatrix}, \begin{bmatrix} 0 & 2 & 0 \\ 2 & 0 & 0 \end{bmatrix}, \right. \\ \left. \begin{bmatrix} 0 & 4 & 0 \\ 4 & 0 & 0 \end{bmatrix}, \begin{bmatrix} 0 & 5 & 0 \\ 5 & 0 & 0 \end{bmatrix} \right\},$$

$$S_6 = \left\{ \begin{bmatrix} 0 & 0 & 0 \\ 0 & 0 & 0 \end{bmatrix}, \begin{bmatrix} 0 & 3 & 0 \\ 3 & 0 & 0 \end{bmatrix} \right\},$$

$$S_7 = \left\{ \begin{bmatrix} 0 & 0 & 0 \\ 0 & 0 & 0 \end{bmatrix}, \begin{bmatrix} 0 & 0 & 1 \\ 0 & 1 & 0 \end{bmatrix}, \begin{bmatrix} 0 & 0 & 2 \\ 0 & 2 & 0 \end{bmatrix}, \right. \\ \left. \begin{bmatrix} 0 & 0 & 4 \\ 0 & 4 & 0 \end{bmatrix}, \begin{bmatrix} 0 & 0 & 5 \\ 0 & 5 & 0 \end{bmatrix} \right\} \text{ and}$$

$$S_8 = \left\{ \begin{bmatrix} 0 & 0 & 0 \\ 0 & 0 & 0 \end{bmatrix}, \begin{bmatrix} 0 & 0 & 3 \\ 0 & 3 & 0 \end{bmatrix} \right\}.$$

We see S_2, \dots, S_8 generate the set group topological vector subspace T of V over the set $P = \{0, 2, 5\} \subseteq Z_6$.

The lattice associated with the set group topological vector subspace T of V over P is as follows:

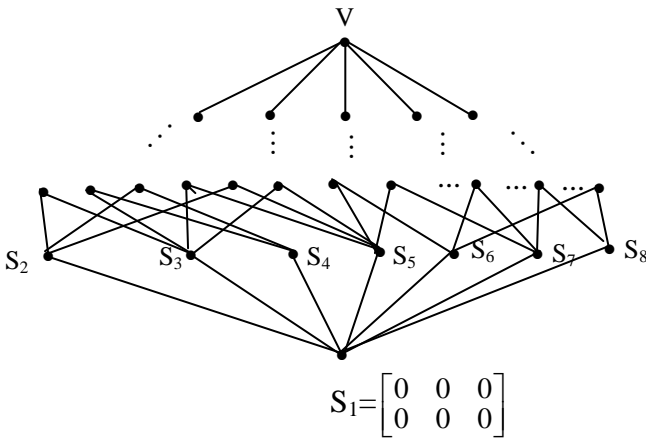

We see the lattice associated with T is only a Boolean algebra of order 2^7 .

Thus T is a finite set group topological vector subspace of V over P .

Suppose we change P to P_1 say $P_1 = \{0, 1, 2, 5\}$ we see the set group topological vector subspace associated with the set P_1 is identical with that of P and both the sets give the same topological space.

However if $P_2 = \{0, 2, 5, 3\} \subseteq Z_6$, we see the set group topological vector subspace of V associated with T_2 is different

from that of the set group topological vector subspace associated with the set P_1 .

Another interesting observations from our study is that if we increase the cardinality of the set over which the set group topological vector subspace is defined than in general the number of elements in the topological space becomes less (Here the number of elements in V is assumed to be finite).

We complete this chapter with the following example where the number of elements in V is infinite.

Example 4.53: Let $V = \{(0, 0), (a, 0), (0, b) \mid a, b \in \mathbb{Z}\}$ be a group vector space over the group $G = \mathbb{Z}$.

Now we find the set group topological vector subspace associated with the set $P = \{0, 1\}$. Let $T = \{\text{collection of all set group topological vector subspaces of } V \text{ over the set } P = \{0, 1\}\}$.

The basic set of T is infinite. For $\{(0, 0)\}$ is the least element and the basic set $\{\{0, 0\}, \{(0, 0), (1, 0)\}, \{(0, 0), (-1, 0)\}, \{(0, 0), (2, 0)\}, \{(0, 0), (-2, 0)\}, \dots, \{(0, 0), (n, 0)\}, \{(0, 0), (-n, 0)\}, \dots, \{(0, 0), (0, 1)\}, \{(0, 0), (0, -1)\}, \{(0, 0), (0, 2)\}, \{(0, 0), (0, -2)\}, \dots, \{(0, 0), (0, n)\}, \{(0, 0), (0, -n)\}, \dots\}$.

Thus the lattice associated with T will be an infinite Boolean algebra.

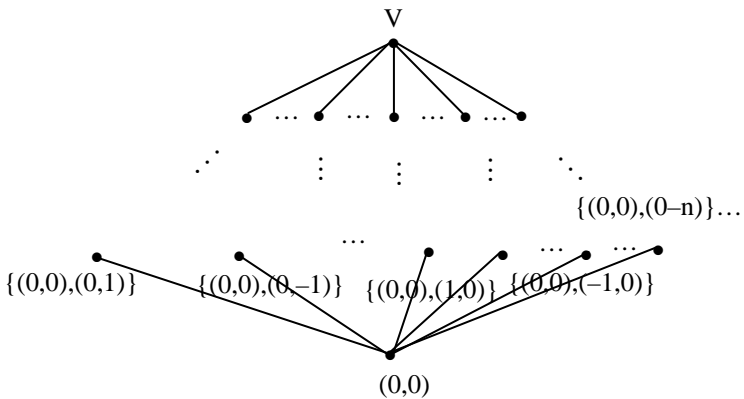

Chapter Five

APPLICATIONS OF SETS TO SET CODES

In this chapter we for the first time introduce a special class of set codes and give a few properties enjoyed by them. Throughout this chapter we assume the set codes are defined over the set $S = \{0, 1\} = \mathbb{Z}_2$, i.e., all code words have only binary symbols. We now proceed on to define the notion of set codes.

DEFINITION 5.1 : *Let $C = \{(x_1 \dots x_{r_1}), (x_1 \dots x_{r_2}), \dots, (x_1 \dots x_{r_n})\}$ be a set of (r_1, \dots, r_n) tuples with entries from the set $S = \{0, 1\}$ where each r_i -tuple (x_1, \dots, x_{r_i}) has some k_i message symbols and $r_i - k_i$ check symbols $1 \leq i \leq n$. We call C the set code if C is a set vector space over the set $S = \{0, 1\}$.*

The following will help the reader to understand more about these set codes.

1. $r_i = r_j$ even if $i \neq j$; $1 \leq i, j \leq n$
2. $k_i = k_j$ even if $i \neq j$; $1 \leq i, j \leq n$
3. Atleast some $r_i \neq r_t$ when $i \neq t$; $1 \leq i, t \leq n$.

We first illustrate this by some examples before we proceed onto give more properties about the set codes.

Example 5.1: Let $C = \{(0\ 1\ 1\ 0), (0\ 0\ 0\ 1), (1\ 1\ 0\ 1), (1\ 1\ 1\ 1\ 1\ 1), (0\ 0\ 0\ 0\ 0\ 0), (1\ 0\ 1\ 0\ 1\ 0), (0\ 1\ 0\ 1\ 0\ 1), (0\ 0\ 0\ 0)\}$. C is also a set code over the set $S = \{0, 1\}$.

We see the set codes will have code words of varying lengths. We call the elements of the set code as set code words. In general for any set code C we can have set code words of varying lengths. As in case of usual binary codes we do not demand the length of every code word to be of same length.

Further as in case of usual codes we do not demand the elements of the set codes to form a subgroup i.e., they do not form a group or a subspace of a finite dimensional vector space. They are just collection of (r_1, \dots, r_n) tuples with no proper usual algebraic structure.

Example 5.2: Let $C = \{(1\ 1\ 1), (0\ 0\ 0), (1\ 1\ 1\ 1\ 1\ 1), (0\ 0\ 0\ 0\ 0\ 0), (1\ 1\ 1\ 1\ 1\ 1\ 1), (0\ 0\ 0\ 0\ 0\ 0\ 0)\}$ be a set code over the set $S = \{0, 1\}$.

Now we give a special algebraic structure enjoyed by these set codes.

DEFINITION 5.2: Let $C = \{(x_1 \dots x_{r_1}), \dots, (x_1 \dots x_{r_n})\}$ be a set code over the set $S = \{0, 1\}$ where $x_i \in \{0, 1\}$; $1 \leq i \leq r_i, \dots, r_n$. We demand a set of matrices $H = \{H_1, \dots, H_t \mid H_i \text{ takes its entries from the set } \{0, 1\}\}$ and each set code word $x \in C$ is such that there is some matrix $H_i \in H$ with $H_i x^t = 0, 1 < i < t$. We do not demand the same H_i to satisfy this relation for every set code word from C .

Further the set $H = \{H_1, \dots, H_t\}$ will not form a set vector space over the set $\{0,1\}$. This set H is defined as the set parity check matrices for the set code C .

We illustrate this by an example.

Example 5.3: Let $V = \{(1\ 1\ 1\ 0\ 0\ 0), (1\ 0\ 1\ 1\ 0\ 1), (0\ 0\ 0\ 0\ 0\ 0), (0\ 1\ 1\ 0\ 1\ 1), (1\ 0\ 1\ 1), (0\ 0\ 0\ 0), (1\ 1\ 1\ 0)\}$ be a set code. The set parity check matrix associated with V is given by

$$H = \{H_1, H_2\} =$$

$$\{H_1 = \begin{pmatrix} 0 & 1 & 1 & 1 & 0 & 0 \\ 1 & 0 & 1 & 0 & 1 & 0 \\ 1 & 1 & 0 & 0 & 0 & 1 \end{pmatrix},$$

and

$$H_2 = \begin{pmatrix} 1 & 0 & 1 & 0 \\ 1 & 1 & 0 & 1 \end{pmatrix}.$$

The following facts are important to be recorded.

- (1) As in case of the ordinary code we don't use parity check matrix to get all the code words using the message symbols. Infact the set parity check matrix is used only to find whether the received code word is correct or error is present.
- (2) Clearly V , the set code does not contain in general all the code words associated with the set parity check matrix H .
- (3) The set codes are just set, it is not compatible even under addition of code words. They are just codes as they cannot be added for one set code word may be of length r_1 and another of length r_2 ; $r_1 \neq r_2$.
- (4) The set codes are handy when one intends to send messages of varying lengths simultaneously.

Example 5.4: Let $V = \{(0\ 0\ 0\ 0\ 0\ 0\ 0\ 0), (1\ 1\ 1\ 1\ 1\ 1\ 1\ 1), (1\ 1\ 1\ 1\ 1), (0\ 0\ 0\ 0\ 0), (1\ 1\ 1\ 1), (0\ 0\ 0\ 0)\}$ be a set code with set parity check matrix

$$H = \left\{ \begin{pmatrix} 1 & 1 & 0 & 0 & 0 & 0 & 0 & 0 \\ 1 & 0 & 1 & 0 & 0 & 0 & 0 & 0 \\ 1 & 0 & 0 & 1 & 0 & 0 & 0 & 0 \\ 1 & 0 & 0 & 0 & 1 & 0 & 0 & 0 \\ 1 & 0 & 0 & 0 & 0 & 1 & 0 & 0 \\ 1 & 0 & 0 & 0 & 0 & 0 & 1 & 0 \\ 1 & 0 & 0 & 0 & 0 & 0 & 0 & 1 \end{pmatrix} \right\},$$

$$\begin{pmatrix} 1 & 1 & 0 & 0 & 0 & 0 \\ 1 & 0 & 1 & 0 & 0 & 0 \\ 1 & 0 & 0 & 1 & 0 & 0 \\ 1 & 0 & 0 & 0 & 1 & 0 \\ 1 & 0 & 0 & 0 & 0 & 1 \end{pmatrix}$$

and

$$\left. \begin{pmatrix} 1 & 1 & 0 & 0 & 0 \\ 1 & 0 & 1 & 0 & 0 \\ 1 & 0 & 0 & 1 & 0 \\ 1 & 0 & 0 & 0 & 1 \end{pmatrix} \right\}.$$

Now having defined set codes we make the definition of special classes of set codes.

DEFINITION 5.3: Let $V = \{(y_1, \dots, y_{r_t}), (x_1, \dots, x_{r_t}) \mid y_i = 0, 1 \leq i \leq r_t; x_i = 1, 1 \leq i \leq r_t \text{ and } t = 1, 2, \dots, n\}$ be a set code where either each of the tuples are zeros or ones. The set parity check matrix $H = \{H_1, \dots, H_n\}$ where H_i is a $(r_i - 1) \times r_i$ matrix of the form;

$$\begin{pmatrix} 1 & 1 & 0 & \dots & 0 \\ 1 & 0 & 1 & \dots & 0 \\ \vdots & \vdots & \vdots & & \vdots \\ 1 & 0 & 0 & \dots & 1 \end{pmatrix}$$

where first column has only ones and the rest is a $(r_i - 1) \times (r_i - 1)$ identity matrix; $i = 1, 2, \dots, n$. We call this set code as the repetition set code.

We illustrate this by some examples.

Example 5.5: Let $V = \{(0\ 0\ 0\ 0), (1\ 1\ 1\ 1), (1\ 1\ 1\ 1\ 1\ 1), (0\ 0\ 0\ 0\ 0\ 0), (1\ 1\ 1\ 1\ 1\ 1\ 1\ 1\ 1\ 1), (0\ 0\ 0\ 0\ 0\ 0\ 0\ 0\ 0\ 0), (1\ 1\ 1\ 1\ 1\ 1\ 1\ 1), (0\ 0\ 0\ 0\ 0\ 0\ 0\ 0)\}$ be a set code with set parity check matrix $H = \{H_1, H_2, H_3, H_4\}$ where

$$H_1 = \begin{pmatrix} 1 & 1 & 0 & 0 & 0 \\ 1 & 0 & 1 & 0 & 0 \\ 1 & 0 & 0 & 1 & 0 \\ 1 & 0 & 0 & 0 & 1 \end{pmatrix},$$

$$H_2 = \begin{pmatrix} 1 & 1 & 0 & 0 & 0 & 0 & 0 \\ 1 & 0 & 1 & 0 & 0 & 0 & 0 \\ 1 & 0 & 0 & 1 & 0 & 0 & 0 \\ 1 & 0 & 0 & 0 & 1 & 0 & 0 \\ 1 & 0 & 0 & 0 & 0 & 1 & 0 \\ 1 & 0 & 0 & 0 & 0 & 0 & 1 \end{pmatrix},$$

$$H_3 = \begin{pmatrix} 1 & 1 & 0 & 0 & 0 & 0 & 0 & 0 & 0 & 0 \\ 1 & 0 & 1 & 0 & 0 & 0 & 0 & 0 & 0 & 0 \\ 1 & 0 & 0 & 1 & 0 & 0 & 0 & 0 & 0 & 0 \\ 1 & 0 & 0 & 0 & 1 & 0 & 0 & 0 & 0 & 0 \\ 1 & 0 & 0 & 0 & 0 & 1 & 0 & 0 & 0 & 0 \\ 1 & 0 & 0 & 0 & 0 & 0 & 1 & 0 & 0 & 0 \\ 1 & 0 & 0 & 0 & 0 & 0 & 0 & 1 & 0 & 0 \\ 1 & 0 & 0 & 0 & 0 & 0 & 0 & 0 & 1 & 0 \\ 1 & 0 & 0 & 0 & 0 & 0 & 0 & 0 & 0 & 1 \end{pmatrix}$$

and

$$H_4 = \begin{pmatrix} 1 & 1 & 0 & 0 & 0 & 0 & 0 & 0 \\ 1 & 0 & 1 & 0 & 0 & 0 & 0 & 0 \\ 1 & 0 & 0 & 1 & 0 & 0 & 0 & 0 \\ 1 & 0 & 0 & 0 & 1 & 0 & 0 & 0 \\ 1 & 0 & 0 & 0 & 0 & 1 & 0 & 0 \\ 1 & 0 & 0 & 0 & 0 & 0 & 1 & 0 \\ 1 & 0 & 0 & 0 & 0 & 0 & 0 & 1 \end{pmatrix}.$$

V is a repetition set code.

DEFINITION 5.4: Let $V = \{\text{Some set of code words from the binary } (n_i, n_i - 1) \text{ code; } i = 1, 2, \dots, t\}$ with set parity check matrix

$$\begin{aligned} H &= \{H_1, \dots, H_t\} \\ &= \{(1\ 1\ 1\ \dots\ 1), (1\ 1\ \dots\ 1), \dots, (1\ 1\ \dots\ 1)\}; \end{aligned}$$

t set of some n_i tuples with ones; $i = 1, 2, \dots, t$. We call V the parity check set code.

We illustrate this by some examples.

Example 5.6: Let $V = \{(1\ 1\ 1\ 1\ 1\ 1\ 0), (1\ 1\ 0\ 0\ 0\ 1\ 1), (1\ 0\ 0\ 0\ 0\ 0\ 1), (0\ 0\ 0\ 0\ 0\ 0\ 0), (1\ 1\ 1\ 1\ 0\ 0\ 0\ 0\ 0), (1\ 1\ 1\ 1\ 1\ 1\ 0\ 0\ 0), (0\ 0\ 0\ 0\ 0\ 0\ 0\ 0\ 0), (1\ 1\ 0\ 0\ 1\ 1\ 0\ 1\ 1), (1\ 1\ 1\ 1\ 0\ 0), (1\ 1\ 0\ 0\ 1\ 1), (1\ 0\ 0\ 0\ 0\ 1), (0\ 0\ 0\ 0\ 0\ 0)\}$ be the set code with set parity check matrix $H = \{H_1, H_2, H_3\}$ where $H_1 = (1\ 1\ 1\ 1\ 1\ 1\ 1)$, $H_2 = (1\ 1\ 1\ 1\ 1\ 1\ 1\ 1)$ and $H_3 = (1\ 1\ 1\ 1\ 1\ 1)$. V is clearly a parity check set code.

Now we proceed onto define the notion of Hamming distance in set codes.

DEFINITION 5.5: Let $V = \{X_1, \dots, X_n\}$ be a set code. The set Hamming distance between two vectors X_i and X_j in V is defined if and only if both X_i and X_j have same number of entries and $d(X_i, X_j)$ is the number of coordinates in which X_i and X_j differ.

The set Hamming weight $\alpha(X_i)$ of a set vector X_i is the number of non zero coordinates in X_i . In short $\alpha(X_i) = d(X_i, 0)$.

Thus it is important to note that as in case of codes in set codes we cannot find the distance between any set codes. The distance between any two set code words is defined if and only if the length of both the set codes is the same.

We first illustrate this situation by the following example.

DEFINITION 5.6: Let $V = \{X_1, \dots, X_n\}$ be a set code with set parity check matrix $H = \{H_1, \dots, H_p\}$ where each H_t is a $m_t \times (2^{m_t} - 1)$ parity check matrix whose columns consists of all non zero binary vectors of length m_t . We don't demand all code words associated with each H_t to be present in V , only a choosen few alone are present in V ; $1 \leq t \leq p$. We call this V as the binary Hamming set code.

We illustrate this by some simple examples.

Example 5.7: Let $V = \{(0\ 0\ 0\ 0\ 0\ 0\ 0), (1\ 0\ 0\ 1\ 1\ 0\ 1), (0\ 1\ 0\ 1\ 0\ 1\ 1), (0\ 0\ 0\ 0\ 0\ 0\ 0\ 0\ 0\ 0\ 0\ 0\ 0\ 0), (1\ 0\ 0\ 0\ 1\ 0\ 0\ 1\ 1\ 0\ 1\ 0\ 1\ 1\ 1)\}$

1), (0 0 0 1 0 0 1 1 0 1 0 1 1 1 1)} be a set code with set parity check matrix $H = (H_1, H_2)$ where

$$H_1 = \begin{pmatrix} 1 & 0 & 0 & 1 & 1 & 0 & 1 \\ 0 & 1 & 0 & 1 & 0 & 1 & 1 \\ 0 & 0 & 1 & 0 & 1 & 1 & 1 \end{pmatrix}$$

and

$$H_2 = \begin{pmatrix} 1 & 0 & 0 & 0 & 1 & 0 & 0 & 1 & 1 & 0 & 1 & 0 & 1 & 1 & 1 \\ 0 & 1 & 0 & 0 & 1 & 1 & 0 & 1 & 0 & 1 & 1 & 1 & 1 & 0 & 0 \\ 0 & 0 & 1 & 0 & 0 & 1 & 1 & 0 & 1 & 0 & 1 & 1 & 1 & 1 & 0 \\ 0 & 0 & 0 & 1 & 0 & 0 & 1 & 1 & 0 & 1 & 0 & 1 & 1 & 1 & 1 \end{pmatrix}.$$

Clearly V is a Hamming set code.

Now we proceed on to define the new class of codes called $m - \text{weight set code } (m \geq 2)$.

DEFINITION 5.7: Let $V = \{X_1, \dots, X_n\}$ be a set code with a set parity check matrix $H = \{H_1, \dots, H_t\}; t < n$. If the set Hamming weight of each and every X_i in V is $m, m < n$ and m is less than the least length of set code words in V . i.e., $\omega(X_i) = m$ for $i = 1, 2, \dots, n$ and $X_i \neq (0)$. Then we call V to be a m -weight set code.

These set codes will be useful in cryptology, in computers and in channels in which a minimum number of messages is to be preserved.

We will illustrate them by some examples.

Example 5.8: Let $V = \{(1 1 1 1 0 1), (1 1 1 1 1 0 0 0), (0 0 0 0 0 0 0 0), (0 0 0 0 0 0), (1 0 1 0 1 0 1 1), (1 1 0 0 1 1 1 0), (0 1 1 1 1 1), (1 1 1 0 1 1), (1 1 1 1 1 0 0), (0 0 1 1 1 1 1), (0 0 0 0 0 0 0)\}$. V is a set code which is a 5-weight set code.

Another usefulness of this m -weight set code is that these codes are such that the error is very quickly detected; they can

be used in places where several time transmission is possible. In places like passwords in e-mails, etc; these codes is best suited.

Now having defined m-weight set codes we now proceed on to define cyclic set codes.

DEFINITION 5.8: Let $V = \{x_1, \dots, x_n\}$ be n-set code word of varying length, if $x_i = (x_{i_1}, \dots, x_{i_n}) \in V$ then $(x_{i_n}, x_{i_1}, \dots, x_{i_{n-1}}) \in V$ for $1 \leq i \leq n$. Such set codes V are defined as cyclic set codes.

For cyclic set codes if $H = \{H_1, \dots, H_t\}$; $t < n$ is the set parity check matrix then we can also detect errors.

Now if in a set cyclic code we have weight of each set code word is m then we call such set codes as m weight cyclic set codes.

We now illustrate this by the following example.

DEFINITION 5.9: Let $V = \{X_1, \dots, X_n\}$ be a set code with associated set parity check matrix $H = \{H_1, \dots, H_t \mid t < n\}$. The dual set code (or the orthogonal set code) $V^\perp = \{Y_i \mid Y_i \cdot X_i = 0\}$ for all those $X_i \in V$; such that both X_i and Y_i are of same length in V .

Now it is important to see as in case of usual codes we can define orthogonality only between two vectors of same length alone.

We just illustrate this by an example.

DEFINITION 5.10: Let $V = \{X_1, \dots, X_n\}$ be a set code with a set parity check matrix $H = \{H_1, H_2, \dots, H_t \mid t < n\}$. We call a proper subset $S \subseteq V^\perp$ for which the weight of each set code word in S to be only m, as the m-weight dual set code of V . For this set code for error detection we do not require the set parity check matrix.

We illustrate this by some simple examples.

Example 5.9: Let $V = \{(0\ 0\ 0\ 0\ 0), (1\ 1\ 1\ 0\ 0), (0\ 0\ 1\ 1\ 1), (1\ 1\ 1\ 0\ 0\ 0), (0\ 0\ 0\ 0\ 0\ 0), (0\ 0\ 0\ 1\ 1\ 1), (0\ 1\ 0\ 1\ 0\ 1)\}$ be a set code.

The dual set code of weight 3 is given by $V^\perp = \{(0\ 0\ 0\ 0\ 0), (0\ 0\ 0\ 0\ 0), (0\ 1\ 1\ 1\ 0), (0\ 1\ 1\ 0\ 1), (1\ 0\ 1\ 0\ 1), (1\ 0\ 1\ 0\ 1)\}$. The advantage of using m-weight set code or m-weight dual set code is that they are set codes for which error can be detected very easily.

Because these codes do not involve high abstract concepts, they can be used by non-mathematicians. Further these codes can be used when retransmission is not a problem as well as one wants to do work at a very fast phase so that once a error is detected retransmission is requested. These set codes are such that only error detection is possible.

Error correction is not easy for all set codes, m-weight set codes are very simple class of set codes for which error detection is very easy. For in this case one need not even go to work with the set parity check matrix for error detection.

Yet another important use of these set codes is these can be used when one needs to use many different lengths of codes with varying number of message symbols and check symbols.

These set codes are best suited for cryptologists for they can easily mislead the intruder as well as each customer can have different length of code words. So it is not easy for the introducer to break the message for even gussing the very length of the set code word is very difficult.

Thus these set codes can find their use in cryptology or in places where extreme security is to be maintained or needed.

The only problem with these codes is error detection is possible but correction is not possible and in channels where retransmission is possible it is best suited. At a very short span

of time the error detection is made and retransmission is requested.

Now we proceed on to define yet another new class of set codes which we call as semigroup codes.

DEFINITION 5.11: Let $V = \{X_1, \dots, X_n\}$ be a set code over the semigroup $S = \{0, 1\}$. If the set of codes of same length form semigroups under addition with identity i.e., monoid, then $V = \{S_1, \dots, S_r \mid r < n\}$ is a semigroup code, here each S_i is a semigroup having elements as set code words of same length; $1 \leq i \leq r$. The elements of V are called semigroup code words.

We illustrate this by some examples.

Example 5.10: Let $V = \{(1\ 1\ 1\ 1\ 1\ 1), (0\ 0\ 0\ 0\ 0\ 0), (1\ 1\ 0\ 0\ 0), (0\ 0\ 0\ 0\ 0), (0\ 0\ 1\ 1\ 1), (1\ 1\ 1\ 1\ 1), (1\ 1\ 1\ 1\ 1\ 1\ 1), (0\ 0\ 0\ 0\ 0\ 0\ 0), (0\ 0\ 1\ 1\ 0\ 0\ 1), (1\ 1\ 0\ 0\ 1\ 1\ 0)\}$ be a semigroup code over $Z_2 = \{0, 1\}$. $V = \{S_1, S_2, S_3\}$ where $S_1 = \{(1\ 1\ 1\ 1\ 1\ 1), (0\ 0\ 0\ 0\ 0\ 0)\}$, $S_2 = \{(1\ 1\ 0\ 0\ 0), (0\ 0\ 0\ 0\ 0), (0\ 0\ 1\ 1\ 1), (1\ 1\ 1\ 1\ 1)\}$ and $S_3 = \{(1\ 1\ 1\ 1\ 1\ 1\ 1), (0\ 0\ 0\ 0\ 0\ 0\ 0), (0\ 0\ 1\ 1\ 0\ 0\ 1), (1\ 1\ 0\ 0\ 1\ 1\ 0)\}$ are monoids under addition.

THEOREM 5.1: Every set repetition code V is a semigroup code.

THEOREM 5.2: Every semigroup code is a set code and a set code in general is not a semigroup code.

Example 5.10: Let $V = \{(1\ 1\ 1\ 1\ 0), (0\ 0\ 0\ 0\ 0), (1\ 1\ 0\ 0\ 1), (1\ 0\ 0\ 0\ 1), (1\ 1\ 1\ 1\ 1\ 1\ 1), (0\ 0\ 0\ 0\ 0\ 0\ 0), (1\ 1\ 0\ 0\ 0\ 0\ 0\ 0), (0\ 0\ 0\ 0\ 0\ 0\ 1\ 1)\}$ be a set code over the set $\{0, 1\}$. Clearly V is not a semigroup code for $(1\ 1\ 0\ 0\ 1), (1\ 0\ 0\ 0\ 1) \in V$ but $(1\ 1\ 0\ 0\ 1) + (1\ 0\ 0\ 0\ 1) = (0\ 1\ 0\ 0\ 0) \notin V$. Hence the claim.

We can with a semigroup code $V = \{X_1, \dots, X_n\}$, associate a set parity check matrix $H = \{H_1, H_2, \dots, H_r \mid r < n\}$. Here also the set parity check matrix only serves the purpose for error detection we do not use it to get all set code words for we do not

use the group of code words. We use only a section of them which forms a semigroup.

Now as in case of set codes even in case of semigroup codes we can define m-weight semigroup code.

DEFINITION 5.12: Let $V = \{X_1, \dots, X_n\} = \{S_1, \dots, S_r \mid r < n\}$ be a semigroup code if Hamming weight of each semigroup code is just only m then we call V to be a m -weight semigroup code.

We illustrate this by some examples.

THEOREM 5.3: Let $V = \{X_1, \dots, X_n\} = \{S_1, S_2, \dots, S_r \mid r < n\}$ be a semigroup code. If V is a semigroup repetition code then V is not a m -weight semigroup code for any positive integer m .

DEFINITION 5.13: Let $V = \{X_1, \dots, X_n\} = \{S_1, \dots, S_r \mid r < n\}$ be a semigroup code where each S_i is a semigroup of the parity check binary $(n_i, n_i - 1)$ code, $i = 1, 2, \dots, r$. Then we call V to be a semigroup parity check code and the set parity check matrix $H = \{H_1, \dots, H_r\}$ is such that

$$H_i = \underbrace{(1 \quad 1 \quad \dots \quad 1)}_{n_i \text{-times}} ; i = 1, 2, \dots, r.$$

We illustrate this by the following example.

DEFINITION 5.14: Let $S = \{X_1, \dots, X_n\} = \{S_1, \dots, S_r \mid r < n\}$ be a semigroup code over $\{0, 1\}$. The dual or orthogonal semigroup code S^\perp of S is defined by $S^\perp = \{S_1^\perp, \dots, S_r^\perp ; r < n\}$ $S_i^\perp = \{s \mid s_i \cdot s = 0 \text{ for all } s_i \in S_i\}$; $1 \leq i \leq r$. The first fact to study about is will S^\perp also be a semigroup code. Clearly S^\perp is a set code. If $x, y \in S_i^\perp$ then $x \cdot s_i = 0$ for all $s_i \in S_i$ and $y \cdot s_i = 0$ for all $s_i \in S_i$. To prove $(x + y) \cdot s_i = 0$ i.e., $(x + y) \in S_i^\perp$. At this point one cannot always predict that the closure axiom will be satisfied by S_i^\perp , $1 \leq i \leq r$.

We first atleast study some examples.

DEFINITION 5.15: Let $S = \{X_1, \dots, X_n\} = \{S_1, \dots, S_r \mid r < n\}$ be a semigroup code if each of code words in S_i are cyclic where S_i is a semigroup under addition with identity, for each i ; $1 \leq i \leq r$, then we call S to be a semigroup cyclic code.

We now try to find some examples to show the class of semigroup cyclic codes is non empty.

THEOREM 5.4: Let $V = \{X_1, \dots, X_n\} = \{S_1, \dots, S_{n/2}\}$ be the semigroup repetition code, V is a semigroup cyclic code.

DEFINITION 5.16: Let $V = \{X_1, \dots, X_n\}$ be a set code if $V = \{G_1, \dots, G_k \mid k < n\}$ where each G_i is a collection of code words which forms a group under addition then we call V to be a group code over the group $Z_2 = \{0,1\}$.

We illustrate this situation by the following examples.

Example 5.11: Let $V = \{(1\ 1\ 1\ 1\ 1\ 1\ 1), (0\ 0\ 0\ 0\ 0\ 0\ 0), (1\ 1\ 0\ 0\ 0\ 0), (1\ 0\ 0\ 0\ 0\ 0), (0\ 1\ 0\ 0\ 0\ 0), (0\ 0\ 0\ 0\ 0\ 0), (1\ 1\ 0\ 0\ 1), (0\ 0\ 1\ 1\ 0), (1\ 1\ 1\ 1\ 1), (0\ 0\ 0\ 0\ 0)\}$ be a group code over Z_2 .

Clearly $V = \{G_1, G_2, G_3\}$ where $G_1 = \{(1\ 1\ 1\ 1\ 1\ 1\ 1), (0\ 0\ 0\ 0\ 0\ 0\ 0)\} \subseteq Z_2^7$. $G_2 = \{(1\ 1\ 0\ 0\ 0\ 0), (1\ 0\ 0\ 0\ 0\ 0), (0\ 1\ 0\ 0\ 0\ 0), (0\ 0\ 0\ 0\ 0\ 0)\} \subseteq Z_2^6$ and $G_3 = \{(1\ 1\ 1\ 1\ 1), (0\ 0\ 0\ 0\ 0), (1\ 1\ 0\ 0\ 1), (0\ 0\ 1\ 1\ 0)\} \subseteq Z_2^5$ are groups and the respective subgroups of Z_2^7 , Z_2^6 and Z_2^5 respectively.

This subgroup property helps the user to adopt coset leader method to correct the errors. However the errors are detected using set parity check matrices.

All group codes are semigroup codes and semigroup codes are set codes.

But in general all the set codes need not be a semigroup code or a group code. In view of this we prove the following theorem.

THEOREM 5.5: *Let V be a set code V in general need not be a group code.*

THEOREM 5.6: *Let V be a set repetition code then V is a group code.*

DEFINITION 5.17: *Let $V = \{X_1, \dots, X_n\} = \{G_1, \dots, G_{n/2}\}$ where V is a set repetition code. Clearly V is a group code. We call V to be the group repetition code.*

The following facts are interesting about these group repetition code.

1. Every set repetition code is a group repetition code.
2. Every group repetition code is of only even order.
3. The error detection and correction is very easily carried out.

If $X_i \in V$ is a length n_i , if the number of ones in X_i is less than $n_i/2$ then we accept $X_i = (0\ 0 \dots 0\ 0)$.

If the number of ones in X_i is greater than $n_i/2$ then we accept $X_i = (1\ 1 \dots 1)$. Thus the easy way for both error correction and error detection is possible.

Now we proceed on to describe group parity check code and group Hamming code.

DEFINITION 5.18: Let $V = \{X_1, \dots, X_n\}$ be a group code if $H = \{H_1, \dots, H_r \mid r < n\}$ be the associated set parity check matrix where each H_i is of the form

$$\underbrace{(1 \ 1 \ \dots \ 1)}_{n_i \text{-times}}$$

$1 < i < r$. i.e., $V = \{G_1, \dots, G_r \mid r < n\}$ and each G_i is a set of code words of same length n_i and forms a group under addition modulo 2; then V is defined as the group parity check code.

We now illustrate this by the following example.

DEFINITION 5.19: Let $V = \{X_1, \dots, X_n\} = \{G_1, \dots, G_r \mid r < n\}$ be a group code. If each G_i is a Hamming code with parity check matrix H_i , $i = 1, 2, \dots, r$ i.e., of the set parity check matrix $H = \{H_1, H_2, \dots, H_r\}$, then we call V to be a group Hamming code or Hamming group code.

We now illustrate this situation by few examples.

Example 5.12: Let $V = \{(0000000000000000), (100010011010111), (010011010111100), (1100001001101011), (00000000), (1001101), (0101011), (1100110), (0010111), (0111100), (1110001), (1011010)\}$ be a Hamming group code with set parity check matrix $H = \{H_1, H_2\}$ where

$$H_1 = \begin{pmatrix} 1 & 0 & 0 & 0 & 1 & 0 & 0 & 1 & 1 & 0 & 1 & 0 & 1 & 1 & 1 \\ 0 & 1 & 0 & 0 & 1 & 1 & 0 & 1 & 0 & 1 & 1 & 1 & 1 & 0 & 0 \\ 0 & 0 & 1 & 0 & 0 & 1 & 1 & 0 & 1 & 0 & 1 & 1 & 1 & 1 & 0 \\ 0 & 0 & 0 & 1 & 0 & 0 & 1 & 1 & 0 & 1 & 0 & 1 & 1 & 1 & 1 \end{pmatrix}$$

and

$$H_2 = \begin{pmatrix} 1 & 0 & 0 & 1 & 1 & 0 & 1 \\ 0 & 1 & 0 & 1 & 0 & 1 & 1 \\ 0 & 0 & 1 & 0 & 1 & 1 & 1 \end{pmatrix}.$$

Thus $V = \{G_1, G_2\}$ where G_1 and G_2 are groups given by $G_1 = \{(0\ 0\ 0\ 0\ 0\ 0\ 0\ 0\ 0\ 0\ 0\ 0\ 0\ 0\ 0\ 0), (1\ 0\ 0\ 0\ 1\ 0\ 0\ 1\ 1\ 0\ 1\ 0\ 1\ 1\ 1), (0\ 1\ 0\ 0\ 1\ 1\ 0\ 1\ 0\ 1\ 1\ 1\ 1\ 0\ 0), (1\ 1\ 0\ 0\ 0\ 1\ 0\ 0\ 1\ 1\ 0\ 1\ 0\ 1\ 1)\}$ and $G_2 = \{(0\ 0\ 0\ 0\ 0\ 0\ 0), (1\ 0\ 0\ 1\ 1\ 0\ 1), (0\ 1\ 0\ 1\ 0\ 1\ 1), (1\ 1\ 0\ 0\ 1\ 1\ 0), (0\ 0\ 1\ 0\ 1\ 1\ 1), (0\ 1\ 1\ 1\ 1\ 0\ 0), (1\ 1\ 1\ 0\ 0\ 0\ 1), (1\ 0\ 1\ 1\ 0\ 1\ 0)\}$.

Now having seen few examples of Hamming group code we now proceed on to define cyclic group code or group cyclic code.

FURTHER READING

1. Baum J.D, *Elements of point set topology*, Prentice-Hall, N.J, 1964.
2. Birkhoff. G, *Lattice theory*, 2nd Edition, Amer-Math Soc. Providence RI 1948.
3. Simmons, G.F., *Introduction to topology and Modern Analysis*, McGraw-Hill Book 60 N.Y. 1963.
4. Smarandache. F. (editor), *Proceedings of the First International Conference on Neutrosophy, Neutrosophic Probability and Statistics*, Univ. of New Mexico-Gallup, 2001.
5. Sze-Tsen Hu, *Elements of general topology*, Vakils, Feffer and Simons Pvt. Ltd., Bombay, 1970.
6. Vasantha Kandasamy, W.B., *Smarandache Semigroups*, American Research Press, Rehoboth, 2002.
7. Vasantha Kandasamy, W.B., *Smarandache Rings*, American Research Press, Rehoboth, 2002.
8. Vasantha Kandasamy, W.B. and Florentin Smarandache, *Finite Neutrosophic Complex Numbers*, Zip Publishing, Ohio, 2011.
9. Vasantha Kandasamy, W.B. and Florentin Smarandache, *Dual Numbers*, Zip Publishing, Ohio, 2012.
10. Vasantha Kandasamy, W.B. and Florentin Smarandache, *Special dual like numbers and lattices*, Zip Publishing, Ohio, 2012.

11. Vasantha Kandasamy, W.B. and Florentin Smarandache, *Special quasi dual numbers and groupoids*, Zip Publishing, Ohio, 2012.
12. Vasantha Kandasamy, W.B. and Florentin Smarandache, *Natural Product \times_n on matrices*, Zip Publishing, Ohio, 2012.
13. Vasantha Kandasamy, W.B. and Florentin Smarandache, *Neutrosophic Rings*, Hexis, Arizona, U.S.A., 2006.
14. Vasantha Kandasamy, W.B. and Florentin Smarandache, *Set Ideal Topological Spaces*, Zip Publishing, Ohio, U.S.A., 2012.
15. Vasantha Kandasamy, W.B., *Linear Algebra and Smarandache Linear Algebra*, Bookman Publishing, US, 2003.
16. Vasantha Kandasamy, W.B. and Florentin Smarandache, *Set Linear Algebra and Set Fuzzy Linear Algebra*, InfoLearnQuest, Ann Arbor, 2008.
17. Vasantha Kandasamy, W.B. and Florentin Smarandache, *Quasi Set Topological Vector Subspaces*, Educational Publisher Inc., Ohio, 2012.
18. Vasantha Kandasamy, W.B. and Florentin Smarandache, *Special classes of set codes and their Applications*, InfoLearnQuest, Ann Arbor, 2008.
19. Vasantha Kandasamy, W.B., *Smarandache Semirings, Semifields and Semivector spaces*, American Research Press, Rehoboth, 2002.
20. Voevodin, V.V., *Linear Algebra*, Mir Publishers, 1983.

INDEX

B

Binary Hamming set code, 151-5

C

Cyclic set codes, 153-4

D

Dual set code, 153-4

G

Group code, 157-8

Group Hamming code, 158-9

Group repetition code, 158

I

Ideal-topological space, 61-5

L

Left set ideal of a semigroup, 9-14

M

Maximal set ideals, 14-9

Maximal set Smarandache ideal, 28-9

Minimal set ideals, 14-9

Minimal set Smarandache ideal, 28-9
m-weight dual set code, 153-4
m-weight semigroup code, 156-7
m-weight set code, 152-3

N

Net Set Topological vector subspaces
(NS-topological vector subspace), 104-6

O

Orthogonal semigroup code, 156-7
Orthogonal set code, 153-4

P

Parity check set code, 150-2
Prime set ideal, 33-5
Pseudo simple quasi set topological vector subspace, 90-3

Q

Quasi set subtopological vector subspace, 85-9
Quasi set topological vector subspace, 82-8
Quasi set vector subspace, 77-9

R

Repetition set code, 148-9
Right set ideal of a semigroup, 9-14
Ring-ideal topological space, 61-5

S

Second layer atoms special second layered lattice, 113-5
Semigroup code, 155-6
Semigroup cyclic code, 156-7
Semigroup of dual numbers, 18-21

Semigroup of mixed dual numbers, 20-6
Semigroup parity check code, 156-7
Semigroup vector space over a semigroup, 118-9
Semigroups, 7-20
Set code, 145
Set generalized minimal ideals, 30-4
Set generalized Smarandache ideal, 30-4
Set Hamming distance, 150-5
Set Hamming weight, 151-5
Set ideal of a semigroup, 9-14
Set ideal topological space, 36-8
Set ideals in rings, 47-9
Set parity check matrices, 146-7
Set semigroup topological vector subspace, 120-5
Set semigroup vector subspace, 118-9
Set Smarandache ideal, 28-9, 35-7
Set Smarandache maximal ideals, 28-9
Set Smarandache minimal ideals, 28-9
Set vector space, 107-9
Special quasi dual number semigroup, 24-7
S-strong quasi set ideal, 55-9
S-strong set ideal, 55-9

ABOUT THE AUTHORS

Dr.W.B.Vasantha Kandasamy is an Associate Professor in the Department of Mathematics, Indian Institute of Technology Madras, Chennai. In the past decade she has guided 13 Ph.D. scholars in the different fields of non-associative algebras, algebraic coding theory, transportation theory, fuzzy groups, and applications of fuzzy theory of the problems faced in chemical industries and cement industries. She has to her credit 646 research papers. She has guided over 68 M.Sc. and M.Tech. projects. She has worked in collaboration projects with the Indian Space Research Organization and with the Tamil Nadu State AIDS Control Society. She is presently working on a research project funded by the Board of Research in Nuclear Sciences, Government of India. This is her 79th book.

On India's 60th Independence Day, Dr.Vasantha was conferred the Kalpana Chawla Award for Courage and Daring Enterprise by the State Government of Tamil Nadu in recognition of her sustained fight for social justice in the Indian Institute of Technology (IIT) Madras and for her contribution to mathematics. The award, instituted in the memory of Indian-American astronaut Kalpana Chawla who died aboard Space Shuttle Columbia, carried a cash prize of five lakh rupees (the highest prize-money for any Indian award) and a gold medal.

She can be contacted at vasanthakandasamy@gmail.com
Web Site: <http://mat.iitm.ac.in/home/wbv/public.html/>
or <http://www.vasantha.in>

Dr. Florentin Smarandache is a Professor of Mathematics at the University of New Mexico in USA. He published over 75 books and 200 articles and notes in mathematics, physics, philosophy, psychology, rebus, literature. In mathematics his research is in number theory, non-Euclidean geometry, synthetic geometry, algebraic structures, statistics, neutrosophic logic and set (generalizations of fuzzy logic and set respectively), neutrosophic probability (generalization of classical and imprecise probability). Also, small contributions to nuclear and particle physics, information fusion, neutrosophy (a generalization of dialectics), law of sensations and stimuli, etc. He got the 2010 Telesio-Galilei Academy of Science Gold Medal, Adjunct Professor (equivalent to Doctor Honoris Causa) of Beijing Jiaotong University in 2011, and 2011 Romanian Academy Award for Technical Science (the highest in the country). Dr. W. B. Vasantha Kandasamy and Dr. Florentin Smarandache got the 2012 New Mexico-Arizona and 2011 New Mexico Book Award for Algebraic Structures. He can be contacted at smarand@unm.edu

This book brings out how sets in algebraic structures can be used to construct the most generalized algebraic structures, like set linear algebra/vector space, set ideals in rings and semigroups and topological set vector spaces. This sort of study is innovative and will find applications in data handling.



US \$35.00

ISBN 9781599732121



90000 >



9 781599 732121