

QUANTIZATION AND DISCRETIZATION AT LARGE SCALES

EDITED BY :
FLORENTIN SMARANDACHE,
V. CHRISTIANITO &
P. PINTR

QUANTIZATION AND DISCRETIZATION AT LARGE SCALES

Edited by:

Florentin Smarandache, V. Christianto, & Pavel Pintre

Including articles never before published

Zip Publishing, 2012

Columbus, Ohio

(ISBN-13) 9781599732275

Printed in USA

This book can be ordered in a paper bound reprint from:

Books on Demand

ProQuest Information & Learning
(University of Microfilm International)
300 N. Zeeb Road
P.O. Box 1346, Ann Arbor
MI 48106-1346, USA
Tel.: 1-800-521-0600 (Customer Service)
<http://wwwlib.umi.com/bod/basic>

Copyright 2012 by Zip Publishing and Authors for their own articles.

Zip Publishing

1313 Chesapeake Avenue

Columbus, Ohio 43212

USA

Tel. (614) 485-0721

E-mail: info@zippublishing.com

Website: <http://www.zippublishing.com>

Many books can be downloaded from the following

Digital Library of Science:

<http://www.gallup.unm.edu/~smarandache/eBooks-otherformats.htm>

Cover design by Sonny Agustinus

(ISBN-13) 9781599732275

Printed in USA



Preface

The ongoing search of extrasolar planets is one of the most attractive fields of research in astrophysics and astronomy. Up to now, 360 extrasolar planets have been discovered near stars with similar mass as the Sun. There is also discovery related to the so-called Earth-like planets. With regards to these discoveries, one intriguing question is whether there is relationship between orbit distance of the planets and their stars. Various formulas have been suggested since 1990s, and they suggest that there may be reason to accept quantization of distances of those planets both in our solar system and also in extrasolar systems as well. This book discusses this issue (Rubcic & Rubcic), along with other interesting issues such as protoplanetary formation of solar system (Pintr, prof. Peřinová, & dr. Lukš), precession in solar system (Pitkanen) and other topics.

Another line of thought explored herein is the correspondence between cosmological phenomena and condensed matter physics, and therefore we can think that the quantization of orbit distances can be caused by superfluid helium quantization. This issue is explored by F. Smarandache and V. Christianto. Moreover, F. Smarandache also discusses possible new era of research that is pertaining to superluminal physics and instantaneous physics. Ion Patrascu and D. Rabounski discuss superluminality from their perspectives. And M. Pereira discusses his Hypergeometrical Universe model.

This book is published after our previous book: Quantization in astrophysics, Brownian motion, and Supersymmetry which was released about five years ago. Perhaps the ideas presented herein will have impact on discussions concerning quantum cosmology, which so far it cannot be observed. On the contrary, quantization at large scales can be observed. We hope that this volume will add a new chapter in our understanding of the Universe, from the viewpoint of quantization and discretization at large scales.

Special thanks go to journal editors who have granted permission to reprint papers included here, including *Chaos, Soliton, Fractals* editor, *Prespacetime Journal* editor, *Fizika* editor, *Progress in Physics* editor and *Apeiron* editor.

January 7th, 2012, January 25th 2012

FS, VC, PP

www.sciprint.org

Contents

Preface	iii
Contents	iv
Planetary orbits in Solar and Extrasolar systems (A. Rubcic & J. Rubcic) <i>Fizika A</i> , 19 no.3, 2010	1
Areal velocities of planets and their comparison (P. Pintr, V. Peřinová, A. Lukš) <i>unpubl.</i> 2011	15
Distribution of distances in solar system (P. Pintr, V. Peřinová, A. Lukš) <i>Chaos, Soliton, Fractals</i> 2007	27
New cosmological model of universe and possible quantization of the Hubble parameter (P. Pintr) <i>unpublished paper</i> , Dec. 2011	39
Do we really understand the solar system? (M. Pitkanen) Nov. 27th 2011	50
Inflation and TGD (M. Pitkanen) Dec. 10th 2011	70
QCD and TGD (M. Pitkanen) Dec. 19th 2011	78
Quantum arithmetics and the relationship between real and p-adic physics (M. Pitkanen) Dec. 12th 2011	94
A blind pilot: who is super-luminal observer? (D. Rabounski) <i>Progress in Physics</i> Vol.2, 2008	126
Scientist deduced the existence of particles with faster-than-light speeds recently discovered by CERN. (I. Patrascu) <i>Progress in Physics</i> Vol.4, 2011	127
Superluminal physics and Instantaneous physics as new trends in research (F. Smarandache)	129
The Hypergeometrical Universe: Cosmology and Standard Model. (M.A. Pereira). Jan. 2012	134
On astrometric data and time-varying sun earth distance in light of Carmeli metric (V. Christianto)	
<i>Prespacetime Journal</i> Vol.1 no.9, 2010	161
What gravity is. Some recent considerations. (V. Christianto & F. Smarandache) <i>Progress in Physics</i> Vol. 3, July 2008	168
Schrodinger equation and the quantization of celestial systems (F. Smarandache & V. Christianto)	
<i>Progress in Physics</i> vol.2, April 2006	173
A Cantorian superfluid vortex and the quantization of planetary motion (V. Christianto) <i>Apeiron</i>	
Vol.11 no.1, January 2004	178

PLANETARY ORBITS IN SOLAR AND EXTRASOLAR SYSTEMS

ANTUN RUBČIĆ and JASNA RUBČIĆ

*Department of Physics, Faculty of Science, University of Zagreb, Bijenička c. 32,
10000 Zagreb, Croatia E-mail address: rubcic@phy.hr*

Received 20 May 2010; Revised manuscript received 18 December 2010

Accepted 5 January 2011 Online 20 February 2011

The analysis of orbital parameters of planets and main planetary satellites of the solar system, published by the present authors, suggests that the Sun's system could be a "prototype" for the distribution of orbits in extrasolar planetary systems. Owing to the recent endeavours in detecting exoplanets, it became possible and suitable to check this assumption. Particularly useful in this work are the multiple extrasolar system with at least four planets. Unfortunately, there are only four stars satisfying this requirement. At the present time eleven stars with three planets have also been observed, which may also be taken into account in reaching reasonable assertions. Quantization of orbits in the solar system by orbital number, the integer n , and quantization of the product nv_n (v_n is the orbital velocity) by the spacing number, integer k , is also found in extrasolar planets. It is expected that new discoveries will support the present findings.

PACS numbers: 95.10.Ce, 95.10.Fh, 95.30.-t

UDC 523.2, 531.35

Keywords: quantization of orbits, solar planets, satellites of planets, extrasolar planetary systems

1. Introduction

In our previous articles [1a, b, c, d], the square law for orbits has been deduced by the analysis of orbital parameters of Sun's planets and main satellites of Jupiter, Saturn and Uranus. The Sun's planets are classified in two subsystems: terrestrial and Jovian. Therefore, there are five subsystems in the solar system, for which the orbital distributions follow the square law in the form

$$r_n = r_1 n^2. \quad (1)$$

The values of n are consecutive integer numbers in a definite range and r_1 is the radius of the orbit with $n = 1$, dependent on the subsystem. The existing orbits, as an example, for terrestrial planets are distributed from $n = 3$ for Mercury and ending with $n = 8$ for Ceres. Similar results are obtained for other systems, as will

be shown later in relevant graphs and tables. In the terrestrial system of planets, the Earth's moon, by hypothesis, had its primordial orbit $n = 7$ between Mars ($n = 6$) and Ceres ($n = 8$). Thus, the Moon is considered to be a planet, which was captured by the Earth [1e]. This hypothesis is supported by the analysis of masses, volumes and periods of all terrestrial planets. Why the Moon at orbit $n = 7$ migrated through the orbit of Mars to become a satellite of the Earth at $n = 5$ is not clear, as well as the problem of its chemical constitution. If the Moon was born at orbit $n = 7$, then it would be expected to contain a significant amount of water, like both Mars and Ceres. However, the absence of volatile elements and water in Moon's materials brought by astronauts suggests another origin: a giant impact of a body as large as Mars with the Earth. But it is hard to accept that such a cataclysmic process could have resulted in the Earth's satellite with parameters compatible with that of the present Moon and with those of all terrestrial planets. Therefore, the problem of the origin of the Moon remains open. Here we treat the Moon as a small planet of the terrestrial group of planets.

Physical basis for the square law (1) is a quantization of the specific angular momentum of planets. Details are presented in Ref. [1]. Equation (1) in extended form [1c,d] is given by

$$r_n = \frac{1}{v_0^2} GM \frac{n^2}{k^2}. \quad (2)$$

Other relevant relations are:

$$\text{specific angular momentum} \quad \frac{J_n}{m_n} = \frac{1}{v_0} GM \frac{n}{k}, \quad (3)$$

$$\text{period} \quad T_n = 2\pi \frac{1}{v_0^3} GM \frac{n^3}{k^3}, \quad (4)$$

$$\text{velocity} \quad v_n = v_0 \frac{k}{n}, \quad (5)$$

where n is the orbital number, G is the universal gravitational constant, M is the mass of the central body, v_0 is the velocity constant for all subsystems in the solar system (close to 24 kms^{-1}), and k is spacing number that depends on the system and defines the packing of orbits. In these formulae, circular orbits are assumed with radii equal to the semi-major axes of actual orbits.

For a definite value of k , Eqs. 2 to 5 are simply:

$$r_n^{1/2} \sim n, \quad (2')$$

$$J_n/m_n \sim n, \quad (3')$$

$$T_n^{1/3} \sim n, \quad (4')$$

$$nv_n = \text{const.} \quad (5')$$

It is important to point out that in a given system nv_n is constant. In the solar system, there are five subsystems, but each with its own value of nv_n . These values are determined by the number k . Jovian planets and satellites of Uranus have $k = 1$ and almost equal values nv_n . For terrestrial planets, $k = 6$ and similarly for other

systems (see Table 1). It means that physical laws are equal in planar gravitational systems regardless the mass m_n of orbiting bodies and the mass M of the central

TABLE 1. Solar and extrasolar planetary systems with at least four planets. The masses are expressed in terms of mass of Jupiter (M_J) or Earth (M_E). T is the period of rotation, a the semimajor axis, n the orbital number, nv_n the product of the orbital number and velocity and k is the spacing number.

System		Mass	T (days)	a (AU)	n	nv_n (km/s)	k
HD 160691	c	0.0332 M_J	9.638	0.09094	1	102.6	
	d	0.5219 M_J	310.55	0.921	3	96.8	
	b	1.676 M_J	643.25	1.5	4	101.5	
	e	1.814 M_J	4205.8	5.235	7	94.8	
						$\langle nv_n \rangle = 99 \pm 3$	4
55 Cnc	(e)	0.024 M_J	2.81705	0.038	1	(146.8)	
	b	0.824 M_J	14.65162	0.115	2	170.8	
	c	0.169 M_J	44.3446	0.24	3	176.6	
	f	0.144 M_J	260	0.781	5	163.4	
	d	3.835 M_J	5218	5.77	14	168.4	
						$\langle nv_n \rangle = 170 \pm 4$	7
GI 581	e	0.006104 M_J	3.14942	0.03	3	310.9	
	b	0.0492 M_J	5.34874	0.041	4	332.3	
	c	0.01686 M_J	12.9292	0.07	5	294.5	
	d	0.02231 M_J	66.8	0.22	9	322.5	
						$\langle nv_n \rangle = 315 \pm 10$	13
Ter.pl.	Me	0.0056 M_E	87.96	0.387	3	143.6	
	V	0.815 M_E	224.70	0.723	4	140.0	
	E	1 M_E	365.26	1	5	148.9	
	Ma	0.107 M_E	686.98	1.524	6	144.8	
	Moon?	0.012 M_E	1089	2.07	7	144.8	
	Ce	0.00016 M_E	1680	2.77	8	143.5	
						$\langle nv_n \rangle = 144 \pm 2$	6
Jov.pl.	J	318 M_E	4333	5.203	2	26.1	
	S	95 M_E	10759	9.54	3	28.9	
	U	14.5 M_E	30685	19.18	4	27.2	
	N	17.2 M_E	60188	30.06	5	27.2	
	Pl	0.002 M_E	90700	39.44	6	28.4	
						$\langle nv_n \rangle = 28 \pm 1$	1
HD 10180	b(?)	1.35 M_E	1.17768	0.02225	1	205.542 (?)	
	c	13.10 M_E	5.75979	0.0641	2	242.147	
	d	11.75 M_E	16.3579	0.1286	3	256.586	
	e	25.1 M_E	49.745	0.2699	4	236.108	
	f	23.9 M_E	122.76	0.4929	5	218.409	
	g	21.4 M_E	601.2	1.422	9	231.588	
	h	64.4 M_E	2222	3.4	14	233.058	
							$\langle nv_n \rangle = 236 \pm 9$

body, provided that m_n are much smaller than M . Consequently, it is expected that the stars with their own planets must also follow the same physical laws. A premonition of that statement was given in Ref. [1c], but at the time of publication, only three extrasolar systems, each with three planets, had been detected: PSR B1267+12, PSR1828 11 and ν Andromedae. Obviously, insufficient observational data could not present a convincing proof. However, nowadays there are 11 detected multiple extrasolar system with three planets (Table 2), two systems with four planets, one system with five planets and one system (the most recently discovered, Ref. [5] update December 2010) with seven planets. The systems with at least four planets (Table 1) are the best to confirm the square law for the distribution of orbits. This will be discussed in the next section.

2. Analysis of observational data

Orbital radii of terrestrial and Jovian planets and of main satellites of Jupiter, Saturn and Uranus are distributed according the square law (1). The circular orbits are assumed with radii equal to semi-major axes. The fundamental physical reason is the quantization of the specific angular momentum, which in the used approximation is given by

$$J_n/m_n = (GMr_1)^{1/2}n.$$

For elliptical orbits, this relation is given by [4]

$$J_n/m_n = [G(M + m_n)a_n(1 - e_n^2)]^{1/2},$$

where a_n is the semi-major axis and e_n the eccentricity related to the n -th orbit (subscript n is added by the present authors). For $m_n \ll M$ and small values of e_n , the approximation of circular orbits is very good.

Using the model defined by Eqs. (1–5), or Eqs. (2'–5') for a given $k = const.$, the numbers n of all orbits in a system are easily determined by the following simple calculation. The values of $T_n^{1/3}$ are each divided by one number from a choice of small integer numbers (see Eq. (4')) with the aim to obtain a constant quotient for all orbits.

For example: for the star 61 Vir, the periods of the planets b, c and d (Ref. 5 and Table 2) are: $T(\text{days}) = 4.215, 38.021$ and 123.01 . Consequently, $T^{1/3} = 1.615, 3.363, 4.973$. One simply obtains $1.615/1 = 1.615, 3.363/2 = 1,682$ and $4.973/3 = 1.658$, so the orbital numbers are $n = 1, 2$ and 3 . The resulting approximate set of orbital periods is $T_n^{1/3} = 1.65n, n = 1, 2, 3$.

The conclusion is that this star has three planets in successive orbits with $n = 1, 2, 3$. There maybe other planets with higher n that have not been detected yet.

However, another set of possible numbers n is obtained taking $1.615/2 = 0.808, 3.363/4 = 0.841$ and $4.973/6 = 0.829$, so the orbital numbers could be $n = 2, 4$ and 6 . The resulting set of orbits is then $T_n^{1/3} = 0.83n$. Other orbits would then be

TABLE 2. Extrasolar planetary systems with three planets.

System		Mass (M_J)	T (days)	a (AU)	n	nv_n (km/s)	k
61 Vir	b	0.016	4.215	0.05020	1	129.6	
	c	0.0573	38.021	0.2175	2	124.4	
	d	0.072	123.01	0.476	3	126.3	
						$\langle nv_n \rangle = 127 \pm 3$	5
Ups And	b	0.69	4.617136	0.059	1	139.0	
	c	1.92	241.33	0.832	4	150.0	
	d	4.13	1278.1	2.51	7	149.6	
						$\langle nv_n \rangle = 146 \pm 6$	6
HD 69830	b	0.033	8.667	0.0785	2	197.1	
	c	0.038	31.56	0.186	3	192.4	
	d	0.058	197	0.63	6	208.8	
						$\langle nv_n \rangle = 200 \pm 9$	8
GLIESE 876	d	0.02	1.93785	0.021	2	233.6	
	c	0.83	30.258	0.132	5	237.3	
	b	2.64	61.067	0.211	6	225.5	
						$\langle nv_n \rangle = 232 \pm 6$	10
HD 40307	b	0.0132	4.345	0.047	3	355.8	
	c	0.0216	9.62	0.081	4	366.4	
	d	0.0288	20.46	0.134	5	356.3	
						$\langle nv_n \rangle = 360 \pm 6$	15
PSR 1257+1	b	7e-05	25.2620	0.19	5	409.1	
	c	0.013	66.5419	0.36	7	412.0	
	d	0.012	98.2114	0.46	8	407.6	
						$\langle nv_n \rangle = 409 \pm 3$	17
HD 181433	b	0.238	9.3743	0.08	1	92.8	
	c	0.64	962	1.76	5	99.5	
	d	0.54	2172	3.0	6	90.2	
						$\langle nv_n \rangle = 94 \pm 5$	4
HD 74156	b	1.88	51.65	0.294	1	61.9	
	d	0.396	336.6	1	2	65.3	
	c	8.03	2476	3.85	4	67.7	
						$\langle nv_n \rangle = 65 \pm 3$	3
HD 37124	b	0.64	154.46	0.529	2	74.5	
	d	0.624	843.6	1.64	3	64.5	
	c	0.683	2295	3.19	4	60.5	
						$\langle nv_n \rangle = 68 \pm 7$	3
HIP 14810	b	3.88	6.67386	0.0692	1	112.9	
	c	1.28	147.73	0.545	3	121.7	
	d	0.57	962	1.89	5	108.0	
						$\langle nv_n \rangle = 114 \pm 7$	5
47 Uma	b	2.53	1078	2.1	3	63.6	
	c	0.54	2391	3.6	4	65.5	
	d	1.64	14002	11.6	7	63.1	
						$\langle nv_n \rangle = 64 \pm 2$	3

possible. For $n = 1$, the period would be $T_1 = 0.57$ days. In Ref. [5], there are no stars with planets with such a small period (only the star WASP 19 has the planet b with the period equal to 0.789 day [5]).

Similar calculations may be performed with semi-major axes. For the planets b, c and d of the star 61 Vir, the semi-major axes (in AU) are 0.0502, 0.2175 and 0.476 (Table 2). Then the values of $a^{1/2}$ are 0.224, 0.466 and 0.690. It follows that $0.224:1 = 0.224$, $0.466:2 = 0.233$ and $0.690:3 = 0.231$. As expected from the previous considerations, the orbital numbers are $n = 1, 2$, and 3 and $a_n^{1/2} = 0.23n$. As above, another possible set of numbers for known orbits is $n = 2, 4, 6$, then $a_n^{1/2} = 0.115n$, which for $n = 1$ gives $a_1 = 0.013$ AU. Note, there are no stars with such a small planetary orbit (only star GJ 1214 has planet b with the semi-major axis $a = 0.014$ AU [5]). The number of missing planets would be three, at $n = 1, 3$ and 5. Which set of numbers is real has to be confirmed by additional observational data. This ambiguity is at present unavoidable.

Another example is the star 47 Uma with three detected planets, with assigned orbital numbers $n = 3, 4$, and 7 (see Table 2). Square root of a_n of the planets b, c and d are 1.45, 1.90 and 3.41 (AU)^{1/2}. Following Eq. (2'), one obtains: $1.45/3 = 0.48$, $1.90/4 = 0.48$ and $3.41/7 = 0.49$. Consequently, occupied orbits are $n = 3, 4$ and 7 and orbits 1, 2, 5 and 6 have not been detected, or may even be nonexistent. Again, a definitive conclusion may be obtained only by new observational data.

In the examples above, the systems with three planets are discussed in which the method of the determination of orbital numbers in a planetary system is given.

In the following analysis, the systems with at least four planets are examined. These are the Sun's terrestrial and Jovian planets, and the planets of stars HD160691, 55 Cnc, GI 581 and HD 10180.

Table 1 shows the parameters of the planets: the masses, periods, semi-major axes, calculated orbital numbers n , and the products nv_n with average values and errors, and for each system the spacing number k (last column).

Orbital velocity is calculated using the simple formula $v_n = 2\pi a_n/T_n$ AU/day, in which it is assumed that a_n could be taken as the radius of circular orbits. If a_n in this formula is in units AU and T_n in days, then $v_n = 1.0879 \cdot 10^4 a_n/T_n$ km s⁻¹. It was shown that nv_n is nearly constant for a particular system according to Eq. (5), but depends on the value of the integer k [1c].

The dependence of $T^{1/3}$ on n is illustrated in Fig. 1.

Figure 1 also shows the data for the satellites of Jupiter, Saturn and Uranus, also given in Table 3. This is done according to our statement that in all planar systems, the existing bodies rotate about the central large body in orbits according to the same physical law, and in particular satisfy the quantization of the specific angular momentum. It means that Jupiter with its satellites may be considered as a small planetary system. That similarly holds for other systems. For example, planetary system of the star Cnc 55 "has some basic structural attributes found in our solar system" [6]. It is also pointed out that the HD 10180 planetary system shows the regular pattern of planets' orbits, as is also seen in the solar system [7].

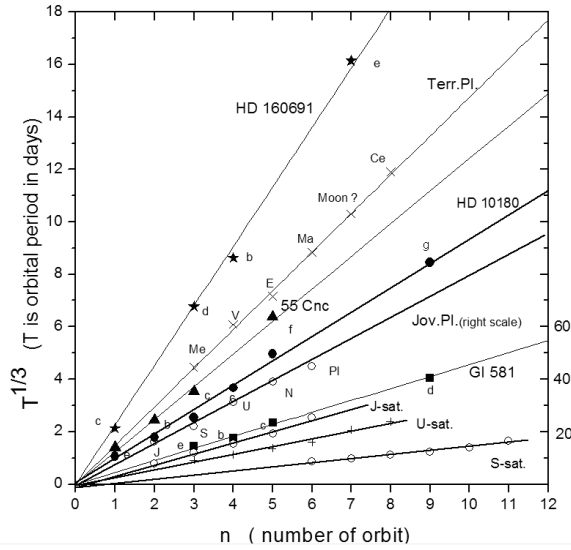

Fig. 1. Third roots of periods divided by chosen small integers n give the straight lines for all bodies in each planetary system. The n s are the orbital numbers (see Eq. (5')). Systems with at least four bodies are shown.

TABLE 3. Systems of satellites of Jupiter, Saturn and Uranus.

System		T (days)	a (AU)	n	nv_n (km/s)	k
Jupiter	Am.	0.498	0.00121	2	52.65	
	Io	1.569	0.00282	3	52.01	
	Eu.	3.551	0.00449	4	54.98	
	Gan.	7.155	0.00715	5	54.42	
	Call.	16.689	0.0126	6	49.23	
					$\langle nv_n \rangle = 52.7 \pm 1.6$	2
Saturn	Jan.	0.693	0.00101	6	95.11	
	Mim.	0.942	0.00124	7	100.24	
	Enc.	1.370	0.00159	8	101.07	
	Teth.	1.888	0.00197	9	102.16	
	Dione	2.737	0.00252	10	100.27	
	Rhea	4.518	0.00352	11	93.31	
					$\langle nv_n \rangle = 98.69 \pm 3.0$	4
Uranus	Ariel	2.520	0.00128	5	27.55	
	Umb.	4.144	0.00178	6	28.04	
	Tit.	8.706	0.00291	7	25.49	
	Ober.	13.463	0.0039	8	25.21	
	Mir.	1.414	0.000865	4	26.62	
	Puck	0.672	0.000575	3	24.62	
					$\langle nv_n \rangle = 26.26 \pm 1.2$	1

The dependence of nv_n on k is shown in Fig. 2. Straight line obtained by linear regression is

$$nv_n = (23.64 \pm 0.32)k + 3.76 \pm 0.87 \text{ km s}^{-1} \quad (6)$$

Since $nv_n = kv_0$

$$\mathbf{v}_0 = (23.64 \pm 0.32) \text{ km s}^{-1}. \quad (7)$$

Note that nv_n for the planet 55 Cnc, e is considerably smaller than those of the other planets with $n = 2, 3, 5$ and 14. The reason for that remains unknown, and in Table 1 both e and nv_1 are given in parentheses and are not included in mean value $\langle nv_n \rangle$.

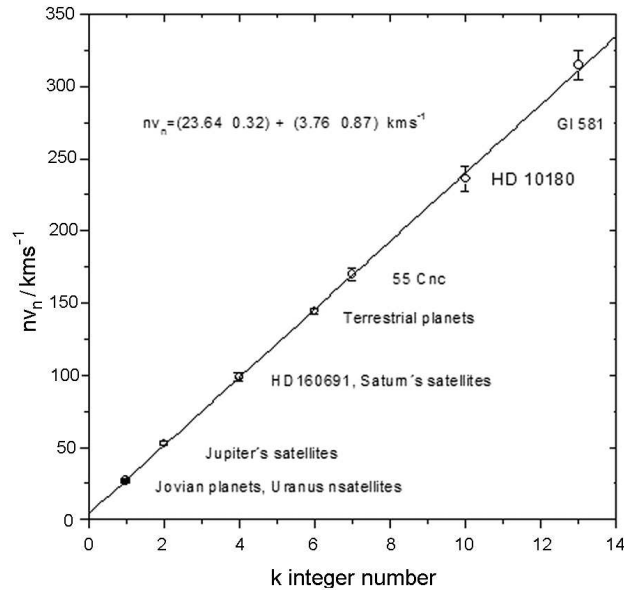

Fig. 2. Products nv_n of orbital number n with orbital velocities v_n for all systems represented in Fig. 1 are shown in steps defined by the spacing number k .

The number k defines the spacing of orbits in a system. It is interesting to point out that Jovian planets and satellites of Uranus both have $k = 1$. It means that orbital velocities decrease with n equally in both systems. Thus, for the $n = 5$ planet Neptune and Uranian satellite Ariel have the same orbital velocities. This is wonderful having in mind that the planar systems of Sun and Uranus are mutually nearly orthogonal. It is also impressive that planets of the star HD 160691 have $k = 4$ as the satellites of Saturn. Deviation of v_0 in Eq. (6) is less than 2%, owing to the analysis of four or more planets per system.

However, 11 systems with only 3 planets per system have greater dissipation of nv_n , as can be seen in Table 2, where maximum errors are included. Nevertheless, the mean nv_n values may be distributed so that they are close to a straight line defined by Eq. (6), as is illustrated in Fig. 3.

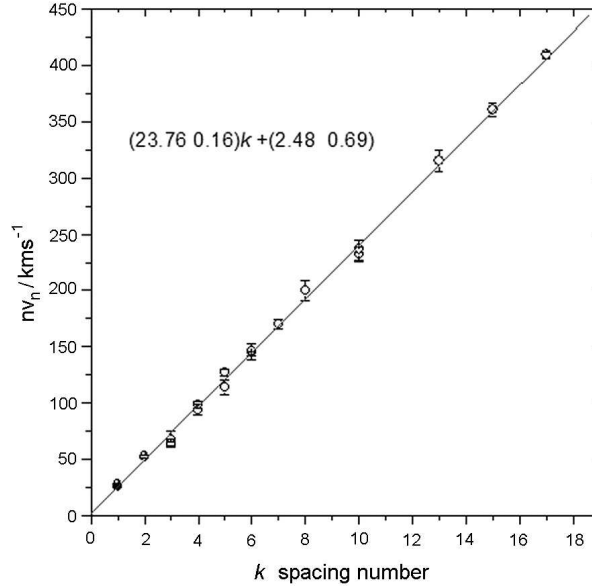

Fig. 3. Dependence of nv_n on k for all systems shown in Fig. 2 and for all systems with three planets.

The straight line determined by all considered systems listed in Tables 1–3 is

$$nv_n = (23.76 \pm 0.16)k + (2.48 \pm 0.69) \text{ km s}^{-1}.$$

Therefore, $v_0 = (23.8 \pm 0.2) \text{ km s}^{-1}$. In spite of the satisfactory description of the dependence of nv_n on k , the systems with 3 planets cannot safely confirm the quantization of nv_n with the above step of v_0 . Additional stars with more planets should be decisive for a final conclusion. Hopefully, advanced technique of observations of extrasolar planetary systems will help in reaching a definite solution.

3. Conclusion

We applied our model of quantization of orbits in the solar system on newly discovered extrasolar planetary systems. We confirmed that the square law for the distribution of orbits deduced from observational orbital parameters in solar system (Eq. (1) and/or Eq. (2)) also holds for the extrasolar planetary systems. Both integers, the orbital number n and the spacing number k , can easily be determined

from observed periods and semi-major axes of planets in systems considered. All this may be useful in the classification of orbits. Thus third root of the period divided by some small integer number n needs to be nearly constant for all planets in the system. Then, n is the number of orbit. We emphasize that the square law of orbits defines only the architecture of the planetary system, but details can only be determined by using observational parameters of some real objects belonging to the system considered. When the possible set of orbits is defined on the basis of occupied orbits, then one can anticipate which empty orbits could contain unobserved planets.

For example, the 55 Cnc planets e, b, c, f, and d are, according to our analysis, located at orbits 1, 2, 3, 5 and 14. Eight orbits at $n = 4, 6, \dots, 13$ are empty. The first thought is that at orbit 4 could be a small yet undetected planet. Moreover, the authors in Ref. [6] presume that in the gap between periods of 260 days to 13 yr several planets could exist and probably maintain dynamical stability.

In the HD 10180 planetary system, the first five orbits are occupied by the planets b, c, d, e, and f. The last planet h with relatively large mass is at the orbit 14. But at orbit 9 there is the planet g. Similarity with 55 Cnc system is impressive.

The procedure outlined above has also been applied to the origin of the Moon. Namely, in the terrestrial planets, the orbit 7 is empty and is located between Mars and Ceres. We have put forward a hypothesis that the Moon originated at that orbit and later on migrated to be captured by the Earth [1e]. The argument for such an assertion is that definite mass and volume of the Moon are expected when compared with the same quantities of all terrestrial planets.

We hope that determination of possible orbits according to square law could be a guide in the search for extrasolar planetary systems.

Acknowledgements

We are very grateful to Professors F. Smarandache and V. Christianto for reprinting our papers in their book. Thanks are due to I. Gladović for technical assistance.

References

- [1] A. Rubčić and J. Rubčić, (a) *Fizika B* **4** (1995) 11; (b) *Fizika B* **5** (1996) 85; (c) *Fizika B* **7** (1998) 1; (d) *Fizika A* **8** (1999) 45; (e) *Fizika A* **18** (2009) 185; Articles (1c) and (1d) in the original form have been reprinted in Ref. [2].
- [2] F. Smarandache and V. Christianto (Editors), *Quantization in Astrophysics, Brownian Motion and Supersymmetry*, MathTiger, Chennai, Tamil Nadu, India (2007) p. 1–19.
- [3] M. Zeilik and J. Gaustad, *Astronomy – The Cosmic Perspective*, J. Wiley & Sons, New York (1990).
- [4] H. Karttunen, P. Kroger, H. Oja, M. Poutanen and K. J. Donner (Editors), *Fundamental Astronomy*, Springer-Verlag, Berlin, Heidelberg, New York (1996) p. 145.

- [5] Jean Schneider, *The Extrasolar Planets*, Encyclopaedia, CNRS-Luth, Paris Observatory, updates: 18. May 2010 and 19. November 2010, Internet: <http://exoplanet.eu/catalog-RV.php>.
- [6] D. A. Fischer et al., *Five Planets Orbiting 55 Cancri*, <http://exoplanets.sfsn.edu/papers/55cnc55th.pdf>.
- [7] *ESO-es01035 Richest Planetary System Discovered*, <http://www.eso.org/public/news/eso/1035/>.

STAZE PLANETA U SUNČEVOM I IZVANSUNČEVIM SUSTAVIMA

Analiza parametra putanja planeta i glavnih planetarnih satelita u sunčevom sustavu, objavljena u našim prijašnjim radovima, upućuje na to da bi sunčev sustav mogao biti prototip i za planetarne sustave zvijezda sličnih Suncu. Zahvaljujući novijim rezultatima u detekciji izvan sunčevih planeta (exoplaneta) omogućena je provjera ove pretpostavke. U tu svrhu su najpogodniji sustavi sa četiri i više planeta, ali nažalost takvih sustava je otkriveno samo nekoliko. Veći broj sustava ima samo tri planete, ali i njihova analiza daje potporu gornjoj pretpostavci iako sa manjom vjerodostojnošću. Kvantizacija putanja u sunčevom sustavu s cijelim brojem n , i kvantizacija prostornosti (pakiranja) putanja sa cijelim brojem k , vodi na relaciju $nv_n = kv_0$, gdje je v_n brzina planete na putanji, a v_0 je konstantna brzina za sve sustave. Ove veličine mogu se odrediti i u izvansunčevim sustavima. Očekujemo da će nova otkrića exoplaneta potvrditi naša dosadašnja saznanja.

1.Orbital velocity of electron in H atom (and ionized atom He⁺ and Li²⁺)

In old quantum mechanical approach to hydrogen-like atoms Bohr used the third Newton’s law

$$m_e v_{ne}^2 / r_{ne} = (1/4\pi\epsilon_0)Ze^2 / r_{ne}^2 \dots\dots\dots(1)$$

and quantized angular momentum,which Bohr found by his great intuition and trial and error method.

$$m_e v_{ne} r_{ne} = nh/2\pi \tag{2}$$

In these equations m_e is electron mass, v_{ne} orbital speed of electron at n-th orbit whose radius is r_{ne}, ε₀ is permittivity of vacuum, e electronic elementary charge, Z is number of elementary charge in atomic nucleus, and h is the Planck’s constant. Equations (1) and (2) define orbital radius Eq.(3) and orbital speed Eq.(4)

$$r_{ne} = \frac{hn^2}{2\pi Z m_e c \alpha} \tag{3}$$

and
$$n v_{ne} = Z \alpha c \tag{4}$$

In Eq.(3) and (4) α=(1/4πε₀) 2πε²/hc is the fine structure constant.

2. In gravitational systems a similar approach to that presented by equations (1) to (4) is following: Third Newton’s law for rotating body of mass m_n at n-th orbit, of radius r_n with

speed v_n around central body of mass M is
$$\frac{m_n v_n^2}{r_n} = G \frac{M m_n}{r_n^2} \tag{5}$$

G is universal constant of gravitation.

A second necessary equation in order to solve unknown r_n and v_n is based on observational data and the square law for orbital radius of orbits in the solar system

has been established in the form
$$r_n = r_1 n^2 \tag{6}$$

As a consequence angular momentum is given by linear function on n, analogous to Eq.(2)

It follows that the speed v_n is
$$v_n = \sqrt{G \frac{M}{r_n}} = \sqrt{G \frac{M}{r_1} \frac{1}{n}} = \frac{v_1}{n}$$

or
$$n v_n = \sqrt{G \frac{M}{r_1}} = v_1 \tag{7}$$

The speed v_n depends on the system considered and for several known systems it was found that v₁ = kv₀ where v₀=close to 24 kms⁻¹. Therefore, one may write

$$n v_n = k v_0 \tag{8}$$

Eq.(4) shows that by increasing Z the set of orbits are more densely packed and speeds v_n increase too.

Similarly, Eq(8) gives a growth of speeds as integer number k increases.

It was also shown that
$$v_n = \alpha c / 2\pi f$$

or
$$v_n = \frac{\alpha c}{F} \tag{9}$$

where $1/F=(0.01073\pm 0.0013)k+(0.00188\pm 0.00043)$. For $k=1$ $v_1=v_0=(0.01073+0.0018)\alpha c=27.6 \text{ kms}^{-1}$ which is valid for Jovian planets i.e. $v_n=27.6/n$. For terrestrial planets $k=6$ and $v_1=0.01073k+0.00188=145.1 \text{ kms}^{-1}$. If the intercept is neglected in fitting procedure the resulting equation is $1/F=0.01118 k\pm 0.000169$. For Jovian planets follows $v_1=24.48 \text{ kms}^{-1}$ and for terrestrial planets $v_1=146.9 \text{ kms}^{-1}$. However, using the tabulated values for periods and semi-major axes with at least four planets for multiple planetary systems the values nv_n are described by

$$nv_n=(23.64\pm 0.32)k+(3.76\pm 0.87) \text{ kms}^{-1}.$$

where k is the integral number in a range from 1 for the Jovian system of planets up to 17 for the system of pulsar PSR 1257+12. Therefore, the constant 144 kms^{-1} is not a fundamental constant concerning the planetary systems of the stars similar to solar system.

For example, planets of 55 Cnc have an average value of nv_n close to 170 kms^{-1} with $k=7$.

Warning: in November 2010, planet denoted by Cnc-e had period $P(e)$ 2.81795 days and semi-major axis $a(e)$ 0.038 AU., (data are taken from Jean Schneider: Extrasolar Planets Encyclopaedia, shortly EPE). These data were used in submitted paper in 2010., and nv_n was 146 kms^{-1} . But, in December 2011, in (EPE) one finds $P(e)=0.73054$ days and semimajor axis $a(e)=0.0156$ AU giving nv_n 230 kms^{-1} . We concluded that data cited are dubious. Our analysis suggests that $P(e)$ and $a(e)$ should be close to 1.807 days and 0.0285 (AU), respectively. Then, for planet Cnc e $nv_n=171.5 \text{ kms}^{-1}$ in agreement with other four planets (see Table 1) Numbers n for planets are 1,2,3,5 and 14.

Recently, the fourth planet of Gliese 876 is detected and data for all planets are listed in EPE. The set of orbits are numbered with 2, 5, 6 and 8. Then the values of nv_n in kms^{-1} are : $2v_2=233.6$, $5v_5=234.3$, $6v_6=222.5$, and $8v_8=234.1$. The mean value for $nv_n=(231.1\pm 4.1) \text{ kms}^{-1}$ and $k=10$. However, this is not included in Table 1.

In conclusion: Eq.(4) shows that fundamental speed of electron is $\alpha c=3 \cdot 10^5/137=2189 \text{ kms}^{-1}$. Number Z determines the packing of permissible orbits, which for all systems follows the square law for orbital radii.

Eq.(8), analogous to Eq.(4), assumes the fundamental constant v_0 common for all gravitational planar systems, while integer k determines the spacing of orbits. The constant $v_0=\alpha c/F=24 \text{ kms}^{-1}$. Factor F is deduced from observational astronomical parameters and presently has not theoretical explanation. Consequently the speed $144 \text{ kms}^{-1}=kv_0$ with $k=6$ is one of possible speed among others with various values of k in an interval from $k=1$ to 17, which is found up to now.

The speed v_0 is proportional to αc and if αc is multiplied by $(3/2)\alpha$ then $(3/2)c\alpha^2=23.98 \text{ kms}^{-1}$ is close to v_0 . Obviously, this little game with numbers is not to be taken seriously, but could perhaps be interesting to some theoreticians in studies a connection of electromagnetism with gravitation.

Areal velocities of planets and their comparison

Pavel Pintr, Vlasta Peřinová*, Antonín Lukš
Joint Laboratory of Optics, Palacký University, RCPTM,
17. listopadu 12, 771 46 Olomouc, Czech Republic

Abstract

We have utilized the fact that the areal velocity of a planet is directly proportional to the appropriate number of the planet, while its distance is directly proportional to the square of this number. We have confirmed a previous proposal of the quantization of the planetary orbits, but with the first possible orbit of a planet in the solar system identical only to an order of magnitude. Using this method, we have treated moons of two planets and one extrasolar system. We have investigated a successive numbering and suggested a Schmidt-like formula in the planets and the Jovian moons.

PACS number: 96.10.+i

Keywords: solar system, distances, planets and satellites

1 Introduction

The formation of the solar system and its development are well described in [1]. The existing theories presume the age of the solar system as 4.5 billion years and that the entire system was created approximately 100 million years after the formation of the Sun. Despite of this, some of the chronological events of the formation of the system still remain unknown to us.

Comparing with the young T Tauri stars, we can say that the Sun formed in the center of a protoplanetary disk with the dimensions of approximately 1000 AU. The planets formed in the first 10 million years after the formation of the protoplanetary disk. The development of the solar system was terminated approximately 90 million years after the formation of the protoplanetary disk.

Very interesting papers have been devoted to the mechanism in protoplanetary disks [2, 3]. Turbulent processes have been described in nascent protoplanetary

^{0*} Corresponding author.

E-mail address: perinova@prfnw.upol.cz (V. Peřinová)

nebular. These topics have been the subject of many papers. The beginning of modern theories dates since Kuiper [4], who has shown that the protoplanetary nebular would have to be more massive than the algebraic sum of masses of all planets.

We can divide papers describing the distribution of distances into several categories. Many empirical formulas describe the distances on the condition of suitable numbering of planets [5, 6]. Dubrulle and Graner [7, 8] have shown that using the rotational symmetry and the scale invariance, we can derive a geometric progression for any model system in the form

$$r_n = r_0 K^n, \quad (1)$$

where n is an integral number, r_0 is an initial distance, and K is a constant that determines the distribution of distances in the system. A successive numbering of planets is assumed as is respectable to such an impressive formula. Krot has created an evolutionary model of the rotating and gravitating spherical body [9]. He has remembered that with the aid of specific angular momentum of protoplanets, Schmidt derived the square root of radius R_n of the orbit for the n th protoplanet [10],

$$\sqrt{R_n} = a + bn, \quad (2)$$

where a and b are constants. Then he has generalized the Schmidt law for the solar system leaving (2), a mere linear approximation.

The first quantum formulas are comparable in complexity with (2). Agnese and Festa [11, 12] have described the distances of planets in the solar system as a gravitational atom [13] using the famous Bohr-Sommerfeld rules. The successive numbering is possible only for the terrestrial planets. The other planets are numbered “suitably”, i.e., so that a best fit is achieved. They have shown that this description can be applied to extrasolar systems. They have proposed a gravitational constant in conformity with the clue to the unification of gravitation and particle physics [14]. The hypothesis of a fundamental orbital distance 0.055 AU has a very interesting result [11, 12, 15, 16]. A derivation of the Schrödinger equation [17, 18] from the Newton mechanics has inspired many variations of quantum description [13, 19, 20, 21]. We can find solutions of the Schrödinger equation in [21, 22], which lead to possible discrete orbits by means of the quantum averaging. The distances of planets obtained in such a way exhibit a dependence on the main and orbital quantum numbers. The probability densities have been derived for each orbit and the number of possible orbits in the solar system has been reduced [22].

Till now 360 extrasolar planets have been discovered near stars with similar mass as the Sun. Every day we observe new extrasolar planets or protoplanetary disks. Theories of migrating planets suppose that, if two high mass planets form near each other, both the planets will change orbits around the star and also the collisions with next big bodies will change orbits of planets in a young planetary

system [23, 24, 25]. According to these theories, the predictions of orbits are very problematic.

In section 2, we will expound the method under application and use it for the planets in the outer part of the solar system. In section 3, we will apply it to the systems of moons around Jupiter and Uranus. In section 4, we will consider the extrasolar system HD10180 [26].

2 Correlation of areal velocities

Agnese and Festa [11, 12] have invented allowed planetary orbits with the major semi-axes and excentricities

$$\bar{a}_n = \bar{a}_1 n^2, \bar{\varepsilon}_{nl} = \sqrt{1 - \frac{l^2}{n^2}}, \quad (3)$$

respectively, where \bar{a}_1 means a possible first orbit of a planet, n is a principal number and l is an azimuthal number, $l = 1, \dots, n$, $n = 1, 2, 3, \dots, \infty$. Assuming $l = n$ (circular orbits), they describe the distribution of planetary distances in words that we formalize as

$$r(p) = \bar{a}_{n(p)}, \quad (4)$$

where $p = \text{Mercury, Venus, Earth, Mars, (Ceres,)} \text{ Jupiter, Saturn, Uranus, Neptune, Pluto}$ and $n(\text{Mercury}) = 3$, $n(\text{Venus}) = 4$, $n(\text{Earth}) = 5$, $n(\text{Mars}) = 6$, ($n(\text{Ceres}) = 8$,) $n(\text{Jupiter}) = 11$, $n(\text{Saturn}) = 15$, $n(\text{Uranus}) = 21$, $n(\text{Neptune}) = 26$, $n(\text{Pluto}) = 30$. It can be seen that the inner planets are successively numbered and the outer planets are rather numbered with a step of 5. For the first orbit it holds that

$$\bar{a}_1 = \frac{GM^{(\text{Sun})}}{\alpha_g^2 c^2}, \quad (5)$$

where G is the gravitational constant, c is the speed of light, α_g is a gravitational structure constant, $1/\alpha_g = 2113 \pm 15$ [11], and $M^{(\text{Sun})}$ is the mass of the Sun in application to the first possible orbit in the solar system. We remark that the gravitational structure constant, whose value was calculated from data of the solar system, has been tested against extrasolar planets and provided an orbit $\bar{a}_1 = 0.055 \text{ AU}$ [11, 12, 15, 16]. This description has shown a very interesting connection between a model of the solar system and the hydrogen atom. In this paper, we will show that it is also possible to use quantum physics for the determination of the distribution of orbits in planetary systems.

Let us consider the solar system, where we implement a simplification that the orbits of planets are circular and the positions of planetary orbits are in one plane. We can define a circular planetary model of the solar system, which looks like the model of hydrogen atom from the ‘‘old quantum theory’’. In the old quantum theory, it was only possible to explain the structure of the hydrogen

atom or an ionized atom with a single electron. The absorption or emission lines for spectroscopy were obtained in terms of the energy differences of the electron on various orbits. For these orbits it holds that (cf. Bohr's model of hydrogen atom)

$$m_e \bar{v}_n \bar{r}_n = n \hbar, \quad (6)$$

where m_e is the mass of electron, \bar{v}_n is the velocity of electron revolving around the nucleus, \bar{r}_n is the distance of electron to the nucleus, and \hbar is the reduced Planck constant. These orbits may not be occupied simply by more and more electrons, because the Coulombic interaction between these particles is not negligible. This quantization of orbits can be formally generalized to macroscopic bodies and the velocities related to the gravity. Agnese and Festa [11] have modified the relation (6) to the form

$$m_p \bar{v}_n \bar{r}_n = n(\hbar + m_p c \bar{\lambda}), \quad (7)$$

where m_p is the mass of planet, \bar{v}_n is the orbital velocity of planet, \bar{r}_n is its distance to the central star, c is the speed of light and $\bar{\lambda}$ is a fundamental length.

With respect to the weak equivalence principle in the case of circular orbits, the velocities will only depend on the gravitational potential in the distance r to the Sun (the central body). On neglecting \hbar on the right-hand side of the relation (7), the independence of allowed orbits of the mass m_p is obtained. In contrast to the electrons in the atom, the orbits around the Sun can be occupied by more than one macroscopic body as far as the gravitational interactions between them can be neglected. This ad hoc hypothesis explains the regularity of the planetary orbits on the given, maybe too generous assumption.

Let us study the simplified model of the solar system and let us address to the following consideration, which comes out of Kepler's second law: Areas which are swept out by the radius vector of planet in equal time intervals are equal, so the elementary area swept out by the radius vector of planet in the aphelium in the time dt is the same as the elementary area swept out by the radius vector of planet in the perihelium in the time dt . For the area which is swept out by the radius vector of planet in the circular model, Kepler's second law is valid as well. For the areal velocities of planets, $w(p)$, it holds that

$$2w(p) = v(p)r(p). \quad (8)$$

Let us compare the areal velocities of planets for the outer part of the solar system, with the allowed areal velocities \bar{w}_n , $2\bar{w}_n = \bar{v}_n \bar{r}_n$, which will be appropriately defined.

From Table 1, we can substitute a formula $v(p)r(p) = n(p)K(p)$ by a new formula $\bar{v}_n \bar{r}_n = nK^{(\text{approx})}$, where $n = n(p)$ and $K^{(\text{approx})}$ is a constant, viz., an approximate value of $K(p)$, or

$$v(p)r(p) \approx n(p)K^{(\text{approx})}, \quad (9)$$

p	$v(p)r(p)$	$n(p)$	$K(p)$	$K^{(\text{approx})}$	$n(p)K^{(\text{approx})}$
Jupiter	1.02×10^{16}	10	1.02×10^{15}	1.00×10^{15}	1.00×10^{16}
Saturn	1.38×10^{16}	14	9.87×10^{15}	1.00×10^{15}	1.40×10^{16}
Uranus	1.95×10^{16}	20	9.75×10^{15}	1.00×10^{15}	2.00×10^{16}
Neptune	2.45×10^{16}	25	9.80×10^{15}	1.00×10^{15}	2.50×10^{16}

Table 1: Parameters $K(p)$, $K^{(\text{approx})}$ and $n(p)$ for the outer part of the solar system.

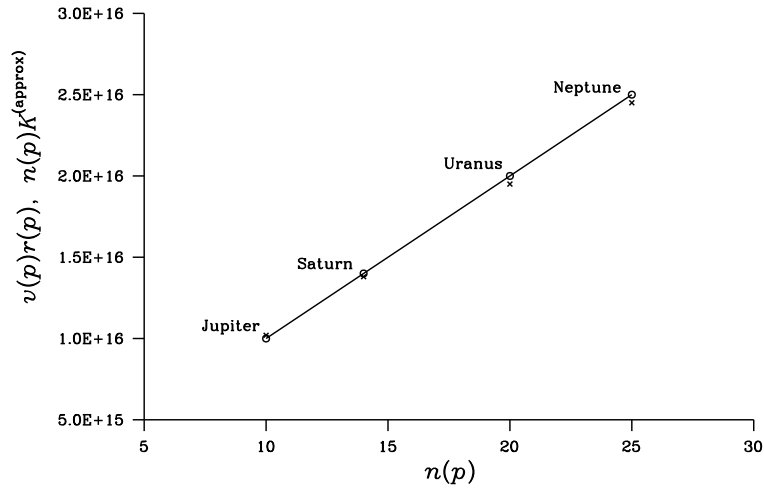

Figure 1: Comparison of real data $v(p)r(p)$ (\times) with the formula $n(p)K^{(\text{approx})}$ (\circ) for the outer parts of the solar system.

where $p = \text{Jupiter, Saturn, Uranus, Neptune}$. A comparison of real data $v(p)r(p)$ with the approximate formula $n(p)K^{(\text{approx})}$ is illustrated in Figure 1.

We find \bar{v}_n, \bar{r}_n such that they fulfil the relation

$$\bar{v}_n \bar{r}_n = nK^{(\text{approx})} \quad (10)$$

and Newton's gravitational law

$$\bar{v}_n = \sqrt{\frac{GM^{(\text{Sun})}}{\bar{r}_n}}. \quad (11)$$

We arrive at

$$\bar{r}_n = \bar{a}_1 n^2, \quad (12)$$

where

$$\bar{a}_1 = \frac{[K^{(\text{approx})}]^2}{GM^{(\text{Sun})}} = 0.052 \text{ AU}. \quad (13)$$

We will show that the planets can be numbered successively using $n(J)$ to $n(J) + 3$, where J stands for the planet Jupiter, unlike 10, 14, 20, 25 in Table 1. Traditionally, we use the least squares method. We can determine the number $n(J)$ and a constant K such that

$$\begin{aligned} & [1.02 - n(J)K]^2 + [1.38 - (n(J) + 1)K]^2 + [1.95 - (n(J) + 2)K]^2 \\ & + [2.45 - (n(J) + 3)K]^2 = \min. \end{aligned} \quad (14)$$

This happens for $n(J) = 2$, $K = 0.4857 \times 10^{16}$. We have arrived at a Schmidt-like formula.

The formula (12) is in accordance with the papers of Agnese and Festa [11, 12], but we do not use the gravitational structure constant for the definition of a possible first orbit. This is the main point in our considerations.

Now we can introduce a new parameter ρ_l of the system in the formula (13), which we call the length density of orbits,

$$\rho_l = \frac{G}{[K^{(\text{approx})}]^2} \quad (15)$$

in units kgm^{-1} . This new parameter can be used for the classification of extrasolar systems.

3 Systems of moons around planets

The procedure which we derived above, is valid also for systems of moons around planets. For a system of moons, the formula (12) is valid, where for the first orbit it holds that

$$\bar{a}_1 = \frac{1}{\rho_l M^{(\text{planet})}}, \quad (16)$$

p	$v(p)r(p)$	$n(p)$	$K(p)$	$K^{(\text{approx})}$	$n(p)K^{(\text{approx})}$
Io	7.31×10^{12}	7	1.04×10^{12}	1.00×10^{12}	7.00×10^{12}
Europa	9.21×10^{12}	9	1.02×10^{12}	1.00×10^{12}	9.00×10^{12}
Ganymedes	1.16×10^{13}	12	9.67×10^{11}	1.00×10^{12}	1.20×10^{13}
Callisto	1.50×10^{13}	15	1.00×10^{12}	1.00×10^{12}	1.50×10^{13}

Table 2: Parameters $K(p)$, $K^{(\text{approx})}$ and $n(p)$ for the Jovian system of moons.

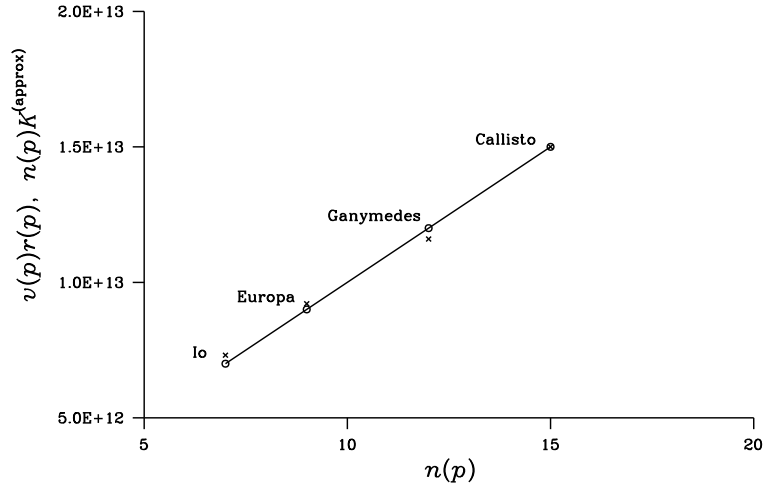

Figure 2: Comparison of real data $v(p)r(p)$ (\times) with the formula $n(p)K^{(\text{approx})}$ (\circ) for the Jovian system of moons.

where $M^{(\text{planet})}$ is a mass of a planet that moons revolve around.

For the Jovian system, it holds that $M^{(\text{Jupiter})} = 1.9 \times 10^{27}$ kg, $\bar{a}_1 = 7890.79$ km, $K^{(\text{approx})} = 1.00 \times 10^{12}$ m²s⁻¹. In Table 2, the parameters for the Jovian system of moons can be found. A comparison of real data $v(p)r(p)$ with the approximate formula $n(p)K^{(\text{approx})}$ is illustrated in Figure 2.

We will show that the moons can be labelled with successive numbers $n(I)$ to $n(I) + 3$, where I stands for the moon Io, unlike 7, 9, 12, 15 in Table 2. Again, we use the least squares method. We can find the number $n(I)$ and a constant K such that

$$\begin{aligned}
& [7.31 - n(I)K]^2 + [9.21 - (n(I) + 1)K]^2 + [11.6 - (n(I) + 2)K]^2 \\
& \quad + [15.0 - (n(I) + 3)K]^2 = \min.
\end{aligned} \tag{17}$$

This takes place for $n(I) = 3$, $K = 2.40 \times 10^{12}$. We have indicated a Schmidt-like formula.

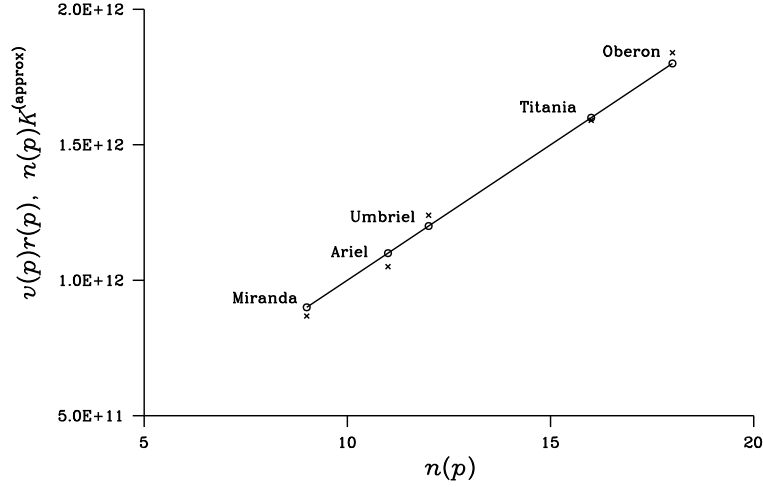

Figure 3: Comparison of real data $v(p)r(p)$ (\times) with the formula $n(p)K^{(\text{approx})}$ (\circ) for the Uranian system of moons.

For the Uranian system it is valid that $M^{(\text{Uranus})} = 8.7 \times 10^{25}$ kg, $\bar{a}_1 = 1723.28$ km, $K^{(\text{approx})} = 1.00 \times 10^{11} \text{ m}^2\text{s}^{-1}$. In Table 3, the parameters for the Uranian system of moons can be found. A comparison of real data $v(p)r(p)$ with the approximate formula $n(p)K^{(\text{approx})}$ is illustrated in Figure 3.

p	$v(p)r(p)$	$n(p)$	$K(p)$	$K^{(\text{approx})}$	$n(p)K^{(\text{approx})}$
Miranda	8.68×10^{11}	9	9.64×10^{11}	1.00×10^{11}	9.00×10^{11}
Ariel	1.05×10^{12}	11	9.57×10^{11}	1.00×10^{11}	1.10×10^{12}
Umbriel	1.24×10^{12}	12	1.04×10^{11}	1.00×10^{11}	1.20×10^{12}
Titania	1.59×10^{12}	16	9.94×10^{11}	1.00×10^{11}	1.60×10^{12}
Oberon	1.84×10^{12}	18	1.02×10^{11}	1.00×10^{11}	1.80×10^{12}

Table 3: Parameters $K(p)$, $K^{(\text{approx})}$ and $n(p)$ for the Uranian system of moons.

4 Extrasolar system HD 10180

We can also apply our consideration to extrasolar systems. For such systems it holds that

$$\bar{a}_1 = \frac{[K^{(\text{approx})}]^2}{GM^{(\text{Star})}}, \quad (18)$$

where $M^{(\text{Star})}$ is a mass of a central star. Here $M^{(\text{Star})} = 1.06 \pm 0.05 M^{(\text{Sun})}$. We calculate further orbits according to the formula (12).

The planetary system HD10180 was introduced in [26]. It is the most explored extrasolar system with 7 planets. This extrasolar system was examined with the aid of measurements of the radial velocities of the system HARPS and that is why we selected it for our considerations.

The planet b is at the distance 0.02226 AU to the central star with the mass 1.4 times more than the mass of the Earth, the planet c is at the distance 0.0641 AU to the central star with the mass 13.16 times more than the mass of the Earth, the planet d is at the distance 0.1286 AU to the central star with the mass 11.91 of the mass of the Earth, the planet e is at the distance 0.2695 AU to the central star with the mass 25.3 of the mass of the Earth, the planet f is at the distance 0.4923 AU to the central star with the mass 23.5 of the mass of the Earth, the planet g is at the distance 1.422 AU to the central star with the mass 21.3 of the mass of the Earth, the planet h is at the distance 3.4 AU to the central star with the mass 65.2 of the mass of the Earth.

The formulas (3) and (12), with $\bar{a}_1 = 0.055$ AU do not provide an appropriate allowed orbit, because the distance of the planet b to the central star $r(b)$, is much nearer than the radius of a possible first orbit \bar{a}_1 . For the system HD10180, it holds that $K^{(\text{approx})} = 1.00 \times 10^{14} \text{ m}^2\text{s}^{-1}$, with the first orbit $\bar{a}_1 = 0.000484$ AU and the length density of orbits $\rho_l = 6.67 \times 10^{-39} \text{ kgm}^{-1}$. If we compare the length density of orbits with the solar system, the system HD10180 has 100 times denser orbits than the solar system. Therefore, the architecture HD10180 is much nearer than the solar system. The extrasolar system HD10180 meets the formula (12), if we apply the correct first distance \bar{a}_1 . In Table 4, the parameters for the system HD10180 are arranged. A comparison of real data $v(p)r(p)$ with the approximate formula $n(p)K^{(\text{approx})}$ is illustrated in Figure 4.

p	$v(p)r(p)$	$n(p)$	$K(p)$	$K^{(\text{approx})}$	$n(p)K^{(\text{approx})}$
b	6.86×10^{14}	7	9.80×10^{13}	1.00×10^{14}	7.00×10^{14}
c	1.15×10^{15}	12	9.59×10^{13}	1.00×10^{14}	1.20×10^{15}
d	1.63×10^{15}	16	1.02×10^{14}	1.00×10^{14}	1.60×10^{15}
e	2.36×10^{15}	24	9.84×10^{13}	1.00×10^{14}	2.40×10^{15}
f	3.19×10^{15}	32	9.98×10^{13}	1.00×10^{14}	3.20×10^{15}
g	5.42×10^{15}	54	1.00×10^{14}	1.00×10^{14}	5.40×10^{15}
h	8.38×10^{15}	84	9.98×10^{13}	1.00×10^{14}	8.40×10^{15}

Table 4: Parameters $K(p)$, $K^{(\text{approx})}$ and $n(p)$ for the system HD10180.

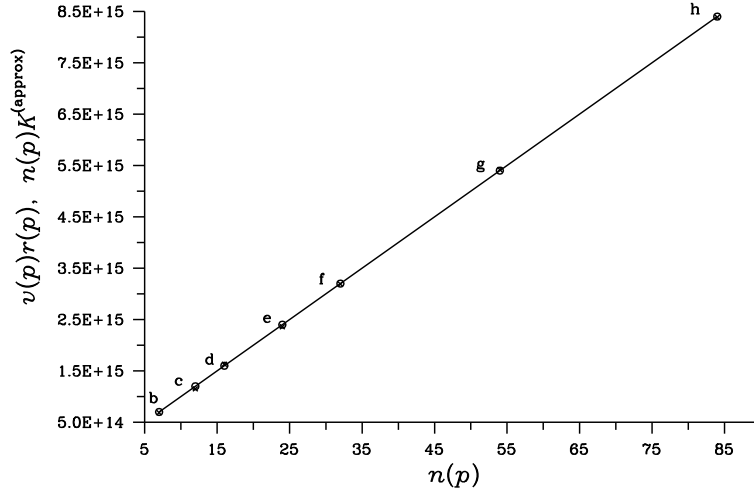

Figure 4: Comparison of real data $v(p)r(p)$ (\times) with the formula $n(p)K^{(approx)}$ (\circ) for the system HD10180.

5 Conclusion

Basing on the numerical agreement between calculation and real data, we have found suitable numbers of the planets and a proportionality constant of their areal velocities to this numbers. We have derived that the distance of the planet to the central star is directly proportional to the square of this number. In this way we have obtained the first possible orbit of a planet at the distance 0.052 AU in the solar system and 0.000484 AU in the system HD10180. Analogously, we have got the first possible orbit of a moon at the distance 7890.79 km in the Jovian system of moons and 1723.28 km in the Uranian moon system.

We conclude that the distances of the planets and moons in gravitational systems can be obtained as follows:

Areal velocities of planets relate to integral numbers, viz., suitable numbers of the planets. These velocities are directly proportional to the appropriate numbers of the planets with a proportionality constant $K^{(approx)}$.

Distances of the planets in the gravitational system are directly proportional to the squares of the numbers of the planets and the proportionality constant, the radius of a possible first orbit \bar{a}_1 depends on the parameter $K^{(approx)}$.

6 Acknowledgments

The authors acknowledge the financial support by the Ministry of Education, Youth and Sports of the Czech Republic in the framework of the project No. 1M06002 and the project COST OC 09026. They would like to thank J. Křepelka

for his adaptation of figures.

References

- [1] Montmerle, T.; Augereau, J.-C.; Chaussidon M. Solar system formation and early evolution: The first 100 million years. *Earth, Moon and Planets* 2006, 98, 39–95.
- [2] von Weizsäcker, C. F. Über die Entstehung des Planetensystems. *Zeitschrift für Astrophysik* 1943, 22, 319–355.
- [3] von Weizsäcker, C. F. Zur Kosmogonie. *Zeitschrift für Astrophysik* 1947, 24, 181–206.
- [4] Kuiper, G. P. On the origin of the solar system. In: *Astrophysics: a topical symposium*; Hynek, J. A.; Ed.; McGraw-Hill: New York, NY, 1951, pp 357–424.
- [5] Pintr, P.; Peřinová, V.; Lukš, A. Allowed planetary orbits in the solar system. *Chaos, Solitons & Fractals* 2008, 36, 1273–1282.
- [6] Nottale, L.; Schumacher, G.; Lefèvre, E. T. Scale-relativity and quantization of exoplanet orbital semi-major axes. *Astronomy and Astrophysics* 2000, 361, 379–387.
- [7] Graner, F.; Dubrulle, B. I. Scale invariance explains everything. *Astronomy and Astrophysics* 1994, 282, 262–268.
- [8] Dubrulle, B.; Graner, F. II. Build your own law from disc models. *Astronomy and Astrophysics* 1994, 282, 269–276.
- [9] Krot, A. M. A statistical approach to investigate the formation of the solar system. *Chaos, Solitons & Fractals* 2009, 41(3), 1481–1500.
- [10] Schmidt, O. Yu. Meteorite theory of origin of Earth and planets. *Doklady Akademii Nauk SSSR* 1944, 45 (6), 245–249 (in Russian).
- [11] Agnese, A. G.; Festa, R. Clues to discretization on the cosmic scale. *Physics Letters A* 1997, 227, 165–171.
- [12] Agnese, A. G.; Festa, R. (1991). Discretizing *v*-Andromedae planetary system. arXiv:astro-ph/9910534v2.
- [13] Greenberger, D. M. Quantization in the Large. *Foundations of Physics* 1983, 13(9), 903–951.

- [14] Wesson, P. S. Clue to the unification of gravitation and particle physics. *Physical Review D* 1981, 23, 1730–1734.
- [15] Nottale, L. *Fractal Space-Time and Microphysics: Towards a Theory of Scale Relativity*; World Scientific: Singapore, 1993, p. 311.
- [16] Nottale, L.; El Naschie, M. S.; Al-Athel, S.; Ord G. N., editors. *Chaos, Solitons & Fractals*, Special Issue: Fractal Space-Time and Cantorian Geometry in Quantum Mechanics; Elsevier: Amsterdam, 1996, 7(6), 821–959.
- [17] Nelson, E. Derivation of the Schrödinger equation from Newtonian mechanics. *Physical Review* 1966, 4, 1079–1085.
- [18] Nelson, E. *Quantum fluctuations*; Princeton University Press: Princeton (NJ), 1985.
- [19] Carvalho, J. C. On large-scale quantization. *Lettere al Nuovo Cimento* 1985, 44(6) ser. 2, 337–342.
- [20] Chechelnitzsky, A. M. Hot points of the wave universe concept: New world of megaquantization. *Hot Points in Astrophysics JINR* (Dubna, Russia, August) 2000, 22-26.
- [21] De Oliveira Neto, M.; Maia, L. A.; Carneiro, S. An alternative theoretical approach to describe planetary systems through a Schrödinger-type diffusion equation. *Chaos, Solitons & Fractals* 2004, 21, 21-28.
- [22] Peřinová, V.; Lukš, A.; Pintr, P. Distribution of distances in the solar system. *Chaos, Solitons & Fractals* 2007, 34, 669–676.
- [23] Murray, N.; Hansen, B.; Holman, M.; Tremaine, S. Migrating planets. arXiv:astro-ph/9801138v2.
- [24] Murray, N.; Paskowitz, M.; Holman, M. Eccentricity evolution of migrating planets. *The Astrophysical Journal* 2002, 565, 608–620.
- [25] Spencer, W. Migrating planets and migrating theories. *Journal of Creation* 2007, 21(3), 12–14.
- [26] Lovis, C.; Ségransan, D.; Mayor, M.; Udry, S.; Benz, W.; Bertaux, J.-L.; Bouchy, F.; Correia, A. C. M.; Laskar, J.; Lo Curto, G.; Mordasini, C.; Pepe, F.; Queloz, D.; Santos, N. C. The HARPS search for southern extra-solar planets, XXVII. Up to seven planets orbiting HD 10180: probing the architecture of low-mass planetary systems. arXiv:astro-ph/1011.4994v1.

Distribution of distances in the solar system

V. Peřinová*, A. Lukš, P. Pintr

Laboratory of Quantum Optics, Faculty of Natural Sciences,
Palacký University, Třída Svobody 26,
77146 Olomouc, Czech Republic

Abstract

The recently published application of a diffusion equation to prediction of distances of planets in the solar system has been identified as a two-dimensional Coulomb problem. A different assignment of quantum numbers in the solar system has been proposed. This method has been applied to the moons of Jupiter on rescaling.

PACS number: 96.35

Key words: regularities of planetary orbits, large scale quantization

1 Introduction

The 20th century is held for the golden age of the astronomy and astrophysics, when many persistent questions were solved and the human view of the universe changed radically. In spite of this, at the beginning of the 21st century, one cannot find satisfactory answers to some questions our ancestors posed as early as in the 16th century. For instance, Kepler looked for a universal law, in his *Mysterium cosmographicum*, to explain the planetary distances in the solar system. Nowadays, when discoveries of other planetary systems occur, such a law could explain the distances of their planets.

In 1766 Titius formulated the law, which described distances of the bodies in the solar system, and it even predicted new bodies at certain distances from the Sun [1]. Actually its being criticized led to the discovery of the remaining planets and new bodies – asteroids – in the solar system. It was the first, controversial, description of the distances of the bodies in this planetary system. But hardly any physical explanation has thus far been given. Is it a mere extravagance, or does this law have some deep physical content? May the planets around stars originate at definite distances?

Quest of the answer developed into invention of new empirical formulae, which describe, with higher or lower accuracy, the distances of the bodies in the solar system. For instance Armelini's empirical formula has the form

$$r_{nA} = 1.53^n, \tag{1}$$

where n assumes the values: Mercury -2 , Venus -1 , Earth 0 , Mars 1 , asteroid Vesta 2 , asteroid Camilla 3 , Jupiter 4 , Saturn 5 , asteroid Chiron 6 , Uranus 7 , Neptune 8 , and Pluto 9 .

⁰*Corresponding author.

E-mail address: perinova@prfnw.upol.cz (V. Peřinová)

In 1938 Mohorovičić invented an empirical formula [2], which describes the distances of planets and comets with high accuracy, and it also predicts an asteroid belt between Mars and Jupiter. Mohorovičić's law says that the distances of the inner parts of the solar system increase in a sublinear manner and those of the outer parts of this system increase in a superlinear manner. In the paper [3] we have modified this law such that it satisfies also other planetary systems and those of the moons of the giant planets.

Interesting is the empirical formula, which is similar to the laws of quantum mechanics [4]

$$r_{mn} = \frac{1}{2}(m^2 + n^2)r_0, \quad (2)$$

where m are natural numbers, $n = 0, 1, \dots, m$ and $r_0 = 0.387$ AU. The Bohr–Sommerfeld rule of (allowed) orbits for electrons in the electric fields of the nuclei of various atoms resemble the distribution of planetary distances, but do not let us forget that this rule describes bodies (electrons), which all have the same inertial mass and the same electric charge, which replaces a gravitational mass here. To obtain a distribution of the planetary distances, one either replaces different planetary masses by their mean mass, or makes the quantum of action depend on the actual mass.

Agnese and Festa described the solar system like a gravitational atom [5]. They utilized a quantum law for the hydrogen atom, which they applied to description of major semi-axes of allowed (discretized) elliptical orbits of the bodies of the planetary system

$$r_{nAF} = r_1 n^2, \quad (3)$$

where n are natural numbers and r_1 is the Bohr radius of the planetary system, which is

$$r_1 = \frac{GM}{\alpha_g^2 c^2}, \quad (4)$$

where G is the gravitational constant, M the mass of the central body, c the vacuum speed of light and α_g is a gravitational structure constant, which has the property $\frac{1}{\alpha_g} = 2113 \pm 15$. Agnese and Festa have shown that this description of distances satisfies also the planetary system v Andromedae [6] and other stellar systems alike on substituting the mass of the appropriate central star for the mass M . A study which elaborates on such ideas has been presented in [7].

Recently, the significance of the Titius–Bode law has been evaluated both by generating random planetary systems [8] and by the help of methods of the modern statistical analysis [9]. In the papers [10, 11] the authors point out quantum features also on large scales, namely discrete values of distances of possible planets and galaxies.

In quantum mechanics one utilizes Schrödinger's equation for the description of a physical system. In the paper [12], the stochastic mechanics is constructed, i. e., the Schrödinger equation is obtained as a classical diffusion equation by the help of the hypothesis that any particle in any interaction also exhibits a universal Brownian motion [13]. The main problem of this kind of derivation is a convincing physical origin for that universal Brownian motion, although a possibility is the quantum nature of space-time [14]. The chaotic behaviour of the solar system during its formation and evolution [15, 16] suggests a diffusion process to be described in terms of a Schrödinger-type equation. The description of the planetary system using a Schrödinger-type diffusion equation has been realized in [17]. There the authors have adapted the Schrödinger equation to the planetary system and shown that there exist very many orbits, on which possible planets may originate. That paper has stimulated us to the following considerations.

2 Discrete distances in the gravitational field of an astronomical body

Let us consider a body of the mass M_p , which orbits a central body of the mass M and has the potential energy $V(x, y, z)$ in its gravitational field. Because planets and moons of the giant planets revolve approximately in the same plane, we consider $z = 0$. Because they revolve in the same direction, we choose directions of the axes x , y and z such that the planets or moons of giant planets revolve counter-clockwise. Then we write the modified Schrödinger equation for the wave function $\psi = \psi(x, y)$ from the part of the Hilbert space $L_2(R^2) \cap C^2(R^2)$ and the eigenvalue $0 > E \in R$ in the form

$$-\frac{\hbar_M^2}{2M_p} \left(\frac{\partial^2}{\partial x^2} + \frac{\partial^2}{\partial y^2} \right) \psi + V(x, y)\psi = E\psi, \quad (5)$$

where $\hbar_M \approx 1.48 \times 10^{15} M_p$, $V(x, y) = V(x, y, z)$ and E is the total energy. Negative E classically correspond to the elliptic Kepler orbits and the localization property (bound state) is conserved also in the quantum mechanics for such total energies E . The factor 1.48×10^{15} is not a dimensionless number, but the unit of its measurement is $m^2 s^{-1}$. With respect to the unusual unit we do not wonder that Agnese and Festa [5] consider this factor in the form of a product, such that $\hbar_M = \bar{\lambda}_M c M_p$, where $\bar{\lambda}_M \approx 4.94 \times 10^6$ m.

We transform equation (5) into the polar coordinates,

$$-\frac{\hbar_M^2}{2M_p} \left(\frac{\partial^2 \tilde{\psi}}{\partial r^2} + \frac{1}{r} \frac{\partial \tilde{\psi}}{\partial r} + \frac{1}{r^2} \frac{\partial^2 \tilde{\psi}}{\partial \theta^2} \right) + \tilde{V}(r)\tilde{\psi} = E\tilde{\psi}, \quad (6)$$

where $\tilde{\psi} \equiv \tilde{\psi}(r, \theta) = \psi(r \cos \theta, r \sin \theta)$ and $\tilde{V}(r) = V(r \cos \theta, r \sin \theta)$ does not depend on θ . Particularly we choose

$$\tilde{V}(r) = -\frac{GM_p M}{r}. \quad (7)$$

With respect to the Fourier method we assume a solution of the equation (7) in the form

$$\tilde{\psi}(r, \theta) = R(r)\Theta(\theta). \quad (8)$$

The original eigenvalue problem is transformed, equivalently, to two eigenvalue problems

$$\Theta''(\theta) = -\Lambda\Theta, \quad (9)$$

$$\Theta(0) = \Theta(2\pi) \quad (10)$$

and

$$R''(r) + \frac{1}{r}R'(r) + \left\{ -\frac{\Lambda}{r^2} + \left[E - \tilde{V}(r) \frac{2M_p}{\hbar_M^2} \right] \right\} R(r) = 0, \quad (11)$$

$$\lim_{r \rightarrow 0^+} [\sqrt{r}R(r)] = 0, \quad \sqrt{r}R(r) \in L_2((0, \infty)). \quad (12)$$

The solution of the problem (9)–(10) has the form

$$\Theta_l(\theta) = \frac{1}{\sqrt{2\pi}} \exp(il\theta) \quad (13)$$

for $l = \pm\sqrt{\Lambda} \in Z$.

Here $l = 0$ should mean a body, which does not revolve at all. In the classical mechanics such a body moves close to a line segment ending at the central body, and it spends a short time in the vicinity of this body. In this paper we utilize some – not all – of the concepts

of quantum mechanics and we will not avoid the case $l = 0$ [17]. In (13) $l = 1, 2, \dots, \infty$ corresponds to the counter-clockwise revolution.

Respecting (7), the equation (11) becomes

$$R''(r) + \frac{1}{r}R'(r) + \left\{ -\frac{l^2}{r^2} - B - \frac{2M_p}{\hbar_M^2} \left(-\frac{GM_p M}{r} \right) \right\} R(r) = 0, \quad (14)$$

where

$$B = -\frac{2M_p E}{\hbar_M^2} = -\frac{2}{(\bar{\lambda}_{Mc})^2} \frac{E}{M_p}. \quad (15)$$

Let us note that

$$\frac{M_p GM_p M}{\hbar_M^2} = \frac{GM}{(\bar{\lambda}_{Mc})^2}. \quad (16)$$

On substituting $r = \frac{\rho}{2\sqrt{B}}$ and introducing

$$\tilde{R}(\rho) = R\left(\frac{\rho}{2\sqrt{B}}\right), \quad (17)$$

equation (14) becomes

$$\tilde{R}''(\rho) + \frac{1}{\rho}\tilde{R}'(\rho) + \left(-\frac{1}{4} + \frac{k}{\rho} - \frac{l^2}{\rho^2}\right)\tilde{R}(\rho) = 0, \quad (18)$$

where

$$k = \frac{GM}{(\bar{\lambda}_{Mc})^2 \sqrt{B}}. \quad (19)$$

For later reference let us note that, inversely,

$$\sqrt{B} = \frac{GM}{(\bar{\lambda}_{Mc})^2 k}, \quad (20)$$

$$\frac{-E}{M_p} = \frac{(\bar{\lambda}_{Mc})^2}{2} B \quad (21)$$

$$= \frac{(GM)^2}{2(\bar{\lambda}_{Mc})^2 k^2}. \quad (22)$$

Expressing $\tilde{R}(\rho)$ in the form

$$\tilde{R}(\rho) = \frac{1}{\sqrt{\rho}} u(\rho), \quad (23)$$

we obtain an equation for $u(\rho)$

$$u''(\rho) + \left[-\frac{1}{4} + \frac{k}{\rho} - \left(l'^2 - \frac{1}{4} \right) \frac{1}{\rho^2} \right] u(\rho) = 0, \quad (24)$$

where $l' = l$. It is familiar that this equation has two linear independent solutions $M_{k,l'}(\rho)$, $M_{k,-l'}(\rho)$, if l' is not an integer number. When l' is integer, the solution $M_{k,-l'}(\rho)$ must be replaced with a more complicated solution. It can be proven that the other solution is not regular for $\rho = 0$ (it diverges as $\ln \rho$ for $\rho \rightarrow 0$). The remaining solution $M_{k,l}(\rho)$ can be transformed to a wave function from the space $L_2((0, \infty))$ if and only if $k - l - \frac{1}{2} = n_r$ is any nonnegative integer number. We choose this function to be

$$u_{kl}(\rho) = C_{kl} M_{k,l}(\rho), \quad (25)$$

where C_{kl} is an appropriate normalization constant and $M_{k,l}(\rho)$ is a Whittaker function, namely

$$M_{k,l}(\rho) = \rho^{l+\frac{1}{2}} \exp\left(-\frac{\rho}{2}\right) \Phi\left(l-k+\frac{1}{2}, 2l+1; \rho\right), \quad (26)$$

where Φ is the confluent (or degenerate) hypergeometric function. In (25) the constant C_{kl} has the property

$$\int_0^\infty r[R_{kl}(r)]^2 dr = 1, \quad (27)$$

or it is

$$C_{kl} = 2\sqrt{B} \frac{1}{(2l)!} \sqrt{\frac{(n+l-1)!}{2k(n-l-1)!}}. \quad (28)$$

Then

$$R_{kl}(r) = 2\sqrt{B} \sqrt{\frac{(n-l-1)!}{2k\Gamma(n+l)}} \exp(-r\sqrt{B})(2r\sqrt{B})^l L_{n-l-1}^{2l}(2r\sqrt{B}), \quad (29)$$

where $n = k + \frac{1}{2}$, $L_{n-l-1}^{2l}(x)$ is a Laguerre polynomial, and the relation (20) holds.

3 Interpretation of formulae derived

Having solved the modified Schrödinger equation, we address interpretation of the formulae derived. The probability density $P_{kl}(r)$ of the revolving body occurring at the distance r from the central body is

$$P_{kl}(r) = r[R_{kl}(r)]^2, \quad r \in [0, \infty). \quad (30)$$

Mean distances of the planets are given by the relation

$$r_{kl} = \int_0^\infty r P_{kl}(r) dr \quad (31)$$

$$= \frac{(\bar{\lambda}_{MC})^2}{4GM} [(2k - n_r)(2k - n_r + 1) + 4n_r(2k - n_r) + n_r(n_r - 1)], \quad (32)$$

where $n_r = n - l - 1$, $k = \frac{1}{2}, \frac{3}{2}, \frac{5}{2}, \dots, \infty$ and $l = 0, 1, 2, \dots, n$.

For the solar system $M = M^{\text{Sun}}$ holds and the Bohr radius of the solar system $r_{\frac{1}{2}0} = 0.055$ AU. For survey one finds some expectation values r_{kl} for selected values k, l with the specification of described bodies in table 1 (cf. [17]).

Even though also in this case an empirical formula is tested for distribution of planetary distances, the predicted orbits fit those of the bodies in this solar system.

Using the graphs of the probability densities we have plotted for every predicted orbit of this system, we obtain surprising results. The graphs of the probability densities for each orbit with $k \leq \frac{9}{2}$ and with $\frac{11}{2} \leq k \leq \frac{31}{2}$ are contained, respectively, in figure 1 and in figure 2. The vertical axis denotes the probability density $P_{kl}(r)$ and the longitudinal axis designates the planetary distance r from the Sun. In figure 1 graph no. $p = 1$ is interpreted such that the highest probability density is assigned to the orbit of the radius of 0.055 AU and from the calm shape of the graph we infer that an ideal circular orbit is tested. In figure 1 graph no. $p = 14$ is interpreted such that the highest probability density is assigned to the orbit of the radius of 3.32 AU and, of many peaks, which wave the shape, we infer that no stable circular orbit is tested. After performing the analysis for all the orbits, we obtain only a small number of stable circular orbits. The orbits, on which big bodies – planets – may originate, are listed in table 2.

It emerges that, for every number k , there exists only one stable orbit, on which a big body – a planet – may originate. Then we can interpret the number k as the principal

quantum number and l as the orbital quantum number equal to the number of possible orbits, but only for the greatest l there exists a stable orbit of a future body. A planet which does not confirm this theory is the Earth. Since the description based on the modified Schrödinger equation for the planetary system is not fundamental, it could not fit all the stable orbits. Other deviations are likely to be incurred by collisions of the bodies in early stages of the origin of the planets, thus nowadays we already observe elliptical orbits, which are very close to circular orbits.

This procedure has been applied to moons of giant planets by us. It emerges that the moons of giant planets also are fitted by the modified Schrödinger equation and appropriate expectation values. Especially, the predicted stable circular orbits of Jupiter's moons are presented in table 3. For Jupiter it holds that $M = M^{\text{Jup}}$ and the Bohr radius (4) of this system $r_1 = 6287$ km. It emerges that the predicted lunar orbits fit the measured orbits of the moons orbiting Jupiter.

4 Conclusions

In this paper we assume that there exists a law by which big objects – planets and moons of giant planets – do not originate anywhere, but at allowed distances from the central body. Unnegligible number of authors have issued from similar assumptions and derived empirical formulae for parameters of allowed orbits.

The results we have presented in this paper are based on a modified Schrödinger equation, which has been applied to the planetary system by us for the quantum theory contained in the Schrödinger equation to create an interesting view of the birth of such a stellar system, namely the orbits of planets and moons being approximately quantized.

5 Acknowledgements

This work under the research project “Measurement and information in optics” No. MSM 6198959213 was supported by the Ministry of Education of the Czech Republic. The authors acknowledge Jaromír Křepelka for his help in the preparation of the figures.

References

- [1] Nieto MM. The Titius–Bode Law of Planetary Distances: Its History and Theory. Oxford: Pergamon Press, 1972.
- [2] Guth V, Link F, Mohr JM, Šternberk B, Astronomy, Vol. I. Prague: Czechoslovak Academy of Sciences Press, 1954 (in Czech).
- [3] Pintr P, Peřinová V. The solar system from the quantization viewpoint. Acta Universitatis Palackianae, Physica, 2003–2004; 42–43: 195–209.
- [4] De Oliveira Neto N. A Niels Bohr-like atomic model for planetary orbit description. Ciência e Cultura (Journal of the Brazilian Association for the Advancement of Science), 1996; 48: 166–171.
- [5] Agnese AG, Festa R. Clues to discretization on the cosmic scale. Physics Letters A, 1997; 227: 165–171.
- [6] Agnese AG, Festa R. Discretizing v -Andromedae planetary system. astro-ph/9910534, v2, 1999.

- [7] Rubčić A, Rubčić J. The Quantization of the solar-like gravitational systems. *Fizika B*, 1998; 7: 1-13.
- [8] Hayes W, Tremaine S. Fitting selected random planetary systems to Titius-Bode laws. *Icarus*, 1998; 135: 549-557.
- [9] Lynch P. On significance of the Titius–Bode law for the distribution of the planets. *Monthly Notices of the Royal Astronomic Society*, 2003; 341: 1174-1178.
- [10] Greenberger DM. Quantization in the Large. *Foundations of Physics*, 1983; 13: 903-951.
- [11] Carvalho JC. On Large-Scale Quantization. *Lettere al Nuovo Cimento*, 1985; 6: 337-342.
- [12] Nelson E. Derivation of the Schrödinger Equation from Newtonian Mechanics. *Physical Review*, 1966; 4: 1079-1085.
- [13] El Naschie MS, Rossler E, Prigogine I. *Quantum Mechanics, diffusion and chaotic fractals*. Oxford: Pergamon Press, 1995.
- [14] Smolin L. Atoms of space and time. *Scientific American (Czech edition)*, 2004; 22–25: 124-129.
- [15] Laskar J. A numerical experiment on the chaotic behaviour of the Solar System. *Nature*, 1989; 338: 237–238.
- [16] Sussman GJ, Wisdom J. Chaotic evolution of the Solar System. *Science*, 1992; 257: 56–62.
- [17] De Oliveira Neto M, Maia LA, Carneiro S. An alternative theoretical approach to describe planetary systems through a Schrödinger-type diffusion equation. *Chaos, Solitons and Fractals*, 2004; 21: 21-28.

Table 1. Predicted distances of bodies from the Sun

Body	k	l	r_{kl} [AU]
—	$\frac{1}{2}$	0	0.055
Mercury	$\frac{3}{2}$	1	0.332
Mercury	$\frac{5}{2}$	0	0.387
Venus	$\frac{7}{2}$	2	0.829
Earth	$\frac{9}{2}$	1	0.995
Earth	$\frac{11}{2}$	0	1.050
Mars	$\frac{13}{2}$	3	1.548
Hungaria	$\frac{15}{2}$	2	1.824
Hungaria	$\frac{17}{2}$	1	1.990
Hungaria	$\frac{19}{2}$	0	2.046
Vesta	$\frac{21}{2}$	4	2.488
Ceres	$\frac{23}{2}$	3	2.875
Hygeia	$\frac{25}{2}$	2	3.151
Camilla	$\frac{27}{2}$	1	3.317
Camilla	$\frac{29}{2}$	0	3.372
Jupiter	$\frac{31}{2}$	0	5.031
—	$\frac{13}{2}$	0	7.021
Saturn	$\frac{15}{2}$	0	9.343
Chiron	$\frac{17}{2}$	0	11.997
Chiron	$\frac{19}{2}$	0	14.982
Uranus	$\frac{21}{2}$	0	18.300
—	$\frac{23}{2}$	0	21.948
HA2 (1992), DW2 (1995)	$\frac{25}{2}$	0	25.929
Neptune	$\frac{27}{2}$	0	30.241
—	$\frac{29}{2}$	0	34.885
Pluto	$\frac{31}{2}$	0	39.861

Table 2. Bodies with stable circular orbits.

Body	k	l	r_{kl} [AU]
—	$\frac{1}{2}$	0	0.055
Mercury	$\frac{3}{2}$	1	0.332
Venus	$\frac{5}{2}$	2	0.83
Mars	$\frac{7}{2}$	3	1.54
Vesta	$\frac{9}{2}$	4	2.49
Fayet comet	$\frac{11}{2}$	5	3.64
Jupiter	$\frac{13}{2}$	6	5.03
Neujmin comet	$\frac{15}{2}$	7	6.636
—	$\frac{17}{2}$	8	8.46
Saturn	$\frac{19}{2}$	9	10.5
—	$\frac{21}{2}$	10	12.77
Westphal comet	$\frac{23}{2}$	11	15.26
Pons–Brooks comet	$\frac{25}{2}$	12	17.97
Uranus	$\frac{27}{2}$	13	20.9
—	$\frac{29}{2}$	14	24.055
—	$\frac{31}{2}$	15	27.43
Neptune	$\frac{33}{2}$	16	31.02
—	$\frac{35}{2}$	17	34.84
Pluto	$\frac{37}{2}$	18	38.88
—	$\frac{39}{2}$	19	43.134

Table 3. Moons of Jupiter with stable circular orbits.

Body	k	l	r_{kl} [km]
—	$\frac{1}{2}$	0	6287
—	$\frac{3}{2}$	1	37722
Halo ring	$\frac{5}{2}$	2	94305
Outer ring	$\frac{7}{2}$	3	176036
—	$\frac{9}{2}$	4	282915
Io	$\frac{11}{2}$	5	414942
Europa	$\frac{13}{2}$	6	572117
—	$\frac{15}{2}$	7	754440
—	$\frac{17}{2}$	8	961911
Ganymede	$\frac{19}{2}$	9	1.19×10^6
—	$\frac{21}{2}$	10	1.452×10^6
Callisto	$\frac{23}{2}$	11	1.735×10^6

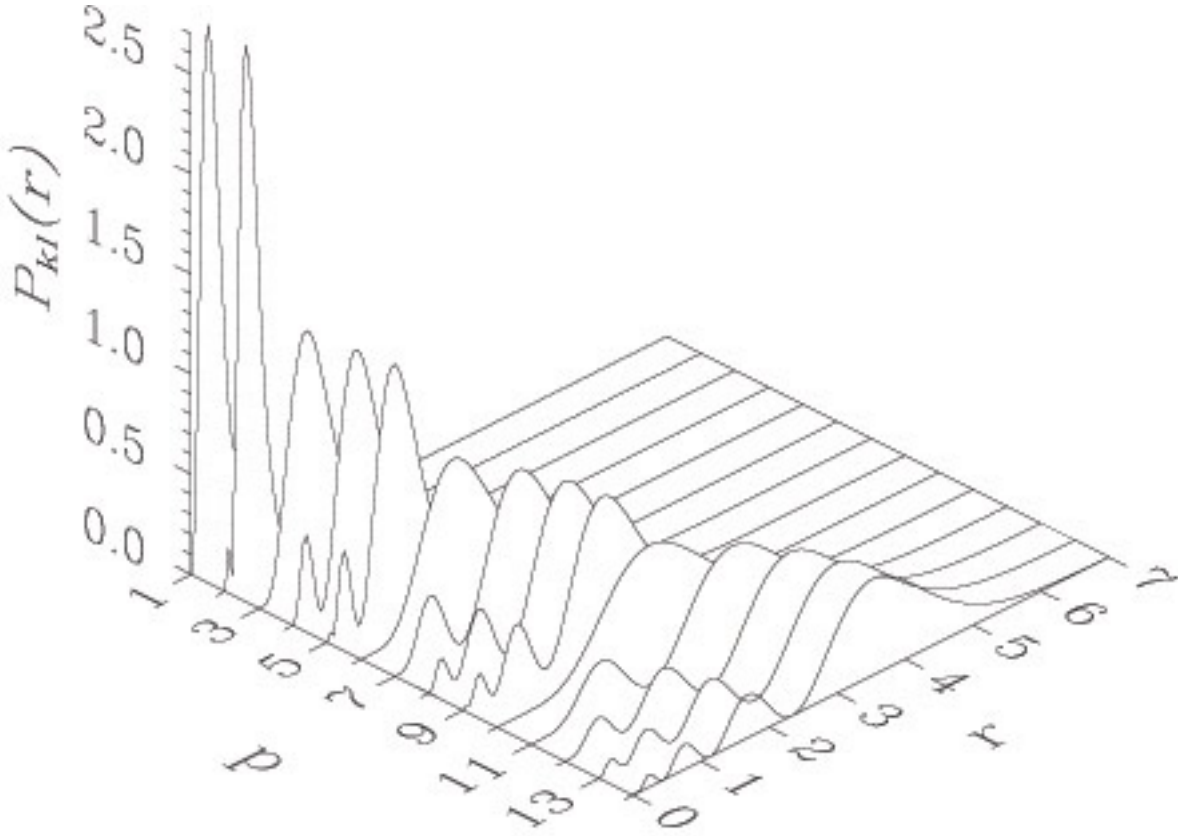

Figure 1: Probability densities for a particle in states with quantum numbers k, l , which correspond, respectively, (p is an ordinary number) to Mercury ($p = 1, l = 1$), Mercury ($p = 2, l = 0$, the second possibility), Venus ($p = 3, l = 2$), Earth ($p = 4, l = 1$), Earth ($p = 5, l = 0$, the second possibility), Mars ($p = 6, l = 3$), asteroid Hungaria ($p = 7, l = 2$), asteroid Hungaria ($p = 8, l = 1$, the second possibility), asteroid Hungaria ($p = 9, l = 0$, the third possibility), asteroid Vesta ($p = 10, l = 4$), asteroid Ceres ($p = 11, l = 3$), asteroid Hygeia ($p=12, l = 2$), asteroid Camilla ($p = 13, l = 1$), and asteroid Camilla ($p = 14, l = 0$, the second possibility). Here $k \in \{\frac{3}{2}, \frac{5}{2}, \dots, \frac{9}{2}\}$, the quantum number k repeats $n(= k + \frac{1}{2})$ times and r is measured in AU.

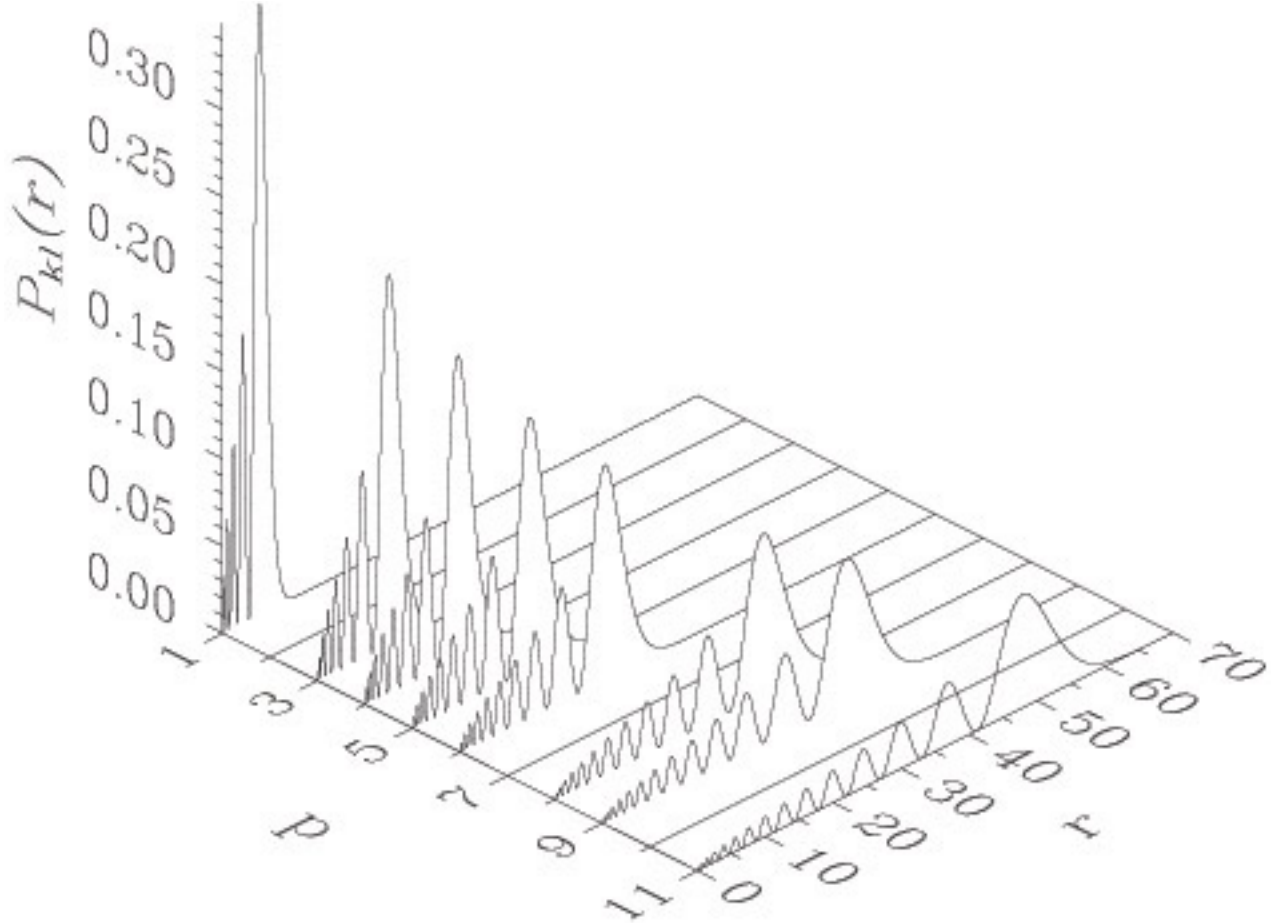

Figure 2: Probability densities for a particle in states with quantum numbers k, l , which correspond, respectively, (p is an ordinary number) to Jupiter ($p = 1$), nothing ($p = 2$), Saturn ($p = 3$), Chiron ($p = 4$), Chiron ($p = 5$, the second possibility), Uranus ($p = 6$), nothing ($p = 7$), HA2 (1992), DW2 (1995) ($p = 8$), Neptune ($p = 9$), nothing ($p = 10$) and Pluto ($p = 11$), $k \in \{\frac{11}{2}, \frac{13}{2}, \dots, \frac{31}{2}\}$, $l = 0$. Here $k = p + \frac{9}{2}$, r is measured in AU.

New cosmological model of universe and possible quantization of the Hubble parameter

Pavel Pintr

Joint Laboratory of Optics, Palacký University, RCPTM,
17. listopadu 12, 77146 Olomouc, Czech Republic

Abstract

We propose new cosmological model of the universe on the basis of a recombination and an ionization of the hydrogen atom. According to the Bohr atomic model, we can explain main epochs in the universe in agreement with observations. We can predict current values of the Hubble parameter according to WMAP observation. We derive that the Hubble parameter can be quantized in time according to the quantum numbers and we express the dependence of the Hubble parameter on time.

1 Introduction

The connection of quantum physics with relativity is main physical problem of 21st century. Many authors have searched for this connection using the rescaled Planck constant [1, 2]. Carneiro [3] has shown that there exists a rescaling factor λ for the large-scale quantization,

$$\lambda = \frac{T}{t} = \frac{R}{r} = \sqrt{\frac{M}{m}}, \quad (1)$$

where T , R , and M are age, size, and mass of the universe, respectively, t , r , and m are typical values of time, length, and mass appearing in particle physics, respectively. It emerges that this scaling factor is equal just to a power of ten. A scaling factor $\lambda \sim 10^{38-41}$ is assigned to the size of galaxies and thus the rescaled Planck constant is $H \sim 10^{81}$, where $H = h\lambda^3$. This is really in good agreement with the Dirac large number hypothesis. Dirac [4] has arrived at the revolutionary hypothesis that the gravitational constant G varies in time. Many authors have applied these ideas to a new cosmological model of space with better or worse success. Nottale [5] has discussed a cosmological constant Λ as sum of a general relativistic term and of a quantum term, scale-varying, gravitational self-energy of virtual pairs in agreement with present observational limits. Shemi-zadeh [6] has found the equality of fundamental large numbers to the exponent of the inverse value of the fine structure constant. The scaling law for the cosmological constant has been applied [7] in the connection with the standard cosmological model. Berman and Trevisan [8, 9] have derived a possible time dependence of some other parameters of the universe (the number of nucleons, the speed of light c , the gravitational constant G , and the energy density. The variation of basic fundamental constants has big impact on the planetary science, the cosmology, and the evolution of stars.

⁰E-mail address: AstroPintr@seznam.cz (P. Pintr)

We can find very interesting description and also discussions about the time dependence of basic fundamental constants in [10].

Tift [11, 12] has published a possible redshift quantization. He has indicated the quantization of the distances to galaxies from the Earth. Arp [13, 14] has studied the redshift quantization from his observations and Guthrie and Napier [15] have found the redshift periodicity in local supercluster. These results showed that the quantization at large scales could be possible. But other authors have criticized the redshift quantization. According to [16], intermediate periodicities in the redshifts are due to other geometric irregularities. Hawkins et al. [17] have found no evidence for the redshift quantization in the 2dF survey. Bajan et al. [18] have published a historical review of the redshift quantization. Their conclusion has been that the redshift quantization is an effect which can really exist and they have studied a periodicity in the Local Group of galaxies and the Hercules Supercluster.

It is clear that the question of the redshift quantization is really open and only precise observations could help to solve this open problem. In this paper, we would like to explain why the redshift quantization could exist. We propose a new cosmological model of the universe on the basis of the hydrogen atom.

2 Hydrogen atomic cosmological model of the universe

According to the standard cosmological model, we can divide a history of the universe into four epochs:

- the inflation phase of the universe,
- the time $t_{(\text{rec})}$ when the radiation separates from the matter (the recombination of atoms),
- the time $t_{(\text{ion})}$ of the reionization of atoms and the creation of stars of first generation,
- the current time t_0 with today's value of the Hubble parameter.

We know exact values of the age of the universe for each epoch only from some observations. Each new cosmological model should fit these values of the observations. One main problem of the standard cosmological model is to determine exact value of the Hubble parameter H_0 , because a correct theoretical model is missing. Without such a theoretical model, we are not able to predict even values of the Hubble parameter in previous stages of the universe. We know the value of the Hubble parameter only from the observation [19]. Based upon measurements of gravitational lensing by using the HST, a value of $H_0 = 72.6 \pm 3.1$ km/s/Mpc has been obtained. WMAP seven-year results, also from 2010, provide an estimate of $H_0 = 71.0 \pm 2.5$ km/s/Mpc.

We propose a new theoretical cosmological model using the properties of the hydrogen atom. The idea is that a history of the universe is connected with the physics at atomic scales (the creation of atoms, the ionization of atoms, etc.). We understand that the hydrogen atom is an isolated system. It means that during the evolution of the universe, the mass of the electron m_e does not vary in time and also a speed of light c does not vary in time, because the small variability of these constants renders the hydrogen atomic model unstable.

We study a simplified model of the hydrogen atom and address to the following consideration, which comes out of the Kepler second law: Areas which are swept out by the radius vector of planet in equal time intervals are equal, so the elementary area swept out by the radius vector of planet in the aphelium in the time dt is the same as the elementary area swept out by the radius vector of planet in the perihelium in the time dt . For the area which

is swept out by the radius vector of electron in the circular model, the Kepler second law is valid as well. It holds that

$$r_e v_e = 2W, \quad (2)$$

where W is the areal velocity of the electron on the Bohr orbit, r_e is the Bohr radius, v_e is an orbital speed of the electron on the Bohr radius. The relation (2) can be rewritten in the form

$$\frac{r_e v_e}{m_e} = \frac{2W}{m_e}. \quad (3)$$

Now we will concentrate on the left-hand side of equation (3). It holds that

$$\frac{r_e v_e}{2m_e} = \frac{c\alpha_e r_e}{2m_e}, \quad (4)$$

where we substituted $v_e = c\alpha_e$ according to [20]. The parameter $\alpha_e = 1/137.036$ is the fine structure constant. According to the Hubble observation, it is valid that the speed of galaxies depends on the distances of galaxies from an observer. The Hubble law is of the form

$$rH_0 = v_H, \quad (5)$$

where r is the distance to galaxy from the Earth, H_0 is the Hubble parameter, v_H is the Hubble speed. Multiplying equation (4) by the Hubble parameter, we get

$$\frac{r_e v_e}{2m_e} H_0 = \frac{c\alpha_e r_e}{2m_e} H_0 \quad (6)$$

or equivalently

$$\frac{r_e v_e}{m_e} \frac{H_0}{2} = \frac{c\alpha_e v_{He}}{m_e}, \quad (7)$$

where $v_{He} = r_e \frac{H_0}{2}$. Applying the substitution

$$A = \frac{\alpha_e v_{He}}{m_e}, \quad (8)$$

we get the parameter A in the units $[\text{ms}^{-1}\text{kg}^{-1}]$ and it holds that

$$\frac{r_e v_e}{m_e} \frac{H_0}{2} = cA \quad (9)$$

or equivalently

$$\frac{r_e v_e}{m_e A} \frac{H_0}{2} = c. \quad (10)$$

Introducing the notation r_u for a distance with $v_H = c$,

$$\frac{r_e v_e}{2m_e A} = r_u, \quad (11)$$

we get the Hubble law in the form

$$r_u H_0 = c. \quad (12)$$

What kind of physical mechanism produces an expansion according to the Hubble law? We discuss equation (8). We can substitute

$$p_A = \frac{v_{He}}{m_e}, \quad (13)$$

where a parameter p_A is in unusual units [$\text{ms}^{-1}\text{kg}^{-1}$]. This parameter resembles a momentum, but with an inverse mass $1/m_e$. According to this, we apply the substitution and transform the units in the form

$$\frac{1}{m_e}K = m_A, \quad (14)$$

where m_A is the inverse mass to m_e in the unit [kg] and a parameter $K = 1$ in the unit [kg^2]. It is valid that

$$m_e m_A = K, \quad (15)$$

and we call K the "inverse unit parameter".

We understand the inverse mass m_A as the mass of dark energy, which has the repulsive character and now we understand the parameter P_A as the momentum of dark energy in correct units. We can modify equation (13) in the form

$$p_A = \frac{m_A r_e H_0}{2K}, \quad (16)$$

where after the modification, it is valid

$$p_A K = P_A = m_A r_e \frac{H_0}{2}, \quad (17)$$

where P_A is the momentum of dark energy and for the Hubble parameter H_0 in the hydrogen atomic model it is valid that

$$H_0 = \frac{2P_A m_e}{r_e K}. \quad (18)$$

Multiplying equation (16) by a half of the Hubble parameter, $H_0/2$, we get a repulsive force F_A of dark energy in the form

$$F_A = p_A K \frac{H_0}{2} = \frac{m_A r_e H_0^2}{4}. \quad (19)$$

3 Epoch of universe - Radiation separates from matter

Now we can define a time $t_{(\text{rec})}$ of the universe, when atoms recombined together. In another words, we understand a recombination of atoms as the recombination to stable atoms. The hydrogen atom is stable on the first energy level $n = 1$, which is equal to the Bohr radius of electron r_e and it is valid that $F_e = F_o$, where F_o is the centrifugal force. It means that the electrical force F_e between the electron and the proton is equal to the centrifugal force F_o . According to this, the electron will be on the stable orbit r_e . We can write

$$F_e = F_o = \frac{1}{4\pi\epsilon_0} \frac{|e_1 e_2|}{r_e^2} = m_e \frac{v_e^2}{r_e}, \quad (20)$$

where r_e is a distance between the electron and the proton, e_1 is the charge of the electron, $e_1 = -e$ and e_2 is the charge of the proton, $e_2 = e$, with an elementary charge $e = 1.602 \times 10^{-19}\text{C}$. As the atoms recombine when $F_o = F_A$, we can write equation (20) in the form

$$F_e = F_A = \frac{m_A}{4} r_e H_{(\text{rec})}^2 \quad (21)$$

and express the Hubble parameter in the time of recombination in the form

$$H_{(\text{rec})} = \sqrt{\frac{4F_e}{m_A r_e}} \quad (22)$$

and for the recombination time $t_{(\text{rec})}$ it is valid that

$$t_{(\text{rec})} = \frac{1}{H_{(\text{rec})}}, \quad (23)$$

where we used $F_e = 8.24 \times 10^{-8}$ N.

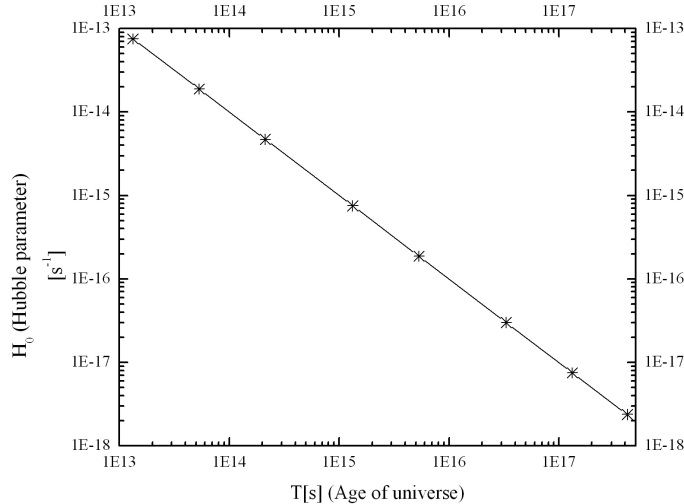

Figure 1: Dependence of the Hubble parameter H_0 on the age T of the universe.

The dependence of the Hubble parameter H_0 on the age T of the universe is depicted in Figure 1. It is obvious that the Hubble parameter decreases with the increasing age of the universe. Using this dependence, we can calculate main epochs in the history of the universe. According to these results, our model is in good agreement with the observation of microwave background in the framework of the standard cosmological model of the universe with $t_{(\text{rec})} = 420000$ years after the Big Bang.

4 Epoch of universe - Formation of stars of first generation

The ionization of atoms and the formation of stars of first generation is next main epoch of the universe. According to the model for the ionization of the hydrogen atom, it holds that $n \gg 1$ and for a distance of the electron on the orbit n to the nucleus, it holds that $r_n > r_e$. For a distance r_n , it is valid that

$$r_n = r_e n^2 \quad (24)$$

according to the Bohr model of the hydrogen atom and for F_{en} it holds that

$$F_{en} = F_o = F_A = \frac{1}{4\pi\epsilon_0} \frac{|e_1 e_2|}{r_n^2} = m_e \frac{v_{en}^2}{r_n} = \frac{m_A r_n H_0^2}{4}, \quad (25)$$

where ϵ_0 is the permittivity of free space. The Hubble parameter $H_{(\text{ion})}$ for the ionization of the hydrogen atom is of the form

$$H_{(\text{ion})} = \sqrt{\frac{4F_{en}}{m_A r_n}}, \quad (26)$$

where $F_{en} = 5.15 \times 10^{-13}$ N, $n = 20$. We get a time $t_{(\text{ion})}$ in the form

$$t_{(\text{ion})} = \frac{1}{H_{(\text{ion})}}. \quad (27)$$

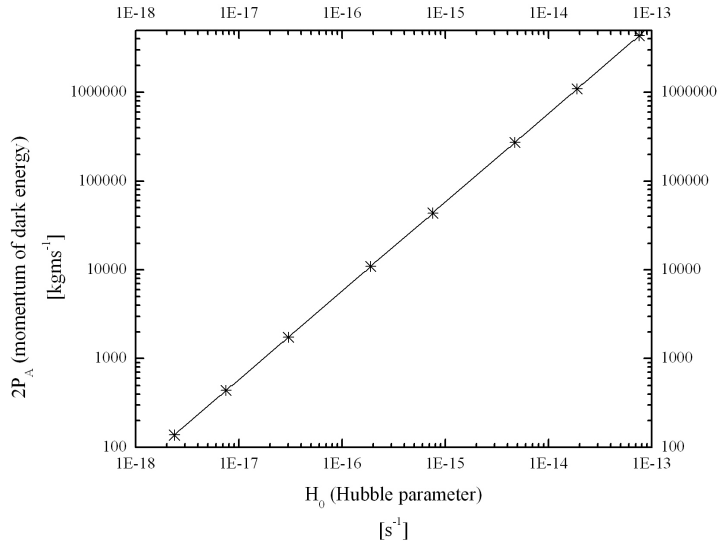

Figure 2: Dependence of the momentum of dark energy $2P_A$ on the Hubble parameter H_0 .

The dependence of the momentum of dark energy $2P_A$ on the Hubble parameter H_0 is illustrated in Figure 2. The momentum of dark energy $2P_A$ is linearly proportional to the Hubble parameter.

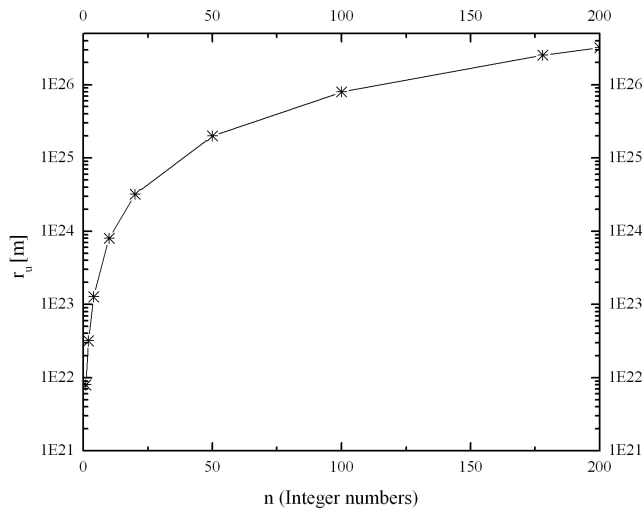

Figure 3: Dependence of the diameter of universe r_u on the integer numbers n .

The dependence of the diameter of universe r_u on the integer numbers n is depicted in Figure 3. The diameter of universe increases rapidly from $n = 1$ to $n = 20$ and for $n > 20$

increases slowly. For $n = 1$, the recombination of atoms sets in, for $n = 20$, the ionization of atoms and the formation of stars of first generation set in, for $n = 178$, the present times set in.

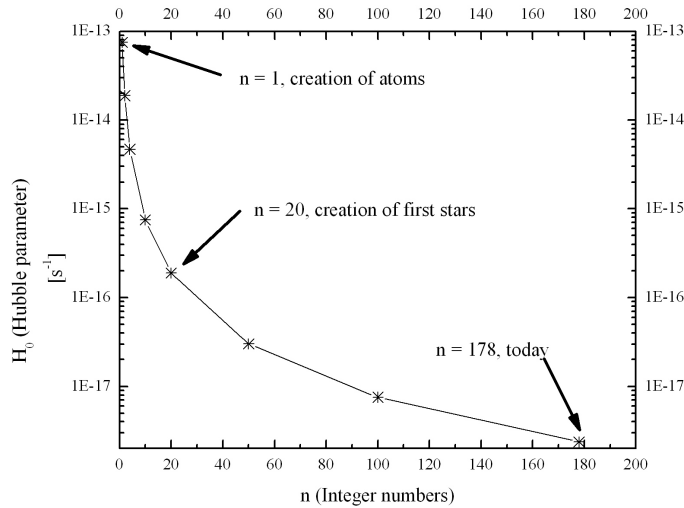

Figure 4: Dependence of the Hubble parameter H_0 on the integer numbers n .

The dependence of the Hubble parameter H_0 on the integer numbers n is illustrated in Figure 4. For $n = 1$, the recombination of atoms sets in, for $n = 20$, the ionization of atoms and the formation of stars of first generation set in, for $n = 178$, the present times set in. These results are in good agreement with the standard cosmological model of the universe with $t_{(\text{ion})} = 168 \times 10^6$ years after the Big Bang.

5 Current value of the Hubble parameter

For a prediction of current value of the Hubble parameter, it is necessary to find a correct mathematical relation. For an illustration, we can use $n \gg 1$ in equation (26). According to the observational WMAP data, the value of the Hubble parameter should be $H_0 = 71.0 \pm 2.5$ km/s/Mpc. Applying this tolerance to the graph, we can see a connection of the momentum of dark energy $2P_A$ with the Hubble parameter H_0 . Five possible results fall into the area of tolerance for the current Hubble parameter according to WMAP data (see Figure 5 and Table 1).

The prediction of current value of the Hubble parameter H_0 is plotted in Figure 5. On the graph, we can follow the tolerance for the Hubble parameter according to WMAP observation. Five possible results fall into this tolerance for $n = 178, 179, 180, 181, 182$.

After the modification of equation (16), we get

$$p_A = \frac{m_A r_n H_0}{2K} \quad (28)$$

and for the Hubble parameter H_0 it holds that

$$H_0 = \frac{2K p_A}{m_A r_n}. \quad (29)$$

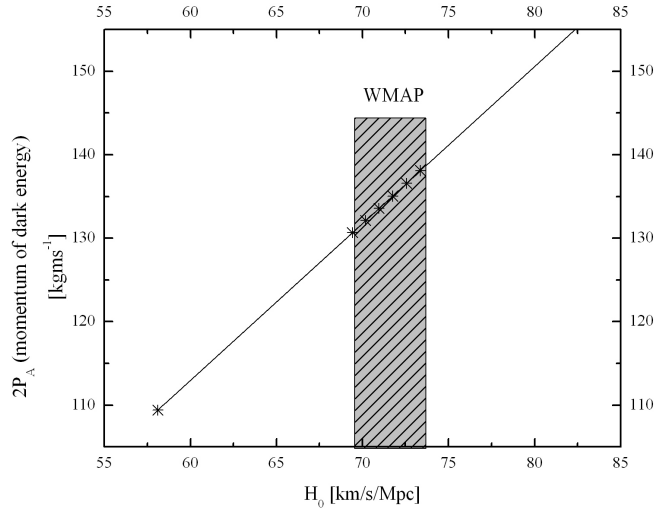

Figure 5: Prediction of current value of the Hubble parameter H_0 .

Table 1: Predictions of the Hubble parameter

n	H_0 [s^{-1}]	P_A	$2P_A$	H_0 [km/s/Mpc]
178	2.37×10^{-18}	69.05	138.11	73.36
179	2.35×10^{-18}	68.28	136.57	72.54
180	2.32×10^{-18}	67.53	135.06	71.74
181	2.29×10^{-18}	66.78	133.57	70.95
182	2.27×10^{-18}	66.05	132.11	70.17

The comparison of results obtained in the framework of the standard model of the universe with those obtained in the framework of the hydrogen atomic cosmological model of the universe can be performed on the basis of Tables 2 and 3.

Table 2: Standard cosmological model

Parameter	Marking	Value	Comments
Hubble's parameter	H_0 [km/s/Mpc]	71 ± 2.5	only from measurements
Age of universe	T_u [years]	$13.4 \pm 0.3 \times 10^9$	calculation
Recombination of atoms	$t_{(\text{rec})}$ [years]	380000	from observation
Ionization of atoms	$t_{(\text{ion})}$ [years]	200×10^6	from observation
Total mass	M_{tot}	1 ± 0.02	including dark matter

Table 3: Hydrogen atomic cosmological model

Parameter	Marking	Value	Comments
Hubble's parameter	H_0 [km/s/Mpc]	72.54	calculation for $n = 179$
Age of universe	T_u [years]	13.44×10^9	calculation
Recombination of atoms	$t_{(\text{rec})}$ [years]	420978	calculation for $n = 1$
Ionization of atoms	$t_{(\text{ion})}$ [years]	168×10^6	calculation for $n = 20$
Total mass	M_{tot}	1	product of dark energy and mass

6 Epoch of universe - phase of inflation

In our model, we define a phase of inflation if $F_A \gg F_e$. In this phase, the repulsive force F_A is much higher than the Coulomb force F_e and therefore atoms could not be stable and exist. It is very difficult to predict the value of the Hubble parameter in the epoch of inflation. It is not possible to apply the hydrogen atomic cosmological model. However, we understand that the calculation of the Hubble parameter in this epoch can be based on a model of nucleus of the hydrogen atom with nuclear forces. According to the hydrogen atomic cosmological model, the speed of light does not vary in time during all epochs, because of the recombination of atoms.

7 Conclusion

We propose new theoretical cosmological model of the universe in the analogy with the hydrogen atom. According to the Bohr model of the hydrogen atom, we characterize main epochs in the universe for the time of the recombination of atoms ($t_{(\text{rec})}$) and that of the reionization of atoms $t_{(\text{ion})}$. We predict also current values of the Hubble parameter according to WMAP measurements. We derive the relation for temporal dependence of the Hubble parameter. In this model, we discuss also properties of dark energy. According to our study, the Hubble parameter does not change continuously in time, but it changes discontinuously in the dependence on the quantum numbers n . We provide the comparison with results obtained in the framework of the standard model of the universe.

8 Acknowledgements

The author would like to thank prof. Peřinová and Dr. Lukš for comments and discussions and Dr. Prouza for remarks. Support by the project Operational Program Research and Development for Innovations - European Social Fund (project CZ.1.05/2.1.00/03.0058) of the Ministry of Education of the Czech Republic is acknowledged.

References

- [1] Greenberger D. M.: Quantization in the large. *Foundations of Physics* 13, 903-951 (1983).
- [2] Carvalho J. C.: On large-scale quantization. *Lettere al Nuovo Cimento* 6, 337-342 (1985).
- [3] Carneiro S.: The large numbers hypothesis and quantum mechanics. *Foundations of Physics Letters* 11 (1), 95-102 (1998).
- [4] Dirac P. A. M.: Cosmological models and large numbers hypothesis. *Proc. Roy. Soc. London A* 338, 439-446 (1974).
- [5] Nottale L.: Mach's principle, Dirac's large numbers and the cosmological constant problem. <http://luth2.obspm.fr/luthier/nottale/arlambda.pdf>.
- [6] Shemi-zadeh V. E.: Coincidence of large numbers, exact value of cosmological parameters and their analytical representation. *arXiv:gr-qc/0206084v3*, (2002).
- [7] Funkhouser S.: A new large-number coincidence and a scaling law for the cosmological constant. *arXiv:physics/0611115* (2008).
- [8] Berman M. S., Trevisan, L. A.: On a time varying fine structure constant. *arXiv:gr-qc/0111102* (2002).
- [9] Berman M. S., Trevisan, L. A.: Possible cosmological implications of time varying fine structure constant. *arXiv:gr-qc/0111102* (2001).
- [10] Ray S., Mukhopadhyay U., Ghosh P. P.: Large number hypothesis: A review. *arXiv:0705.1836v1* (2007).
- [11] Tifft W. G.: Discrete states of redshift and galaxy dynamics. II. Systems of galaxies. *Astrophysical Journal* 291, 88 (1985).
- [12] Tifft W. G.: Discrete states of redshift and galaxy dynamics. III. Abnormal galaxies and stars. *Astrophysical Journal* 211, 377 (1977).
- [13] Arp H., Sulentic J. W.: Analysis of groups of galaxies with accurate redshifts. *Astrophysical Journal* 291, 88 (1985).
- [14] Arp H.: A corrected velocity for the local standard of rest by fitting to mean red-shift of local group galaxies. *Astronomy and Astrophysics* 156, 207 (1986).
- [15] Guthrie B. N., Napier W. M.: Redshift periodicity in the local supercluster. *Astronomy and Astrophysics* 310, 353-370 (1996).
- [16] Sepulveda E.: Geometric paradigm accounts for all redshift periodicities. *Bulletin of the American Astronomical Society* 19, 689 (1987).

- [17] Hawkins E., Maddox S. J., Merrifield M. R.: No periodicities in 2dF redshift survey data. *Monthly Notices of the Royal Astronomical Society* 336 (13), L13–L16 (2002).
- [18] Bajan K., Flin P., Godlowski W., Pervushin V. P.: On the investigations of galaxy redshift periodicity. [arXiv.org/abs/astro-ph/0606294](https://arxiv.org/abs/astro-ph/0606294) (2006).
- [19] Komatsu E., Smith K. M., Dunkley J., Bennett C. L., Gold B., Hinshaw G., Jarosik N., Larson D., Nolta M. R., Page L., Spergel D. N., Halpern M., Hill R. S., Kogut A., Limon M., Meyer S. S., Odegard N., Tucker G. S., Weiland J. L., Wollack E., Wright E. L.: Seven-year Wilkinson microwave anisotropy probe (WMAP) observations: Cosmological interpretation. [arXiv.org: astro-ph arXiv:1001.4538v3](https://arxiv.org/abs/astro-ph/1001.4538v3) (2010).
- [20] Agnese A. G., Festa R.: Clues to discretization on the cosmic scale. *Physics Letters A* 227, 165-171 (1997).

Do we really understand the solar system?

M. Pitkänen

Email: matpitka@luukku.com.

http://tgd.wippiespace.com/public_html/.

November 27, 2011

Contents

1	Motivations	2
1.1	Two basic theories explaining the precession of equinoxes	2
1.2	Some hints	2
1.3	The identification of the companion of the Sun in the framework of standard physics	3
1.4	The identification of the companion of the Sun in TGD framework	4
2	A model for the motion of comet in the gravitational field of flux tube	6
2.1	Gravitational potential of a straight flux tube with constant mass density	7
2.2	Motion of a test particle in the region exterior to the flux tube	7
3	A model for the precession of the solar system in the gravitational field of flux tube	8
3.1	Calculation of the gravitational potential energy	9
3.2	Solving the equations of motion from conservation laws	10
3.3	Exact solution when nutation is neglected	12
3.4	Approximate solution when nutation is allowed	13
4	Cosmic evolution as transformation of dark energy to matter	14
5	The origin of cosmic rays	15
5.1	What has been found?	15
5.2	Cosmic rays in TGD Universe?	16
5.2.1	The mechanism transforming dark energy to dark matter and cosmic rays	16
5.2.2	What is the precise mechanism transforming dark energy to matter?	17
5.2.3	What is the acceleration mechanism	17

Abstract

The recent experimental findings have shown that our understanding of the solar system is surprisingly fragmentary. As a matter fact, so fragmentary that even new physics might find place in the description of phenomena like the precession of equinoxes and the recent discoveries about the bullet like shape of heliosphere and strong magnetic fields near its boundary bringing in mind incompressible fluid flow around obstacle. TGD inspired model is based on the heuristic idea that stars are like pearls in a necklace defined by long magnetic flux tubes carrying dark matter and strong magnetic field responsible for dark energy and possibly accompanied by the analog of solar wind. Heliosphere would be like bubble in the flow defined by the magnetic field inside the flux tube inducing its local thickening. A possible interpretation is as a bubble of ordinary and dark matter in the flux tube containing dark energy. This would provide a beautiful overall view about the emergence of stars and their helio-spheres as a phase transition transforming dark energy to dark and visible matter. Among other things the magnetic walls surrounding the solar system would shield the solar system from cosmic rays. The model leads to a vision about formations of stars and galaxies as "boiling" of dark energy to matter. Also a model for the cosmic rays emerges allowing to identify the acceleration mechanism using recent findings about cosmic rays.

1 Motivations

The inspiration to this little contribution came from a discussion with my friend Pertti Kärkkäinen who told me about the work of Walter Cruttenden [17]. Cruttenden is a free researcher working with an old problem related to the astronomy of the solar system, namely the precession of equinoxes [9]. Equinoxes [2] correspond to the two points at the orbit of Earth at which the Sun is in the plane of the equator (if Earth's spin axes were not tilted this would be the case always). What has been observed is an apparent movement of fixed stars relative to the Earth bound observer. The period of the equinox precession is about 26,000 years. The angular radius of the precession cone is about 23.5 degrees. The rate of precession is approximately 50 arc seconds per year but is not strictly constant.

The precession of equinoxes reduces to precession which is a well-known phenomenon associated with the motion of a rigid body with one point fixed. Precession [8] means that the spin axis of the spinning system rotates around fixed axis along the surface of a cone. One can distinguish between a torque free precession and precession induced by torque. Precession can be accompanied by a nutation [6]: the tilt angle of the spin axes with respect to fixed axes varies with time. The nutation for Earth is well-understood process determined by the local gravitational physics. In the case of precession the situation is not so clear.

1.1 Two basic theories explaining the precession of equinoxes

There are two basic theories of precession.

1. The precession of equinoxes could be governed by a local dynamics being due to the precession of the Earth with respect to solar system. Earth is indeed a prolate ellipsoid and the precession would be caused mainly by the gravitational fields of Sun and Moon (lunisolar model). According to the summary of Cruttenden [17], Newton's equations did not work and d'Alembert and others have added and changed input values to fit the observed precession. The latest 2000A version includes almost 1400 terms but it still fails to accurately predict variations in the precession rate. The theory is also plagued by a "measurement paradox". Studies show that the changes in Earth's orientation relative to Sun and other planets are small (few arc seconds per year instead of 50 arc seconds) as compared to the equinox precession.
2. The precession of equinoxes could be also due to the precession of the entire solar system regarded as a rigid body with one point fixed and would be caused by some hypothetical binary companion of Sun. Usually the binary companion is thought to be star of planet like system but this is not necessary. This model is known as binary model and was first proposed by Indian astronomer Sri Yukteswar. The predicted period was 24,000 years. According to the summary of Cruttenden, the binary model of Yukteswar has turned out to be more accurate over 100 year period [17].

In principle the observation of the precession from some other planet could select between the two approaches. If the precession were similar at two planets then the precession of the entire solar system would be strongly favored as an explanation of the equinox precession.

1.2 Some hints

The basic challenge for the binary theory is of course the identification of the binary. There are some hints in this respect listed by W. Cruttenden in the articles at his homepage. Consider first what has been learned from the structure of heliosphere during last years.

1. The data from Voyager 1 and Voyager 2 have revealed that heliosphere is asymmetric [16]. The edge of the heliosphere (the place where the solar wind slows down to sub-sonic speeds and is heated) appears to be 1.2 billion kilometers shorter on the south side of the solar system than it is on the edge of the planetary plane. This indicates the heliosphere is not a sphere but has a shape of a bullet. In a sharp contrast with the naive expectations, the magnetosphere of Sun would not be like that of Earth which is compressed on the day side by solar wind and has a long tail on the night side.

2. There is also evidence from Voyager 2 for a strong magnetic field [15]. Also the temperature just outside the boundary zone defining the boundary of the solar inner magnetosphere was ten times cooler than expected. The presence of the strong magnetic field is not easy to understand since the interstellar space consists of extremely tenuous gas. The proposal is that the interstellar magnetic field could be forced to flow around the helio-magnetosphere much like fluid flows around obstacle. This increases the density of flux lines and interstellar magnetic field would become stronger locally. Heliosphere would be like a bubble inside magnetic flux tube expanding it locally.

The direction of the local magnetic field at the edge of the heliosphere differs considerably from that for the interstellar magnetic field thought to be parallel to the galactic plane. The tilt angle is about 60 degrees. Therefore one can challenge the identification of the strong local magnetic field as galactic magnetic field.

3. Between June and October 2007, the STEREO spacecraft [12] "detected atoms originating from the same spot in the sky: the shock front and the helio-sheath beyond, where the sun plunges through the interstellar medium, and found energetic neutral particles from beyond the heliosphere that are moving towards the sun [14]. This would suggest magnetic flux tube like structure and the flow of neutral particles along the flux tube towards the Sun so that an analog of solar wind would be in question.

Also the behavior of comets suggests that the understanding of the solar system is far from complete. The behavior of the comet Sedna thought to belong to the inner Oort cloud [7] cannot be explained in terms of theory assuming only solar and planetary gravitational fields. Typically comets move along periodic orbits returning repeatedly near some planet of solar system (typically Neptune) which has kicked the comet to its highly eccentric orbit. Sedna [1] (thought to be a "dwarf planet") seems to be an exception in this respect. Sedna has an exceptionally long and elongated orbit (aphelion about 937 AU and perihelion about 89.6 AU), period is estimated to be 11,400 years, and Sedna does not return near any planet periodically as the assumption that it belongs to the scattered disk would require.

What could be the origin of Sedna?

1. It has been suggested that that Sun has an dim binary companion - christened Nemesis [5] - at a distance of thousands of AUs. This companion could explain the behavior of Sedna, and has been also proposed to be responsible for the conjectured periodicity of mass extinctions, the lunar impact record, and the common orbital elements of a number of long period comets.
2. Second proposal is that Sedna has been kicked to its orbit by some object. This object could be an unseen planet much beyond the Kuiper belt [3] (Kuiper belt is outside planet Neptune and extends from 30 AU to 55 AU). It would have mass about 5 times the mass of Jupiter and be at distance of roughly 7850 AU from the Sun in the inner Oort cloud. It could be a single passing star or one of the young stars embedded with the Sun in the stellar cluster in which it formed. This might have happened already in the Sun's birth cluster (cluster of stars).
3. Also the behavior of the comets in outer Oort cloud (very eccentric orbits and long orbital periods) might reflect the influence of a binary companion whose mass distribution is such that this kind of orbits are generic. For spherical objects one would expect nearly circular orbits. String like object would satisfy this condition as will be found.

1.3 The identification of the companion of the Sun in the framework of standard physics

Consider first the identification of the companion of the Sun responsible for the precession of the solar system as a whole but staying in the framework of the standard physics. In this context only objects with a spherical symmetry can be considered.

1. The strange behavior of Sedna suggests that binary could be an unseen planet at distance of about 7850 AU in the inner Oort cloud. Note that Oort could extend up to 50,000 AUs which corresponds to .75 ly whereas the closest star - Proxima Centauri- is at distance of about 4.2 light years.

2. The identification of the binary as the hypothetical Nemesis might explain the analog of the solar wind. If the dim Nemesis is at the same distances as the hypothetical planet, its mass would be only .5 per cent of solar mass.
3. An analog of solar wind flowing along magnetic flux tubes could also come from some other star, say Proxima Centauri [10]. Proxima Centauri is however too light as red dwarf and too distant to induce the precession of the solar system as whole.

1.4 The identification of the companion of the Sun in TGD framework

In TGD framework one can consider more speculative ideas concerning the identification of the binary of the Sun.

1. In TGD Universe dark matter and dark energy can be understood as phases of matter with large Planck constant [4]. For the dark energy assignable to the flux tubes mediating gravitational interaction between Sun and given planet the value of the Planck constant is of order GMm/v_0 , where $v_0/c \simeq 2^{-11}$ holds true for the inner planets. For dark matter the value of Planck constant is much smaller integer multiple of its minimal value identified as the ordinary Planck constant. Whether only magnetic energy should be counted as dark energy or whether also dark particles with a gigantic value of Planck constant should be identified as dark energy is not quite clear.
2. Magnetic flux tubes are identified as carriers of dark matter. This hypothesis plays a key role in TGD inspired quantum biology and cosmology. The flux tubes can have arbitrary large length scales. During the cosmology space-time would have consisted of cosmic strings of form $X^2 \times Y^2 \subset M^4 \times CP_2$ with X^2 minimal surface and Y^2 complex sub-manifold of CP_2 . In the course of the cosmic evolution their M^4 projection would have become 4-dimensional and they would have become magnetic flux tubes. The proposal is that galaxies are like pearls in a necklace formed by flux tubes [1].

The density ρ_{dark} of the magnetic energy is enormous for cosmic strings: the length L of cosmic string corresponds to a mass which is a fraction $G/h_0 R^2 \sim 10^{-4}$ of the mass of a black hole with radius L . The thickening of the cosmic string to a flux tube respects the conservation of the magnetic flux so that the strength of the magnetic field scales down like $B \propto 1/S$, where S is the area for the transversal cross section of the flux tube. By a simple scaling argument the density of the magnetic energy per unit length of the flux tube scales down like $dE_m/dl \propto 1/S$.

If energy is conserved if the length of the cosmic string scales up like S in the cosmic expansion: $d \propto \sqrt{L}$ proportionality analogous to that encountered in the case of diffusion would relate to each other flux tube radius and length. Also the primary p-adic length scales L_p assignable to particles and the secondary p-adic length scales $L_{p,2}$ characterizing the corresponding causal diamond CD relate in a similar manner. This would suggest that the p-adic length scale assignable to a given particle (of order Compton length) corresponds to the thickness of the magnetic flux tube(s) assignable to the particle and the size of CD to the length of the(se) magnetic flux tube(s). Similar scaling holds true for the density of dark matter per unit length of the flux tube.

The dark matter associated with the flux tubes would generate transversal $1/\rho$ gravitational field explaining the constant velocity spectrum of distance stars in the galactic halo. The basic prediction is free motion along the direction of the cosmic string perturbed only by the mass of the galaxy itself.

3. The fractality of the TGD Universe suggests the pearls in the necklace model applies also to stars. The magnetic flux tube idealizable as a straight string would be roughly orthogonal to the plane of the planetary system possibly associated with the star and the spin axis of the star would be nearly parallel to the flux tube. If one combines this picture with the previous discussion, the simplest proposal is obvious. The binary companion of the Sun is the magnetic flux tube containing dark matter.

Newtonian theory for the gravitation in planetary system works excellently and this poses strong constraints on the pearls in a necklace model will be discussed in more detail.

1. If the magnetic flux tube idealizable as a straight string carries dark matter, this dark matter gives an additional transversal $1/\rho$ contribution to the gravitational field in the exterior of the flux tube experienced by comets and also by planets. Near the Sun this contribution should be small as compared to the contribution of the Sun but this is not obvious. Inside the flux tube the gravitational potential would be apart from a constant proportional to ρ^2 . It could affect much the gravitational potential of Sun in a detectable manner.
2. The contribution of the gravitational potential of dark matter to the dynamics of the solar system is certainly negligible if the heliosphere is a bubble inside the magnetic flux tube having fluid flow as an analog. Stars could be bubbles of ordinary and dark matter inside flux tubes containing dark energy with a gigantic value of Planck constant. Fractality suggests that this picture might apply also to galactic magnetospheres and even in biological systems where TGD inspired quantum biology predicts that the flux tubes containing dark matter use visible matter as sensory receptor and motor instrument [2, 3]. Cell would be a fractal analog of the solar heliosphere in this framework!
3. At long distances the transversal gravitational field created by the dark matter at the magnetic flux tube begins to dominate and the situation is very much like in the case of galaxies. In particular, for circular orbits the rotation velocity is constant. The logarithmic behavior of the gravitational potential implies that the orbits tend to be highly eccentric and the it might be that the behavior of comets in the outer Oort cloud at least could be dictated by the gravitational field of the flux tube.

How thick the flux tube in question is and is its thickness affected by the presence of Sun and heliosphere?

1. The magnetic flux tube should have transversal dimensions not must larger than those of planetary system or heliosphere. The heliosphere has radius of about 80-100 AU to be compared to the distance 40 AU of Neptune. The distance of Neptune about 30 AU gives the first guess for the thickness of the flux tube. Kuiper belt extends from 30 AU to 55 AU and would surround the flux tube in this case.
2. Second guess is that the flux tube is so thick that it contains also Kuiper belt.
3. Third guess motivated by the above experimental findings is that the magnetic flux flows past the heliosphere like fluid flow: this would apply also to the dark matter matter inside flux tube. Heliosphere corresponds to a hollow bullet like bubble of ordinary and dark matter formed inside the flux tube carrying dark energy and carrying only the magnetic fields of Sun and planets.

The dark energy and possible dark matter inside the flux tube (particular kind of space-time sheet) would have no effect on the gravitational field inside heliosphere so that no modifications of the existing model of solar system would be needed. Outside the heliosphere the effect would be in a good approximation described by a logarithmic gravitational potential created by an infinitely thin string like structure. The strong magnetic field of the flux wall surrounding the heliosphere would form a shield against the effects of cosmic rays coming from interstellar space.

The third guess seems to be consistent with the recent findings about the heliosphere boundary.

1. The strong magnetic field detected by Voyager 2 [13] has been identified as galactic magnetic field which has changed its direction locally and for which the density of flux tubes has increased. Near the helio-sheath heliosphere would have deformed it locally inducing a tilt angle of 60 degrees with respect to the galactic plane.

The article contains a video giving an artist's view about the magnetic field suggesting strongly that flux tube develops a hole representing heliosphere. Could the magnetic field actually correspond to the dark magnetic field associated with the proposed magnetic flux tube? Helio-sheath has radius of order 80-100 AU so that this interpretation could make sense. This would challenge the interpretation as a galactic magnetic field unless the galactic magnetic field itself decomposes into flux tubes some of which contain stars as bubbles of ordinary and dark matter.

2. The findings of STEREO suggest that neutral atoms - presumably hydrogen atoms- arrive from a spot in the sky. It is not clear to me whether the spot refers to something in interstellar space (say another star) or just to the tip of the bullet like structure defined by the heliosphere. The simplest guess is that Proxima Centauri belongs to the same flux tube as Sun: this hypothesis is easy to kill if one assumes that the flux tube connecting Sun and Proxima Centauri is straight. The red dwarf character of Proxima Centauri does not however favor this hypothesis. Unfortunately I could not find any data about the direction of of the analog of the solar wind.
3. Interstellar Explorer discovered a narrow ribbon in heliosphere [4]. This ribbon could correspond to the locus in which the deflection for the magnetic magnetic flux tubes caused by the heliosphere is such that the neutral particle of the solar wind can return back. The proposal is that magnetic walls act as mirrors. The reflection would involve ionization of neutral particle following by a confinement around flux tube plus possible motion in the direction of the flux tube and subsequent neutralization followed by a free linear motion possible back to Sun. Only when the neutral particle arrives to the magnetic flux wall in approximately orthogonal direction, the reflection would occur via this process. Otherwise the particle would leak out along the magnetic flux wall.

An interesting question concerns the criteria for what it is to be pearls in a necklace. One possible criterion would be correlated motion in the absence of gravitational binding. The moving groups of stars [11] not bound by gravitational interaction would satisfy this criterion. Another criterion that one can imagine is that the stars are in the same developmental stage. Maybe stellar nurseries contain tangled magnetic flux tubes inside which bubbles of ordinary and dark matter are formed in a phase transition transforming dark energy to ordinary and dark matter: the flux tubes mediating gravitational interaction would still carry dark energy as magnetic energy and have a gigantic value of Planck constant.

One can imagine also other dark options: such as dark planets or dark Nemesis but these options are more speculative and might fail to explain the analog of the solar wind. Also the proposed dark matter matter at the orbits of the planets might have some role and fractality suggests that dark matter is present in in all scales so that one has bubbles inside bubbles inside....

In the following the idea that magnetic flux tube containing dark matter is tested by building simple models for the orbits of comets in the gravitational field of the flux tube and for the precession of the solar system in this field. The models are oversimplified and can be taken only as first steps to test whether the proposed vision might work.

2 A model for the motion of comet in the gravitational field of flux tube

One should derive tests for the idea that also stars are mass concentrations around magnetic flux tube like structures evolved from extremely thin cosmic strings forming linear structures analogous to pearls in a necklace.

1. One possible signature might be the motion of comets. If the general structure of the orbits of comets in outer (at least) Oort cloud [7] are determined by the gravitational field of the magnetic flux tube structure their general characteristics should reflect the very slowly variation of the logarithmic gravitational potential of the flux tube. What one would expect is typically very eccentric orbits in the plane of the solar system orthogonal to the flux tube and having very long orbital periods. Comet orbits in the outer Oort cloud indeed have these characteristics.
2. Second characteristic signature is free motion in direction parallel to the flux tube apart from effects caused by the solar gravitational field.. This could imply the leakage of the comets from the system if the velocity is higher than the escape velocity from the solar system in presence of only solar gravitational field. Also the concentration of comets strongly in the plane of the solar system would imply that the total number of comets is much lower than predicted by the spherically symmetric model for the Oort cloud: this conforms with experimental facts [7]. A more complex situation corresponds to a motion to which the gravitational fields of Sun and flux tube are both important. This could be relevant for motions which are not in the plane of planetary system.

2.1 Gravitational potential of a straight flux tube with constant mass density

The gravitational potential for a straight flux tube with constant density of dark energy (or matter) ρ_{dark} will be needed in the sequel.

1. Gravitational potential satisfies the Poisson equation

$$\nabla^2 \phi_{gr} = 4\pi G \rho_{dark} . \quad (2.1)$$

2. For a straight flux tube of radius d the mass density is constant and the situation is cylindrically symmetric and the solution inside the flux tube reads as

$$\begin{aligned} \phi_{gr} &= G\pi\rho_{dark}d^2 = GT\frac{\rho^2}{d} , \\ T &= \frac{dM}{dl} . \end{aligned} \quad (2.2)$$

T is the linear mass density.

Outside the straight flux tube the potential is given by Gauss theorem as

$$\phi_{gr} = 2TG \times \log\left(\frac{\rho}{\rho_0}\right) . \quad (2.3)$$

The choice of the value ρ_0 is dictated by boundary conditions at the boundary of the flux tube if one assumes that the potential energy vanishes at origin. Its change induces only an additive constant to the total energy and does not effect equations of motion.

2.2 Motion of a test particle in the region exterior to the flux tube

One can construct a model for the motion of comet in gravitational field of flux tube by idealizing it with an infinitely thin straight string with string tension kept as a free parameter. For simplicity the motion will be assumed to take place in the plane orthogonal to the flux tube.

1. The gravitational potential energy of mass in the field of straight string like object is given by

$$V(\rho) = k \log(x) , \quad x = \frac{\rho}{\rho_0} , \quad k = 2TG \quad (2.4)$$

Here ρ_0 is a parameter which can be chosen rather freely since only the value of the conserved energy changes as ρ_0 is changed. One possible choice is $\rho_0 = \rho_{min}$, the minimum value of the radial distance from the flux tube idealized to be infinitely thin.

2. Conserved quantities are angular momentum

$$L = m\rho^2 \frac{d\phi}{dt} , \quad (2.5)$$

and energy

$$E = \frac{m}{2} \left(\frac{d\rho}{dt}\right)^2 + \frac{L^2}{2m\rho^2} + V(\rho) . \quad (2.6)$$

3. One can integrate these equations to get for the period of the motion the expression

$$\frac{T}{\rho_0} \sqrt{2Em} = 2 \int_{x_-}^{x_+} \frac{dx}{\sqrt{1 - \frac{L^2}{E^2 \rho_0^2 x^2} - k \log(x)}} ,$$

$$x_- = \frac{\rho_-}{\rho_0} , \quad x_+ = \frac{\rho_+}{\rho_0} . \quad (2.7)$$

4. The turning points of the motion corresponds to the vanishing of the argument of the square root. At x_+ the logarithmic term dominates under rather general conditions whereas logarithmic term can be neglected at x_- , and one has in good approximation

$$x_+ \simeq e^{\frac{L}{k}} , \quad x_- = \frac{L}{E \rho_0} . \quad (2.8)$$

Without a loss of generality one can choose $\rho_0 = L/E$ giving $x_- = 1$ which gives

$$\rho_- \simeq \frac{L}{E} , \quad \rho_+ \simeq \rho_- \times e^{\frac{L}{k}} , \quad . \quad (2.9)$$

For large values of L/k the orbits is very eccentric since one has $\rho_+/\rho_- \simeq \exp(L/k)$.

A highly eccentric orbit with a very long orbital period is expected to represent the generic situation so that the model could indeed explain the characteristics of the comets in the outer Oort cloud. In the inner Oort cloud the eccentricities are smaller and the natural explanation would be that the gravitational field of Sun determines the characteristics of these orbits in good approximation.

3 A model for the precession of the solar system in the gravitational field of flux tube

The model for the precession of the solar system in the gravitational field of the flux tube is obtained by idealizing the solar system with a cylindrically symmetry top with one point fixed in the gravitational field of the flux tube. The calculation is a little modification of that appearing in any text book of classical mechanics: I have used Herbert Goldstein's "Classical Mechanics" familiar from my student days [1].

1. The model above requires that the solar system is a bullet like bubble inside the flux tube and dark energy induces no gravitational interaction inside the bubble. The bubble is approximated as a rigid body with one point fixed, which can thus perform precession. The torque must be due to the dependence of the total gravitational potential energy on the tilt angle θ of the bubble with respect to the axis of the flux tube.
2. One can apply the same trick as in the case of estimating the force on levitating super-conductor in external magnetic field. Since the magnetic field does not penetrate the superconductor, the interaction energy is the negative of the magnetic energy of the external field in the volume occupied by the super-conductor. Now one obtains the *negative* of the interaction energy of the dark matter with its own gravitational potential. This can be written as

$$E_{gr} = -\frac{1}{8\pi G} \int (\nabla \phi_{gr})^2 dV . \quad (3.1)$$

The value of the interaction energy depends on the orientation of the heliosphere which gives rise to a torque.

3.1 Calculation of the gravitational potential energy

The value of the potential energy must be calculated for various orientations of the bubble. Cylindrical coordinates (ρ, z, ϕ) are obviously the proper choice of coordinates. Cylindrical rotational symmetry implies that the potential energy depends on the inclination angle θ only characterizing the cone of precession. Potential energy is defined as an integral over the bubble. Potential energy is proportional to the transverse distance from the axis of the magnetic flux tube and this simplifies the analytical calculations considerably.

1. The change of the orientation of the bubble by a rotation which can be taken to be a rotation in (y, z) plane by angle θ means that the expression for the transverse distance squared - call it $(\rho')^2$ - from the axis of the flux tube is given by

$$\begin{aligned} (\rho')^2 &= x^2 + (\sin(\theta)z + \cos(\theta)y)^2 \\ &= \rho^2 \cos^2(\phi) + \rho^2 \cos^2(\theta) \sin^2(\phi) + z^2 \sin^2(\theta) + 2z\rho \cos(\theta) \sin(\theta) \sin(\phi) . \end{aligned} \quad (3.2)$$

By the rotational symmetry the contribution of the term linear in $\sin(\phi)$ vanishes in the integral and the integral of $(\rho')^2$ over ϕ can be done trivially so that one obtains the integral of quantity

$$I \equiv \int dV (\rho')^2 = \int dV [\rho^2 + \rho^2 \cos^2(\theta) + 2z^2 \sin^2(\theta)] . \quad (3.3)$$

over z and ρ . The integral of the ρ^2 gives a term which does not depend on θ and therefore does not contribute to torque and can be dropped and one obtains

$$I = \int dV [\rho^2 \cos^2(\theta) + 2z^2 \sin^2(\theta)] . \quad (3.4)$$

2. To simplify the situation one can assume that bubble is hemisphere so that one has $z^2 = d^2 - \rho^2$ at the upper boundary. It is convenient to introduce scaled coordinates $x = \rho/d$ and $y = z/d$.

The integration over ϕ can be carried out trivially so that apart from additive constant term one has

$$\begin{aligned} I &= \pi d^4 (I_1 \cos^2(\theta) + I_2 \sin^2(\theta)) , \\ I_1 &= \int_0^1 dy \int_0^{\sqrt{1-y^2}} x^3 dx = \frac{1}{4} \int_0^1 dy (1-y^2)^2 = \frac{44}{45} , \\ I_2 &= 2 \int_0^1 dx x \int_0^{\sqrt{1-x^2}} dy y^2 = \frac{2}{3} \int_0^1 dx x (1-x^2)^{3/2} = \frac{2}{15} \end{aligned} \quad (3.5)$$

By replacing the upper limit of x integral with $z = f(\rho)$ one obtains the more general situation.

3. The value of the integral I is given by

$$\begin{aligned} I &= \pi d^5 \left[\frac{44}{45} \cos^2(\theta) + \frac{2}{15} \sin^2(\theta) \right] \equiv \frac{38}{45} \pi u^2 , \\ u &= \cos(\theta) . \end{aligned} \quad (3.6)$$

Here a constant term not contributing to the torque has been dropped away.

4. By substituting the explicit expression for the gravitational potential one obtains the following expression for the gravitational potential

$$V = V_1 u^2 , \quad V_1 = -\frac{19}{15} \times \frac{3}{8\pi} \frac{GM_{dark}^2}{d} . \quad (3.7)$$

The proportionality to GM_{dark}^2/d could have been guessed using dimensional analysis.

3.2 Solving the equations of motion from conservation laws

The equations of motion can be solved using standard procedure applicable to cylindrical symmetry top with one point fixed. The potential has the following general form for the bubble model;

$$V(u) = V_1 u^2 \text{ (bubble) .} \quad (3.8)$$

Note that one has $V_1 < 0$ is by previous arguments more realistic than the potential when the magnetic flux penetrates the solar system (note that solar system would repel the magnetic flux like super-conductor). In the latter case analytical calculation would be also impossible although also now the potential depends on u only.

The calculation proceeds in the following manner [1].

1. The Lagrangian is given in terms of Euler angles (θ, ϕ, ψ) by

$$L = \frac{I_1}{2} \left[\left(\frac{d\theta}{dt} \right)^2 + (1 - u^2) \left(\frac{d\phi}{dt} \right)^2 \right] + \frac{I_3}{2} \left(\frac{d\psi}{dt} + u \frac{d\phi}{dt} \right)^2 - V_1 u^2 . \quad (3.9)$$

Here $I_1 = I_2$ *resp.* I_3 are the eigen values of the inertia tensor in the directions orthogonal *resp.* parallel to symmetry axis. In the recent case I_1 and I_2 correspond to the two directions orthogonal to the the symmetry axis of the bullet like heliosphere and I_3 to the direction of the symmetry axis of the heliosphere.

2. ϕ and ψ are cyclic coordinates and give rise to two conserved quantities corresponding to conserved angular momentum components

$$\begin{aligned} p_\psi &= I_3 \left(\frac{d\psi}{dt} + u \frac{d\phi}{dt} \right) \equiv I_1 a , \\ p_\phi &= [I_1(1 - u^2) + I_3 u^2] \frac{d\phi}{dt} + I_3 u \frac{d\psi}{dt} \equiv I_1 b . \end{aligned} \quad (3.10)$$

From these equations one can solve $d\psi/dt$ and $d\phi/dt$ (recession velocity) in terms of u and various parameters and integrate this equations with respect to time if $u(t)$ is known.

3. Energy conservation gives an additional condition. By noticing that also the quantity $p_\psi^2/2I_3$ is conserved and one obtains

$$E' = E - \frac{p_\psi^2}{2I_3} = \frac{I_1}{2} \left(\frac{d\theta}{dt} \right)^2 + (1 - u^2) \left(\frac{d\phi}{dt} \right)^2 + V_1 u^2 \quad (3.11)$$

is conserved. By little manipulations one can integrate θ or equivalently t from this equation and one obtains for the period T of motion the expression of form

$$\begin{aligned} T &= 2 \int_{u_-}^{u_+} \frac{du}{\sqrt{(1 - u^2)(\alpha - \beta u^2) - (b - au)^2}} , \\ \alpha &= \frac{2E'}{I_1} , \quad \beta = \frac{2V_1}{I_1} , \quad V_1 = -\frac{19}{15} \times \frac{3}{8\pi} \frac{GM_{dark}^2}{d} . \end{aligned} \quad (3.12)$$

The coefficients α and β can be deduced from the conservation laws for p_ψ and p_ϕ . Note that for the cylindrically symmetric rotating rigid body in Earth's magnetic field the negative $V_1 u^2$ term is replaced with $2GMl \times u$ term having positive sign. By replacing u_+ with u as the upper integration limit one obtains the relationship $t = t(u)$ and can in principle invert this relationship to get $u = u(t)$.

The integral in question is elliptic integral [2, 1], whose general form is

$$P(a, b) = \int_a^b R(u, \sqrt{P(u)}) du , \quad (3.13)$$

where R is rational function of its arguments and $P(t)$ is a polynomial with degree not higher than 4. Now the degree of P is maximal and the rational function reduces to a rational function $R(u, \sqrt{P(u)}) = 1/\sqrt{P(u)}$ of single variable. The limits are given by $(a, b) = (u_-, u)$ in the general case. By an appropriate change of variables elliptic integrals can be always reduced to three canonical elliptic integrals known as Legendre forms [3].

1. In the recent case the elliptic integral is of the standard form

$$\begin{aligned} t &= \int_{u_-}^u dv \frac{1}{\sqrt{P_4(v)}} , \quad P_4(v) = a_4 v^4 + a_3 v^3 + a_2 v^2 + a_1 v + a_0 , \\ a_4 &= -\beta , \quad a_3 = 0 , \quad a_2 = -\alpha - a^2 , \quad a_1 = 2ab , \quad a_0 = \alpha - b^2 . \end{aligned} \quad (3.14)$$

It can be computed analytically [1] in terms of Weierstrass elliptic function $\mathcal{P}(t; g_2, g_3)$ [4, 5] with invariants

$$\begin{aligned} g_2 &= a_0 a_4 - 4a_1 a_3 + 3a_2^2 , \\ g_3 &= a_0 a_2 a_4 - 2a_1 a_2 a_3 - a_4 a_1^2 - a_3^2 a_0 . \end{aligned} \quad (3.15)$$

2. Weierstrass elliptic function is the inverse of the function defined by the elliptic integral

$$t = \int_t^\infty \frac{ds}{4s^3 - g_2 s - g_3} . \quad (3.16)$$

g_2 and g_3 are expressible in terms of zeros e_1, e_2, e_3 of $4s^3 - g_2 s + g_3$ satisfying $e_1 + e_2 + e_3 = 0$ (the quadratic term in the polynomial vanishes)

$$\begin{aligned} g_2 &= -4(e_1 e_2 + e_1 e_3 + e_2 e_3) = 2(e_1^2 + e_2^2 + e_3^2) , \\ g_3 &= 4e_1 e_2 e_3 . \end{aligned} \quad (3.17)$$

The zeros of this polynomial must correspond to the zeros of the third order polynomial obtained when the zero u_- of P_4 is factorized out but for variable which is not u anymore.

Either all the zeros are real or one is real and two complex conjugates of each other. This depends on the sign of the discriminant $\Delta = g_2^3 - 27g_3^2$. The possibly complex half periods ω_i (in the generic case) are related to the roots by $\mathcal{P}(\omega_1) = e_1, \mathcal{P}(\omega_2) = e_2, \mathcal{P}(\omega_3) = e_3 = -e_1 - e_2$ and satisfy $\omega_3 = -\omega_1 - \omega_2$. For real roots e_i ω_1 is real and ω_3 purely imaginary so that $\omega_2 = -\omega_1 - \omega_3$ is complex.

The ratio $\tau = \omega_1/\omega_2$ defines so called modular parameter τ characterizing the periodicity properties of the Weierstrass function in complex plane (or effectively on torus whose conformal structures is characterized by τ).

3. If u_- is root of the P_4 as in the recent case, the expression for integral is given by

$$u = u_- + \frac{1}{4} P_4'(u_-) \left[\mathcal{P}(t; g_2, g_3) - \frac{1}{24} P_4''(u_-) \right]^{-1} . \quad (3.18)$$

Here $\mathcal{P}(t; g_2, g_3)$ is the Weierstrass elliptic function. This expression gives $u = \cos(\theta)$ as function of time t . The period T corresponds to the situation $u = u_+$ and must correspond to the $t = \omega_1$ (real period in the argument of \mathcal{P}). The values of this function can be calculated numerically using Mathematica.

4. The relationship $u = u(t)$ giving by the above expression allows to integrate the equations for ψ and ϕ from the corresponding conservation laws by substituting the expression for $u(t)$ to these eqtions. Note that if nutation is absent so that $d\theta/dt = 0$ holds true and the above description fails since P_4 has a pair of degenerate real roots $u_+ = u_-$ meaning that nutation amplitudes becomes vanishing. This situation must be treated separately.

3.3 Exact solution when nutation is neglected

In the recent case the nutation can be neglected in the first approximation so that one has $d\theta/dt = 0$. In this case the two roots of the fourth order polynomial whose roots define the turning points are degenerate. This situation must be treated separately since the previous treatment fails.

1. The Lagrange equations of motion for θ give $\partial L/\partial\theta = 0$ stating that the torque vanishes in the equilibrium position for θ . The condition allows three solutions

$$\begin{aligned} u &= \pm 1 \text{ (no precession) ,} \\ u &= \frac{1}{r_{13} - 1} \times \frac{\left(\frac{d\psi}{dt}\right)^2}{\left(\frac{d\phi}{dt}\right)^2} \text{ (precession) ,} \\ r_{13} &\equiv \frac{I_1}{I_3} . \end{aligned} \quad (3.19)$$

If the bubble were a hemisphere with constant mass density one would have $r_{13} = 1/2$. Since the mass is concentrated in the orbital plane of planets, the value of I_3 is however smaller than I_1 and r_{13} is large suggesting that $r_{31} \equiv 1/r_{13}$ is a more convenient parameter for numerical calculations. If dark matter and energy do not contribute significantly inside helisphere, Jupiter would give the dominating contribution to I_1 and Sun to I_3 inside planetary system. Kuiper belts are expected to give a large contribution to I_1 . A rough estimate for r_{31} using various masses, solar radius, and planetary distances as basic data and neglecting Kuiper belt would give $r_{31} \sim 10^{-3}$. The actual value would be smaller than this unless dark matter changes the situation.

2. The conservation laws for p_ψ and p_ϕ read as

$$\begin{aligned} p_\psi &= I_3 \left(\frac{d\psi}{dt} + u \frac{d\phi}{dt} \right) \equiv I_1 a , \\ p_\phi &= [I_1(1 - u^2) + I_3 u^2] \frac{d\phi}{dt} + I_3 u \frac{d\psi}{dt} \equiv I_1 b , \end{aligned} \quad (3.20)$$

and give

$$\begin{aligned} \begin{pmatrix} \frac{d\psi}{dt} \\ \frac{d\phi}{dt} \end{pmatrix} &= \frac{1}{1 - u^2} \begin{pmatrix} a [r_{13}(1 - u^2) + u^2] - bu \\ b - au \end{pmatrix} , \\ \frac{d\psi}{dt} &= \pm \frac{a [r_{13}(1 - u^2) + u^2] - bu}{b - au} . \end{aligned} \quad (3.21)$$

Note that $d\psi/dt$ and $d\phi/dt$ are constants.

3. By substituting the expression for the ratio of these angular velocities to the equation for the equilibrium value of u , one obtains

$$u(b - au)^2 = \frac{1}{r_{13} - 1} \{a [r_{13}(1 - u^2) + u^2] - bu\}^2 . \quad (3.22)$$

This is fourth order polynomial and the number of real roots is at most four. $u \rightarrow -u, b \rightarrow -b$ is a symmetry of this equation. The interpretation is as change of the direction of spin axis and precession axis.

4. By feeding $d\theta/dt = 0$ into the conservation law of energy, one obtains an expression for the conserved energy

$$E = \frac{I_1}{2} [(1 - u^2)(b - au)^2 + r_{13}b^2] + V_1u^2 . \quad (3.23)$$

An interesting possibility is that the rotational motion of the bubble is stabilized against dissipation by the negativity of even the total energy E . The problem is that r_{13} is large and b is non-vanishing for precession so that the negativity of the total energy does not seem plausible.

A weaker condition is that $E' = E - p_\psi^2/2I_3$ is negative. This gives

$$E' = \frac{I_1}{2} [(1 - u^2)(b - au)^2 + r_{13}(b^2 - a^2)] + V_1u^2 < 0 . \quad (3.24)$$

For $b^2 < a^2$ the sign of the large term in the kinetic energy changes. What this would mean that the rate of rotation of solar system around the instantaneous precessing instantaneous rotation axis is large as compared to the precession rate.

5. The estimate for the period of precession given by $T = 2.6 \times 10^4$ years. In the approximation that nutation is absent $d\phi/dt = \omega$ is constant, and one has $d\phi/dt = 2\pi/T = 2.4 \times 10^{-4}/\text{year}$. The actual precession rate is not constant but its order of magnitude is same as the estimate obtained neglecting the nutation. Nutation would induce a time dependence of the precession rate. A reasonable expectation is that nutation represents a small oscillation around the solution representing mere precession.

3.4 Approximate solution when nutation is allowed

The model for non-nutating precession and the fact that precession rate is not quite constant suggest that a small nutation is present and induces the variation of the precession rate. A natural guess is that nutation represents a small perturbation around of non-nutating solutions. If this the case one can consider a standard treatment using standard perturbation theory assuming $u = u - 0 + \Delta u(t)$ and assuming that angular velocities are not affected at all so that only the u is perturbed.

1. The Lagrangian for small perturbations of this kind is

$$\Delta L = \frac{I_1}{2} \left(\frac{d\Delta u}{dt} \right)^2 + \left[\frac{(I_3 - I_1)}{2} \omega_\phi^2 - \frac{V_1}{2} \right] \Delta u^2 . \quad (3.25)$$

Here the shorthand notation $d\phi/dt \equiv \omega_\phi$ is introduced.

2. The equation for small oscillations is

$$\begin{aligned} \frac{d^2 \Delta u}{dt^2} + \omega_0^2 \Delta u &= 0 , \\ \omega_0^2 &= \left[(1 - r_{31}) \omega_\phi^2 + \frac{V_1}{I_1} \right] \Delta . \end{aligned} \quad (3.26)$$

3. Stability requires $\omega_0^2 > 0$. Since r_{13} is small the first term in ω_0^2 is positive. The second term is negative and this poses an upper bound for the magnitude of V_1 or alternatively lower bound for the magnitude of ω_ϕ :

$$\frac{I_1 \omega_\phi^2}{|V_1|} > \frac{1}{1 - r_{31}} = \frac{r_{13}}{r_{13} - 1} . \quad (3.27)$$

A possible interpretation of this condition is that sufficiently high precession rate prevents the instability causing the value of u to increase. Note that $V_1 u^2$ is analogous to harmonic oscillator potential with a wrong sign. Note that for $\omega_\phi = 0$ which corresponds to $u_0 = 0$ the situation is unstable so that precession is necessary to stabilize the system against gravitational torque.

4. The period of nutation defines the period of oscillation for the rate of precession and this condition gives additional constraint on the parameters of the model.

4 Cosmic evolution as transformation of dark energy to matter

The proposed bubble option favored by the fact that Newtonian theory works so well inside planetary system favors bound state precessing solutions without nutation. These solutions are expected to be stable against dissipation. Small nutation around the equilibrium solution could explain the slow variation of the precession rate. The variation could be also caused by external perturbations. What is amusing from the mathematical point of view is that the model is analytically solvable and that the solution involves elliptic functions just as the Newtonian two-body problem does.

The model suggests a universal fractal mechanism leading to the formation of astrophysical and even biological structures as a formation of bubbles of ordinary or dark matter inside magnetic flux tubes carrying dark energy identified as magnetic energy of the flux tubes. In primordial cosmology these flux tubes would have been cosmic strings with enormous mass density, which is however below the black hole limit for straight strings. Strongly entangled strings could form black holes if general relativistic criteria hold true in TGD.

One must be very critical concerning the model since in TGD framework the accelerated cosmic expansion has several alternative descriptions, which should be mutually consistent. It seems that these descriptions correspond to the descriptions of one and same thing in different length scales.

1. The critical and over-critical cosmologies representable as four-surfaces in $M^4 \times CP_2$ are unique apart from their duration [8]. The critical cosmology corresponds to flat 3-space and would effectively replace inflationary cosmology in TGD framework and criticality would serve as a space-time correlate for quantum criticality in cosmological scales natural if hierarchy of Planck constants is allowed. The expansion is accelerating for the critical cosmology and is caused by a negative "pressure" basically due to the constraint force induced by the imbeddability condition, which is actually responsible for most of the explanatory power of TGD (say geometrization of standard model gauge fields and quantum numbers).
2. A more microscopic manner to understand the accelerated expansion would be in terms of cosmic strings. Cosmic strings [1] expand during cosmic evolution to flux tubes and serve as the basic building bricks of TGD Universe. The magnetic tension along them generates a negative "pressure", which could explain the accelerated expansion. Dark energy would be magnetic energy.

The proposed boiling of the flux tubes with bubbles representing galaxies, stars, ..., cells, etc.. would serve as a universal mechanism generating ordinary and dark matter. The model should be consistent with the Bohr orbitology for the planetary systems [7] in which the flux tubes mediating gravitational interaction between star and planet have a gigantic Planck constant. This is the case if the magnetic flux tubes quite generally correspond to gigantic values of Planck constant of form $\hbar_{gr} = GM_1 M_2 / v_0$, $v_0/c < 1$, where M_1 and M_2 are the masses of the objects connected by the flux tube.

3. Even more microscopic description of the accelerated expansion would be in terms of elementary particles. In TGD framework space-time decomposes into regions having both Minkowskian and Euclidian signatures of the induced metric [9]. The Euclidian regions are something totally new as compared to the more conventional theories and have interpretation as space-time regions representing lines of generalized Feynman diagrams.

The simplest GRT limit of TGD relies of Einstein-Maxwell action with a non-vanishing cosmological constant in the Euclidian regions of space-time [9]: this allows both Reissner-Nordström metric and CP_2 as special solutions of field equations. The cosmological constant is gigantic but associated only with the Euclidian regions representing particles having typical size of order CP_2 radius. The cosmological constant explaining the accelerated expansion at GRT limit could correspond to the space-time average of the cosmological constant and therefore would be of a correct sign and order of magnitude (very small) since most of the space-time volume is Minkowskian.

This picture can be consistent with the idea that magnetic flux tubes which have Minkowskian signature of the induced metric are responsible for the effective cosmological constant if the magnetic energy inside the magnetic flux tubes transforms to elementary particles in a phase transition generating dark and ordinary matter from dark energy and therefore gives rise to various visible astrophysical objects.

5 The origin of cosmic rays

The origin of cosmic rays remains still one of the mysteries of astrophysics and cosmology. The recent finding of a super bubble [19] emitting cosmic rays might cast some light in the problem.

5.1 What has been found?

The following is the abstract of the article published in Science [18].

The origin of Galactic cosmic rays is a century-long puzzle. Indirect evidence points to their acceleration by supernova shockwaves, but we know little of their escape from the shock and their evolution through the turbulent medium surrounding massive stars. Gamma rays can probe their spreading through the ambient gas and radiation fields. The Fermi Large Area Telescope (LAT) has observed the star-forming region of Cygnus X. The 1- to 100-gigaelectronvolt images reveal a 50-parsec-wide cocoon of freshly accelerated cosmic rays that flood the cavities carved by the stellar winds and ionization fronts from young stellar clusters. It provides an example to study the youth of cosmic rays in a superbubble environment before they merge into the older Galactic population. The usual thinking is that cosmic rays are not born in states with ultrahigh energies but are boosted to high energies by some mechanism. For instance, super nova explosions could accelerate them. Shock waves could serve as an acceleration mechanism. Cosmic rays could also result from the decays of heavy dark matter particles.

The story began when astronomers detected a mysterious source of cosmic rays in the direction of the constellation Cygnus X [20]. Supernovae happen often in dense clouds of gas and dust, where stars between 10 to 50 solar masses are born and die. If supernovae are responsible for accelerating of cosmic rays, it seems that these regions could also generate cosmic rays. Cygnus X is therefore a natural candidate to study. It need not however be the source of cosmic rays since magnetic fields could deflect the cosmic rays from their original direction. Therefore Isabelle Grenier and her colleagues decided to study, not cosmic rays as such, but gamma rays created when cosmic rays interact with the matter around them since they are not deflected by magnetic fields. Fermi gamma-ray space telescope was directed toward Cygnus X. This led to a discovery of a superbubble with diameter more than 100 light years. Superbubble contains a bright regions which looks like a duck. The spectrum of these gamma rays implies that the cosmic rays are energetic and freshly accelerated so that they must be close to their sources.

The important conclusions are that cosmic rays are created in regions in which stars are born and gain their energies by some acceleration mechanism. The standard identification for the acceleration mechanism are shock waves created by supernovas but one can imagine also other mechanisms.

5.2 Cosmic rays in TGD Universe?

In TGD framework one can imagine several mechanisms producing cosmic rays. According to the vision already discussed, both ordinary and dark matter would be produced from dark energy identified as Kähler magnetic energy and producing as a by product cosmic rays. What causes the transformation of dark energy to matter, was not discussed earlier, but a local phase transition increasing the value of Planck constant of the magnetic flux tube could be the mechanism. A possible acceleration mechanism would be acceleration in an electric field along the magnetic flux tube. Another mechanism is supernova explosion scaling-up rapidly the size of the closed magnetic flux tubes associated with the star by \hbar increasing phase transition preserving the Kähler magnetic energy of the flux tube, and accelerating the highly energetic dark matter at the flux tubes radially: some of the particles moving along flux tubes would leak out and give rise to cosmic rays and associated gamma rays.

5.2.1 The mechanism transforming dark energy to dark matter and cosmic rays

Consider first the mechanism transforming dark energy to dark matter.

1. The recent model for the formation of stars and also galaxies is based on the identification magnetic flux tubes as carriers of mostly dark energy identified as Kähler magnetic energy giving rise to a negative "pressure" as magnetic tension and explaining the accelerated expansion of the Universe. Stars and galaxies would be born as bubbles of ordinary are generated inside magnetic flux tubes. Inside these bubbles dark energy would transform to dark and ordinary matter. Kähler magnetic flux tubes are characterized by the value of Planck constant and for the flux tubes mediating gravitational interactions its value is gigantic. For a start of mass M its value for flux tubes mediating self-gravitation it would be $\hbar_{gr} = GM^2/v_0$, $v_0 < 1$ (v_0 is a parameter having interpretation as a velocity).
2. On possible mechanism liberating Kähler magnetic energy as cosmic rays would be the increase of the Planck constant for the magnetic flux tube occurring locally and scaling up quantal distances. Assume that the radius of the flux tube is this kind of quantum distance. Suppose that the scaling $\hbar \rightarrow r\hbar$ implies that the radius of the flux tube scales up as r^n , $n = 1/2$ or $n = 1$ ($n = 1/2$ turns out to be the sensible option). Kähler magnetic field would scale as $1/r^{2n}$. Magnetic flux would remain invariant as it should and Kähler magnetic energy would be reduced as $1/r^{2n}$. For both options Kähler magnetic energy would be liberated. The liberated Kähler magnetic energy must go somewhere and the natural assumption is that it transforms to particles giving rise to matter responsible for the formation of star.

Could these particles include also cosmic rays? This would conform with the observation that stellar nurseries could be also the birth places of cosmic rays. One must of course remember that there are many kinds of cosmic rays. For instance, this mechanism could produce ultra high energy cosmic rays having nothing to do with the cosmic rays in 1-100 GeV rays studied in the recent case.

3. The simplest assumption is that the thickening of the magnetic flux tubes during cosmic evolution is based on phase transitions increasing the value of Planck constant in step-wise manner. This is not a new idea and I have proposed that entire cosmic expansion at the level of space-time sheets corresponds to this kind of phase transitions. The increase of Planck constant by a factor of two is a good guess since it would increase the size scale by two. In fact, Expanding Earth hypothesis having no standard physics realization finds a beautiful realization in this framework. Also the periods of accelerating expansion could be identified as these phase transition periods.
4. For the values of gravitational Planck constant assignable to the space-time sheets mediating gravitational interactions, the Planck length scaling like $r^{1/2}$ would scale up to black-hole horizon radius. The proposal would imply for $n = 1/2$ option that magnetic flux tubes having M^4 projection with radius of order Planck length primordially would scale up to blackhole horizon radius if gravitational Planck constant has a value GM^2/v_0 , $v_0 < 1$, assignable to a star. Obviously this evolutionary scenario is consistent with with what is known about the relationship between masses and radii of stars.

5.2.2 What is the precise mechanism transforming dark energy to matter?

What is the precise mechanism transforming the dark magnetic energy to ordinary or dark matter? This is not clear but this mechanism could produce very heavy exotic particles not yet observed in laboratory which in turn decay to very energetic ordinary hadrons giving rise to cosmic rays spectrum. I have considered a mechanism for the production of ultrahigh energy cosmic rays based on the decays of hadrons of scaled up copies of ordinary hadron physics [6]. In this case no acceleration mechanism would be necessary. Cosmic rays lose their energy in interstellar space. If they correspond to a large value of Planck constant, situation would change and the rate of the energy loss could be very slow. The above described experimental finding about Cygnus X however suggests that acceleration takes place for the ordinary cosmic rays with relatively low energies. This of course does not exclude particle decays as the primary production mechanism of very high energy cosmic rays. In any case, dark magnetic energy transforming to matter gives rise to both stars and high energy cosmic rays in TGD based proposal.

5.2.3 What is the acceleration mechanism of cosmic rays or is there any such mechanism?

How cosmic rays are created by this general process giving rise to the formation of stars?

1. Cosmic rays could be identified as newly created matter leaking out from the system. Even in the absence of accelerating fields the particles created in the boiling of dark energy to matter, particles moving along magnetic flux tubes would move essentially like free particles whereas in orthogonal directions they would feel $1/\rho$ gravitational force. For large values of \hbar this could explain very high energy cosmic rays. The recent findings about gamma ray spectrum however suggests that there is an acceleration involved for cosmic rays with energies 1-100 GeV.
2. One possible alternative acceleration mechanism relies on the motion along magnetic flux tubes deformed in such a manner that there is an electric field orthogonal to the magnetic field in such a manner that the field lines of these fields rotate around the direction of the flux tube. The simplest imbeddings of constant magnetic fields allow deformations allowing also electric field [5], and one can expect the existence of preferred extremals with similar structure. Electric field would induce an acceleration along the flux tube. If the flux tube corresponds to large non-standard value of Planck constant, dissipation rate would be low and the acceleration mechanism would be very effective.

Similar mechanism might even explain the observations about ultrahigh energy electrons associated with lightnings at the surface of Earth: they should not be there because the dissipation in the atmosphere should not allow free acceleration in the radial electric field of Earth.

Here one must be very cautious: the findings are based on a model in which gamma rays are generated with collisions of cosmic rays with matter. If cosmic rays travel along magnetic flux tubes with a gigantic value of Planck constant, they should dissipate extremely slowly and no gamma rays would be generated. Hence the gamma rays must be produced by the collisions of cosmic rays which have leaked out from the magnetic flux tubes. If the flux tubes are closed (say associated with the star) the leakage must indeed take place if the cosmic rays are to travel to Earth.

3. There could be a connection with supernovae although it would not be based on shock waves. Also supernova expansion could be accompanied by a phase transition increasing the value of Planck constant. Suppose that Kähler magnetic energy is conserved in the process. This is the case if the lengths of the magnetic flow tubes r and radii by $r^{1/2}$. The closed flux tubes associated with supernova would expand and the size scale of flux tubes would increase by factor r . The fast radial scaling of the flux tubes would accelerate the dark matter at the flux tubes radially.

Cosmic rays having ordinary value of Planck constant could be created when some of the dark matter leaks out from the magnetic flux tubes as their expanding motion in radial direction accelerates or slows down. High energy dark particles moving along flux tube would leak out in the tangential direction. Gamma rays would be generated as the resulting particles interact with the environment. The energies of cosmic rays would be the outcome of acceleration process:

only their leakage would be caused by it so that the mechanism differs in a decisive manner from the mechanism involving shock waves.

4. The energy scale of cosmic rays - let us take it to be about $E=100$ GeV for definiteness- gives an order of magnitude estimate for the Planck constant of dark matter at the Kähler magnetic flux tubes if one assumes that supernovae is producing the cosmic rays. Assume that electromagnetic field equals to induced Kähler field (the space-time projection of space-time surface to CP_2 belongs homologically non-trivial geodesic sphere). Assume that E equals the cyclotron energy scale given by $E_c = \hbar e B / m_e$ in non-relativistic situation and by $E_c = \sqrt{\hbar e B}$ in relativistic situation. The situation is relativistic for both proton and electron now and at this limit the cyclotron energy scale does not depend on the mass of the charged particle at all. This means that same value of \hbar produces same energy for both electron and proton.
 - (a) The magnetic field of pulsar can be estimated from the knowledge how much the field lines are pulled together and from the conservation of magnetic flux: a rough estimate is $B = 10^8$ Tesla and will be used also now. This field is $2 \times 10^{12} B_E$ where $B_E = .5$ Gauss is the nominal value of Earth's magnetic field.
 - (b) The cyclotron frequency of electron in Earth's magnetic field is $f_c(e) = 6 \times 10^5$ Hz in a good approximation and correspond to cyclotron energy $E_c = 10^{-14} (f_c / \text{Hz})$ eV from the approximate correspondence $eV \leftrightarrow 10^{14} \text{ Hz}$ true for $E = hf$. For the ordinary value of Planck constant electron's cyclotron energy would be for supernova magnetic field $B_S = 10^8$ Tesla equal to $E_c = 2 \times 10^{-2} (f_c / \text{Hz})$ eV and much below the energy scale $E = 100$ GeV.
 - (c) The required scaling $\hbar \rightarrow r\hbar$ of Planck constant is obtained from the condition $E_c = E$ giving in the case of electron one can write

$$r = \left(\frac{E}{E_c}\right)^2 \times = \frac{B_E}{B_S} \times \frac{\hbar e B_E}{m_e^2} .$$

The dimensionless parameter $\hbar e B_E / m_e^2 = 1.2 \times 10^{-14}$ follows from $m_e = .5$ MeV. The estimate gives $r \sim 2 \times 10^{12}$. Values of Planck constant of this order of magnitude and even larger ones appear in TGD inspired model of brain but in this case magnetic field is Earth's magnetic field and the large thickness of the flux tube makes possible to satisfy the quantization of magnetic flux in which scaled up \hbar defines the unit.

To sum up, large values of Planck constant would be absolutely essential making possible high energy cosmic rays and just the presence of high energy cosmic rays could be seen as an experimental support for the hierarchy of Planck constants. The acceleration mechanism of cosmic rays are poorly understood and TGD option predicts that there is no acceleration mechanism to search for.

Acknowledgements: I want to express my gratitude to my friend Pertti Kärkkäinen for informing me about the theoretical problems related to the precession of equinoxes and for a careful proof reading of the manuscript of this article.

Books related to TGD

- [1] M. Pitkänen. Cosmic Strings. In *Physics in Many-Sheeted Space-Time*. Onlinebook. http://tgd.wippiespace.com/public_html/tgdclass/tgdclass.html#cstrings, 2006.
- [2] M. Pitkänen. Dark Forces and Living Matter. In *p-Adic Length Scale Hypothesis and Dark Matter Hierarchy*. Onlinebook. http://tgd.wippiespace.com/public_html/paddark/paddark.html#darkforces, 2006.
- [3] M. Pitkänen. Dark Matter Hierarchy and Hierarchy of EEGs. In *TGD and EEG*. Onlinebook. http://tgd.wippiespace.com/public_html/tgdeeg/tgdeeg.html#eegdark, 2006.
- [4] M. Pitkänen. Does TGD Predict the Spectrum of Planck Constants? In *Towards M-Matrix*. Onlinebook. http://tgd.wippiespace.com/public_html/tgdquant/tgdquant.html#Planck, 2006.

- [5] M. Pitkänen. Macroscopic Quantum Phenomena and CP_2 Geometry. In *Physics in Many-Sheeted Space-Time*. Onlinebook. http://tgd.wippiespace.com/public_html/tgdclass/tgdclass.html#super, 2006.
- [6] M. Pitkänen. New Particle Physics Predicted by TGD: Part I. In *p-Adic Length Scale Hypothesis and Dark Matter Hierarchy*. Onlinebook. http://tgd.wippiespace.com/public_html/paddark/paddark.html#mass4, 2006.
- [7] M. Pitkänen. TGD and Astrophysics. In *Physics in Many-Sheeted Space-Time*. Onlinebook. http://tgd.wippiespace.com/public_html/tgdclass/tgdclass.html#astro, 2006.
- [8] M. Pitkänen. TGD and Cosmology. In *Physics in Many-Sheeted Space-Time*. Onlinebook. http://tgd.wippiespace.com/public_html/tgdclass/tgdclass.html#cosmo, 2006.
- [9] M. Pitkänen. The Relationship Between TGD and GRT. In *Physics in Many-Sheeted Space-Time*. Onlinebook. http://tgd.wippiespace.com/public_html/tgdclass/tgdclass.html#tgdgrt, 2006.

Mathematics

- [1] Elliptic integral. <http://mathworld.wolfram.com/EllipticIntegral.html>.
- [2] Elliptic integrals. http://en.wikipedia.org/wiki/http://en.wikipedia.org/wiki/Elliptic_integrals.
- [3] Legendre form. http://en.wikipedia.org/wiki/http://en.wikipedia.org/wiki/Legendre_form.
- [4] Weierstrass elliptic function. <http://mathworld.wolfram.com/WeierstrassEllipticFunction.html>.
- [5] Weierstrass elliptic function. http://en.wikipedia.org/wiki/Weierstrass_elliptic_function.

Theoretical Physics

- [1] H. Goldstein. *Classical Mechanics*. Addison Wesley, 1971.

Cosmology and Astro-Physics

- [1] 90377 Sedna. http://en.wikipedia.org/wiki/90377_Sedna.
- [2] Equinoxes. <http://en.wikipedia.org/wiki/Equinox>.
- [3] Kuiper belt. http://en.wikipedia.org/wiki/Kuiper_belt.
- [4] Mysterious band of particles holds clues to Solar System's future. <http://www.cosmosmagazine.com/news/3251/mysterious-band-particles-holds-clues-solar-systems-future>.
- [5] Nemesis. [http://en.wikipedia.org/wiki/Nemesis_\(hypothetical_star\)](http://en.wikipedia.org/wiki/Nemesis_(hypothetical_star)).
- [6] Nutation. <http://en.wikipedia.org/wiki/Nutation>.
- [7] Oort cloud. http://en.wikipedia.org/wiki/Oort_cloud.
- [8] Precession. <http://en.wikipedia.org/wiki/Precession>.
- [9] Precession of equinoxes. http://en.wikipedia.org/wiki/Precession_of_equinoxes.
- [10] Proxima Centauri. http://en.wikipedia.org/wiki/Proxima_Centauri.
- [11] Stellar kinematics. http://en.wikipedia.org/wiki/Moving_group.
- [12] STEREO. <http://en.wikipedia.org/wiki/STEREO>.

- [13] The bubble of our solar system. <http://saturn.jpl.nasa.gov/photos/imagedetails/index.cfm?imageId=3700>.
- [14] Video about. http://www.science20.com/news_releases/heliosphere_versus_heliopause_hot_solar_wind_meets_cold_interstellar_space.
- [15] D. Chandler. MIT instrument finds surprises at solar system's edge. <http://web.mit.edu/newsoffice/2007/voyager-1210.html>.
- [16] W. Cruttenden. Asymmetrical Shape of Heliosphere Raises Questions. <http://www.binaryresearchinstitute.org/bri/research/papers/voyager2.shtml>.
- [17] W. Cruttenden. Earth orientation: does solar system motion matter? <http://www.binaryresearchinstitute.org/bri/images/solarsystemmotion/solarsystemmotion-large.jpg>.
- [18] Ackerman et al. A Cocoon of Freshly Accelerated Cosmic Rays Detected by Fermi in the Cygnus Superbubble. *Science*, 25:2203–22207, 2011.
- [19] L. Grossmann. Cosmic ray factory observed in stellar superbubble. <http://www.newscientist.com/article/dn21210-cosmic-ray-factory-observed-in-stellar-superbubble.html>, 2011.
- [20] D. Shiga. Mysterious source of cosmic rays detected. <http://www.newscientist.com/article/dn10338-mysterious-source-of-cosmic-rays-detected.html>, 2006.

Inflation and TGD

M. Pitkänen

Email: matpitka@luukku.com.

http://tgd.wippiespace.com/public_html/.

December 10, 2011

Contents

1	Introduction	1
2	Brief summary of the inflationary scenario	2
2.1	The problems that inflation was proposed to solve	2
2.2	Evolution of inflationary models	2
3	Comparison with TGD inspired cosmology	3
3.1	What about magnetic monopoles in TGD Universe?	3
3.2	The origin of cosmological principle	4
3.3	Three-space is flat	4
3.4	Replacement of inflationary cosmology with critical cosmology	5
3.5	Fractal hierarchy of cosmologies within cosmologies	6
3.6	Vacuum energy density as magnetic energy of magnetic flux tubes and accelerating expansion	6
3.7	What is the counterpart of cosmological constant in TGD framework?	6
3.8	Speculations about consciousness in cosmic scales	7

Abstract

The comparison of TGD with inflationary cosmology combined with new results about TGD inspired cosmology provides fresh insights to the relationship of TGD and standard approach and shows how TGD cures the lethal diseases of the eternal inflation. Very roughly: the replacement of the energy of the scalar field with magnetic energy replaces eternal inflation with a fractal quantum critical cosmology allowing to see more sharply the TGD counterpart of inflation and accelerating expansion as special cases of criticality. The rapid expansion periods correspond to phase transitions increasing the value of Planck constant and increasing the radius of magnetic flux tubes. This liberates magnetic energy and gives rise to radiation in turn giving rise to radiation and matter in the recent Universe just like the energy of inflaton field would give rise to radiation at the end of the inflation period in cosmic inflation. The multiverse of inflationary scenarios is replaced with the many-sheeted space-time and one can say that the laws of physics are essentially same everywhere in the sense that the fundamental symmetries are the symmetries of standard model everywhere.

1 Introduction

The comparison of TGD with inflationary cosmology combined with new results about TGD inspired cosmology provides fresh insights to the relationship of TGD and standard approach and shows how TGD cures the lethal diseases of the eternal inflation. Very roughly: the replacement of the energy of the scalar field with magnetic energy replaces eternal inflation with a fractal quantum critical cosmology allowing to see more sharply the TGD counterpart of inflation and accelerating expansion as special cases of criticality. Wikipedia gives a nice overall summary inflationary cosmology [1] and I recommend it to the non-specialist physics reader as a manner to refresh his or her memory.

2 Brief summary of the inflationary scenario

Inflationary scenario relies very heavily on rather mechanical unification recipes based on GUTs. Standard model gauge group is extended to a larger group. This symmetry group breaks down to standard model gauge group in GUT scale which happens to correspond to CP_2 size scale. Leptons and quarks are put into same multiplet of the gauge group so that enormous breaking of symmetries occurs as is clear from the ratio of top quark mass scale and neutrino mass scale. These unifiers want however a simple model allowing to calculate so that neither aesthetics nor physics does not matter. The instability of proton is one particular prediction. No decays of proton in the predicted manner have been observed but this has not troubled the gurus. As a matter fact, even Particle Data Tables tell that proton is not stable! The lobbies of GUTs are masters of their profession!

One of the key features of GUT approach is the prediction Higgs like fields. They allow to realize the symmetry breaking and describe particle massivation. Higgs like scalar fields are also the key ingredient of the inflationary scenario and inflation goes to down to drain tub if Higgs is not found at LHC. It is looking more and more probable that this is indeed the case. Inflation has endless variety of variants and each suffers from some drawback. In this kind of situation one would expect that it is better to give up but it has become a habit to say that inflation is more than a theory, it is a paradigm. When superstring models turned out to be a physical failure, they did not same thing and claimed that super string models are more like a calculus rather than mere physical theory.

2.1 The problems that inflation was proposed to solve

The basic problems that inflation was proposed to solve are magnetic monopole problem, flatness problem, and horizon problem. Cosmological principle is a formulation for the fact that cosmic microwave radiation is found to be isotropic and homogenous in an excellent approximation. There are fluctuations in CMB believed to be Gaussian and the prediction for the spectrum of these fluctuations is an important prediction of inflationary scenarios.

1. Consider first the horizon problem. The physical state inside horizon is not causally correlated with that outside it. If the observer today receives signals from a region of past which is much larger than horizon, he should find that the universe is not isotropic and homogenous. In particular, the temperature of the microwave radiation should fluctuate wildly. This is not the case and one should explain this.

The basic idea is that the potential energy density of the scalar field implies exponential expansion in the sense that the "radius" of the Universe increases with an exponential rate with respect to cosmological time. This kind of Universe looks locally like de-Sitter Universe. This fast expansion smooths out any inhomogenities and non-isotropies inside horizon. The Universe of the past observed by a given observer is contained within the horizon of the past so that it looks isotropic and homogenous.

2. GUTs predict a high density of magnetic monopoles during the primordial period as singularities of non-abelian gauge fields. Magnetic monopoles have not been however detected and one should be able to explain this. The idea is very simple. If Universe suffers an exponential expansion, the density of magnetic monopoles gets so diluted that they become effectively non-existent.
3. Flatness problem means that the curvature scalar of 3-space defined as a hyper-surface with constant value of cosmological time parameter (proper time in local rest system) is vanishing in an excellent approximation. de-Sitter Universe indeed predicts flat 3-space for a critical mass density. The contribution of known elementary particles to the mass density is however much below the critical mass density so that one must postulate additional forms of energy. Dark matter and dark energy fit the bill. Dark energy is very much analogous to the vacuum energy of Higgs like scalar fields in the inflationary scenario but the energy scale of dark energy is by 27 orders of magnitude smaller than that of inflation, about 10^{-3} eV.

2.2 Evolution of inflationary models

The inflationary models developed gradually more realistic.

1. Alan Guth was the first to realize that the decay of false (unstable) vacuum in the early universe could solve the problem posed by magnetic monopoles. What would happen would be the analog of super-cooling in thermodynamics. In super-cooling the phase transition to stable thermodynamical phase does not occur at the critical temperature and cooling leads to a generation of bubbles of the stable phase which expand with light velocity.

The unstable super-cooled phase would locally correspond to exponentially expanding de-Sitter cosmology with a non-vanishing cosmological constant and high energy density assignable to the scalar field. The exponential expansion would lead to a dilution of the magnetic monopoles and domain walls. The false vacuum corresponds to a value of Higgs field for which the symmetry is not broken but energy is far from minimum. Quantum tunneling would generate regions of true vacuum with a lower energy and expanding with a velocity of light. The natural hope would be that the energy of the false vacuum would generate radiation inducing reheating. Guth however realized that nucleation does not generate radiation. The collisions of bubbles do so but the rapid expansion masks this effect.

2. A very attractive idea is that the energy of the scalar field transforms to radiation and produces in this manner what we identify as matter and radiation. To realize this dream the notion of slow-roll inflation was proposed. The idea was that the bubbles were not formed at all but that the scalar field gradually rolled down along almost flat hill. This gives rise to an exponential inflation in good approximation. At the final stage the slope of the potential would come so steep that reheating would take place and the energy of the scalar field would transform to radiation. This requires a highly artificial shape of the potential energy. There is also a fine tuning problem: the predictions depend very sensitively on the details of the potential so that strictly speaking there are no predictions anymore. Inflaton should have also a small mass and represent new kind of particle.
3. The tiny quantum fluctuations of the inflaton field have been identified as the seed of all structures observed in the recent Universe. These density fluctuations make them visible also as fluctuations in the temperature of the cosmic microwave background and these fluctuations have become an important field of study (WMAP).
4. In the hybrid model of inflation there are two scalar fields. The first one gives rise to slow-roll inflation and second one puts end to inflationary period when the first one has reached a critical value by decaying to radiation. It is of course imagine endless number of speculative variants of inflation and Wikipedia article summarizes some of them.
5. In eternal inflation the quantum fluctuations of the scalar field generate regions which expand faster than the surrounding regions and gradually begin to dominate. This means that there is eternal inflation meaning continual creation of Universes. This is the basic idea behind multiverse thinking. Again one must notice that scalar fields are essential: in absence of them the whole vision falls down like a card house.

The basic criticism of Penrose against inflation is that it actually requires very specific initial conditions and that the idea that the uniformity of the early Universe results from a thermalization process is somehow fundamentally wrong. Of course, the necessity to assume scalar field and a potential energy with a very weird shape whose details affect dramatically the observed Universe, has been also criticized.

3 Comparison with TGD inspired cosmology

It is good to start by asking what are the empirical facts and how TGD can explain them.

3.1 What about magnetic monopoles in TGD Universe?

Also TGD predicts magnetic monopoles. CP_2 has a non-trivial second homology and second geodesic sphere represents a non-trivial element of homology. Induced Kähler magnetic field can be a monopole field and cosmic strings are objects for which the transversal section of the string carries monopole flux. The very early cosmology is dominated by cosmic strings carrying magnetic monopole fluxes. The

monopoles do not however disappear anywhere. Elementary particles themselves are string like objects carrying magnetic charges at their ends identifiable as wormhole throats at which the signature of the induced metric changes. For fermions the second end of the string carries neutrino pair neutralizing the weak isospin. Also color confinement could involve magnetic confinement. These monopoles are indeed seen: they are essential for both the screening of weak interactions and for color confinement!

3.2 The origin of cosmological principle

The isotropy and homogeneity of cosmic microwave radiation is a fact as are also the fluctuations in its temperature as well as the anomalies in the fluctuation spectrum suggesting the presence of large scale structures. Inflationary scenarios predict that fluctuations correspond to those of nearly gauge invariant Gaussian random field. The observed spectral index measuring the deviation from exact scaling invariance is consistent with the predictions of inflationary scenarios.

Isotropy and homogeneity reduce to what is known as cosmological principle. In general relativity one has only local Lorentz invariance as approximate symmetry. For Robertson-Walker cosmologies with sub-critical mass density one has Lorentz invariance but this is due to the assumption of cosmological principle - it is not a prediction of the theory. In inflationary scenarios the goal is to reduce cosmological principle to thermodynamics but fine tuning problem is the fatal failure of this approach.

In TGD inspired cosmology [6] cosmological principle reduces sub-manifold gravity in $H = M^4 \times CP_2$ predicting a global Poincare invariance reducing to Lorentz invariance for the causal diamonds. This represent extremely important distinction between TGD and GRT. This is however not quite enough since it predicts that Poincare symmetries treat entire partonic 2-surfaces at the end of CD as points rather than affecting on single point of space-time. More is required and one expects that also now finite radius for horizon in very early Universe would destroy the isotropy and homogeneity of 3 K radiation. The solution of the problem is simple: cosmic string dominated primordial cosmology has infinite horizon size so that arbitrarily distance regions are correlated. Also the critical cosmology, which is determined part from the parameter determining its duration by its imbeddability, has infinite horizon size. Same applies to the asymptotic cosmology for which curvature scalar is extremized.

The hierarchy of Planck constants [3] and the fact that gravitational space-time sheets should possess gigantic Planck constant suggest a quantum solution to the problem: quantum coherence in arbitrary long length scales is present even in recent day Universe. Whether and how this two views about isotropy and homogeneity are related by quantum classical correspondence, is an interesting question to ponder in more detail.

3.3 Three-space is flat

The flatness of three-space is an empirical fact and can be deduced from the spectrum of microwave radiation. Flatness does not however imply inflation, which is much stronger assumption involving the questionable scalar fields and the weird shaped potential requiring a fine tuning. The already mentioned critical cosmology is fixed about the value value of only single parameter characterizing its duration and would mean extremely powerful predictions since just the imbeddability would fix the space-time dynamics almost completely.

Exponentially expanding cosmologies with critical mass density do not allow imbedding to $M^4 \times CP_2$. Cosmologies with critical or over-critical mass density and flat 3-space allow imbedding but the imbedding fails above some value of cosmic time. These imbeddings are very natural since the radial coordinate r corresponds to the coordinate r for the Lorentz invariant $a=\text{constant}$ hyperboloid so that cosmological principle is satisfied.

Can one imbed exponentially expanding sub-critical cosmology? This cosmology has the line element

$$ds^2 = dt^2 - ds_3^2 \quad , \quad ds_3^2 = \sinh^2(t) d\Omega_3^2 \quad ,$$

where ds_3^2 is the metric of the $a = \text{constant}$ hyperboloid of M_+^4 (future light-cone).

1. The simplest imbedding is as vacuum extremal to $M^4 \times S^2$, S^2 the homologically trivial geodesic sphere of CP_2 . The imbedding using standard coordinates (a, r, θ, ϕ) of M_+^4 and spherical coordinates (Θ, Φ) for S^2 is to a geodesic circle (the simplest possibility)

$$\Phi = f(a) \ , \ \Theta = \pi/2 \ .$$

2. $\Phi = f(a)$ is fixed from the condition

$$a = \sinh(t) \ ,$$

giving

$$g_{aa} = (dt/da)^2 = \frac{1}{\cosh^2(t)}$$

and from the condition for the g_{aa} as a component of induced metric tensor

$$g_{aa} = 1 - R^2 \left(\frac{df}{da}\right)^2 = \frac{1}{\cosh^2(t)} \ .$$

3. This gives

$$\frac{df}{da} = \pm \frac{1}{R} \times \tanh(t)$$

giving $f(a) = (\cosh(t) - 1)/R$. Inflationary cosmology allows imbedding but this imbedding cannot have a flat 3-space and therefore cannot make sense in TGD framework.

3.4 Replacement of inflationary cosmology with critical cosmology

In TGD framework inflationary cosmology is replaced with critical cosmology. The vacuum extremal representing critical cosmology is obtained has 2-D CP_2 projection- in the simplest situation geodesic sphere. The dependence of Φ on r and Θ on a is fixed from the condition that one obtains flat 3-metric

$$\frac{a^2}{1+r^2} - R^2 \sin^2(\Theta) \left(\frac{d\Phi}{dr}\right)^2 = a^2 \ .$$

This gives

$$\sin(\Theta) = \pm ka \ , \ \frac{d\Phi}{dr} = \pm \frac{1}{kR} \frac{r}{\sqrt{1+r^2}} \ .$$

The imbedding fails for $|ka| > 1$ and is unique apart from the parameter k characterizing the duration of the critical cosmology. The radius of the horizon is given by

$$R = \int \frac{1}{a} \sqrt{1 - \frac{R^2 k^2}{1 - k^2 a^2}}$$

and diverges. This tells that there are no horizons and therefore cosmological principle is realized. Infinite horizon radius could be seen as space-time correlate for quantum criticality implying long range correlations and allowing to realize cosmological principle. Therefore thermal realization of cosmological principle would be replaced with quantum realization in TGD framework predicting long range quantal correlations in all length scales. Obviously this realization is a in well-defined sense the diametrical opposite of the thermal realization. The dark matter hierarchy is expected to correspond to the microscopic realization of the cosmological principle generating the long range correlations.

Critical cosmology could describe the phase transition increasing Planck constant associated with a magnetic flux tube leading to its thickening. Magnetic flux would be conserved and the magnetic energy for the thickened portion would be reduced via its partial transformation to radiation giving rise to ordinary and dark matter.

3.5 Fractal hierarchy of cosmologies within cosmologies

Many-sheeted space-time leads to a fractal hierarchy of cosmologies within cosmologies. In zero energy ontology the realization is in terms of causal diamonds within causal diamonds with causal diamond identified as intersection of future and past directed light-cones. One can say that everything can be created from vacuum. The temporal distance between the tips of CD is given as an integer multiple of CP_2 time in the most general case and boosts of CD s are allowed. There are also other moduli associated with CD and discretization of the moduli parameters is strong suggestive.

Critical cosmology corresponds to negative value of "pressure" so that it also gives rise to accelerating expansion. This suggests strongly that both the inflationary period and the accelerating expansion period which is much later than inflationary period correspond to critical cosmologies differing from each other by scaling. Continuous cosmic expansion is replaced with a sequence of discrete expansion phases in which the Planck constant assignable to a magnetic flux quantum increases and implies its expansion. This liberates magnetic energy as radiation so that a continual creation of matter takes place in various scales.

This fractal hierarchy is the TGD counterpart for the eternal inflation. This fractal hierarchy implies also that the TGD counterpart of inflationary period is just a scaled up invariant of critical cosmologies within critical cosmologies. Of course, also radiation and matter dominated phases as well as asymptotic string dominated cosmology are expected to be present and correspond to cosmic evolutions within given CD .

The multiverse of inflationary scenarios is replaced with the many-sheeted space-time (recall that various p-adic physics as correlates for cognition and the hierarchy of Planck constants mean quite a generalization so that a lot of new physics emerges) and one can say that the laws of physics are essentially the same everywhere in the sense that the fundamental symmetries are the symmetries of the standard model everywhere.

3.6 Vacuum energy density as magnetic energy of magnetic flux tubes and accelerating expansion

TGD allows a more microscopic view about cosmology based on the vision that primordial period is dominated by cosmic strings which during cosmic evolution develop 4-D M^4 projection meaning that the thickness of the M^4 projection defining the thickness of the magnetic flux tube gradually increases [6]. The magnetic tension corresponds to negative pressure and can be seen as a microscopic cause of the accelerated expansion. Magnetic energy is in turn the counterpart for the vacuum energy assigned with the inflaton field. The gravitational Planck constant assignable to the flux tubes mediating gravitational interaction nowadays is gigantic and they are thus in macroscopic quantum phase. This explains the cosmological principle at quantum level.

The phase transitions inducing the boiling of the magnetic energy to ordinary matter are possible. What happens that the flux tube suffers a phase transition increasing its radius. This however reduces the magnetic energy so that part of magnetic energy must transform to ordinary matter. This would give rise to the formation of stars and galaxies. This process is the TGD counterpart for the re-heating transforming the potential energy of inflaton to radiation. The local expansion of the magnetic flux could be described in good approximation by critical cosmology since quantum criticality is in question.

One can of course ask whether inflationary cosmology could describe the transition period and critical cosmology could correspond only to the outcome. This does not look very attractive idea since the CP_2 projections of these cosmologies have dimension $D=1$ and $D=2$ respectively.

In TGD framework the fluctuations of the cosmic microwave background correspond to mass density gradients assignable to the magnetic flux tubes. An interesting question is whether the flux tubes could reveal themselves as a fractal network of linear structures in CMB. The prediction is that galaxies are like pearls in a necklace: smaller cosmic strings around long cosmic strings. The model discussed for the formation of stars and galaxies discussed in the previous section gives a more detailed view about this.

3.7 What is the counterpart of cosmological constant in TGD framework?

In TGD framework cosmological constant emerges when one asks what might be the GRT limit of TGD [7], [1]. Space-time surface decomposes into regions with both Minkowskian and Euclidian

signature of the induced metric and Euclidian regions have interpretation as counterparts of generalized Feynman graphs. Also GRT limit must allow space-time regions with Euclidian signature of metric - in particular CP_2 itself - and this requires positive cosmological constant in this regions. The action principle is naturally Maxwell-Einstein action with cosmological constant which is vanishing in Minkowskian regions and very large in Euclidian regions of space-time. Both Reissner-Nordström metric and CP_2 are solutions of field equations with deformations of CP_2 representing the GRT counterparts of Feynman graphs. The average value of the cosmological constant is very small and of correct order of magnitude since only Euclidian regions contribute to the spatial average. This picture is consistent with the microscopic picture based on the identification of the density of magnetic energy as vacuum energy since Euclidian particle like regions are created as magnetic energy transforms to radiation.

3.8 Dark energy and cosmic consciousness

The hierarchy of Planck constants makes possible macroscopic quantum coherence in arbitrarily long scales. Macroscopic quantum coherence is essential for life and the notion of magnetic body is central in TGD inspired biology. For instance, the braiding of flux tubes making possible topological quantum computation like processes [2]. The findings of Peter Gariaev [2, 3, 5] provide support for the notion of magnetic body containing dark matter [1]. The notion of magnetic body also inspires science fictive ideas like remote replication of DNA [8] for which there is also some support and which could be essential for understanding water memory [4, 1].

The gravitational Planck constant $\hbar_{gr} = GM_1M_2/v_0$ (v_0 is dimensionless parameter in units for which $c = 1$ but has interpretation as velocity) assumed in the model of planetary system based on Bohr orbitology [5, 4] is assigned to the magnetic flux quanta mediating gravitational interaction between objects with masses M_1 and M_2 ($M_1 = M_2$ for self gravitation). For these values of Planck constant the quantum scales are gigantic. Even for gravitational magnetic flux tubes connecting electron with Sun, the Compton length would be of the order of the radius of Sun. If there are ordinary particles at these flux tubes, their Compton length is enormous and their density is essentially constant.

The fractality of TGD Universe and of the magnetic flux tube hierarchy forces to ask whether intelligent consciousness could be possible in cosmic scales and be based on the Indra's net of the magnetic flux tubes. This cosmic nervous system would carry dark energy as magnetic energy with magnetic tension responsible for the negative "pressure" causing accelerated expansion. This Indra's web would act as super-intelligence taking the role of God by creating stars and galaxies by transforming magnetic energy to radiation and matter in phase transitions increasing the Planck constant and driving the evolution of this cosmic intelligence. In inflationary scenario inflaton field would have similar role. In zero energy ontology there is no deep reason preventing for the creation of entire sub-cosmologies from vacuum.

Books related to TGD

- [1] P. Gariaev and M. Pitkänen. Model for the Findings about Hologram Generating Properties of DNA. In *Genes and Memes*. Onlinebook. http://tgd.wippiespace.com/public_html/genememe/genememe.html#dnahologram, 2011.
- [2] M. Pitkänen. DNA as Topological Quantum Computer. In *Genes and Memes*. Onlinebook. http://tgd.wippiespace.com/public_html/genememe/genememe.html#dnatqc, 2006.
- [3] M. Pitkänen. Does TGD Predict the Spectrum of Planck Constants? In *Towards M-Matrix*. Onlinebook. http://tgd.wippiespace.com/public_html/tgdquant/tgdquant.html#Planck, 2006.
- [4] M. Pitkänen. Quantum Astrophysics. In *Physics in Many-Sheeted Space-Time*. Onlinebook. http://tgd.wippiespace.com/public_html/tgdclass/tgdclass.html#qastro, 2006.
- [5] M. Pitkänen. TGD and Astrophysics. In *Physics in Many-Sheeted Space-Time*. Onlinebook. http://tgd.wippiespace.com/public_html/tgdclass/tgdclass.html#astro, 2006.
- [6] M. Pitkänen. TGD and Cosmology. In *Physics in Many-Sheeted Space-Time*. Onlinebook. http://tgd.wippiespace.com/public_html/tgdclass/tgdclass.html#cosmo, 2006.

- [7] M. Pitkänen. The Relationship Between TGD and GRT. In *Physics in Many-Sheeted Space-Time*. Onlinebook. http://tgd.wippiespace.com/public_html/tgdclass/tgdclass.html#tgdgrt, 2006.
- [8] M. Pitkänen and P. Gariaev. Quantum Model for Remote Replication. In *Genes and Memes*. Onlinebook. http://tgd.wippiespace.com/public_html/genememe/genememe.html#remotereplication, 2011.

Articles about TGD

- [1] M. Pitkänen. TGD inspired vision about entropic gravitation. http://tgd.wippiespace.com/public_html/articles/egtgd.pdf, 2011.

Cosmology and Astro-Physics

- [1] Cosmic inflation. http://en.wikipedia.org/wiki/Cosmic_inflation.

Biology

- [1] L. Montagnier et al. DNA waves and water. <http://arxiv.org/abs/1012.5166>, 2010.
- [2] P. Gariaev et al. *The DNA-wave biocomputer*, volume 10. CHAOS, 2001.
- [3] P. P. Gariaev et al. The spectroscopy of bio-photons in non-local genetic regulation. *Journal of Non-Locality and Remote Mental Interactions*, (3), 2002.
- [4] S. Ferris J.-L. Montagnier L. Montagnier, J. Aissa and C. Lavall'e. Electromagnetic Signals Are Produced by Aqueous Nanostructures Derived from Bacterial DNA Sequences. *Interdiscip. Sci. Comput. Life Sci.*, 2009.
- [5] A.V. Tovmash P. P. Gariaev, G. G. Tertishni. Experimental investigation in vitro of holographic mapping and holographic transposition of DNA in conjunction with the information pool encircling DNA. *New Medical Tehcnologies*, 9:42–53, 2007.

QCD and TGD

M. Pitkänen

Email: matpitka@luukku.com.

http://tgd.wippiespace.com/public_html/.

December 19, 2011

Contents

1	Introduction	1
2	Basic differences between QCD and TGD	3
2.1	How the TGD based notion of color differs from QCD color?	3
2.2	Generalized Feynman diagrams and string-parton duality as gauge-gravity duality . . .	4
2.3	Q^2 dependent quark distribution functions and fragmentation functions in zero energy ontology	5
2.3.1	Probabilistic description of quarks in ZEO	5
2.3.2	Q^2 dependence of distribution and fragmentation functions in ZEO	5
3	p-Adic physics and strong interactions	6
3.1	p-Adic real correspondence as a new symmetry	6
3.2	Logarithmic corrections to cross sections and jets	7
3.3	p-Adic length scale hypothesis and hadrons	9
4	Magnetic flux tubes and and strong interactions	9
4.1	Magnetic flux tube in TGD	9
4.2	Reconnection of color magnetic flux tubes and non-perturbative aspects of strong interactions	10
4.3	Quark gluon plasma	11
4.4	Super-symmetry and hadron physics	11
4.5	Exotic pion like states: "infra-red" Regge trajectories or Shnoll effect?	12
5	Higgs or M_{89} hadron physics?	13

Abstract

During last week I have been listening some very inspiring Harward lectures relating to QCD, jets, gauge-gravity correspondence, and quark gluon plasma. Matthew Schwartz gave a talk titled *The Emergence of Jets at the Large Hadron Collider*. Dam Thanh Son's talk had the title *Viscosity, Quark Gluon Plasma, and String Theory*. Factorization theorems of jet QCD discussed in very clear manner by Ian Stewart in this talk titled *Mastering Jets: New Windows into Strong Interaction and Beyond*.

These lecture inspired several blog postings and also the idea about a systematical comparison of QCD and TGD. This kind of comparisons are always very useful - at least to me - since they make it easier to see why the cherished beliefs- now the belief that QCD is *the* theory of strong interactions - might be wrong.

1 Introduction

During last week I have been listening some very inspiring Harward lectures relating to QCD, jets, gauge-gravity correspondence, and quark gluon plasma. Matthew Schwartz gave a talk titled *The Emergence of Jets at the Large Hadron Collider* [4]. Dam Thanh Son's talk had the title *Viscosity,*

Quark Gluon Plasma, and String Theory [5]. Factorization theorems of jet QCD discussed in very clear manner by Ian Stewart [6] in this talk titled *Mastering Jets: New Windows into Strong Interaction and Beyond*.

These lecture several blog postings and also inspired the idea about a systematical comparison of QCD and TGD. This kind of comparisons are always very useful -at lest to myself - since they make it easier to see why the cherished beliefs- now the belief that QCD is *the* theory of strong interactions - might be wrong.

There are several crucial differences between QCD and TGD.

1. The notion of color is different in these two theories. One prediction is the possibility of lepto-hadron physics [13] involving colored excitations of leptons.
2. In QCD AdS/CFT duality is hoped to allow the description of strong interactions in long scales where perturbative QCD fails. The TGD version of gauge-gravity duality is realized at space-time level and is much stronger: string-parton duality is manifest at the level of generalized Feynman diagrams.
3. TGD form of gauge-gravity duality suggests a stronger duality: p-adic-real duality. This duality allows to sum the perturbation theories in strong coupling regime by summing the p-adic perturbation series and mapping it to real one by canonical correspondence between p-adics and reals. This duality suggests that factorization "theorems" have a rigorous basis due to the fact that quantum superposition of amplitudes would be possible inside regions characterized by given p-adic prime. p-Adic length scale hypothesis suggests that p-adically scaled up variants of quarks are important for the understanding of the masses of low lying hadrons. Also scaled up versions of hadron physics are important and both Tevatron and LHC have found several indications for M_{89} hadron physics [7].
4. Magnetic flux tubes are the key entities in TGD Universe. In hadron physics color magnetic flux tubes carrying Kähler magnetic monopole fluxes would be responsible for the non-perturbative aspects of QCD [14]. Reconnection process for the flux tubes (or for the corresponding strings) would be responsible for the formation of jets and their hadronization. Jets could be seen as structures connected by magnetic flux tubes to form a connected structure and therefore as hadron like objects. Ideal QCD plasma would be single hadron like objects. In QCD framework quark-gluon plasma would be more naturally gas of partons.
5. Super-symmetry in TGD framework differs from the standard SUSY and the difficult-to-understand X and Y bosons believed to consist of charmed quark pair force to consider the possibility that they are actually smesons rather than mesons [7]. This leads to a vision in which squarks have the same p-adic length scale as quarks but that the strong mixing between smesons and mesons makes second mass squared eigenstate tachyonic and thus unphysical. This together with the fact that hadronization is a fast process as compared to electroweak decays of squarks weak bosons and missing energy would explain the failure to observe SUSY at LHC. An alternative option is that covariantly constant right handed neutrino generates gauge supersymmetry and as an operator creates zero norm state. The generator of SUSY would be color octet partial wave of right-handed neutrino. Color confinement would make impossible the decays producing the standard missing energy signatures of SUSY. This would allow to interpret lepto-hadrons as pion-like states formed from color octet sleptons.
6. p-Adic length scale hypothesis leads to the prediction that hadron physics should possess scaled variants. A good guess is that these scaled variants correspond to ordinary Mersenne primes $M_n = 2^n - 1$ or Gaussian (complex) Mersenne primes. $M_{89} = 2^{89} - 1$ hadron physics would be one such scaled variant of hadron physics. The mass scale of hadrons would be roughly 512 higher than for ordinary hadrons, which correspond to M_{107} . In zero energy ontology Higgs is not necessarily needed to give mass for gauge bosons and if Higgs like states are there, all of them are eaten by states which become massive. Therefore Higgs would be only trouble makers in TGD Universe.

The neutral mesons of M_{89} hadron physics would however give rise to Higgs like signals since their decay amplitudes are very similar to those of Higgs even at quantitative level if one accepts the generalization of partially conserved axial current hypothesis.

The recent reports by ATLAS and CMS about Higgs search support the existence of Higgs like signal around about 125 GeV. In TGD framework the interpretation would be as pion like state. There is however also evidence for Higgs like signals at higher masses and standard Higgs is not able to explain this signals. Furthermore, Higgs with about 125 GeV mass is just at the border of vacuum stability, and new particles would be needed to stabilize the vacuum. The solution provided by TGD is that entire scaled up variant of hadron physics replaces Higgs. Within a year it should become clear whether the observed signal is Higgs or pionlike state of M_{89} hadron physics or something else.

2 Basic differences between QCD and TGD

The basic difference between QCD and TGD follow from different views about color, zero energy ontology, and from the notion of generalized Feynman diagram.

2.1 How the TGD based notion of color differs from QCD color?

TGD view about color is different from that of QCD. In QCD color is spin like quantum number. In TGD Universe it is like angular momentum and one can speak about color partial waves in CP_2 . Quarks and leptons must have non-trivial coupling to CP_2 Kähler gauge potential in order to obtain a respectable spinor structure. This coupling is odd multiplet of Kähler gauge potential and for $n = 1$ for quarks and $n = 3$ for leptons one obtains a geometrization of electro-weak quantum numbers in terms of induced spinor structure and geometrization of classical and color gauge potentials. This has several far reaching implications.

1. Lepton and baryon numbers are separately conserved. This is not possible in GUTs. Despite the intense search no decays of proton predicted by GUTs have been observed: a strong support for TGD approach.
2. Infinite number of color partial waves can assigned to leptons and quarks and they obey the triality rule: $t = 0$ or leptons and $t = +1/-1$ for quarks/antiquarks. The color partial waves however depend on charge and CP_2 handedness and therefore on M^4 chirality. The correlation is not correct. Also the masses are gigantic of order CP_2 mass as eigenvalues of CP_2 Laplace operator. Only right handed covariantly constant lepton would have correct color quantum numbers.

The problem can be cured if one accepts super-conformal invariance. Conformal generators carrying color contribute to the color quantum numbers of the particle state. p-Adic mass calculations show that if ground states have simple negative conformal weight making it tachyon, it is possible to have massless states with correct correlation between electroweak quantum numbers and color [6].

3. Both leptons and quarks have color excited states. In leptonic sector color octet leptons are possible and there is evidence already from seventies that states having interpretation as leptopion are created in heavy ion collisions [13]. During last years evidence for muo-pions and tau-pions has emerged and quite recently CDF provided additional evidence for tau-pions.

Light colored excitations of leptons and quarks are in conflict what is known about the decay width of intermediate gauge bosons and the way out is to assume that these states are dark matter in the sense that they have effective value of Planck constant coming as integer multiple of the ordinary Planck constant [4]. Only particles with the same value of Planck constant can appear in the same vertex of generalized Feynman diagram so that these particles are dark in the weakest possible sense of the world. The Planck constant can however change when particle tunnels between different sectors of the generalized imbedding spaces consisting of coverings of the imbedding space $M^4 \times CP_2$.

The attribute "effective" applies in the simplest interpretation for the dark matter hierarchy based on many-valuedness of the normal derivatives of the imbedding space coordinates as functions of the canonical momentum densities of Kähler action. Many-valuedness is implied by the gigantic vacuum degeneracy of Kähler action: any 4-surface with CP_2 projection which

is Lagrangian manifold of CP_2 is vacuum extremal and preferred extremals are deformations of these. The branches co-incide at 3-D space-like ends of the space-time surface at boundaries of CD and at 3-D light-like orbits of wormhole throats at which the signature of the induced metric changes. The value of the effective Planck constant corresponds to the number of sheets of this covering of imbedding space and there are arguments suggesting that this integer is product of two integers assignable to the multiplicities of the branches of space-like 3-surfaces and light-like orbits. At partonic 2-surfaces the degeneracy is maximal since all $n = n_1 \times n_2$ sheets co-incide. This structure brings very strongly in mind the stack of branes infinitesimally near to each other appearing in AdS/CFT duality. TGD analogs of 3-branes of the stacks would be distinct in the interior of the space-time surface.

4. TGD predicts the presence of long ranged classical color gauge potentials identified as projections of CP_2 Killing forms to the space-time surface. Classical color gauge fields are proportional to induced Kähler form and Hamiltonians of color isometries: $G_A = H_A J$. All components of the classical gluon field have the same direction. Also long ranged classical electroweak gauge fields are predicted and one of the implications is an explanation for the large parity breaking in living matter (chiral selection of molecules).

Long ranged classical color fields mean a very profound distinction between QCD color and TGD color and in TGD inspired hadron physics color magnetic flux tubes carrying classical color gauge fields are responsible for the strong interactions in long length scales. These color magnetic fields carrying Kähler magnetic monopole fluxes are absolutely essential in TGD based view about quark distribution functions and hadronic fragmentation functions of quarks and represent the long range hadron physics about which QCD cannot say much using analytic formulas: numerical lattice calculations provide the only manner to tackle the problem.

5. Twistorial approach to $\mathcal{N} = 4$ super-symmetric gauge theory could be seen as a diametrical opposite of jet QCD. It has been very successful but it is perturbative approach and I find it difficult to see how it could produce something having the explanatory power of color magnetic flux tubes.

2.2 Generalized Feynman diagrams and string-parton duality as gauge-gravity duality

Generalized Feynman diagrams reduce to generalized braid diagrams [14]. Braid strands have unique identification as so called Legendrean braids identifiable as boundaries of string world sheets which are minimal surfaces for which area form is proportional to Kähler flux. One can speak about sub-manifold braids.

There are no $n > 2$ -vertices at the fundamental braid strand level. Together with the fact that in zero energy ontology (ZEO) all virtual states consist of on mass shell massless states assignable to braid strands, this means that UV and IR infinities are absent. All physical states are massive bound states of massless on mass shell states. Even photon, gluon, and graviton have small masses. No Higgs is needed since for the generalized Feynman diagrams the condition eliminating unphysical polarizations eliminates only the polarization parallel to the projection of the total momentum of the particle to the preferred plane M^2 defining the counterpart of the plane in which one usually projects Feynman diagrams.

The crossings for the lines of non-planar Feynman diagrams represent generalization of the crossings of the braid diagrams and integrable M^2 QFT is suggested to describe the braiding algebraically. This would mean that non-planar diagrams are obtained from planar ones by braiding operations and generalized Feynman diagrams might be constructed like knot invariants by gradually trivializing the braid diagram. This would allow to reduce the construction of also non-planar Feynman amplitudes to twistorial rules.

One can interpret gluons emission by quark as an emission of meson like state by hadron. This duality is exact and does not require $N_c \rightarrow \infty$ limit allowing to neglect non-planar diagrams as AdS/CFT correspondence requires. The interpretation is in terms of duality: one might call this duality parton-hadron duality, gauge-gravity duality, or particle-string duality.

2.3 Q^2 dependent quark distribution functions and fragmentation functions in zero energy ontology

Factorization of the strong interaction physics in short and long time scales is one of the basic assumptions of jet QCD and originally motivated by parton model which preceded QCD [2, 3]. The physical motivation for the factorization in higher energy collision is easy to deduce at the level of parton model. By Lorentz contraction of colliding hadrons look very thin and by time dilation the collision time is very long in cm system. Therefore the second projectile moves in very short time through the hadron and sees the hadron in frozen configuration so that the state of the hadron can be thought of as being fixed during collision and partons interact independently. This looks very clear intuitively but it is not at all clear whether QCD predicts this picture.

2.3.1 Probabilistic description of quarks in ZEO

Probabilistic description requires further assumptions. Scattering matrix element is in good approximation sum over matrix elements describing scattering of partons of hadron from -say- the partons of another hadron or from electron. Scattering amplitudes in the sum reduce to contractions of current matrix elements with gluon or gauge boson propagator. Scattering probability is the square of this quantity and contains besides diagonal terms for currents also cross terms. Probabilistic description demands that the sum of cross terms can be neglected. Why the phases of the terms in this sum should vary randomly? Does QCD really imply this kind of factorization?

Could the probabilistic interpretation require and even have a deeper justification?

1. p-Adic real correspondence to be discussed in more detail below suggest how to proceed. Quarks with different p-adic mass scales can correspond to different p-adic number fields with real amplitudes or probabilities obtained from their p-adic counterparts by canonical identification. Interference makes sense only for amplitudes in the same number field. Does this imply that cross terms involving different p-adic primes cannot appear in the scattering amplitudes?
2. Should one assume only a density matrix description for the many quark states formed from particles with different values of p-adic prime p ? If so the probabilistic description would be un-avoidable. This does not look an attractive idea as such. Zero energy ontology however replaces density matrix with M -matrix defined as the hermitian square root of the density matrix multiplied by a universal unitary S -matrix. The modulus squared of M -matrix element gives scattering probability.

One can imagine that M -matrix at least approximately decomposes to a tensor product of M -matrices in different length scales: these matrices could correspond to different number fields before the map to real numbers and probabilities could be formed as "numbers" in the tensor product of p-adic number fields before the mapping to real numbers by canonical identification.

In finite measurement resolution one sums over probabilities in short length scales so that the square of M -matrix in short scale gives density matrix. Could this lead to a probabilistic description at quark level? Distribution functions and fragmentation functions could indeed correspond to these probabilities since they emerge in QCD picture from matrix elements between initial and final states of quark in scattering process. Now these states correspond to the positive and negative energy parts of zero energy state.

2.3.2 Q^2 dependence of distribution and fragmentation functions in ZEO

The probabilistic description of the jet QCD differs from that of parton model in that the parton distributions and fragmentation functions depend on the value of Q^2 , where Q is defined as the possibly virtual momentum of the initial state of the parton level system. Q could correspond to the momentum of virtual photon annihilation to quark pair in the annihilation of e^+e^- pair to hadrons, to the virtual photon decaying to $\mu^+\mu^-$ pairs and emitted by quark after quark-quark scattering in Drell-Yan process, or to the momentum of gluon or quark giving rise to a jet, ... What is highly non-trivial is that distribution and fragmentation functions are universal in the sense that they do not depend on the scattering process. Furthermore, the dependence on Q^2 can be determined from renormalization group equations [2, 3].

What does Q^2 's dependence mean in TGD framework?

1. In partonic model this dependence looks strange. If one thinks the scattering at quantum level, this dependence is very natural since it corresponds to the dependence of the matrix elements of current operators on the momentum difference between quark spinors in the matrix element. In QCD framework Q^2 dependence is not mysterious. It is the emergence of probabilistic description which is questionable in QFT framework.
2. One could perhaps say that Q^2 represents resolution and that hadron looks different in different resolutions. One could also say that there is no hadron "an sich": what hadron looks like depends on the process used to study it.
3. In zero energy ontology the very notion of state changes. Zero energy state corresponds to physical event or quantum superposition of them with M -matrix defining the time like entanglement coefficient and equal to a hermitian square root of density matrix and S -matrix. In this framework different values of Q correspond to different momentum differences for spinor pairs appearing in the matrix element of the currents and Q^2 dependence of the probabilistic description is very natural. The universality of distribution and fragmentation functions follows in zero energy ontology if one assumes the factorization of the dynamics in different length scales. This should follow from the universality of the S -matrix in given number field (in given p-adic length scale).

3 p-Adic physics and strong interactions

p-Adic physics provides new insights to hadron physics not provided by QCD.

3.1 p-Adic real correspondence as a new symmetry

The exactness of the gauge-gravity duality suggests the presence of an additional symmetry. Perhaps the non-converging perturbative expansion at long scales could make sense after all in some sense. p-Adic-real duality suggests how.

1. The perturbative expansion is interpreted in terms of p-adic numbers and the effective coupling constant $g^2 MN_c$ is interpreted as p-adic number which for some preferred primes is proportional to the p-adic prime p and therefore p-adically small. Hence the expansion converges rapidly p-adically. The p-adic amplitudes would be obtained by interpreting momenta as p-adic valued momenta. If the momenta are rationals not divisible by any non-trivial power of p the canonical identification maps the momenta to themselves. If momenta are small rationals this certainly makes sense but does so also more generally.
2. The converging p-adic valued perturbation series is mapped to real numbers using the generalization of the canonical identification appearing in quantum arithmetics [15]. The basic rule is simple: replace powers of p with their inverses everywhere. The coefficients of powers of p are however allowed to be rationals for which neither numerator or denominator is divisible by p . This modification affects the predictions of p-adic mass calculations only in a negligible manner.
3. p-Adic-real duality has an interpretation in terms of cognition having p-adic physics as a correlat: it maps the physical system in long length scale to short length scales or vice versa and the image of the system assigning to physical object thought about it or vice versa provides a faithful representation. Same interpretation could explain also the successful p-adic mass calculations. It must be emphasized that real partonic 2-surfaces would obey effective p-adic topology and this would be due to the large number of common points shared by real and p-adic partonic 2-surfaces. Common points would be rational points in the simplest picture: in quantum arithmetics they would be replaced by quantum rationals.

p-Adic-real correspondence generalizes the canonical identification used to map the p-adic valued mass squared predicted by p-adic thermodynamics as the analog of thermal energy to a real number. An important implication is that *p-adic mass squared value is additive* [9].

1. For instance, for mesons consisting of pairs of quark and its antiquark the values of p-adic mass squared for quark and antiquark are additive and this sum is mapped to a real number: this kind of additivity was observed already at early days of hadron physics but there was no sensible interpretation for it. In TGD framework additivity of the scaling generator of Virasoro algebra is in question completely analogous to the additivity of energy.
2. For mesons consisting of quarks labelled by different value of p-adic prime p , one cannot sum mass squared values since they belong to different number fields. One must map both of them first to real numbers and after this sum real mass values (rather than mass squared values).

This picture generalizes. Only p-adic valued amplitudes belonging to same p-adic number field and therefore corresponding to the same p-adic length scales can be summed. There is no interference between amplitudes corresponding to different p-adic scales.

1. This could allow to understand at deeper level the somewhat mysterious and ad hoc assumption of jet QCD that the strong interactions in long scales and short scales factorize at the level of probabilities. Typically the reaction rate is expressible using products of probabilities. The probability for pulling out quarks from colliding protons (non-perturbative QCD), the probability describing parton level particle reaction (perturbative QCD), and the probability that the scattering quarks fragment to the final state hadrons (non-perturbative QCD). Ordinary QCD would suggest the analog of this formula but with probability amplitudes replacing probabilities and in order to obtain a probabilistic description one must assume that various interference terms sum up to zero (decoherence). p-Adic-real duality would predict the relative decoherence of different scales as an exact result. p-adic length scale hypothesis would also allow to define the notion of scale precisely. From the stance provided by TGD it seems quite possible that the standard belief that jet QCD follows from QCD is simply wrong. The repeated emphasis of this belief is of course part of the liturgy: it would be suicidal for a specialist of jet QCD to publicly conjecture that jet QCD is more than QCD.
2. The number theoretical decoherence would be very general and could explain the somewhat mysterious decoherence phenomenon. Decoherence could have as a number theoretical correlate the decomposition of space-time surfaces to regions characterized by different values of p-adic primes. In given region the amplitudes would be constructed as p-adic valued amplitudes and then mapped to real amplitudes by canonical identification. A space-time region characterized by given p would be the number theoretical counterpart of the coherence region. The regions with different value of p would behave classically with respect to each other and region with given p could understand what happens in regions with different values of p using classical probability. This would also resolve paradoxes like whether the Moon is there when no-one is looking. It could also mean that the anticommutative statistics for fermions holds true only for fermionic oscillator operators associated with a space-time region with given value of p-adic prime p . Somewhat ironically, p-adic physics would bring quantum reality much nearer to the classical reality.

3.2 Logarithmic corrections to cross sections and jets

Even in the perturbative regime exclusive cross sections for parton-parton scattering contain large logarithmic corrections of form $\log(Q^2/\mu^2)$ [2], where Q is cm energy and μ is mass scale which could be assigned to quark or - perhaps more naturally - to jet. These corrections spoil the convergence of the perturbative expansion at $Q^2 \rightarrow \infty$ limit. One can also say that the cross sections are singular at the limit of vanishing quark mass: this is the basic problem of the twistor approach.

For "infra-red safe" cross sections the logarithmic singularities can be eliminated by summing over all initial and final states not distinguishable from each other in the energy and angle resolutions available. It is indeed impossible to distinguish between quark and quark and almost collinear soft gluon and one must therefore sum over all final states containing soft gluons. A simple example about IR safe cross section is the cross section for e^+e^- annihilation to hadrons in finite measurement resolution, from which logarithms $\log(Q/\mu)$ disappear.

In hadronic reactions jets are studied instead of hadrons. IR safety is one criterion for what it is to be a jet. Jet can be imagined to result as a cascade. Parton annihilates to a pair of partons,

resulting partons annihilate into softer partons, and so on... The outcome is a cascade of increasingly softer partons. The experimental definition of jet is constrained by a finite measurement resolution for energy and angle, and jet is parameterized by the cm energy Q , by the energy resolution ϵ , and by the jet opening angle δ : apart from a fraction ϵ all cm energy Q of the jet is contained within a cone with opening angle δ . According to the estimate [2] the mass scale of the jet resulting at the k :th step of the cascade is roughly $\delta^k Q$.

What could be the counterpart for this description of jets in TGD framework?

1. Jet should be a structure with a vanishing total Kähler magnetic charge bound by flux tubes to a connected hadron like structure. By hadron-parton duality gluon emission from quark has interpretation as a meson emission from hadron: jets could be also interpreted as collections of hadrons at different space-time sheets. Reconnection process could play a key role in the decay of jet to hadrons. p-Adic length scale hypothesis suggests the interpretation of jets as hadron like objects which are off mass shell in the sense that the p-adic prime $p \simeq 2^k$ characterizing the jet space-time sheets is smaller than M_{107} characterizing the final state hadrons. One could say that jets represent p-adically hot hadron-like objects which cool and decay to hadrons. If so, the transition from M_{107} hadron physics to M_{89} hadron physics could be rather smooth. The only new thing would be the abnormally long lifetime of M_{89} hadrons formed as intermediate states in the process.
2. p-Adic length scale hypothesis suggests that the p-adic length scale assignable to the parton (hadron like object) at the $k + 1$:th step is by power of $\sqrt{2}$ longer than that associated with k :th step: $p \rightarrow p_{next} \simeq 2 \times p$ is the simplest possibility. The naive formula $Q(k+1) \sim \delta \times Q(k)$ would probably require a generalization to $Q(k+1) \sim 2^{-r/2} \times Q(k)$, r integer with $\delta = 2^{-nr/2} \times 2\pi$, n an integer. $r = 1$ would be the simplest option. The cascade at the level of jet space-time sheets would stop when the p-adic length scale corresponds to M_{107} , which corresponds to .5 GeV mass scale. At the level of quarks one can imagine a similar cascade stopping at p-adic length scales corresponding to the mass scale about 5 MeV for u and d quarks.
3. Zero energy ontology brings in natural IR cutoffs since also gluons have small mass. Final and initial state quarks could emit only a finite number of gluons as brehmstrahlung and soft gluons could not produce IR divergences.
4. The notion of finite measurement resolution in QCD involves the cone opening angle δ and energy resolution characterized by ϵ . In TGD framework the notion of finite measurement resolution is fundamental and among other things implies the description in terms of braids. Could TGD simplify the QCD description for finite measurement resolution? Discretization in the space of momentum directions is what comes in mind first and is strongly suggested also by the number theoretical vision. One would not perform integral over the cone but sum over all events producing quark and a finite number of collinear gluons with an upper bound form them deducible from cm energy and gluon mass. For massive gluons the number of amplitudes to be summed should be finite and the jet cascade would have only finite number of steps.

Could number theoretical constraints allow additional insights? Are the logarithmic singularities present in the p-adic approach at all? Are they consistent with the number theoretical constraints?

1. The p-adic amplitudes might well involve only rational functions and thus be free of logarithmic singularities resulting from the loop integrals which are dramatically simplified in zero energy ontology by on mass shell conditions for massless partonic 2-surfaces at internal lines.
2. For the sheer curiosity one can consider the brehmstrahlung from a quark characterized by p-adic prime p . Do the logarithms $\log((Q^2/\mu^2))$, where μ^2 is naturally p-adic mass scale, make sense p-adically? This is the case of one has $Q^2/\mu^2 = (1 + O(p))$. The logarithm would be of form $O(p)$ and p-adically very small. Also its real counterpart obtained by canonical identification would be very small for $O(p) = np$, $n \ll p$. For $Q^2/\mu^2 = m(1 + O(p))$, m integer, one must introduce an extension of p-adic numbers guaranteeing that $\log(m)$ exists for $1 < m < p$. Only single logarithm $\log(a)$ and its powers are needed since for primitive roots a of unity one as $m = a^n \pmod p$ for some n . Since the powers of $\log(a)$ are algebraically independent, the extension is infinite-dimensional and therefore can be questioned.

3. For the original form of the canonical identification one would have $O(p) = np$. In the real sense the value of Q^2 would be gigantic for $p = M_{107}$ (say). p-Adically Q^2 would be extremely near to μ^2 . The modified form of canonical identification replaces binary expansion $x = \sum x_n p^n$, $0 \leq x_n < p$, of the p-adic integer with the quantum rational $q = \sum q_n p^n$, where q_n are quantum rationals, which are algebraic numbers involving only the quantum phase $e^{i2\pi/p}$ and are not divisible by any power of p [15].

This would allow physically sensible values for $Q^2/mu^2 = 1 + qp + ..$ in the real sense for arbitrarily large values of p-adic prime. In the canonical identification they would be mapped to $Q^2/mu^2 = 1 + q/p + ..$ appearing in the scattering amplitude. For q/p near unity logarithmic corrections could be sizable. If qp is of order unity as one might expect, the corrections are of order q/p and completely negligible. Even at the limit $Q^2 \rightarrow \infty$ understood in the real sense the logarithmic corrections would be always negligible if Q^2 is p-adic quantum rational. Similar extremely rapid convergence characterizes p-adic thermodynamics [6] and makes the calculations practically exact. Smallness of logarithmic corrections quite generally could thus distinguish between QCD and TGD.

4. In p-adic thermodynamics the p-adic mass squared defined as a thermal average of conformal weight is a ratio of two quantities infinite as real numbers. Even when finite cutoff of conformal weight is introduced one obtains a ratio of two gigantic real numbers. The limit taking cutoff for conformal weight to infinity does not exist in real sense. Does same true for scattering amplitudes? Quantum arithmetics would guarantee that canonical identification respects discretized symmetries natural for a finite measurement resolution.

3.3 p-Adic length scale hypothesis and hadrons

Also p-adic length scale hypothesis distinguishes between QCD and TGD. The basic predictions are scaled variants of quarks and the TGD variant of Gell-Mann Okubo mass formula indeed assumes that in light hadrons quarks can appear in several p-adic mass scales. One can also imagine the possibility that quarks can have short lived excitations with non-standard p-adic mass scale. The model for tau-pion needed to explain the 3-year old CDF anomaly for which additional support emerged recently, assumes that color octet version of tau lepton appears as three different mass scales coming as octaves of the basic mass scale [13]. Similar model has been applied to explain also some other anomalies.

M_{89} hadron physics corresponds to a p-adic mass scale in TeV range [7]: the proton of M_{89} hadron physics would have mass near 500 GeV if naive scaling holds true. The findings from Tevatron and LHC have provided support for the existence of M_{89} mesons and the bumps usually seen as evidence for Higgs would correspond to the mesons of M_{89} hadron physics. It is a matter of time to settle whether M_{89} hadron physics is there or not.

4 Magnetic flux tubes and and strong interactions

Color magnetic flux tubes carrying Kähler magnetic monopole flux define the key element of quantum TGD and allow precise formulation for the non-perturbative aspects of strong interaction physics.

4.1 Magnetic flux tube in TGD

The following examples should make clear that magnetic flux tubes are the central theme of entire TGD present in all scales.

1. Color magnetic flux tubes are the key element of hadron physics according to TGD and will be discussed in more detail below.
2. In TGD Universe atomic nucleus is modelled as nuclear string with nucleons connected by color magnetic flux tubes which have length of order Compton length of u and d quark [12, 8]. One of the basic predictions is that the color flux tubes can be also charged. This predicts a spectrum of exotic nuclei. The energy scale of these states could be small and measured using keV as a natural unit. These exotic states with non-standard value of Planck constant giving to the flux tubes the size of the atom and the scaling up electroweak scale to atomic scale could explain cold fusion for which empirical support is accumulating.

3. Magnetic flux tubes are also an essential element in the model of high T_c super conductivity. The transition to super-conductivity in macroscopic scale would be a percolation type process in which shorter flux tubes would combine at critical point to form long flux tubes so that the supra currents could flow over macroscopic distances [2]. The basic prediction is that there are two critical temperatures. Below the first one the super-conductivity is possible for "short" flux tubes and at lower critical temperature the "short" flux tubes fuse to form long flux tubes. Two critical temperatures have been indeed observed.
4. Magnetic flux tubes carrying dark matter are the corner stone of TGD inspired quantum biology, where the notion of magnetic body is in a central role. For instance, the vision about DNA as topological quantum computer is based on the braiding of flux tubes connecting DNA nucleotides and the lipids of nuclear or cellular membrane [3].
5. In the very early TGD inspired cosmology [11] string like objects with 2-D M^4 projection are the basic objects. Cosmic evolution means gradual thickening of their M^4 projection and flux conservation means that the flux weakens. If the lengths of the flux tubes increase correspondingly, magnetic energy is conserved. Local phase transitions increasing Planck constant locally can occur and led to a thickening of the flux tube and liberation of magnetic energy as radiation which later gives rise to radiation and matter. This mechanism replaces the decay of the energy of inflation field to radiation as a mechanism giving rise to stars and galaxies [10]. The magnetic tension is responsible for the negative pressures explaining accelerated expansion and magnetic energy has identification as the dark energy.

4.2 Reconnection of color magnetic flux tubes and non-perturbative aspects of strong interactions

The reconnection of color magnetic flux tubes is the key mechanism of hadronization and a slow process as compared to quark gluon emission.

1. Reconnection vertices have interpretation in terms of stringy vertices $AB + CD \rightarrow AD + BC$ for which interiors of strings serving as representatives of flux tubes touch. The first guess is that reconnection is responsible for the low energy dynamics of hadronic collisions.
2. Reconnection process takes place for both the hadronic color magnetic flux tubes and those of quarks and gluons. For ordinary hadron physics hadrons are characterized by Mersenne prime M_{107} . For M_{89} hadron physics reconnection process takes place in much shorter scales for hadronic flux tubes.
3. Each quarks is characterized by a p-adic length scale: this scale characterizes the length scale of the magnetic bodies of the quark. Therefore reconnection at the level of the magnetic bodies of quarks take places in several time and length scales. For top quark the size scale of magnetic body is very small as is also the reconnection time scale. In the case of u and d quarks with mass in MeV range the size scale of the magnetic body would be of the order of electron Compton length. This scale assigned with quark is longer than the size scale of hadrons characterized by M_{89} . Classically this does not make sense but in quantum theory Uncertainty Principle predicts it from the smallness of the light quark masses as compared to the hadron mass. The large size of the color magnetic body of quark could explain the strange finding about the charge radius of proton [7].
4. Reconnection process in the beginning of proton-proton collision would give rise to the formation of jets identified as big hadron like entities connected to single structure by color magnetic flux tubes. The decay of jets to hadrons would be also reconnection process but in opposite time direction and would generate the hadrons in the final state (negative energy part of the zero energy state). The short scale process would be the process in which partons scatter from each other and produce partons. These processes would have a dual description in terms of hadronic reactions.
5. Factorization theorems are the corner stone of jet QCD. They are not theorems in the mathematical sense of the word and one can quite well ask whether they really follow from QCD

or whether they represent correct physical intuitions transcending the too rigid framework provided by QCD as a gauge theory. Reconnection process would obviously represent the slow non-perturbative aspects of QCD and occur both for the flux tubes associated with quarks and those assignable to hadrons. Several scales would be present in case of quarks corresponding to p-adic length scales assigned to quarks which even in light hadrons would depend on hadron [9]. The hadronic p-adic length scale would correspond to Mersenne prime M_{107} . One of the basic predictions of TGD is the existence of M_{89} hadron physics and there are several indications that LHC has already observed mesons of this hadron physics. p-Adic-real duality would provide a further mathematical justification for the factorization theorems as a consequence of the fact that interference between amplitudes belong to different p-adic number fields is not possible.

Reconnection process is not present in QCD although it reduces to string re-connection in the approximation that partonic 2-surfaces are replaced by braids. An interesting signature of 4-D string-yness is the knotting of the color flux tubes possible only because the strings reside in 4-D space-time. This braiding and knotting could give rise to effects not predicted by QCD or at least its description using AdS/CFT strings. The knotting and linking of color flux tubes could give rise to exotic topological effects in nuclear physics if nuclei are nuclear strings.

4.3 Quark gluon plasma

A detailed qualitative view about quark-gluon plasma in TGD Universe can be found from [14].

1. The formation of quark gluon plasma would involve a reconnection process for the magnetic bodies of colliding protons or nuclei in short time scale due to the Lorentz contraction of nuclei in the direction of the collision axis. Quark-gluon plasma would correspond to a situation in which the magnetic fluxes are distributed in such a manner that the system cannot be decomposed to hadrons anymore but acts like a single coherent unit. Therefore quark-gluon plasma in TGD sense does not correspond to the thermal quark-gluon plasma in the naive QCD sense in which there are no long range correlations. Ideal quark gluon plasma is like single very large hadron rather than a gas of partons bound to single unit by the conservation of magnetic fluxes connecting the quarks and antiquarks.
2. Long range correlations and quantum coherence suggest that the viscosity to entropy ratio is low as indeed observed [7]. The earlier arguments suggest that the preferred extremals of Kähler action have interpretation as perfect fluid flows [5]. This means at given space-time sheet allows global time coordinate assignable to flow lines of the flow and defined by conserved isometry current defining Beltrami flow. As a matter fact, all conserved currents are predicted to define Beltrami flows. Classically perfect fluid flow implies that viscosity, which is basically due to a mixing causing the loss of Beltrami property, vanishes. Viscosity would be only due to the finite size of space-time sheets and the radiative corrections describable in terms of fractal hierarchy CDs within CDs. In quantum field theory radiative corrections indeed give rise to the absorptive parts of the scattering amplitudes. In the case of quark gluon plasma viscosity is very large although the viscosity to entropy ratio is near to its minimum $\eta/s = \hbar/4\pi$ predicted by AdS/CFT correspondence. In TGD framework the lower bound is smaller [14].
3. There are good motivations for challenging the belief that QCD predicts strongly interacting quark gluon plasma having very large viscosity begin more like glass than a gas of partons. The reason for the skepticism is that classical color magnetic fields carrying magnetic monopole charges are absent. Also the notion of many-sheeted space-time is essential element of the description. The recent evidence for the failure of AdS/CFT correspondence in the description of jet fragmentation in plasma support the pessimistic views.

4.4 Super-symmetry and hadron physics

So called X and Y bosons are mysterious creatures having no obvious place in the quark model. They seem to consist of charmed quarks but they decay systematics suggest that something differentiates between these quarks and charmed quarks in the ordinary charmonium states. The TGD proposal [7] is that the super-partners of quarks have same the p-adic mass scale and even mass as quarks. There

would be however a mixing between mesons and smesons and for light mesons this mixing would be very large making the second eigen state of mass squared matrix tachyonic and kicking it out of spectrum so that light mesons would be strong mixtures of mesons and smesons. For heavier quarks such as c the mixing would not be so large since color couplings strength would be reasonably small and one would obtain both mesons and smesons. The prediction is that also the mesons consisting of $b\bar{b}$ pair would have smeson counterparts.

A further obvious objection is that intermediate gauge boson decay widths exclude light fermions. TGD based view about dark matter as ordinary particles with non-standard value of Planck constant and the fact that particles with different values of Planck constant cannot appear in the same vertex, allows to circumvent this objection. The superpartners would correspond to non-standard value of Planck constant.

Same picture about squarks would apply to M_{89} hadron physics and the failure to detect spartners at LHC would be the use of wrong signatures. Shadronization would be much faster process than the decay of squarks to quarks and electro-weak gauge bosons and missing energy so that these events would not be observed. Shadrons would in turn decay to hadrons by gluino exchanges.

This looks nice but there are objections.

1. The first objection relates to the tachyonicity. Mesons and smesons consisting of squark pair mix and for large α_s the mixing is large and can indeed make second eigenvalue of the mass squared matrix negative. If so, these states disappears from spectrum. At least to me this looks however somewhat unaesthetic.

Luckily, the transformation of second pion-like state to tachyon and disappearance from spectrum is not the only possibility. After a painful search I found experimental work [1] claiming the existence of states analogous to ordinary pion with masses 60, 80, 100, 140,.... MeV. 100 GeV is first downwards half-octave of pion with mass about 140 MeV and also second half octave is there. Could it be that one of these states is spion predicted by TGD SUSY for ordinary hadrons? (But what about other states? They are not spartners: what are they?)

2. The second objection relates to the missing energy. SUSY signatures involving missing energy have not been observed at LHC. This excludes standard SUSY candidates and could do the same in the case of TGD. In TGD framework the missing energy would be eventually right handed neutrinos resulting from the decays of sfermions to fermion and sneutrino in turn decaying to neutrino and right handed neutrino. The above naive argument says that strong interactions are faster than weak decays of squarks to quark and spartner of weak boson whose decay would produce the usual signatures of SUSY so that shadronization would take place instead of production of the SUSY signatures. The problem with this argument is that the weak decays of squarks producing right handed neutrinos as missing energy are still there!

This objection forces to consider the possibility that covariantly constant right handed neutrino which generates SUSY is replaced with a color octet. Color excitations of leptons of lepto-hadron hypothesis would be sleptons which are color octets so that SUSY for leptons would have been seen already at seventies in the case of electron. The whole picture would be nicely unified. Sleptons and squark states would contain color octet right handed neutrino the same wormhole throats as their em charge resides. In the case of squarks the tensor product $3 \otimes 8 = 3 + \bar{6} + 15$ would give several colored exotics. Triplet squark would be like ordinary quark with respect to color.

Covariantly constant right-handed neutrino as such would represent pure gauge symmetry, a super-generator annihilating the physical states. Something very similar can occur in the reduction of ordinary SUSY algebra to sub-algebra familiar in string model context. By color confinement missing energy realized as a color octet right handed neutrino could not be produced and one could overcome the basic objections against SUSY by LHC.

This is view about TDG SUSY is just one possibility. The situation is not completely settled and one must keep mind open.

4.5 Exotic pion like states: "infra-red" Regge trajectories or Shnoll effect?

The experimental claim is that pion is accompanied by pion like states with mass 60, 80, 100, 140, 181, 198, 215, 227.5, and 235 MeV means that besides spion also other pion like states should be there.

Similar satellites have been observed for nucleons with ground state mass 934 MeV: the masses of the satellites are 1004, 1044, 1094 MeV. Also the signal cross sections for Higgs to gamma pairs at LHC suggest the existence of several pion and spion like states, and this was the reason why I decided to to again the search for data about this kind of states (I remembered vaguely that Tommaso Dorigo had talked about them but I failed to find the posting). What is their interpretation? One can imagine two explanations which could be also equivalent.

1. The states could be "infrared" Regge trajectories assignable to magnetic flux tubes of order Compton length of u and d quark (very long and with small string tension) could be the explanation. Hadron mass spectrum would have microstructure. This is something very natural in many-sheeted space-time with the predicted p-adic fractal hierarchy of physics. This conforms with the proposal that all baryons have the satellite states and that they correspond to stringy excitations of magnetic flux tubes assignable to quarks. Similar fine structure for nuclei is predicted for nuclei in nuclear string model [8]. In fact, the first excited state for ${}^4\text{He}$ has energy equal to 20 MeV not far from the average energy difference 17.5 MeV for the excited states of pion with energies 198, 215, and 227.5 MeV so that this state might correspond to an excitation of a color magnetic flux tube connecting two nucleons.

Needless to say, the existence of the exotic hadrons would kill QCD as a theory of strong interactions and provide a strong support for the notion of color magnetic flux tube central for TGD vision about hadrons.

2. The p-adic model for Shnoll effect [1] relies on universal modification of the notion of probability distribution based on the replacement of ordinary arithmetics with quantum arithmetics. Both the rational valued parameters characterizing the distribution and the integer or rational valued arguments of the distribution are replaced with quantum rationals. Quantum arithmetics is characterized by quantum phase $q = \exp(i2\pi/p)$ defined by the p-adic prime p . The primes in the decomposition of integer are replaced with quantum primes except p which remains as such. In canonical identification powers of p are mapped to their inverses. Quite generally, distributions with single peak are replaced with many peaked ones with sub-peak structure having number theoretic origin. A good example is Poisson distribution for which one has $P(n) = \lambda^n/n!$. The quantum Poisson distribution is obtained by replacing λ and $n!$ with their quantum counterparts. Quantum Poisson distribution could apply in the case of resonance bump for which the number of count in a given mass squared interval is integer valued variable.

There are objections against Shnoll effect based explanation.

- (a) If the p-adic prime assignable to quark or hadron characterizes quantum arithmetics it is not distinguishable from ordinary arithmetics since the integers involved are certainly much smaller than say $M_{107} = 2^{107} - 1$. In the case of nuclear physics Shnoll effect involves small primes so that this argument is not water tight. For instance, if $p = 107$ defines the quantum arithmetics, the effects would be visible in good enough resolution and one might even expect variations in the bump structure in the time scale of year.
- (b) The effect is present also for nucleons but the idea about a state with large width splitting into narrower bumps does not fit nicely with the stability of proton.

For Higgs like signals IR-Regge trajectories/Shnoll effect would be visible as a splitting of wide bumps for spion and pion of M_{89} physics to sub-bumps. This oscillatory bumpy structure is certainly there but is regarded as a statistical artifact. It would be really fascinating to see this quantum deformation of the basic arithmetics at work even in elementary particle physics.

The prediction of the additional pion-like states is one of the predictions of TGD about hadron physics at low energies and one of the first tasks is to look quantitatively possible realizations of Shnoll effect in the case of resonances.

5 Higgs or M_{89} hadron physics?

The newest results about Higgs search using 4.9/fb of data were published yesterday and there are many articles in arXiv. The overall view is that there is evidence for something around 125 GeV. .

The evidence comes basically from what might be interpreted as decays of Higgs to $\gamma\gamma$. There are some ZZ and WW events. CMS represented also data for more rare events including also b quark pairs and tau lepton pairs. There are also indications about something at higher masses and the interpretation of them depends on the belief system of the theoretician.

In TGD framework Higgs like states seem to be un-necessary. Zero energy ontology predicts that all states with spin 1 are massive and the third polarization state is allowed by the generalization of the gauge condition excluding the third polarization in the case of massless states [14]. If one assumes Higgs like states, the particles which become massive "eat" all of them. Also photon, gluon, and graviton become massive and the small mass allows to get rid of infrared divergences plaguing gauge theories.

The basic question is whether the data could be interpreted as signatures of Higgs or of M_{89} hadron physics. This question is discussed in detail in [7]. Here I represent just the main arguments.

1. The basic observation is that the generalization of PCAC hypothesis leads to very similar predictions for the direct couplings of pseudo-scalar mesons as Higgs has and the decay rates are of the same form. The generalization of the hadronic sigma model with vacuum expectation value of sigma field replacing that of Higgs field makes it easy to understand the close resemblance but does not seem to be absolutely necessary unless one wants additional predictions. What is remarkable that the vacuum expectation of sigma field equals apart from sign to W boson mass.
2. If one believes in the indications about structures at higher masses than 125 GeV, one must conclude that standard Higgs hypothesis fails. M_{89} hadron physics might be able to explain these structures but the coupling X defined by $f_\pi = Xm_\pi$ would be smaller for these higher pion-like states. One of them would be around 139 GeV.
3. TGD suggests that the spartners of quarks correspond to the same mass scale as quarks. The pion-like states with masses 139 GeV and 125 GeV would correspond to pion and spion (pair of squarks) which could have suffered mixing by exchange of gluino. The original proposal that spartners are generated by covariantly constant right-handed neutrino and antineutrino has the problem that it might produce just the same missing energy signatures of SUSY as ordinary SUSY and thus be excluded experimentally.

The simplest way out is the assumption that covariantly constant neutrino generates gauge supersymmetry and thus creates zero norm states. It would be color octet state of neutrino that would generate the dynamical supersymmetry and states with a non-vanishing norm. Color confinement would not allow the usual missing energy signature so that everything would be consistent with what we have learned from LHC. Lepto-hadrons [13] would consist of pairs of sleptons which would be color octets so that same picture would apply to both leptons and quarks.

4. This is however not quite enough. There is evidence for a bumpy structure of signal cross section. The easy explanation is in terms of statistical fluctuations and time will show whether this explanation works. The bumpy structure suggests the existence of additional states not explainable in terms of the doubling predicted by TGD SUSY.

Rather remarkably, the already mentioned quite recent anomaly suggests that similar phenomenon is encountered also in ordinary hadron physics. According to a three-year old discovery [1], there is evidence for narrow pion-like and nucleon like states with a mass splitting which is of order few tens of MeV. p-Adic fractality predicts the same in the case of M_{89} hadron physics and the observed bumpy structure might have interpretation in terms of "infra-red" Regge trajectory with string tension assignable to the color magnetic flux tubes accompanying light quarks. This string tension is dramatically smaller than the hadronic string tension of order 1 GeV and measured using 10 MeV as a unit.

Needless to say, the existence of the exotic hadrons would kill QCD as a theory of strong interactions and provide a strong support for the notion of color magnetic flux tube central for TGD vision about hadrons.

An alternative explanation would be rely on Shnoll effect [1] implying the splitting of resonances to separate peaks. It is not clear whether the explanations exclude each other. The question

"Higgs of M_{89} hadron physics or something else?" will be probably answered within a year as the statistics from LHC improves.

Books related to TGD

- [1] M. Pitkänen. A Possible Explanation of Shnoll Effect. In *p-Adic Length Scale Hypothesis and Dark Matter Hierarchy*. Onlinebook. http://tgd.wippiespace.com/public_html/paddark/paddark.html#ShnollTGD, 2006.
- [2] M. Pitkänen. Bio-Systems as Super-Conductors: part I. In *Quantum Hardware of Living Matter*. Onlinebook. http://tgd.wippiespace.com/public_html/bioware/bioware.html#superc1, 2006.
- [3] M. Pitkänen. DNA as Topological Quantum Computer. In *Genes and Memes*. Onlinebook. http://tgd.wippiespace.com/public_html/genememe/genememe.html#dnatqc, 2006.
- [4] M. Pitkänen. Does TGD Predict the Spectrum of Planck Constants? In *Towards M-Matrix*. Onlinebook. http://tgd.wippiespace.com/public_html/tgdquant/tgdquant.html#Planck, 2006.
- [5] M. Pitkänen. Does the Modified Dirac Equation Define the Fundamental Action Principle? In *Quantum Physics as Infinite-Dimensional Geometry*. Onlinebook. http://tgd.wippiespace.com/public_html/tgdgeom/tgdgeom.html#Dirac, 2006.
- [6] M. Pitkänen. Massless states and particle massivation. In *p-Adic Length Scale Hypothesis and Dark Matter Hierarchy*. Onlinebook. http://tgd.wippiespace.com/public_html/paddark/paddark.html#mless, 2006.
- [7] M. Pitkänen. New Particle Physics Predicted by TGD: Part I. In *p-Adic Length Scale Hypothesis and Dark Matter Hierarchy*. Onlinebook. http://tgd.wippiespace.com/public_html/paddark/paddark.html#mass4, 2006.
- [8] M. Pitkänen. Nuclear String Hypothesis. In *p-Adic Length Scale Hypothesis and Dark Matter Hierarchy*. Onlinebook. http://tgd.wippiespace.com/public_html/paddark/paddark.html#nuclstring, 2006.
- [9] M. Pitkänen. p-Adic Particle Massivation: Hadron Masses. In *p-Adic Length Scale Hypothesis and Dark Matter Hierarchy*. Onlinebook. http://tgd.wippiespace.com/public_html/paddark/paddark.html#mass3, 2006.
- [10] M. Pitkänen. TGD and Astrophysics. In *Physics in Many-Sheeted Space-Time*. Onlinebook. http://tgd.wippiespace.com/public_html/tgdclass/tgdclass.html#astro, 2006.
- [11] M. Pitkänen. TGD and Cosmology. In *Physics in Many-Sheeted Space-Time*. Onlinebook. http://tgd.wippiespace.com/public_html/tgdclass/tgdclass.html#cosmo, 2006.
- [12] M. Pitkänen. TGD and Nuclear Physics. In *p-Adic Length Scale Hypothesis and Dark Matter Hierarchy*. Onlinebook. http://tgd.wippiespace.com/public_html/paddark/paddark.html#padnucl, 2006.
- [13] M. Pitkänen. The Recent Status of Lepto-hadron Hypothesis. In *p-Adic Length Scale Hypothesis and Dark Matter Hierarchy*. Onlinebook. http://tgd.wippiespace.com/public_html/paddark/paddark.html#leptc, 2006.
- [14] M. Pitkänen. Generalized Feynman Diagrams as Generalized Braids. In *Towards M-Matrix*. Onlinebook. http://tgd.wippiespace.com/public_html/tgdquant/tgdquant.html#braidfeynman, 2011.
- [15] M. Pitkänen. Quantum Arithmetics and the Relationship between Real and p-Adic Physics. In *TGD as a Generalized Number Theory*. Onlinebook. http://tgd.wippiespace.com/public_html/tgdnumber/tgdnumber.html#qarithmetics, 2011.

Particle and Nuclear Physics

- [1] E. Tomasi-Gustafsson B. Tatischeff. Search for low-mass exotic mesonic structures: II. Attempts to understand the experimental results. *Part. Nucl. Lett.*, 5(5):709–713, 2008.
- [2] P. Hoyer. Jet Analysis. *Acta Physica Polonica*, B11(2):133–165, 1980.
- [3] D. E. Soper J. Collins and G. Sterman. Factorization of Hard Processes in QCD. <http://arxiv.org/abs/hep-ph/0409313>, 2004.
- [4] M. Schwartz. The Emergence of Jets at the Large Hadron Collider. http://media.physics.harvard.edu/video/?id=COLLOQ_SCHWARTZ_101711, 2011.
- [5] D. T. Son. Viscosity, Quark Gluon Plasma, and String Theory. http://media.physics.harvard.edu/video/?id=LOEB_SON_041811, 2011.
- [6] I. Stewart. Mastering Jets: New Windows into the Strong Interaction and Beyond. .

Quantum Arithmetics and the Relationship between Real and p-Adic Physics

M. Pitkänen

Email: matpitka@luukku.com.

http://tgd.wippiespace.com/public_html/.

December 12, 2011

Abstract

This chapter suggests answers to the basic questions of the p-adicization program, which are following.

1. Is there a duality between real and p-adic physics? What is its precise mathematic formulation? In particular, what is the concrete map p-adic physics in long scales (in real sense) to real physics in short scales? Can one find a rigorous mathematical formulation of canonical identification induced by the map $p \rightarrow 1/p$ in pinary expansion of p-adic number such that it is both continuous and respects symmetries.
2. What is the origin of the p-adic length scale hypothesis suggesting that primes near power of two are physically preferred? Why Mersenne primes are especially important?

The answer to these questions proposed in this chapter relies on the following ideas inspired by the model of Shnoll effect. The first piece of the puzzle is the notion of quantum arithmetics formulated in non-rigorous manner already in the model of Shnoll effect.

1. Quantum arithmetics is induced by the map of primes to quantum primes by the standard formula. Quantum integer is obtained by mapping the primes in the prime decomposition of integer to quantum primes. Quantum sum is induced by the ordinary sum by requiring that also sum commutes with the quantization.
2. The construction is especially interesting if the integer defining the quantum phase is prime. One can introduce the notion of quantum rational defined as series in powers of the preferred prime defining quantum phase. The coefficients of the series are quantum rationals for which neither numerator and denominator is divisible by the preferred prime.
3. p-Adic-real duality can be identified as the analog of canonical identification induced by the map $p \rightarrow 1/p$ in the pinary expansion of quantum rational. This maps maps p-adic and real physics to each other and real long distances to short ones and vice versa. This map is especially interesting as a map defining cognitive representations.

Quantum arithmetics inspires the notion of quantum matrix group as counterpart of quantum group for which matrix elements are ordinary numbers. Quantum classical correspondence and the notion of finite measurement resolution realized at classical level in terms of discretization suggest that these two views about quantum groups are closely related. The preferred prime p defining the quantum matrix group is identified as p-adic prime and canonical identification $p \rightarrow 1/p$ is group homomorphism so that symmetries are respected.

1. The quantum counterparts of special linear groups $SL(n, F)$ exists always. For the covering group $SL(2, C)$ of $SO(3, 1)$ this is the case so that 4-dimensional Minkowski space is in a very special position. For orthogonal, unitary, and orthogonal groups the quantum counterpart exists only if quantum arithmetics is characterized by a prime rather than general integer and when the number of powers of p for the generating elements of the quantum matrix group satisfies an upper bound characterizing the matrix group.
2. For the quantum counterparts of $SO(3)$ ($SU(2)/SU(3)$) the orthogonality conditions state that at least some multiples of the prime characterizing quantum arithmetics is sum of three (four/six) squares. For $SO(3)$ this condition is strongest and satisfied for all integers, which are not of form $n = 2^{2r}(8k + 7)$. The number $r_3(n)$ of representations as sum of squares is known and $r_3(n)$ is invariant under the scalings $n \rightarrow 2^{2r}n$. This means scaling by 2 for the integers appearing in the square sum representation.

3. $r_3(n)$ is proportional to the so called class number function $h(-n)$ telling how many non-equivalent decompositions algebraic integers have in the quadratic algebraic extension generated by $\sqrt{-n}$.

The findings about quantum $SO(3)$ suggest a possible explanation for p-adic length scale hypothesis and preferred p-adic primes.

1. The basic idea is that the quantum matrix group which is discrete is very large for preferred p-adic primes. If cognitive representations correspond to the representations of quantum matrix group, the representational capacity of cognitive representations is high and this kind of primes are survivors in the algebraic evolution leading to algebraic extensions with increasing dimension.
2. The preferred primes correspond to a large value of $r_3(n)$. It is enough that some of their multiples do so (the 2^{2^r} multiples of these do so automatically). Indeed, for Mersenne primes and integers one has $r_3(n) = 0$, which was in conflict with the original expectations. For integers $n = 2M_m$ however $r_3(n)$ is a local maximum at least for the small integers studied numerically.
3. The requirement that the notion of quantum integer applies also to algebraic integers in quadratic extensions of rationals requires that the preferred primes (p-adic primes) satisfy $p = 8k + 7$. Quite generally, for the integers $n = 2^{2^r}(8k + 7)$ not representable as sum of three integers the decomposition of ordinary integers to algebraic primes in the quadratic extensions defined by $\sqrt{-n}$ is unique. Therefore also the corresponding quantum algebraic integers are unique for preferred ordinary prime if it is prime also in the algebraic extension. If this were not the case two different decompositions of one and same integer would be mapped to different quantum integers. Therefore the generalization of quantum arithmetics defined by any preferred ordinary prime, which does not split to a product of algebraic primes, is well-defined for $p = 2^{2^r}(8k + 7)$.
4. This argument was for quadratic extensions but also more complex extensions defined by higher polynomials exist. The allowed extensions should allow unique decomposition of integers to algebraic primes. The prime defining the quantum arithmetics should not decompose to algebraic primes. If the algebraic evolution leads to algebraic extensions of increasing dimension it gradually selects preferred primes as survivors.

Contents

1	Introduction	4
1.1	What could be the deeper mathematics behind dualities?	5
1.2	Correspondence along common rationals and canonical identification: two manners to relate real and p-adic physics	7
1.3	Brief summary of the general vision	8
2	Quantum arithmetics and the notion of commutative quantum group	9
2.1	Quantum arithmetics	10
2.1.1	Quantum counterparts of real integers	10
2.1.2	The quantum counterparts of p-adic integers	11
2.1.3	Quantum counterpart of pinary expansion?	11
2.2	Do commutative quantum counterparts of Lie groups exist?	12
2.2.1	Quantum counterparts of special linear groups	13
2.2.2	Do classical Lie groups allow quantum counterparts?	14
2.3	Questions	16
2.3.1	How to realize p-adic-real duality at the space-time level?	16
2.3.2	How commutative quantum groups could relate to the ordinary quantum groups?	17
2.3.3	How to define quantum counterparts of coset spaces?	17
3	Could one understand p-adic length scale hypothesis number theoretically?	18
3.1	Orthogonality conditions for $SO(3)$	19
3.2	Number theoretic functions $r_k(n)$ for $k = 2, 4, 6$	20
3.2.1	The behavior of $r_2(n)$	20
3.2.2	The behavior of $r_4(n)$	20

3.2.3	The behavior of $r_6(n)$	21
3.3	What can one say about the behavior of $r_3(n)$?	21
3.3.1	Expression of $r_3(p)$ in terms of class number function	21
3.3.2	Simplified formula for $r_3(D)$	22
3.3.3	Could thermodynamical analogy help?	23
3.3.4	Expression of $r_3(p)$ in terms of Dirichlet L-function	25
3.3.5	Could preferred integers correspond to the maxima of Dirichlet L-function?	25
3.3.6	Interference as a helpful physical analogy?	26
3.3.7	Period doubling as physical analogy?	26
3.3.8	Which preferred primes could winners in the number theoretic evolution?	27
4	How quantum arithmetics affects basic TGD and TGD inspired view about life and consciousness?	28
4.1	What happens to p-adic mass calculations and quantum TGD?	28
4.2	What happens to TGD inspired theory of consciousness and quantum biology?	29
5	Appendix: Some number theoretical functions	29
5.1	Characters and symbols	30
5.1.1	Principal character	30
5.1.2	Legendre and Kronecker symbols	30
5.1.3	Dirichlet character	30
5.2	Divisor functions	31
5.3	Class number function and Dirichlet L-function	31

1 Introduction

The construction of quantum counterparts for various mathematical structures of theoretical physics have been a fashion for decades. Quantum counterparts for groups, Lie algebras, coset spaces, etc... have been proposed often on purely formal grounds. In TGD framework quantum group like structure emerges via the hyper-finite factors of type II_1 (HFFs) about which WCW spinors represent a canonical example [12]. The inclusions of HFFs provide a very attractive manner to realize mathematically the notion of finite measurement resolution.

In the following a proposal for what might be called quantum integers and quantum matrix groups is discussed. Quantum integers n_q differ from their standard variants in that the map $n \rightarrow n_q$ respects prime decomposition so that one obtains quantum number theory. Also quantum rationals belonging to algebraic extension of rationals can be defined as well as their algebraic extensions. Quantum arithmetics differs from the usual one in that quantum sum is defined in such a manner that the map $n \rightarrow n_q$ commutes also with sum besides the product: $m_q +_q n_q = (m + n)_q$. Quantum matrix groups differ from their standard counterparts in that the matrix elements are not non-commutative. The matrix multiplication involving summation over products is however replaced with quantum summation.

The proposal is that these new mathematical structures allow a more understanding of the relationship between real and p-adic physics for various values of p-adic prime p , to be called l in the sequel because of its preferred physical nature resembling that of l-adic prime in l-adic cohomology. The correspondence with the ordinary quantum groups [15] is also considered and suggested to correspond to a discretization following as a correlate of finite measurement resolution.

One can of course wonder whether and how quantum arithmetics relates to discretization and quantization- the basic themes of the book at hand. The answer is simple: finite measurement resolution has as its space-time correlate quantization and discretization and these reduce to a high extent to quantum arithmetics.

1. Number theoretic constraints form p-adicization give extremely powerful quantization conditions. For instance, in p-adic thermodynamics the notion of Boltzmann weight defined as the analog of the exponential $\exp(-E/T)$ does not make sense since p-adic exponent function exists only for $x = -E/T$ a p-adic number smaller than one. Even in this case the exponent has unit norm so that partition function for a system with infinite number of states does not converge

p-adically. In real context the replacement $\exp(-E/T) \rightarrow p^{E/T}$ is only a change of convention. In the p-adic context this representation assuming that E/T has integer valued spectrum implies that the partition function exists p-adically. Super-conformal invariance guarantees the needed integer valued spectrum for the scaling generator appearing as the counterpart of energy. Furthermore, temperature is quantized as $T = 1/n$, $n = 1, 2, \dots$. This together with the p-adic length scale hypothesis stating that physically favored primes satisfy $p \simeq 2^n$, makes p-adic mass calculations extremely predictive [5].

2. The challenge is to demonstrate mathematically p-adic length scale hypothesis. Quantum arithmetics gives a first principle argument in favor of the conjecture that Mersenne primes $M_n = 2^{n-1}$ are indeed physically preferred primes. Numerical checks are encouraging but for the physically favored very large Mersenne primes the numerical approach fails.
3. Quantum arithmetics also leads to discretized variants of Lie groups, in particular the Lorentz group of 4-D Minkowski space has a completely unique position as symplectic group $SL(2, C)$ since symplectic groups allow quantum arithmetic variants without additional conditions. One can speak of quantization of mathematical structures themselves and quantum arithmetic groups can be seen as analogs of Bohr orbits required by quantum classical correspondence. This quantization applies to all kinds of algebraic structures involving rational numbers since one can always replace rational numbers with their quantum counterparts. This has also universal implications in physics and Shnoll effect is such an implication [1]. The p-adic prime p characterizes the quantum arithmetic variant of the structure obtained in this manner so that not only physics but also mathematics is p-adicized. Therefore number theoretical universality implies an extremely general discretization and quantization mechanism.

1.1 What could be the deeper mathematics behind dualities?

Dualities certainly represent one of the great ideas of theoretical physics of the last century. The mother of all dualities might be electric-magnetic duality due to Montonen and Olive [2]. Later a proliferation, one might say even inflation, of dualities has taken place. AdS/CFT correspondence [3] is one example relating to each other perturbative QFT working in short scales and string theory working in long scales.

Also in TGD framework several dualities suggests itself. All of them seem to relate to dictotomies such as weak-strong, perturbative-non-perturbative, point like particle-string. Also number theory seems to be involved in an essential manner.

1. If $M^8 - -M^4 \times CP_2$ duality is true it is possible to regard space-times as surfaces in either M^8 or $M^4 \times CP_2$ [11]. One manner to interpret the duality would as the analog of q-p duality in wave mechanics. Surfaces in M^8 would be analogous to momentum space representation of the physical states: space-time surfaces in M^8 would represent in some sense the points for the tangent space of the "world of classical worlds" (WCW) just like tangent for a curve gives the first approximation for the curve near a given point.

The argument supporting $M^8 - -M^4 \times CP_2$ duality involves the basic facts about classical number fields - in particular octonions and their complexification - and one can understand $M^4 \times CP_2$ in terms of number theory. The analog of the color group in M^8 picture would be the isometry group $SO(4)$ of E^4 which happens to be the symmetry group of the old fashioned hadron physics. Does this mean that $M^4 \times CP_2$ corresponds to short length scales and perturbative QCD whereas M^8 would correspond to long length scales and non-perturbative approach?

2. Second duality would relate partonic 2-surfaces and string world sheets playing a key role in the recent view about preferred extremals of Kähler action [3]. Partonic 2-surfaces are magnetic monopoles and TGD counterparts of elementary particles, which in QFT approach are regarded as point like objects. The description in terms of partonic 2-surfaces forgetting that they are parts of bigger magnetically neutral structures would correspond to perturbative QFT. The description in terms of string like objects with vanishing magnetic charge is needed in longer length scales. Electroweak symmetry breaking and color confinement would be the natural applications. The essential point is that stringy description corresponds to long length scales (strong coupling) and partonic description to short length scales (weak coupling).

Number theory seems to be involved also now: string world sheets could be seen as hyper-complex 2-surfaces of space-time surface with hyper-quaternionic tangent space structure and partonic 2-surfaces as co-hyper complex 2-surfaces (normal space would be hyper-complex).

3. Space-time surface itself would decompose to hyper-quaternionic and co-hyperquaternionic regions and a duality also at this level is suggestive [1], [2]. The most natural candidates for dual space-time regions are regions with Minkowskian and Euclidian signatures of the induced metric with latter representing the generalized Feynman graphs. Minkowskian regions would correspond to non-perturbative long length scale description and Euclidian regions to perturbative short length scale description. This duality should relate closely to quantum measurement theory and realize the assumption that the outcomes of quantum measurements are always macroscopic long length scale effects. Again number theory is in a key role.

Real and p-adic physics and their unification to a coherent whole represent the basic pieces of physics as generalized number theory program.

1. p-Adic physics can mean two different things. p-Adic physics could mean a discretization of real physics relying on effective p-adic topology. p-Adic physics could also mean genuine p-adic physics at p-adic space-time sheets. Real continuity and smoothness is an enormous constraint on short distance physics. p-Adic continuity and smoothness pose similar constraints in short scales and therefore on real physics in long length scales if one accepts that real and space-time surfaces (partonic 2-surfaces for minimal option) intersect along rational points and possible common algebraics in preferred coordinates. p-Adic fractality implying short range chaos and long range correlations is the outcome. Therefore p-adic physics could allow to avoid the landscape problem of M-theory due to the fact that the IR limit is unpredictable although UV behavior is highly unique.
2. The recent argument [3] suggesting that the areas for partonic 2-surfaces and string world sheets could characterize Kähler action leads to the proposal that the large N_c expansion [1] in terms of the number of colors defining non-perturbative stringy approach to strong coupling phase of gauge theories could have interpretation in terms of the expansion in powers of $1/\sqrt{p}$, p the p-adic prime. This expansion would converge extremely rapidly since N_c would be of the order of the ratio of the secondary and primary p-adic length scales and therefore of the order of \sqrt{p} : for electron one has $p = M_{127} = 2^{127} - 1$.
3. Could there exist a duality between genuinely p-adic physics and real physics? Could the mathematics used in p-adic mass calculations- in particular canonical identification $\sum_n x_n p^n \rightarrow \sum x_n p^{-n}$ - be extended to apply to quantum TGD itself and allow to understand the non-perturbative long length scale effects in terms of short distance physics dictated by continuity and smoothness but in different number field? Could a proper generalization of the canonical identification map allow to realize concretely the real-p-adic duality?

A generalization of the canonical identification [8] and its variants is certainly needed in order to solve the problems caused by the fact that it does not respect symmetries. That the generalization might exist was suggested already by the model for Shnoll effect [1], which led to a proposal that this effect can be understood in terms of a deformation of probability distribution $f(n)$ (n non-negative integer) for random fluctuations. The deformation would replace the rational parameters characterizing the distribution with new ones obtained by mapping the parameters to new ones by using the analog of canonical identification respecting symmetries. This deformation would involve two parameters: quantum phase $q = \exp(i2\pi/m)$ and preferred prime l , which need not be independent however: $m = l$, is a highly suggestive restriction.

The idea of the model of Shnoll effect was to modify the map $n \rightarrow n_q$ in such a manner that it is consistent with the prime decomposition of ordinary integers. One could even consider the notion of quantum arithmetics requiring that the map commutes with sum. This in turn suggests the generalization of the matrix groups to what might be called quantum matrix groups. The matrix elements would not be however non-commutative but obey quantum arithmetics. These quantum groups would be labelled by prime l and the original form of the canonical identification $l \rightarrow 1/l$ defines a group homomorphism. This form of canonical identification respecting symmetries could be applied to the linear representations of these groups. This map would be both continuous and respect symmetries.

1.2 Correspondence along common rationals and canonical identification: two manners to relate real and p-adic physics

The relationship between real and p-adic physics deserves a separate discussion.

1. The first correspondence between reals and p-adics is based on the idea that rationals are common to all number fields implying that rational points are common to both real and p-adic worlds. This requires preferred coordinates. It also leads to a fusion of different number fields along rationals and common algebraics to a larger structure having a book like structure [10, 8].
 - (a) Quite generally, preferred space-time coordinates would correspond to a subset of preferred imbedding space coordinates, and the isometries of the imbedding space give rise to this kind of coordinates which are however not completely unique. This would give rise to a moduli space corresponding to different symmetry related coordinates interpreted in terms of different choices of causal diamonds (CDs).
 - (b) Cognitive representation in the rational (partly algebraic) intersection of real and p-adic worlds would necessarily select certain preferred coordinates and this would affect the physics in a delicate manner. The selection of quantization axis would be basic example of this symmetry breaking. Finite measurement resolution would in turn reduce continuous symmetries to discrete ones.
 - (c) Typically real and p-adic variants of given partonic 2-surface would have discrete and possibly finite set of rational points plus possible common algebraic points. The intersection of real and p-adic worlds would consist of discrete points. At more abstract level rational functions with rational coefficients used to define partonic 2-surfaces would correspond to common 2-surfaces in the intersection of real and p-adic WCW:s. As a matter fact, the quantum arithmetics would make most points algebraic numbers.
 - (d) The correspondence along common rationals respects symmetries but not continuity: the graph for the p-adic norm of rational point is totally discontinuous. Most non-algebraic reals and p-adics do not correspond to each other. In particular, transcendental at both sides belong to different worlds with some exceptions like e^p which exists p-adically.
2. There is however a totally different view about real–p-adic correspondence. The predictions of p-adic mass calculations are mapped to real numbers via the canonical identification applied to the p-adic value of mass squared [8, 7]. One can imagine several forms of canonical identification but this affects very little the predictions since the convergence in powers of p for the mass squared thermal expectation is extremely fast.
3. The two views are consistent if appropriately generalized canonical identification is interpreted as a concrete duality mapping short length scale physics and long length scale physics to each other. As a matter fact, I proposed for more than 15 years ago that canonical identification could be essential element of cognition mapping external world to p-adic cognitive representations realized in short length scales and vice versa. If so, then real–p-adic duality would be a cornerstone of cognition [9]. Common rational points would relate to the intentionality which is second aspect of the p-adic real correspondence: the transformation of real to p-adic surfaces in quantum jump would be the correlate for the transformation of intention to action. The realization of intention would correspond to the correspondence along rationals and common algebraics (the more common points real and p-adic surface have, the more faithful the realization of intentional action) and the generation of cognitive representations to the canonical identification.

There are however hard technical problems involved. Maybe canonical identification should be realized at the level of imbedding space at least - or even at space-time level. Canonical identification would be locally continuous in both directions. Note that for the points with finite binary expansion (ordinary integers) the map is two-valued. Note also that rationals can be expanded in infinite powers series with respect to p and one can ask whether one should do this or map $q = m/n$ to $I(m)/I(n)$ (the representation of rational is unique if m and n have no common factors).

The basic problem is that canonical identification in its basic form does not respect symmetries: the action of the p-adic symmetry followed by a canonical identification to reals is not equal to the canonical identification map followed by the real symmetry.

1. One can imagine modifications of the canonical identification in attempts to solve this problem. One can map rationals by $m/n \rightarrow I(m)/I(n)$. One can also express m and n as power series of p^k as $x = \sum x_n p^{nk}$ and perform the map as $x \rightarrow \sum x_n p^{-nk}$. This allows to preserve symmetries in arbitrary good measurement resolution characterizing by the power p^{-k} on real side.
2. Could one circumvent this difficulty without approximations? This kind of approach should work at least when finite measurement resolution is used meaning the replacement of the space-time surface with a set of discrete points. Could the already mentioned quantum integers provide a generalization of the notion of symmetry itself in order to circumvent ugly constructions?

1.3 Brief summary of the general vision

The basic questions of the p-adicization program are following.

1. Is there a duality between real and p-adic physics? What is its precise mathematical formulation? In particular, what is the concrete map p-adic physics in long scales (in real sense) to real physics in short scales? Can one find a rigorous mathematical formulation of the canonical identification induced by the map $p \rightarrow 1/p$ in pinary expansion of p-adic number such that it is both continuous and respects symmetries.
2. What is the origin of the p-adic length scale hypothesis suggesting that primes near power of two are physically preferred? Why Mersenne primes are especially important?

The answer to these questions proposed in this chapter relies on the following ideas inspired by the model of Shnoll effect [1]. The first piece of the puzzle is the notion of quantum arithmetics formulated in non-rigorous manner already in the model of Shnoll effect.

1. Quantum arithmetics is induced by the map of primes to quantum primes by the standard formula. Quantum integer is obtained by mapping the primes in the prime decomposition of integer to quantum primes. Quantum sum is induced by the ordinary sum by requiring that also sum commutes with the quantization.
2. The construction is especially interesting if the integer defining the quantum phase q is prime. One can introduce the notion of quantum rational defined as series in powers of the preferred prime p defining quantum phase. The coefficients of the series are quantum rationals for which neither numerator and denominator is divisible by the preferred prime.
3. p-Adic- real duality can be identified as the analog of canonical identification induced by the map $p \rightarrow 1/p$ in the pinary expansion of quantum rational. This maps maps p-adic and real physics to each other and real long distances to short ones and vice versa.

Quantum arithmetics inspires the notion of quantum matrix group as counterpart of quantum group for which matrix elements are non-commuting numbers. Now they would be ordinary numbers. Quantum classical correspondence and the notion of finite measurement resolution realized at classical level in terms of discretization suggest that these two views about quantum groups are closely related. The preferred prime p defining the quantum matrix group is identified as p-adic prime and canonical identification $p \rightarrow 1/p$ is group homomorphism so that symmetries are respected.

1. The quantum counterparts of special linear groups $SL(n, F)$, $F = R, C$ exists always. For the covering group $SL(2, C)$ of $SO(3, 1)$ this is the case so that 4-dimensional Minkowski space is in a very special position. For orthogonal, unitary, and orthogonal groups the quantum counterpart exists only if quantum arithmetics is characterized by a prime rather than general integer and when the number of powers of p for the generating elements of the quantum matrix group satisfies an upper bound characterizing the matrix group.
2. For the quantum counterparts of $SO(3)$ ($SU(2)/SU(3)$) the orthogonality conditions state that at least some multiples of the prime characterizing quantum arithmetics is sum of three (four/six) squares. For $SO(3)$ this condition is strongest and satisfied for all integers, which are not of form $n = 2^{2r}(8k + 7)$. The number $r_3(n)$ of representations as sum of squares is known and $r_3(n)$ is invariant under the scalings $n \rightarrow 2^{2r}n$. This means scaling by 2 for the integers appearing in the square sum representation.

3. $r_3(n)$ is proportional to the so called class number function $h(-n)$ telling how many non-equivalent decompositions algebraic integers have in the quadratic algebraic extension generated by $\sqrt{-n}$.

The findings about quantum $SO(3)$ suggest a possible explanation for p-adic length scale hypothesis and preferred p-adic primes.

1. The basic idea is that the quantum matrix group which is discrete is in some sense very large for preferred p-adic primes. If cognitive representations correspond to the representations of quantum matrix group, the representational capacity of cognitive representations is high and this kind of primes are survivors in the algebraic evolution leading to algebraic extensions with increasing dimension.
2. There is no need that the preferred primes correspond to larger value of $r_3(n)$. It is enough that some of their multiples do so. Indeed, for Mersenne primes and also integers one has $r_3(n) = 0$, which is in conflict with the original naive expectations. For integers $n = 2M_m$ however $r_3(n)$ is a local maximum at least for the small integers studied numerically.
3. The requirement that the notion of quantum integer applies also to algebraic integers in quadratic extensions of rationals requires that the preferred primes (p-adic primes) satisfy $p = 8k + 7$. Quite generally, for the integers $n = 2^{2r}(8k + 7)$ not representable as sum of three integers the decomposition of ordinary integers to algebraic primes in the quadratic extensions defined by $\sqrt{-n}$ is unique. Therefore also the corresponding quantum algebraic integers are unique for preferred ordinary prime if it is prime also in the algebraic extension. If this were not the case two different decompositions of one and same integer would be mapped to different quantum integers. Therefore the generalization of quantum arithmetics defined by any preferred ordinary prime, which does not split to a product of algebraic primes, is well-defined for $p = 2^{2r}(8k + 7)$ when quadratic extensions are considered. This selects Mersenne primes as preferred ones.
4. This argument was for quadratic extensions but also more complex extensions defined by higher polynomials exist. For these higher dimensional algebraic extensions the number of ordinary primes allowing no decomposition to ordinary primes and implying unique decomposition in possibly existing algebraic extension defined by the prime gets smaller. Hence algebraic evolution leading to algebraic extensions of increasing dimension would gradually select preferred primes and integers.

2 Quantum arithmetics and the notion of commutative quantum group

In this section the notion of quantum arithmetics as a generalization of ordinary arithmetics preserving its structure but mapping preferred integer- most naturally prime- to zero is discussed. Also the notion of quantum matrix group differing from ordinary quantum groups in that matrix elements are commuting numbers is discussed. This group forms a discrete counterpart of ordinary quantum group and its existence suggested by quantum classical correspondence.

2.1 Quantum arithmetics

The basic idea is that quantum arithmetics is isomorphic to the ordinary arithmetics of integers.

1. The multiplicative structure of ordinary integers is respected in the map taking ordinary integers to quantum integers:

$$n = kl \rightarrow n_q = k_q l_q . \quad (2.1)$$

This is guaranteed if the map is induced by the map of ordinary primes to quantum primes.

2. Also the sum of quantum integers is well-defined and induces sum of the quantum rationals. Therefore the sum $+_q$ of quantum integers should reflect the summation of ordinary integers:

$$n = k + l \rightarrow n_q = k_q +_q l_q . \quad (2.2)$$

The basic formula for quantum integers in the case of quantum groups is

$$n_q = \frac{q^n - q^{-n}}{q - q^{-1}} . \quad (2.3)$$

Here q is any complex number. The generalization respective the notion of primeness is obtained by mapping only the primes p to their quantum counterparts and defining quantum integers as products of the quantum primes involved in their prime factorization.

$$\begin{aligned} p_q &= \frac{q^p - q^{-p}}{q - q^{-1}} \\ n_q &= \prod_p p_q^{n_p} \text{ for } n = \prod_p p^{n_p} . \end{aligned} \quad (2.4)$$

2.1.1 Quantum counterparts of real integers

The proposed definition is just the first guess. Let us consider now some aspects of this definition to see whether it must be modified somehow.

1. The $n = 0, 1, -1$ are fixed points of $n \rightarrow n_q$ so that one can say that all these numbers are common to quantum integers for all values of q .
2. An important special case corresponds to the roots of unity: $q = e^{i2\pi/m}$. In this case primes p_1, p_2 satisfying $p_1 - p_2 \pmod n = 0$ are mapped to same quantum integers. If one has

$$q = \exp\left(\frac{\eta}{m}\right) \exp(i2\pi/m) \quad (2.5)$$

the map is 1-1 for a non-vanishing value of η and the limit $m \rightarrow \infty$ gives ordinary integers. It seems that one must include the factor making the modulus of q different from unity if one wants 1-1 correspondence between ordinary and quantum integers guaranteeing a unique definition of quantum sum.

3. Second potential problem is that p_q is negative for $n/2 \leq p \pmod n \leq n$. This would mean that quantum integers can be negative. In p -adic context this is not a problem. In real context this could be a problem if one maps a probability distribution $f(n)$ to its quantum counterpart by $n \rightarrow n_q$ unless one makes special assumption about the distribution. If this is a real problem, one can try to avoid it in a straightforward manner by including a compensating sign factor which is -1 for $n/2 \leq p \pmod n \leq n$ and +1 otherwise.

The sign factor seems to be consistent with the preservation of product structure and there seems to be no obvious reason why this definition could not be consistent with the proposed definition of quantum sum since it is just the image of the ordinary sum if m is not prime. For $\eta \neq 0$ one could say that the quantum integers define a different coordinates for integer points of the real line as algebraic numbers in the algebraic extension defined by the quantum phase.

4. If m is prime: $m = l$ (the notation is inspired by l -adicity), $l_q = 0$ holds true and all integers divisible by l are mapped to zero. If one restricts the quantum integers to the ones corresponding to $0 > n < l$, one obtains the q -analog of finite field $G(l, 1)$ by defining the sum in such a manner that it respects the sum for finite field $G(l, 1)$. In this case l is mapped to zero in perfect analogy with mod l arithmetics. One can however allow arbitrary quantum integers: not however that those divisible by l_q vanish.

5. One can also consider powers $m = l^k$ of prime. Does one obtain the analog of finite field $G(p, k)$ by defining the sum so that it respects the sum of ordinary integers modulo l^k ? This need not be the case since finite fields correspond to algebraic extensions rather than integers modulo l^k . Note that for $k > 1$ one does not encounter the problem with the vanishing of l_q .

2.1.2 The quantum counterparts of p-adic integers

One can also ask what might be the best manner to define the quantum counterparts of p-adic integers. Also now one needs a quantum phase. Its existence as a p-adic number poses strong constraints.

1. The root of unity must now correspond to an element of algebraic extension. Here Fermat's theorem $a^{p-1} \pmod{p} = 1$ poses constraints since $p-1$:th root of unity exists as ordinary p-adic number. Hence $m = p-1$:th root of unity is excluded. Also the modulus of q must exist either as a p-adic number or a number in the extension of p-adic numbers. The generalization of the expression of q in the real context to p-adic context reads as

$$q = \exp(mr)\exp(i2\pi/m) , \quad (2.6)$$

where the phase factors in the algebraic extension of p-adic integers and r is integer. If m is divisible by p the exponent exists p-adically without an extension of p-adics.

2. If m is prime: $m = l$, one obtains

$$q = \exp(ml)\exp\left(\frac{i2\pi}{l}\right) . \quad (2.7)$$

Here the condition $0 < m < l$ is natural.

2.1.3 Quantum counterpart of pinary expansion?

Is $l_q = 0$ for $q = \exp(i2\pi/l)$ a curse or blessing? The generalization of the notion of quantum integer to a power series in l turns $l_q = 0$ to a blessing as later considerations demonstrate.

1. The idea is simple: consider power series

$$x = \sum x_n l^n \quad (2.8)$$

of l with coefficients x_n which are arbitrary quantum rationals $r_q = m_q/n_q$ rather than only integers in the range $(0, l-1)$ as for ordinary pinary expansion. If m_q is divisible by l_q , one has $r_q = 0$. If $n_q = 0$, r_q is infinite so that also this option must be excluded. Somewhat loosely one can say that quantum rationals correspond to rationals not divisible by l .

2. One can define quantum arithmetics for these powers series by regarding l as a formal variable. If quantum sum is proportional to l_q it vanishes. It will be found that this could provide a very elegant manner to realize p-adic length scale cutoff without breaking of symmetries if one works in quantum rational discretization. The map $l \rightarrow 1/l$ mapping UV and IR to each other would serve as a symmetry of the theory and could relate real and p-adic physics to each other in continuous and symmetry respecting manner in the quantum intersection of real and p-adic worlds.

An attractive definition for the quantum counterparts of p-adic integers is based on the expansion in powers of l since its coefficients are not divisible by l .

1. The prime l in the expansion $\sum x_n l^n$ is interpreted as a symbolic coordinate variable and the product of two quantum integers is analogous to the product of polynomials reducing to a convolution of the coefficient using quantum sum. The coefficient of a given power of l in the product would be just the convolution of the coefficients for factors using quantum sum. In the sum coefficients would be just the quantum sums of coefficients of summands.

2. The coefficient x_n can be larger than l as ordinary integers. In the product of ordinary p-adic integers the convolution for given power of l can lead to overflow and this leads to the emergence of modulo arithmetics. As a consequence, the canonical identification $\sum x_n l^n \rightarrow \sum x_n l^{-n}$ does not respect product and sum in general. Canonical identification does not respect symmetries although it is continuous. The overflow does not happen for quantum integers. For quantum integers the image under canonical identification induced by $l \rightarrow 1/l$ respects the product and sum structures.
3. The expansion in powers of l could also have as coefficients quantum rationals for which both numerator and denominator are indivisible by l . The quantum sum however vanishes when it is proportional l_q . This might be quite essential for the definition of quantum counterparts of the matrix groups.
4. It can happen that quantum sum resulting in the product or sum of quantum integers is proportional to l_q and vanishes. This is not a catastrophe and turns out to be crucial in the definition of quantum counterparts of matrix groups with commuting elements.

Note that these numbers are algebraic numbers so that quantum integers are algebraic numbers with prime l remaining ordinary integer. Canonical identification could give rise to a correspondence between real physics and p-adic physics respecting both continuity and symmetries and mapping long real length scales to short p-adic scales and vice versa. This kind of map would allow to relate real and p-adic variants of symmetries.

This notion of quantum integer is more general than that proposed in the model of Shnoll effect [1] but gives identical predictions when the parameters characterizing the probability distribution $f(n)$ correspond contain only single term in the p-adic power expansion. The mysterious dependence of nuclear decay rates on physics of solar system in the time scale of years reduces to similar dependence for the parameters characterizing $f(n)$. Could this dependence relate directly to the fact that canonical identification maps long length scale physics to short length scales physics. Could even microscopic systems such as atomic nuclei give rise to what might be called "cognitive representations" about the physics in astrophysical length scales?

2.2 Do commutative quantum counterparts of Lie groups exist?

The proposed definition of quantum rationals involves exceptional prime l expected to define what might be called p-adic prime. In p-adic mass calculations canonical identification is based on the map $p \rightarrow 1/p$ and has several variants but quite generally these variants fail to respect symmetries. Canonical identification for space-time coordinates fails also to be general coordinate invariant unless one has preferred coordinates.

The natural question is whether the proposed definition of quantum integers as series of powers of p-adic prime l with coefficients which are arbitrary quantum rationals not divisible by l with product defined in terms of convolution for the coefficients of the series in powers of l using quantum sum for the summands in the convolution could save the situation.

To see whether this is the case on must find whether the quantum analogues of classical matrix groups exist. To avoid confusion it should be emphasized that these quantum counterparts are distinct from the usual quantum groups having non-commutative matrix elements. Later a possible connection between these notions is discussed. In the recent case matrix elements commute but sum is replaced with quantum sum and the matrix element is interpreted as a powers series or polynomial in symbolic variable $x = l$ or $x = 1/l$, l prime such that coefficients are rationals not divisible by l .

The crucial points are the following ones.

1. All classical groups [3] are subgroups of the special linear groups [16] $SL_n(F)$, $F = R, C$, consisting of matrices with unit determinant. These groups are obtained by posing additional conditions such as the orthonormality of the rows with respect to real, complex or quaternionic inner product. Determinant defines a homomorphism mapping the product of matrices to the product of determinants in the field F .

Could one generalize rational special linear group and its algebraic extensions by replacing the group elements by polynomials of a formal variable x , which has as its value the preferred prime l such that the coefficients of the polynomial are rational numbers not divisible by l ?

Could one perform this generalization in such a manner that the canonical identification $p \rightarrow 1/p$ maps this group to an isomorphic group?

2. The identity $\det(AB) = \det(A)\det(B)$ and the fact that the condition $\det(A) = 1$ involves at the right hand side only the unit element common to all quantum integers suggests that this generalization could exist. If one has found a set of elements satisfying the condition $\det_q(A) = 1$ all quantum products satisfy the same condition and subgroup of rational special linear group is generated.

2.2.1 Quantum counterparts of special linear groups

Special linear groups [16] defined by matrices with determinant equal to 1 contain classical groups as subgroups and the conditions for their quantum counterparts are therefore the weakest possible.

1. To see that the generalization exists in the case of special linear groups one just writes the matrix elements a_{ij} in series in powers of l

$$a_{ij} = \sum_n a_{ij}(n)l^n . \quad (2.9)$$

This expansion is very much analogous to that for the Kac-Moody algebra element and also the product and sum obey similar algebraic structure. l is treated as a symbolic variable in the conditions stating $\det_q(A) = 1$. It is essential that $\det_q(A) = 1$ holds true when l is treated as a formal symbol so that each power of l gives rise to separate conditions.

2. For SL_n the definition of determinant involves sum over products of n elements. Quantum sums of these elements are in question. The question whether the quantum sum can correspond to a quantum integer which is divisible by l_q and therefore vanishes. For $q = 1$ the question is whether the sum for products of rationals, which do not have p as a factor can have p as a factor. Quite generally the situation reduces to this if ordinary sum induces quantum sum. It seems that this can be the case and the question is whether one can just assume that these terms vanish without ending up with some internal inconsistency.
3. Consider now the number of conditions involved. The number of matrix elements is in real case $N^2(k+1)$, where k is the highest power of l involved. $\det(A) = 1$ condition involves powers of l up to l^{Nk} and the total number of conditions is $kN + 1$ - one for each power. For higher powers of l the conditions state the vanishing of the coefficients of l^m . This is achieved elegantly in the sense of modulo arithmetics if the quantum sum involved is proportional to l_q .

The number of free parameters is

$$\# = (k+1)N^2 - kN - 1 = kN(N-1) + N^2 - 1 . \quad (2.10)$$

For $N = 2, k = 0$ one obtains $\# = 3$ as expected for $SL(2, \mathbb{R})$. For $N = 2, k = 1$ one obtains $\# = 5$. This can be verified by a direct calculation. Writing $a_{ij} = b_{ij} + c_{ij}p$ one obtains three conditions

$$\det_q(A) = 1 , \quad Tr_q(AB) = 0 , \quad \det_q(B) = 0 . \quad (2.11)$$

for the 8 parameters leaving six parameters which of course are rational numbers whose numerator and denominator are not divisible by l .

4. Complex case can be treated in similar manner. In this case the number of three parameters is $2(k+1)N^2$, the number of conditions is $2(kN + 1)$ and the number of parameters is

$$\# = 2(k+1)N^2 - 2(kN + 1) . \quad (2.12)$$

5. Since the conditions hold separately for each power of l , the formulate $\det_q(AB) = \det_q(A)\det_q(B)$ implies that the matrices satisfying the conditions generate a subgroup of SL_n .

The result means that rational subgroups of special linear groups $SL_n(R)$ and $SL(n, C)$ quantum matrix groups characterized by prime l exist in both real and p-adic context and can be related by the map $l \rightarrow 1/l$ mapping short and length scales to each other.

It is remarkable that only the Lorentz groups $SO(2, 1)$ and $SO(3, 1)$ have covering groups are isomorphic to $SL(2, R)$ and $SL(2, C)$ allow these subgroups. All classical Lie groups involve additional conditions besides the condition that the determinant of the matrix equals to one and all these groups except symplectic groups fail to allow the generalization of this kind for arbitrary values of k . Therefore four-dimensional Minkowski space is in completely exceptional position.

2.2.2 Do classical Lie groups allow quantum counterparts?

In the case of classical groups one has additional conditions stating orthonormality of the rows of the matrix in real, complex, or quaternionic number field. It is quite possible that the conditions might not be satisfied always and it turns out that for G_2 and probably also for other exceptional groups this is the case.

1. Non-exceptional classical groups

It is easy to see that all non-exceptional classical groups quantum counterparts in the proposed sense for sufficiently small values of k and in the case of symplectic groups quite generally.

1. Consider first orthogonal groups $SO(N)$.
 - (a) For $q = 1$ there are N^2 parameters. There are N conditions stating that the rows are unit vectors and $N(N - 1)/2$ conditions stating that they are orthogonal. The total number of free parameters is $\# = N(N - 1)/2$.
 - (b) If the highest power of l is k there are $(k + 1)N^2$ parameters and $(2k + 1)[N + N(N - 1)/2] = (2k + 1)(N + 1)/2$ conditions. The number of parameters is

$$\# = N^2(k + 1) - \frac{N(N + 1)(2k + 1)}{2} = \frac{N(N - 2k + 1)}{2} . \quad (2.13)$$

This is negative for $k > (N + 1)/2$. It is quite not clear how to interpret this result. Does it mean that when one forms products of group elements satisfying the conditions the powers higher than $k_{max} = [(N + 1)/2]$ vanish by quantum modulo arithmetics. Or do the conditions separate to separate conditions for factors in AB : this indeed occurs in the unitarity conditions as is easy to verify. For $SO(3)$ and $SO(2, 1)$ this would give $k_{max} = 2$. For $SO(3, 1)$ one would have $k_{max} = 2$ too. Note that for the covering groups $SL(2, R)$ and $SL(2, C)$ there is no restrictions of this kind.

- (c) The normalization conditions for the coefficients of the highest power of a given row imply that the vector in question has vanishing length squared in quantum inner product. For $q = 1$ this implies that the coefficients vanish. The repeated application of this condition one would obtain that $k = 0$ is the only possible solution. For $q \neq 1$ the conditions can be satisfied if the quantum length squared is proportional to $l_q = 0$. It seems that this condition is absolutely essential and serves as a refined manner to realize p-adic cutoff and quantum group structure and p-adicity are extremely closely related to each other. This conclusion applies also in the case of unitary groups and symplectic groups.
 - (d) Complex forms of rotation groups can be treated similarly. Both the number of parameters and the number of conditions is doubled so that one obtains $\# = N^2(k + 1) - N(N + 1)(2k + 1) = N(N - 2k + 1)$ which is negative for $k > (N + 1)/2$.
2. Consider next the unitary groups $U(N)$. Similar argument leads to the expression

$$\# = 2N^2(k + 1) - (2k + 1)N^2 = N^2 \quad (2.14)$$

so that the number of three parameters would be N^2 - same as for $U(N)$. The determinant has modulus one and the additional conditions requires that this phase is trivial. This is expected to give $k + 1$ conditions since the fixed phase has l-adic expansion with $k + 1$ powers. Hence the number of parameters for $SU(N)$ is

$$\# = N^2 - k + 1 \quad (2.15)$$

giving the condition $k_{max} < N^2 - 1$ which is the dimension of $SU(N)$.

3. Symplectic group can be regarded as a quaternionic unitary group. The number of parameters is $4N^2(k+1)$ and the number of conditions is $(2k+1)(N+2N(N-1)) = N(2N-1)(2k+1)$ so that the number of three parameters is $\# = 4N^2(k+1) - (2k+1)N(N-1) = (2k+3)N^2 + N(2k+1)$. Fixing single quaternionic phase gives $3(k+1)$ conditions so that the number of parameters reduces to

$$\# = (2k+3)N^2 + (2k+1)N - 3(k+1) = (k+1)(2N^2 + 2N - 3) + N(N-1) \quad , \quad (2.16)$$

which is positive for all values of N and k so that also symplectic groups are in preferred position. This is rather interesting, since the infinite-dimensional variant of symplectic group associated with the $\delta M^4 \times CP_2$ is in the key role in quantum TGD and one expects that in finite measurement resolution its finite-dimensional counterparts should appear naturally.

2. Exceptional groups are exceptional

Also exceptional groups [7] [7] related closely to octonions allow an analogous treatment once the nature of the conditions on matrix elements is known explicitly. The number of conditions can be deduced from the dimension of the ordinary variant of exceptional group in the defining matrix representation to deduce the number of conditions. The following argument allows to expect that exceptional groups are indeed exceptional in the sense that they do not allow non-trivial quantum counterparts.

The general reason for this is that exceptional groups are very low dimensional subgroups of matrix groups so that for the quantum counterparts of these groups the number N_{cond} of group conditions is too large since the number of parameters is $(k+1)N^2$ in the defining matrix representation (if such exists) and the number of conditions is at least $(2k+1)N_{class}$, where N_{class} is the number of condition for the classical counterpart of the exceptional group. Note that r-linear conditions the number of conditions is proportional to $rk+1$.

One can study the automorphism group G_2 [8] of octonions as an example to demonstrate that the truth of the conjecture is plausible.

1. G_2 is a subgroup of $SO(7)$. One can consider 7-D real spinor representation so that a representation consists of real 7×7 matrices so that one has $7^2 = 49$ parameters. One has $N(N+1)/2$ orthonormality conditions giving for $N = 7$ orthonormality conditions 28 conditions. This leaves 21 parameters. Besides this one has conditions stating that the 7-dimensional analogs of the 3-dimensional scalar-3-products $A \cdot (B \times C)$ for the rows are equal 1, -1, or 0. The number of these conditions is $N(N-1)(N-2)/3!$. For $N = 7$ this gives 35 conditions meaning that these conditions cannot be independent of orthonormalization conditions The number of parameters is $\# = 49 - 35 = 14$ - the dimension of G_2 - so that these conditions must imply orthonormality conditions.
2. Consider now the quantum counterpart of G_2 . There are $(k+1)N^2 = 49(k+1)$ parameters altogether. The number of cross product conditions is $(3k+1) \times 35$ since the highest power of l in the scalar-3-product is l^{3k} . This would give

$$\# = -56k + 14 \quad . \quad (2.17)$$

This number is negative for $k > 0$. Hence G_2 would not allow quantum variant. Could this be interpreted by saying that the breaking of G_2 to $SU(3)$ must take place and indeed occurs in quantum TGD as a consequence of associativity conditions for space-time surfaces.

3. The conjecture is that the situation is same for all exceptional groups.

The general results suggest that both the covering group of the Lorentz group of 4-D Minkowski space and the hierarchy symplectic groups have very special mathematical role and that the notions of finite measurement resolution and p-adic physics have tight connections to classical number fields, in particular to the non-associativity of octonions.

2.3 Questions

In the following some questions are introduced and discussed.

2.3.1 How to realize p-adic-real duality at the space-time level?

The concrete realization of p-adic-real duality would require a map from p-adic realm to real realm and vice-versa induced by the map $p \rightarrow 1/p$ leading from p-adic number field to real number field or vice versa.

If possible, the realization of p-adic real duality at the space-time level should not pose additional conditions on the preferred extremals themselves. Together with effective 2-dimensionality this suggests that the map from p-adic realm to real realm maps partonic 2-surfaces to partonic 2-surfaces defining at least partially the boundary data for holography.

The situation might not be so simple as this.

1. One must however also consider the possibility that its is 3-D space-like surfaces at the ends of CDs which are mapped by the duality from p-adic realm to real realm or vice versa. A possible reason is that this kind of surfaces can be easily defined as intersections $F_i(z, r\xi^2, \xi^2) = 0$, $i = 1, 2$ of two complex valued functions F_i of complex coordinate z and radial light-like coordinate for $\delta M_{\pm}^4 = S^2 \times T_+$ and two complex coordinates ξ^i , $i = 1, 2$ of CP_2 : the number of conditions is 4 and this gives D= 7-4=3-dimensional space-like surface as a solution. These surfaces - that is functions F_i cannot be completely free but solutions of field equations in the direction of radial coordinate, and this might pose a difficulty.
2. It is also possible that some local 4-D tangent space data at partonic 2-surfaces are needed to characterize the space-time surface. An alternative possibility is that the failure of standard form of determinism for Kähler action forces to introduce partonic 2-surfaces in various scales and the breaking of strict 2-dimensionality does not occur locally. This option would correspond at quantum level radiative corrections in shorter scales down to CP_2 scale and might be seen as aesthetically more attractive option.
3. The realization of p-adic real duality by applying the proposed form of canonical identification to quantum rational points requires preferred coordinates. For the minimum option defined by the map of partonic 2-surfaces (no 4-D tangent space data) this would mean that one must have preferred coordinates for partonic 2-surfaces. It is easy to imagine how to identify this kind of preferred complex coordinate. The complex coordinate could correspond to a preferred complex coordinate for $S^2 \subset \delta M_{\pm}^4$ or for a homologically non-trivial geodesic sphere of CP_2 . The complex coordinates would transform linearly under the maximal compact subgroup of $SO(3)$ *resp.* $SU(3)$.

2.3.2 How commutative quantum groups could relate to the ordinary quantum groups?

The interesting question is whether and how the commutative quantum groups relate to ordinary quantum groups.

This kind of question is also encountered when considers what finite measurement resolution means for second quantized induced spinor fields [4]. Finite measurement resolution implies a cutoff on the number of the modes of the induced spinor fields on partonic 2-surfaces. As a consequence, the

induced spinor fields at different points cannot anti-commute anymore. One can however require anti-commutativity at a discrete set of points with the number of points "more or less equal" to the number of modes. Discretization would follow naturally from finite measurement resolution in its quantum formulation.

The same line of thinking might apply to quantum groups. The matrix elements of quantum group might be seen as quantum fields in the field of real or complex numbers or possibly p-adic number field or of its extension. Finite measurement resolution means a cutoff in the number of modes and commutativity of the matrix elements in a discrete set of points of the number field rather than for all points. Finite measurement resolution would apply already at the level of symmetry groups themselves. The condition that the commutative set of points defines a group would lead to the notion of commutative quantum group and imply p-adicity as an additional and completely universal outcome and select quantum phases $\exp(i2\pi/p)$ in a preferred position. Also the generalization of canonical identification so central for quantum TGD would emerge naturally.

One must of course remember that the above considerations probably generalize so that one should not take the details of the discussion too seriously.

2.3.3 How to define quantum counterparts of coset spaces?

The notion of commutative quantum group implies also a generalization of the notion of coset space G/H of two groups G and $H \subset G$. This allows to define the quantum counterparts of the proper time constant hyperboloid and $CP_2 = SU(3)/U(2)$ as discrete spaces consisting of quantum points identifiable as representatives of cosets of the coset space of discrete quantum groups. This approach is very similar but more precise than the earlier approach in which the points in discretization had angle coordinates corresponding to roots of unity and radial coordinates with discretization defined by p-adic prime.

The infinite-dimensional "world of classical worlds" (WCW) can be seen as a union of infinite-dimensional symmetric spaces (coset spaces) [3] and the definition as a quantum coset group could make sense also now in finite measurement resolution. This kind of approach has been already suggested and might be made rigorous by constructing quantum counterparts for the coset spaces associated with the infinite-dimensional symplectic group associated with the boundary of causal diamond. The problem is that matrix group is not in question. There are however good hopes that the symplectic group could reduce to a finite-dimensional matrix group in finite measurement resolution. Maybe it is enough to achieve this reduction for matrix representations of the symplectic group.

3 Could one understand p-adic length scale hypothesis number theoretically?

p-Adic length scale hypothesis states that primes near powers of two are physically interesting. In particular, both real and Gaussian Mersenne primes seem to be fundamental and can be tentatively assigned to charged leptons and living matter in the length scales between cell membrane thickness and size of the cell nucleus. They can be also assigned to various scaled up variants of hadron physics and with leptonhadron physics suggested by TGD.

How could one understand p-adic length scale hypothesis? One explanation would be in terms of evolution by quantum jumps selecting the primes that are the fittest. This would mean also selection of preferred scales for CDs , instead of integer multiples of CP_2 scale only prime multiples or possibly prime power multiples would be favored and primes near powers of two were especially fit. A possible "biological" explanation is that for the preferred primes the number of quantum states is especially large making possible to build complex sensory and cognitive representations about external world.

The proposed vision about commutative quantum groups suggests a number theoretic explanation for the p-adic length scale hypothesis consistent with the evolutionary explanation is that the quantum counterpart of symmetry groups are especially large for preferred primes. Large symmetries indeed imply large numbers of states related by symmetry transformations and high representational capacity provided by the p-adic-real duality. It is easy to make a rough test of the proposal.

1. For $SL(2, C)$ - the covering group of Lorentz group- one obtains no constraints and all quantum phases $\exp(i2\pi/n)$ are allowed: this would mean that all CDs are in the same position. One must

however notice that $l_q = 0$ allows additional solutions to the conditions since the determinant highest power of l need only be proportional to l_q rather than vanish. The rational $SL(2, C)$ matrices whose determinant is zero modulo l form a group and and it might be that for some values of l this group is exceptionally large. $SL(2, C)$ defines also the covering group of conformal symmetries of sphere.

2. For orthogonal, unitary, and symplectic groups only $n = l$, l prime allows $k > 0$ and genuine p -adicity. Since $SO(3, 1)$, $SO(3)$, $SU(2)$ and $SU(3)$ should allow p -adicization this selects CDs with size scale characterized by prime l .
3. For orthogonal, unitary, and symplectic groups one obtains non-trivial solutions to the unitarity conditions only if the highest power of l corresponds quantum image of a vector with zero norm modulo l as follows from the basic properties of quantum arithmetics.

(a) In the case of $SO(3)$ one has the condition

$$\sum_{i=1}^3 x_i^2 = k \times l \quad (3.1)$$

Note that this condition can degenerate to a condition stating that a sum of two squares is multiple of prime.

(b) For the covering group $SU(2)$ of $SO(3)$ one has the condition

$$\sum_{i=1}^4 x_i^2 = k \times l = k \times l \quad (3.2)$$

since two complex numbers for the row of $SU(2)$ matrix correspond to four real numbers

(c) For $SU(3)$ one has the condition

$$\sum_{i=1}^6 x_i^2 = k \times l = k \times l \quad (3.3)$$

corresponding to 3 complex numbers defining the row of $SU(3)$ matrix.

What can one say about these conditions? The first thing to look is whether the conditions can be satisfied at all. Second thing to look is the number of solutions to the conditions.

3.1 Orthogonality conditions for $SO(3)$

The conditions for $SO(3)$ are certainly the strongest ones so that it is reasonable to study this case first.

1. One must remember that there are also integers -in particular primes- allowing representation as a sum of two squares. For instance, Fermat primes whose number is very small, allow representation $F_n = 2^{+1}$. More generally, Fermat's theorem on sums of two squares states that and odd prime is expressible as sum of two squares only if it satisfies $p \bmod 4 = 1$. The second possibility is $p \bmod 4 = 3$ so that roughly one half of primes satisfy the $p \bmod 4 = 1$ condition: Mersenne primes do not satisfy it.

The more general condition giving sum proportional to prime is satisfied for all $n = k^2 l$, $k = 1, 2, \dots$

2. For the sums of three non-vanishing squares one can use the well-known classical theorem stating that if integers n can be represented as a sum of three non-vanishing squares only if it is *not* of the form [11]

$$n = 2^{2r}(8k+7) \quad (3.4)$$

For instance, squares of odd integers multiplied by any power of two satisfy this condition. If n satisfies (does not satisfy) this condition then nm^2 satisfies this condition for any m so that one can say that square free odd integers for which the condition $n \not\equiv 7 \pmod{8}$ generate this set of integers.

In the recent case these integers must be also divisible by prime l . Note that the integers representable as sums of three non-vanishing squares do not allow a representation using two squares. The product of odd primes $p_1 = 8m_1 + k_1$ and $p_2 = 8m_2 + k_2$ fails to satisfy the condition only if one has $k_1 = 3$ and $k_2 = 5$. The product of n primes $p_i = 8m_i + k_i$ must satisfy the condition $\prod k_i \not\equiv 7 \pmod{8}$ in order to serve as a generating square free prime.

The cold -or at least cool- shower is that Mersenne primes $M_n > 3$ do *not* satisfy the condition guaranteeing representability as a sum of three squares as one sees from $2^n - 1 = (2^{n-3} - 1)8 + 7$. The integers $2^{2k+1}M_n$ satisfy the condition. One can of course ask whether Mersenne primes might be special just because they representation requires four integers so that they would correspond to the covering $SU(2)$ of $SO(3)$ instead of $SO(3)$: could this mean that Mersenne primes -and more generally primes $p = km + 7$ - must correspond to fermions?

One must also remember that all that is needed is that sufficiently small multiples of Mersenne primes correspond to large value of $r_3(n)$.

3. If one has $\sum n_i^2 = l$ requiring

$$l = 8k + 7 \quad (3.5)$$

then the scaling $n_i \rightarrow kn_i$ gives a solution to the condition $\sum n_i^2 = k^2l$.

4. The condition $l = 8k + 7$ is true for all Mersenne primes $M_n = 2^n - 1$, $n > 2$, since $2^n - 1 = 8 \times (2^{n-3} - 1) + 7$ in this case. Hence this condition indeed selects Mersenne primes plus some other primes as special but not necessarily preferred ones for $l \pmod{4} = 3$ case. The list of allowed primes begins with 7, 23, 31, 47, 71, 79, 103, 127, ...: 7, 31, and 127 are Mersenne primes.
5. If prime near power of 2 but smaller than it is to satisfy this condition $l = 8k + 7$, one must have

$$l = 2^n - 1 - 8m - 1, \quad n > 2. \quad (3.6)$$

so that special -one might hope preferred -p-adic length scales could somehow correspond to Mersenne integers (to be distinguished from primes) from which a suitable multiple of 8 is subtracted.

3.2 Number theoretic functions $r_k(n)$ for $k = 2, 4, 6$

The number theoretical functions $r_k(n)$ telling the number of vectors with length squared equal to a given integer n are well-known for $k = 2, 3, 4, 6$ and can be used to gain information about the constraints posed by the existence of quantum groups $SO(2)$, $SO(3)$, $SU(2)$ and $SU(3)$. In the following the easy cases corresponding to $k = 2, 4, 6$ are treated first and after than the more difficult case $k = 3$ is discussed. For the auxiliary function the reader can consult to the Appendix.

3.2.1 The behavior of $r_2(n)$

$r_2(n)$ gives information not only about quantum $SO(2)$ but also about $SO(3)$ since 2-D vectors define 3-D vectors in an obvious manner. The expression for $r_2(n)$ is given by

$$r_2(n) = \sum_{d|n} \chi(d) , \quad \chi(d) = \left(\frac{-4}{d} \right) . \quad (3.7)$$

For primes this gives

$$r_2(p) = \begin{cases} 2 & \text{if } p = 1 \pmod{4} , \\ 0 & \text{if } p = 3 \pmod{4} . \end{cases} \quad (3.8)$$

The result is expected and the two solutions for $p = 1 \pmod{4}$ are obtained by permuting the components of the 2-vector. In 3-D case 2-D solutions gives rise to 12 solutions as is easy to see.

3.2.2 The behavior of $r_4(n)$

The expression for $r_4(n)$ reads as

$$r_4(n) = \begin{cases} 8\sigma(n) & \text{if } n \text{ is odd} , \\ 24\sigma(m) & \text{if } n = 2^\nu m, m \text{ odd} . \end{cases} \quad (3.9)$$

For $n = p$ one has $\sigma(p) = p + 1$ giving

$$r_4(p) = 8(p + 1) . \quad (3.10)$$

The behavior as a function of p is smooth and does not distinguish between different primes. Since σ is multiplicative function it is easy to calculate the values of $r_4(n)$ if n is a small multiple of prime since one has

$$\begin{aligned} r_4((2m + 1)l) &= r(l)\sigma(2m + 1) , \\ r_4(2^s l) &= 24r_4(l) . \end{aligned} \quad (3.11)$$

One has a periodicity in powers of 2 so that large values of r_4 appear at octaves of l . From the point of view of p-adic length scale hypothesis this is an encouraging sign but is not enough to distinguish preferred primes.

The asymptotic behavior of σ function is known so that it is relatively easy to estimate the behavior of $r_4(n)$. The behavior involves random looking local fluctuation which can be understood as reflective the multiplicative character implying correlation between the values associated with multiples of a given prime.

3.2.3 The behavior of $r_6(n)$

The analytic expression for $r_6(n)$ is given by

$$\begin{aligned} r_6(n) &= \sigma_{d|n} \left[16\chi\left(\frac{n}{d}\right) - 4\chi(d) \right] d^2 , \\ \chi(n) &= \left(\frac{-4}{n} \right) = \begin{cases} 0 & \text{if } n \text{ is even} \\ 1 & \text{if } n = 1 \pmod{4} \\ -1 & \text{if } n = 3 \pmod{4} \end{cases} \end{aligned} \quad (3.12)$$

For primes this gives

$$r_6(p) = \begin{cases} 12(p^2 + 1) & \text{for } p = 1 \pmod{4} \\ 12 + 20p^2 & \text{for } p = 3 \pmod{4} \end{cases} \quad (3.13)$$

The behavior is smooth and for primes $p = 3 \pmod{4}$ the parabolic growth is faster. $r_6(p)$ does not seem to distinguish between different primes.

3.3 What can one say about the behavior of $r_3(n)$?

The proportionality of $r_3(D)$ to the order of $h(-D)$ [1] of the ideal class group [10] [10] for quadratic extensions of rationals [1] inspires some conjectures.

1. The conjecture that preferred primes l correspond to large commutative quantum groups translates to a conjecture that the order of ideal class group is large for the algebraic extension generated by $\sqrt{-l}$ or more generally $\sqrt{-kl}$ - at least for some values of k such as $k = 2^r$. Could suitable integer multiples primes near power of 2- in particular Mersenne primes - be such primes? Note that only integer multiple is required by the basic argument.
2. Also some kind of approximate fractal behavior $r_k(sl) \simeq r_k(l)f_k(s)$ for some values of s analogous to that encountered for $r_4(D)$ for all values of s might hold true since $k = 3$ is a critical transition dimension between $k = 2$ and $k = 3$. In particular, an approximate periodicity in octaves of primes might hold true: $r_k(2^s l) \simeq r_k(l)$: this would support p-adic length scale hypothesis and make the commutative quantum group large.

3.3.1 Expression of $r_3(p)$ in terms of class number function

To proceed one must have an explicit expression for the class number function $h(D)$ and the expression of r_3 in terms of $h(D)$.

1. For $D = -p$ defining the complex extension the general expression for $h(D)$ discussed in the Appendix gives

$$h(-p) = -\frac{1}{p} \sum_1^p r \times \left(\frac{-p}{r} \right) . \tag{3.14}$$

The general expression is obtained by replacing p with D . The symbols $\left(\frac{-p}{r} \right)$ are Dirichlet and Kronecker symbols defined in the Appendix.

2. One can express $r_3(|D|)$ in terms of $h(D)$ as

$$r_3(|D|) = 12\left(1 - \left(\frac{D}{2}\right)\right)h(D) . \tag{3.15}$$

For $D = -p$ the relationship between $r_3(|D|)$ and $h(D)$ gives

$$r_3(p) = 12\left(1 - \left(\frac{p}{2}\right)\right)h(-p) . \tag{3.16}$$

Note that $\left(\frac{p}{2}\right)$ refers to Kronecker symbol.

3. From Wolfram one finds the following expressions of $r_3(n)$ for square free integers

$$\begin{aligned} r_3(n) &= 24h(-n) & n &= 3 \pmod{8} , \\ r_3(n) &= 12h(-4n) & n &= 1, 2, 5, 6 \pmod{8} , \\ r_3(n) &= 0 & n &= 7 \pmod{8} . \end{aligned} \tag{3.17}$$

4. The generating function for r_3 [17] is third power of θ function θ_3 .

$$\sum_{n \geq 0} r_3(n)x^n = \theta_3^3(n) = 1 + 6x + 12x^2 + 8x^3 + 6x^4 + 24x^5 + 24x^6 + 12x^8 + 30x^9 + \dots \tag{3.18}$$

This representation follows trivially from the definition of θ function as sum $\sum_{n=-\infty}^{\infty} x^{n^2}$.

The behavior of $h(-p)$ for large primes is not easy to deduce without numerical calculations which probably get too heavy for primes of order M_{127} . The definition involves sum of p terms labeled by $r = 1, \dots, p$, and each term is a product of terms expressible as a product over the prime factors of r with over all term being a sign factor. "Interference" effects between terms of different sign are obviously possible in this kind of situation and one might hope that for large primes these effects imply wild fluctuations of $r_3(p)$.

3.3.2 Simplified formula for $r_3(D)$

Recall that the proportionality of $r_3(|D|)$ to the ideal class number $h(D)$ is for $D < -4$ given by

$$r_3(|D|) = 12 \left[1 - \left(\frac{D}{2} \right) \right] h(D) . \tag{3.19}$$

The expression for the Kronecker symbol appears in the formula as well as formulas to be discussed below and reads as

$$\left(\frac{D}{2} \right) = \begin{cases} 0 & \text{if } D \text{ is even ,} \\ 1 & \text{if } D \equiv -1 \pmod{8} , \\ -1 & \text{if } D \equiv \pm 3 \pmod{8} . \end{cases} \tag{3.20}$$

The proportionality factor vanishes for $D = 2^{2r}(8m + 7)$ and equals to 12 for even values of D and to 24 for $D \equiv \pm 3 \pmod{8}$.

To get more detailed information about r_3 one can begin from class number formula [2] for $D < -4$ reading as

$$h(D) = \frac{1}{|D|} \sum_{r=1}^{|D|} r \left(\frac{D}{r} \right) . \tag{3.21}$$

Each Jacobi symbol $\left(\frac{D}{r} \right)$ decomposes to a product of Legendre and Kronecker symbols $\left(\frac{D}{p_i} \right)$ in the decomposition of odd integer r to a product of primes p_i .

For $\left(\frac{D}{p_i} \right) = 1$ p_i splits into a product of primes in quadratic extension generated by \sqrt{D} . If it vanishes p_i is square of prime in the quadratic extension. In the recent case neither of these options are possible for the primes involved as is easy to see by using the definition of algebraic integers. Hence one has $\left(\frac{D}{p_i} \right) = -1$ for all odd primes to transform the formula for $D < -4$ to the form

$$\begin{aligned} h(D) &= \frac{1}{|D|} \sum_{r=1}^{|D|} r \left[\left(\frac{D}{2} \right) \right]^{\nu_2(r)} (-1)^{\Omega(r) - \nu_2(r)} \\ &= \frac{1}{|D|} \sum_{r=1}^{|D|} r \left[- \left(\frac{D}{2} \right) \right]^{\nu_2(r)} (-1)^{\Omega(r)} . \end{aligned} \tag{3.22}$$

Here $\nu_2(r)$ characterizes the power of 2 appearing in r and $\Omega(r)$ is the number of prime divisors of r with same divisor counted so many times as it appears. Hence the sign factor is same for all integers r which are obtained from the same square free integer by multiplying it by a product of even powers of primes.

Consider next various special cases.

1. For even values $D < -4$ (say $D = -2M_n$) only odd integers r contribute to the sum since the Kronecker symbols vanish for even values of r .

$$h(D = 2d) = \frac{1}{|D|} \sum_{\substack{1 \leq r < |D| \\ \text{odd}}} r(-1)^{\Omega(r)} \quad (3.23)$$

2. For $D = \pm 1 \pmod{8}$, the factors $\left(\frac{D}{2}\right) = -1$ implies that one can forget the factors of 2 altogether in this case (note that for $D = -1 \pmod{8}$ $r_3(|D|)$ vanishes unlike $h(D)$).

$$h(D = \pm 1 \pmod{8}) = \frac{1}{|D|} \sum_{r=1}^{|D|} r(-1)^{\Omega(r)} \quad (3.24)$$

3. For $D = \pm 3 \pmod{8}$, the factors $\left(\frac{D}{2}\right) = 1$ implies that one has

$$h(D = \pm 3 \pmod{8}) = \frac{1}{|D|} \sum_{r=1}^{|D|} r(-1)^{\Omega(r) - \nu_2(r)} \quad (3.25)$$

The magnitudes of the terms in the sum increase linearly but the sign factor fluctuates wildly so that the value of $h(-p)$ varies chaotically but must be divisible by p and negative since $r_3(p)$ must be a positive integer. Even in this form the calculation of $r_3(p)$ requires summation over p terms so that for M_{127} the number of terms is still huge.

3.3.3 Could thermodynamical analogy help?

For $D < -4$ $h(D)$ is expressible in terms of sign factors determined by the number of prime factors or odd prime factors modulo two for integers or odd integers $r < D$. This raises hopes that $h(D)$ could be calculated for even large values of D .

1. Consider first the case $D = \pm 1 \pmod{8}$). The function $\lambda(r) = (-1)^{\Omega(r)}$ is known as Liouville function [12]. From the product expansion of zeta function in terms of "prime factors" it is easy to see that the generating function for $\lambda(r)$

$$\begin{aligned} \sum_n \lambda(n)n^{-s} &= \frac{\zeta(2s)}{\zeta(s)} = \frac{1}{\zeta_F(s)} \ , \\ \zeta(s) &= \prod_p (1 - p^{-s})^{-1} \ , \quad \zeta_F(s) = \prod_p (1 + p^{-s}) \ . \end{aligned} \quad (3.26)$$

Recall that $\zeta(s)$ *resp.* $\zeta_F(s)$ has a formal interpretation as partition functions for the thermodynamics of bosonic *resp.* fermionic system. This representation applies to $h(D = \pm 1 \pmod{8})$.

2. For $D = 2d$ the representation is obtained just by dropping away the contribution of all even integers from Liouville function and this means division of $(1 + 2^{-s})$ from the fermionic partition function $\zeta_F(s)$. The generating function is therefore

$$\sum_{n \text{ odd}} \lambda(n)n^{-s} = \prod_{p \text{ odd}} (1 + p^{-s})^{-1} = (1 + 2^{-s}) \frac{1}{\zeta_F(s)} \ . \quad (3.27)$$

3. For $h(D = \pm 3(\text{mod}8))$. One must modify the Liouville function by replacing $\Omega(r)$ by the number of odd prime factors but allow also even integers r . The generating function is now

$$\sum_n \lambda(n)(-1)^{\nu_2(n)} n^{-s} = \frac{1}{1-2^{-s}} \prod_{p \text{ odd}} (1+p^{-s})^{-1} = \frac{1}{1-2^{-s}} \frac{1}{\zeta_F(s)} . \quad (3.28)$$

The generating functions raise the hope that it might be possible to estimate the values of the $h(D)$ numerically for large values of D using a thermodynamical analogy.

1. $h(D)$ is obtained as a kind of thermodynamical average $\langle r(-1)^{\Omega(r)} \rangle$ for particle number r weighted by a sign factor telling the number of divisors interpreted as particle number. s plays the role of the inverse of the temperature and infinite temperature limit $s = 0$ is considered. One can also interpret this number as difference of average particle number for states restricted to contain even *resp.* odd particle number identified as the number of prime divisors with 2 and even particle numbers possibly excluded.
2. The average is obtained at temperature corresponding to $s = 0$ so that $n^{-s} = 1$ holds true identically. The upper bound $r < D$ means cutoff in the partition sum and has interpretation as an upper bound on the energy $\log(r)$ of many particle states defined by the prime decomposition. This means that one must replace Riemann zeta and its analogs with their cutoffs with $n \leq |D|$. Physically this is natural.
3. One must consider bosonic system all the cases considered. To get the required sign factor one must associate to the bosonic partition functions assigned with individual primes in $\zeta(s)$ the analog of chemical potential term $\exp(-\mu/T)$ as the sign factor $\exp(i\pi) = -1$ transforming ζ to $1/\zeta_F$ in the simplest case.

One might hope that one could calculate the partition function without explicitly constructing all the needed prime factorizations since only the number of prime factors modulo two is needed for $r \leq |D|$.

3.3.4 Expression of $r_3(p)$ in terms of Dirichlet L-function

It is known [13] that the function $r_3(D)$ is proportional to Dirichlet L-function $L(1, \chi(D))$ [5]:

$$\begin{aligned} r_3(|D|) &= \frac{12\sqrt{D}}{\pi} L(1, \chi(D)) , \\ L(s, \chi) &= \sum_{n>0} \frac{\chi(n, D)}{n^s} , \end{aligned} \quad (3.29)$$

$\chi(n, D)$ is Dirichlet character [4] which is periodic and multiplicative function - essentially a phase factor- satisfying the conditions

$$\begin{aligned} \chi(n, D) &\neq 0 && \text{if } n \text{ and } D \text{ have no common divisors } > 1 , \\ \chi(n, D) &= 0 && \text{if } n \text{ and } D \text{ have a common divisor } > 1 , \\ \chi(mn, D) &= \chi(m, D)\chi(n, D) , && \chi(m + D, D) = \chi(m, D) , \\ \chi(1, D) &= 1 . \end{aligned} \quad (3.30)$$

1. $L(1, \chi(D))$ varies in average sense slowly but fluctuates wildly between certain bounds. One can say that there is local chaos.

The following estimates for the bounds are given in [13]:

$$c_1(D) \equiv k_1 \log(\log(D) < L_1(1, \chi(D)) < c_2(D) \equiv k_2 \log(\log(D)) . \quad (3.31)$$

Also other bounds are represented in the article.

3.3.5 Could preferred integers correspond to the maxima of Dirichlet L-function?

The maxima of Dirichlet L-function are excellent candidates for the local maxima of $r_3(D)$ since \sqrt{D} is slowly varying function.

1. As already found, Mersenne primes and integers cannot represent pronounced maxima of $r_3(n)$ since there are no representation as a sum of three squares and the proportionality constant vanishes. In this special case it does not matter whether L-function has a maximum or not.
 - (a) Could just the fact that the representation in terms of three primes is not possible, select Mersenne primes $M_n > 3$ as preferred ones? For $SU(2)$, which is covering group of $SO(3)$ the representation as a sum of four squares is possible. Could it be that the spin 1/2 character of the fermionic building blocks of elementary particles means that a representation as sum of four squares is what matters. But why the non-existence of representation as a sum of three squares might make Mersenne primes so special?
 - (b) Mersenne prime multiplied by odd power of two satisfies the condition and some of these square free integers might correspond to pronounced maxima.
2. Could also primes near power of 2 define maxima? Unfortunately, the calculations of [13] involve averaging, minimum, and maximum over 10^6 integers in the ranges $n \times 10^6 < D < (n+1) \times 10^6$, so that they give very slowly varying maximum and minimum.
3. Could Dirichlet function have some kind of fractal structure such that for any prime one would have approximate factorization? The naivest guesses would be $L(1, \chi_{kl}) \simeq f_1(k)L(1, \chi_l)$ with $k = 2^s$. This would mean that the primes for which $D(1, \chi_p)$ is maximum would be of special importance.
4. p-Adic fractality and effective p-adic topology inspire the question whether L-function is p-adic fractal in the regions above certain primes defining effective p-adic topology $D(1, \chi_{p^k}) \simeq f_1(k)DK(1, \chi_p)$ for preferred primes.

3.3.6 Interference as a helpful physical analogy?

Could one use physical analog such as interference for the terms of varying sign appearing in L-function to gain some intuition about the situation?

1. One could interpret L-function as a number theoretic Fourier transform with D interpreted as a wave vector and one has an interference of infinite number of terms in position space whose points are labelled by positive integers defining a half -lattice with unit lattice length. The magnitude of n :th summand $1/n$ and its phase is periodic with period $D = kp$. The value of the Fourier component is finite except for $D = 0$ which corresponds to Riemann Zeta at $s = 1$. Could this means that the Fourier component behaves roughly like $1/D$ apart from an oscillating multiplicative factor.
2. The number theoretic counterparts of plane waves are special in that besides D-periodicity they are multiplicative making them also analogs of logarithmic waves. For ordinary Fourier components one additivity in the sense that $\Psi(k_1 + k_2) = \Psi(k_1)\Psi(k_2)$. Now one has $\Psi(k_1 k_2) = \Psi(k_1)\Psi(k_2)$ so that $\log(D)$ corresponds to ordinary wave vector. p-Adic fractality is an analog for periodicity in the sense of logarithmic waves so that powers rather than integer multiples of the basic scale define periodicity. Could the multiplicative nature of Dirichlet characters imply p-adic - or at least 2-adic - fractality, which also means logarithmic periodicity?
3. Could one say that for these special primes a constructive interference takes place in the sum defining the L-function. Certainly each prime represents the analog of fundamental wavelength whose multiples characterize the summands. In frequency space this would mean fundamental frequency and its sub-harmonics.

3.3.7 Period doubling as physical analogy?

1. For $k = 4$ all scales are present because of the multiplicative nature of σ function. Now only the Dirichlet characters are multiplicative which suggests that only few integers define preferred scales? Prime power multiples of the basic scale are certainly good candidates for preferred scales but amongst them must be some very special prime powers. $p = 2$ is the only even prime so that it is the first guess.
2. Could the system be chaotic or nearly chaotic in the sense of period doubling so that octaves of preferred primes interfere constructively? Why constructively? Could complete chaos -interpreted as randomness- correspond to a destructive interference and minimum of the L-function?
3. What about scalings by squares of a given prime? It seems that these scalings cannot be excluded by any simple argument. The point is that $r_3(n)$ contains also the factor \sqrt{n} which must transform by integer in the scaling $n \rightarrow kn$. Therefore k must be power of square.

This leaves two extreme options. Both options are certainly testable by simple numerical calculations for small primes. For instance one can use generating function $\theta_3^3(x) = \sum r_3(n)x^n$ to kill the conjectures.

1. The first option corresponds to scalings by all integers that are squares. This option is also consistent with the condition $n \neq 2^k(8m + 7)$ since both the scaling by a square of odd prime and by a square of 2 preserve this condition since one has $n^2 = 1 \pmod{8}$ for odd integers. This is also consistent with the finding that $r_3(n) = 1$ holds true only for a finite number of integers. A simple numerical calculation for the sums of 3 squares of 16 first integers demonstrates that the conjecture is wrong.
2. The second option corresponds only to the scaling by even powers of two and is clearly the minimal option. This period quadrupling for n corresponds to period doubling for the components of 3-vector. A calculation of the sums of squares of the 16 first integers demonstrates that for $n = 3, 6, 9, 11, \dots$ the conjecture the value of $r_3(n)$ is same so that the conjecture might hold true! If it holds true then Dirichlet L-function should suffer scaling by 2^{-r} in the scaling $n \rightarrow 2^{2r}n$. The integer solutions for n scaled by 2^r are certainly solutions for $2^{2r}n$. Quite generally, one has $r_3(m^2n) \geq r_3(n)$ for any integer m . The non-trivial question is whether some new solutions are possible when the scaling is by 2^{2r} .

A simple argument demonstrates that there cannot be any other solutions to $\sum_{n_i=1}^3 m_i^2 = 2^{2r}n$ than the scaled up solutions $m_i = 2n_i$ obtained from $\sum_{n_i=1}^3 n_i^2 = n$. This is seen by noticing that non-scaled up solutions must contain 1, 2, or 3 integers m_i , which are odd. For this kind of integers one has $m^2 = 1 \pmod{4}$ so that the sum $(\sum_i m_i^2) = 1, 2, \text{ or } 3 \pmod{4}$ whereas the right hand side vanishes mod 4.

3. If D is interpreted as wave vector, period quadrupling could be interpreted as a presence of logarithmic wave in wave-vector space with period $2\log(2)$.

3.3.8 Which preferred primes could winners in the number theoretic evolution?

Since the invariance under scalings by even powers of two holds true in strong sense, it is enough to find which square free integers satisfying the basic condition correspond to the maxima of Dirichlet function.

1. Mersenne primes (same applies to Mersenne numbers) certainly do not satisfy the condition but their odd power multiples do. The study of the situation for the smallest Mersenne primes indeed shows that for $n = 2M_k$ for $M_k = 3, 7, 31, 127$ $r_3(n)$ has a local maximum. For Mersenne integers $m = 2M_n$ with $n = 3, 5, 6, 7, 9, 12$ the ratio $r_3(n)/\sqrt{(n)}$ proportional to Dirichlet L-function is larger than 1.5 in the range $k \in [1, 40000]$. The maximum occurs for $n = 12$ and is equal to 2.25. $n = 3, 5, 7$ correspond to Mersenne primes and $n = 6, 9, 12$ to Mersenne integers divisible by the Mersenne primes associated with the factors of n , in particular all are divisible by $M_3 = 7$ so that $M_3 = 7$ sees to be a lucky number. For $n = 4, 8, 10, 11, 13$ the values

are (1.10, 1.06, 1.06.1.33). In this case M_n is divisible by $M_2 = 3$ but not divisible by higher Mersenne primes. $n = 13$ corresponds to Mersenne prime so that $n = 13$ is indeed unlucky number. One could ask whether this tendency is true also for n , when n is Mersenne integer. Checking this should be quite easy. If so then divisors of Mersenne integers would be special.

2. What matters is the existence of a large number of integer component vectors with length squared proportional to the preferred prime. The implication would be that for large values of D integers near powers of two would correspond to several closely located maxima of $h(D)$ assignable to different powers of 2.
3. The following argument favors primes of form $p = 2^{2^r}(8k + 7)$ and therefore Mersenne primes.
 - (a) One could generalize the quantum arithmetics in such a manner that the primes associated with algebraic integers are mapped to corresponding quantum primes. If the preferred ordinary prime does not decompose to generalized primes in the extension, there are no problems: this prime would still mapped to zero but in general new quantum primes would be transcendental numbers.
 - (b) If the decomposition to primes is not unique for a general ordinary prime ($h(-p) > 1$), problems are encountered since the quantum decompositions corresponding to two compositions to more general primes need not be identical. The manner to solve this problem would be simple in the case of quadratic extensions (but not generally): allow only the primes $p = 2^{2^r}(8k + 7)$ as preferred primes mapped to zero. In a given algebraic extension only those ordinary primes which do not split to produces of new primes could define quantum extensions.
 - (c) The higher the algebraic dimension of the extension of rationals, the smaller the number of preferred ordinary primes able to define the quantum arithmetics. Could this mechanism gradually select preferred primes in the number theoretical evolution by quantum jumps leading to increasingly larger algebraic extensions of rationals?
4. Note that the scaling invariance under powers of 4 does not correspond to 2-adic fractality (or equivalently continuity). 2-Adic fractality of r_3 would state that $r_3(n)$ and $r_3(n + 2^r)$ do not differ much for large enough r so that there is continuity in 2-adic topology: here $r_3(n)$ could be as real or 2-adic integer. 2-adic fractality could explain why primes near prime powers of two since the addition of a large power 2^s to the integer kp having representation $kp = 2^r(8l + m)$ leaves this representation invariant. If $r_3(n)$ behaves as 2-adic number then for large values of 2^s the addition could give $r_3(n + m2^s) = r_3(n) + n_1 2^{s_1}$, $s_1 \gg 1$ so that large primes near power of two would have large value of r_3 which is in 2-adic sense is strongly correlated with the value of r_3 for rather small integers n . The smoothed out behavior $r_3 \propto \sqrt{n}$ as real valued function poses constraints on possible 2-adic fractality. The study of r_3 for $n = 3 + 2^r$ does not however support 2-adic fractality for smaller values of r ($r < 9$): about larger values one cannot say anything without heavy numerical calculations.

4 How quantum arithmetics affects basic TGD and TGD inspired view about life and consciousness?

The vision about real and p-adic physics as completions of rational physics or physics associated with extensions of rational numbers is central element of number theoretical universality. The physics in the extensions of rationals are assigned with the interaction of real and p-adic worlds.

1. At the level of the world of classical worlds (WCW) the points in the intersection of real and p-adic worlds are 2-surfaces defined by equations making sense both in real and p-adic sense. Rational functions with polynomials having rational (or algebraic coefficients in some extension of rationals) would define the partonic 2-surface. One can of course consider more stringent formulations obtained by replacing 2-surface with certain 3-surfaces or even by 4-surfaces.
2. At the space-time level the intersection of real and p-adic worlds corresponds to rational points common to real partonic 2-surface obeying same equations (the simplest assumption). This

conforms with the vision that finite measurement resolution implies discretization at the level of partonic 2-surfaces and replaces light-like 3-surfaces and space-like 3-surfaces at the ends of causal diamonds with braids so that almost topological QFT is the outcome.

How does the replacement of rationals with quantum rationals modify quantum TGD and the TGD inspired vision about quantum biology and consciousness?

4.1 What happens to p-adic mass calculations and quantum TGD?

The basic assumption behind the p-adic mass calculations and all applications is that one can assign to a given partonic 2-surface (or even light-like 3-surface) a preferred p-adic prime (or possibly several primes).

The replacement of rationals with quantum rationals in p-adic mass calculations implies effects, which are extremely small since the difference between rationals and quantum rationals is extremely small due to the fact that the primes assignable to elementary particles are so large ($M_{127} = 2^{127} - 1$ for electron). The predictions of p-adic mass calculations remains almost as such in excellent accuracy. The bonus is the uniqueness of the canonical identification making the theory unique.

The problem of the original p-adic mass calculations is that the number of common rationals (plus possible algebraics in some extension of rationals) is same for all primes p . What is the additional criterion selecting the preferred prime assigned to the elementary particle?

Could the preferred prime correspond to the maximization of number theoretic negentropy for a quantum state involved and therefore for the partonic 2-surface by quantum classical correspondence? The solution ansatz for the modified Dirac equation indeed allows this assignment [4]: could this provide the first principle selecting the preferred p-adic prime? Here the replacement of rationals with quantum rationals improves the situation dramatically.

1. Quantum rationals are characterized by a quantum phase $q = \exp(i2\pi/p)$ and thus by prime p (in the most general but not so plausible case by an integer n). The set of points shared by real and p-adic partonic 2-surfaces would be discrete also now but consist of points in the algebraic extension defined by the quantum phase $q = \exp(i2\pi/p)$.
2. What is of crucial importance is that the number of common quantum rational points of partonic 2-surface and its p-adic counterpart would depend on the p-adic prime p . For some primes p would be large and in accordance with the original intuition this suggests that the interaction between p-adic and real partonic 2-surface is stronger. This kind of prime is the natural candidate for the p-adic prime defining effective p-adic topology assignable to the partonic 2-surface and elementary particle. Quantum rationals would thus bring in the preferred prime and perhaps at the deepest possible level that one can imagine.

4.2 What happens to TGD inspired theory of consciousness and quantum biology?

The vision about rationals as common to reals and p-adics is central for TGD inspired theory of consciousness and the applications of TGD in biology.

1. One can say that life resides in the intersection of real and p-adic worlds. The basic motivation comes from the observation that number theoretical entanglement entropy can have negative values and has minimum for a unique prime [6]. Negative entanglement entropy has a natural interpretation as a genuine information and this leads to a modification of Negentropy Maximization Principle (NMP) allowing quantum jumps generating negentropic entanglement. This tendency is something completely new: NMP for ordinary entanglement entropy would force always a state function reduction leading to unentangled states and the increase of ensemble entropy.

What happens at the level of ensemble in TGD Universe is an interesting question. The pessimistic view [6], [2] is that the generation of negentropic entanglement is accompanied by entropic entanglement somewhere else guaranteeing that second law still holds true. Living matter would be bound to pollute its environment if the pessimistic view is correct. I cannot

decide whether this is so: this seems like deciding whether Riemann hypothesis is true or not or perhaps unprovable.

2. Replacing rationals with quantum rationals however modifies somewhat the overall vision about what life is. It would be quantum rationals which would be common to real and p-adic variants of the partonic 2-surface. Also now an algebraic extension of rationals would be in question so that the proposal would be only more specific. The notion of number theoretic entropy still makes sense so that the basic vision about quantum biology survives the modification.
3. The large number of common points for some prime would mean that the quantum jump transforming p-adic partonic 2-surface to its real counterpart would take place with a large probability. Using the language of TGD inspired theory of consciousness one would say that the intentional powers are strong for the conscious entity involved. This applies also to the reverse transition generating a cognitive representation if p-adic-real duality induced by the canonical identification is true. This conclusion seems to apply even in the case of elementary particles. Could even elementary particles cognize and intend in some primitive sense? Intriguingly, the secondary p-adic time scale associated with electron defining the size of corresponding CD is .1 seconds defining the fundamental 10 Hz bio-rhythm. Just an accident or something very deep: a direct connection between elementary particle level and biology perhaps?

5 Appendix: Some number theoretical functions

Explicit formulas for the number $r_k(n)$ of the solutions to the conditions $\sum_1^k x_k^2 = n$ are known and define standard number theoretical functions closely related to the quadratic algebraic extensions of rationals. The formulas for $r_k(n)$ require some knowledge about the basic number theoretical functions to be discussed first. Wikipedia contains a good overall summary about basic arithmetic functions [1] including the most important multiplicative and additive arithmetic functions.

Included are character functions which are periodic and multiplicative: examples are symbols (m/n) assigned with the names of Legendre, Jacobi, and Kronecker as well as Dirichlet character.

5.1 Characters and symbols

5.1.1 Principal character

Principal character [1] $\chi(n)$ distinguishes between three situations: n is even, $n = 1 \pmod{4}$, and $n = 3 \pmod{4}$ and is defined as

$$\chi(n) = \left(\frac{-4}{n}\right) = \begin{cases} 0 & \text{if } n \equiv 0 \pmod{2} \\ +1 & \text{if } n \equiv 1 \pmod{4} \\ -1 & \text{if } n \equiv 3 \pmod{4} \end{cases} \quad (5.1)$$

Principal character is multiplicative and periodic with period $k = 4$.

5.1.2 Legendre and Kronecker symbols

Legendre symbol $\left(\frac{n}{p}\right)$ characterizes what happens to ordinary primes in the quadratic extensions of rationals. Legendre symbol is defined for odd integers n and odd primes p as

$$\left(\frac{n}{p}\right) = \begin{cases} 0 & \text{if } n \equiv 0 \pmod{p} , \\ +1 & \text{if } n \not\equiv 0 \pmod{p} \text{ and } n = x^2 \pmod{p} , \\ -1 & \text{if there is no such } x . \end{cases} \quad (5.2)$$

When D is so called fundamental discriminant- that is discriminant $D = b^2 - 4c$ for the equation $x^2 - bx + c = 0$ with integer coefficients b, c , Legendre symbols tells what happens to ordinary primes in the extension:

1. $\left(\frac{D}{p}\right) = 0$ tells that the prime in question divides D and that p is expressible as a square in the quadratic extension of rationals defined by \sqrt{D} .
2. $\left(\frac{D}{p}\right) = 1$ tells that p splits into a product of two different primes in the quadratic extension.
3. For $\left(\frac{D}{p}\right) = -1$ the splitting of p does not occur.

This explains why Legendre symbols appear in the ideal class number $h(D)$ characterizing the number of different splittings of primes in quadratic extension.

Legendre symbol can be generalized to Kronecker symbol well-defined for also for even integers D . The multiplicative nature requires only the definition of $\left(\frac{n}{2}\right)$ for arbitrary n :

$$\left(\frac{n}{2}\right) = \begin{cases} 0 & \text{if } n \text{ is even} , \\ (-1)^{\frac{n^2-1}{8}} & \text{if } n \text{ is odd} . \end{cases} \quad (5.3)$$

Kronecker symbol for $p = 2$ tells whether the integer is even, and if odd whether $n = \pm 1 \pmod{8}$ or $a = \pm 3 \pmod{8}$ holds true. Note that principal character $\chi(n)$ can be regarded as Dirichlet character $\left(\frac{-4}{n}\right)$.

For $D = p$ quadratic reciprocity [14] allows to transform the formula

$$\chi_p(n) = (-1)^{(p-1)/2} (-1)^{(n-1)/2} \left(\frac{p}{n}\right) = (-1)^{(p-1)/2} (-1)^{(n-1)/2} \prod_{p_i|n} \left(\frac{p}{p_i}\right) . \quad (5.4)$$

5.1.3 Dirichlet character

Dirichlet character [4] $\left(\frac{a}{n}\right)$ is also a multiplicative function. Dirichlet character is defined for all values of a and odd values of n and is fixed completely by the conditions

$$\chi_D(k) = \chi_D(k + D) , \quad \chi_D(kl) = \chi_D(k)\chi_D(l) , \quad (5.5)$$

$$\text{If } D|n \text{ then } \chi_D(n) = 0 , \quad \text{otherwise } \chi_D(n) \neq 0 .$$

Dirichlet character associated with quadratic residues is real and can be expressed as

$$\chi_D(n) = \left(\frac{n}{D}\right) = \prod_{p_i|D} \left(\frac{n}{p_i}\right) . \quad (5.6)$$

Here $\left(\frac{n}{p_i}\right)$ is Legendre symbol described above. Note that the primes p_i are odd. $\left(\frac{n}{1}\right) = 1$ holds true by definition.

For prime values of D Dirichlet character reduces to Legendre symbol. For odd integers Dirichlet character reduces to Jacobi symbol defined as a product of the Legendre symbols associated with the prime factors. For $n = p^k$ Dirichlet character reduces to $\left(\frac{p}{n}\right)^k$ and is non-vanishing only for odd integers not divisible by p and containing only odd prime factors larger than p besides power of 2 factor.

5.2 Divisor functions

Divisor functions [6] $\sigma_k(n)$ are defined in terms of the divisors d of integer n with $d = 1$ and $d = n$ included and are also multiplicative functions. $\sigma_k(n)$ is defined as

$$\sigma_k(n) = \sum_{d|n} d^k , \quad (5.7)$$

and can be expressed in terms of prime factors of n as

$$\sigma_k(n) = \sum_i (p_i^k + p_i^{2k} + \dots + p_i^{a_i k}) . \quad (5.8)$$

$\sigma_1 \equiv \sigma$ appears in the formula for $r_4(n)$.

The figures in Wikipedia [9] give an idea about the locally chaotic behavior of the sigma function.

5.3 Class number function and Dirichlet L-function

In the most interesting $k = 3$ case the situation is more complicated and more refined number theoretic notions are needed. The function $r_3(D)$ is expressible in terms of so called class number function $h(n)$ characterizing the order of the ideal class group for a quadratic extension of rationals associated with D , which can be negative. In the recent case $D = -p$ is of special interest as also $D = -kp$, especially so for $k = 2^r$. $h(n)$ in turn is expressible in terms of Dirichlet L-function so that both functions are needed.

1. Dirichlet L-function [5] can be regarded as a generalization of Riemann zeta and is also conjectured to satisfy Riemann hypothesis. Dirichlet L-function can be assigned to any Dirichlet character χ_D appearing in it as a function valued parameter and is defined as

$$L(s, \chi_D) = \sum_n \frac{\chi_D(n)}{n^s} . \quad (5.9)$$

For $\chi_1 = 1$ one obtains Riemann Zeta. Also L-function has expression as product of terms associated with primes converging for $Re(s) > 1$, and must be analytically continued to get an analytic function in the entire complex plane. The value of L-function at $s = 1$ is needed and for Riemann zeta this corresponds to pole. For Dirichlet zeta the value is finite and $L(1, \chi_{-n})$ indeed appears in the formula for $r_3(n)$.

2. Consider next what class number function h means.
 - (a) Class number function [2] characterizes quadratic extensions defined by \sqrt{D} for both positive and negative values of D . For these algebraic extensions the prime factorization in the ring of algebraic integers need not be unique. Algebraic integers are complex algebraic numbers which are not solutions of a polynomial with coefficients in \mathbb{Z} and with leading term with unit coefficient. What is important is that they are closed under addition and multiplication. One can also defined algebraic primes. For instance, for the quadratic extension generated by $\sqrt{\pm 5}$ algebraic integers are of form $m + n\sqrt{\pm 5}$ since $\sqrt{\pm 5}$ satisfies the polynomial equation $x^2 = \pm 5$.
Given algebraic integer n can have several prime decompositions: $n = p_1 p_2 = p_3 p_4$, where p_i algebraic primes. In a more advance treatment primes correspond to ideals of the algebra involved: obviously algebra of algebraic integers multiplied by a prime is closed with respect to multiplication with any algebraic integer.
A good example about non-unique prime decomposition is $6 = 2 \times 3 = (1 + \sqrt{-5})(\sqrt{1 - \sqrt{-5}})$ in the quadratic extension generated by $\sqrt{-5}$.
 - (b) Non-uniqueness means that one has what might be called fractional ideals: two ideals I and J are equivalent if one can write $(a)J = (b)I$ where (n) is the integer ideal consisting of algebraic integers divisible by algebraic integer n . This is the counterpart for the non-uniqueness of prime decomposition. These ideals form an Abelian group known as ideal class group [10]. For algebraic fields the ideal class group is always finite.
 - (c) The order of elements of the ideal class group for the quadratic extension determined by integer D can be written as

$$h(D) = \frac{1}{D} \sum_1^{|D|} r \times \left(\frac{D}{r}\right) , \quad D < -4 . \quad (5.10)$$

Here $\left(\frac{D}{r}\right)$ denotes the value of Dirichlet character. In the recent case D is negative.

3. It is perhaps not completely surprising that one can express $r_3(|D|)$ characterizing quadratic form in terms of $h(D)$ characterizing quadratic algebraic extensions as

$$r_3(|D|) = 12\left(1 - \left(\frac{D}{2}\right)\right)h(D) , \quad D < -4 . \quad (5.11)$$

Here $\left(\frac{D}{2}\right)$ denotes Kronecker symbol.

Books related to TGD

- [1] M. Pitkänen. A Possible Explanation of Shnoll Effect. In *p-Adic Length Scale Hypothesis and Dark Matter Hierarchy*. Onlinebook. http://tgd.wippiespace.com/public_html/paddark/paddark.html#ShnollTGD, 2006.
- [2] M. Pitkänen. Basic Extremals of Kähler Action. In *Physics in Many-Sheeted Space-Time*. Onlinebook. http://tgd.wippiespace.com/public_html/tgdclass/tgdclass.html#class, 2006.
- [3] M. Pitkänen. Construction of Configuration Space Kähler Geometry from Symmetry Principles. In *Quantum Physics as Infinite-Dimensional Geometry*. Onlinebook. http://tgd.wippiespace.com/public_html/tgdgeom/tgdgeom.html#comp11, 2006.
- [4] M. Pitkänen. Does the Modified Dirac Equation Define the Fundamental Action Principle? In *Quantum Physics as Infinite-Dimensional Geometry*. Onlinebook. http://tgd.wippiespace.com/public_html/tgdgeom/tgdgeom.html#Dirac, 2006.
- [5] M. Pitkänen. Massless states and particle massivation. In *p-Adic Length Scale Hypothesis and Dark Matter Hierarchy*. Onlinebook. http://tgd.wippiespace.com/public_html/paddark/paddark.html#mless, 2006.
- [6] M. Pitkänen. Negentropy Maximization Principle. In *TGD Inspired Theory of Consciousness*. Onlinebook. http://tgd.wippiespace.com/public_html/tgdconsc/tgdconsc.html#nmpc, 2006.
- [7] M. Pitkänen. *p-Adic length Scale Hypothesis and Dark Matter Hierarchy*. Onlinebook. http://tgd.wippiespace.com/public_html/paddark/paddark.html, 2006.
- [8] M. Pitkänen. p-Adic Numbers and Generalization of Number Concept. In *TGD as a Generalized Number Theory*. Onlinebook. http://tgd.wippiespace.com/public_html/tgdnumber/tgdnumber.html#padmat, 2006.
- [9] M. Pitkänen. p-Adic Physics as Physics of Cognition and Intention. In *TGD Inspired Theory of Consciousness*. Onlinebook. http://tgd.wippiespace.com/public_html/tgdconsc/tgdconsc.html#cognic, 2006.
- [10] M. Pitkänen. TGD as a Generalized Number Theory: p-Adicization Program. In *TGD as a Generalized Number Theory*. Onlinebook. http://tgd.wippiespace.com/public_html/tgdnumber/tgdnumber.html#visiona, 2006.
- [11] M. Pitkänen. TGD as a Generalized Number Theory: Quaternions, Octonions, and their Hyper Counterparts. In *TGD as a Generalized Number Theory*. Onlinebook. http://tgd.wippiespace.com/public_html/tgdnumber/tgdnumber.html#visionb, 2006.
- [12] M. Pitkänen. Was von Neumann Right After All. In *Towards M-Matrix*. Onlinebook. http://tgd.wippiespace.com/public_html/tgdquant/tgdquant.html#vNeumann, 2006.

Articles about TGD

- [1] M. Pitkänen. An attempt to understand preferred extremals of Kähler action. http://tgd.wippiespace.com/public_html/articles/prefextremals.pdf, 2011.
- [2] M. Pitkänen. Generalization of thermodynamics allowing negentropic entanglement and a model for conscious information processing. http://tgd.wippiespace.com/public_html/articles/thermolife.pdf, 2011.
- [3] M. Pitkänen. Is Kähler action expressible in terms of areas of minimal surfaces? http://tgd.wippiespace.com/public_html/articles/minimalsurface.pdf, 2011.

Mathematics

- [1] Arithmetic functions. http://en.wikipedia.org/wiki/Arithmetic_function.
- [2] Class number formula. http://en.wikipedia.org/wiki/Class_number_formula.
- [3] Classical groups. http://en.wikipedia.org/wiki/Classical_groups.
- [4] Dirichlet character. http://en.wikipedia.org/wiki/Dirichlet_character.
- [5] Dirichlet L-function. http://en.wikipedia.org/wiki/Dirichlet_L-function.
- [6] Divisor function. http://en.wikipedia.org/wiki/Divisor_function.
- [7] Exceptional groups. http://en.wikipedia.org/wiki/Exceptional_groups.
- [8] G_2 (mathematics). [http://en.wikipedia.org/wiki/G2_\(mathematics\)](http://en.wikipedia.org/wiki/G2_(mathematics)).
- [9] Graph of sigma function. http://en.wikipedia.org/wiki/File:Sigma_function.svg.
- [10] Ideal class group. http://en.wikipedia.org/wiki/Ideal_class_group.
- [11] Integer sum of three squares. http://www.proofwiki.org/wiki/Integer_as_Sum_of_Three_Squares.
- [12] Liouville function. http://en.wikipedia.org/wiki/Liouville_function.
- [13] Number theory. http://en.wikipedia.org/wiki/Number_theory.
- [14] Quadratic reciprocity theorem. http://en.wikipedia.org/wiki/Quadratic_reciprocity.
- [15] Quantum group. http://en.wikipedia.org/wiki/Quantum_group.
- [16] Special linear group. http://en.wikipedia.org/wiki/Special_linear_group.
- [17] Sum of squares function. <http://mathworld.wolfram.com/SumofSquaresFunction.html>.

Theoretical Physics

- [1] $1/N$ expansion. http://en.wikipedia.org/wiki/1/N_expansion.
- [2] Montonen Olive Duality. http://en.wikipedia.org/wiki/Montonen-Olive_duality.
- [3] I. R. Klebanov. TASI Lectures: Introduction to the AdS/CFT Correspondence. <http://arxiv.org/abs/hep-th/0009139>, 2000.

*LETTERS TO PROGRESS IN PHYSICS***A Blind Pilot: Who is a Super-Luminal Observer?**

Dmitri Rabounski

E-mail: rabounski@yahoo.com

This paper discusses the nature of a hypothetical super-luminal observer who, as well as a real (sub-light speed) observer, perceives the world by light waves. This consideration is due to that fact that the theory of relativity permits different frames of reference, including light-like and super-luminal reference frames. In analogy with a blind pilot on board a supersonic jet aeroplane (or missile), perceived by blind people, it is concluded that the light barrier is observed in the framework of only the light signal exchange experiment.

We outline a few types of the frames of reference which may exist in the space-time of General Relativity — the four-dimensional pseudo-Riemannian space with Minkowski's signature (+---) or (-+++). Particles, including the observer himself, that travel at sub-luminal speed ("inside" the light cone), bear real relativistic mass. In other words, the particles, the body of reference and the observer are in the state of matter commonly referred to as "substance". Therefore any observer whose frame of reference is one of this kind is referred to as a *sub-luminal speed observer*, or as a *substantial observer*.

Particles and the observer that travel at the speed of light (i. e. over the surface of a light hypercone) bear zero rest-mass $m_0 = 0$ but their relativistic mass (mass of motion) is nonzero $m \neq 0$. They are in the light-like state of matter. In other words, such an observer accompanies the light. We therefore call such an observer a *light-like observer*.

Accordingly, we will call particles and the observer that travel at a super-luminal speed *super-luminal* particles and observer respectively. They are in the state of matter for which rest-mass is definitely zero $m_0 = 0$ but the relativistic mass is imaginary.

It is intuitively clear who a sub-luminal speed observer is: this term requires no further explanation. The same more or less applies to a light-like observer. From the point of view of a light-like observer the world around looks like a colourful system of light waves. But who is a super-light observer? To understand this let us give an example.

Imagine a new supersonic jet aeroplane (or missile) to be commissioned into operation. All members of the ground crew are blind, and so is the pilot. Thus we may assume that all information about the surrounding world the pilot and the members of the ground crew gain is from sound, that is, from transverse waves traveling in air. It is sound waves that build a picture that those people will perceive as their "real world".

The aeroplane takes off and begins to accelerate. As long as its speed is less than the speed of sound in air, the blind members of the ground crew will match its "heard" position in the sky to the one we can see. But once the sound barrier is overcome, everything changes. The blind members

of the ground crew will still perceive the speed of the plane equal to the speed of sound regardless of its real speed. The speed of propagation of sound waves in air will be the *maximum speed of propagation of information*, while the real supersonic jet plane will be beyond their "real world", in the world of "imaginary objects", and all its properties will be imaginary too. The blind pilot will hear nothing as well. Not a single sound will reach him from his past reality and only local sounds from the cockpit (which also travels at the supersonic speed) will break his silence. Once the speed of sound is overcome, the blind pilot leaves the subsonic world for a new supersonic one. From his new viewpoint (the supersonic frame of reference) the old subsonic fixed world that contains the airport and the members of the ground crew will simply disappear to become a realm of "imaginary quantities".

What is light? — Transverse waves that run across a certain medium at a constant speed. We perceive the world around through eyesight, receiving light waves from other objects. It is waves of light that build our picture of the "truly real world".

Now imagine a spaceship that accelerates faster and faster to eventually overcome the light barrier at still growing speed. From the purely mathematical viewpoint this is quite possible in the space-time of General Relativity. For us the speed of the spaceship will be still equal to the speed of light whatever is its real speed. For us the speed of light will be the maximum speed of propagation of information, and the real spaceship for us will stay in another "unreal" world of super-light speeds where all properties are imaginary. The same is true for the spaceship's pilot. From his viewpoint, overcoming the light barrier brings him into a new super-light world that becomes his "true reality". And the old world of sub-light speeds is banished to the realm of "imaginary reality".

I am thankful to Prof. Brian Josephson and Dr. Elmira Isaeva for discussion and comments.

Submitted on February 28, 2008
Accepted on March 10, 2008

Scientist deduced the existence of particles with faster-than-light speeds recently discovered by CERN

Prof. Ion Patrascu
"Fratii Buzesti" National College
Craiova, Romania

Abstract.

In this paper we present a short survey on Smarandache Hypothesis that there is no speed barrier in the universe and one can construct arbitrary speeds, hypothesis which has been partially confirmed by the recent CERN results of OPERA team led by Dr. Antonio Ereditato that experimentally found that neutrino particles travel faster than c .

1. Introduction.

Physicists at CERN have recently experimentally discovered particles traveling faster than light: the neutrinos!

The OPERA experiment, which sent sprays of neutrinos from CERN laboratory in Geneva, Switzerland, to INFN Gran Sasso Laboratory, Italy, found that neutrinos traveled underground 730 km faster than light could do.

Dr. Antonio Ereditato of University of Bern, leader of the OPERA scientist team, made the results public and invited scientists all over the world to discuss these astonishing results.

There are mediums where the light travels slower than some particles, for example in water and oil, but not in the vacuum.

There also exist superluminal phenomena like wave phase velocity and wave group velocity, but in these cases no information or energy travels faster than the light.

Similarly there are X-waves whose superluminal velocity of the peak is a transitory phenomenon, but their wavefronts move with the speed c (Maiorino and Rodrigues, 1999).

In the breaking News on September 22, 2011, in the LiveScience.com, it is said that proven true, the laws of physics have to be re-written:

<http://news.yahoo.com/strange-particles-may-travel-faster-light-breaking-laws-192010201.html> .

2. A Hypothesis.

Professor Florentin Smarandache from the University of New Mexico, United States, has deduced the existence of particles moving faster-than-light in a published paper called "There Is No Speed Barrier in the Universe" in 1998, as an extension of a 1972 manuscript that he presented at the Universidad de Blumenau, Brazil, in a Tour Conference on "Paradoxism in Literature and Science" in 1993.

His paper is based on the Einstein-Podolsky-Rosen Paradox (1935), a Bohm's paper (1951) and Bell's Inequalities (1964).

For his hypothesis of particles of speeds greater than the speed of light (called "Smarandache hypothesis") and for his introduction of the Neutrosophic Logic, Set, and Probability (which are the most general and powerful logic and respectively set and probability theories today), Dr.

Florentin Smarandache was awarded the Telesio-Galilei Academy Gold Medal in 2010 at the University of Pecs in Hungary.

The Smarandache Hypothesis, that is included and criticized in the *Encyclopedia of Physics*,

<http://scienceworld.wolfram.com/physics/SmarandacheHypothesis.html>

is enounced as follows:

- suppose a certain physical process produces a pair of entangled particles A and B (having opposite or complementary characteristics), which fly off into space in the opposite direction and, when they are billions of miles apart, one measures particle A; because B is the opposite, the act of measuring A instantaneously tells B what to be; therefore those instructions would somehow have to traveled between A and B faster than the speed of light; hence, one can extend the Einstein-Podolsky-Rosen paradox and Bell's inequalities and assert that the light speed is not a speed barrier in the universe;
- more, one can construct any speed, even greater than the speed of light (c), by measuring particle A at various time intervals;
- also, the information from particles A and B is transmitted instantaneously (thus, there is no speed barrier in the universe).

3. Conclusion.

Although superluminal phenomena are in contradiction with Einstein's Theory of Special Relativity (1905) that prevents energy, information and (real) mass from traveling faster than light, Smarandache (1972) considered that superluminal phenomena do not violate the causality principle, neither produce time traveling, nor necessitating infinite energy for particles traveling at speeds greater than the speed of light.

References:

1. Einstein, A.; Podolsky, B.; and Rosen, N. "Can Quantum-Mechanical Description of Physical Reality Be Considered Complete?" *Phys. Rev.* 47, 777-780, 1935.
2. Bohm, D. "The Paradox of Einstein, Rosen, and Podolsky." *Quantum Th.*, 611-623, 1951.
3. Bell, J. S. "On the Einstein-Podolsky-Rosen Paradox." *Physics* 1, 195-200, 1964.
4. F. Smarandache, *An Hypothesis : There Is No Speed Barrier in the Universe*, CERN website, General Theoretical Physics, Imprint: 01 Feb 1972, <http://cdsweb.cern.ch/record/796230/>
5. Smarandache, Florentin, "There Is No Speed Barrier In The Universe", *Bulletin of Pure and Applied Sciences*, Delhi, India, Vol. 17D (Physics), No. 1, p. 61, 1998; <http://www.gallup.unm.edu/~smarandache/NoSpLim.htm>.
6. Maiorino, J. E. and Rodrigues, W. A. Jr. "What Is Superluminal Wave Motion?" *Sci. & Tech. Mag.* 2, Aug. 1999; <http://www.cptec.br/stm>.
7. Weisstein, Eric W., "Smarandache Hypothesis", *The Encyclopedia of Physics*, Wolfram Research, <http://scienceworld.wolfram.com/physics/SmarandacheHypothesis.html>.

8. Clara Moskowitz, Strange Particles May Travel Faster than Light, Breaking Laws of Physics, in LiveScience.com, 09/22/2011, <http://news.yahoo.com/strange-particles-may-travel-faster-light-breaking-laws-192010201.html>.

26 September 2011

Superluminal Physics & Instantaneous Physics as new trends in research

Florentin Smarandache
University of New Mexico
200 College Road, Gallup, NM 87301, USA
Email: smarand@unm.edu

Abstract.

In a similar way as passing from Euclidean Geometry to Non-Euclidean Geometry, we can pass from Subluminal Physics to Superluminal Physics, and further to Instantaneous Physics. In the lights of two consecutive successful CERN experiments with superluminal particles in the Fall of 2011, we believe that these two new fields of research should begin developing.

Introduction.

Let's start by recalling the history of geometry in order to connect it with the history of physics.

Then we present the way of S-denying a law (or theory) and building a spectrum of spaces where the same physical law (or theory) has different forms, then we mention the S-multispace with its multistructure that may be used to the Unified Field Theory by employing a *multifield*.

It is believed that the S-multispace with its multistructure is the best candidate for 21st century *Theory of Everything* in any domain.

1. Geometry's History.

As in Non-Euclidean Geometry, there are models that validate the hyperbolic geometric and of course invalidate the Euclidean geometry, or models that validate the elliptic geometry and in consequence they invalidate the Euclidean geometry and the hyperbolic geometry.

Now, we can mix these geometries and construct a model in which an axiom is partially validated and partially invalidated, or the axiom is only invalidated but in multiple different ways [1]. This operation produces a degree of negation of an axiom, and such geometries are hybrid. We can in general talk about the *degree of negation of a scientific entity P*, where P can be a theorem, lemma, property, theory, law, etc.

2. S-Denying of a Theory.

Let's consider a physical space S endowed with a set of physical laws L, noted by (S, L), such that all physical laws L are valid in this space S.

Then, we construct another physical space (or model) S_1 where a given law has a different form, afterwards another space S_2 where the same law has another form, and so on until getting a spectrum of spaces where this law is different.

We thus investigate spaces where anomalies occur [2].

3. Multispace Theory.

In any domain of knowledge, multispace (or S-multispace) with its multistructure is a finite or infinite (countable or uncountable) union of many spaces that have various structures. The spaces may overlap [3].

The notions of multispace (also spelt multi-space) and multistructure (also spelt multi-structure) were introduced by the author in 1969 under his idea of hybrid science: combining different fields into a unifying field (in particular combinations of different geometric spaces such that at least one geometric axiom behaves differently in each such space), which is closer to our real life world since we live in a heterogeneous multispace. Today, this idea is accepted by the world of sciences. S-multispace is a qualitative notion, since it is too large and includes both metric and non-metric spaces.

A such multispace can be used for example in physics for the Unified Field Theory that tries to unite the gravitational, electromagnetic, weak and strong interactions by constructing a *multifield* formed by a gravitational field united with an electromagnetic field united with a weak-interactions field and united with a strong-interactions field.

Or in the parallel quantum computing and in the mu-bit theory, in multi-entangled states or particles and up to multi-entangles objects.

We also mention: the algebraic multispaces (multi-groups, multi-rings, multi-vector spaces, multi-operation systems and multi-manifolds, also multi-voltage graphs, multi-embedding of a graph in an n-manifold, etc.) or structures included in other structures, geometric multispaces (combinations of Euclidean and Non-Euclidean geometries into one space as in S-geometries), theoretical physics, including the Relativity Theory [4], the M-theory and the cosmology, then multi-space models for p-branes and cosmology, etc.

The multispace is an extension of the neutrosophic logic and set, which derived from neutrosophy. Neutrosophy (1995) is a generalization of dialectics in philosophy, and takes into consideration not only an entity $\langle A \rangle$ and its opposite $\langle \text{anti}A \rangle$ as dialectics does, but also the neutralities $\langle \text{neut}A \rangle$ in between. Neutrosophy combines all these three $\langle A \rangle$, $\langle \text{anti}A \rangle$, and $\langle \text{neut}A \rangle$ together. Neutrosophy is a metaphilosophy.

Neutrosophic logic (1995), neutrosophic set (1995), and neutrosophic probability (1995) have, behind the classical values of truth and falsehood, a third component called indeterminacy (or

neutrality, which is neither true nor false, or is both true and false simultaneously - again a combination of opposites: true and false in indeterminacy).

Neutrosophy and its derivatives are generalizations of the paradoxism (1980), which is a vanguard in literature, arts, and science, based on finding common things to opposite ideas [i.e. combination of contradictory fields].

4. Physics History and Future.

- a) With respect to the size of space there are: *Quantum Physics* which is referring to the subatomic space, the *Classical Physics* to our intuitive living space, while *Cosmology* to the giant universe.
- b) With respect to the direct influence: the *Locality*, when an object is directly influenced by its immediate surroundings only, and the *Nonlocality*, when an object is directly influenced by another distant object without any interaction mediator
- c) With respect to the speed: the *Newtonian Physics* is referred to low speeds, the *Theory of Relativity* to subluminal speeds near to the speed of light, while *Superluminal Physics* will be referred to speeds greater than c , and *Instantaneous Physics* to instantaneous motions (infinite speeds).

A physical law has a form in Newtonian physics, another form in Relativity Theory, and different form at Superluminal theory, or at Infinite (Instantaneous) speeds – as above in the S-Denying Theory spectrum.

We get new physics at superluminal speeds and other physics at very very big speed ($v \gg c$) speeds or at instantaneous (infinite) traveling.

At the beginning we have to extend physical laws and formulas to superluminal traveling and afterwards to instantaneous traveling.

For example, what/how would be Doppler effect if the motion of an emitting source relative to an observer is greater than c , or $v \gg c$ (much greater than c), or even at instantaneous speed?

Also, what addition rule should be used for superluminal speeds?

Then little by little we should extend existing classical physical theories from subluminal to superluminal and instantaneous traveling.

For example: if possible how would the Theory of Relativity be adjusted to superluminal speeds?

Lately we need to found a general theory that unites all theories at: law speeds, relativistic speeds, superluminal speeds, and instantaneous speeds – as in the S-Multispace Theory.

Conclusion:

Today, with many contradictory theories, we can reconcile them by using the S-Multispace Theory.

We also propose investigating new research trends such as Superluminal Physics and Instantaneous Physics. Papers in these new fields of research should be e-mailed to the author by July 1st, 2012, to be published in a collective volume.

References:

1. Linfan Mao, *Automorphism groups of maps, surfaces and Smarandache geometries*, arXiv.org, 2005, <http://xxx.lanl.gov/pdf/math/0505318v1>
2. Florentin Smarandache, *S-Denying a Theory*, Progress in Physics, No. 1 (17), 71-74, 2011.
3. Florentin Smarandache, *Multispace and Multistructure as a Theory of Everything*, 13th Annual Meeting of the Northwest Section of the APS, Session D1, LaSells Stewart Center, Public Gallery (room), Oregon State University, Corvallis, Oregon, USA, 04:30 PM on Friday, October 21, 2011.
4. D. Rabounski, *Smarandache Spaces as a New Extension of the Basic Space-Time of General Relativity*, Progress in Physics, Vol. 2, 2010, Pages/record No.: L1-L2, DOAJ record, Sweden

The Hypergeometrical Universe: Cosmology and Standard Model

¹Marco A. Pereira

Citigroup, 390 Greenwich Street, New York, NY 10013, USA

Abstract. This paper presents a simple and purely geometrical Grand Unification Theory. Quantum Gravity, Electrostatic and Magnetic interactions are shown in a unified framework. Newton's, Gauss' and Biot-Savart's Laws are derived from first principles. Unification symmetry is defined for all the existing forces. This alternative model does not require Strong and Electroweak forces. A 4D Shock-Wave Hyperspherical topology is proposed for the Universe which together with a Quantum Lagrangian Principle and a Dilator based model for matter result in a quantized stepwise expansion for the whole Universe along a radial direction within a 4D spatial manifold. The Hypergeometrical Standard Model for matter, Universe Topology and a new Law of Gravitation are presented. Superluminal neutrinos are explained.

INTRODUCTION

Grand Unification Theories are the subject of intense research. Among current theories, Superstring, M-Theory, Kaluza-Klein based 5D Gauge Theories have shown diverse degrees of success. All theories try to keep the current conceptual framework of science. Kaluza-Klein melded both Electromagnetism and Einstein Gravitational equations in a 5D metric.

Here is presented a theory that departs radically from other theories and tries to bridge the conceptual gap as opposed to explore the formalism gap. Most research is concerned on how to express some view of Nature in a mathematically elegant formalism while keeping what we already know. It has been said that for a theory to be correct, it has to be beautiful.

This work concentrates on what to say, the conceptual framework of Nature instead. All the common constructs: mass, charge, color, hypercharge are dropped in favor of just dilator positions and dilaton fields, which are metric modulators and traveling modulations, respectively. There is no need for the concepts of charge or mass. Mass is modeled as quantity proportional to the 4D metric displacement volume at **precise phases of de Broglie cycles**. Charge sign is modeled by dilaton phase (sign) on those specific phases. The mapping is needed to demonstrate that the geometrical framework replicates current scientific knowledge.

The logical framework is presented on the Hypergeometrical Universe Topology section.

On the Cosmological Coherence section, the consequences of the topology of the hypergeometrical universe and the homogeneity proposed in the Fundamental Dilator based model for matter is shown to result in a cosmological coherence, that is, the whole 3D universe expands radially at light speed and in de Broglie (Compton) steps.

When cosmological coherence is mentioned it is within the framework of absolute time and absolute 4D space (RXYZ or Φ XYZ). There is no sense in speaking of synchronous motion within frameworks containing proper time τ . All force derivations are done considering a framework at rest with respect to the Fabric of Space.

A new Quantum Lagrangian Principle (QLP) is created to describe the interaction of dilators and dilatons. Quantum gravity, electrostatics and magnetism laws are derived subsequently as the result of simple constructive interference of five-dimensional spacetime wave overlaid on an expanding hyperspherical universe. In the electrostatics and magnetism derivation, a 1.007825046 atomic mass unit (atomic mass of a Hydrogen Atom) electron or fat electron is used. This means that the dilatons being 5D spacetime waves driven by coherent metric modulations are coherently produced by all phases of the dilator coherence.

Hypergeometrical Standard Model Section contains a brief description of the Hypergeometrical Standard Model. It shows that hyperons and the elements are modeled as longer coherences of tumbling 4D deformations. Nuclear energy is proposed to be stored on sub-coherence local twisting of the fabric of space.

¹ Ny2292000@yahoo.com

A grand unification theory is a far-reaching theory and touches many areas of knowledge. Arguments supporting this kind of theory have by definition to be equally scattered. Many arguments will be presented with little discussion when they are immediate conclusions of the topology or simple logic.

HYPERSPHERICAL UNIVERSE TOPOLOGY

The picture shown in Fig. 1 represents cross sections of the proposed hyperspherical light speed expanding universe. The universe is hypothesized to be created by a four-dimensional explosion, a Big Bang in a Four Dimensional Spatial Manifold. **The evolution of such Big Bang is a lightspeed expanding three-dimensional hypersurface on quantized de Broglie steps. The steps have length equal to the Compton wavelength associated with the fundamental dilator (the atomic mass of a hydrogen atom).** All times (proper time τ and Cosmological time Φ) are made dimensional by the multiplication by the speed of light c .

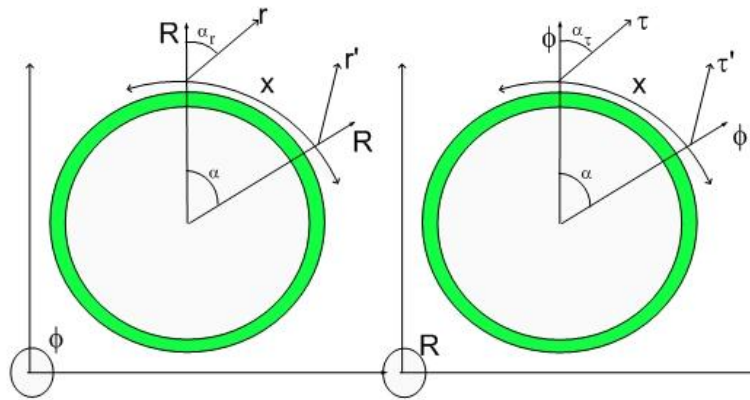

FIGURE 1. These are the cross-sections $X\tau$ and XR for the expanding universe. The universe direction along X is represented by the band. X (or Y or Z) is displayed along the perimeter of the circle. Also shown in the diagram is Φ (cosmological time), proper time τ , radial direction R , proper radial projection r , the Cosmological Angle α between two reference frames $XYZ\tau$ and $X'Y'Z'\tau'$, the local torsion angles α_r and α_τ .

Pseudo-Time Quantization/de Broglie Stepwise Expansion of the Universe are the result of the proposed model for matter based upon the Fundamental Dilator together with the proposed topology. These concepts will become clearer when the Fundamental Dilator is presented.

Definitions and simple topology based conclusions:

Cosmological time Φ represents an absolute time frame, as envisioned by Newton and Mach - it is a fifth dimension in the Hypergeometrical Universe Model. It times the expansion of the Universe.

Proper time τ , τ' are projections of the Cosmological Time Φ on the respective reference frames.

Fabric of Space (FS) is the Lightspeed traveling locus where our 3D Universe exists. This is a 3D hypersurface of a shockwave within a 4D spatial manifold. Anything at rest with respect to the Fabric of Space would just travel radially at the speed of light. At the Big Bang all dilators would be initially traveling at the speed of light not only radially but also tangentially in all directions. When the Universe is a point, there is no difference between tangential and radial directions. As the Universe aged, dilators would, on average, reach equilibrium and a low velocity with respect to FS.

The radial direction is a preferential direction in 4D space. It is the radial expansion direction. This direction doubles as a direction on 4D Space and a projection of the cosmological time, since they are related by the expansion speed (light speed).

The 3D Universe has a radius of curvature equal to the age of the Universe time the speed of light. This radius is independent of mass distribution. This is not the same as stating that General Relativity theory cannot reproduce Gravitation effects by mass induced curvature of spacetime ($XYZ\tau$).

It will be derived that the Gravitational Constant G is inversely proportional to the 4D radius of the Universe, thus being stronger in the earlier Universe. This should affect the mass of stellar candles such that earlier (far away) stellar candles would have smaller mass and thus smaller energy release, thus misleading intensity based distance measurements.

The Universe is finite but cannot be traversed since it is expanding at the speed of light. Simple geometry can provide the volume of the Universe.

One can only see the Universe up to cosmological angle $\alpha=45$ degrees.

Any observer is always at the center of their Universe.

The 4D Big Bang occurred on each and every point of the 3D Universe.

Since one can only see the past, cosmological angle $\alpha=45$ degrees corresponds to the Big Bang or thereabouts.

Doppler shifted Gamma radiation is hypothesized to be the Microwave Cosmic Background [1]. A geometric mechanism for Doppler shifting will be presented later.

The moving frame aspect of this model requires the **actual speed of light to be $\sqrt{2} * c$** since all measurements of the **observed** speed of light c can only be done at distances small in comparison to the 4D radius of the Universe.

α_R and α_τ represent a direction of propagation and a deformation of the local fabric of space. Since these angles point to direction of propagation it is clear that a local deformation of the fabric of space maps directly to a state of motion. Motion is the result of the relaxation process of the local FS (Hypergeometrical Universe interpretation of Newton's first law) as the FS expands.

RXYZ is modeled as a Cartesian space

Φ XYZ is modeled as a hyperbolic space and thus consistent with Strict Relativity [2,3] if one considers that the Lorentz transformation is a rotation on an imaginary angle equal to $\text{atan}(v/c)$.

The rate of torsion of the local FS is proportional to the force (Hypergeometrical Universe interpretation of Newton's second law).

$$F = m_0 c^2 \frac{d \tanh(\alpha_\tau)}{d\tau} \quad (1)$$

Adding the extra spatial dimension implies that:

$$F = m_{04D} c^2 \frac{d \tan(\alpha_r)}{dr} = m_{03D} c^2 \frac{d \tanh(\alpha_\tau)}{d\tau} \quad (2)$$

In this theory, a force capable of moving a body corresponds to a stress capable of deforming the Fabric of Space where that body is located. Notice that the body only has footprints on the FS where the dilators are. The strains are

given by $\frac{d \tanh(\alpha_\tau)}{d\tau}$ and $\frac{d \tan(\alpha_r)}{dr}$ where the angles are shown on the two cross-sections on Fig. 1. The "areas"

where the strain takes place are given by $m_{04D} c^2$ and $m_{03D} c^2$, respectively. They provide the extensive nature associated with mass in our current view.

Deformation of the Fabric of Space can be understood as acceleration from equation (2).

Newton's Third Law also has a representation within this theory. The stress on interacting dilators (bodies) is also the same with opposing signs; this is equivalent to say that the force felt on each other is equal with opposite signs. This law is valid both on the RXYZ and in the Φ XYZ. Newton's fourth law is the Natural Law of Gravitation which will be derived later from first principles.

The above equations are the basis for the more fundamental theoretical development in this theory. In first analysis, it is just an extrapolation of Newton's Law, which only covers the 3D space and introduces an unknown quantity F . The introduction of a four spatial dimension allows for the creation of the purely geometric tautology relating Stress on the two cross-sections shown on Fig.1. The stress associated with interaction is then same on both cross-sections. The strain is expressed differently in each cross-section and that permits the derivation of our fundamental laws of physics (Newton's, Gauss's, Biot-Savart's) from first principles. If you replace the masses by displacement volumes (4D) and displacement volumes overlap with FS (3D), it becomes clear that Newton's equation can be thought as a Stress-Strain description, where the fundamental laws can be derived from comparing strain on different cross-sections of the Universe.

FUNDAMENTAL DILATOR

We propose that dilators are the basic building block of matter. They are coherences between two metric deformation stationary states in a rotating four-dimensional double well potential. A single coherence between two 4D-space deformation states or fundamental dilator is shown to account of all the constituents of non-exotic matter (elements, neutrons, electrons and protons and their antimatter counterparties) and hyper-nuclei (hyperons) on Hypergeometrical Universe Standard Model Section. This coherence is between two deformation states with 4D volumes corresponding to the electron and proton, or electron-proton coherence. **Here the proton, anti-proton,**

electron and positron are considered to be the same particle or the fundamental dilator, just four faces of the same coin.

Electron and Proton Model

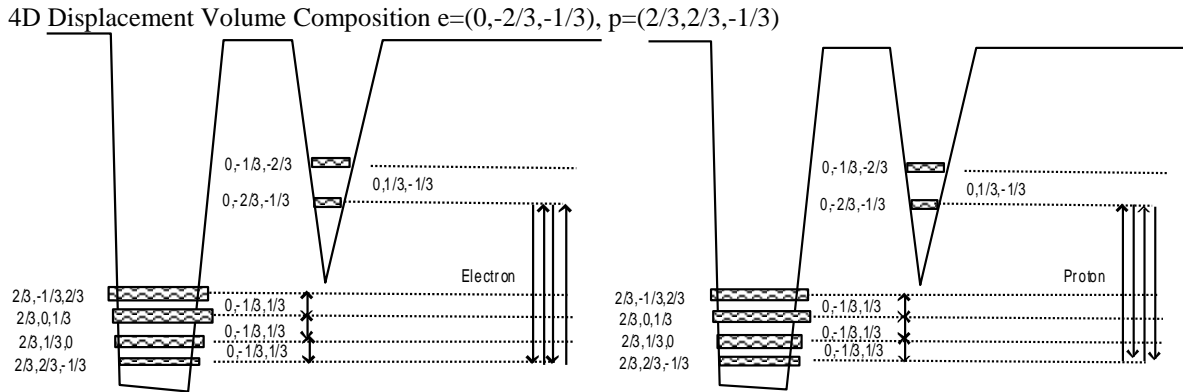

FIGURE 2. 4D Stationary Deformation State diagram for electron and proton.

The coherence four notes are meant to repeat forever since this is a coherence between ground states. The 4D Displacement Volume corresponds to the three axes length of a 4D ellipsoid of revolution.

Where $p=(2/3,2/3,-1/3)$, $p^*=(2/3,-1/3,2/3)$, $e=(0,-2/3,-1/3)$, $e^*=(0,-1/3,-2/3)$ are a subset of states involved in the three most common “particles”= proton, electron and neutron. Notice that $p(e)$ and $p^*(e^*)$ differs only by orientation. In this dynamic model, spatial degeneracy is lifted due to the finite time it takes for a proton or electron to rotate within the 3D hypersurface. This subcoherences involving the * states introduce dephasing between tunneling and spinning (rotating perpendicular to R and a direction X or Y or Z), increasing tension on the FS and changing which phase is in phase with the FS. For that, they are referred to as transmutation notes.

A half-cycle shifted diagram would account for positron and antiproton, this just means, that when a Proton is expanding space, an antiproton would be contracting space.

Below is another representation of the electron and positron.

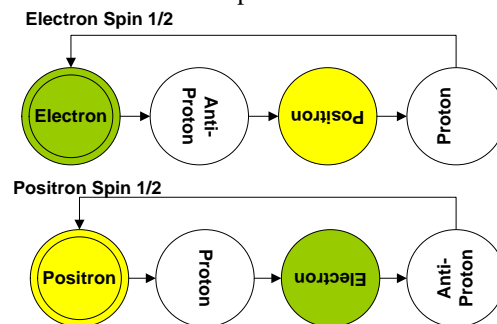

FIGURE 3. Dimensional notes associated with Electron and Positron. Lighter = positive charge, darker = Negative charge, White = Invisible in 3D due to 4D orientation – perpendicular to the Fabric of Space.

The term dimensional note was used to emphasize the similarity between the dilators (metric modulators) and musical instruments and the dilatons (traveling metric modulations) and sounds. The Fundamental Dilator is the ensemble of four dimensional notes, each one corresponding to a dilation or contraction of the local metric. The two involved states correspond to two metric volume displacements mapped to proton and electron masses. Simple inspection of Fig. 3 clarifies the why the usage of a Fat Electron with a mass equal to the mass of a Hydrogen Atom. The mass we are referring to is a 4D Mass, which is the basis for the dissociation of Inertial Mass (3D Mass) and Gravitational (Electromagnetic) Mass (4D Mass). One associated the 4D Mass to the ability to generate a dilaton field. It is clear that with this representation for protons and electrons, they ability to generate a dilaton field is the

same (same 4D Mass), since the coherent addition of dilaton fields at 45 degrees does not depend upon which phase of the coherence is in phase with the FS.

Inertial Mass or 3D Mass is the overlap of the Fundamental Dilator with the FS at phases $0, \pi, 2\pi$ and so on. The lettering shown on Fig. 3 indicates the orientation of the state with respect to the FS. Vertical lettering indicates minimum overlap with the FS, thus minimum interaction. Horizontal lettering indicates perfect overlap. It is clear that only at a very specific phase there is interaction, thus one would expect an intermittently interaction Universe. The phase would be randomized after a while if there wasn't a reason for dilators to rephase themselves at each de Broglie step. This reason is the Quantum Lagrangian Principle.

Notice that the first and last elements of the coherence chain are the same and that the coherence repeats itself for its lifetime. In the case of a proton/electron, that lifetime is infinite, since that coherence is between two ground states. Belly up states represent anti-states (anti-proton or positron states).

Since in the theory, there is an absolute time, one can define an absolute phase and that is what distinguishes an electron from a positron. Later it will be clear that more complex coherences involving the p^* state (neutrino) will result in a phase shift of the tunneling process with respect to the tumbling process, thus modifying which state is in phase with the shock-wave universe.

The colors are shown only for states that have both a FS overlap and the same frequency as the fundamental dilator.

Another important element of the model is the bolding of the third axis length (e.g. $p=(2/3, 2/3, -1/3)$). This means that the spin is a tumbling process around and rotational axis perpendicular to both the radial direction (perpendicular to all three spatial coordinates and the z coordinate). This defines a 4D angular momentum which has to be conserved. More complex coherences like the ones associated with Delta and Sigma particles differs just by the final spin and thus by how the sub-coherences tumbles to make up the final amount of spinning. Details will be

Here is the representation of a proton and an antiproton.

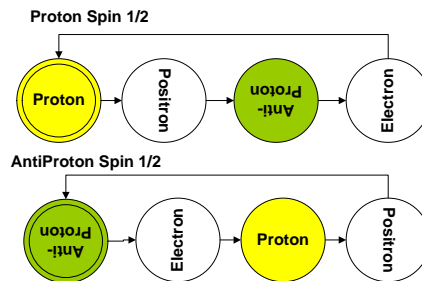

FIGURE 4. Dimensional notes associated with Proton and anti-Proton.

Neutron Model

4D Displacement Volume Composition: neutron = $e(0, -2/3, -1/3)$ plus $p(2/3, 2/3, -1/3)$ plus antineutrino $(0, -1/3, 1/3) = (2/3, -1/3, -1/3)$

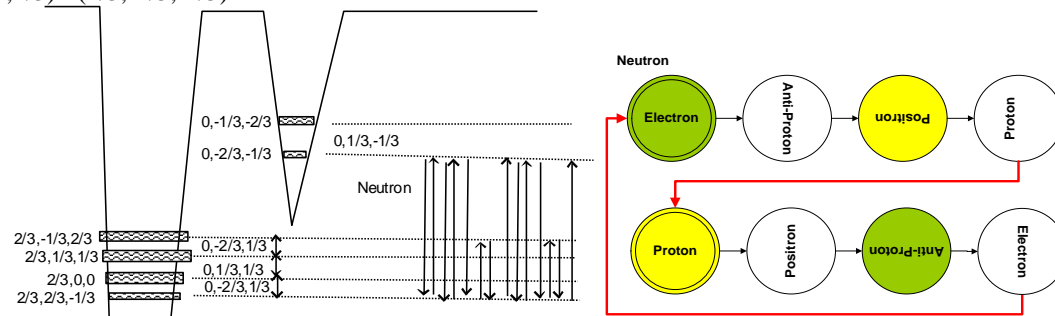

FIGURE 5. Neutron coherence. Notice the electron coherence followed by a subcoherence corresponding to a 90 degrees rotation within the FS followed by a proton coherence and another 90 degrees rotation within FS. Right panel shows Neutron diagram displaying the two fundamental subcoherences and two transmutation notes (half-antineutrino each).

The subcoherences corresponds to the electron antineutrino and changes the phase relationship between tunneling and spinning, permitting a change in the nature of the state in phase with FS. This means that at each de Broglie state, the neutron changes character from electron to proton. Another aspect of this model is its dimer character. Due to the uncertainty on the phase of the initial dilator state, neutron is better described as a dimer (proton/electron) in a pseudo-rotation of 180 degrees at each de Broglie step. A de Broglie step encompasses the four phases of the fundamental dilator subcoherence.

The red lines correspond to the Electron-Proton-Electron transmutation notes. Currently they are assigned to a 3D rotation of the fundamental dilator while in the proton state, due to the larger inertia (displacement volume) of this state, thus slower rotation. The alternative assignment would be that the transmutation note and thus the half-neutrino subcoherence to be assigned to a 3D rotation while the Fundamental Dilator is in the electron state. This assignment is not crucial to the theory.

Notice that the electron neutrino corresponds to a subcoherence between states $(2/3, 2/3, -1/3)$ and $(2/3, -1/3, 2/3)$. This is equivalent to the shrinking of the local metric along axis Y and simultaneous expansion of the same metric along the Z axis. This forms the basis for the assignment of the electron neutrino as an asymmetric dilaton field when free. The difference in dilaton frequency and nature (symmetric for light versus asymmetric for the electron neutrino) forms the basis for my explanation on why an electron neutrino would have a different speed than light. In this case, the asymmetric dilaton mode with higher frequency has a higher speed than the symmetric dilaton mode (light).

Antineutrino Model

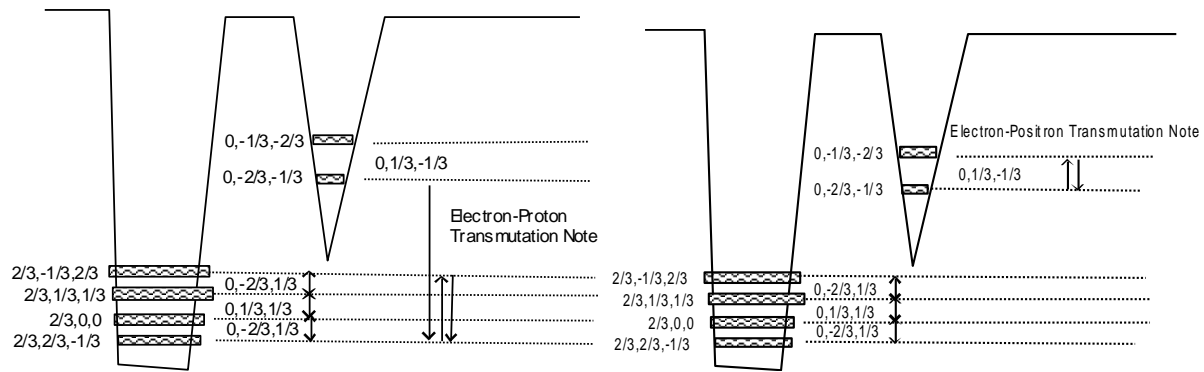

FIGURE 6. Electron-Proton/Proton-Electron and Electron-Positron/Positron-Electron transmutation notes

Each one of these two transmutation notes contribute to a dephasing angle to particles which contain it. The electron-proton transmutation note is present in neutrons while the electron-positron note is present in pions. Two electron-proton transmutation notes form an antineutrino.

The half-antineutrinos subcoherences (transmutation notes) change the relative phase between tunneling and spinning, thus changing the nature of the FS in-phase coherence from electron to proton and later vice-versa. They also introduces the spring tension associated with the nuclear energy stored in a neutron. The pseudo-rotation accompanies a local FS deformation associated with a strong centrifugal acceleration as the dimer rotates within the 3D space. The total deformation is equal to the stored nuclear energy of the particle. When a neutron decays, it generates an antineutrino and a proton and an energetic electron. The energy is stored in the Fabric of Space and the associated angle can be easily calculated. The shift in phase is such that the electron/proton fabric of space twisting is $43.90266/-0.07294$ degrees for a neutron at rest, respectively. This is the fabric of space twisting that would result in the observed relative exit velocities plus antineutrino after neutron decaying. Notice that twisting the fabric of space results in an increase in the observed mass or FS overlap of the 4D volume displacement associated with different states, and thus explains the extra mass involved in the neutron formation. This “extra mass or extra overlap” concept is an artifact of the current choice of laws of motion. If one could remain in the logical framework of this theory, the explanation for “larger inertia” is just due to the fact that the larger the twisting of the local FS, the smaller subsequent twisting will be for the same dilaton field. This is due to the fact that interaction always occurs at 45 degrees and that is the maximum angle one can twist FS through this mechanism (dilaton-dilator interference).

The same reasoning is applicable to all particles and elements. The elements and isotopes are modeled as simple coherences involving only the fundamental dilator (electron and proton) and the Electron-Proton transmutation note. Elements and isotopes are represented by more complex polymeric coherences (a neutron is a dimer in this theory). A polymeric coherences containing n Dilators pseudo-rotates by $(2\pi/n)$ at each de Broglie step of Universe expansion. The uncertainty on the orientation of the axis of rotation in the 3D manifold is due to our inability to point to the radial direction within a 3D manifold. The axis of rotation undetermined until measured.

Further research should follow to pinpoint the exact angles and their application to the mass calculation of the subatomic particles and isotopes.

Pion Minus Model

The state diagram should read as an electron coherence followed by a electron-positron transmutation note (rotation in the 3D Space in the electron metric deformation state). This transmutation note changes the phase relationship between tunneling and spinning making the next phase to be in phase with the FS to be a positron coherence. This repeat twice (electron->positron->electron) followed by an electron-proton and a proton-electron transmutation notes.

Assignments were made for all hyperon family and will be presented elsewhere.

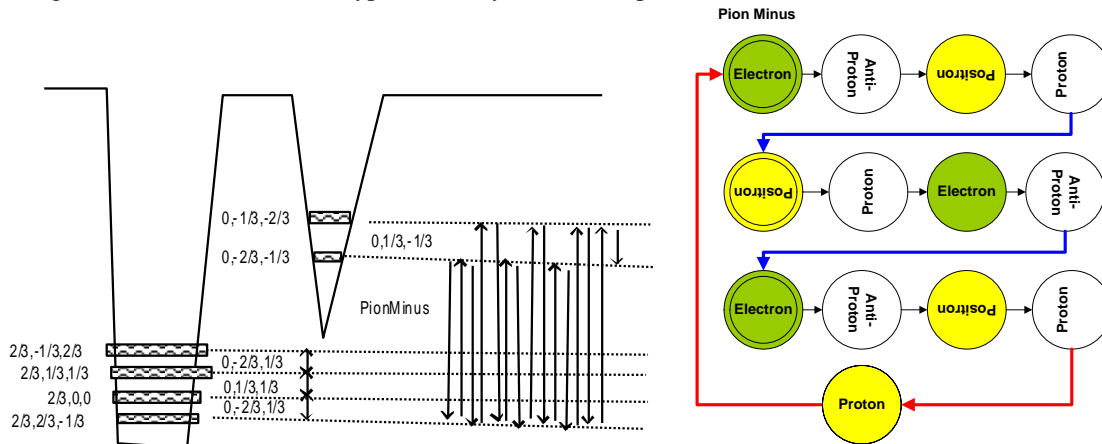

FIGURE 7. Pion Minus Coherence and diagram. Pion minus contains two electrons and one positron subcoherences and form a trimer in the 3D space rotating 120 degrees at each de Broglie expansion step.

PSEUDO TIME-QUANTIZATION AND THE STROBOSCOPIC UNIVERSE

Pseudo Time-Quantization arises when one considers Newton’s Law, where mass attracts mass at the direct products of their values. On the intermediate phases, the 3D overlap of the fundamental dilator with the FS goes to zero and so goes its perceived 3D mass, resulting in an intermittent interacting Universe (Stroboscopic Universe).

This pseudo-time quantization and the introduction of a four spatial dimension creates inherent uncertainties in the dynamics of dilator which together with the Quantum Lagrangian Principle would result in the basis for Quantum Mechanics.

QUANTUM LAGRANGIAN PRINCIPLE

The Quantum Lagrangian Principle is nothing more than a direct result of the quantization of space deformation or metric deformation. It states that:

DILATORS ALWAYS DILATE IN PHASE WITH THE SURROUNDING DILATON FIELD

Since Gravitation and everything else is described in terms of metric deformations, all fields are quantized in a sense but not in another. Gravitational/Electromagnetism fields are dependent upon dilaton fields from dilators

which provide quantized dilations amplitudes and have to be at any given time on a well defined spatial interference patterned grid, although not at quantized distances. This means that the generation of the field is quantized but the actual dilaton field is not.

This means that interacting dilators (e.g. Hydrogen atom composed of electron and proton), will always be at the nearest maximum dilation (contraction) for proton (electron) at each de Broglie step of the Universe expansion. The phase choice is arbitrary. This means that the electron (the most mobile) will have an uncertain trajectory (due to the azimuthally nature of the interferometric dilaton pattern resulting from proton-electron interaction).

Due to the Quantum Lagrangian Principle, peak dilaton field and dilator position can be thought as being the same, that is, a dilator will surf a dilaton field, which has the real physical meaning of a local metric deformation. The dilaton field-FS overlap on ΦXYZ cross-section corresponds to the de Broglie material waves. While traveling within a 4D spatial manifold, a dilator will always surf the total dilaton field according to $RXYZ$ cross-section. One should be careful not to interpret that particles (dilators) follow just an interference pattern in our 3D Universe. The perceived reality in the 4D spacetime (τXYZ) depends upon the solution of the Hypergeometrical Universe Newton's equation of motion.

ELECTROMAGNETIC AND GRAVITATIONAL DILATORS

The archetypical Electromagnetic Dilator is represented by the Proton or Electron coherences presented previously. The Gravitational Dilator is represented by a spin zero Hydrogen Atom shown below:

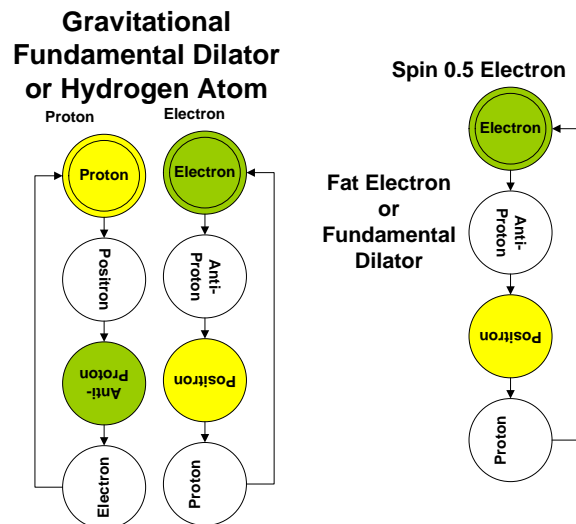

FIGURE 8. Archetypical Gravitational Fundamental Dilator (zero spin Hydrogen atom) and Electromagnetic Fundamental Dilator (electron).

The first thing that comes to mind is that the Gravitational Fundamental Dilator contains two Electromagnetic Fundamental Dilators. Positive and negative phases of the dilator are positioned such as to minimize dilator work, that is, the phases are positioned to be in phase with the surrounding dilaton field.

Their 3D mass or inertial mass behaves as expected. An Electrostatic Fundamental Dilator on an electron pattern has the inertial mass of an electron. A Fundamental Dilator on a proton pattern has the inertial mass of a proton. The reason for a light speed expansion of the shockwave Universe and the synchronization event that forever synched all dilator's spinning will be explained later when we briefly review Cosmogogenesis in the Beginning of Times section.

THE MEANING OF INERTIA

Inertia maps to the overlap of the dilator with FS at specific phases when the Universe interacts. At those phases, the larger the overlap, the larger the inertia will be. The reason lies on the Stress-Strain view of interaction. Interacting dilators create dilaton fields which affect the position of other dilators at subsequent de Broglie steps.

This is equivalent to changing the propagation direction within the 4D spatial manifold and thus to a local deformation of the FS. The larger the area that should be deformed the larger the required stress (Force), thus the larger the inertia.

The intersection of this 4D dilator displacement volume with the very thin 4D Universe (Fabric of Space) multiplied by a 4D mass density corresponds to the perceived 3D mass, a familiar concept. Since both the dilator and the Fabric of Space are very thin, the intersection decreases extremely rapidly with spinning angle. The interaction between dilators and dilaton fields (generated by other dilators) is directly dependent upon that footprint. Since the footprint is non-null only at specific spinning angles, interaction is quantized and “existence” is quantized. Where existence was construed according to the following paradigm: “I interact, thus I exist”. Neutrinos have been called “Ghostly Particles” due to their very small interaction with the rest of the Universe (dilators). It will be shown that neutrinos correspond to coherences with different wavelength or frequency than the Fundamental Dilator, thus resulting in alternating interactions that are only effective at very short range, thus making neutrino matter interaction cross-section very small.

COSMOLOGICAL COHERENCE

Given that dilators obey the Quantum Lagrangian Principle, thus are never dephased by interactions, then it becomes clear that all dilators are in phase throughout the Universe, creating a Cosmological Coherence.

The existence of macroscopic coherence is the underlying reason why the concept of field can work. If one considers a field to be a property of space, then the coherent addition of dilaton fields is a requirement for the fields to be an extensive property of the number of dilators.

THE PIONEER ANOMALY

The Pioneer Anomaly can be derived directly understood from the Hypergeometrical Universe topology. The anomaly is an unexpected deceleration that cannot be explained by all known facts.

It is our current understanding that only matter curves spacetime, this means that locally the curvature is quite well defined by the inexistence of localized matter. In the vicinity of Pioneer without the obvious occurrence of matter, it is equal to zero. The addition of another spatial dimension in the Hypergeometrical Universe theory changes things, since there are now many curvatures to talk about.

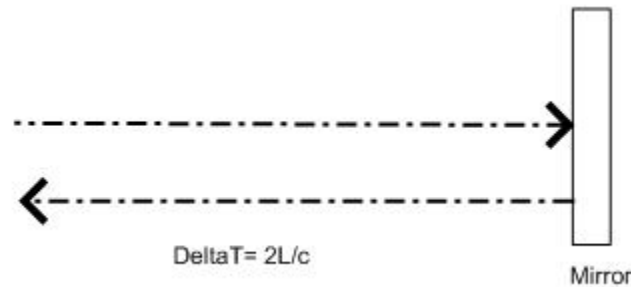

FIGURE 9. Figure showing the reflected radiation bouncing back from the mirror at rest, posing as the Pioneer spacecraft.

Let’s see what happens when one measures the speed of light within our standard paradigm. The measure time delay between shooting the laser pulse and measuring the reflection is equal to twice the distance divided by the speed of light.

For a static mirror, the relationship between frequency, wavelength and the speed of light states that:

$$f = \frac{c}{\lambda} \tag{3}$$

Now if we place the mirror in motion we arrive at the standard derivation of the Doppler Effect:

$$f_{Shifted} = \frac{c+v}{\lambda} \tag{4}$$

The Doppler shift is given by:

$$\Delta f = \frac{v}{c} f \quad (5)$$

The derivation is different if one allows both c and v to vary:

$$f_{Shifted}(0) = \frac{c+v}{\lambda} \quad (6)$$

$$f_{Shifted}(\Delta t) = \frac{c + \dot{c}\Delta t + v + \dot{v}\Delta t}{\lambda} \quad (7)$$

Resulting:

$$\frac{\Delta f_{Shifted}}{\Delta t} = \frac{\dot{c} + \dot{v}}{c} f \quad (8)$$

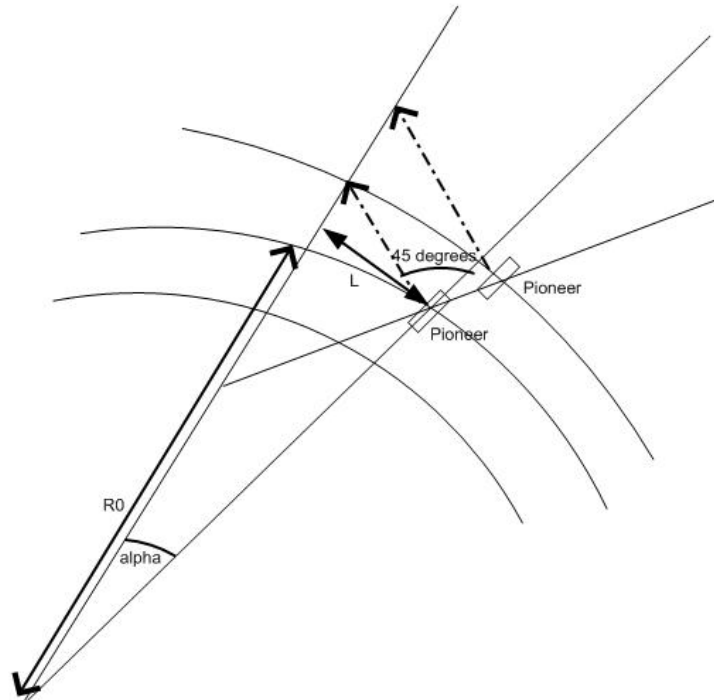

FIGURE 10. Geometry of reflected radiation bouncing back from the Pioneer spacecraft as it travels away.

This means that both accelerations on the speed of light or the actual speed of the Pioneer spacecraft would contribute to the Doppler Shift. The figure below shows how the perceived speed of light would vary as a function of the spacecraft distance.

Fig. 10 shows what would be the path traversed by each pulse emitted by the Pioneer spacecraft. The angle of the light ray is always 45 degrees is consistent with a lightspeed expanding shockwave Universe and with a real speed of light that is $\sqrt{2}c$. The leftmost radial line represents Earth position. This means that when Pioneer is far from Earth by 45 degrees or $\frac{\pi}{4}R_0$, light will never come back (the light ray will be parallel to the Earth radial line. Two parallel lines never meet. From the point of view of being on Earth, this could be interpreted as if the Pioneer spacecraft had reached the speed of light, which it did just by being at that position if one considers the lightspeed expansion of the hyperspherical surface.

Let's say that at time zero, Pioneer is at R_0 from the 4D Center of the Universe and L from Earth and let's derive the deceleration from the simple geometry.

Let $R(t)$ be the Radius of the Universe at the time t :

$$R(t) = R_0 + ct \quad (9)$$

Where time is being measured after a light pulse is emitted from the Pioneer while it is at distance from the 4D Center of the Universe equal to R_0 .

The Cosmological Angle associated with Pioneer at time t given by:

$$\alpha(t) = \frac{(L+ct)}{(R_0+ct)} \quad (10)$$

for calculating the deceleration of the speed of light and

$$\alpha(t) = \frac{(L+vt)}{(R_0+ct)} \quad (11)$$

for calculating the deceleration of the speed of the Pioneer spacecraft.

The Cosmological Angle alpha is measured from the actual Center of the Universe. The time that measures the expansion of the Universe is the Cosmological Time Φ , but for quasi-relaxed fabric of space (low velocities), the Cosmological Time is a reasonable approximation to the proper time.

The equation for the photon trajectory leaving the Spacecraft and reaching Earth later is given by:

$$y(t, t') = R(t) \sin(\alpha(t)) - c\sqrt{2}t' \sin\left(\frac{\pi}{4} - \alpha(t)\right) \quad (12)$$

Where $y(t, t')$ is the tangential distance represented in the Fig. 10 of the reflected light beam as a function of time t' , which starts counting at the reflection moment. The time t refers to the t governing the expansion of the Universe from some given initial condition (R_0, L).

Equating this equation to zero and solving for t' , one obtains the time it takes for light to come from Pioneer to Earth at any given time or Pioneer position.

The perceived distance traversed is given by $x=c.t'$:

$$x = ct' = \frac{R(t) \sin(\alpha(t))}{\sqrt{2} \sin\left(\frac{\pi}{4} - \alpha(t)\right)} \quad (13)$$

Taking the second derivative, expanding in Taylor Series and simplifying to obtain the acceleration as:

$$\frac{d^2x}{dt^2} = \frac{2c^2}{R_0} + \frac{2v^2}{R_0} \quad (14)$$

The observed acceleration is $8.75e-10$ m/s², the speed of light = 299792458 m / s. This yields a value for $R_0=2.05E+26$ meters. Since the Pioneer velocity is much smaller than c and the second term can be neglected.

The 4D observed velocity of light is $\sqrt{2}c$ but the Universe expansion velocity is just c . This means that the Universe is $\frac{R_0}{c}$ (**21.72 billion years old**) and not $\frac{R_0}{\sqrt{2}c}$ (1.5364E+10 years old). Analysis using Hubble constant would yield the incorrect results of 15.36 billion years old. Hubble constant is only valid for short cosmological distances. For long distances one should use this equation:

$$H = \frac{\sqrt{2}c}{R_0 \cos\left(\frac{\pi}{4} - \alpha\right)} \quad (15)$$

Where α is the Cosmological Angle.

Setting $\alpha = 0$ recovers:

$$H = \frac{\sqrt{2}c}{R_0} \quad (16)$$

This is the standard Hubble constant or the inverse of 1.5364E+10 years in seconds.

While observing the past by peering further into space, one changes the angle of observation from 45 degrees for short distances to zero degrees when looking at the Big Bang. This change in the direction of propagation of light as seen from the 4D spatial manifold implies that light wavelength will change (red shift) just by geometrical considerations, thus the Hypergeometrical Universe theory provides a geometrical mechanism for Hubble's red shift.

The conclusions in this section are very important because they break the symmetry between dilators and dilators, in the sense that they do not travel at the same speed. On the other hand, this velocity relationship is strictly necessary for the Quantum Lagrangian Principle to make all dilators to surf the surrounding dilaton field, since dilators always see retarded dilaton fields at 45 degrees with respect to R.

THE BEGINNING OF TIMES

At the time of the Big Bang, the Universe is a small macroscopic metric fluctuation in a 4D spatial manifold. We speculate that this moment followed a dimensional transition that made the process entropically irreversible.

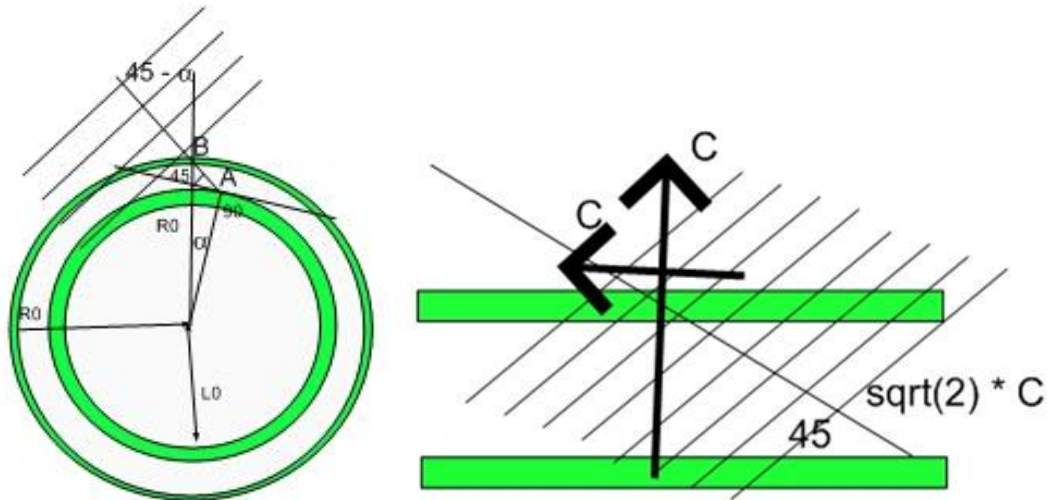

FIGURE 11. Time zero boundary conditions are shown.

In the subsequent instant, the initial metric fluctuation decays into a myriad of smaller metric coherences (dilators) which start to recombine creating Gamma Radiation. The initial burst of Gamma Radiation propels all dilators with the correct spinning phase outwards. This is the synching event that synchronized the spinning of all dilators.

The symmetry of the problem makes radial and tangential degrees of freedom equivalent. Since one would expect equipartition of energy among all degrees of freedom, then one would expect that dilators would be accelerated to the same speed on all directions. Once the Universe is more than a point, the surfing of the retarded dilaton field requires interaction to take place on 45 degrees with respect to the radial direction for the equipartition of energy to take place. This and the first principle derivation of the natural laws of physics are the basis for considering that the initial Universe was accelerated to c at time zero.

Fig. 11 left panel also shows how we peer into the past. Looking at close epochs means looking at a small cosmological angle α where the two near hyperspheres can be approximated by a two hyperplanes. The farther we look, the smaller the hyperspherical Universe was. Light travels at 45 degrees with respect to R from prior epochs. When the inner circle (prior epoch) gets really small, the cosmological angle α moves towards 45 degrees.

QUANTUM GRAVITY AND ELECTROSTATIC INTERACTION

First let's express Gauss law in terms of two interacting bodies of one Kg4D (4D Mass of one Kg) of dilators separated by one meter distance. The reason for expressing Gauss Law in term of 4DMass is to have a term of comparison with Newton's Law, that is, both Gravitational and Electrostatic laws should be measuring the effect of the same number of dilators (1Kg4D of electrons or 1Kg3D of Hydrogen Atoms). Due to Fundamental Dilator Model, electron, positron, antiproton and proton are all equivalent to a Hydrogen atom.

The standard MKS equation for electrostatic force between two one Kg4D bodies of electrons (χ a.m.u. "electrons" or "protons") = x Coulombs, is giving by:

$$F_{Electrostatic} = \frac{1}{4\pi\epsilon_0} \left(\frac{Coulomb}{1meter} \right)^2 \left(\frac{DilatorE}{Coulomb} \right)^2 \left(\frac{1Kg4D}{DilatorE} \right)^2 \left(\frac{Kg4D}{Kg3D} \right)^2 \left(\frac{Kg3D}{Kg3D} \right)^2 = G_{Electrostatic}^{4D} \left(\frac{Kg3D}{meter} \right)^2 \quad (17)$$

Where

Gravitational Fundamental Dilator=DilatorG

Electromagnetic Fundamental Dilator = DilatorE

Kg3D (Kg4D) is one Kg of 3DMass(4DMass)

Electromagnetic Fundamental Dilator 4D Mass= Hydrogen 3DMass= $\chi = 1.00794u$

$$\left(\frac{1Kg4D}{1Kg3D} \right) = \text{Spatial Anisotropy} = \kappa$$

G is the gravitational constant = $6.6720E-11 \text{ m}^3 \cdot \text{Kg}^{-1} \cdot \text{s}^{-2}$

$N = 1Kg4D$ of DilatorE = $0.5Kg3D$ of DilatorG $\cong 1000$ Avogadro's Number/ $\chi = 5.97470265E+26$

dilators per Kg4D.

$$\left(\frac{DilatorE}{Coulomb} \right) = \frac{e}{Coulomb} \quad (18)$$

$$\left(\frac{1Kg4D}{DilatorE} \right) = N = 5.97470265E + 26 \quad (19)$$

$$G_{Electrostatic}^{4D} = \frac{1}{4\pi\epsilon_0} \left(\frac{N}{1Kg3D} \cdot e\kappa \right)^2 = 8.23558E + 25\kappa^2 \quad (20)$$

Similarly Newton's Gravitational Law can be written for 1Kg4D of Gravitational Fundamental Dilators (Hydrogen Atoms).

$$F_{Gravitational} = G \left(\frac{Kg3D}{1meter} \right)^2 \left(\frac{Kg4D}{Kg3D} \right)^2 = G_{Gravitational}^{4D} \left(\frac{Kg3D}{1meter} \right)^2 \quad (21)$$

Resulting:

$$G_{Gravitational}^{4D} = G\kappa^2 = 6.6720E - 11\kappa^2 \quad (22)$$

$N \cong 1000 * \text{Avogadro} / 1 \text{ Kg4D} / \chi = 5.97470265E+23$.

$\lambda_1 \cong h * 1000 * \text{Avogadro} / (1 \text{ Kg4D} * c) / \chi / \kappa = 1.32054E-15 / \kappa$ meters (in the MKS system).

$\lambda_2 = \lambda_{1Kg4D} \cong h / (1Kg4D * c) / \kappa = 2.2102E-42 / \kappa$ meters (in the MKS system). = λ_1 / N

$e = \text{Single electric charge}$ (1.6022E-19 Coulomb).

$\epsilon_0 = \text{permittivity of the vacuum} = 8.8542E-12 \text{ C}^2 \cdot \text{N}^{-1} \cdot \text{m}^{-2}$ (MKS)

Thus

$$\frac{G_{Electrostatic}^{4D}}{G_{Gravitational}^{4D}} = \frac{\frac{1}{4\pi\epsilon_0} \left(\frac{N}{1Kg3D} e\kappa \right)^2}{G\kappa^2} = \frac{8.23558E + 25\kappa^2}{6.6720E - 11\kappa^2} = 1.23435E + 36 \quad (23)$$

To analyze the interaction between a probe dilator and a 1Kg4D body, let's express the dilaton field for a single particle as:

$$\psi_1(x, y, z, \rho, \Phi) = \frac{\cos(\vec{k}_1 \cdot \vec{r})}{1 + P \cdot f(\vec{k}_1, \vec{r} - \vec{r}_0)} \quad (24)$$

where

$$f(\vec{k}_1, \vec{r}) = |\vec{k}_1 \cdot \vec{r}| \quad (25)$$

For $|\vec{k}_1 \cdot \vec{r}| < 2\pi$ we have $f(\vec{k}_1, \vec{r}) = 0$, that is there is not decay within the first cycle

|| means absolute value

P (absolute value of the phase volume) is 3. The meaning of P is that for one de Broglie wavelength traversed path along R by the hyperspherical universe, a propagating spacetime wave spreads along by a factor of $P2\pi$ (6π) due to the number of cross-sections involved.

Similarly, for a 1 Kg4D of DilatorE body located at position \bar{R} :

$$\psi_2(x, y, z, r, \Phi) = \frac{M.N.\cos(\bar{k}_2.(\bar{R}-\bar{r}))}{1+P.f(\bar{k}_2, \bar{R}-\bar{r})} \quad (26)$$

where the effect of the 1 Kg4D mass is implicit in the k_2 -vector and expressed by the factor N. The wave intensity scales up with the number of particles (N). One kilogram of mass has $N=1000/\chi$ moles of χ a.m.u. Fundamental Dilators or $|k_2| = 1000.Avogadro/\chi$. $|k_1|=(N).|k_1|$, where

M=1 for neutral matter-matter, or antimatter-antimatter interactions or opposite charge interactions

M=-1 for same charge or matter-antimatter interactions

To calculate the effect of gravitational/electrostatic attraction, one needs to calculate the displacement on the dilaton field maximum around each particle or body due to interaction with the dilatons generated by the other body.

This is done for the lighter particle, by calculating the derivative of the waveform and considering the extremely fast varying gravitational wave from the macroscopic body always equal to one, since the maxima of these oscillations are too close to each other and can be considered a continuum.

The total waveform is given by:

$$\psi_{total}(x, y, z, r, \Phi) = \frac{\cos(\bar{k}_1.\bar{r})}{1+P.f(\bar{k}_1, \bar{r}-\bar{r}_0)} + \frac{M * N}{1+P.f(\bar{k}_2, \bar{R}-\bar{r})} \quad (27)$$

Why is the lightspeed c the limiting speed in this Universe?

The reason can be seen from equation (27). Taking of the derivative equation (27) with respect to r and equating it to zero, yields:

$$\frac{\bar{k}_1 \sin(\bar{k}_1.\bar{r})}{(1+P.|\bar{k}_1.(\bar{r}-\bar{r}_0)|)} - \frac{\bar{k}_1 \cos(\bar{k}_1.\bar{r})}{(1+P.|\bar{k}_1.(\bar{r}-\bar{r}_0)|)^2} = 0 \quad (28)$$

Notice that the second term was considered saturated, that is, independent upon r.

As interaction increases, r shifts asymptotically to some \bar{r}_0 , that is, $\bar{r} = \bar{r}_0$ is achieved at saturation. The resulting saturation equation states that:

$$\cos(\bar{k}_1.\bar{r}_0) = \sin(\bar{k}_1.\bar{r}_0) \quad (29)$$

This means that the limiting angle of acceleration is 45 degrees or the speed of light. Notice that there was no use of any postulate as in the Theory of Relativity. This speed limit is the direct result of the choice of interaction and the proposed topology.

Equation (27) is the one and only unification equation, that is, it is the four-dimensional wave equation that yields all the forces, when one considers four-dimensional wave constructive interference. It shows that anti-matter will have gravitational repulsion or anti-gravity with respect to normal matter. The derivative for Ψ_1 is given by:

$$\left. \frac{\partial \psi_1(x, y, z, r, \Phi)}{\partial x} \right|_{r=\lambda_1} \cong -k_1^2 r \quad (30)$$

$$\nabla(P.f(\bar{k}_1, \bar{r}-\bar{r}_0)) = 0 \quad \text{due to} \quad \left| \bar{k}_1.(\bar{r}-\bar{r}_0) \right| \ll 2\pi.$$

Similarly

$$\left. \frac{\partial \psi_2(x, y, z, r, \varphi)}{\partial x} \right|_{r=\lambda_1} \cong \frac{NM}{Pk_2.R^2} \quad (31)$$

Solving for x:

$$x = \frac{N}{Pk_1^2 k_2 R^2} = \frac{\lambda_1^2 \lambda_2 N M}{P(2\pi)^3 R^2} \quad (32)$$

There are two regimen of spacetime travel for the probing dilator and they are depicted in Figure 12 below:

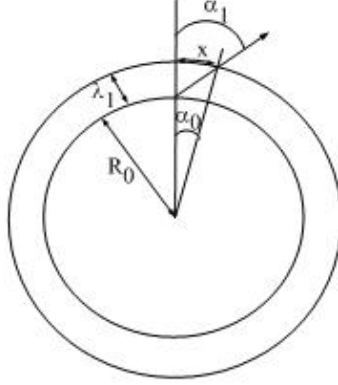

FIGURE 12. This figure shows the geometry of a surface bound particle. This is a X versus R cross-section of the hyperspherical expanding universe. Notice that the two circles represent a one step de Broglie expansion of the hyperspherical universe.

At each de Broglie step both types of particles (zero and non-zero spin) change position by the same amount x and that defines a change in their k -vector direction. The difference is with which referential that change in angle occurs. In the case of volumetric waves (non-zero spin particles), the k -vector is allowed to change by the angle α_1 , while in the case of superficial waves (zero spin particles), the k -vector changes just by the amount given by α_0 since its k -vector has to remain perpendicular to the fabric of space. $\tan(\alpha)$ is given by $\tan(\alpha_1) = x/\lambda_1$ or by $\tan(\alpha_0) = x/\lambda_1 * (\lambda_1/R_0)$ depending upon if the interaction is such that the particle k -vector shifts as in α_1 or it just acquires the radial pointing direction as in α_0 . A further refinement introduced by equation (33) below introduces a level of local deformation of the de Broglie hypersurface or fabric of space. A change in angle α_0 corresponds to a much smaller angle change between the radial directions (by a factor $\lambda_1/R_0 = 6.43E-42$, with R_0 (circa 21.72 billion light-years) as the dimensional age of the Universe). The experimental spacetime torsion due to gravitational interaction lies someplace in between 1 and 10^{-41} , thus showcasing a level of local deformation of the fabric of space. From Fig. 12, one calculates $\tan(\alpha)$ as:

$$\tan(\alpha) = \frac{x}{\lambda_1} \delta = \frac{\lambda_1 \lambda_2 N}{P(2\pi)^3 R^2} \delta \quad (33)$$

Where $6.43E-42 = \frac{\lambda_1}{R_0} \leq \delta \leq 1$ and $M=1$. It will be shown that the upper limit is valid for charged particle

interaction, while the lower limit modified by a slight deformation of the fabric of space will be associated with gravitational interaction. For the case of light, one has:

$$\tan(\alpha_0) = 1 \quad (34)$$

That is, light propagates with proper time projection/propagation direction τ at 45° with respect to the radial direction. To calculate the derivative of $\tan(\alpha)$ with respect to τ , one can use the following relationship:

$$\frac{\partial}{\partial r} \tan(\alpha_0) = \frac{\tan(\alpha_0)}{\lambda_1} = \frac{\lambda_2 N}{P(2\pi)^3 R^2} \delta \quad (35)$$

Acceleration is given by:

$$a = c^2 \frac{\partial}{\partial r} \tan(\alpha_0) = \frac{c^2 \lambda_2 N}{P(2\pi)^3 R^2} \delta \quad (36)$$

To calculate the force between two 1 Kg4D masses separated by one meter distance expressed in terms of Kg3D, one needs to multiply equation (36) by $N(1Kg3D)\kappa^2$ since the acceleration was calculated by a 1Kg4D of DilatorE:

$$F = G_{Calculated}(\delta) \frac{(1Kg3D)^2}{(1meter)^2} = - \frac{c^2 \lambda_2 * N^2 \left(\frac{1Kg4D}{1Kg3D} \right)^2}{P(2\pi)^3 (1Kg3D)} \delta \frac{(1Kg3D)^2}{(1meter)^2} \quad (37)$$

For $\delta=1$ and $P=3$ one obtains the $G_{Electrostatic}$ (20).

$$G_{Calculated}(\delta=1) = \frac{c^2 (N\kappa)^2 \lambda_2}{P(2\pi)^3 (1Kg3D)} = 8.23558E + 25\kappa^2 = G_{Electrostatic}^{4D} \quad (38)$$

With anisotropy given by:

$$\kappa = 1.157055733$$

Remembering of the κ dependence of λ_1 . It is important to notice that in the derivation of the $G_{Calculated}$ never made use of any electrostatic property of vacuum, charge etc. It only mattered the mass (spacetime deformation) and spin. Of course, one used the Planck constant and the speed of light and Avogadro's number. **By setting $\delta=1$ one recovers the electrostatic value of G!**

To analyze gravitational interaction, let's consider our estimate the universe as being around 21.72 Billion Years old or $2.05E+26$ meters radius. To obtain the elasticity coefficient of spacetime, let's rewrite $\delta = (\lambda_1/R_0)\xi$ on equation (36) and equate the $G_{Calculated}$ to $G_{Gravitational}$ for two bodies of 1 Kg3D separated by 1 meter.

$$F = G_{Gravitational}^{4D} \frac{(1Kg3D)^2}{(1meter)^2} = -6.6720 E-11 \kappa^2 \frac{(1Kg3D)^2}{(1meter)^2} = - \frac{c^2 N^2 \lambda_2}{(1Kg3D) P(2\pi)^3 R_0} \lambda_1 \kappa^2 \xi \frac{(1Kg3D)^2}{(1meter)^2} \quad (39)$$

Where $P=3$ since we are considering a spin-zero interaction. Solving for ξ :

$$\xi = \frac{P(2\pi)^3 R_0 G(1Kg3D)}{c^2 N \lambda_1^2} = 1.457645E + 05 \quad (40)$$

If we consider that the force is given by mass times acceleration:

$$F = m_{Mass} a_x = m_{Mass} c^2 \frac{\partial \tan(\theta)}{\partial \lambda} = \frac{m_{Mass} c^2 \lambda_1}{\lambda_1^2 R_0} \xi .x \quad (41)$$

$$F = \frac{m_{Mass} c^2}{\lambda_1 R_0} \xi .x = m_{Mass} \left(2\pi \Omega^G Universe \right)^2 .x \quad (42)$$

The natural frequency of spacetime oscillations is:

$$\Omega^G Universe = \frac{1}{2\pi} \sqrt{\frac{c^2 \xi}{\lambda_1 R_0}} = 37.6 \text{ KHz} \quad (43)$$

Notice that this is not dependent upon any masses. That should be the best frequency to look for or to create gravitational waves. Of course, Hubble red shift considerations should be used to determine the precise frequency from a specific region of the universe. At last one can calculate the value of the vacuum permittivity from equations (20) and (27) as:

$$G_{Calculated}(\delta=1) = \frac{c^2 (N\kappa)^2 \lambda_2}{P(2\pi)^3 (1Kg3D)} \quad (44)$$

$$G_{Electrostatic} = \frac{1}{4\pi\epsilon_0} \left(\frac{N}{1Kg3D} e \right)^2 = \frac{c^2 N^2 \kappa^2 \lambda_2}{P(2\pi)^3 (1Kg3D)} \quad (45)$$

$$\varepsilon_0 = \frac{6\pi^2 e^2}{(1Kg3D)c^2 \lambda_2} = 8.85418782E-12 \quad (46)$$

Not surprisingly, there is a perfect match between theoretical and experimental (8.85418782E-12 C².N⁻¹.m⁻²) values. The Space Anisotropy coefficient κ was derived to make this identity true. It is important to notice that this derivation don't use any parameterization. The Space Anisotropy coefficient κ and the "FS elasticity ξ " are predictions of the theory, which uses only electron charge, speed of light, Avogadro's number and Planck's constant to relate it to non-hypergeometrical physics.

The complete gravitation equation is given by:

$$F_{Gravitational} = \left[\frac{c^2 N^2 \lambda_2}{P(2\pi)^3 (1Kg3D)} \kappa^2 \frac{\lambda_1}{R_0} \xi \right] \frac{m_1 m_2}{R^2} \quad (47)$$

Quantum aspects can be recovered by not using fast oscillation approximations. It is also important to notice that equations (26) and (27) can be used to calculate the interaction between any particles (matter or anti-matter) or to perform quantum mechanical calculations in a manner similar to molecular dynamic simulations. The quantum character is implicit in the de Broglie wavelength stepwise quantization. It is also relativistic in essence, as it will become clear when one analyzes magnetism next.

MAGNETIC INTERACTION

The Derivation of the Biot-Savart Law

Let's consider two wires with currents i_1 and i_2 separated by a distance R . Let's consider i_2 on the element of length dl_2 as the result of a moving charge of mass of $1Kg4D$ of electromagnetic fundamental dilators. This is done to obtain the correct scaling factor.

Without loss of generality, let's consider that the distance between the two elements of current is given by:

$$\vec{R} = \frac{R}{\sqrt{3}} \begin{pmatrix} 1 \\ 1 \\ 1 \\ 0 \\ 0 \end{pmatrix} = R\hat{I} \quad \text{and} \quad \vec{r}_0 = \begin{pmatrix} 0 \\ 0 \\ 0 \\ 0 \\ 0 \end{pmatrix} \quad (48)$$

The velocities are:

$$\vec{V}_1 = v_1 \begin{pmatrix} \alpha_1 \\ \beta_1 \\ \gamma_1 \\ 0 \\ 0 \end{pmatrix} \quad \text{and} \quad \vec{V}_2 = v_2 \begin{pmatrix} \alpha_2 \\ \beta_2 \\ \gamma_2 \\ 0 \\ 0 \end{pmatrix} \quad (49)$$

Due to the spin half, one has after a two de Broglie cycles:

$$\vec{r} = \begin{pmatrix} \frac{r}{\sqrt{3}} \cdot (1 + \frac{v_2}{c} \alpha_2 \sqrt{3}) \\ \frac{r}{\sqrt{3}} \cdot (1 + \frac{v_2}{c} \beta_2 \sqrt{3}) \\ \frac{r}{\sqrt{3}} \cdot (1 + \frac{v_2}{c} \gamma_2 \sqrt{3}) \\ 2\lambda_1 \\ 2\lambda_1 \end{pmatrix} \quad \text{and} \quad \vec{R} = \begin{pmatrix} \frac{R}{\sqrt{3}} \\ \frac{R}{\sqrt{3}} \\ \frac{R}{\sqrt{3}} \\ 2\lambda_1 \\ 2\lambda_1 \end{pmatrix} \quad \text{and} \quad \vec{r}_0 = \begin{pmatrix} 0 \\ 0 \\ 0 \\ 2\lambda_1 \\ 2\lambda_1 \end{pmatrix} \quad (50)$$

Since one expects that the motion of particle 2 will produce a drag on the particle 1 along particle 2 direction of motion.

The figure below showcase the geometry associated with these two currents.

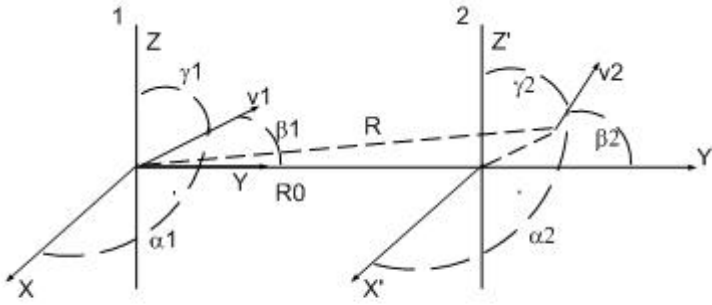

FIGURE 13. Derivation of Biot-Savart law using spacetime waves.

Notice also that the effect of the $\frac{1}{2}$ spin is to slow down the rate of phase variation along the dimensional time τ in half.

In the case of currents, the velocities are not relativistic and one can make the following approximations to the five-dimensional rotation matrix or metric: $\cosh(\alpha) \cong 1$ and $\sinh(\alpha_i) \cong v_i/c$ where v_i is the velocity along the axis i .

The k-vectors for the two electrons on the static reference frame are given by:

$$\vec{k}_1 \cong \frac{2\pi}{\lambda_1} \begin{bmatrix} \frac{1}{\sqrt{3}} & \frac{1}{\sqrt{3}} & \frac{1}{\sqrt{3}} & -1 & \frac{1}{2} \end{bmatrix} \begin{bmatrix} 1 & 0 & 0 & -\alpha_1 \frac{v_1}{c} & 0 \\ 0 & 1 & 0 & -\beta_1 \frac{v_1}{c} & 0 \\ 0 & 0 & 1 & -\gamma_1 \frac{v_1}{c} & 0 \\ -\alpha_1 \frac{v_1}{c} & -\beta_1 \frac{v_1}{c} & -\gamma_1 \frac{v_1}{c} & -1 & 0 \\ 0 & 0 & 0 & 0 & -1 \end{bmatrix} \quad (51)$$

$$\vec{k}_1 \cong \frac{2\pi}{\lambda_1} \begin{bmatrix} \left(\frac{1}{\sqrt{3}} + \alpha_1 \frac{v_1}{c} \right) & \left(\frac{1}{\sqrt{3}} + \beta_1 \frac{v_1}{c} \right) & \left(\frac{1}{\sqrt{3}} + \gamma_1 \frac{v_1}{c} \right) & \left(-\left(\alpha_1 \frac{v_1}{c} + \beta_1 \frac{v_1}{c} + \gamma_1 \frac{v_1}{c} \right) - 1 \right) & \left(-\frac{1}{2} \right) \end{bmatrix} \quad (52)$$

Similarly:

$$\bar{k}_2 \cong \frac{2\pi}{\lambda_2} \left[\left(\frac{1}{\sqrt{3}} + \alpha_2 \frac{v_2}{c} \right) \left(\frac{1}{\sqrt{3}} + \beta_2 \frac{v_2}{c} \right) \left(\frac{1}{\sqrt{3}} + \gamma_2 \frac{v_2}{c} \right) \left(-\alpha_2 \frac{v_2}{c} - \beta_2 \frac{v_2}{c} - \gamma_2 \frac{v_2}{c} - 1 \right) \left(-\frac{1}{2} \right) \right] \quad (53)$$

The wave intensities at \bar{r} are:

$$\psi_1(x, y, z, r, \Phi) = \frac{\cos(\bar{k}_1 \cdot \bar{r})}{1 + P \cdot f(\bar{k}_1, \bar{r} - \bar{r}_0)} \quad (54)$$

$$\psi_2(x, y, z, r, \Phi) = \frac{N \cdot \cos(\bar{k}_2 \cdot (\bar{R} - \bar{r}))}{1 + P \cdot f(\bar{k}_2, \bar{R} - \bar{r})} \quad (55)$$

Where $N = 1000$ Avogadro/ χ , $\lambda_1 =$ de Broglie wavelength of a χ a.m.u (atomic mass unit) particle/ κ , $\lambda_2 =$ de Broglie wavelength of a 1Kg4D particle = λ_1/N .

Now one can calculate:

$$\begin{aligned} & \bar{k}_1 \cdot (\bar{r} - \bar{r}_0) \cong \\ & \cong \frac{2\pi}{\lambda_1} \left[\left(\frac{1}{\sqrt{3}} + \alpha_1 \frac{v_1}{c} \right) \left(\frac{1}{\sqrt{3}} + \beta_1 \frac{v_1}{c} \right) \left(\frac{1}{\sqrt{3}} + \gamma_1 \frac{v_1}{c} \right) \left(-\left(\alpha_1 \frac{v_1}{c} + \beta_1 \frac{v_1}{c} + \gamma_1 \frac{v_1}{c} \right) - 1 \right) \left(-\frac{1}{2} \right) \right] \begin{pmatrix} \frac{r}{\sqrt{3}} \cdot \left(1 + \frac{v_2}{c} \alpha_2 \sqrt{3} \right) \\ \frac{r}{\sqrt{3}} \cdot \left(1 + \frac{v_2}{c} \beta_2 \sqrt{3} \right) \\ \frac{r}{\sqrt{3}} \cdot \left(1 + \frac{v_2}{c} \gamma_2 \sqrt{3} \right) \\ 0 \\ 0 \end{pmatrix} \quad (56) \end{aligned}$$

$$\bar{k}_1 \cdot \bar{r} \cong \frac{2\pi r}{\lambda_1} \left(1 + \frac{\bar{V}_1 \cdot \hat{R}}{c} + \frac{\bar{V}_2 \cdot \hat{R}}{c} + \frac{\bar{V}_1 \cdot \bar{V}_2}{c^2} \right) + 2\pi \quad (57)$$

$$\nabla(\bar{k}_1 \cdot (\bar{r} - \bar{r}_0)) = \nabla(\bar{k}_1 \cdot \bar{r}) \cong \frac{2\pi}{\lambda_1} \left(1 + \frac{\bar{V}_1 \cdot \hat{R}}{c} + \frac{\bar{V}_2 \cdot \hat{R}}{c} + \frac{\bar{V}_1 \cdot \bar{V}_2}{c^2} \right) \hat{R} \quad (58)$$

$$\nabla(P \cdot f(\bar{k}_1, \bar{r} - \bar{r}_0)) \cong 0 \quad \text{due to} \quad \left| \bar{k}_1 \cdot (\bar{r} - \bar{r}_0) \right| \ll 2\pi. \quad (59)$$

Similarly:

$$\begin{aligned} & \bar{k}_2 \cdot (\bar{R} - \bar{r}) \cong \\ & \cong \frac{2\pi}{\lambda_2} \left[\left(\frac{1}{\sqrt{3}} + \alpha_2 \frac{v_2}{c} \right) \left(\frac{1}{\sqrt{3}} + \beta_2 \frac{v_2}{c} \right) \left(\frac{1}{\sqrt{3}} + \gamma_2 \frac{v_2}{c} \right) \left(-\alpha_2 \frac{v_2}{c} - \beta_2 \frac{v_2}{c} - \gamma_2 \frac{v_2}{c} - 1 \right) \left(-\frac{1}{2} \right) \right] \begin{pmatrix} \frac{R}{\sqrt{3}} - \frac{r}{\sqrt{3}} \cdot \left(1 + \frac{v_2}{c} \alpha_2 \sqrt{3} \right) \\ \frac{R}{\sqrt{3}} - \frac{r}{\sqrt{3}} \cdot \left(1 + \frac{v_2}{c} \beta_2 \sqrt{3} \right) \\ \frac{R}{\sqrt{3}} - \frac{r}{\sqrt{3}} \cdot \left(1 + \frac{v_2}{c} \gamma_2 \sqrt{3} \right) \\ 0 \\ 0 \end{pmatrix} \\ & \cong \frac{2\pi R}{\lambda_2} \left(1 + \frac{\bar{V}_2 \cdot \hat{R}}{c} \right) \quad (60) \end{aligned}$$

$$\nabla(f(\bar{k}_2, \bar{R}-\bar{r})) \cong$$

$$\cong \frac{2\pi}{\lambda_2} \left[\left(\frac{1}{\sqrt{3}} + \alpha_2 \frac{v_2}{c} \right) \left(\frac{1}{\sqrt{3}} + \beta_2 \frac{v_2}{c} \right) \left(\frac{1}{\sqrt{3}} + \gamma_2 \frac{v_2}{c} \right) \left(-\alpha_2 \frac{v_2}{c} - \beta_2 \frac{v_2}{c} - \gamma_2 \frac{v_2}{c} - 1 \right) \left(-\frac{1}{2} \right) \right] \begin{pmatrix} -\frac{1}{\sqrt{3}} \cdot (1 + \frac{v_2}{c} \alpha_2 \sqrt{3}) \\ -\frac{1}{\sqrt{3}} \cdot (1 + \frac{v_2}{c} \beta_2 \sqrt{3}) \\ -\frac{1}{\sqrt{3}} \cdot (1 + \frac{v_2}{c} \gamma_2 \sqrt{3}) \\ 0 \\ 0 \end{pmatrix} \quad (61)$$

$$\nabla(f(\bar{k}_2, \bar{R}-\bar{r})) \cong -\frac{2\pi}{\lambda_2} \left(1 + \frac{\bar{V}_2 \cdot \hat{R}}{c} \right) \hat{R} \quad (62)$$

Hence:

$$\nabla \psi_1(x, y, z, r, \Phi) \cong -\frac{\nabla(\bar{k}_1 \cdot \bar{r})}{1 + P \cdot f(\bar{k}_1, \bar{r} - \bar{r}_0)} \sin(\bar{k}_1 \cdot \bar{r}) \quad (63)$$

$$\nabla \psi_1(x, y, z, r, \Phi) \cong -\left(\frac{2\pi}{\lambda_1} \right)^2 \left(1 + \frac{\bar{V}_1 \cdot \hat{R}}{c} + \frac{\bar{V}_2 \cdot \hat{R}}{c} + \frac{\bar{V}_1 \cdot \bar{V}_2}{c^2} \right)^2 r \hat{R} \quad (64)$$

And

$$\nabla \psi_2(\bar{r}, r, \Phi) \cong -\frac{NP \nabla(f(\bar{k}_2, \bar{R}-\bar{r}))}{(1 + P \cdot f(\bar{k}_2, \bar{R}-\bar{r}))^2} = -\frac{N}{P \frac{2\pi}{\lambda_2} \left(1 + \frac{\bar{V}_2 \cdot \hat{R}}{c} \right)} \frac{\hat{R}}{R^2} \cong -\left(\frac{N \lambda_2}{2\pi P} \right) \left(1 - \frac{\bar{V}_2 \cdot \hat{R}}{c} \right) \frac{\hat{R}}{R^2} \quad (65)$$

Thus,

$$r \cong -\frac{\left(\frac{N \lambda_2}{2\pi P} \right) \left(1 - \frac{\bar{V}_2 \cdot \hat{R}}{c} \right) \frac{\hat{R}}{R^2}}{\left(\frac{2\pi}{\lambda_1} \right)^2 \left(1 + \frac{\bar{V}_1 \cdot \hat{R}}{c} + \frac{\bar{V}_2 \cdot \hat{R}}{c} + \frac{\bar{V}_1 \cdot \bar{V}_2}{c^2} \right)^2} \cong -\left(N \lambda_1^2 \lambda_2 \right) \frac{\left(1 - \frac{\bar{V}_2 \cdot \hat{R}}{c} \right) \left(\hat{R} \cdot \hat{R} - 2 \frac{\bar{V}_1 \cdot \hat{R}}{c} - 2 \frac{\bar{V}_2 \cdot \hat{R}}{c} - 2 \frac{\bar{V}_1 \cdot \bar{V}_2}{c^2} \right)}{(2\pi)^3 P} \frac{\hat{R}}{R^2} \quad (66)$$

$$r_{ee} \cong -\left(N \lambda_1^2 \lambda_2 \right) \frac{\left(\hat{R} \cdot \hat{R} - 2 \frac{\bar{V}_1 \cdot \hat{R}}{c} - 2 \frac{\bar{V}_2 \cdot \hat{R}}{c} - 2 \frac{\bar{V}_1 \cdot \bar{V}_2}{c^2} - 2 \frac{\bar{V}_2 \cdot \hat{R}}{c} + 2 \left(\frac{\bar{V}_1 \cdot \hat{R}}{c} \right) \left(\frac{\bar{V}_2 \cdot \hat{R}}{c} \right) + 2 \left(\frac{\bar{V}_2 \cdot \hat{R}}{c} \right) \left(\frac{\bar{V}_2 \cdot \hat{R}}{c} \right) + 2 \left(\frac{\bar{V}_1 \cdot \bar{V}_2}{c^2} \right) \left(\frac{\bar{V}_2 \cdot \hat{R}}{c} \right) \right)}{(2\pi)^3 P} \frac{\hat{R}}{R^2} \quad (67)$$

$$r_{ep} \cong +\left(N \lambda_1^2 \lambda_2 \right) \frac{\left(\hat{R} \cdot \hat{R} - 2 \frac{\bar{V}_1 \cdot \hat{R}}{c} \right)}{(2\pi)^3 P} \frac{\hat{R}}{R^2} \quad \text{since } v_2=0 \quad (68)$$

$$r_{pe} \cong \left(N\lambda_1^2\lambda_2 \right) \frac{\left(\hat{R}\cdot\hat{R} - 2\frac{\vec{V}_2\cdot\hat{R}}{c} - 2\frac{\vec{V}_2\cdot\hat{R}}{c} + 2\left(\frac{\vec{V}_2\cdot\hat{R}}{c}\right)\left(\frac{\vec{V}_2\cdot\hat{R}}{c}\right) \right)}{(2\pi)^3 P} \frac{\hat{R}}{R^2} \quad \text{since } v_1=0 \quad (69)$$

$$r_{pp} \cong -\left(N\lambda_1^2\lambda_2 \right) \frac{(\hat{R}\cdot\hat{R})}{(2\pi)^3 P} \frac{\hat{R}}{R^2} \quad \text{since } v_1=v_2=0 \quad (70)$$

$$r_{total} \cong r_{ee} + r_{ep} + r_{pe} + r_{pp} = -\left(N\lambda_1^2\lambda_2 \right) \frac{\left(2\left(\frac{\vec{V}_1\cdot\hat{R}}{c}\right)\left(\frac{\vec{V}_2\cdot\hat{R}}{c}\right) - 2\left(\frac{\vec{V}_1\cdot\vec{V}_2}{c^2}\right)\left(1 - \left(\frac{\vec{V}_2\cdot\hat{R}}{c}\right)\right) \right)}{(2\pi)^3 P} \frac{\hat{R}}{R^2} \quad (71)$$

Where p stands for proton and e for electron.

$$r \cong -\left(N\lambda_1^2\lambda_2 \right) \frac{\left(-2\frac{\vec{V}_1\cdot\vec{V}_2}{c^2} + 2\left(\frac{\vec{V}_1\cdot\hat{R}}{c}\right)\left(\frac{\vec{V}_2\cdot\hat{R}}{c}\right) \right)}{(2\pi)^3 P} \frac{\hat{R}}{R^2} \quad (68)$$

Here we introduce the correction to the 5D speed of light. From the Pioneer Anomaly analysis, $c \rightarrow c\sqrt{2}$ yielding:

$$r \cong \left(N\lambda_1^2\lambda_2 \right) \frac{\left(\left[\vec{V}_1 \otimes (\vec{V}_2 \otimes \hat{R}) \right] \cdot \hat{R} \right)}{(2\pi)^3 P c^2} \frac{\hat{R}}{R^2} \quad (69)$$

Where non-velocity dependent and single velocity dependent contributions were neglected due to the counterbalancing wave contributions from static positively charged centers.

The force between two 1 Kg4D dilators is given by:

$$\vec{F} = N * (1Kg3D)\kappa^2 c^2 \frac{\partial \tan(\alpha)}{\partial r} = N\kappa^2 (1Kg3D)c^2 \frac{r}{\lambda_1^2} = N^2\kappa^2 (1Kg3D) \frac{\lambda_2}{(2\pi)^3 P} \left(\left[\vec{V}_1 \otimes (\vec{V}_2 \otimes \hat{R}) \right] \cdot \hat{R} \right) \frac{\vec{R}}{R^3} \quad (70)$$

To scale this force into the force between two Coulomb charges traveling with velocities v_1 and v_2 one just have to multiply the equation by $(1C/Nek)^2$:

$$\vec{F} = \left(\frac{1C}{eN\kappa} \right)^2 \frac{N^2\kappa^2 (1Kg3D)\lambda_2 v_1 v_2}{(2\pi)^3 P} \left(\left[d\hat{l}_1 \otimes (d\hat{l}_2 \otimes \hat{R}) \right] \cdot \hat{R} \right) \frac{\vec{R}}{R^3} \quad (71)$$

Where one took into consideration that a particle with spin half has a cycle of $2\lambda_1$ instead of λ_1 .

The Biot-Savart law can be written as:

$$d\vec{F} = \frac{\mu_0 I_1 I_2}{4\pi} \frac{(d\vec{l}_1 \cdot d\vec{l}_2) \vec{x}_{12}}{|\vec{x}_{12}|^3} \quad (72)$$

Comparing the two equations one obtains:

$$\frac{\mu_0}{4\pi} = \frac{(1Kg3D)\lambda_2}{(2\pi)^3 e^2 P} \quad (73)$$

Thus

$$\mu_0 = 1Kg3D \frac{\lambda_2}{2\pi^2 e^2 P} \quad (74)$$

From equation (45)

$$\varepsilon_0 = \frac{2P\pi^2 Ne^2}{(1Kg3D)c^2 \lambda_1} \quad (75)$$

Thus

$$\mu_0 \cdot \varepsilon_0 = \frac{\lambda_2 (1Kg3D)}{2P\pi^2 e^2} \frac{2P\pi^2 Ne^2}{c^2 \lambda_1 (1Kg3D)} = \frac{1}{c^2} \quad (76)$$

Thus one recovers the relationship between μ_0 and ε_0 .

We recovered the Biot-Savart law for infinitesimal elements of current. This was achieved by considering the many contributions of positive and negative center charges and using the low velocity approximation. Within a Tokamak Nuclear Fusion device, currents are both positive and negative (hot plasma) and velocities are relativistic. Under these conditions one should use the non-approximated equation derived from equation (62):

$$r \cong - \frac{\left(\frac{N\lambda_2}{2\pi P} \right) \left(1 - \frac{\vec{V}_2 \cdot \hat{R}}{c} \right) \frac{\hat{R}}{R^2}}{\left(\frac{2\pi}{\lambda_1} \right)^2 \left(1 + \frac{\vec{V}_1 \cdot \hat{R}}{c} + \frac{\vec{V}_2 \cdot \hat{R}}{c} + \frac{\vec{V}_1 \cdot \vec{V}_2}{c^2} \right)^2} \cong \left(\frac{\lambda_1^3}{P(2\pi)^3} \right) \frac{\left(1 - \frac{\vec{V}_2 \cdot \hat{R}}{c} \right)}{\left(1 + \frac{\vec{V}_1 \cdot \hat{R}}{c} + \frac{\vec{V}_2 \cdot \hat{R}}{c} + \frac{\vec{V}_1 \cdot \vec{V}_2}{c^2} \right)^2} \frac{\hat{R}}{R^2} \quad (77)$$

The force between two 1 Kg4D dilators is given by:

$$\bar{F} = (1Kg3D) \kappa^2 Nc^2 \frac{\partial \tan(\alpha)}{\partial r} = (1Kg3D) \kappa^2 Nc^2 \frac{r}{\lambda_1^2} = (1Kg3D) \kappa^2 c^2 \left(\frac{N\lambda_1}{P(2\pi)^3} \right) \frac{\left(1 - \frac{\vec{V}_2 \cdot \hat{R}}{c} \right)}{\left(1 + \frac{\vec{V}_1 \cdot \hat{R}}{c} + \frac{\vec{V}_2 \cdot \hat{R}}{c} + \frac{\vec{V}_1 \cdot \vec{V}_2}{c^2} \right)^2} \frac{\hat{R}}{R^2} \quad (78)$$

To scale this force into the force between two Coulomb charges traveling with velocities v_1 and v_2 one just have to multiply the equation by $(1C/Nc\kappa)^2$:

$$\bar{F}_1 = \frac{\mu_0 c^2 C_1 C_2}{4\pi} \frac{\left(1 - \frac{\vec{V}_2 \cdot \hat{R}}{c} \right)}{\left(1 + \frac{\vec{V}_1 \cdot \hat{R}}{c} + \frac{\vec{V}_2 \cdot \hat{R}}{c} + \frac{\vec{V}_1 \cdot \vec{V}_2}{c^2} \right)^2} \frac{\hat{R}}{R^2} \quad (79)$$

Or

$$\bar{F}_1 = \frac{C_1 C_2}{4\pi \varepsilon_0} \frac{\left(1 - \frac{\vec{V}_2 \cdot \hat{R}}{c} \right)}{\left(1 + \frac{\vec{V}_1 \cdot \hat{R}}{c} + \frac{\vec{V}_2 \cdot \hat{R}}{c} + \frac{\vec{V}_1 \cdot \vec{V}_2}{c^2} \right)^2} \frac{\hat{R}}{R^2} \quad (80)$$

Where C_1 and C_2 are the charges traveling at V_1 and V_2 and c is the speed of light.

GYROGRAVITATION-ELECTROMAGNETISM UNIFICATION

Similarly one can derive the Gravitational Biot-Savart equation by simple analogy to our derivation of the Gravitation Law.

The limit with zero velocity independent term corresponds to the steady state gravitational field (Newton's Law).

$$F_{Gravitational} = \left[\frac{c^2 N \lambda_1}{(1Kg3D)P(2\pi)^3 R_0} \frac{\lambda_1}{R_0} \xi \right] \frac{m_1 m_2}{R^2} = G \frac{m_1 m_2}{R^2} \quad (81)$$

Notice that the value of the Gravitational Constant G is inversely proportional to the 4D Radius of the Universe R_0 . This means that at earlier epochs, Gravitation was stronger and at a precise time in the life of the Universe all forces had the same strength. It also means that Stellar Candles would contain smaller masses in the past than they do at later epochs. This means that current measurements of distances across the Universe based upon Stellar Candles might not work properly and indicate unreasonable large distance incompatible with the age of the Universe.

For non-zero relative speed, we obtain the Hypergeometrical Universe Law of Gravitation:

$$\vec{F}_1 = Gm_1 m_2 \frac{\hat{R}}{R^2} \left(\frac{\left(1 - \frac{\vec{v}_2 \cdot \hat{R}}{c} \right)}{\left(1 + \frac{\vec{v}_1 \cdot \hat{R}}{c} + \frac{\vec{v}_2 \cdot \hat{R}}{c} + \frac{\vec{v}_1 \cdot \vec{v}_2}{c^2} \right)^2} \right) \quad (82)$$

Equations (79-80) express the force for two elements of charge in motion. They recover Gauss Law under conditions of rest and have identical form as equation (81). This means that a single equation describes everything we know about electrostatics, electromagnetism and gravitation.

The Force derivation uses a boundary condition where the dilator is at rest with respect to the FS. This is equivalent to say that all forces are partial derivatives with respect to R while keeping velocity constant. This is important since the force is velocity dependent. To obtain a potential from which one can calculate dynamics, one need to integrate the equation (81) with respect to R.

$$V_2(R, \vec{v}_1, \vec{v}_2) = Gm_1 m_2 \frac{1}{R} \left(\frac{\left(1 - \frac{\vec{v}_1 \cdot \hat{R}}{c} \right)}{\left(1 + \frac{\vec{v}_1 \cdot \hat{R}}{c} + \frac{\vec{v}_2 \cdot \hat{R}}{c} + \frac{\vec{v}_1 \cdot \vec{v}_2}{c^2} \right)^2} \right) \quad (83)$$

This potential can be used in calculating the equations of motion of Mercury around the Sun for instance.

From equation (47) it is clear that R points from position 1 to position 2, F_1 is force acting upon body 1 under the influence of body 2. There is an inherent asymmetry due to the usage of a third inertial reference frame which is inertial. Any reference frame based upon either body would be non-inertial. This equation was derived under the regimen of weak (normal) gravitational pull. It would be easy to derive the same equation for conditions in the surroundings of a Black Hole. One would just not use the derivative approximations.

This means that there is AntiGravity (weakening of Gravitation) right within the Law of Gravitation. If for a moment one sets the referential frame on body 1, thus having $v_1=0$, the Gravitational Force on F_2 becomes:

$$\vec{F}_2 = Gm_1 m_2 \frac{\hat{R}}{R^2} \frac{1}{\left(1 + \frac{\vec{v}_2 \cdot \hat{R}}{c} \right)^2} \approx Gm_1 m_2 \frac{\hat{R}}{R^2} \left(1 - 2 \frac{\vec{v}_2 \cdot \hat{R}}{c} \right) \quad (84)$$

This is a much more complex view of Gravitation and it is a view derived from a more fundamental model. It reduces to Newton's Law at zero relative velocity.

This equation is likely to explain jets emanating from Black Holes since it shows that as the Black Hole pulls matter inwards it suffer a stronger pull than when it tries to slow down that same matter. This should be expected since the maximum inward speed is the speed of light. This asymmetric pull makes the Black Hole capable of propelling itself forward by asymmetric acceleration of the matter in front of it. In the case of a symmetric distribution of matter, one would expect double jets.

PRECESSION OF MERCURY PERIHELION

Let's consider equation (80) with $V_1=0$, that is, body 1 is not rotating. The new potential is given by:

$$V_2(R, V_2) = Gm_1m_2 \frac{1}{R \left(1 + \frac{\vec{V}_2 \cdot \hat{R}}{c} \right)^2} = Gm_1m_2 \frac{1}{R \left(1 - \frac{1}{c} \frac{dR}{dt} \right)^2} \quad (85)$$

This is the Gerber's potential [5,6] which correctly predicts the precession of Mercury perihelion (42.3 arc seconds per century).

GRAVITATIONAL LENSING

To calculate Gravitational Lensing one has to remember that Electromagnetic Waves are modeled as source-position modulated dilaton fields, that is, EM are dilaton fields (extremely small wavelength = Compton wavelength of a hydrogen atom) modulated by the motion of the dilators that create them. Of course, dilators slow motion yields much larger wavelengths consistent with the electromagnetic waves they generate.

To obtain the predictions of the Hypergeometrical Model for the gravitational refraction of an electromagnetic wave, one has to remember that a Force is represented as a Stress in this model. Acceleration is modeled as a local deformation of the Fabric of Space. This is shown in the equation below:

$$F = m_0 c^2 \frac{d \tanh(\alpha_\tau)}{d\tau} = c \frac{dm_0 v}{d\tau} = c \frac{d(\hbar k)}{d\tau} = \hbar c \frac{\Delta k}{\Delta \tau} \quad (86)$$

Where $d\tau$ is equal to cdt , that is, it is a dimensionalized time. The momentum of an electromagnetic wave was represented by $\hbar k$ and its mass by this equation:

$$m = \frac{\hbar k}{c} \quad (87)$$

Light always travels at 45 degrees with respect to the Fabric of Space. This means that Gravitation only affects the direction of propagation within the Fabric of Space. That cross-section is shown below:

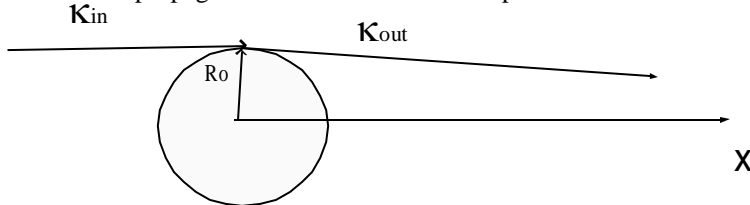

FIGURE 14. Gravitational induced scattering due to Gravitational Force acting upon a photon.

At the position of scattering $R=R_0$, $dR/dt=0$ since one cannot increase the speed of light nor decrease it. One can only change its direction within the 3D hypersphere.

The change in direction is shown in the diagram below:

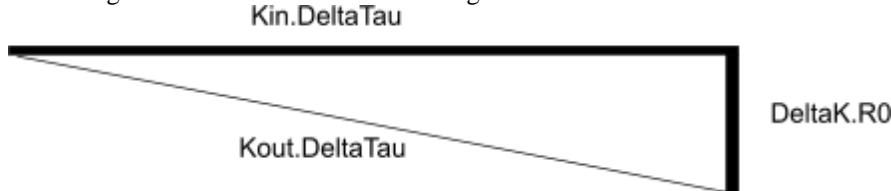

FIGURE 15. Phasematching condition on Gravitational Lensing event.

$\Delta\tau$ is the de Broglie step in the Hypergeometrical Expansion of the Universe. The angle is given by:

$$\alpha = \frac{\Delta k R_0}{k \Delta \tau} \quad (88)$$

The Force can be written in terms of Gravitational fields as:

$$F_2(R, \vec{V}_2) = -Gm_1m_2 \frac{\hat{R}}{R^2} \quad (89)$$

The equation of motion for an electromagnetic wave is given by:

$$F = \hbar c \frac{\Delta k \hat{R}}{\Delta \tau} = -GMm \frac{\hat{R}}{R^2} = -GM \frac{\hbar k}{c} \frac{\hat{R}}{R^2} \quad (90)$$

From our equation of motion, we obtain:

$$\alpha = \frac{\Delta k R_0}{k \Delta \tau} = \frac{GM}{c^2 R_0} \quad (91)$$

Which is the observed Gravitational Lensing.

SUPERLUMINAL NEUTRINOS

The latest research results from CERN indicates a possibility that neutrinos travel faster than the speed of light. To understand how the Hypergeometrical Universe Theory is compatible with this result, one has to review how the theory models light and electron neutrinos.

What is light?

Electromagnetic interaction (Light) was derived just from the dilaton field as the source moved. This means that Light in the Hypergeometrical Universe Theory is just the positional modulation of the dilaton field source. That motion and its momentum is passed by through the rule of motion (Quantum Lagrangian Principle). As motion takes place, the dilaton field itself is Doppler shifted, changing the perceived dilaton wavelength. This Doppler shift is due to the intersection of the four-dimensional dilaton field with our tridimensional shockwave hyperspherical universe changes depending upon the orientation of the k-vector of the dilaton field. Motion changes the local fabric of space orientation and the k-vector is perpendicular to the fabric of space where the dilator sits at each de Broglie step of the Universe expansion.

In summary, light is a volumetric, propagating deformation of the space in which all the four dimensions are expanded or contracted in phase with amplitudes corresponding to the stationary state of the coherence at any given time. In the electromagnetic interaction, the source of the dilaton field is in motion with respect to the probing dilator.

What is an Electron Neutrino?

As stated on the model for the Neutron presented before, the electron neutrino corresponds to a subcoherence between states $(2/3, 2/3, -1/3)$ and $(2/3, -1/3, 2/3)$. This is equivalent to the shrinking of the local metric along axis Y and simultaneous expansion of the same metric along the Z axis. This forms the basis for the assignment of the electron neutrino as an asymmetric dilaton field when free. The difference in dilaton frequency and nature (symmetric for light versus asymmetric for the electron neutrino) forms the basis for my explanation on why an electron neutrino would have a different speed than light. In this case, the asymmetric dilaton mode with higher frequency has a higher speed than the symmetric dilaton mode (light).

GRAND UNIFICATION SUPERSYMMETRY

As the dimensional age of the universe becomes smaller, the relative strength of gravitation interaction increases. Conversely, one expects that as the universe expands gravity will become weaker and weaker. This and the four-dimensional light speed expanding hyperspherical universe topology explain the acceleration of expansion without the need of anti-gravitational dark matter.

For gravitation the spring coefficient is given by:

$$F = m_{neutron} * a_x = m_{neutron} c^2 \frac{\partial \tan(\theta)}{\partial \lambda} = \frac{m_{neutron} c^2}{\lambda_1^2} \xi \frac{\lambda_1}{R_0} = \frac{m_{neutron} c^2}{\lambda_1^2} \frac{14.57E4 \lambda_1}{R_0} x = \kappa_g x \quad (92)$$

Similarly for electrostatic interaction, one has:

$$F = m_{neutron} * a_x = m_{neutron} c^2 \frac{\partial \tan(\theta)}{\partial \lambda} = \frac{m_{neutron} c^2}{\lambda_1^2} x = \kappa_e x \quad (93)$$

Thus

$$\frac{\kappa_g}{\kappa_e} = \frac{14.57E4 \lambda_1}{R_0} \quad (94)$$

Thus when R_0 was smaller than $14.57 \cdot 10^4$ times λ_1 (at $6.40E-19$ s into the Universe life), gravitational and electromagnetic interactions had equal strength. They were certainly indistinguishable when the radius of the universe was one de Broglie wavelength long. This section is called Grand unification supersymmetry, because condition in equation (94) plays the role of the envisioned group theoretical supersymmetry of the grand unification force. Of course, it has a geometrical interpretation. At that exact radius, an elastic spring constant of the fabric of space allows for a change in the local normal such that it is parallel to the redirection of k-vector of a freely moving dilator.

CONCLUSIONS

The Hypergeometrical Universe Model provides alternative views on matter and forces by changing the paradigm under which to describe events. The model provides an alternative Standard Model, Cosmology, Cosmogenezys while maintaining compatibility with Relativity and Quantum Mechanics.

The Fundamental Dilator together with the LightSpeed Expanding Universe and the Quantum Lagrangian Principle provides the basis for Quantum Mechanics.

New Cosmology provides simple explanation for Hubble Expansion, Stellar Candles, and Cosmic Microwave Background. It also provides a new estimate for the age of the Universe (**21.72 billion years old**), Natural Frequency of Gravitational Waves (37.02 KHz), a new estimate of the real velocity of light ($\sqrt{2}c$). The observed velocity of light is c as usual.

Using the Quantum Lagrangian Principle to model dynamics naturally bring about the observed speed of light as being the maximum speed in this Universe. It also explains the reason for increased inertial mass and the slowing down of time with speed (increase twisting of local FS). The larger the speed (local FS twist), the smaller the effect of subsequent interactions (accelerations) will be. The twin in a spacecraft would see its chemistry (aging) altered from the external observer point of view because all the dynamics (interactions) would be creating smaller changes at each de Broglie step. Smaller changes per de Broglie step means slower aging. Nuclear lifetimes [7] are also affected by the local twisting. A more detailed analysis is outside the scope of this paper and will be presented elsewhere.

The concept of the Fundamental Dilator brings about a view of a Stroboscopic Universe where interaction is intermittent and where particle substructure is easily explained by the polymeric nature of dilator coherences. It also brings about the possibility of thinking of matter in terms of metric deformations, thus capable of beating and nonlinear hadronics processes. We proposed new experiments that might bring about Coherent Nuclear Fusion along the lines of nonlinear optical interactions. Phase matching angle for coherent hadronic processes is tuned by changing the relative interaction velocity, which is an angle or direction in the 4D spatial manifold.

The theory was applied to standard tests (Precession of Mercury Perihelion, Gravitational Lensing), was used to explain the Stellar Candle paradox without the use of inflation, Hubble expansion without Dark Energy, Neutron Decay without Electroweak Interaction, Particle Substructure without quark composition and Black Hole's Double Jets with the use of Gyrogravitation.

The Fabric of Space Stress-Strain paradigm applied to the two cross-sections of the Universe (RXYZ and Φ XYZ) allowed for the derivation from first principles of natural laws (Gauss, Biot-Savart, Newton's Gravitation) and the derivation of a more general equation that applies to all forces.

This is a simple theory in terms of formalism, which provides new insights and testable predictions.

ACKNOWLEDGEMENTS

I would like to express my eternal gratitude to my parents and family for the lifetime of friendship and support they provided.

REFERENCES

1. Bertram Schwarzschild, "WMAP Spacecraft Maps the Entire Cosmic Microwave Sky With Unprecedented Precision." *Physics Today*. Vol. 56, No. 4 (April 2003): 21.
2. W Pauli, "*Theory of Relativity*", 1958 London: Pergamon Press
3. L D Landau and E M Lifshitz, "*The Classical Theory of Fields*", 1975 Oxford: Pergamon Press.
4. J.D. Jackson, "*Classical Electrodynamics*", 1975-John Wiley & Sons).
5. P. Gerber, "*Die räumliche und zeitliche Ausbreitung der Gravitation*" (Space and temporary propagation of gravitation). *Z. Math. Phys.* 43 (1898), 93–104.
6. P. Gerber, "*Die Fortpflanzungsgeschwindigkeit der Gravitation*" (The propagation-velocity of gravitation). *Ann. Phys.* 52 (1917), 415–444.
7. Joseph Lach "*Hyperon Polarization and Magnetic Moments*", Fermilab-Conf-93/381

Article**On Astrometric Data & Time Varying Sun-Earth Distance
in Light of Carmeli Metric**Victor Christianto^{*}**Abstract**

In this note, we describe shortly time varying Sun-Earth distance in the light of Carmeli metric and compare the result with recent astrometric data. The graphical plot suggests that there should be linear-linear correspondence between Sun-planets distances and their time variation. Carmeli metric simply adds a momentum term to the normal 4-d spacetime formulation, to give us a 5-d working space, but actually the original Carmeli metric replaces time dimension in Minkowski metric to become momentum term divided by quadratic Hubble constant. One obvious advantage from Carmeli metric is that it can be used to derive Tully-Fisher law, which can explain galaxy motion without invoking dark matter.

Key Words: astrometric data, time varying, Sun-Earth distance, Carmeli metric.

Introduction

Recent astrometric data suggest that there is time variation of Sun-Earth distance at the order of 15 cm/year [1]. This observed effect can shed light on restriction in astronomy modeling.

In this regard we discuss how this time varying Sun-Earth distance can be explained by virtue of Carmeli metric [2]. In the first section we explain how Carmeli metric can be shown to be derivable from quaternion group, and in turn there are a number of new effects which can be observed as part of Carmeli metric. Carmeli metric simply adds a momentum term to the normal 4-d spacetime formulation, to give us a 5-d working space, but actually the original Carmeli metric replaces time dimension in Minkowski metric to become momentum term divided by quadratic Hubble constant. One obvious advantage from Carmeli metric is that it can be used to derive Tully-Fisher law, which can explain galaxy motion without invoking dark matter [2]. There are other advantages from the viewpoint of clarity of modeling, including that one can expect to explain the presently un-described Earth geochronometry [4].

^{*} Victor Christianto, <http://www.sciprint.org> E-Mail: victorchristianto@gmail.com

FLRW-metric from quaternion group and Carmeli metric

The quaternion algebra is one of the most important and most studied objects in mathematics and physics; and it has natural Hermitian form which induces Euclidean metric [3].

In this regards Trifonov has obtained that by using a natural extension of the structure tensors using nonzero quaternion bases then they will yield a metric as follows [3]:

$$g_{\alpha\beta} = \begin{pmatrix} \tau(\eta)\left(\frac{\dot{R}}{R}\right)^2 & 0 & 0 & 0 \\ 0 & -\tau(\eta) & 0 & 0 \\ 0 & 0 & -\tau(\eta)\sin^2(\chi) & 0 \\ 0 & 0 & 0 & -\tau(\eta)\sin^2(\chi)\sin^2(\vartheta) \end{pmatrix} \quad (1)$$

In order to obtain a closed-FLRW metric, one assume that [3]:

$$\tau(\eta)\left(\frac{\dot{R}}{R}\right)^2 = 1, \quad (2)$$

which can be rewritten in the form of a metric:[4]

$$\tau(\eta)(\dot{R})^2 = R^2 = dx^2 + dy^2 + dz^2, \quad (3)$$

or

$$ds^2 = dx^2 + dy^2 + dz^2 - \tau(\eta)(\dot{R})^2, \quad (4)$$

which in turn this metric can be compared with Carmeli metric:[2]

$$ds^2 = dR^2 - \frac{1}{H^2} dv^2 = dx^2 + dy^2 + dz^2 - \tau^2 dv^2, \quad (5)$$

where τ symbol denotes inverse of Hubble constant, H.

The standard procedure of Carmeli metric, however, is to begin with Hubble law [2]:

$$x = H_0^{-1}v, \quad (5a)$$

Where H and v are Hubble constant and velocity, respectively. Quote: "But one cannot use this law directly to obtain a relation between z and t. So we start by

assuming that the Universe is empty of gravitation. One can then describe the property of expansion as a null-vector in the flat four dimensions of space and expanding velocity v ." [2a] From a viewpoint, one can say for clarity that Carmeli metric simply adds a momentum term to the normal 4-d spacetime formulation, to give us a 5-d working space, but actually the original Carmeli metric (see eq.(5)) replaces time dimension in Minkowski metric $ds^2 = dx^2 + dy^2 + dz^2 - c^2 dt^2$, to become momentum term divided by quadratic Hubble constant. One obvious advantage from Carmeli metric is that it can be used to derive Tully-Fisher law, which can explain galaxy motion without invoking dark matter.[2] There are other advantages from the viewpoint of clarity of modeling, including that one can expect to explain the presently un-described Earth geochronometry.[4] That is why we think that Carmeli metric can be one good candidate to explain galaxy motion without necessity to include dark matter.

One shall note here that this τ (tau) symbol is given different meaning compared with its meaning in equation (4), that is:

$$\tau^2 = \tau(\eta) = \frac{1}{\alpha H^n}. \quad (6)$$

One implication of this proposition has been found in [4], that there is such a proportionality which can be written as follows:

$$\left(\frac{R_1}{\dot{R}_1} \right) = \left(\frac{R_2}{\dot{R}_2} \right) = \sqrt{\tau(\eta)}. \quad (7)$$

The aforementioned proportionality corresponds to the observed Earth geochronometry phenomena which can be attributed to an expansion of Earth radius at the order of ~ 0.166 cm/yr [4].

Plausible explanation of time varying Sun-Earth distance

In order to explain time varying Sun-Earth distance, one can use similar analogies, but with introducing a coefficient in order to match with the observed data of Anderson et al. (that is around 15 cm /yr) [1]. The virtue of this calculation is that one can also expect to observe the time varying displacement of the other planets too, compared to their distances to the Sun.

Given we accept approximate radius of earth to be around 6367.5 km, or around 6.3675×10^6 meter, and that is why: elongation of metric scale can be estimated to

be around: $\frac{0.166\text{meter} / \text{cy}}{6367500\text{meter}} \approx 0.2607 \times 10^{-7} \text{m.cy}^{-1} / \text{m} \approx 2.607 \times 10^{-10} \text{m.year}^{-1} / \text{m}$. And

that is approximately what one should find in a metrology device in order one can observe the effect of Hubble expansion to SI metric length scale. After conversion, this number amount to: $8.26674 \times 10^{-18} \text{m/sec/m}$ ' . Now times this amount with $1.4959 \times 10^{11} \text{m}$ of distance between the Sun and the earth, and we will obtain estimate of displacement per second. After conversion to displacement each year, one gets= 39.0 meter per year of displacement. In order to match this number with the observed, one multiply this number with $1/274$, and then one gets: 14.23 cm/year of displacement of the Earth from the Sun. While the value above appears to be a retrodiction compared to the observed value, the virtue here is one gets simplicity of framework to get estimate of displacement for other planets. The proportionality now for the planets could be written instead of (7):

$$\left(\frac{\dot{R}_1}{R_1} \right) = \left(\frac{\varepsilon \dot{R}_2}{R_2} \right), \text{ or} \quad (8)$$

$$\left(\frac{\dot{R}_1}{R_1} \right) \frac{R_2}{\varepsilon} = (\dot{R}_2), \quad (8a)$$

where the R_2 mean distance from planet to the Sun, and R_1 mean earth radius respectively. The symbol ε denotes factor 274 to match the observed data. This number in turn can be associated with the well-known fine structure constant, therefore equation (8a) can be rewritten for convenience as follows:

$$\left(\frac{\dot{R}_1}{R_1} \right) \frac{\alpha R_2}{2} = (\dot{R}_2), \quad (8b)$$

where α represents fine structure constant = $1/137, \dots$ That would be interesting to observe the actual time-varying distance between other planets to the Sun, in order to verify or refute the aforementioned proposition (8b).

The result of the above procedure is presented in the table 1 below.

Table 1. calculation of the time varying displacement of planets from the Sun

planet	distance	displcmt	observd(in cm)	log scale	log scale	log scale
	dist(10 ¹¹ m)	displac(in cm)		dist(10 ¹¹ m)	displac(in m)	observd(in m)
mercury	5,7894	5,51		0,7626	0,74	
venus	10,9506	10,42		1,0394	1,02	
earth	14,9598	14,23	15	1,1749	1,15	1,176
mars	22,7389	21,64		1,3568	1,34	
hungarias	31,4006	29,88		1,4969	1,48	
asteroid	40,3914	38,43		1,6063	1,58	
camilla	47,1233	44,84		1,6732	1,65	
jupiter	77,8358	74,06		1,8912	1,87	
saturn	142,7014	135,77		2,1544	2,13	
uranus	287,0783	273,14		2,4580	2,44	
neptune	450,2896	428,43		2,6535	2,63	
pluto	590,9116	562,23		2,7715	2,75	
2003ub313	777,9089	740,15		2,8909	2,87	

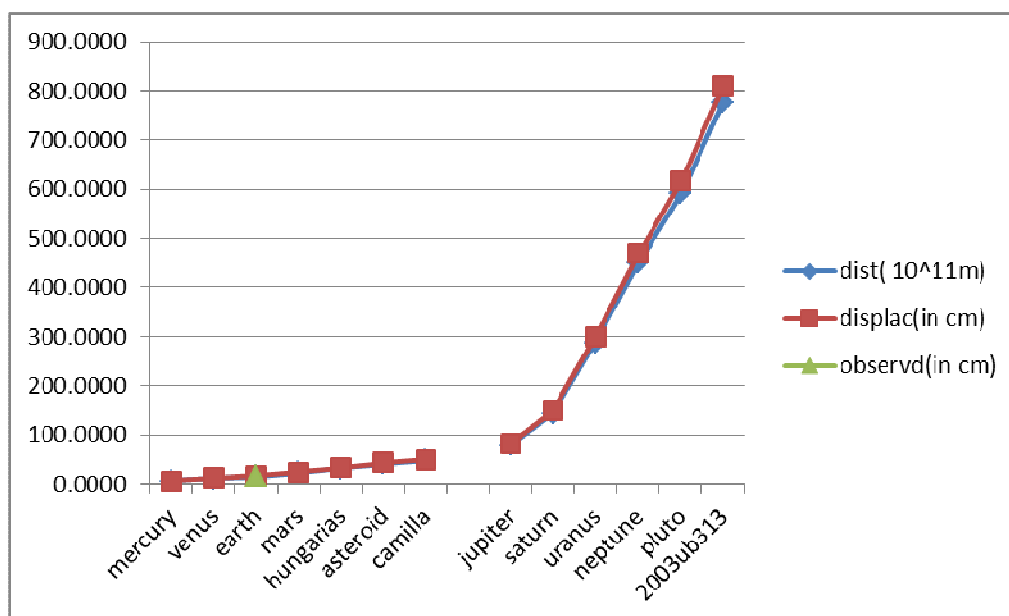

Figure 1. Graphical plot of time varying displacement of planets from the Sun

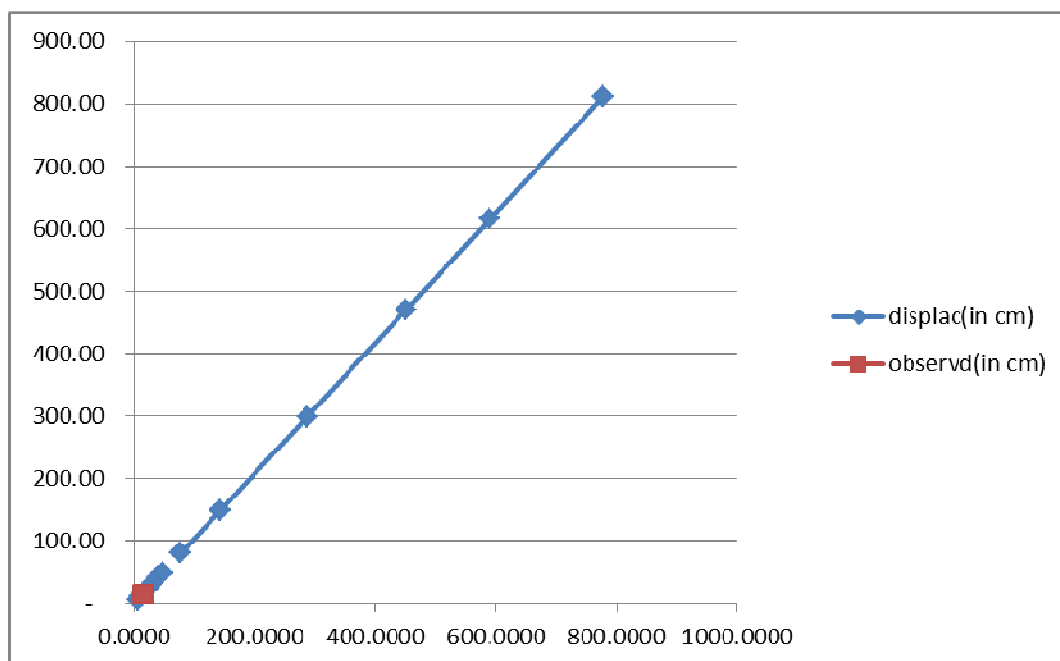

Figure 2. Graphical plot of distance vs. displacement of various planets from the Sun

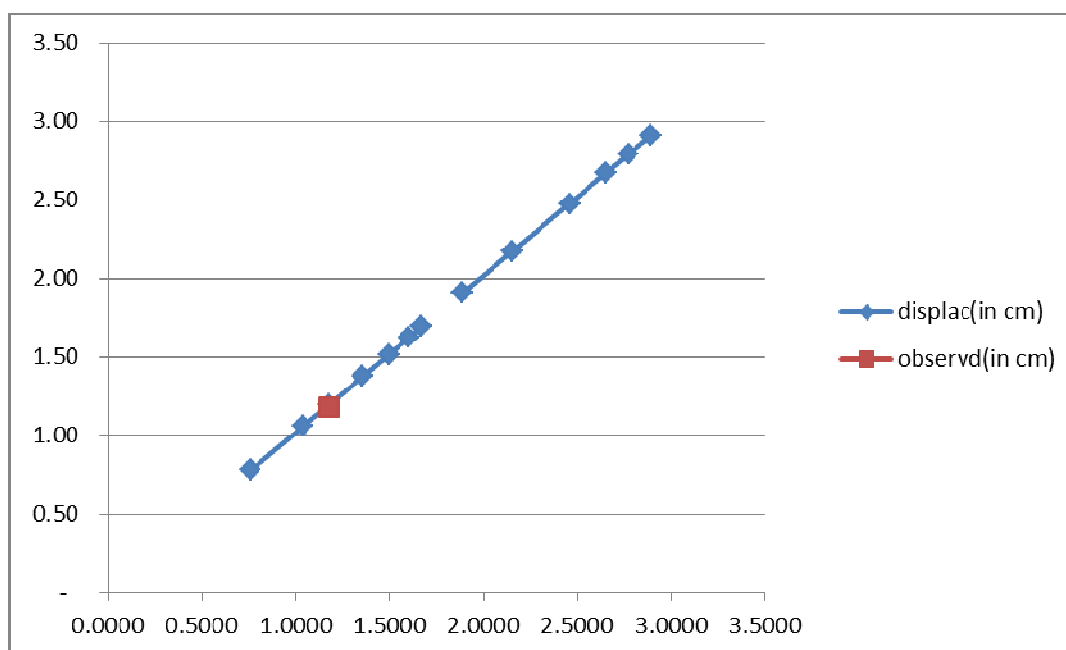

Figure 3. Graphical log-log plot of distance vs. displacement of various planets from the Sun.

Concluding remarks

In this note, we describe shortly time varying Sun-Earth distance in the light of Carmeli metric and compare the result with recent astrometric data. The graphical plot suggests that there should be linear-linear correspondence between Sun-planets distances and their time variation.

Not only that, the prediction made here suggests that Carmeli metric can be the sought after framework in order to describe the astrometric anomaly pertaining to the time varying distance of the Sun-Earth distance, and furthermore there are expected time varying distance effect between the Sun and other planets as well.

References:

- [1] J.D. Anderson & M.M. Nieto (2009), "Astrometric solar system anomalies," *Relativity in fundamental astronomy*. Proc. IAU Symposium no. 261, 2009, arXiv:gr-qc/0907.2469. (9p.)
- [2] M. Carmeli (1996) "Is galaxy dark matter a property of spacetime?" arXiv: astro-ph/9607142. M. Carmeli, J. Hartnett, F.J. Oliveira (2005) "The cosmic time in terms of the redshift," arXiv: gr-qc/0506079 (2005).
- [3] V. Trifonov (2003), "Geometry of the group of nonzero quaternions," arXiv: physics/0301052; [3a] arXiv: math-ph/0606007.
- [4] V. Christianto & F. Smarandache (2008), "Kaluza-Klein-Carmeli metric from quaternion space, Lorentz's force, and some observable," *Progress in Physics* vol. 2, url: www.ptep-online.com. Vixra reference: <http://vixra.org/pdf/1003.0050v1.pdf>
- [5] V. Christianto & F. Smarandache (2008), "What gravity is: some recent considerations," *Progress in Physics* vol. 3, url: www.ptep-online.com. Vixra reference: <http://vixra.org/pdf/1003.0015v1.pdf>

What Gravity Is. Some Recent Considerations

Vic Christianto* and Florentin Smarandache†

*Sciprint.org — a Free Scientific Electronic Preprint Server, <http://www.sciprint.org>

E-mail: admin@sciprint.org

†Department of Mathematics, University of New Mexico, Gallup, NM 87301, USA

E-mail: smarand@unm.edu

It is well-known, that when it comes to discussions among physicists concerning the meaning and nature of gravitation, the room temperature can be so hot. Therefore, for the sake of clarity, it seems worth that all choices were put on a table, and we consider each choice's features and problems. The present article describes a non-exhaustive list of such gravitation theories for the purpose of inviting further and more clear discussions.

1 Introduction

The present article summarizes a non-exhaustive list of gravitation theories for the purpose of inviting further and more clear discussions. It is well-known, that when it comes to discussions among physicists concerning the meaning and nature of gravitation, the room temperature can be so hot. Therefore, for the sake of clarity, it seems worth that all choices were put on a table, and we consider each choice's features and problems. Of course, our purpose here is not to say the last word on this interesting issue.

2 Newtonian and non-relativistic approaches

Since the days after Newton physicists argued what is the meaning of “action at a distance” (Newton term) or “spooky action” (Einstein term). Is it really possible to imagine how an apple can move down to Earth without a medium whatsoever?

Because of this difficulty, from the viewpoint of natural philosophy, some physicists maintained (for instance Euler with his impulsion gravity), that there should be “pervasive medium” which can make the attraction force possible. They call this medium “ether” though some would prefer this medium more like “fluid” instead of “solid”. Euler himself seems to suggest that gravitation is some kind of “external force” acting on a body, instead of *intrinsic* force:

“gravity of weight: It is a power by which all bodies are forced towards the centre of the Earth” [3].

But the Michelson-Morley experiment [37] opened the way for Einstein to postulate that ether hypothesis is not required at all in order to explain Lorentz's theorem, which was the beginning of Special Relativity. But of course, one can ask whether the Michelson-Morley experiment really excludes the so-called ether hypothesis. Some experiments after Michelson seem to indicate that “ether” is not excluded in the experiment setup, which means that there is Earth absolute motion [4, 5].

To accept that gravitation is external force instead of intrinsic force implies that there is distinction between gravitation and inertial forces, which also seem to indicate that inertial force can be modified externally via electromagnetic field [6].

The latter notion brings us to long-time discussions in various physics journals concerning the electromagnetic nature of gravitation, i.e. whether gravitation pulling force have the same properties just as electromagnetic field is described by Maxwell equations. Proponents of this view include Tajmar and de Matos [7, 8], Sweetser [9]. And recently Rabounski [10] also suggests similar approach.

Another version of Euler's hypothesis has emerged in modern way in the form of recognition that gravitation was carried by a boson field, and therefore gravitation is somehow related to low-temperature physics (superfluid as boson gas, superconductivity etc.). The obvious advantage of superfluidity is of course that it remains frictionless and invisible; these are main features required for true ether medium — i.e. no resistance will be felt by objects surrounded by the ether, just like the passenger will not feel anything inside the falling elevator. No wonder it is difficult to measure or detect the ether, as shown in Michelson-Morley experiment. The superfluid Bose gas view of gravitation has been discussed in a series of paper by Consoli et al. [11], and also Volovik [12].

Similarly, gravitation can also be associated to superconductivity, as shown by de Matos and Beck [29], and also in Podkletnov's rotating disc experiment. A few words on Podkletnov's experiment. Descartes conjectured that there is no gravitation without rotation motion [30]. And since rotation can be viewed as solution of Maxwell equations, one can say that there is no gravitation separated from electromagnetic field. But if we consider that equations describing superconductivity can be viewed as mere generalization of Maxwell equations (London field), then it seems we can find a modern version of Descartes' conjecture, i.e. *there is no gravitation without superconductivity rotation*. This seems to suggest the significance of Podkletnov's experiments [31, 32].

3 Relativistic gravitation theories

Now we will consider some alternative theories which agree with both Newton theory and Special Relativity, but differ either slightly or strongly to General Relativity. First of all, Einstein's own attempt to describe gravitation despite earlier gravitation theories (such as by Nordstrom [1]) has been inspired by his thought-experiment, called the "falling elevator" experiment. Subsequently he came up with conjecture that there is proper metric such that a passenger inside the elevator will not feel any pulling gravitation force. Therefore gravitation can be replaced by certain specific-chosen metric.

Now the questions are twofold: (a) whether the proper-metric to replace gravitation shall have non-zero curvature or it can be flat-Minkowskian; (b) whether the formulation of General relativity is consistent enough with Mach principle from where GTR was inspired. These questions inspired heated debates for several decades, and Einstein himself (with colleagues) worked on to generalize his own gravitation theories, which implies that he did find that his theory is not complete. His work with Strauss, Bergmann, Pauli, etc. (Princeton School) aimed toward such a unified theory of gravitation and electromagnetism.

There are of course other proposals for relativistic gravitation theories, such as by Weyl, Whitehead etc. [1]. Meanwhile, R. Feynman and some of his disciples seem to be more flexible on whether gravitation shall be presented in the General-Relativity "language" or not.

Recently, there is also discussion in online forum over the question: (a) above, i.e. whether curvature of the metric surface is identical to the gravitation. While most physicists seem to agree with this proposition, there is other argument suggesting that it is also possible to conceive General Relativity even with zero curvature [13, 14].

Of course, discussion concerning relativistic gravitation theories will not be complete without mentioning the PV-gravitation theory (Puthoff et al. [15]) and also Yilmaz theory [16], though Misner has discussed weaknesses of Yilmaz theory [17], and Yilmaz et al. have replied back [18]. Perhaps it would be worth to note here that General Relativity itself is also not without limitations, for instance it shall be modified to include galaxies' rotation curve, and also it is actually theory for one-body problem only [2], therefore it may be difficult to describe interaction between bodies in GTR.

Other possible approaches on relativistic gravitation theories are using the fact that the "falling-elevator" seems to suggest that it is possible to replace gravitation force with certain-chosen metric. And if we consider that one can find simplified representation of Maxwell equations with Special Relativity (Minkowski metric), then the next logical step of this "metrical" (some physicists prefer to call it "geometro-dynamics") approach is to represent gravitation with yet another special relativistic but with extra-dimension(s). This was first conjectured in Kaluza-Klein theory [19]. Einstein

himself considered this theory extensively with Strauss etc. [20]. There are also higher-dimensional gravitation theories with 6D, 8D and so forth.

In the same direction, recently these authors put forth a new proposition using Carmeli metric [21], which is essentially a "phase-space" relativity theory in 5-dimensions.

Another method to describe gravitation is using "torsion", which is essentially to introduce torsion into Einstein field equations. See also torsional theory developed by Hehl, Kiehn, Rapoport etc. cited in [21].

It seems worth to remark here, that relativistic gravitation does not necessarily exclude the possibility of "aether" hypothesis. B. Riemann extended this hypothesis by assuming (in 1853) that the gravitational aether is an incompressible fluid and normal matter represents "sinks" in this aether [34], while Einstein discussed this aether in his Leiden lecture *Ether and Relativity*.

A summary of contemporary developments in gravitation theories will not be complete without mentioning Quantum Gravity and Superstring theories. Both are still major topics of research in theoretical physics and consist of a wealth of exotic ideas, some or most of which are considered controversial or objectionable. The lack of experimental evidence in support of these proposals continues to stir a great deal of debate among physicists and makes it difficult to draw definite conclusions regarding their validity [38]. It is generally alleged that signals of quantum gravity and superstring theories may occur at energies ranging from the mid or far TeV scale all the way up to the Planck scale.

Loop Quantum Gravity (LQG) is the leading candidate for a quantum theory of gravitation. Its goal is to combine the principles of General Relativity and Quantum Field Theory in a consistent non-perturbative framework [39]. The features that distinguish LQG from other quantum gravity theories are: (a) background independence and (b) minimality of structures. Background independence means that the theory is free from having to choose an a priori background metric. In LQG one does not perturb around any given classical background geometry, rather arbitrary fluctuations are allowed, thus enabling the quantum "replica" of Einstein's viewpoint that gravity is geometry. Minimality means that the general covariance of General Relativity and the principles of canonical quantization are brought together without new concepts such as extra dimensions or extra symmetries. It is believed that LQG can unify all presently known interactions by implementing their common symmetry group, the four-dimensional diffeomorphism group, which is almost completely broken in perturbative approaches.

The fundamental building blocks of String Theory (ST) are one-dimensional extended objects called strings [40, 41]. Unlike the "point particles" of Quantum Field Theories, strings interact in a way that is almost uniquely specified by mathematical self-consistency, forming an allegedly valid quantum theory of gravity. Since its launch as a dual res-

onance model (describing strongly interacting hadrons), ST has changed over the years to include a group of related superstring theories (SST) and a unifying picture known as the M-theory. SST is an attempt to bring all the particles and their fundamental interactions under one umbrella by modeling them as vibrations of super-symmetric strings.

In the early 1990s, it was shown that the various superstring theories were related by dualities, allowing physicists to map the description of an object in one superstring theory to the description of a different object in another superstring theory. These relationships imply that each of SST represents a different aspect of a single underlying theory, proposed by E. Witten and named M-theory. In a nut-shell, M-theory combines the five consistent ten-dimensional superstring theories with eleven-dimensional supergravity. A shared property of all these theories is the holographic principle, that is, the idea that a quantum theory of gravity has to be able to describe physics occurring within a volume by degrees of freedom that exist on the surface of that volume. Like any other quantum theory of gravity, the prevalent belief is that true testing of SST may be prohibitively expensive, requiring unprecedented engineering efforts on a large-system scale. Although SST is falsifiable in principle, many critics argue that it is un-testable for the foreseeable future, and so it should not be called science [38].

One needs to draw a distinction in terminology between string theories (ST) and alternative models that use the word “string”. For example, Volovik talks about “cosmic strings” from the standpoint of condensed matter physics (topological defects, superfluidity, superconductivity, quantum fluids). Beck refers to “random strings” from the standpoint of statistical field theory and associated analytic methods (space-time fluctuations, stochastic quantization, coupled map lattices). These are not quite the same as ST, which are based on “brane” structures that live on higher dimensional space-time.

There are other contemporary methods to treat gravity, i.e. by using some advanced concepts such as group(s), topology and symmetries. The basic idea is that Nature seems to prefer symmetry, which lead to higher-dimensional gravitation theories, Yang-Mills gravity etc.

Furthermore, for the sake of clarity we have omitted here more advanced issues (sometimes they are called “fringe research”), such as faster-than-light (FTL) travel possibility, warpdrive, wormhole, cloaking theory (Greenleaf et al. [35]), antigravity (see for instance Naudin’s experiment) etc. [36].

4 Wave mechanical method and diffraction hypothesis

The idea of linking gravitation with wave mechanics of Quantum Mechanics reminds us to the formal connection between Helmholtz equation and Schrödinger equation [22].

The use of (modified) Schrödinger equation has become so extensive since 1970s, started by Wheeler-DeWitt (despite

the fact that the WDW equation lacks observation support). And recently Nottale uses his scale relativistic approach based on stochastic mechanics theory in order to generalize Schrödinger equation to describe wave mechanics of celestial bodies [23]. His scale-relativity method finds support from observations both in Solar system and also in exo-planets.

Interestingly, one can also find vortex solution of Schrödinger equation, and therefore it is worth to argue that the use of wave mechanics to describe celestial systems implies that there are vortex structure in the Solar system and beyond. This conjecture has also been explored by these authors in the preceding paper. [24] Furthermore, considering formal connection between Helmholtz equation and Schrödinger equation, then it seems also possible to find out vortex solutions of Maxwell equations [25, 26, 27]. Interestingly, experiments on plasmoid by Bostick et al. seem to vindicate the existence of these vortex structures [28].

What’s more interesting in this method, perhaps, is that one can expect to consider gravitation and wave mechanics (i.e. Quantum Mechanics) in equal footing. In other words, the quantum concepts such as ground state, excitation, and zero-point energy now can also find their relevance in gravitation too. This “classical” implications of Wave Mechanics has been considered by Ehrenfest and also Schrödinger himself.

In this regards, there is a recent theory proposed by Gulko [33], suggesting that matter absorbs from the background small amounts of energy and thus creates a zone of reduced energy, and in such way it attracts objects from zones of higher energy.

Another one, by Glenn E. Perry, says that gravity is diffraction (due to the changing energy density gradient) of matter or light as it travels through the aether [33].

We can remark here that Perry’s Diffraction hypothesis reminds us to possible production of energy from physical vacuum via a small fluctuation in it due to a quantum indeterminacy (such a small oscillation of the background can be suggested in any case because the indeterminacy principle). On the average the background vacuum does not radiate — its energy is constant. On the other hand, it experiences small oscillation. If an engine built on particles or field interacts with the small oscillation of the vacuum, or at least “senses the oscillation, there is a chance to get energy from them. Because the physical vacuum is eternal capacity of energy, it is easy to imagine some possible techniques to be discovered in the future to extract this energy.

Nonetheless, diffraction of gravity is not a “new hot topic” at all. Such ideas were already proposed in the 1920’s by the founders of relativity. They however left those ideas, even unpublished but only mentioned in memoirs and letters. The main reason was that (perhaps) almost infinitely small energy which can be extracted from such background per second. (In the mean time, there are other various proposals suggesting that it is possible to ‘extract’ energy from gravitation field).

About Glenn Perry and his theory. There is a drawback that that matter he called “aether” was not properly determined by him. In such a way like that, everything can be “proven”. To produce any calculation for practical purpose, we should have exact data on the subject of this calculation, and compare it with actual experiments.

On the other hand, such an idea could be put into another field — the field of Quantum Mechanics. That is, to study diffraction not gravitational radiation (gravitational waves which is so weak that not discovered yet), but waves of the field of the gravitational force — in particular those can be seismic-like waves travelling in the cork of the Earth (we mean not the earthquakes) but in the gravitational field of the planet. These seismic-like oscillations (waves) of the gravitational force are known to science, and they aren't weak: everyone who experienced an earthquake knows this fact.

Other hint from wave aspect of this planet is known in the form of Schumann resonance, that the Earth produces vibration at very-low frequency, which seems to support the idea that planetary mass vibrates too, just as hypothesized in Wave Mechanics (de Broglie's hypothesis). Nonetheless, there are plenty of things to study on the large-scale implications of the Wave Mechanics.

5 Concluding remarks

The present article summarizes a non-exhaustive list of gravitation theories for the purpose of inviting further and more clear discussions. Of course, our purpose here is not to say the last word on this interesting issue. For the sake of clarity, some advanced subjects have been omitted, such as faster-than-light (FTL) travel possibility, warpdrive, wormhole, cloaking theory (Greenleaf et al.), antigravity etc. As to the gravitation research in the near future, it seems that there are multiple directions which one can pursue, with which we're not so sure. The only thing that we can be sure is that everything changes (Heraclitus of Ephesus), including how we define “what the question is” (Wheeler's phrase), and also what we mean with “metric”, “time”, and “space”. Einstein himself once remarked that ‘distance’ itself is merely an illusion.

Acknowledgment

The first writer wishes to thank to Prof. T. Van Flandern for sending his *Meta Research Bulletin* around 8 years ago. Both writers wish to thank to Dr. J. Sarfatti and P. Zielinski and others for stimulating discussions concerning the meaning of curvature in General Relativity. Special thanks to D. Rabounski for his remarks on Glenn Perry diffraction theory; and to E. Goldfain for summary of Loop Quantum gravity and Superstring. Previous discussions with Profs. M. Pitkanen, D. Rapoport, A. Povolotsky, Yoshio Kishi, and others are ac-

knowledged. At the time of writing this paper, P. LaViolette has just released a new book discussing antigravity research.

Submitted on May 02, 2008 / Accepted on June 19, 2008

References

1. http://en.wikipedia.org/wiki/Classical_theories_of_gravitation
2. Millis M. New ways of thinking inertia and gravity. <http://www.spinningdisk.org/article0.htm>
3. Lamprecht J. Euler's impulsion gravity. *Meta Research Bulletin*, 1998, v. 7, no. 3.
4. Consoli M. and Constanzo E. Flat space picture of gravitation vs General Relativity. arXiv: 0710.5613.
5. Consoli M. Modern Michelson-Morley experiment and gravitation induced anisotropy of c . arXiv: gr-qc/0306105.
6. Haisch B. and Rueda A. Geometrodynamics, inertia, and quantum vacuum. arXiv: gr-qc/0106075.
7. De Matos C. J. and Tajmar M. Gravitational Poynting vector. arXiv: gr-qc/0107014.
8. De Matos C. J. and Tajmar M. Coupling of gravitation and electromagnetism in the weak field approximation. arXiv: gr-qc/0003011.
9. Sweetser D. Classical unified field theory. http://world.std.com/~sweetser/arch/unified_field.2001.09.01/unified_field.html
10. Rabounski D. A theory of gravity like electrodynamics. *Progress in Physics*, 2005, v. 2.
11. Consoli M. Gravitational forces from Bose-Einstein condensate. arXiv: hep-ph/0002098.
12. Volovik G. Superfluid analogies of cosmological phenomena. arXiv: gr-qc/0005091.
13. Brown P. M. Einstein gravitational field. arXiv: physics/0204044.
14. Luminet J.-P. <http://luth2.obspm.fr/~luminet/etopo.html>
15. Puthoff H. PV representation of general relativity. arXiv: gr-qc/9909037.
16. http://en.wikipedia.org/wiki/Yilmaz_theory_of_gravitation
17. Misner C. W. Yilmaz cancels Newton. arXiv: gr-qc/9504050.
18. Alley C. O., et al. Refutation of Misner's claims. arXiv: gr-qc/9506082.
19. Kol B. and Smolkin M. Non-relativistic gravitation: from Newton to Einstein and back. arXiv: 0712.4116; [19a] http://en.wikipedia.org/wiki/Scalar_theories_of_gravitation
20. Huang X. B. Unification of gravitation, gauge field, and dark energy. arXiv: hep-th/0410266
21. Christianto V. and Smarandache F. Kaluza-Klein-Carmeli metric from Quaternion-Clifford Space, Lorentz force, and some observables. *Progress in Physics*, 2008, v. 4.
22. Lu L. J., Greeleaf J. F., and Recami E. arXiv: physics/9610012.
23. Celerier M. N. and Nottale L. Generalized macro Schrödinger equation from scale relativity. arXiv: gr-qc/0505012.

24. Smarandache F. and Christianto V. Schrödinger equation and the quantization of celestial systems. *Progress in Physics*, 2006, v. 2.
25. Sowa A. Nonlinear Maxwell theory and electrons in two dimensions. arXiv: cond-mat/9904204.
26. Bialinycki-Birula I. and Bialinycki-Birula Z. arXiv: physics/0305012.
27. Bialinycki-Birula I. arXiv: physics/0309112.
28. Bostick W. Experimental study of plasmoids. *Phys. Rev.*, 1957, v. 106, 404–412; <http://en.wikipedia.org/wiki/Plasmoid>
29. de Matos G. J. and Beck C. arXiv: 0707.1797.
30. Snelders H. A. M. Huygens and Newton's theory of gravitation. *Notes and Records of the Royal Society of London*, 1989, v. 43, no. 2.
31. Solomon B. An introduction to gravity modification: a guide to using Laithwaite's and Podkletnov's experiments and the physics of forces for empirical results. <http://www.libreriauniversitaria.it/an-introduction-to-gravity-modification/book/9781599429922>
32. http://en.wikipedia.org/wiki/Eugene_Podkletnov
33. Perry G. E. Gravity as diffraction — proof and consequences. *Infinite Energy*, 2008, v. 14, no. 79, 25–38.
34. http://en.wikipedia.org/wiki/Mechanical_explanations_of_gravitation
35. <http://plus.maths.org/latestnews/jan-apr07/cloaking/index.html>
36. Sato R. Physicist use levitation to solve a sticky problem. http://www.dailygalaxy.com/my_weblog/2007/08/physicists-use-.html; [36a] <http://www.zamandayolculuk.com/cetinbal/wwormholew.htm>
37. Pavlovic M. <http://users.net.yu/~mrp/chapter5.html>
38. <http://discovermagazine.com/2006/feb/dialogue-woit>
39. See e.g.: Smolin L. Three roads to quantum gravity. Basic Books, New York, 2001.
40. See e.g.: Green M. Superstring theory in new physics for the twenty-first century. Cambridge University Press, 2006.
41. 't Hooft G. Introduction to string theory. <http://www.phys.uu.nl/~thoof/lectures/stringnotes.pdf>

Schrödinger Equation and the Quantization of Celestial Systems

Florentin Smarandache* and Vic Christianto†

*Department of Mathematics, University of New Mexico, Gallup, NM 87301, USA

E-mail: smarand@unm.edu

†Sciprint.org – a Free Scientific Electronic Preprint Server, <http://www.sciprint.org>

E-mail: admin@sciprint.org

In the present article, we argue that it is possible to generalize Schrödinger equation to describe quantization of celestial systems. While this hypothesis has been described by some authors, including Nottale, here we argue that such a macroquantization was formed by topological superfluid vortice. We also provide derivation of Schrödinger equation from Gross-Pitaevskii-Ginzburg equation, which supports this superfluid dynamics interpretation.

1 Introduction

In the present article, we argue that it is possible to generalize Schrödinger equation to describe quantization of celestial systems, based on logarithmic nature of Schrödinger equation, and also its exact mapping to Navier-Stokes equations [1].

While this notion of macro-quantization is not widely accepted yet, as we will see the logarithmic nature of Schrödinger equation could be viewed as a support of its applicability to larger systems. After all, the use of Schrödinger equation has proved itself to help in finding new objects known as extrasolar planets [2, 3]. And we could be sure that new extrasolar planets are to be found in the near future. As an alternative, we will also discuss an outline for how to derive Schrödinger equation from simplification of Ginzburg-Landau equation. It is known that Ginzburg-Landau equation exhibits fractal character, which implies that quantization could happen at *any scale*, supporting topological interpretation of quantized vortices [4].

First, let us rewrite Schrödinger equation in its common form [5]

$$\left[i \frac{\partial}{\partial t} + \frac{\bar{\nabla}^2}{2m} - U(x) \right] \psi = 0 \quad (1)$$

or

$$i \frac{\partial \psi}{\partial t} = H \psi. \quad (2)$$

Now, it is worth noting here that Englman and Yahalom [5] argues that this equation exhibits logarithmic character

$$\ln \psi(x, t) = \ln (|\psi(x, t)|) + i \arg(\psi(x, t)). \quad (3)$$

Schrödinger already knew this expression in 1926, which then he used it to propose his equation called “eigentliche Wellengleichung” [5]. Therefore equation (1) can be rewritten as follows

$$2m \frac{\partial(\ln|\psi|)}{\partial t} + 2\bar{\nabla} \ln|\psi| \bar{\nabla} \arg[\psi] + \bar{\nabla} \bar{\nabla} \arg[\psi] = 0. \quad (4)$$

Interestingly, Nottale’s scale-relativistic method [2, 3] was also based on generalization of Schrödinger equation to describe quantization of celestial systems. It is known that Nottale-Schumacher’s method [6] could predict new exoplanets in good agreement with observed data. Nottale’s scale-relativistic method is essentially based on the use of first-order scale-differentiation method defined as follows [2]

$$\frac{\partial V}{\partial(\ln \delta t)} = \beta(V) = a + bV + \dots \quad (5)$$

Now it seems clear that the natural-logarithmic derivation, which is essential in Nottale’s scale-relativity approach, also has been described properly in Schrödinger’s original equation [5]. In other words, its logarithmic form ensures applicability of Schrödinger equation to describe macro-quantization of celestial systems. [7, 8]

2 Quantization of celestial systems and topological quantized vortices

In order to emphasize this assertion of the possibility to describe quantization of celestial systems, let us quote Fischer’s description [4] of relativistic momentum from superfluid dynamics. Fischer [4] argues that the circulation is in the relativistic dense superfluid, defined as the integral of the momentum

$$\gamma_s = \oint p_\mu dx^\mu = 2\pi N_v \hbar, \quad (6)$$

and is quantized into multiples of Planck’s quantum of action. This equation is the covariant Bohr-Sommerfeld quantization of γ_s . And then Fischer [4] concludes that the Maxwell equations of ordinary electromagnetism can be written in the form of conservation equations of relativistic perfect fluid hydrodynamics [9]. Furthermore, the topological character of equation (6) corresponds to the notion of topological electronic liquid, where compressible electronic liquid represents superfluidity [25]. For the plausible linkage between superfluid dynamics and cosmological phenomena, see [16–24].

It is worth noting here, because vortices could be defined as elementary objects in the form of stable topological excitations [4], then equation (6) could be interpreted as Bohr-Sommerfeld-type quantization from *topological quantized vortices*. Fischer [4] also remarks that equation (6) is quite interesting for the study of superfluid rotation in the context of gravitation. Interestingly, application of Bohr-Sommerfeld quantization for celestial systems is known in literature [7, 8], which here in the context of Fischer's arguments it has special meaning, i. e. it suggests that *quantization of celestial systems actually corresponds to superfluid-quantized vortices at large-scale* [4]. In our opinion, this result supports known experiments suggesting neat correspondence between condensed matter physics and various cosmology phenomena [16–24].

To make the conclusion that quantization of celestial systems actually corresponds to superfluid-quantized vortices at large-scale a bit conceivable, let us consider the problem of quantization of celestial orbits in solar system.

In order to obtain planetary orbit prediction from this hypothesis we could begin with the Bohr-Sommerfeld's conjecture of quantization of angular momentum. This conjecture may originate from the fact that according to BCS theory, superconductivity can exhibit macroquantum phenomena [26, 27]. In principle, this hypothesis starts with observation that in quantum fluid systems like superfluidity [28]; it is known that such vortexes are subject to quantization condition of integer multiples of 2π , or $\oint v_s dl = 2\pi n \hbar / m$. As we know, for the wavefunction to be well defined and unique, the momenta must satisfy Bohr-Sommerfeld's quantization condition [28]

$$\oint_{\Gamma} p dx = 2\pi n \hbar \quad (6a)$$

for any closed classical orbit Γ . For the free particle of unit mass on the unit sphere the left-hand side is [28]

$$\int_0^T v^2 d\tau = \omega^2 T = 2\pi\omega, \quad (7)$$

where $T = 2\pi/\omega$ is the period of the orbit. Hence the quantization rule amounts to quantization of the rotation frequency (the angular momentum): $\omega = n\hbar$. Then we can write the force balance relation of Newton's equation of motion [28]

$$\frac{GMm}{r^2} = \frac{mv^2}{r}. \quad (8)$$

Using Bohr-Sommerfeld's hypothesis of quantization of angular momentum, a new constant g was introduced [28]

$$mvr = \frac{ng}{2\pi}. \quad (9)$$

Just like in the elementary Bohr theory (before Schrödinger), this pair of equations yields a known simple solution

for the orbit radius for any quantum number of the form [28]

$$r = \frac{n^2 g^2}{4\pi^2 GMm^2}, \quad (10)$$

which can be rewritten in the known form of gravitational Bohr-type radius [2, 7, 8]

$$r = \frac{n^2 GM}{v_0^2}, \quad (11)$$

where r , n , G , M , v_0 represents orbit radii, quantum number ($n = 1, 2, 3, \dots$), Newton gravitation constant, and mass of the nucleus of orbit, and specific velocity, respectively. In this equation (11), we denote [28]

$$v_0 = \frac{2\pi}{g} GMm. \quad (12)$$

The value of m is an adjustable parameter (similar to g) [7, 8]. In accordance with Nottale, we assert that the specific velocity v_0 is 144 km/sec for planetary systems. By noting that m is meant to be mass of celestial body in question, then we could find g parameter (see also [28] and references cited therein).

Using this equation (11), we could predict quantization of celestial orbits in the solar system, where for Jovian planets we use least-square method and use M in terms of reduced mass $\mu = \frac{(M_1 + M_2)}{M_1 M_2}$. From this viewpoint the result is shown in Table 1 below [28].

For comparison purpose, we also include some recent observation by Brown-Trujillo team from Caltech [29–32]. It is known that Brown et al. have reported not less than four new planetoids in the outer side of Pluto orbit, including 2003EL61 (at 52 AU), 2005FY9 (at 52 AU), 2003VB12 (at 76 AU, dubbed as Sedna). And recently Brown-Trujillo team reported a new planetoid finding, called 2003UB31 (97 AU). This is not to include their previous finding, Quaoar (42 AU), which has orbit distance more or less near Pluto (39.5 AU), therefore this object is excluded from our discussion. It is interesting to remark here that all of those new "planetoids" are within 8% bound from our prediction of celestial quantization based on the above Bohr-Sommerfeld quantization hypothesis (Table 1). While this prediction is not so precise compared to the observed data, one could argue that the 8% bound limit also corresponds to the remaining planets, including inner planets. Therefore this 8% uncertainty could be attributed to macroquantum uncertainty and other local factors.

While our previous prediction only limits new planet finding until $n = 9$ of Jovian planets (outer solar system), it seems that there are sufficient reasons to suppose that more planetoids in the Oort Cloud will be found in the near future. Therefore it is recommended to extend further the same quantization method to larger n values. For prediction purpose, we include in Table 1 new expected orbits based

Object	No.	Titius	Nottale	CSV	Observ.	Δ , %
	1		0.4	0.43		
	2		1.7	1.71		
Mercury	3	4	3.9	3.85	3.87	0.52
Venus	4	7	6.8	6.84	7.32	6.50
Earth	5	10	10.7	10.70	10.00	-6.95
Mars	6	16	15.4	15.4	15.24	-1.05
Hungarias	7		21.0	20.96	20.99	0.14
Asteroid	8		27.4	27.38	27.0	1.40
Camilla	9		34.7	34.6	31.5	-10.00
Jupiter	2	52		45.52	52.03	12.51
Saturn	3	100		102.4	95.39	-7.38
Uranus	4	196		182.1	191.9	5.11
Neptune	5			284.5	301	5.48
Pluto	6	388		409.7	395	-3.72
2003EL61	7			557.7	520	-7.24
Sedna	8	722		728.4	760	4.16
2003UB31	9			921.8	970	4.96
Unobserv.	10			1138.1		
Unobserv.	11			1377.1		

Table 1: Comparison of prediction and observed orbit distance of planets in Solar system (in 0.1AU unit) [28].

on the same quantization procedure we outlined before. For Jovian planets corresponding to quantum number $n = 10$ and $n = 11$, our method suggests that it is likely to find new orbits around 113.81 AU and 137.71 AU, respectively. It is recommended therefore, to find new planetoids around these predicted orbits.

As an interesting alternative method supporting this proposition of quantization from superfluid-quantized vortices (6), it is worth noting here that Kiehn has argued in favor of re-interpreting the square of the wavefunction of Schrödinger equation as the vorticity distribution (including topological vorticity defects) in the fluid [1]. From this viewpoint, Kiehn suggests that there is *exact mapping* from Schrödinger equation to Navier-Stokes equation, using the notion of quantum vorticity [1]. Interestingly, de Andrade and Sivaram [33] also suggest that there exists formal analogy between Schrödinger equation and the Navier-Stokes viscous dissipation equation:

$$\frac{\partial V}{\partial t} = \nu \nabla^2 V, \quad (13)$$

where ν is the kinematic viscosity. Their argument was based on propagation torsion model for quantized vortices [23]. While Kiehn's argument was intended for ordinary fluid, nonetheless the neat linkage between Navier-Stokes equation and superfluid turbulence is known in literature [34, 24].

At this point, it seems worth noting that some criticism arises concerning the use of quantization method for describing the motion of celestial systems. These criticism proponents usually argue that quantization method (wave mechanics) is oversimplifying the problem, and therefore cannot explain other phenomena, for instance planetary migration etc. While we recognize that there are phenomena which do not correspond to quantum mechanical process, at least we can argue further as follows:

1. Using quantization method like Nottale-Schumacher did, one can expect to predict new exoplanets (extra-solar planets) with remarkable result [2, 3];
2. The "conventional" theories explaining planetary migration normally use fluid theory involving *diffusion* process;
3. Alternatively, it has been shown by Gibson et al. [35] that these migration phenomena could be described via Navier-Stokes approach;
4. As we have shown above, Kiehn's argument was based on *exact-mapping* between Schrödinger equation and Navier-Stokes equations [1];
5. Based on Kiehn's vorticity interpretation one these authors published prediction of some new planets in 2004 [28]; which seems to be in good agreement with Brown-Trujillo's finding (March 2004, July 2005) of planetoids in the Kuiper belt;
6. To conclude: while our method as described herein may be interpreted as an oversimplification of the real planetary migration process which took place sometime in the past, at least it could provide us with useful tool for prediction;
7. Now we also provide new prediction of other planetoids which are likely to be observed in the near future (around 113.8 AU and 137.7 AU). It is recommended to use this prediction as guide to finding new objects (in the inner Oort Cloud);
8. There are of course other theories which have been developed to explain planetoids and exoplanets [36]. Therefore quantization method could be seen as merely a "plausible" theory between others.

All in all, what we would like to emphasize here is that the quantization method does not have to be the *true* description of reality with regards to celestial phenomena. As always this method could explain some phenomena, while perhaps lacks explanation for other phenomena. But at least it can be used to predict something quantitatively, i. e. measurable (exoplanets, and new planetoids in the outer solar system etc.).

In the meantime, it seems also interesting here to consider a plausible generalization of Schrödinger equation in particular in the context of viscous dissipation method [1]. First, we could write Schrödinger equation for a charged particle

interacting with an external electromagnetic field [1] in the form of Ulrych's unified wave equation [14]

$$\begin{aligned} [(-i\hbar\nabla - qA)_\mu(-i\hbar\nabla - qA)^\mu\psi] = \\ = \left[-i2m\frac{\partial}{\partial t} + 2mU(x) \right] \psi. \end{aligned} \quad (14)$$

In the presence of electromagnetic potential, one could include another term into the LHS of equation (14)

$$\begin{aligned} [(-i\hbar\nabla - qA)_\mu(-i\hbar\nabla - qA)^\mu + eA_0]\psi = \\ = 2m \left[-i\frac{\partial}{\partial t} + U(x) \right] \psi. \end{aligned} \quad (15)$$

This equation has the physical meaning of Schrödinger equation for a charged particle interacting with an external electromagnetic field, which takes into consideration Aharonov effect [37]. Topological phase shift becomes its immediate implication, as already considered by Kiehn [1].

As described above, one could also derived equation (11) from scale-relativistic Schrödinger equation [2, 3]. It should be noted here, however, that Nottale's method [2, 3] differs appreciably from the viscous dissipative Navier-Stokes approach of Kiehn [1], because Nottale only considers his equation in the Euler-Newton limit [3]. Nonetheless, it shall be noted here that in his recent papers (2004 and up), Nottale has managed to show that his scale relativistic approach has linkage with Navier-Stokes equations.

3 Schrödinger equation derived from Ginzburg-Landau equation

Alternatively, in the context of the aforementioned superfluid dynamics interpretation [4], one could also derive Schrödinger equation from simplification of Ginzburg-Landau equation. This method will be discussed subsequently. It is known that Ginzburg-Landau equation can be used to explain various aspects of superfluid dynamics [16, 17]. For alternative approach to describe superfluid dynamics from Schrödinger-type equation, see [38, 39].

According to Gross, Pitaevskii, Ginzburg, wavefunction of N bosons of a reduced mass m^* can be described as [40]

$$-\left(\frac{\hbar^2}{2m^*}\right)\nabla^2\psi + \kappa|\psi|^2\psi = i\hbar\frac{\partial\psi}{\partial t}. \quad (16)$$

For some conditions, it is possible to replace the potential energy term in equation (16) with Hulthen potential. This substitution yields

$$-\left(\frac{\hbar^2}{2m^*}\right)\nabla^2\psi + V_{\text{Hulthen}}\psi = i\hbar\frac{\partial\psi}{\partial t}, \quad (17)$$

where

$$V_{\text{Hulthen}} = -Ze^2\frac{\delta e^{-\delta r}}{1 - e^{-\delta r}}. \quad (18)$$

This equation (18) has a pair of exact solutions. It could be shown that for small values of δ , the Hulthen potential (18) approximates the effective Coulomb potential, in particular for large radius

$$V_{\text{Coulomb}}^{\text{eff}} = -\frac{e^2}{r} + \frac{\ell(\ell+1)\hbar^2}{2mr^2}. \quad (19)$$

By inserting (19), equation (17) could be rewritten as

$$-\left(\frac{\hbar^2}{2m^*}\right)\nabla^2\psi + \left[-\frac{e^2}{r} + \frac{\ell(\ell+1)\hbar^2}{2mr^2}\right]\psi = i\hbar\frac{\partial\psi}{\partial t}. \quad (20)$$

For large radii, second term in the square bracket of LHS of equation (20) reduces to zero [41],

$$\frac{\ell(\ell+1)\hbar^2}{2mr^2} \rightarrow 0, \quad (21)$$

so we can write equation (20) as

$$\left[-\left(\frac{\hbar^2}{2m^*}\right)\nabla^2 + U(x)\right]\psi = i\hbar\frac{\partial\psi}{\partial t}, \quad (22)$$

where Coulomb potential can be written as

$$U(x) = -\frac{e^2}{r}. \quad (22a)$$

This equation (22) is nothing but Schrödinger equation (1), except for the mass term now we get mass of Cooper pairs. In other words, we conclude that it is possible to re-derive Schrödinger equation from simplification of (Gross-Pitaevskii) Ginzburg-Landau equation for superfluid dynamics [40], in the limit of small screening parameter, δ . Calculation shows that introducing this Hulthen effect (18) into equation (17) will yield essentially similar result to (1), in particular for small screening parameter. Therefore, we conclude that for most celestial quantization problems the result of TDGL-Hulthen (20) is *essentially* the same with the result derived from equation (1). Now, to derive gravitational Bohr-type radius equation (11) from Schrödinger equation, one could use Nottale's scale-relativistic method [2, 3].

4 Concluding remarks

What we would emphasize here is that this derivation of Schrödinger equation from (Gross-Pitaevskii) Ginzburg-Landau equation is in good agreement with our previous conjecture that equation (6) implies macroquantization corresponding to superfluid-quantized vortices. This conclusion is the main result of this paper. Furthermore, because Ginzburg-Landau equation represents superfluid dynamics at low-temperature [40], the fact that we can derive quantization of celestial systems from this equation seems to support the idea of Bose-Einstein condensate cosmology [42, 43]. Nonetheless, this hypothesis of Bose-Einstein condensate cosmology deserves discussion in another paper.

Above results are part of our book *Multi-Valued Logic, Neutrosophy, and Schrödinger Equation* that is in print.

Acknowledgments

The authors would like to thank to Profs. C. Castro, A. Rubcic, R. M. Kiehn, M. Pitkänen, E. Scholz, A. Kaivarainen and E. Bakhoun for valuable discussions.

References

1. Kiehn R. M. An interpretation of wavefunction as a measure of vorticity. <http://www22.pair.com/cscd/pdf/cologne.pdf>.
2. Nottale L., et al., *Astron. Astrophys.*, 1997, v. 322, 1018.
3. Nottale L. *Astron. Astrophys.*, 1997, v. 327, 867-889.
4. Fischer U. W. arXiv: cond-mat/9907457 (1999).
5. Englman R. and Yahalom H. arXiv: physics/0406149 (2004).
6. Nottale L., Schumacher G., Levefre E. T. *Astron. Astrophys.*, 2000, v. 361, 379-387.
7. Rubcic A. and Rubcic J. The quantization of solar-like gravitational systems. *Fizika B*, 1998, v. 7(1), 1-13.
8. Agnese A. G. and Festa R. Discretization of the cosmic scale inspired from the Old Quantum Mechanics. *Proc. Workshop on Modern Modified Theories of Grav. and Cosmology*, 1997; arXiv: astro-ph/9807186.
9. Fischer U. W. arXiv: cond-mat/9907457.
10. Aharonov Y., et al. arXiv: quant-ph/0311155.
11. Hofer W. A. arXiv: physics/9611009; quant-ph/9801044.
12. Hooft G. arXiv: quant-ph/0212095.
13. Blasone M., et al. arXiv: quant-ph/0301031.
14. Rosu H. C. arXiv: gr-qc/9411035.
15. Oudet X. The quantum state and the doublets. *Annales de la Fondation Louis de Broglie*, 2000, v. 25(1).
16. Zurek W. Cosmological experiments in superfluids and superconductors. *Proc. Euroconference Formation and Interaction of Topological Defects*, ed. A. Davis and R. Brandenberger, Plenum, 1995; arXiv: cond-mat/9502119.
17. Volovik G. Superfluid analogies of cosmological phenomena. arXiv: gr-qc/0005091.
18. Volovik G. Links between gravity and dynamics of quantum liquids. *Int. Conf. Cosmology. Relativ. Astrophysics. Cosmoparticle Physics (COSMION-99)*; arXiv: gr-qc/0004049.
19. Volovik G. arXiv: gr-qc/0104046.
20. Nozieres P. and Pines D. The theory of quantum liquids: Superfluid Bose Liquid. Addison-Wesley, 1990, 116-124.
21. Winterberg F. Z. *Naturforsch.*, 2002, v. 57a, 202-204; presented at 9th Canadian Conf. on General Relativity and Relativ. Astrophysics, Edmonton, May 24-26, 2001.
22. Winterberg F. Maxwell's aether, the Planck aether hypothesis, and Sommerfeld's fine structure constant. <http://www.znaturforsch.com/56a/56a0681.pdf>.
23. Kaivarainen A. arXiv: physics/020702.
24. Kaivarainen A. Hierarchic models of turbulence, superfluidity and superconductivity. arXiv: physics/0003108.
25. Wiegmann P. arXiv: cond-mat/9808004.
26. Schrieffer J. R. Macroscopic quantum phenomena from pairing in superconductors. Lecture, December 11th, 1972.
27. Coles P. arXiv: astro-ph/0209576.
28. Christianto V. *Apeiron*, 2004, v. 11(3).
29. NASA News Release (Jul 2005), <http://www.nasa.gov/vision/universe/solarsystem/newplanet-072905.html>.
30. *BBC News* (Oct 2004), <http://news.bbc.co.uk/1/hi/sci/tech/4730061.stm>.
31. Brown M., et al. *ApJ. Letters*, Aug. 2004; arXiv: astro-ph/0404456; *ApJ.*, forthcoming issue (2005); astro-ph/0504280.
32. Brown M. (July 2005), <http://www.gps.caltech.edu/~mbrown/planetlila/>.
33. de Andrade L. G. and Sivaram C. arXiv: hep-th/9811067.
34. Godfrey S. P., et al. A new interpretation of oscillating flow experiments in superfluid Helium II, *J. Low Temp. Physics*, Nos. 112, Oct 2001.
35. Gibson C. and Schild R. arXiv: astro-ph/0306467.
36. Griv E. and Gedalin M. The formation of the Solar System by Gravitational Instability. arXiv: astro-ph/0403376.
37. Anandan J. S. *Quantum Coherence and Reality, Proc. Conf. Fundamental Aspects of Quantum Theory*, Columbia SC., ed. by J. S. Anandan and J. L. Safko, World Scientific, 1994; arXiv: gr-qc/9504002.
38. Varma C. M. arXiv: cond-mat/0109049.
39. Lipavsky P., et al. arXiv: cond-mat/0111214.
40. Infeld E., et al. arXiv: cond-mat/0104073.
41. Pitkänen M. <http://www.physics.helsinki.fi/~matpitka/articles/nottale.pdf>.
42. Trucks M. arXiv: gr-qc/9811043.
43. Castro C., et al. arXiv: hep-th/0004152.

A Cantorian Superfluid Vortex and the Quantization of Planetary Motion

V. Christianto, vxianto@yahoo.com

This article suggests a preliminary version of a Cantorian superfluid vortex hypothesis as a plausible model of non-linear cosmology. Though some parts of the proposed theory resemble several elements of what have been proposed by Consoli (2000, 2002), Gibson (1999), Nottale (1996, 1997, 2001, 2002a), and Winterberg (2002b), it seems such a Cantorian superfluid vortex model instead of superfluid or vortex theory alone has *never* been proposed before. Implications of the proposed theory will be discussed subsequently, including prediction of some new outer planets in solar system beyond Pluto orbit. Therefore further observational data is recommended to falsify or verify these predictions. If the proposed hypothesis corresponds to the observed facts, then it could be used to solve certain unsolved problems, such as gravitation instability, clustering, vorticity and void formation in galaxies, and the distribution of planet orbits both in solar system and also exoplanets.

Keywords: multiple vortices, superfluid aether, nonlinear cosmology, gravitation instability, Bose-Einstein condensate, Cantorian spacetime, fluid dynamics.

Introduction

In recent years, there has been a growing interest in the quantum-like approach to describe orbits of celestial bodies. While this approach has not been widely accepted, motivating idea of this approach was originated from Bohr-Sommerfeld's hypothesis of quantization of angular momentum, and therefore it has some resemblance with Schrödinger's wave equation (Chavanis 1999, Nottale 1996, Neto *et al.* 2002). This application of wave mechanics to large-scale structures (Coles 2002) has led to several impressive results in terms of the prediction of planetary semimajor axes, particularly to predict orbits of exoplanets (Armitage *et al.* 2002, Lineweaver *et al.* 2003, Nottale *et al.* 1997, 2000, Wel Drake 2002). However, a question arises as how to describe the physical origin of wave mechanics of such large-scale structures. This leads us to hypothesis by Volovik-Winterberg of superfluid phonon-roton as quantum vacuum aether (Volovik 2001, Winterberg 2002a, 2002b).

In this context, gravitation could be considered as result of diffusion process of such Schrödinger-like wave equation in the context of Euler-Newton equations of motion (Kobelev 2001, Neto *et al.* 2002, Rosu 1994, Zakir 1999, Zurek 1995). And large-scale structures emerge as condensed objects within such a quantum vacuum aether.

In the mean time, despite rapid advancement in theoretical cosmology development, there are certain issues that remain unexplainable in the presently available theories; one of these issues concern the origin and nature of gravitation instability (Coles 2002, Gibson 1999). Recent studies that have incorporated condensation, and void formation occurring on the non-acoustic density nuclei produced by turbulent mixing, appear to indicate that the universe is inherently *nonlinear* nature. Thus a very different nonlinear

cosmology is emerging to replace the presently accepted linear cosmology model.

For instance, recently Gibson (1999) suggested that the theory of gravitational structure formation in astrophysics and cosmology should be revised based on *real* fluid behavior and turbulent mixingⁱ theory, which leads us to nonlinear fluid model. His reasoning of this suggestion is based on the following argument: “*The Jeans theory of gravitational instability fails to describe this highly nonlinear phenomenon because it is based on a linear perturbation stability analysis of an inadequate set of conservation equations excluding turbulence, turbulent mixing, viscous forces, and molecular and gravitational diffusivity.*” This is because Jeans’ theory neglects viscous and nonlinear terms in Navier-Stokes *momentum equations*, thus reducing the problem of gravitational instability in a nearly uniform gas to one of linear acoustics.ⁱⁱ

In related work, Nottale (1996, 1997) argued that equation of motion for celestial bodies could be expressed in terms of a scale-relativistic Euler-Newton equation.ⁱⁱⁱ By separating the real and imaginary part of Schrödinger-like equation, he obtained a generalized Euler-Newton equation and the continuity-equation (which is therefore now part of the dynamics), so the system becomes (Nottale 1997, Nottale *et al.* 2000 p. 384):

$$m.(\partial / \partial t + V \cdot \nabla)V = -V(\mathbf{f} + Q) \quad (1a)$$

$$\partial \mathbf{r} / \partial t + \text{div}(\mathbf{r}V) = 0 \quad (1b)$$

$$\Delta \mathbf{f} = -4pG\mathbf{r} \quad (1c)$$

It is clear therefore Nottale’s basic Euler-Newton equations above, while including the inertial vortex force, neglect viscous terms ($-\nu \Delta \mathbf{V}$) in Navier-Stokes momentum equations,^{iv} so his equations will obviously lead us to certain reduction of gravitational instability

phenomena similar to Jeans' theory. Though Nottale's expression could offer a plausible explanation on the origin of *dark energy* (Ginzburg 2002, Nottale 2002a p. 20-22, Nottale 2002b p. 13-14), his expression appears to be not complete enough to explain other phenomena in a nonlinear cosmology, such as clustering, gravitation condensation and void formation.

Therefore the subsequent arguments will be based on a more complete form of Navier-Stokes equations including inertial-vortex force (Gibson 1999). Furthermore in the present article, two basic conjectures are proposed, i.e.

- (i) in accordance with Thouless *et al.* (2001), it is proposed here: Instead of using the Euler-Lagrange equation, '*the nonlinear Navier-Stokes equations are applicable to represent the superfluid equations of motion*'. By doing so we can expect to obtain an extended expression of Nottale's Euler-Schrödinger equations (Nottale 1996, 1997, 2000, 2001, 2002a).
- (ii) by taking into consideration recent developments in Cantorian spacetime physics, particularly by Castro *et al.* (2000, 2001) and Celerier & Nottale (2002), we propose that *modeling the universe using superfluid aether is compatible (at least in principle) with Nottale's scale relativity framework*. This is the second basic conjecture in this article.^v

Accordingly, this article suggests that the nonlinear dynamics of Cantorian vortices in superfluid aether can serve as the basis of a nonlinear cosmological model. The term 'Cantorian' here represents the notion of 'transfinite set' introduced by Georg Cantor.^{vi} Recently this term has been reintroduced for instance by Castro *et al.* (2000) and Castro & Granik (2001) to describe the exact dimension of the universe. As we know, a transfinite set is associated with the mapping

of a set onto itself, producing a ‘*self-similar*’ pattern. This pattern is observed in various natural phenomena, including turbulence and tropical hurricane phenomena.

Turbulence usually occurs when conditions of low viscosity and high-speed gradients are present. A turbulent fluid can be visually identified by the presence of *vortices*. As we know, a flow pattern, whose streamlines are concentric circles, is known as circular vortex (vortice). If the fluid particle rotates around its own axis, the vortex is called rotational. Such vortices continually form and evolve over time, giving rise to highly complex motions. In this context, vortices are defined as the curl of the velocity ($\nabla \times \mathbf{V}$) in Navier-Stokes equations.^{vii} Landau describes turbulence as a superposition of an *infinite* number of vortices, with sizes varying over all scales (this ‘*all scales*’ notion leads us to Cantorian term). From the large scale vortices, energy is transmitted down to smaller ones without loss. The energy of the fluid is finally dissipated to the environment when it reaches the smallest vortices in the range of scales. The solutions to the velocity field are unique when the helicity $= \mathbf{v} \cdot \text{curl } \mathbf{v} = 0$; otherwise the solutions are not unique.

As we know, real fluid flow is never irrotational, though the mean pattern of turbulent flow outside the boundary layer resembles the pattern of irrotational flow. In rotational flow of real fluids, vorticity can develop as an effect of viscosity. Provided other factors remain the same, vortices can neither be created nor destroyed in a non-viscous fluid. Since the vortex moves with the fluid, vortex tube retain the same fluid elements and these elements retain their vorticity. The term ‘vorticity’ here is defined as the number of circulations in a certain area, and it equals to the circulation around an elemental surface divided by the area of the surface (supposing such vortex lattice exists within equal distance).^{viii}

In quantum fluid systems like superfluidity, such vortices are subject to quantization condition of integer multiples,^{ix} i.e. they are present in certain N number of atoms, as experimentally established in the superfluid phase of ⁴He,

$$\oint v_s \cdot dl = 2\pi \cdot n\hbar / m_4 = n\kappa_0 \quad (12)$$

where m_4 is the helium particle mass, and κ_0 is the quantum of circulation (Nozieres & Pines 1990, Thouless *et al.* 2001). Furthermore, quantized vortices is a topological excited state, which takes form of circulation with equidistance distribution known as vorticity (Carter 1999, Kiehn 2001). Usually the Landau two-fluid model is used, with a normal and superfluid component. The normal fluid component always possesses some nonvanishing amount of viscosity and mutual friction; therefore it could exhibit quantum vorticity as observed in Ketterle's experiments.

A 'Cantorian vortex' can be defined in simple terms as tendency of the dynamics of both fluids and superfluids to produce multiple regions of vortex and circulation structures at various *scales* (Barge & Sommeria 1995, Castro *et al.* 2002, Chavanis 1999, Kobelev 2001, Nozieres & Pines 1990, Volovik 2000b, 2000c). In principle, the notion of Cantorian Superfluid Vortex suggests that there is a tendency in nature, particularly at the astronomical level scale, to produce mini vortices within the bigger vortices *ad infinitum*. Though some parts of the proposed theory resemble several elements of what have been proposed by Consoli (2000, 2002), Gibson (1999), Nottale (1996, 1997, 2001, 2002a), Volovik (2000a, 2000b, 2001), and also Winterberg (2002a, 2002b), to the author's present knowledge the idea of using a Cantorian superfluid vortex model instead of (ordinary) superfluid model or vortex theory alone has *never* been proposed before. The Cantorian term here implies that such a superfluid vortice is—in accordance with Landau's definition of

turbulence—supposed to exist both as quantum vacuum aether background (micro phenomena) and as representation of various condensed objects such as neutron stars (macro phenomena). The proposed hypothesis results in a non-homogenous isotropic Euclidean flat-spacetime expanding universe at *all scales*, but *without* a cosmological constant. This cosmology constant nullity is somewhat in accordance with some recent articles, for instance by Guendelman *et al.* (2002), Volovik (2001), and Winterberg (2002a, 2002b).

Implications of the proposed model will be discussed subsequently, where first results of the method yield improved prediction of three new planets in outer planet orbits of the solar system beyond Pluto. If the predictions of the proposed hypothesis correspond to the observed facts, it is intuitively conjectured that the proposed theory could offer an improved explanation for several unexplainable things (at least not yet in a quantifiable form) in regards to the origin of gravitation instability, void formation, and unifying gravity and quantum theory.

A review of recent developments

Throughout the last century of theoretical physics since Planck era, physicists have investigated almost every conceivable idea of how geometry can be used or modified to describe physical phenomena. For instance, Minkowski refined his 4D spacetime-geometry to explain Einstein's STR. Others have come up with 5D (Kaluza-Klein), 6D, and then ten D, eleven D, and recently 26D (bosonic string theory as a dual resonance model in 26D; see Winterberg 2002a). It seems like the number of geometrical dimensions simply grow with time. We could also note a considerable amount of study has been devoted to geometry with infinite-dimension or Hilbert space.

However, recently it seems there is also a reverse drift of simplifying these high dimensional (integer) numbers, for instance by use of the replacement of the dual resonance model in 26D with QCD in 4D to describe nuclear forces; and by using of the aforementioned analogies between Yang-Mills theories and *vortex dynamics*, there is a suggestion that string theory should perhaps be reinstated by some kind of vortex dynamics at the Planck scale (Winterberg 2002a). Furthermore, Castro *et al.* (2000, 2001) have proposed that the *exact* dimension of the universe is only a bit higher than Minkowskian 4D (less than 5D). They arrived at this conclusion after reconciling Cantorian spacetime geometry with the so-called Golden Section. Therefore instead of proposing a trivial argument over which geometry is superior, this article proposing accepting the hypothesis that the Cantorian fractal spacetime dimension as proposed by Castro *et al.* (2000) can be the *real* geometric dimension of the universe. This fractal dimension will be called the Cantorian-Minkowski dimension. This conjecture is somewhat in accordance with a recent suggestion made by Kobelev (2001) that Newton equation is a diffusion equation of multifractal universe.

In the mean time, despite the fact that most theoretical physics efforts are devoted toward the proper expressions of fields, fields are not the only objects which one can think as occupying spacetime, there are also fluids. When there is no equation of state specified they are *more general* than fields (Roberts 2001).^x In this regards quantum fluids, which are usually understood as a limited class of objects used to describe low-temperature physics phenomena, have in recent years been used to model various cosmological phenomena, for instance neutron stars (Andersson & Comer 2001, Elgaroy & DeBlasio 2001, Sedrakian & Cordes 1997, Yakovlev 2000). It is not surprising therefore that there is increasing research in using superfluid model to

represent cosmology dynamics (Liu 2002, Roberts 2001, Volovik 2000a, 2000b, 2000c, 2001, Zurek 1995).

In this context, it is worth noting here some recent development in superfluidity research. This direction of research includes application of NLSE (Nonlinear Schrödinger equation) as a model of the Bose-Einstein condensate under various conditions (Quist 2002). There are also NLSE proposals representing Cantorian fractal spacetime phenomena (Castro *et al.* 2002). Experiments on Bose-Einstein condensates have now *begun to address vortex systems*. Superfluid turbulence issues and its explanation in terms of quantum *vortex dynamics* have become one of the most interesting physics research these days (Volovik 2000a, 2002b, Zurek 1995). For instance, recent experiments in the past few years showed that some turbulent flows of the superfluid phase of ^4He (helium II) are similar to analogous turbulent flow in a classical fluid (Thouless *et al.* 2001). In theoretical realm, there is also new interest in the relationship between the topology (broken by reconnections, hence release of energy) and the geometry of structure—sometimes known as *topological defects* in cosmology (Yates 1996, Zurek 1995)—which cannot be changed arbitrarily as done traditionally by topologists but changes according to the dynamics (NLSE or Navier-Stokes equation^{xi}).

Winterberg (2002a) has suggested that the universe can actually be considered an Euclidean flat-spacetime provided we include superfluid aether quantum vacuum into the model. Winterberg's aether is a densely filled substance with an equal number of positive and negative Planck masses $m_p = \sqrt{(hc/G)}$ which interact locally through contact-type delta-function potentials. In the framework of this approach Winterberg (2002a, 2002b) has shown that quantum mechanics can be derived as an approximate solution of the Boltzmann equation for the Planck aether masses. The particle in his model is a formation appeared as result of the interaction between the

positive and negative Planck masses similar to the phonon in a solid. This suggestion is seemingly in a good agreement with other study of gravity phenomena as long wave-length excitation of Bose-Einstein condensate by Consoli (2000, 2002). Consoli (2000) noted that the basic idea that gravity can be a long-wavelength effect induced by the peculiar ground state of an underlying quantum field theory leads to considering the implications of spontaneous symmetry breaking through an elementary scalar field. He pointed out that Bose-Einstein condensation implies the existence of long-range order and of a gapless mode of the Higgs-field. This gives rise to a $1/r$ potential and couplings with infinitesimal strength to the inertial mass of known particles. If this is interpreted as the origin of Newtonian gravity one finds a natural solution of the hierarchy problem. In the spirit of Landau, Consoli (2000, 2002) has also considered similarity between his condensate model and superfluid aether hypothesis. Furthermore, he also suggested: “*all classical experimental tests of general relativity would be fulfilled in any theory incorporating the Equivalence Principle.*”

Furthermore, recently Celerier & Nottale (2002) have shown that the Dirac equation can be derived from the scale relativity theory. Since the Dirac equation implies the existence of aether, this derivation can be interpreted as: modeling superfluid aether in the universe is compatible (at least in principle) with Nottale’s scale relativity framework.^{xiii} Nottale’s conjecture on the applicability of the Schrödinger equation to describe macroscopic phenomena (up to astronomic scale) seems also to imply the presence of a certain form of fluid (aether) as the medium of vacuum quantum fluctuation or a zero point field (Roberts 2001). And because the only type of matter capable of resembling such quantum phenomena macroscopically is Bose-Einstein condensate or its special case superfluid (Consoli 2000,

2002), then this leads us to a conjecture that the *aether medium is very likely a quantum fluid*.

Combining the character of these selected recent developments, this article suggests that the nonlinear wave dynamics of Cantorian vortices of superfluid aether can serve as the basis of a nonlinear cosmological model, which will be capable of describing various phenomena including a plausible mechanism of continuous particle generation in the universe. The preceding work (albeit somewhat controversial from the present accepted view) suggests that this alternative and nonlinear cosmological model shall include: (a) an aether, (b) Euclidean flat spacetime^{xiii}, (c) vortex dynamics, (d) superfluid (Bose-Einstein condensate), and (e) fractal phenomena—as the basis of real physical model and also the theoretical analysis of nonlinear cosmology. It is the opinion of this author that a proper combination will lead us to a consistent real model.

Therefore, in theoretical terms this article argues in favor of combining *Cantorian-Minkowski geometry with Nottale-Gibson-Winterberg's vortex of superfluid aether*. The proposed model results in a Euclidean flat spacetime with some fluctuations induced by fractal phenomena (expressed as a non-integer dimension in Cantorian universe) arising from multiple vortices. A real physically-observed model is chosen here instead of geometrical construct, because it will directly lead us to a set of experimental tests which can be used to determine if the model is not valid. With regards to superfluidity research, perhaps the conjectures of this article can be considered as extending Volovik's (2000a, 2000b, 2001) superfluid theory to Cantorian spacetime case.

A derivation of the basic vortex model and quantization of semimajor axes

The Schrödinger equation of wave mechanics can be interpreted as a description for the tendency of micro aggregates of matter to make structures. In this regards, Nottale (1993, 1996, 1997) put forth a conjecture that spacetime is *non-differentiable*,^{xiv} which led to a fractal version of the Schrödinger-like equation capable of predicting the semimajor axes of both planetary-like systems as well as micro orbits at molecular level. This reasoning could be considered as an alternative interpretation of Ehrenfest Theorem.

However, such a quantum-like approach in a large-scale structure has not been widely accepted (Coles 2002), for the quantization of macroscopic systems is something outside the scope of known physics (Neto *et al.* 2002). Nevertheless, some possible origins for such effects have been outlined. For instance Bohr-Sommerfeld's hypothesis of quantization of angular momentum, appears to be more direct than the Schrödinger-like equation, at least for (planar case of) planetary orbits in the solar system. For a spherical case (for some exoplanet systems) we should derive solution of the Schrödinger-like equation.

As we know, for the wave function to be well defined and single-valued, the momenta must satisfy Bohr-Sommerfeld's quantization conditions (Van Holten 2001):

$$\oint_{\Gamma} p \cdot dx = 2\mathbf{p} \cdot n\hbar \quad (3)$$

for any closed classical orbit Γ . For the free particle of unit mass on the unit sphere the left-hand side is

$$\int_0^T v^2 .dt = \mathbf{w}^2 .T = 2\mathbf{p} .\mathbf{w} \quad (3a)$$

where $T = 2\pi/\omega$ is the period of the orbit. Hence the quantization rule amounts to quantization of the rotation frequency (the angular momentum): $\mathbf{w} = n\hbar$.

Then the force balance relation of Newton's equation of motion:

$$GMm/r^2 = mv^2/r \quad (3b)$$

Using Bohr-Sommerfeld's hypothesis of quantization of angular momentum (3a), a new constant g was introduced (which plays the role of a gravitational analog of the Planck constant):

$$mvr = ng/2\mathbf{p}$$

Just like in the elementary Bohr theory (before Schrödinger), this pair of equations yields a known simple solution for the orbit radius for any quantum number of the form:

$$r = n^2 .g^2 / (4\mathbf{p}^2 .GM .m^2) \quad (5)$$

or

$$r = n^2 .GM / v_o^2 \quad (6)$$

where r , n , G , M , v_o represents semimajor axes, quantum number ($n = 1, 2, 3, \dots$), Newton gravitation constant, and mass of the nucleus of orbit, and specific velocity, respectively. In this equation (6), we denote

$$v_o = (2\mathbf{p} / g) .GMm \quad (6a)$$

This result (6) is the same as Nottale's basic equation for predicting semimajor axes of planetary-like systems (Nottale 1996, Nottale *et al.* 1997, 2000). It can be shown that equation (6) could be derived directly from the Schrödinger equation for planar case (Christianto

2001), therefore it represents the solution of the Schrödinger equation for *planar axisymmetric cylindrical case*. The value of m is an adjustable parameter (similar to g). For a planetary system including exoplanets Nottale *et al.* (1997, 2000) has found the specific velocity v_0 is ± 144 km/s. Therefore this equation (6) implies the semimajor axes distribution can be predicted from a sequence of quantum numbers. This equation (5) is also comparable with Neto *et al.*'s (2002) approach, where they propose $m = 2.1 \times 10^{26}$ kg (the average mass of the planets in solar system).

It is worth noting here Nottale *et al.* (1997, 2000) reported this equation (6) agrees very well with observed data including those for exoplanets, and particularly for *inner planet orbits* in the solar system. Indeed the number of exoplanets found has increased fivefold since their first study (Nottale *et al.* 2000). However, a question arises when we compare this prediction with *outer planet orbits* in the solar system, since this results in very low predictions compared with observed data, i.e. 52.6% for Jupiter, 36.3% for Saturn, 22.3% for Uranus, 17.2% for Neptune, and 15.6% for Pluto. Therefore, Nottale (1996) proposed to use a different value for v_0 to get the distribution of outer planets (the so-called Jovian planets).

Nottale (1996) proposed a plausible explanation for this discrepancy by suggesting outer planets from Jupiter to Pluto are part of different systems since they apparently consist of *different* physical and chemical planetary compositions, so we can expect two different diffusion coefficients for them. Therefore he proposed the following relation to predict orbits of inner planets and outer planets (Nottale 1996, p. 51) $a = n.(n + \frac{1}{2}).a_0$. Nottale then suggested the proper values are $a_{0,inner} = 0.038025\text{AU}$ for inner orbits and $a_{0,outer} = 1.028196\text{AU}$ for outer orbits, and based on these values the discrepancy in predicting outer planet distribution can be reconciled.

While Nottale's (1996, p. 53) description on these different chemical and physical compositions, distribution of mass, and distribution of angular momentum seem to be at least near to right, he did not offer any explanation of *why* there are different chemical and physical compositions if these outer planets were generated by the same Sun in the past. Nottale's proposed equation was based on the second quantum number l , derived from Schrödinger-type equation for *spherical case*. However, it should be noted that while the second quantum number could plausibly explain the different orbits for outer planets, it cannot provide any explanation for their different chemical and physical compositions. Therefore, this leads us to a conjecture, i.e. these *differences of planetary distribution and different chemical and physical compositions of the outer planets in the solar system are the consequences of the interaction of a negative mass (star) with the Sun*.^{xv} From this author's opinion, it seems only through using this conjecture we could explain why the outer planets are physico-chemically different from the inner planets. From this conjecture, then we reinterpreted Nottale's conjecture that Jupiter should be the second planet ($n = 2$) in the outer orbit system, to obtain predicted values of semimajor axes of those Jovian planets, based on the notion of reduced mass μ . The result of this approach will be described subsequently.

Another plausible explanation of the outer planets distribution has been suggested by Chavanis (1999) based on *two-fluids model*. However, while this suggestion is in good agreement with observation of outer planet orbits, in the author opinion it also does not offer a convincing argument for the difference of chemical and physical composition *if* those inner and Jovian planets were generated by the same Sun.

Now let's turn our attention to the implications of equation (6) in regards to the basic vortex model. If T is the orbit period of the above planet around the Sun, then by Kepler's third law,

$$r^3 \approx T^2 \approx (2\pi r / v)^2 \quad (7)$$

Or

$$v^2 r \approx 4\pi^2 = k_{spring}$$

where r , T , v , k_{spring} represents semimajor axes, orbit period, orbit velocity, and 'spring constant' of the dynamics system, respectively.^{xvi} For gravity case, one obtains $k_{spring} = G.M$. We remark here this constant k_{spring} could be comparable with Nottale's (Nottale *et al.* 2000) notion of parameter $D = G.M/2\omega$; thus $k_{spring} = D.2\omega = D.2\alpha_g c$. This alternative expression comes from the definition of gravitation coupling constant $\alpha_g = \omega/c$, where $\alpha_g^{-1} = 2072 \pm 7$ (Nottale *et al.* 2000).

By observing the above expressions, we conclude that equation (8) has the same basic form of Nottale's equation (6). We also note here Nozieres & Pines (1990) suggested that a vortex structure exists in a superfluid if its velocity is *radius-dependent* ($v = f(1/r)$). Since from equation (8) the quadratic of velocity is radius-dependent $v^2 = (k/r)$, we propose here that equation (8) also implies a *special case* of vortex motion. Therefore, we conclude equation (6) also implies a vortex motion. This seems to be in agreement with Nottale *et al.*'s (1997, 2000) assertion that specific velocity $v_o = 144$ km/s represents a new fundamental constant observed from the planetary up to extragalactic scale.

In order to generalize further equation (6), we proposed using Kobelev's (2001) idea that Newton's equations may be treated as a diffusion process in a multi-fractal universe. Provided such a relationship exists, we could conclude that equation (6) implies a

Cantorian fractality of vortex structure in the universe. But a question arises here as to whether a scaling factor is required to represent equation of motion of celestial bodies at various scales using equation (6). Therefore, by using a fractional derivative method as described by Kolwankar (1998, eq. 2.9), then

$$d^q f(\mathbf{bx})/[dx]^q = \mathbf{b}^q \cdot \{d^q f(\mathbf{bx})/[d(\mathbf{bx})]^q\} \quad (9)$$

where it is assumed that for $dx \rightarrow 0, d(\mathbf{bx}) \approx dx$. Hence this author obtained (Christianto 2002b) a linear scaling factor for equation (6):

$$a_0 = \mathbf{f} \cdot n^2 \cdot GM / v_o^2 \quad (10)$$

This equation implies :

$$v_1^2 = (v_o^2 / \mathbf{f}_o) \quad (11)$$

In other words, for different scaling reference frames, specific velocity v_1 may vary and may be influenced by a scale effect ϕ . To this author's present knowledge, such a scaling factor has never appeared before elsewhere; neither in Nottale's work (1996, 1997, 2001, 2002) nor in Neto *et al.* (2002). A plausible reason for this is that Nottale's and Neto *et al.*'s theory were intended to describe planetary orbits only.

A note on this interpretation is perhaps worth making. While of course this Cantorian fractality of vortex structure in the universe is not the only possible interpretation, we believe this is the nearest interpretation considering the turbulence phenomena.^{xvii} It is known that turbulent flows seem to display *self-similar* statistical properties at length scales smaller than the scales at which energy is delivered to the flow (this sometimes referred to as 'multi-fractality' of turbulence). For instance, Kolmogorov argued that at these scales, in three dimensions, the fluids display universal statistical features (Bernard 2000, Foias *et al.* 2001 p. 17, Gibson 1991, Weinan 2000).

Turbulent flow is conventionally visualized as a cascade of large vortices (large scale components of the flow) breaking up into ever smaller sized vortices (fine-scale components of the flow) – the principal cascading entity is the ‘enstrophy’.^{xviii}

Recent observational data of the similar size of semimajor axes between solar system and exoplanet systems ($a/M = 0.043 \text{ AU}/M_{\odot}$ for $n = 1$; and $a/M = 0.17 \text{ AU}/M_{\odot}$ for $n = 2$) seems to indicate that those are clusters of celestial objects at the same hierarchy (scale) of quantized vortices (Armitage *et al.* 2002, Lineweaver *et al.* 2003, Neto *et al.* 2002, Nottale *et al.* 1997, 2000, Weldrake 2002). This seems to imply that the proposed Cantorian vortices interpretation is in good agreement with observed data.

Superfluid vortices model

It is worth discussing here the *rationale* for suggesting a Cantorian superfluid aether as a real physical model for nonlinear cosmology. This brings us back in time to where GTR was first introduced (in passing we note in pre-GTR era aether hypothesis was almost entirely abandoned because of the growing acceptance of STR; see Munera 1998).

It is known that in GTR there is no explicit description of the medium of interaction in space (aether), though actually this was considered by Einstein himself in his lecture in Leiden 1921, “*Ether and Relativity*” (Einstein 1921):

*“..According to the general theory of relativity space without an ether is **unthinkable**; for in such a space there not only would be no propagation of light, but also no possibility of existence for standards of space and time (measuring-rods and clocks), nor therefore any space-time intervals in the physical sense. But this ether may not*

be thought of as endowed with the quality characteristic of ponderable media, as consisting of parts which may be tracked through time. The idea of motion may not be applied to it.”

A perfect fluid in GTR is therefore could be thought of as a liquid medium with no viscosity and no heat induction. Such a perfect fluid is basically a special case of quantum liquid or superfluid (Nozieres & Pines 1990). We note the term ‘special case’ because the superfluid here should be able to represent non-ponderable (weightless) characteristic of the aether medium, though perhaps it could have motion.

It is clear therefore aether is inherently implied in a GTR geometrical construct (see also Consoli 2002). Furthermore, it is possible to explain the frame dragging phenomena in a GTR geometrical construct as it is actually a fluid vortex—with a massive object in its vortex centre (Prix 2000)—capturing a volume of surrounding fluid and entraining its rotation.

In Maxwell’s hypothesis, aether is a frictionless fluid. Based on this conjecture Winterberg (2002a, 2002b) has proposed an aether model, which consists of a quantum fluid made up of Bose particles. This analogy leads to the Planckian aether hypothesis which makes the assumption the vacuum of space is a kind of plasma (see also Roberts 2001). The ultimate building blocks of matter are Planck mass particles obeying the laws of classical Newtonian mechanics, but there are also *negative* Planck mass particles. Furthermore, with the Planck aether having an equal number of positive and negative Planck mass particles, the cosmological constant is zero and the universe is Euclidean flat-spacetime. In its groundstate the Planck aether is a two component positive-negative mass superfluid with a *phonon-roton* energy spectrum for each component.

The theory of superfluid vortices is based upon various versions of the Landau's two-component fluid model (Godfrey *et al.* 2001), and is adequately described by many researchers (Kivshar *et al.* 1998, Quist 2002, Thouless *et al.* 2001, Tornkvist & Schroder 1997, Volovik 2000c, 2001, Zurek 1995). For applications to Cosmology, it is presumed that the "vacuum" is a superfluid-like continuum in which the formation of topological defects as "vortices" generates the stars and galaxies as components of the normal fluid. The diffusive and dissipative Navier-Stokes fluid equations, with constraints that lead to the Complex Ginzburg-Landau equations to describe the superfluid, form the basis of the mathematical model. The topological defects can be homogeneously defined, hence they are self-similar, and scale covariant. Such topological defect domains can support not only fractals but also quantum like integer values for their closed integrals.

The conceptual map (Figure 1) depicts how the various parts of the most recent theories could plausibly be used to form a Cantorian superfluid vortex model for nonlinear cosmology.

Conceptual Map of Cantorian Superfluid Vortex Model: A new synthesis

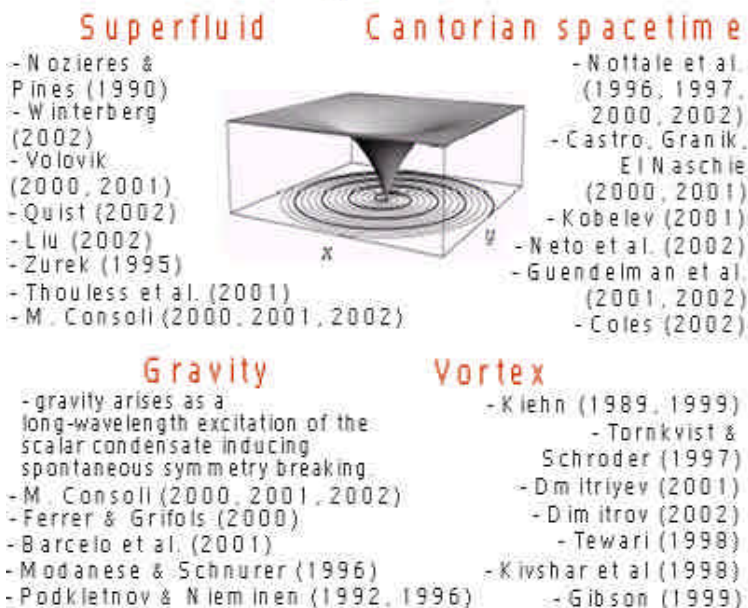

Figure 1. Conceptual map of the plausible synthesis of a Cantorian superfluid vortex model for nonlinear cosmology

Now we are going to illustrate how the equation of motion (6) is compatible with the proposed superfluid vortices model as described above. In other words, we will provide an argument to link the solution of the Schrödinger equation (6) with the solution of Navier-Stokes equations. Theoretically, R. Kiehn (1989, 1999) has shown that there is an exact mapping between the Schrödinger equation and Navier-Stokes equation, though without reference yet to its cosmological implications. Therefore now we extend his conjecture to

a cosmological setting. In order to do this, we consider two approaches here:

- Gibson's (1999) Navier-Stokes model for cosmology;
- Godfrey *et al.*'s (2001) model of superfluid vortices.

First, we note here that Gibson (1999) has shown that his Navier-Stokes-Newton model yields the following solution:

$$v_r = m'.Gt / r^2 \quad (12)$$

where r , t , G , m' , v_r represents semimajor axes, time elapsed, Newton gravitation constant, mass of the nucleus of orbit, and specific velocity, respectively. It is clear therefore that equation (12) admits mass growth rate as time elapsed, which is permitted by Gibson's Navier-Stokes model. Now we assert $v = 2pr / T$ or $r = vT / 2p = vt$, and substitute this value to one of r in equation (12). We get:

$$r = m'.G / v^2 \quad (13)$$

which is very similar to equation (6), except the expression for quadratic quantum number n^2 . A plausible reason for this missing quantum number is that Gibson (1999) assumed a normal fluid in his model instead of quantum liquid. He also argued that equation (12) only governs the formation stage (such as spiral nebulae formation); while equation (13) is also applicable for present time provided we assert a quantum liquid for the system. Therefore we also conclude again that Nottale's equation (6) *actually implies a quantum liquid as medium of interaction*.

For the second method, we note here that according to Godfrey *et al.* (2001) the analytic form of an oscillating plane boundary layer flow of superfluid vortices can be derived from the Navier-Stokes equation, and the velocity $u(z,t)$ is given by:

$$u = A.e^{-kz} . \cos(\omega t - kz) \quad (14)$$

where $k = \sqrt{(\mathbf{w}/2\nu)}$, $\mathbf{w} = 2\mathbf{p}/T$ is the angular frequency of oscillation, T is the period of oscillation, ν is the kinematic viscosity and A is an arbitrary constant. In the limit that the coupling of the superfluid and normal fluid components through mutual friction is negligible, we may take this oscillating velocity profile for the normal fluid, with the superfluid remaining at rest. Because we can assert velocity $\mathbf{u} = d\mathbf{z}/dt = d\Psi/dt$, therefore we can obtain Ψ and also its second differentiation $d^2\Psi/dt^2$. Hence we get:

$$d^2\Psi/dt^2 = -A.e^{-kz}.\sin(\mathbf{w}t - kz).\mathbf{w} \quad (15)$$

or

$$d^2\Psi/dt^2 + \mathbf{w}^2.\Psi = 0 \quad (16)$$

which is the most basic form of the Schrödinger equation. In other words, we obtain the Schrödinger equation from a velocity expression derived from the Navier-Stokes equation for superfluid vortices (Godfrey *et al.* 2001). These two methods confirm Kiehn's (1989, 1999) conjecture that there is exact mapping between the Schrödinger equation and Navier-Stokes equation *regardless* of the scale of the system considered. This conclusion, which was based on a two-fluid model of superfluid vortices, is the *main result* of this article; and to this author's present knowledge this conclusion has never been made before for the astronomical domain (neither in Chavanis 1999, Neto *et al.* 2002, nor Nottale 1996, 1997, 2001, 2002). In this author opinion, Chavanis' article (1999) is the nearest to this approach, because he already considered two-fluid model for the Schrödinger equation (though without reference to superfluidity), though he did not mention the role of Navier-Stokes equations like Gibson (1999).

A distinctive feature of this proposed superfluid vortices approach is that we could directly compare our model with laboratory observation (Volovik 2001, Zurek 1995). For instance, using this

model Godfrey *et al.* (2001) argued that the fluid at the edge of the disk moves a distance $4\phi_c R$ in a time T (with angular velocity $\omega = 2\pi/T$), thus having a critical dimensional linear velocity of

$$v_{disk} = 2\mathbf{w}\mathbf{f}_c R / \mathbf{p} \quad (17)$$

In this equation, ϕ_c represents critical amplitude where damping of the oscillations reduce to a value, which was interpreted as the damping due only to viscosity of the normal fluid component. In this regards, interpretation of the experiment is that superfluid boundary layer vortices are the cause of critical amplitude of oscillations observed. Therefore it seems we could expect to observe such critical amplitude for the motion of celestial objects. Of course for spherical orbit systems the equation of critical dimensional linear velocity is somewhat different from equation (17) above (Godfrey *et al.* 2001). To this author's present knowledge such theoretical linkage between critical amplitude of superfluid vortices and astronomical orbital motions has also never been made before; neither in Chavanis (1999), Nottale (1996, 1997, 2001, 2002), Volovik (2000a, 2000b, 2000c, 2001), nor Zurek (1995).

New planets prediction in solar system

Based on equation (6) and using Nottale's conjecture of Jupiter should be the second planet ($n=2$) in the outer orbit system, we derive predicted and observed values of semimajor axes of those outer planets. Then by using Nottale's (1996, p. 53) conjecture for quantization of galaxy pairs, and minimizing the standard deviation (s) between these observed and predicted values, we can solve equation (6) for the reduced mass μ to get the most probable distribution for outer planet orbits:

$$\mathbf{m} = (m_1.m_2)/(m_1 + m_2) \quad (18)$$

It is worth noting here, that a somewhat similar approach using reduced mass μ to derive planetary orbits has also been used by Neto *et al.* (2002), as follows:

$$-g^2 / 2\mathbf{m}(\partial^2\Psi / \partial r + \partial\Psi / r\partial r + r^{-2}.\partial^2\Psi / \partial \mathbf{j}^2) + V\Psi = E\Psi \quad (18a)$$

though Neto *et al.* (2002) did not come to the same conclusion as presented here. Result of this method (18) is presented in Table 1 below.

Msun = 0.198951 10³⁴ g k = 26.60 k.Msun = 5.29 10³⁴ g

Astroobject	Observed			Prediction based on Nottale-Ord				
	Orbit Size	r _{actual} (AU x 10) ¹	r _{actual} (10 ⁶ km)	n	r _{pred} (10 ⁶ km)	n	r _{pred} /r _{actual} (%)	(r _{pred} -r _{act}) ²
Mercury	4	3.87	57.89	1	6.40			
				2	25.60	2		
Venus	7	7.32	109.51	3	57.60	3	99.484	0.1
Earth	10	10.00	149.60	4	102.39	4	93.504	50.6
Mars	16	15.24	227.99	5	159.99	5	106.945	107.9
Hungarias ³			314.00	6	230.38	6	101.050	5.7
Asteroid ⁴			403.91	7	313.58	7	99.865	0.2
		27.00	403.91	8	409.57	8	101.400	32.0
Jupiter		31.50	471.23	9	518.36	9	110.001	2220.9
Saturn	52	52.03	778.36	2	681.01	2	87.493	9476.8
Uranus	100	95.39	1427.01	3	1532.27	3	107.376	11078.9
Neptune	196	191.90	2870.78	4	2724.04	4	94.888	21534.7
Pluto	388	301.00	4502.90	5	4256.31	5	94.524	60806.4
	722	395.00	5909.12	6	6129.08	6	103.722	48384.8
Π ₁				7	8342.36	7		
Π ₂ ⁵				8	10896.14	8		
Π ₃ ⁶				9	13790.43	9		

Table 1. Predicted orbit values of inner and outer planets in Solar system

From Table 1 above we obtain $\mu = 26.604.m_1$, for the minimum standard deviation $s = 0.76AU$.^{xix} Inserting this μ value into equation (18) and solving it, we get the most likely companion mass of $m_2 = -(26.604/25.604).m_1$. Therefore we conclude it is *very likely* there is a negative-mass star (NMS) interacting with the Sun. This NMS has a mass value of very near to the Sun but with a negative sign, so this can be considered as the dim twin-companion star of the Sun. This is somewhat comparable to what some astronomers suggest of the hypothetical 'dark star' (Damgov *et al.* 2002), though to this author's

present knowledge none of the existing astronomic literatures has considered a negative-mass star as plausible candidate of the twin-companion of the Sun. Therefore thus far, this conclusion of the plausible presence of a large negative-mass object in the solar system could only be explained using *superfluid/superconducting model* (DeAquino 2002).^{xx}

On the basis of this value of $\mu = 26.604.m_1$, we obtained a set of predicted orbit values for both inner planets and Jovian planets. For inner planets, our prediction values are very similar to Nottale's (1996) values, starting from $n=3$ for Mercury; for $n=7$ Nottale reported minor object called Hungarias; for Jovian planets from $n=2$ for Jupiter up to $n=6$ for Pluto our prediction values are also somewhat similar with Nottale's (1996) values. It is worth noting here, we don't have to invoke an *ad hoc* quantum number to predict orbits of Venus and Earth as Neto *et al.* (2002) did. We also note here that the proposed method results in prediction of orbit values, which are within a 7% error range compared to observed values, except for Jupiter which is within a 12.6% error range.

The departure of our predicted values compared to Nottale's predicted values (1996, 1997, 2001) appear in outer planet orbits starting from $n=7$. We proposed some new predictions of the possible presence of three outer planets beyond Pluto (for $n=7$, $n=8$, $n=9$) to be called here as Π_1, Π_2, Π_3 at orbits around $55.77 \pm 1.24\text{AU}$, $72.84 \pm 1.24\text{AU}$, and $92.18 \pm 1.24\text{AU}$, respectively. This prediction of most likely semimajor axes has taken into consideration standard deviation found above $s = 0.76\text{AU}$ (Table 1). Two of these predicted orbits of outer planets are somewhat in agreement with previous predictions by some astronomers on the possible presence of outer planets beyond Pluto around $\sim 50\text{AU}$ and around $\sim 100\text{AU}$ (Horner *et al.* 2001). However, it is worth noting here, the predicted planet (for $n=8$) at orbit $72.84 \pm 1.24\text{AU}$ is purely

based on equation of quantization of orbit (6) for Jovian planets. It is also worth noting here, that these proposed planets beyond Pluto are different from what is predicted by Matese *et al.* (1999), since Matese's planet is supposed to be somewhere around the outer Oort cloud.

Further remarks are worth considering here concerning predicted orbits at $n = 8$ and $n = 9$. We consider first for the case of inner orbits. It was suggested by Olber and also recently by Van Flandern in 1993 (Damgov *et al.* 2002) of a planet (or *planets*) existed until relatively recently between Mars and Jupiter, at the location where a missing planet is expected by the well-known Titius-Bode law (see Table 1 under column 'Orbit size'). As we know, Titius-Bode law was based on series of numbers 0,3,6,12,24,48,96... which then translated by factor 4. Thus we have series of 4,7,10,16,28,52,... which are supposed to be able to predict the orbit size of planets in solar system. This argument was subsequently supported by Nottale's equation except for orbits at $n = 7$ and $n = 9$, between Mars and Jupiter, which can be regarded as departure from the Titius-Bode law. However, while Nottale (1996, p. 51) has reported planets (or at least, recognizable objects) at $n = 8$ and $n = 9$ for *inner* orbit in solar system were observed, to our present knowledge no similar prediction has been made for $n = 8$ and $n = 9$ for outer orbits. Therefore new observational data is highly recommended to find the real semimajor axes of the proposed new outer planets beyond Pluto.

If these new outer planets correspond to the observational data, it is conjectured intuitively that the proposed Cantorian superfluid vortices model could offer an improved explanation for several things unexplainable (at least not yet in a observable and quantifiable form) thus far with regards to the origin of continuous particle generation, gravitation instability, and unifying gravity and quantum theory.

Notes on the superfluid experiments for cosmology: fractal superfluid

Zurek (1995) and Volovik (2000b) have proposed some aspects of superfluid analogies to describe various cosmological phenomena. However, extending this view towards Cantorian Superfluid Vortex hypothesis implies we should be able to observe fractal phenomena of superfluid and also Bose-Einstein condensate systems. While this has not become the accepted view, recent articles indicate such phenomena were *already* observed (Kivotides *et al.* 2001, 2001b, Ktitorov 2002).

In this regards, some recent observations have shown that the number of galaxies $N(r)$ within a sphere of radius r , centered on any galaxy, is not proportional to r^3 as would be expected of a homogeneous distribution. Instead $N(r)$ is proportional to r^D , where D is approximately equal to 2, which is symptomatic of distribution with fractal dimension D . It is interesting to note, that for $D=2$, the cosmological gravitational redshift gives the linear distance-redshift relation and becomes an observable phenomenon (Mittal & Lohiya 2001). This non-integer dimension is known as Hausdorff dimension d_H , which can be computed to be within the range of $1.6 \sim 2.0$ up to the scale $1 \sim 200$ Mpc (Baryshev 1994, 1999). Furthermore, transition to homogeneity distribution has not been found yet. In this regards Anderson *et al.*^{xxi} also admitted: “*These findings (of clustering and void formation) have become increasingly difficult to reconcile with standard cosmological theories, in which the approach to homogeneity at large-scales is central element.*” What more interests us here is that an extended version of Gross-Pitaevskii equation admits self-similar solutions and also it corresponds to Hausdorff dimension $d_H \sim 2$, which seems to substantiate our

hypothesis that there is exact correspondence between cosmological phenomena and condensed matter physics.^{xxii}

In principle, the proposed Cantorian Superfluid Vortex theory leads us to a fractal superfluid description of Euclidean flat-spacetime universe, which is scale-invariant and expanding at all scales, but without a cosmological constant (this was also suggested by Guendelman *et al.* 2002, Winterberg 2002a, 2002b). This Cantorian Superfluid Vortex model is inhomogeneous though it is perhaps isotropic (in accordance with Einstein-Mandelbrot Cosmological Principle; Mittal & Lohiya 2001). Gibson (1999) has also described how the nonlinear cosmology model based on Navier-Stokes equations could explain the hidden-universe problem. Furthermore, it seems that the superfluid vortice model could explain why the inner cylindrical core of earth rotates independently of the rest of the planet.^{xxiii}

It seems therefore we could expect that further research will divulge more interesting fractal phenomena of Bose-Einstein condensate and superfluid systems (somewhat related to superfluid turbulence and its damping phenomena; Godfrey *et al.* 2001), which could lead us to further generalization of the proposed Cantorian Superfluid Vortex model.

A new method to predict quantization of planetary orbits has been proposed based on a Cantorian superfluid vortex hypothesis. It could be expected that in the near future there will be more precise nonlinear cosmology models based on real fluid theory.

Acknowledgment

Special thanks goes to Prof. C. Castro for valuable discussions; to Dr. V. Dvoeglazov for kind comments; to Prof. R.M. Kiehn for insightful

suggestions and remarks during the preparation of this article; and to Phil Vermiglio (philipvermiglio@comcast.net) for proofreading.

References

1. Andersson, N., & G. Comer, "Probing neutron star superfluidity with gravitational-wave data," *arXiv:gr-qc/0110112* (2001).
2. Armitage, P.J., *et al.*, "Predictions for the frequency and orbital radii of massive extrasolar planets," *Mon.Not.R. Astron. Society*, (Apr. 2002), also published at *arXiv:astro-ph/0204001*.
3. Baryshev, Y.V., "Conceptual problems of fractal cosmology," *arXiv:astro-ph/9912074* (1999).
4. Baryshev, Y.V., *et al.*, "Facts and ideas in modern cosmology," *Vistas in Astronomy* Vol. 38 no. 4 (1994). Also in *arXiv:astro-ph/9503074*.
5. Barge, P., & J. Sommeria, "Did planet formation begin inside persistent gaseous vortices?" published in *arXiv:astro-ph/9501050*. Also in *Astronomy & Astrophysics* 19.8.2002 (1995).
6. Bernard, D., "Turbulence for (and by) amateurs," *arXiv:cond-mat/0007106* (2000), 3.
7. Carter, B., "Relativistic dynamics of vortex defects in superfluids," *Lecture notes for Les Houches winter school, Topological Defects and Non-Equilibrium Dynamics of Phase Transitions*, ed. Y. Bunkov, H. Godfrin. Also in *arXiv:gr-qc/9907039* (1999).
8. Castro, C., *et al.*, "Scale relativity in Cantorian space," *arXiv:hep-th/0004152* (2000).
9. Castro, C. & A. Granik, "Scale relativity in Cantorian space and average dimensions of our world," *Chaos, Solitons & Fractals*, Vol. 12 No. 10 (2001) 1793-1816.
10. Castro, C., J. Mahecha, & B. Rodriguez, "Nonlinear QM as a fractal Brownian motion with complex diffusion constant," *arXiv:quant-ph/0202026v1* (2002).
11. Celerier, M.N. & L. Nottale, "A scale-relativistic derivation of the Dirac Equation," *Electromagnetic Phenomena*, in press, special issue dedicated to the 75th anniversary of the discovery of the Dirac equation (Oct 2002). Published at <http://www.daec.obspm.fr/users/nottale>. Also in *arXiv:hep-th/0210027*.

12. Chapline, G., "The vacuum energy in a condensate model of spacetime," *arXiv:hep-th/9812129* (1998).
13. Chavanis, P., "Trapping of dust by coherent vortices in the solar nebula," *arXiv:astro-ph/9912087* (1999, revised 2002).
14. Christianto, V., "Scale invariance, relativity and vacuum fluctuations. Part II: Is there scale-invariant equation of motion?" (2001) available at <http://reachme.at/coolbit>.
15. Christianto, V., "On the possibility of presence of a negative mass star in solar system," (Dec 2002a) available at <http://reachme.at/coolbit>.
16. Christianto, V., "Scale effect in quantization of semimajor axes of solar-like systems" (Dec 2002b) available at <http://reachme.at/coolbit>.
17. Coles, P., "The wave mechanics of large-scale structure," *arXiv:astro-ph/0209576* (2002).
18. Consoli, M., "Gravitational forces from Bose-Einstein condensate," *arXiv:hep-ph/0002098* (2000).
19. Consoli, M., "A connection between gravity and the Higgs field," *arXiv:hep-ph/0204106* (2002).
20. Damgov, V, *et al.*, "N-body gravitational interactions: A general view and some heuristic problems," *arXiv:astro-ph/0208373* (2002).
21. De Aquino, F., "The gravitational mass at the superconducting state," *arXiv:physics/0201508* (2002).
22. De Aquino, "Some cosmological consequences of the correlation between the gravitational and inertial mass," *arXiv:physics/0205040* (2002a).
23. Dimitrov, V., "Mystery of vorticity of human dynamics as reflected in the laws of requisite vorticity," presented at the *7th International Conference of the UK Systems Society*. Univ. of York, July 2002 (2002) <http://www.uws.edu.au/vip/dimitrov/>
24. Dmitriyev, V.P., "Mechanical analogy for the wave-particle: Helix on a vortex filament," *Apeiron* Vol. 8 No. 2 (Apr 2001).
25. Einstein, A., *Sidelights on Relativity*. Methuen and Co., London (1921).
26. Einstein, A., *Relativity: The Special and the General Theory*. Random House, London (1952).
27. Elgaroy, O. & F.V. DeBlassio, "Superfluid vortices in neutron stars," *arXiv:astro-ph/0102343* (2001).

28. Foias, C. *et al.*, “Navier-Stokes equations and turbulence,” *Encyclop. Of Mathematics and its applications*, Cambridge Univ. Press (2001)
29. Forster, G., “Spiralling planets and the life zone,” <http://onelight.com/forster/spiral.doc> (2001) p. 17.
30. Geller, M.R., *et al.*, “Transverse force on quantized vortex in a superconductor,” *Phys. Rev. B*, Vol. 57 No. 14, Apr. (1998) 8119-8122.
31. Gibson, C., “Kolmogorov similarity hypothesis for scalar fields,” *Proc. Roy. Soc. Lond. A* 434, 1991, 149-164. Also in arXiv:astro-ph/9904269
32. Gibson, C., “Turbulent mixing, diffusion and gravity in the formation of cosmological structures,” *Proc. of FEDSM99*, July 18-23, 1999, San Fransisco (1999).
33. Ginzburg, V.L., “On some advances in physics and astronomy over the past three years,” *Physics-Uspexhi* 45 (2) (2002) 205-211.
34. Godfrey, S.P. *et al.*, “A new interpretation of oscillating flow experiments in superfluid Helium II,” *J. Low Temp. Physics*, Vol. 125, Nos. 112 (Oct 2001).
35. Guendelman, E.I., “Scale invariance, inflation and the present vacuum energy of the universe,” *arXiv:gr-qc/0004011* v1 (Apr 2000).
36. Guendelman, E.I., & A. Kaganovich, “Interactions from SSB of scale symmetry: applications to problems of quintessence, galaxy dark matter and fermion family,” *arXiv:hep-th/0106152* (Jun 2001).
37. Guendelman, E.I. *et al.*, “Inflation and transition to a slowly accelerating phase from SSB of scale invariance,” November 29, *arXiv:gr-qc/0211095* (2002).
38. Horner, J. *et al.*, “Biases in cometary catalogues and Planet X,” *Mon.Not.R.Astron.Society* 000, 1-16 (2001). Also published at *arXiv:astro-ph/0205150*.
39. Kiehn, R.M., “An interpretation of the wave function as a cohomological measure of quantum vorticity,” Florida, <http://www22.pair.com/cscd/pdf/cologne.pdf> (1989)
40. Kiehn, R.M., “An extension of Bohm’s Quantum Theory to include Non-gradient Potentials and the production of nanometer vortices,” <http://www22.pair.com/cscd/pdf/bohmlplus.pdf> (1999).
41. Kiehn, R.M., “Topology and turbulence,” *arXiv:physics/0102003* (2001).

42. Kim, S-H., *et al.*, “Ideal Bose gas in fractal dimensions and superfluid in porous media,” *arXiv:cond-mat/9908086* (1999).
43. Kivotides, D., *et al.*, “Fractal dimension of superfluid turbulence,” *Physical Rev. Letters* Vol. 87, Oct 8 (2001).
44. Kivotides, D., *et al.*, “Quantum signature of superfluid turbulence,” *Physical Rev. Letters* Vol. 87, Dec 31 (2001b).
45. Kivshar, Y., *et al.*, “Dynamics of optical vortex solitons,” *Optics Communications* 152, Elsevier (1998) 198-206.
46. Kobelev, L. Ya., “Generalized Riemann-Liouville fractional derivatives for multifractal sets,” *arXiv:math.CA/0002008* (2000a).
47. Kobelev, L. Ya., “Maxwell equation, Schroedinger equation, Dirac equation, Einstein equation defined on the multifractal sets of the time and the space,” *arXiv:gr-qc/0002003* (2000b).
48. Kobelev, L. Ya., “Newton equations may be treated as diffusion equations in the real time and spacefield of multifractal universe,” *arXiv:physics/0104040* (2001).
49. Kolwankar, K., *Studies of fractal structures and processes using methods of the fractional calculus. Dissertation*, Univ. Pune, *arXiv:chaodyn/9811008* (Nov. 1998)
50. Ktitorov, S.A., “Fractal vortex structure in the lattice model of superconductors,” *arXiv:cond-mat/0212650* (2002).
51. Lineweaver, C. *et al.*, *Scientific Frontiers in Research on Extrasolar Planets*, *ASP Conf. Series* Vol. 28, Deming *et al.* (eds), (2003). Also published at *arXiv:astro-ph/0209382*
52. Liu, M., “Superconducting hydrodynamics and the Higgs analogy,” *J. Low Temp Phys.* 126 (2002) 911.
53. Mandelbrot, B., *et al.*, “Angular gaps in radial DLA,” *arXiv:cond-mat/0109426* (2001).
54. Matese, J.J., P. Whitman, & D. Whitmire, “Cometary evidence of a massive body in the outer Oort cloud,” *Icarus* 141 (1999) 354-366.
55. Mittal, A., & D. Lohiya, “From fractal cosmography to fractal cosmology,” *arXiv:astro-ph/0104370* (2001).
56. Munera, H., “Michelson-Morley experiments revisited: systematic errors, consistency among different experiments, and compatibility with absolute space,” *Apeiron* Vol. 5 No. 1-2, Jan.-April (1998).

57. Myers, L.S., "An unheralded giant of geology: Warren Carey," *Apeiron* Vol. 4 No. 4 (1997).
58. Myers, L.S., "Our planet is expanding by internal core expansion," www.expanding-earth.org (2002).
59. Neto, M., *et al.*, "An alternative approach to describe planetary systems through a Schrodinger-type diffusion equation," *arXiv:astro-ph/0205379* (Oct. 2002).
60. Nottale, L., *Fractal Spacetime and Microphysics, Towards a Theory of Scale Relativity*, World Scientific, Singapore-New Jersey (1993) Also in <http://www.chez.com/etlefevre/rechell/>
61. Nottale, L., "Scale Relativity and Fractal Space-Time: Application to Quantum Physics, Cosmology and Chaotic systems," *Chaos, Solitons and Fractals*, 7, (1996) 877-938. Also published at <http://www.daec.obspm.fr/users/nottale>. See particularly p. 50-53.
62. Nottale, L. *et al.*, "Scale relativity and quantization of the Solar System" *Astron. Astrophys.* 322, (1997) 1018.
63. Nottale, L., "Scale relativity and quantization of the universe I: Theoretical framework" *Astron. Astrophys.* 327, (1997) 867-889.
64. Nottale, L., Schumacher, G., & E.T. Lefevre, "Scale-relativity and quantization of exoplanet orbital semi-major axes," *Astron. Astrophys.* 361, (2000) 379-387.
65. Nottale, L., "Scale relativity and gauge invariance," *Chaos, Solitons and Fractals*, 12, (Jan 2001) 1577. As published at <http://www.daec.obspm.fr/users/nottale>.
66. Nottale, L., "Non-differentiable space-time and scale relativity," in: "Géométrie au XXè siècle", *Proc. of International Colloquium*, Paris, 24-29 Septembre 2001, Ed. D. Flament, in press (2002a) As published at <http://www.daec.obspm.fr/users/nottale>.
67. Nottale, L., "Scale relativistic cosmology," *Chaos, Solitons and Fractals* (2002b) As published at <http://daec.obspm.fr/users/nottale>.
68. Nozieres, P., & D. Pines, *The theory of quantum liquids: Superfluid Bose Liquid*. Wesley Publ. Co. Inc. (1990) p. 116-124.
69. O'Brien, R., "Astronomical coincidence or cosmic design?" in *2002 Yearbook of Astronomy*, ed. P. Moore, Macmillan Publ. Ltd., London, (2002) 214-223, 262-263.

70. Prix, R., "Covariant vortex in superconducting-superfluid-normal fluid mixtures with stiff equation of state," *arXiv:gr-qc/0004076* (2000).
71. Quist, M., "Vortex dynamics in the nonlinear Schrödinger equations," *arXiv:cond-mat/0211424* (Nov. 2002).
72. Roberts, M., "Vacuum energy," *arXiv:hep-th/0012062* (2001).
73. Roscoe, D., "A fractal universe with discrete spatial scales," *Apeiron* Vol. 3 No. 3-4, July-Oct. (1996).
74. Rosu, H., "Pedestrian notes on quantum mechanics," *arXiv:gr-qc/9411035* (1994, revised 1997).
75. Rothwarf, A., "An aether model of the universe," *Phys. Essay* 11 (1998) 444-466.
76. Sedrakian, A. & J. Cordes, "Generation of pulsar glitches: superfluid core model," *Proc. 18th Texas Symposium on Relativistic Astrophysics*, eds. A. Olinto, J. Frieman & D. Schram, World Scientific Press, (1997), *arXiv:astro-ph/9709277*.
77. Sciforums, "Satellites reveal a mystery of large change in earth's gravity field," *Sciforums.com*, August 01 (2002). Also appears in *Science*, August 02, 2002.
78. Sidharth, B., "Issues in quantized fractal space time," *arXiv:physics/0006048* (2000).
79. Signell, P., "Newton's second law from quantum physics," *Project PHYSNET*, <http://www.physnet.org/home/modules/license.html> (2002)
80. Starobinsky, A., & I. Tkachev, "Trans-Planckian particle creation in cosmology and ultra-high energy cosmic rays," *arXiv:astro-ph/0207572* (2002).
81. Tang, J-M., "Quantum mechanics of quantized vortices in dilute Bose gases," *Diss. thesis in Univ. of Washington* (2001) 96 p.
82. Tewari, P., "Creation of galactic matter, and dynamics of cosmic bodies through spatial velocity field," http://www.tewari.org/Theory_Papers/theory_papers.html (1998)
83. Thouless, D.J., *et al.*, "Vortex dynamics in the two-fluid model," *Phys. Rev. Lett. B*, Vol. 63, 224504 (2001).
84. Tornkvist, O., & E. Schroder, "Vortex dynamics in dissipative systems," *Phys. Rev. Lett.* Vol. 78, No. 10 (1997).

85. Van Holten, J., "Particles, fluids, and vortices," NIKHEF, *arXiv:gr-qc/0107041* (2001).
86. Volovik, G., "Links between gravity and dynamics of quantum liquids," *Int. Conf. "Cosmology. Relativistic Astrophysics. Cosmoparticle Physics" (COSMION-99)* (2000a). As published at *arXiv:gr-qc/0004049*.
87. Volovik, G., "Superfluid analogies of cosmological phenomena," *arXiv:gr-qc/0005091* (2000b).
88. Volovik, G., "Vortices observed and to be observed," *arXiv:cond-mat/0005431* (2000c).
89. Volovik, G., "Vacuum in quantum liquids and in general relativity," *arXiv:gr-qc/0104046* (2001).
90. Weinan, E., "Stochastic hydrodynamics," talks given at the meeting *Developments in Mathematics*, Harvard University, (Dec 2000) 66p.
91. Weinberg, S., *Dreams of final theory*, Vintage, London. (1993) 180-182, 214-215.
92. Weldrake, D., "Extrasolar planets and the Upsilon Andromedae System," in *2002 Yearbook of Astronomy*, ed. P. Moore, Macmillan Publ. Ltd., London, (2002) 179-191.
93. Winterberg, F., "Maxwell's Aether, the Planck Aether hypothesis, and Sommerfeld's Fine Structure Constant," http://www.cet.sunderland.ac.uk/webedit/allweb/news/Philosophy_of_Science/Maxwell's%20Aether,%20the%20Planck%20Aether%20Hypothesis%20and%20Sommerfeld's%20Finestructure%20Constant.doc (2002a) see also <http://www.znaturforsch.com/56a/56a0681.pdf>.
94. Winterberg, F., "Planck mass rotons as cold dark matter and quintessence," presented at the *9th Canadian Conf. on General Relativity and Relativistic Astrophysics*, Edmonton, May 24-26th 2001; also in *Z. Naturforsch 57a*, 202-204 (2002b).
95. Yakovlev, D.G., "Superfluidity in neutron stars," *Physics-Uspekhi* 44 (8), (Aug 2000) 823-826.
96. Yates, A.J., "The formation and electrodynamic properties of cosmic strings," *Diss. thesis in Imperial College*, London (Nov 1996) 148p.
97. Zakir, Z., "Gravitation as quantum diffusion," *gr-qc/9906079* (1999).
98. Zurek, W.H., "Cosmological experiments in superfluids and superconductors," in *Proc. Euroconference Formation and Interaction of*

Topological Defects, A.C. Davis & R.N. Brandenberger (eds.) Plenum (1995). Also in *arXiv: cond-mat/9502119*.

99. Zurek, W.H., “Sub-Planck structure in phase space and its relevance for quantum decoherence,” *Nature* Vol. 412, Aug. 16th, 2002, www.nature.com (2002) 712-717.

Endnotes

ⁱ Term ‘turbulent mixing’ here has been used in accord with Gibson’s original terminology. Turbulence is defined as “an eddy-like state of fluid motion where the inertial-vortex forces of the eddies are larger than the viscous, buoyancy, electromagnetic or any other forces which tend to damp the eddies.” Furthermore, natural flows at very high Reynolds, Froude, Rossby numbers in the ocean, atmosphere, stars and interstellar medium develop highly intermittent turbulent and mixing (Gibson 1991, also Foias et al. 2001).

ⁱⁱ For other publications of C. Gibson related to this issue, see arXiv.org: [astro-ph/9904230](http://arXiv.org/astro-ph/9904230), [astro-ph/9904237](http://arXiv.org/astro-ph/9904237), [astro-ph/9904260](http://arXiv.org/astro-ph/9904260), [astro-ph/9904284](http://arXiv.org/astro-ph/9904284), [astro-ph/9904283](http://arXiv.org/astro-ph/9904283), [astro-ph/9904317](http://arXiv.org/astro-ph/9904317), [astro-ph/9911264](http://arXiv.org/astro-ph/9911264), [astro-ph/9904362](http://arXiv.org/astro-ph/9904362), [astro-ph/0003147](http://arXiv.org/astro-ph/0003147), [astro-ph/0002381](http://arXiv.org/astro-ph/0002381), [astro-ph/9810456](http://arXiv.org/astro-ph/9810456), [astro-ph/0003352](http://arXiv.org/astro-ph/0003352), [astro-ph/9904366](http://arXiv.org/astro-ph/9904366), [astro-ph/9908335](http://arXiv.org/astro-ph/9908335).

ⁱⁱⁱ See also Castro, Mahecha, Rodriguez (2002) for further discussion on this approach from the fractal diffusion viewpoint.

^{iv} As we know $\rho(\mathbf{V} \cdot \nabla)\mathbf{V}$ is the only nonlinear term in the Navier-Stokes equations; this term is also called the inertial (vortex) term. The Navier-Stokes equations are among the very few equations of mathematical physics for which the nonlinearity arises not from the physical attributes of the system but rather from the mathematical (kinematical) aspects of the system. In divergence free condition $\text{div } \mathbf{u} = 0$, the Navier-Stokes equations for a viscous, incompressible, homogenous flow are usually expressed as:

$$\begin{aligned} \partial \mathbf{u} / \partial t - \nu \Delta \mathbf{u} + (\mathbf{u} \cdot \nabla) \mathbf{u} + \nabla p &= \mathbf{f}, \\ \nabla \cdot \mathbf{u} &= 0 \end{aligned}$$

where for notational simplicity, we represent the divergence of \mathbf{u} by $\nabla \cdot \mathbf{u}$, and for all practical purposes the density has been normalized to unity, $\rho=1$ (C. Foias et al., 2001). It shall be worthnoting, however, the origin of viscosity imposes a limit on the domain of validity of the Navier-Stokes equations. We should learn of some natural lengths characterizing the length scale region in which flow energy dissipation is dominated by viscous phenomena.

Therefore we find the significance of the Reynolds number emerges by comparing the inertial and dissipation terms of the Navier-Stokes equations. The inertial term dominates when:

$$\text{Re} = L_* U_* / \nu \gg 1$$

By setting the $\text{Re} = +\infty$ (i.e. $\nu = 0$), we obtain the case of inviscid flows. In this case, the divergence-free condition is retained but the momentum equation changes, resulting in the Euler equations for inviscid perfect fluids:

$$\partial u / \partial t + (u \cdot \nabla) u + \nabla p = f,$$

$$\nabla \cdot u = 0$$

Note here, some of the difficulties encountered in studying turbulent behavior, a largely inviscid regime, arise because of transition from Euler's equations to the Navier-Stokes equations necessitates a change from a first-order system to a second-order one in space (∇ to Δ) (C. Foias et al. 2001).

^v We admit here the accepted viewpoint is superfluidity implies no dissipation (no turbulence is possible); the condensations –as long-lived states perhaps far from equilibrium – are indeed related to superfluidity, where the solutions are harmonic, so dissipative effects do not appear. Hence chaos can appear in the superfluid but not irreversible turbulence. However, recent research have begun to embrace this ‘superfluid turbulence’ issue (see Proceedings of the Isaac Newton Institute Workshop on Quantized Vortex Dynamics and Superfluid Turbulence, Cambridge, UK, Aug. 2000). They discussed for instance: hydrodynamic description of superfluid helium turbulence with quantum vortices; valuable comparison between the physics of Navier-Stokes and helium II turbulence; and a realistic possibility of experimental study of quantum turbulence in superfluid ³He. Other researchers have considered the possibility of superfluid turbulence phenomena, particularly for superfluid ³He and He⁴. Zurek (1995, 16) considered turbulent tangle of vortex lines. Volovik (2000b) considered ³He-A effects to represent turbulent cosmic plasmas, though he admits these effects are less dramatic. Some experiments showing

unusual properties damping and viscosity properties of helium II, indicating turbulence phenomenon, have also been reported by (Godfrey *et al.* 2001). Therefore we could expect under certain condition superfluid (helium) could exhibit such turbulence phenomena.

^{vi} See also for instance *arXiv:math-ph/9909033*.

^{vii} Inspired by Landau two-fluid theory, a number of researchers share a viewpoint that a **vortex** can be a singularity in a “background” fluid. The background fluid is the superconductor (or superfluid) which can admit circulation, but without vorticity and without dissipation. The defect “vortex” regions are then topological defects (Yates 1996), which, if not empty holes, are bounded regions of real vorticity, with a vorticity discontinuity on the boundary of the defect domain. The discontinuity implies a lack of differentiability. In the limit, these regions are taken to be “vortex” threads or strings, but this is only part of the story for there are other types of topologically bounded regions of “vorticity” which in many cases can have persistent lifetimes, and therefore represent “objects” in the background fluid (see Kiehn 2001). In this regards, an active community sponsored by ESF in Europe, COSLAB-VORTEX-BEC2000+ groups have combined to give a workshop in Bilbao this summer (2003), see <http://tp.lc.ehu.es/ILE/bilbaocoslab.htm>. It appears that the objective of COSLAB is to see how these objects in a laboratory superfluid may be considered as models of a cosmology (Zurek 1995, Volovik 2000b). In effect, the background is the “vacuum aether superfluid” and the stars and galaxies are the “condensed objects” within it.

^{viii} Vorticity in cosmology has been considered in a recent article, C. Schmid, *arXiv:gr-qc/0201095* (2002); while the idea of condensation may correspond to article by G. Chapline, *arXiv:hep-th/9812129* (1998).

^{ix} Such vortices sometimes are known as ‘circulatory wave’ or Wolter’s vortex, see H. Rosu, *arXiv:quant-ph/9506015* (1997).

^x This argument can be considered as based on the simple observation, i.e. one can represent natural objects like gas or water as (kinematic) dynamics of

fluids, but not as fields. Therefore we could conclude the domains of application of fields are *less than* those of fluids.

^{xi} It is known there exist exact solutions to the Navier-Stokes equations that – at constant vorticity- create bounded regions of fluid bubbles of isolated vorticity which are formed as the mean translational flow increases. It seems this could be an example of particle generation in dissipative media. It is perhaps also worth noting here, i.e. there does exist one-to-one correspondence between the Schroedinger equation and the Navier-Stokes equation for viscous compressible fluids, not just Madelung-Eulerian fluids (Kiehn 1989, 1999). The square of the wavefunction is the enstrophy of these fluids.

^{xii} At this point, it is worth noting here this previous works by Cartan have shown that Dirac equation can be generalized without any recourse to non-differentiability nor to an aether. Therefore, such aether interpretation could be considered merely as plausible alternative interpretation, somewhat in accordance with the previous works of Prokhorov, Rothwarf (1998), Consoli *arXiv:hep-ph/0109215* etc.

^{xiii} Similar suggestion of *flat spacetime* universe has also been argued recently for instance by Moniz (*arXiv:gr-qc/0011098*) and K. Akama (*arXiv:hep-th/0007001, hep-th/0001113*).

^{xiv} *Non-differentiable function* is defined here in simple term as function, which has a derivative nowhere. It is known there are such functions, which are continuous but nowhere differentiable. Some mathematicians propose Weierstrass function belongs to this group.

^{xv} Alternatively, we could consider negative mass is inherent in the structure of the core of the Sun (*arXiv:physics/0205040*). This possibility has been discussed by DeAquino for the case of neutron stars. Otherwise, perhaps this negative mass could be considered as effects related to (ultra-cold superfluid neutron) boson stars as theorised by several authors.

^{xvi} There is also known transformation (Kustaanheimo-Steifel) from the Kepler problem to the harmonic oscillator problem. An alternative expression was given by Tewari (1998).

^{xvii} See also *Apeiron* Vol. 9 No. 2 (2002), though this article discusses atmospheric flows instead of the motion of celestial bodies.

^{xviii} Mandelbrot also suggested turbulent velocity fields may have fractal structure with a non-integer Hausdorff dimension: a pattern of spiral with smaller spirals on them—and so on to increasingly smaller scales. This is in

accordance with Landau's (1963) turbulence definition as "superposition of an *infinite* number of vortices, or eddies, with sizes varying *over all scales*." For discussion on possible limitations of such *scale symmetry* assumption, we refer to E.I. Guendelman, *arXiv:gr-qc/0004011*, *arXiv:gr-qc/9901067*.

^{xix} This method uses *Ordinary Least Square* (OLS) theorem, or known as 'least square error' principle. However it shall be kept in mind, this OLS method has seven well-known premises known as "Gauss-Markov assumptions."

^{xx} For discussion on the plausibility of the proposed Negative-Mass Star (NMS), see for instance F. De Aquino, *arXiv:physics/0205040* (2002a). In principle, he conjectures there is negative mass inside the vortex core of neutron stars. Therefore either we could observe a distant negative mass star as companion of the Sun, or perhaps the negative mass with mass approximately equivalent with the mass of the Sun is located inside the core of the Sun, as part of its inner structure. Alternatively, we could think such a negative mass as extension to Cantorian space of negative electron mass in Hall effect theory:

$-eEm_h / m_e = +eE$ which can only hold if $m_h = -m_e$. See H. Myers, *Introductory solid state physics*, Taylor & Francis, 2nd ed. (1997), p. 266-267.

^{xxi} Anderson, P.W., *et al.*, *Europhys. Lett.* (), *arXiv:astro-ph/0002054* (2000).

^{xxii} Kolomeisky, E., *et al.*, *arXiv:cond-mat/0002282* (2000).

^{xxiii} X. Song and P. Richards of Columbia University's Lamont-Doherty, <http://www.ldeo.columbia.edu/song/pr/html>

QUANTIZATION AND DISCRETIZATION AT LARGE SCALES

Edited by Florentin Smarandache, V. Christianto & Pavel Pintr

The ongoing search of extrasolar planets is one of the most attractive fields of research in astrophysics and astronomy. Up to now, 360 extrasolar planets have been discovered near stars with similar mass as the Sun. There is also discovery related to the so-called Earth-like planets. With regards to these discoveries, one intriguing question is whether there is relationship between orbit distance of the planets and their stars. Various formulas have been suggested since 1990s, and they suggest that there may be reason to accept quantization of distances of those planets both in our solar system and also in extrasolar systems as well. This book discusses this issue (Rubcic & Rubcic), along with other interesting issues such as protoplanetary formation of solar system (Pintr, prof. Peřinová, & dr. Luks), precession in solar system (Pitkanen) and other topics.

Another line of thought explored herein is the correspondence between cosmological phenomena and condensed matter physics, and therefore we can think that the quantization of orbit distances can be caused by superfluid helium quantization. This issue is explored by F. Smarandache and V. Christianto. Moreover, F. Smarandache also discusses possible new era of research that is pertaining to superluminal physics and instantaneous physics. Ion Patrascu and D. Rabounski discuss superluminality from their perspectives. And M. Pereira discusses his Hypergeometrical Universe model.

This book is published after our previous book: Quantization in astrophysics, Brownian motion, and Supersymmetry which was released about five years ago. Perhaps the ideas presented herein will have impact on discussions concerning quantum cosmology, which so far it cannot be observed. On the contrary, quantization at large scales can be observed. We hope that this volume will add a new chapter in our understanding of the Universe, from the viewpoint of quantization and discretization at large scales.

www.sciprint.org

